

Owner's Manual

24bit Dual Multi Effect Processor

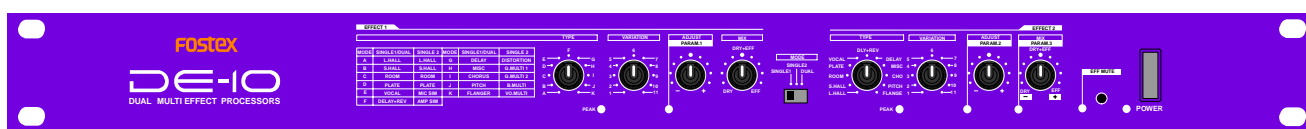

Model DE-10



Introductions

Thank you very much for having purchased the Fostex DE-10.

This unit is a completely independent two channel Multi Effect Processor that employs the A. S. P.+ (Fostex Advanced Signal Processing Technology), which is newly developed by Fostex.

It provides high quality ambient effects almost equivalent to a professional effect processor.

In addition to the typical Reverbs, it offers not only various practical algorithms such as Delay, Chorus, Flanger and Pitch Bend, but some combinations of these are also available, e.g., Delay+Reverb.

Also, the DE-10 offers three operation modes as “**Dual Mode**”, “**Single 1 Mode**” and “**Single 2 Mode.**” The “**Dual Mode**” works twice as much as an independent single channel Multi Effect Processor, which configures as 1 Input - 2 Output times two. The “**Single (1 and 2) Mode**” works as a 2 Input - 2 Output Multi Effect Processor.

You can use the unit by connecting it to the AUX Send and AUX Return of an Audio Mixer for a recording. Also you can directly connect the output from your musical instruments (Line Level only) to the unit so that it will be a useful aid in your live performance.

To fully exploit all of its many useful features and functions, we recommend you read this manual first before you start using the DE-10.

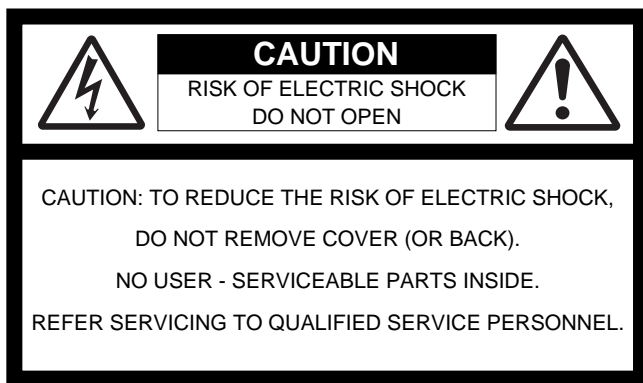

"WARNING"

"TO REDUCE THE RISK OF FIRE OR ELECTRIC SHOCK, DO NOT EXPOSE THIS APPLIANCE TO RAIN OR MOISTURE."

SAFETY INSTRUCTIONS

1. Read Instructions - All the safety and operating instructions should be read before the appliance is operated.
2. Retain Instructions - The safety and operating instructions should be retained for future reference.
3. Heed Warnings - All warnings on the appliance and in the operating instructions should be adhered to.
4. Follow Instructions - All operating and use instructions should be followed.
5. Water and Moisture - The appliance should not be used near water - for example, near a bathtub, washbowl, kitchen sink, laundry tub, in a wet basement, or near a swimming pool, and the like.
6. Carts and Stands - The appliance should be used only with a cart or stand that is recommended by the manufacturer.



An appliance and cart combination should be moved with care. Quick stops, excessive force, and uneven surfaces may cause the appliance and cart combination to overturn.

7. Wall or Ceiling Mounting - The appliance should be mounted to a wall or ceiling only as recommended by the manufacturer.
8. Ventilation - The appliance should be situated so that its location or position does not interfere with its proper ventilation. For example, the appliance should not be situated on a bed, sofa, rug, or similar surface that may block the ventilation openings; or, placed in a built-in installation, such as a bookcase or cabinet that may impede the flow of air through the ventilation openings.
9. Heat - The appliance should be situated away from heat sources such as radiators, heat registers, stoves, or other appliances (including amplifiers) that produce heat.

CAUTION:

TO PREVENT ELECTRIC SHOCK, MATCH WIDE BLADE OF PLUG TO WIDE SLOT, FULLY INSERT.

ATTENTION:

POUR ÉVITER LES CHOCS ÉLECTRIQUES, INTRODUIRE LA LAME LA PLUS LARGE DE LA FICHE DANS LA BORNE CORRESPONDANTE DE LA PRISE ET POUSSER JUSQU' AU FOND.



The lightning flash with arrowhead symbol, within an equilateral triangle, is intended to alert the user to the presence of uninsulated "dangerous voltage" within the product's enclosure that may be of sufficient magnitude to constitute a risk of electric shock to persons.



The exclamation point within an equilateral triangle is intended to alert the user to the presence of important operating and maintenance (servicing) instructions in the literature accompanying the appliance.

10. Power Sources - The appliance should be connected to a power supply only of the type described in the operating instructions or as marked on the appliance.
11. Grounding or Polarization - The precautions that should be taken so that the grounding or polarization means of an appliance is not defeated.
12. Power Cord Protection - Power supply cords should be routed so that they are not likely to be walked on or pinched by items placed upon or against them, paying particular attention to cords at plugs, convenience receptacles, and the point where they exit from the appliance.
13. Cleaning - The appliance should be cleaned only as recommended by the manufacturer.
14. Nonuse Periods - The power cord of the appliance should be unplugged from the outlet when left unused for a long period of time.
15. Object and Liquid Entry - Care should be taken so that objects do not fall and liquids are not spilled into the enclosure through openings.
16. Damage Requiring Service - The appliance should be serviced by qualified service personnel when:
 - A. The power supply cord or the plug has been damaged; or
 - B. Objects have fallen, or liquid has been spilled into the appliance; or
 - C. The appliance has been exposed to rain; or
 - D. The appliance does not appear to operate normally or exhibits a marked change in performance; or
 - E. The appliance has been dropped, or the enclosure damaged.
17. Servicing - The user should not attempt to service the appliance beyond that described in the operating instructions. All other servicing should be referred to qualified service personnel.
18. The appliance should be situated away from drops of water or spray of water.
19. Objects containing liquid such as vase must not be put on the appliance.
20. The appliance is not completely isolated from the power supply even if the power switch is at off position.

Table of Contents

Precautions (please read before use)	3
Digital Effect Functions	4
The details of the preset Effects	5
• Effects in DUAL mode	5
L. HALL (Large Hall)	5
S. HALL (Small Hall)	5
ROOM	5
PLATE	6
VOCAL	6
DLY+REV (Delay + Reverb)	6
DELAY	6
MISC (Miscellaneous)	7
CHORUS	7
PITCH	7
FLANGE	7
• Effects in SINGLE 1 mode	8
L. HALL (Large Hall)	8
S. HALL (Small Hall)	8
ROOM	8
PLATE	8
VOCAL	9
DLY+REV (Delay + Reverb)	9
DELAY	9
MISC (Miscellaneous)	10
CHORUS	10
PITCH	10
FLANGE	11
• Effects in SINGLE 2 mode	12
L. HALL (Large Hall)	12
S. HALL (Small Hall)	12
ROOM	12
PLATE	12
MIC SIM (Microphone Simulation)	13
AMP SIM (Amplifier Simulation)	13
DISTORTION	13
GUITAR MULTI 1	14
GUITAR MULTI 2	14
BASS MULTI	15
VOCAL MULTI	15
Names and Functions (Front panel section)	16
Names and Functions (Rear panel section)	17
How to use the DUAL mode	18
How to use the SINGLE (1 and 2) mode	19
Specifications	21
Block Diagram	21
Declaration of EC Directive	22

Precautions (please read before use)

Power supply

- When unplugging the power cable from the AC outlet, be sure to grasp the power plug. Attempting to unplug it by pulling on the power cable may damage the wiring.
- It is dangerous to use any power cable that is cut or frayed. If the power cable is damaged, immediately stop using it, and have it repaired.
- Do not plug in or unplug the power plug with wet hands. Doing so may result in dangerous electric shock.
- Do not open the unit or touch any parts in side. Doing so may result in a dangerous electric shock, and could damage the unit.
- Do not let water or other liquids, flammable materials, or metal objects such as pins get in side the unit. These things may cause electrical shock or short circuit the DE-10, and damage it. If the DE-10 should become wet, unplug the power cable from the AC outlet, and contact your authorized service station.

Location

- Avoid using the DE-10 in the following locations:
 - Locations of extreme low or high temperatures, or extreme changes in temperature.
 - Locations with excessive moisture or dust.
 - Locations where direct sunlight falls for an extended time, or near a stove or other source of heat.
 - Locations where electrical voltage varies.
 - Unstable locations or where there is heavy vibration.
 - Near strong magnetic fields (on top of a television or speaker).

Digital Effect Functions

The DE-10 achieves superb ambience effects by employing the Fostex A.S.P. (Fostex Advanced Signal Processing Technology*), as well as simulations of microphones/amplifiers with overwhelming reality by employing the newly developed "A.S.P. +".



*A. S. P. (Fostex Advanced Signal Processing Technology)

The A. S. P. is an exclusive new digital effect processing technology designed by Fostex. This method extracts maximum efficiency from the limited DSP power. It achieves an overwhelmingly high density Early Reflection sound and wonderfully smooth High Dump response through the H. F. A. (Harmonic Feedback Algorithm). Also, it carries out an elaborate reverb simulation with clear sounds through the H. D. L. P. (Hi-Density Logarithmic Processing), which eliminates the mutual interference between the numerous integrated delay modules and reduce the impurity and grit of the sound.

*H. F. A. (Harmonic Feedback Algorithm)

There is one of indispensable elements in the natural echo called "Early Reflection sound", which is usually sacrificed in commercial reverb products in order to reduce costs. (In practice, the Early Reflection sound means the very first reverberated sound that bounces back from walls, floors and ceilings of concert halls). The entire reverb sound quality depends on this Early Reflection sound and how closely it can resemble the real echo. The H. F. A. is an algorithm that enables the effect unit to reproduce a clear and natural Early Reflection sound by applying an ideal harmonic feedback to each delay module.

*H. D. L. P. (Hi-Density Logarithmic Processing)

The reverb sounds consist of lots of small delay elements combined in a complex way, which are produced by many delay modules inside the effect unit. In order to obtain smooth and comfortable reverb sounds, it is very important to efficiently organize the relationship between each delay module and minimize negative mutual interference. The H. D. L. P. is a technology which applies efficient logarithmic processing to each delay module, so that they can work in the most efficient way in order to eliminate harmful reverb elements and roughness. This makes it possible to establish high density and transparent sounds.

About "A.S.P.+"

Combining the ambience effect technology established through the development of "A.P.S." with acoustic theories accumulated through the development of transducers such as monitor speakers for many years, Fostex developed a unique simulation algorithm engine called "A.S.P.+", which performs overwhelmingly realistic microphone/amplifier simulation.

To simulate a microphone, the frequency response of the microphone, which is the most essential factor that decides the sound character of each famous/popular microphone, must be reproduced correctly. To get this, "A.P.S.+" carries out a double accuracy operation for each frequency range using the unique "D.A.O." (Double Accuracy Operation).

Regarding a guitar amplifier, the peak and dip of the specific frequencies, as well as feedback of the peak frequency's harmonics, are the most essential factors that decide the sound character of each famous/popular amplifier. To simulate such a unique character, "A.P.S.+" carries out a double accuracy operation for each frequency range using the "D.A.O." (Double Accuracy Operation) to simulate the frequency curve, as well as carries out harmonics feedback processing using the "H.F.A." (Harmonics Feedback Algorithm).

Reverb:

The so called Reverb effect consists of various reflection sounds mixed together. For example, when you clap your hands in a tunnel, you will hear the sound linger even after you stop clapping your hands. This is the Reverb. The sounds we normally hear in daily life have three types of sounds mixed together, i.e., "Direct sound", "Early Reflection sound" and "Late Reflection sound". The Direct sound means the sound directly reaches the ears from the sound source. The Early Reflection sound means the sound that comes after the Direct sound and has rebound off the wall of the tunnel up to a few times. The Late Reflection sound means that the sound rebounds many times long after the Direct sound has disappeared. Our ears normally hear the "Direct sound" - "Early Reflection sound" - "Late Reflection sound" in that order.

Delay:

This is the effect to add a delayed sound to the original sound. You can obtain a richer sound or completely change the original source sound by using the Delay.

Pitch:

The Pitch basically means the frequency of the audio. But, in the case of an effect unit, it works this way; for instance, you can amend the vocal tone by changing the Pitch lifting or dropping as much as an octave. Also, you can obtain some unusual effects by mixing the shifted Pitch sound and the original sound together.

Chorus:

This makes the one original sound appear to have many sources. The Chorus is used to widen or thicken the original sound.

Flanger:

The Flanger is one of applications of the Delay. This is used to create a sound like a jet airplane ascending or descending.

Distortion:

The distortion effect distorts the sound and adds harmonics. Four types of the distortion effect are provided: the guitar distortion, bass distortion, drum distortion and voice distortion. The distortion is used for the insert effect.

Simulation:

Simulators for famous guitar amplifiers and microphones are provided. You can get a familiar distortion sound of a famous guitar amplifier or a popular microphone sound. A simulator can be used for the insert effect.

The Details of the Preset Effects

The DE-10 has 11 preset Effect Types available on both the Dual Mode and Single 1/2 Mode. Each Effect Type further offers a maximum of 11 variations. See Operations on page 18 and 19 for how to set up the Preset Effects.

Effects in DUAL MODE

• L.HALL (Large Hall)

- L.HALL 1** (Natural Large Hall) : Conventional large hall, with sonic detail, clarity, and an appropriate amount of early reflections.
- L.HALL 2** (Lo-Freq Large Hall) : Large hall with lingering low-frequency reverb components.
- L.HALL 3** (Vivid Large Hall) : Reverb with crispness and good presence.
- L.HALL 4** (Hard-Wall Large Hall) : Large hall surrounded by hard walls, many early reflections, and a strong high-frequency ratio.
- L.HALL 5** (Soft-Wall Large Hall) : Reverb with restrained high-frequency range and gentle character.
- L.HALL 6** (Long Pre-Delay Large Hall): Reverb with an extremely long pre-delay time, simulating a fairly broad space.
- L.HALL 7** (Cave) : Reverb simulating a cave. Perhaps the thick moss accounts for the excellent high-frequency absorption!
- L.HALL 8** (Stadium) : Stadium reverb with many long early reflections.
- L.HALL 9** (Vivid Stadium) : Stadium reverb with a dry character.
- L.HALL 10** (Auditorium) : Reverb simulating a space with little reverberation, such as a large auditorium.
- L.HALL 11** (Big Cave) : Simulates a more spacious volume than the cave of L.HALL 7. Reverb time is longer.

* **[ADJUST]** knob: Adjust the Reverb Time.



• S. HALL (Small Hall)

- S.HALL 1** (Natural Small Hall) : Conventional small hall with sonic detail, clarity, and an appropriate amount of early reflections.
- S.HALL 2** (Lo-Freq Small Hall) : Small hall with lingering low-frequency reverb components.
- S.HALL 3** (Vivid Small Hall) : General-purpose small hall with crisp sound and few early reflections.
- S.HALL 4** (Hard-Wall Small Hall) : Small hall surrounded by hard walls, many early reflections, and a strong high-frequency ratio.
- S.HALL 5** (Soft-Wall Small Hall) : Small hall with little high-frequency range.
- S.HALL 6** (Long Pre-Delay Small Hall): Small hall with a long pre-delay time, simulating a broad space.
- S.HALL 7** (Narrow Small Hall) : Small hall simulating a long and narrow space where the reverberation is concentrated in the center.
- S.HALL 8** (Dead Hall) : Relatively "dead" small hall with a low high-frequency ratio.
- S.HALL 9** (Small Stadium) : Small hall simulating a space with low-density reverberation such as a gymnasium.
- S.HALL 10** (Out Door Stage) : Simulation of an outdoor stage. Extremely small amount of reverberation.
- S.HALL 11** (Flat Reverb) : Small hall with no early reflections, and the entire frequency range decays in the same way.

* **[ADJUST]** knob: Adjust the Reverb Time.



• ROOM

- ROOM 1** (Natural Room) : Conventional room reverb simulating a nice space with just enough "sparkle."
- ROOM 2** (Garage) : Room reverb with crisp presence simulating a small, live space such as a garage.
- ROOM 3** (Dead Room) : Room reverb simulating a small, dead room. Add just a bit of this to give warmth to a sound. Ideal for narrations.
- ROOM 4** (Live Room) : Room reverb simulating a live space with low-density reverberation.
- ROOM 5** (Vivid Room) : All-purpose room reverb with few early reflections and good definition.
- ROOM 6** (Off Mic) : Room reverb with reverberation concentrated in the center.
- ROOM 7** (Hard Wall Drum Booth) : Room reverb simulating a drum booth with hard walls. Crisp, and good for percussion as well.
- ROOM 8** (Wood Wall Drum Booth) : Room reverb simulating a drum booth with a boost in the low to mid-ranges.
- ROOM 9** (Live House) : Room reverb simulating a small club.
- ROOM 10** (Back-Stage) : Room reverb simulating the sound back-stage.
- ROOM 11** (Hi-Freq Room) : Room reverb with unique character in the mid-range.

* **[ADJUST]** knob: Adjust the Reverb Time.

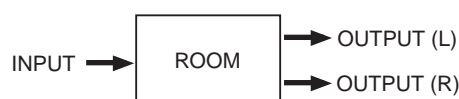

• **PLATE**

- PLATE 1** (Normal Plate) : Contemporary-feeling plate reverb with a wide bandwidth.
- PLATE 2** (Old Plate) : Conventional plate reverb with the character of classic plate devices.
- PLATE 3** (Vivid Plate) : Crisp plate reverb with extended highs.
- PLATE 4** (Lo-Freq Plate) : Plate reverb with a gentle character.
- PLATE 5** (Sharp Plate) : Plate reverb with only the high-frequency component.
- PLATE 6** (Mono Plate) : Plate reverb panned to the center.
- PLATE 7** (Dark Plate) : Plate reverb with rapidly decaying highs and lingering lows.
- PLATE 8** (Hi-Freq Plate) : Plate reverb with unique character in the high range.
- PLATE 9** (Mid-Freq Plate) : Plate reverb with unique character in the mid range.
- PLATE 10** (Large E/R Plate) : Plate reverb emphasizing a digital feel, with metallic-sounding early reflection.
- PLATE 11** (Flat Plate) : Plate reverb with low-density reverberation.

* **[ADJUST]** knob: Adjust the Reverb Time.



• **VOCAL**

- VOCAL 1** (Standard Vocal) : The early reflections of an ideal vocal booth plus short reverberation with extended high range. This adds sparkle to the sound, and is effective when you want to make the vocal stand out in the ensemble.
- VOCAL 2** (Karaoke) : All-around reverb that makes any vocal sound great (!?)
- VOCAL 3** (Vocal Booth) : The early reflections of an ideal vocal booth plus short reverberation. This adds a natural feeling of air, and is effective with simple arrangements with an unhurried vocal.
- VOCAL 4** (Warm Vocal) : Reverb with a short delay and a plate character. Adds depth to the sound.
- VOCAL 5** (Diffusion Vocal) : Spacious stadium-type early reflections plus short reverberation with extended high range. Good for chorus parts.
- VOCAL 6** (Natural Vocal) : Easy to use vocal reverb with moderate delay and reverberation.
- VOCAL 7** (Vivid Vocal) : Reverb that adds depth and spaciousness to the sound. A good high range makes this ideal for chorus parts as well.
- VOCAL 8** (Wet Vocal) : A short delay plus a gentle reverb. Recommended for slow songs.
- VOCAL 9** (Doubling Vocal) : Spacious short delay plus a reverb with a real plate character. Blends naturally into any background.
- VOCAL 10** (Dry Vocal) : Spacious short delay plus short reverberation.
- VOCAL 11** (Stadium Vocal) : Stadium-type early reflection plus majestic reverb. Adds depth and spaciousness to a vocal.

* **[ADJUST]** knob: Adjust the Reverb Time.

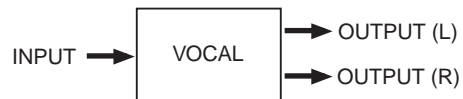

• **DLY+REV (Delay+Reverb)**

- DLY+REV 1** (Mono Delay+Hall Reverb) : Mono delay + hall reverb.
- DLY+REV 2** (L-R Delay+Hall Reverb) : Panning delay + hall reverb.
- DLY+REV 3** (Diffusion Delay+Hall Reverb) : Spacious delay + hall reverb.
- DLY+REV 4** (Mono Delay+Room Reverb) : Mono delay + room reverb.
- DLY+REV 5** (L-R Delay+Room Reverb) : Panning delay + room reverb.
- DLY+REV 6** (Diffusion Delay+Room Reverb) : Spacious delay + room reverb.
- DLY+REV 7** (Mono Delay+Plate Reverb) : Mono delay + plate reverb.
- DLY+REV 8** (L-R Delay+Plate Reverb) : Panning delay + plate reverb.
- DLY+REV 9** (Diffusion Delay+Plate Reverb) : Spacious delay + plate reverb.
- DLY+REV 10** (Mono Single Delay+Plate Reverb) : Mono delay (without feedback) + plate reverb.
- DLY+REV 11** (L-R Single Delay+Plate Reverb) : Panning delay (without feedback) + plate reverb.

* **[ADJUST]** knob: Adjust the Delay Time.

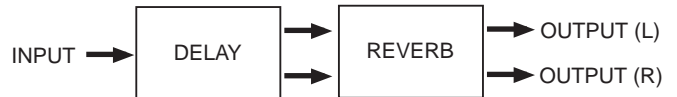

• **DELAY**

- DELAY 1** (Mono Delay) : Typical mono delay with moderate feedback.
- DELAY 2** (L-R Delay) : Typical panning delay with moderate feedback.
- DELAY 3** (Diffusion Delay) : Spacious mono delay with moderate feedback.
- DELAY 4** (Mono Single Delay) : Typical mono delay without feedback.
- DELAY 5** (L-R Single Delay) : Typical panning delay without feedback.
- DELAY 6** (Diffusion Single Delay) : Spacious mono delay without feedback.
- DELAY 7** (Mono Doubling) : Mono doubling delay.
- DELAY 8** (Diffusion Doubling) : Stereo doubling delay.
- DELAY 9** (Lo-Freq Delay) : Delay Type 1 with only the low-frequency components.
- DELAY 10** (Hi-Freq Delay 1) : Delay Type 2 with only the high-frequency components.
- DELAY 11** (Hi-Freq Delay 2) : Delay Type 1 with only the high-frequency components.

* **[ADJUST]** knob: Adjust the Delay Time.



• **MISC (Miscellaneous)**

- MISC 1** (Random E/R) : Random early reflections. When applied to instruments with a slow attack, this produces a natural feeling of air and space.
- MISC 2** (Soft Random E/R) : Random early reflections. Less high range than MISC 1, so suitable for backing tracks.
- MISC 3** (Tight Random E/R) : Random early reflections with only high-frequency components.
- MISC 4** (Long E/R) : Miraculous ambience that could not exist in the real world, with early reflections that continue without being covered by reverberant components.
- MISC 5** (Short E/R) : Random early reflections at close spacing appear all at once. Effective for giving natural spaciousness to pad-type sounds.
- MISC 6** (Large Hall E/R) : Early reflections of a large hall.
- MISC 7** (Soft Large Hall E/R) : Early reflections of a large hall. Gentler sound than MISC 4.
- MISC 8** (Small Hall E/R) : Early reflections of a small hall.
- MISC 9** (Soft Small Hall E/R) : Early reflections of a small hall. Gentler sound than MISC 6.
- MISC 10** (Reverse E/R) : Early reflections of reverse reverb. Effective on vocal or brass section.
- MISC 11** (Gate Reverb) : Gated early reflection with a crisp cutoff.

* **[ADJUST]** knob: Adjust the size of the room.

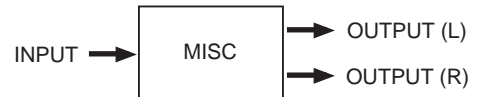

• **CHORUS**

- CHORUS 1** (Natural Chorus) : Conventional chorus with fairly shallow depth, suitable for any sound. Adds a natural spaciousness and depth without changing the character of the original sound.
- CHORUS 2** (Deep Chorus) : Chorus with greater depth. Suitable when you want to aggressively modify the sound of an electric piano, etc.
- CHORUS 3** (Doubling Chorus) : Conventional chorus, plus a doubling effect created by a short delay.
- CHORUS 4** (Mono Chorus) : Light chorus panned to center. Adds natural depth and warmth to vocals or sax, etc.
- CHORUS 5** (Mono Doubling Chorus) : The effect of CHORUS 4 plus a doubling effect created by a short delay.
- CHORUS 6** (Mono Deep Chorus) : Deep chorus panned to center. Effective for adding body to a center-panned instrument such as bass.
- CHORUS 7** (Mono Deep Doubling Chorus) : The effect of CHORUS 6 plus a doubling effect created by a short delay.
- CHORUS 8** (Hi-Freq Chorus) : Chorus applied only to the high-frequency range.
- CHORUS 9** (Lo-Freq Chorus) : Chorus applied only to the low-frequency range.
- CHORUS 10** (Mono Delay Chorus) : Pitch chorus that adds depth to the sound by slightly shifting the pitch.
- CHORUS 11** (L-R Delay Chorus) : Pitch chorus panned to the center.

* **[ADJUST]** knob: Adjust the depth of the chorus.



• **PITCH**

- PITCH 1—3** (Pitch +/- 1oct.) : Pitch shift with a variable range of +/-1 octave. (No pitch shift when ADJUST = 0.) Select one of three variations: PITCH 1 is normal, PITCH 2 has faster response, and PITCH 3 is clearest.
- PITCH 4—6** (Pitch Shift Up) : Pitch shift with a variable range of 0—+2 octaves. (+1 octave when ADJUST = 0.) Select one of three variations: PITCH 4 is normal, PITCH 5 has faster response, and PITCH 6 is clearest.
- PITCH 7—9** (Pitch Shift Down) : Pitch shift with a variable range of -2—0 octaves. (-1 octave when ADJUST = 0.) Select one of three variations: PITCH 7 is normal, PITCH 8 has faster response, and PITCH 9 is clearest.
- PITCH 10** (Pitch Delay) : Pitch shift with delayed feedback. Offsetting the pitch will produce interesting results.
- PITCH 11** (SFX Pitch) : Pitch shift that produces a strange effect like a simulation of a space alien. We recommend that you set ADJUST to 0.

* **[ADJUST]** knob: Adjust the amount of pitch change. +/-1 octave.



• **FLANGE**

- FLANGE 1** (Dual Flange) : Dual flanging in which two effect sounds with different modulation phase are heard from left and right. Deep feedback.
- FLANGE 2** (Dual Flange Lo-Feedback) : Dual flanging. Light feedback.
- FLANGE 3** (Dual Flange No-Feedback) : Dual flanging. Almost no feedback.
- FLANGE 4** (Lo-Freq Flange) : Flanging with modulation in the low-frequency component. Deep feedback.
- FLANGE 5** (Double Width Flange Lo-Feedback) : Flanging with modulation in the low-frequency component. light feedback.
- FLANGE 6** (Hi-Freq Flange) : Flanging applied only to the high-frequency range.
- FLANGE 7** (Lo-Freq Flange) : Flanging applied only to the low-frequency range.
- FLANGE 8** (Mono Dual Flange) : Two types of flanging heard from the center. Deep feedback.
- FLANGE 9** (Mono Dual Flange Lo-Feedback) : Two types of flanging heard from the center. Light feedback.
- FLANGE 10** (Mono Single Flange) : One effect heard from the center. Deep feedback.
- FLANGE 11** (Mono Single Flange Lo-Feedback) : One effect heard from the center. Light feedback.

* **[ADJUST]** knob: Adjust the modulation speed of the flanging.



Effects in SINGLE 1 MODE

• L. HALL (Large Hall)

L. HALL 1 (Natural Large Hall)	: Same as DUAL mode L. HALL 1, but higher density reverberation.
L. HALL 2 (Lo-Freq Large Hall)	: Same as DUAL mode L. HALL 2, but higher density reverberation.
L. HALL 3 (Vivid Large Hall)	: Same as DUAL mode L. HALL 3, but higher density reverberation.
L. HALL 4 (Hard-Wall Large Hall)	: Same as DUAL mode L. HALL 4, but higher density reverberation.
L. HALL 5 (Soft-Wall Large Hall)	: Same as DUAL mode L. HALL 5, but higher density reverberation.
L. HALL 6 (Long Pre-Delay Large Hall)	: Same as DUAL mode L. HALL 6, but higher density reverberation.
L. HALL 7 (Cave)	: Same as DUAL mode L. HALL 7, but higher density reverberation.
L. HALL 8 (Stadium)	: Same as DUAL mode L. HALL 8, but higher density reverberation.
L. HALL 9 (Vivid Stadium)	: Same as DUAL mode L. HALL 9, but higher density reverberation.
L. HALL 10 (Auditorium)	: Reverb simulating a space with little reverberation, such as a large auditorium.
L. HALL 11 (Big Cave)	: Simulates a more spacious volume than the cave of L. HALL 7. Reverb time is longer.

- * **[EFFECT 1_ADJUST]** knob (PARAM.1): Adjust the Reverb Time.
- * **[EFFECT 2_ADJUST]** knob (PARAM.2): Adjust the E/R Level.
- * **[EFFECT 2_MIX]** knob (PARAM.3): Adjust the Character.



• S. HALL (Small Hall)

S. HALL 1 (Natural Small Hall)	: Same as DUAL mode S. HALL 1, but higher density reverberation.
S. HALL 2 (Lo-Freq Small Hall)	: Same as DUAL mode S. HALL 2, but higher density reverberation.
S. HALL 3 (Vivid Small Hall)	: Same as DUAL mode S. HALL 3, but higher density reverberation.
S. HALL 4 (Hard-Wall Small Hall)	: Same as DUAL mode S. HALL 4, but higher density reverberation.
S. HALL 5 (Soft-Wall Small Hall)	: Same as DUAL mode S. HALL 5, but higher density reverberation.
S. HALL 6 (Long Pre-Delay Small Hall)	: Same as DUAL mode S. HALL 6, but higher density reverberation.
S. HALL 7 (Narrow Small Hall)	: Same as DUAL mode S. HALL 7, but higher density reverberation.
S. HALL 8 (Dead Hall)	: Same as DUAL mode S. HALL 8, but higher density reverberation.
S. HALL 9 (Small Stadium)	: Same as DUAL mode S. HALL 9, but higher density reverberation.
S. HALL 10 (Out Door Stage)	: Simulation of an outdoor stage. Extremely small amount of reverberation.
S. HALL 11 (Flat Reverb)	: Small hall with no early reflections, and the entire frequency range decays in the same way.

- * **[EFFECT 1_ADJUST]** knob (PARAM.1): Adjust the Reverb Time.
- * **[EFFECT 2_ADJUST]** knob (PARAM.2): Adjust the E/R Level.
- * **[EFFECT 2_MIX]** knob (PARAM.3): Adjust the Character.

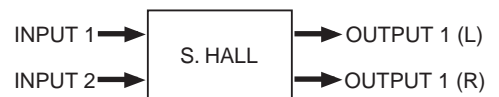

• ROOM

ROOM 1 (Natural Room)	: Same as DUAL mode ROOM 1, but higher density reverberation.
ROOM 2 (Garage)	: Same as DUAL mode ROOM 2, but higher density reverberation.
ROOM 3 (Dead Room)	: Same as DUAL mode ROOM 3, but higher density reverberation.
ROOM 4 (Live Room)	: Same as DUAL mode ROOM 4, but higher density reverberation.
ROOM 5 (Vivid Room)	: Same as DUAL mode ROOM 5, but higher density reverberation.
ROOM 6 (Off Mic)	: Same as DUAL mode ROOM 6, but higher density reverberation.
ROOM 7 (Hard Wall Drum Booth)	: Same as DUAL mode ROOM 7, but higher density reverberation.
ROOM 8 (Wood Wall Drum Booth)	: Same as DUAL mode ROOM 8, but higher density reverberation.
ROOM 9 (Live House)	: Same as DUAL mode ROOM 9, but higher density reverberation.
ROOM 10 (Back Stage)	: Amazing room reverb with a light flanging effect
ROOM 11 (Hi-Freq Room)	: Special reverb with flanging applied to the early reflections of the room.

- * **[EFFECT 1_ADJUST]** knob (PARAM.1): Adjust the Reverb Time.
- * **[EFFECT 2_ADJUST]** knob (PARAM.2): Adjust the E/R Level.
- * **[EFFECT 1_MIX]** knob (PARAM.3): Adjust the Character.



• PLATE

PLATE 1 (Normal Plate)	: Same as DUAL mode PLATE 1, but higher density reverberation.
PLATE 2 (Old Plate)	: Same as DUAL mode PLATE 2, but higher density reverberation.
PLATE 3 (Vivid Plate)	: Same as DUAL mode PLATE 3, but higher density reverberation.
PLATE 4 (Lo-Freq Plate)	: Same as DUAL mode PLATE 4, but higher density reverberation.
PLATE 5 (Sharp Plate)	: Same as DUAL mode PLATE 5, but higher density reverberation.
PLATE 6 (Mono Plate)	: Same as DUAL mode PLATE 6, but higher density reverberation.

- PLATE 7** (Dark Plate) : Same as DUAL mode PLATE 7, but higher density reverberation.
- PLATE 8** (Hi-Freq Plate) : Same as DUAL mode PLATE 8, but higher density reverberation.
- PLATE 9** (Mid-Freq Plate) : Same as DUAL mode PLATE 9, but higher density reverberation.
- PLATE 10** (Large E/R Plate) : Unusual plate reverb with a light flanging effect applied.
- PLATE 11** (Flat Plate) : Special reverb with an aggressive flanging effect applied.

- * **[EFFECT 1_ADJUST]** knob (PARAM.1): Adjust the Reverb Time.
- * **[EFFECT 2_ADJUST]** knob (PARAM.2): Adjust the E/R Level.
- * **[EFFECT 2_MIX]** knob (PARAM.3): Adjust the Character.



• VOCAL

- VOCAL 1** (Standard Vocal) : Same as DUAL mode VOCAL 1, but higher density reverberation.
- VOCAL 2** (Karaoke) : Same as DUAL mode VOCAL 2, but higher density reverberation.
- VOCAL 3** (Vocal Booth) : Same as DUAL mode VOCAL 3, but higher density reverberation.
- VOCAL 4** (Warm Vocal) : Same as DUAL mode VOCAL 4, but higher density reverberation.
- VOCAL 5** (Diffusion Vocal) : Same as DUAL mode VOCAL 5, but higher density reverberation.
- VOCAL 6** (Natural Vocal) : Same as DUAL mode VOCAL 6, but higher density reverberation.
- VOCAL 7** (Vivid Vocal) : Same as DUAL mode VOCAL 7, but higher density reverberation.
- VOCAL 8** (Wet Vocal) : Same as DUAL mode VOCAL 8, but higher density reverberation.
- VOCAL 9** (Doubling Vocal) : Same as DUAL mode VOCAL 9, but higher density reverberation.
- VOCAL 10** (Dry Vocal) : Mysterious reverb with a light flanging effect applied to VOCAL 1.
- VOCAL 11** (Stadium Vocal) : Mysterious reverb with a light flanging effect applied to VOCAL 4.

- * **[EFFECT 1_ADJUST]** knob (PARAM.1): Adjust the Reverb Time.
- * **[EFFECT 2_ADJUST]** knob (PARAM.2): Adjust the E/R Level.
- * **[EFFECT 2_MIX]** knob (PARAM.3): Adjust the Character.



• DLY + REV (Delay + Reverb)

- DLY+REV 1** (Mono Delay + Reverb) : Mono delay with reverberation.
- DLY+REV 2** (Long Mono Delay + Reverb) : Long mono delay with reverberation.
- DLY+REV 3** (L-R Delay + Reverb) : Panning delay with reverberation.
- DLY+REV 4** (Long L-R Delay + Reverb) : Long panning delay with reverberation.
- DLY+REV 5** (Short Delay + Reverb) : Short delay with reverberation.
- DLY+REV 6** (Lo-Freq Mono Delay) : Mono delay only for the low frequency range.
- DLY+REV 7** (Hi-Freq Mono Delay) : Mono delay only for the high frequency range.
- DLY+REV 8** (Lo-Freq L-R Delay) : Panning delay only for the low frequency range.
- DLY+REV 9** (Hi-Freq L-R Delay) : Panning delay only for the high frequency range.
- DLY+REV 10** (Lo-Freq L-R Delay + Reverb) : Panning delay only for the low frequency range, with reverberation.
- DLY+REV 11** (Hi-Freq L-R Delay + Reverb) : Panning delay only for the high frequency range, with reverberation.

- * **[EFFECT 1_ADJUST]** knob (PARAM.1): Adjust the Delay Time.
- * **[EFFECT 2_ADJUST]** knob (PARAM.2): Adjust the Delay Feedback.
- * **[EFFECT 2_MIX]** knob (PARAM.3): Adjust the Reverb Time.

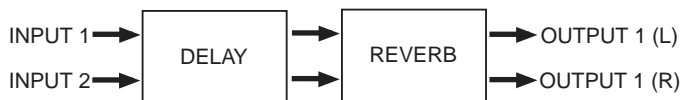

• DELAY

- DELAY 1** (Stereo Long Delay) : Long stereo delay with maintaining the stereo image.
- DELAY 2** (Stereo Delay) : Mid stereo delay with maintaining the stereo image.
- DELAY 3** (Stereo Short Delay) : Short stereo delay with maintaining the stereo image.
- DELAY 4** (Mono Long Delay) : Mono long delay.
- DELAY 5** (Mono Delay) : Mono short delay.
- DELAY 6** (L-R Long Delay) : Long panning delay.
- DELAY 7** (L-R Delay) : Short panning delay.
- DELAY 8** (Diffusion Long Delay) : Long diffusion delay.
- DELAY 9** (Diffusion Delay) : Short diffusion delay.
- DELAY 10** (Doubling) : Center-panned doubling.
- DELAY 11** (Diffusion Doubling) : Diffusion doubling.

- * **[EFFECT 1_ADJUST]** knob (PARAM.1): Adjust the Delay Time.
- * **[EFFECT 2_ADJUST]** knob (PARAM.2): Adjust the Delay Feedback.
- * **[EFFECT 2_MIX]** knob (PARAM.3): Adjust the Character.



• **MISC (Miscellaneous)**

- MISC 1** (Random E/R) : Random early reflections. When applied to instruments with a slow attack, this produces a natural feeling of air and space.
- MISC 2** (Soft Random E/R) : Random early reflections. Less high range than MISC 1, so suitable for backing tracks.
- MISC 3** (Tight Random E/R) : Random early reflections with only high-frequency components.
- MISC 4** (Long E/R) : Miraculous ambience that could not exist in the real world, with early reflections that continue without being covered by reverberant components.
- MISC 5** (Short E/R) : Random early reflections at close spacing appear all at once. Effective for giving natural spaciousness to pad-type sounds.
- MISC 6** (Large Hall E/R) : Early reflections of a large hall.
- MISC 7** (Soft Large Hall E/R) : Early reflections of a large hall. Gentler sound than MISC 4.
- MISC 8** (Small Hall E/R) : Early reflections of a small hall.
- MISC 9** (Soft Small Hall E/R) : Early reflections of a small hall. Gentler sound than MISC 6.
- MISC 10** (Reverse E/R) : Early reflections of reverse reverb. Effective on vocal or brass section.
- MISC 11** (Gate Reverb) : Gated early reflection with a crisp cutoff.

- * **[EFFECT 1_ADJUST]** knob (PARAM.1): Adjust the Room Size.
- * **[EFFECT 2_ADJUST]** knob (PARAM.2): Adjust the E/R Feedback.
- * **[EFFECT 2_MIX]** knob (PARAM.3): Adjust the Character.



• **CHORUS**

- CHORUS 1** (3D Chorus) : Simulation of an analog three-phase chorus with great spaciousness and depth.
- CHORUS 2** (Doubling Chorus) : CHORUS 1 plus a doubling effect produced by a short delay.
- CHORUS 3** (Mono Chorus) : Center-panned chorus. Ideal for vocals or sax.
- CHORUS 4** (Thin Chorus) : Clean thin chorus
- CHORUS 5** (Thin Doubling Chorus) : CHORUS 4 plus a doubling effect produced by a short delay.
- CHORUS 6** (Deep Chorus) : Deep chorus
- CHORUS 7** (Deep Doubling Chorus) : CHORUS 4 plus a doubling effect produced by a short delay.
- CHORUS 8** (Warm Chorus) : Complex chorus using the feedback algorithm.
- CHORUS 9** (Mono Warm Chorus) : Center-panned chorus of CHORUS 8.
- CHORUS 10** (SFX Chorus 1) : SFX chorus 1. Suitable for strings, Pad, etc.
- CHORUS 11** (SFX Chorus 2) : SFX chorus 2. Suitable for strings, Pad, etc.

- * **[EFFECT 1_ADJUST]** knob (PARAM.1): Adjust the Chorus Depth.
- * **[EFFECT 2_ADJUST]** knob (PARAM.2): Not used.
- * **[EFFECT 2_MIX]** knob (PARAM.3): Not used.



• **PITCH**

- PITCH 1—3** (Stereo Pitch) : Stereo pitch shift with maintaining the stereo image. Can be shifted within the range of +/- one octave. The internal processing of each type differs, resulting in the sound character difference.
 - Pitch 1: Recommended for general use.
 - Pitch 2: Recommended for use when the pitch variation is small, to get a smooth sound.
 - Pitch 3: Recommended for use when you do not want to alter the tone character. Note that, however, a delay is generated.
- PITCH 4—6** (Dual L-R Pitch) : Dual pitch shift. You can hear the two different pitch shifted sound from the center. The internal processing of each type differs, resulting in the sound character difference.
 - Pitch 4: Recommended for general use.
 - Pitch 5: Recommended for use when the pitch variation is small, to get a smooth sound.
 - Pitch 6: Recommended for use when you do not want to alter the tone character. Note that, however, a delay is generated.
- PITCH 7—9** (Dual Mono Pitch) : Dual pitch shift. You can hear the two different pitch shifted sound from the center. One octave higher than PITCH(es) 4 through 6. The internal processing of each type differs, resulting in the sound character difference.
 - Pitch 7: Recommended for general use.
 - Pitch 8: Recommended for use when the pitch variation is small, to get a smooth sound.
 - Pitch 9: Recommended for use when you do not want to alter the tone character. Note that, however, a delay is generated.
- PITCH 10** (Pitch Delay) : Dual pitch shift with long delay feedback. You can adjust two pitches and pitch adjustment.
- PITCH 11** (Pitch Sweeper) : Dual pitch shift with short delay feedback. You can adjust two pitches and pitch adjustment.

<PITCH-1, 2, 3>

- * **[EFFECT 1_ADJUST]** knob (PARAM.1): Adjust the Pitch.
- * **[EFFECT 2_ADJUST]** knob (PARAM.2): Not used.
- * **[EFFECT 2_MIX]** knob (PARAM.3): Adjust the Pitch 1/2.



<PITCH-14, 5, 6, 7, 8, 9, 10, 11>

- * **[EFFECT 1_ADJUST]** knob (PARAM.1): Adjust the Pitch 1.
- * **[EFFECT 2_ADJUST]** knob (PARAM.2): Adjust the Pitch 2.
- * **[EFFECT 2_MIX]** knob (PARAM.3): Adjust the Pitch 1/2.

• FLANGE

FLANGE 1 (Stereo Flange)	: Stereo flanger which applies flanging effect while maintaining the stereo image. Slow rate.
FLANGE 2 (Stereo Flange <Faster>)	: Stereo flanger which applies flanging effect while maintaining the stereo image. Fast rate.
FLANGE 3 (Stereo Dual Flange)	: Stereo flanger which applies two (normal and reverse) flanging effects while maintaining the stereo image. Slow rate.
FLANGE 4 (Stereo Dual Flange <Faster>)	: Stereo flanger which applies two (normal and reverse) flanging effects while maintaining the stereo image. Fast rate.
FLANGE 5 (Single Flange)	: Single flanger. Slow rate.
FLANGE 6 (Single Flange <Faster>)	: Single flanger. Fast rate.
FLANGE 7 (Dual Flange)	: Special dual flanger in which two types of flanging effects fly around complicatedly. Slow rate.
FLANGE 8 (Dual Flange <Faster>)	: Special dual flanger in which two types of flanging effects fly around complicatedly. Fast rate.
FLANGE 9 (Mono Dual Flange)	: Special mono dual flanger in which two types of flanging effects fly around complicatedly. Fast rate.
FLANGE 10 (Hi-Freq Flange)	: Special flanger which applies a flanging effect only to the high frequency range.
FLANGE 11 (Lo-Freq Flange)	: Flanger with double depth.

<FLANGE-1, 2, 3, 4, 5, 6>

- * [EFFECT 1_ADJUST] knob (PARAM.1): Adjust the Flange Rate.
- * [EFFECT 2_ADJUST] knob (PARAM.2): Not used.
- * [EFFECT 2_MIX] knob (PARAM.3): Adjust the Flange Feedback.

<FLANGE-7, 8, 9, 10, 11>

- * [EFFECT 1_ADJUST] knob (PARAM.1): Adjust the Flange Rate 1.
- * [EFFECT 2_ADJUST] knob (PARAM.2): Adjust the Flange Rate 2.
- * [EFFECT 2_MIX] knob (PARAM.3): Adjust the Flange Feedback.



Effects in SINGLE 2 MODE

• L. HALL (Large Hall)

L. HALL-1 (Special Large Hall 1)	: Hall reverb simulating a large hall with ideal acoustic characteristics which applies soft early reflection sound.
L. HALL-2 (Special Large Hall 2)	: Hall reverb simulating a large hall which applies different early reflection sound from L. HALL-1.
L. HALL-3 (Large Stage Reverb)	: Hall reverb sounding on the stage in a large hall.
L. HALL-4 (Large Stadium)	: Large stadium reverb.
L. HALL-5 (Large Theater)	: Large theater reverb.
L. HALL-6 (Warm Large Hall)	: Large hall reverb with thickness by applying chorus effect.
L. HALL-7 (Chorus Large Hall)	: Clean large hall reverb with chorus effect.
L. HALL-8 (Sizzle Large Hall)	: Large hall reverb with sizzle sound.
L. HALL-9 (Flanging Large Hall)	: Clean large hall reverb with deep flanging effect.
L. HALL-10 (Large Cave)	: Like a sound of wind blowing in a large cave.
L. HALL-11 (Large Tunnel)	: Reverb in a large tunnel with flanging effect.

- * **[EFFECT 1_ADJUST]** knob (PARAM.1): Adjust the Reverb Time.
- * **[EFFECT 2_ADJUST]** knob (PARAM.2): Adjust the E/R Level.
- * **[EFFECT 2_MIX]** knob (PARAM.3): Adjust the Character.



• S. HALL (Small Hall)

S. HALL-1 (Special Small Hall 1)	: Hall reverb simulating a small hall with ideal acoustic characteristics which applies soft early reflection sound.
S. HALL-2 (Special Small Hall 2)	: Hall reverb simulating a small hall which applies different early reflection sound from L. HALL-1.
S. HALL-3 (Small Stage Reverb)	: Hall reverb sounding on the stage in a small hall.
S. HALL-4 (Small Stadium)	: Small stadium reverb.
S. HALL-5 (Small Theater)	: Small theater reverb.
S. HALL-6 (Warm Small Hall)	: Small hall reverb with thickness by applying chorus effect.
S. HALL-7 (Chorus Small Hall)	: Clean small hall reverb with chorus effect.
S. HALL-8 (Sizzle Small Hall)	: Small hall reverb with sizzle sound.
S. HALL-9 (Flanging Small Hall)	: Clean small hall reverb with deep flanging effect.
S. HALL-10 (Small Cave)	: Like a sound of wind blowing in a small cave.
S. HALL-11 (Small Tunnel)	: Reverb in a small tunnel with flanging effect.

- * **[EFFECT 1_ADJUST]** knob (PARAM.1): Adjust the Reverb Time.
- * **[EFFECT 2_ADJUST]** knob (PARAM.2): Adjust the E/R Level.
- * **[EFFECT 2_MIX]** knob (PARAM.3): Adjust the Character.

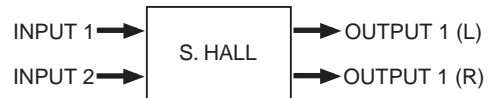

• ROOM

ROOM-1 (Long E/R Room)	: Room reverb with long early reflection.
ROOM-2 (Short E/R Room)	: Room reverb with short early reflection.
ROOM-3 (Room E/R)	: Room reverb with common early reflection. The amount of reverberation is small.
ROOM-4 (Announce Booth)	: Room reverb with short early reflection and the small amount of reverb sound.
ROOM-5 (Pf Booth)	: Reverb for adding the brightness to a piano sound.
ROOM-6 (Warm Room)	: Room reverb which emphasizes the thickness of sound by applying chorus effect.
ROOM-7 (Chorus Room)	: Room reverb with thin chorus effect.
ROOM-8 (Sizzle Room)	: Room reverb with the characteristic high frequency range.
ROOM-9 (Flanging Room)	: Room reverb with flanging effect.
ROOM-10 (Lo-F Flanging Room)	: Room reverb with flanging effect applied only to the low frequency range.
ROOM-11 (Hi-F Flanging Room)	: Room reverb with flanging effect applied only to the high frequency range.

- * **[EFFECT 1_ADJUST]** knob (PARAM.1): Adjust the Reverb Time.
- * **[EFFECT 2_ADJUST]** knob (PARAM.2): Adjust the E/R Level.
- * **[EFFECT 2_MIX]** knob (PARAM.3): Adjust the Character.



• PLATE

PLATE-1 (High-Density Plate)	: High density plate reverb.
PLATE-2 (High-Density Old Plate)	: High density plate reverb with deep and fat sound.
PLATE-3 (High-Density Vivid Plate)	: High density plate reverb with the vivid high frequency range.
PLATE-4 (Phase Shift Plate)	: Plate reverb with phase-shifted sound.
PLATE-5 (No E/R Plate)	: Neutral plate reverb sound, with no early reflection.
PLATE-6 (Warm Plate)	: Rich plate reverb sound with chorus effect.
PLATE-7 (Chorus Plate)	: Plate reverb with thin chorus effect.
PLATE-8 (Sizzle Plate)	: Plate reverb with the characteristic high frequency range.
PLATE-9 (Flange Plate)	: Plate reverb with flanging effect.
PLATE-10 (Lo-F Flange Plate)	: Plate reverb with flanging effect applied only to the low frequency range.
PLATE-11 (Hi-F Flange Plate)	: Plate reverb with flanging effect applied only to the high frequency range.

- * **[EFFECT 1_ADJUST]** knob (PARAM.1): Adjust the Reverb Time.
- * **[EFFECT 2_ADJUST]** knob (PARAM.2): Adjust the E/R Level.
- * **[EFFECT 2_MIX]** knob (PARAM.3): Adjust the Character.



• **MIC SIM (Microphone Simulation)**

- MIC SIM-1** (Trad Condenser 3k, Low Cut: Off) : Simulates the sound of a multipurpose professional condenser microphone with a large diaphragm. Its warm and transparent sound is suitable for a vocal, as well as a drum overhead or guitar amplifier.
- MIC SIM-2** (Trad Condenser 3k, Low Cut: On) : Simulates the sound of "MIC SIM-1" above with the Low Cut switch to On. You can suppress boosted low frequencies as a result from placing a microphone in close proximity to the signal source.
- MIC SIM-3** (Trad Condenser 414, Low Cut: Off) : Simulates the sound of one of the most popular condenser microphones in professional studios together with the Classic condenser 87. You can get a high-fidelity clean sound of an acoustic piano.
- MIC SIM-4** (Trad Condenser 414, Low Cut: 150Hz) : Simulates the sound of "MIC SIM-3" above with the Low Cut switch to On. You can suppress boosted low frequencies.
- MIC SIM-5** (Trad Dynamic 112) : Simulates the sound of a dynamic microphone suitable for a kick. You can get a clean and powerful sound by applying it to a kick or bass. It has a slightly boosted low frequencies.
- MIC SIM-6** (German Dynamic 421) : Simulates the sound of a dynamic microphone which is frequently used for recording a tom-tom. Suitable for recording a skin percussion because of its powerful attack feeling with a high frequency peak.
- MIC SIM-7** (German Dynamic 421, Low Cut: 2) : Simulates the sound of "MIC SIM-6" above with the Low Cut switch to On. You can suppress boosted low frequencies more than "MIC SIM-6".
- MIC SIM-8** (German Dynamic 421, Low Cut: SPE) : Simulates the sound of "MIC SIM-6" above with the Low Cut switch to On (SPE). You can considerably suppress boosted low frequencies. Suitable for a speech.
- MIC SIM-9** (Modern Condenser 2) : Simulates the sound of a modern condenser microphone which has a wider dynamic range and bright sound. It offers a warm tube sound, making a vocal or acoustic guitar as if it were recorded by a condenser microphone.
- MIC SIM-10** (Vintage Condenser 47) : Simulates a professional tube microphone with a large diaphragm that offers clean and dry sound. Suitable for an acoustic guitar and brass.
- MIC SIM-11** (Vintage Condenser 87, Low Cut: Off) : Simulates the sound of a classic and historic model used for vocals and strings frequently in professional studios. Provides outstanding warm sound among condenser microphones.

- * **[EFFECT 1_ADJUST]** knob (PARAM.1): Not used.
- * **[EFFECT 2_ADJUST]** knob (PARAM.2): Adjust the Distortion Output Level.
- * **[EFFECT 2_MIX]** knob (PARAM.3): Adjust the Gate Threshold.

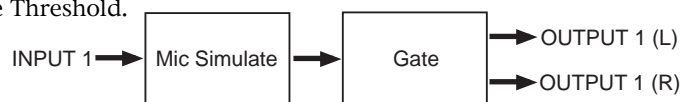

• **AMP SIM (Amplifier Simulation)**

- AMP SIM-1** (British 800 Amplifier) : Simulates the 800-series British tube amplifier, a synonym for "rock." The king of the rock sound of the 80's hard rock and heavy metal. Distorted raging sound.
- AMP SIM-2** (Tremo Recti Amplifier) : Simulates the American combo model amplifier, designed to get high gain sound for the 90's hard rock and heavy metal. Fat bass and raging distorted sound.
- AMP SIM-3** (Metal Panel Recti Amplifier) : Simulates the amp head of the high gain amp series, same as the Tremo Recti Amplifiers. Deep and well-separated distortion and heavy sound. Suitable for the metal sound.
- AMP SIM-4** (British Class A30 Amplifier) : Simulates a most popular British sound tube amplifier. The preamp section is designed using the class A circuit for creating the fat and warm sound. Usually used in the range between clear and crunch sound, but sometimes used with the higher gain to get a harder distortion.
- AMP SIM-5** (Fat Bass Amplifier) : Simulates the American combo amplifier designed as a bass amplifier but used by many guitarists because of its fat presence sound. Suitable for jazz and blues with its clear and crunch sound, however, because you can get a raging distortion that you cannot expect from an ordinary bass amplifier when raising the gain. It can be used for a wide range of genres.
- AMP SIM-6** (Kick) : You can distort a kick sound appropriately.
- AMP SIM-7** (Snare 1) : You can distort a snare sound appropriately.
- AMP SIM-8** (Snare 2) : You can distort a snare sound excessively.
- AMP SIM-9** (Voice 1) : You can get a smooth distortion.
- AMP SIM-10** (Voice 2) : You can get a boomy and bright distortion.
- AMP SIM-11** (Radio Voice) : You can get a bullhorn sound.

- * **[EFFECT 1_ADJUST]** knob (PARAM.1): Adjust the Distortion Gain.
- * **[EFFECT 2_ADJUST]** knob (PARAM.2): Adjust the Distortion Output Level.
- * **[EFFECT 2_MIX]** knob (PARAM.3): Adjust the Gate Threshold.

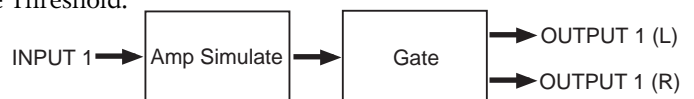

• **DISTORTION**

- DIST-1** (Distortion) : You can get a hard distortion like driving a three-stacked amplifier.
- DIST-2** (Rhythm) : You can get a slight distortion when picking the guitar strongly.
- DIST-3** (Over Drive) : You can get a smooth distortion like driving a tube amplifier.
- DIST-4** (Acoustic) : You can get an electric-acoustic guitar sound.
- DIST-5** (Blues) : You can get a fat overdrive sound.
- DIST-6** (Fuzz) : You can get a rough sound with a fat low frequency range.
- DIST-7** (Lead) : You can get a bright and smooth distortion.

- DIST-8** (Metal) : You can get a shred sound.
- DIST-9** (Bass 1) : Simulates a bass amplifier.
- DIST-10** (Bass 2) : You can get a sound like recording a distorted bass sound through a line.
- DIST-11** (Bass 3) : You can get a fat bass sound.

- * **[EFFECT 1_ADJUST]** knob (PARAM.1): Adjust the Distortion Gain.
- * **[EFFECT 2_ADJUST]** knob (PARAM.2): Adjust the Distortion Output Level.
- * **[EFFECT 2_MIX]** knob (PARAM.3): Adjust the Gate Threshold.

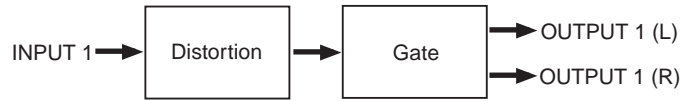

• GUITAR MULTI 1

- G. MULTI 1-1** (Natural Clean Guitar) : Clean guitar sound featuring natural compression and moderate reverberation.
- G. MULTI 1-2** (Vivid Chorus Guitar) : Contemporary guitar sound featuring a vivid and clear tone.
- G. MULTI 1-3** (Warm Chorus Guitar) : Warm and clean guitar sound with a deep chorus effect.
- G. MULTI 1-4** (Rhythm Guitar) : Designed for a rhythm guitar, with compression and drive circuits.
- G. MULTI 1-5** (Warm Rhythm Guitar) : Designed for a rhythm guitar with warm sound, by adding a chorus effect.
- G. MULTI 1-6** (Flange Rhythm Guitar) : Designed for a rhythm guitar with a flanging effect.
- G. MULTI 1-7** (Acoustic Guitar) : Simulates an acoustic guitar sound, with applying compression and reverberation.
- G. MULTI 1-8** (Crunch Guitar) : Crunch guitar sound.
- G. MULTI 1-9** (Vivid Crunch) : Crunch guitar sound with a moderate chorus effect.
- G. MULTI 1-10** (Delay Crunch Solo) : Crunch guitar sound with L-R delay. Suitable for a mellow song.
- G. MULTI 1-11** (Flange Crunch Solo) : Crunch guitar sound with a light and coarse flanging effect, featuring a brilliant high frequency range.

<G. MULTI-1, 2, 3>

- * **[EFFECT 1_ADJUST]** knob (PARAM.1): Adjust the Modulation Level.
- * **[EFFECT 2_ADJUST]** knob (PARAM.2): Adjust the Reverb/Delay Level.
- * **[EFFECT 2_MIX]** knob (PARAM.3): Adjust the Gate Threshold.

<G. MULTI-4, 5, 6, 7, 8, 9, 10, 11>

- * **[EFFECT 1_ADJUST]** knob (PARAM.1): Adjust the Distortion Gain.
- * **[EFFECT 2_ADJUST]** knob (PARAM.2): Adjust the Distortion Output.
- * **[EFFECT 2_MIX]** knob (PARAM.3): Adjust the Gate Threshold.



<NOTE>

When using any one of G_MULTI 1 settings above and no input signal is fed, you may hear an input noise. This is due to the character of the effects. In such a case, you can reduce the noise by setting the gate to "on" (by PARAM 3).

• GUITAR MULTI 2

- G. MULTI 2-1** (Warm Distortion) : Distortion guitar sound like the JCM800.
- G. MULTI 2-2** (Heavy Distortion) : Distortion guitar sound like Recti Head.
- G. MULTI 2-3** (Thin Flange Distortion) : Distortion guitar sound with a moderate flanging effect.
- G. MULTI 2-4** (Deep Flange Distortion) : Distortion guitar sound with a deep flanging effect.
- G. MULTI 2-5** (Thin Metal Flange) : Metal distortion with thin flanging effect.
- G. MULTI 2-6** (Deep Metal Flange) : Metal distortion with deep flanging effect.
- G. MULTI 2-7** (Blues Lead) : Natural and mild lead guitar sound.
- G. MULTI 2-8** (Distortion Lead) : Bright lead guitar sound by applying a short delay.
- G. MULTI 2-9** (Mono Delay Lead) : Lead guitar sound with a mono delay.
- G. MULTI 2-10** (L-R Delay Lead) : Lead guitar sound with an L-R delay.
- G. MULTI 2-11** (Delay Chorus Lead) : Lead guitar sound with an L-R delay and a chorus.

- * **[EFFECT 1_ADJUST]** knob (PARAM.1): Adjust the Distortion Gain.
- * **[EFFECT 2_ADJUST]** knob (PARAM.2): Adjust the Distortion Output.
- * **[EFFECT 2_MIX]** knob (PARAM.3): Adjust the Gate Threshold.



<NOTE>

When using any one of G_MULTI 2 settings above and no input signal is fed, you may hear an input noise. This is due to the character of the effects. In such a case, you can reduce the noise by setting the gate to "on" (by PARAM 3).

• BASS MULTI

B. MULTI-1 (Normal Bass)	: Normal bass sound with compression tuned for a bass.
B. MULTI-2 (Slap Bass)	: Slap bass sound with compression and natural modulation.
B. MULTI-3 (Fretless Bass)	: Deeply moderated bass sound.
B. MULTI-4 (Distortion Bass 1)	: Slightly distorted bass sound which stands out in the orchestra sound.
B. MULTI-5 (Distortion Bass 2)	: More distorted sound than B. MULTI-4, resulting in more distinct sound.
B. MULTI-6 (Distortion Bass 3)	: Distorted sound with moderate flanging effect.
B. MULTI-7 (Ambience Bass Solo 1)	: Natural bass sound. Suitable for a bass solo.
B. MULTI-8 (Ambience Bass Solo 2)	: Distorted sound with natural feeling.
B. MULTI-9 (Flange Bass 1)	: Moderate flanged bass sound.
B. MULTI-10 (Flange Bass 2)	: Deep flanged bass sound.
B. MULTI-11 (Chorus Bass)	: Rich and spacious bass sound by adding a chorus effect. Recommended to be used with a reverb.

<B. MULTI-1, 2, 3, 7, 9, 10, 11>

- * **[EFFECT 1_ADJUST]** knob (PARAM.1): Adjust the Modulation Level.
- * **[EFFECT 2_ADJUST]** knob (PARAM.2): Adjust the Reverb/Delay Level.
- * **[EFFECT 2_MIX]** knob (PARAM.3): Adjust the Gate Threshold.

<B. MULTI-4, 5, 6, 8>

- * **[EFFECT 1_ADJUST]** knob (PARAM.1): Adjust the Distortion Gain.
- * **[EFFECT 2_ADJUST]** knob (PARAM.2): Adjust the Distortion Output.
- * **[EFFECT 2_MIX]** knob (PARAM.3): Adjust the Gate Threshold.



<NOTE>

When using any one of BASS MULTI settings above and no input signal is fed, you may hear an input noise. This is due to the character of the effects. In such a case, you can reduce the noise by setting the gate to "on" (by PARAM 3).

• VOCAL MULTI

V. MULTI-1 (Normal Vocal)	: Light compression and reverberation applied only to the high frequency range.
V. MULTI-2 (Doubling Vocal)	: Light compression and moderate short delay. Suitable for adding the brightness to a dull vocal.
V. MULTI-3 (Diffusion Vocal)	: Designed for adding a chorus effect to a center positioned vocal.
V. MULTI-4 (Distortion Vocal)	: Distorted vocal sound for standing out the vocal.
V. MULTI-5 (Flange Distortion Vocal)	: Distorted vocal sound with adding a moderate flanging effect. A unique sound can be generated.
V. MULTI-6 (Radio Voice)	: Typical "radio voice". Simulates a radio sound with its characteristic compression.
V. MULTI-7 (Small Radio Voice)	: Simulate a smaller radio than V. MULTI-6.
V. MULTI-8 (Flange Voice)	: A special voice that can be used as an effect voice.

<V. MULTI-1, 2, 3, 6>

- * **[EFFECT 1_ADJUST]** knob (PARAM.1): Adjust the Modulation Level.
- * **[EFFECT 2_ADJUST]** knob (PARAM.2): Adjust the Reverb/Delay Level.
- * **[EFFECT 2_MIX]** knob (PARAM.3): Adjust the Gate Threshold.

<V. MULTI-4, 5, 7, 8>

- * **[EFFECT 1_ADJUST]** knob (PARAM.1): Adjust the Distortion Gain.
- * **[EFFECT 2_ADJUST]** knob (PARAM.2): Adjust the Distortion Output.
- * **[EFFECT 2_MIX]** knob (PARAM.3): Adjust the Gate Threshold.



V. MULTI-9 (Line Select 1)	: Input 1 routes to Output 1/L, while Input 2 routes to Output 1/R.
V. MULTI-10 (Line Select 2)	: Input 1 routes to Output 2/L, while Input 2 routes to Output 2/R.
V. MULTI-11 (Mute)	: No signal is output from Output 1/2.

* Parameter Settings: Non.

<NOTE>

When using any one of VOCAL MULTI settings above and no input signal is fed, you may hear an input noise. This is due to the character of the effects. In such a case, you can reduce the noise by setting the gate to "on" (by PARAM 3).

Names and Functions (Front panel section)

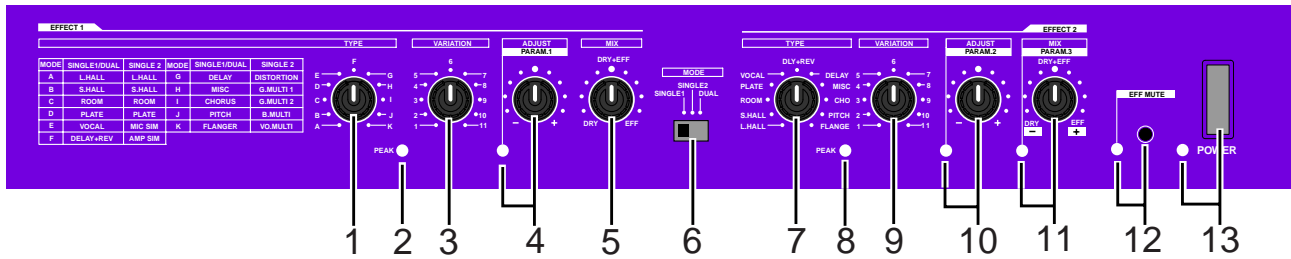

1. EFFECT 1 TYPE switch

Selects the type for EFFECT 1 in the dual mode or for the effect in the single (1 or 2) mode. You can select from among 11 effect types for each mode as shown in the table below.

MODE SW	SINGLE 1/DUAL	SINGLE 2	MODE SW	SINGLE 1/DUAL	SINGLE 2
A	L. HALL	L. HALL	G	DELAY	DISTORTION
B	S. HALL	S. HALL	H	MISC	G. MULTI 1
C	ROOM	ROOM	I	CHORUS	G. MULTI 2
D	PLATE	PLATE	J	PITCH	B. MULTI
E	VOCAL	MIC SIM	K	FLANGER	VO. MULTI
F	DELAY + REV	AMP SIM			

2. EFFECT 1 PEAK indicator

Lights up when the input level of EFFECT 1 in the dual mode or of the effect in the single (1 or 2) mode exceeds "+6 dB" which is just below the clipping level.

3. EFFECT 1 VARIATION switch

Selects the variation for EFFECT 1 in the dual mode or for the effect in the single (1 or 2) mode. You can select from among 11 variations.

4. EFFECT 1 ADJUST/PARAM. 1 control and indicator

Adjusts the parameter value for EFFECT 1 in the dual mode or the parameter 1 value for the effect in the single (1 or 2) mode. The center position is the default. Turning left decreases the value while turning right increases the value.

5. EFFECT 1 MIX control

Adjusts the balance of the output sound from the OUTPUT 1 jacks on the rear panel in the dual or single mode.

- Hard left :DRY 100%, EFFECT 0%
- Center :DRY 50%, EFFECT 0%
- Hard right :DRY 0%, EFFECT 100%

6. MODE select switch

Selects the mode between DUAL, SINGLE 1 and SINGLE 2.

7. EFFECT 2 TYPE switch

Selects the type for EFFECT 2 in the dual mode. This switch does not function in the single (1 or 2) mode. You can select from among 11 effect types, as same as EFFECT 1.

8. EFFECT 2 PEAK indicator

Lights up when the input level of EFFECT 2 in the dual mode exceeds "+6 dB" which is just below the clipping level. This indicator does not function in the single (1 or 2) mode. We recommend to adjust the INPUT LEVEL control on the rear panel appropriately so that this indicator sometimes lights up.

9. EFFECT 2 VARIATION switch

Selects the variation for the effect type selected for EFFECT 2 in the dual mode. This switch does not function in the single (1 or 2) mode. You can select from among 11 variations, as same as EFFECT 1.

10. EFFECT 2 ADJUST/PARAM. 2 control and indicator

Adjusts the parameter value for EFFECT 2 in the dual mode or the parameter 2 value for the effect in the single (1 or 2) mode. The center position is the default. Turning left decreases the value while turning right increases the value.

11. EFFECT 2 MIX/PARAM. 3 control and indicator

Adjusts the balance of the output sound from the OUTPUT 2 jacks on the rear panel in the dual mode.

- Hard left :DRY 100%, EFFECT 0%
- Center :DRY 50%, EFFECT 0%
- Hard right :DRY 0%, EFFECT 200%

In the single mode, this control adjusts the parameter 3 value for the selected effect type. The center position is the default. Turning left decreases the value while turning right increases the value.

12. EFFECT MUTE switch and indicator

Each press of the switch alternates on and off of EFFECT MUTE. The indicator lights up when the mute is on, while it turns off when the mute is off.

Note that the dry sound is not muted regardless of the switch setting.

<NOTE>

When connecting an external foot switch and stepping it down, pressing this switch does not alternate on and off of EFFECT MUTE.

13. POWER switch and indicator

Turns the power on or off. The indicator lights up when the power is on.

<Hints: About the ADJUST indicators for parameters>

Each ADJUST indicator lights when moving the appropriate control after changing the effect type or variation. This shows that the current position of the control matches the parameter value.

On the contrary, if you change the effect type or variation while the indicator is lit, it turns off. This the parameter is set to the default value.

Names and Functions (Rear panel section)

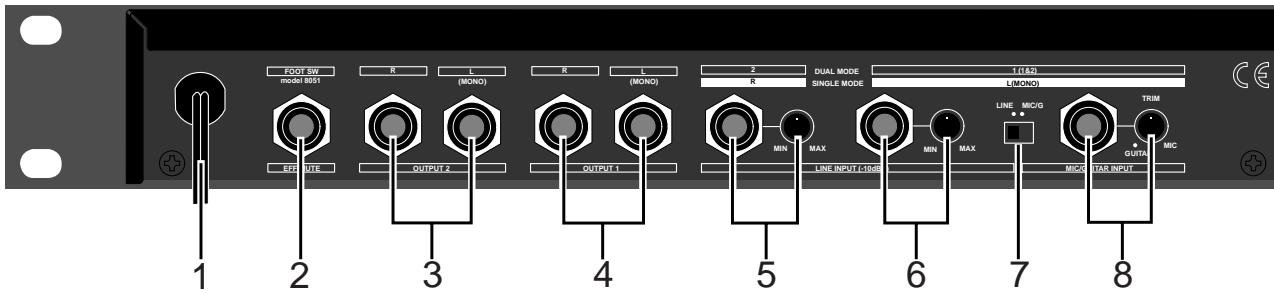

1. Power cord

2. FOOT SW jack

By connecting the optional Model 8051 foot switch to this jack, you can alternate on or off of the EFFECT MUTE function via the foot switch.

Contact our dealer or local Fostex sales office if you want to know details about the Model 8051.

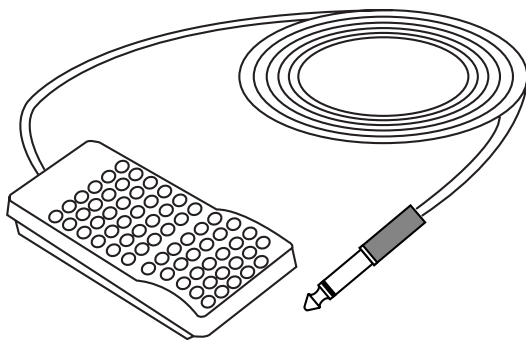

3. OUTPUT 2 jacks (L (MONO), R)

In the dual mode, these jacks feed the EFFECT 2 sound in stereo (L and R). In the single mode (1 or 2), they do not feed any signal. When only the "L (MONO)" jack is plugged, it feeds the summed signal of L and R.

4. OUTPUT 1 jacks (L (MONO), R)

In the dual mode, these jacks feed the EFFECT 1 sound in stereo (L and R). In the single mode, they feed the selected effect sound in stereo (L and R). When only the "L (MONO)" jack is plugged, it feeds the summed signal of L and R.

5. LINE INPUT 2 jack/Input level control

This jack is used to connect to a line level (-10 dBV) source. In the dual mode, the source signal is routed to EFFECT 2. You can adjust the input level by the control beside the jack while monitoring the appropriate peak indicator.

In the single mode, the source signal is routed to the R channel of the effect.

You can adjust the input level by the input level control beside the jack while monitoring the appropriate peak indicator.

6. LINE INPUT 1 jack and Input level control

This jack connects to a line level (-10 dBV) source. It is active when the input select switch is set to "LINE".

In the dual mode, the source signal is routed to EFFECT 1. When the INPUT 2 (R) jack is not plugged, the same signal is fed to both EFFECT 1 and EFFECT 2. You can adjust the input level by the control beside the jack while monitoring the appropriate peak indicator.

In the single mode, the source signal is routed to the L channel of the effect. When the INPUT 2 (R) jack is not plugged, the same signal is fed to both the L and R channels of the effect.

You can adjust the input level by the input level control beside the jack while monitoring the appropriate peak indicator.

<NOTE>

When the input select switch is set to "MIC/G", this jack is not active.

7. Input select switch

Selects the input jack to be active for INPUT 1.

LINE	The LINE INPUT jack is active. You can connect a line level source.
MIC/G	The MIC/GUITAR INPUT jack is active. You can connect a microphone or guitar directly.

8. MIC/GUITAR INPUT jack and TRIM control

This jack is used to connect to a microphone or guitar. It is active when the input select switch is set to "MIC/G".

In the dual mode, the source signal is routed to EFFECT 1. When the INPUT 2 (R) jack is not plugged, the same signal is fed to both EFFECT 1 and EFFECT 2. You can adjust the input level by the control beside the jack while monitoring the appropriate peak indicator.

In the single mode, the source signal is routed to the L channel of the effect. When the INPUT 2 (R) jack is not plugged, the same signal is fed to both the L and R channels of the effect.

You can adjust the input level by the TRIM control beside the jack while monitoring the appropriate peak indicator.

<NOTE>

When the input select switch is set to "LINE", this jack is not active.

How to use the Dual Mode

We describe how to use the Dual Mode below.

- <About features of the Dual Mode>**
1. You can use the DE-10 as a two-channel effect processing unit.
 2. Each effect processor (EFFECT 1 and EFFECT 2) provides a mono input and stereo output jacks.
 3. A main parameter for each effect can be edited from the preset value.

The following shows the example of using the dual mode, in which the DE-10 is connected between the AUX SEND and AUX RTN jacks for applying the desired effect to a sound.

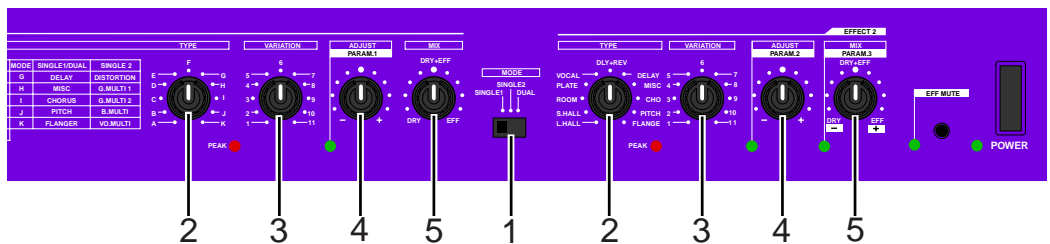
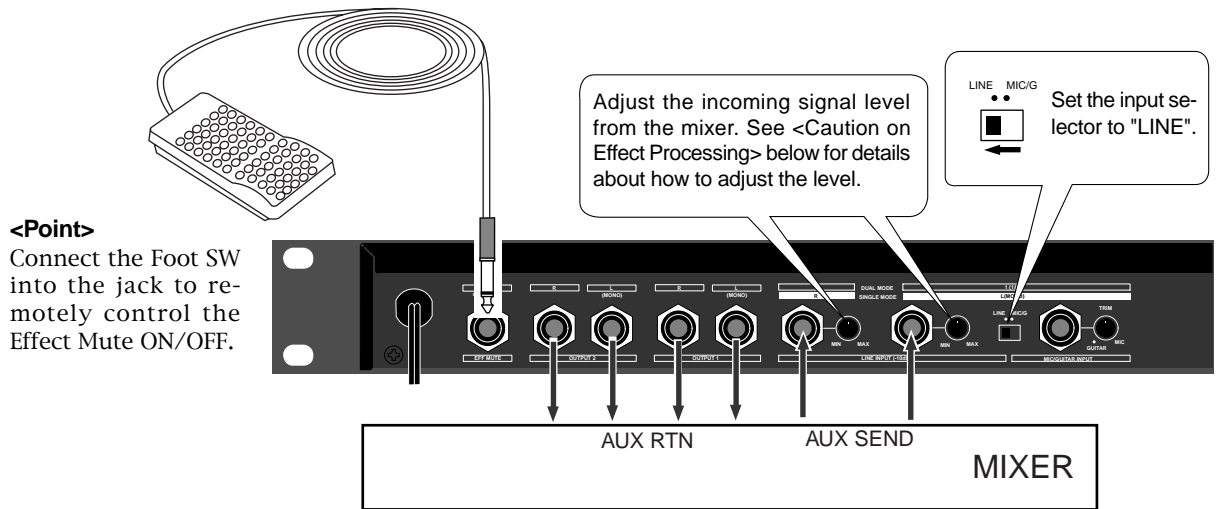

<Front panel settings>

1. Set the **MODE** switch to "DUAL".
2. Set the **TYPE** switch for each of **EFFECT 1** and **2** to the desired position.
You can select from among the following eleven types. See page 5~7 for details about each type.

MODE SW	SINGLE 1/DUAL	SINGLE 2	MODE SW	SINGLE 1/DUAL	SINGLE 2
A	L. HALL	L. HALL	G	DELAY	DISTORTION
B	S. HALL	S. HALL	H	MISC	G. MULTI 1
C	ROOM	ROOM	I	CHORUS	G. MULTI 2
D	PLATE	PLATE	J	PITCH	B. MULTI
E	VOCAL	MIC SIM	K	FLANGER	VO. MULTI
F	DELAY + REV	AMP SIM			

3. Set the **VARIATION** switch for each of **EFFECT 1** and **2** to the desired position.
4. Using the appropriate **ADJUST** control, adjust the parameter for each of **EFFECT 1** and **2**.
5. Using the appropriate **MIX** control, adjust the mixing balance of dry and effect signals fed from the **OUTPUT** jacks for each of **EFFECT 1** and **2**.

<About PEAK indicator>
The PEAK indicator on the front panel illuminates when the input signal to be monitored reaches 6 dB below the clipping level. Adjust the input level appropriately so that the PEAK indicator occasionally flickers. If you hear the output sound distorted though the PEAK indicator does not steadily light or illuminate so often, it may be due to the signal level increase in the effect processing. In such a case, reduce the input level so that the output sound is not distorted.

<Note on changing the switch position>
When you change the position of the **MODE**, **EFFECT TYPE**, or **VARIATION** switch, the DE-10 resets the internal DSP and the output signal disappears momentarily. This is due to not a malfunction.

<Notes on using the ADJUST and MIX controls>

- When you turn the **ADJUST** or **MIX** control, a click may be generated with some effect type.
- If the default of a parameter is the maximum or minimum value, you cannot increase or decrease the value using the **ADJUST** control, respectively.

How to use the Single (1/2) Mode

We describe how to use the single (1 or 2) mode below.

<About features of the Single Mode>

1. You can use the DE-10 as a high quality single-channel effect processing unit.
2. Stereo inputs and outputs are provided.
3. Three main parameters for each effect can be edited from the preset values.
4. You can apply a higher density reverberation than the dual mode.
5. For the delay, flange and pitch effects, the independent channel algorithm is employed, offering completely separated processing for L and R channels.

The following shows the examples of using the single mode for a live performance, in which a guitar, keyboard and microphone are directly connected to the DE-10, while the effect outputs of the DE-10 are connected to a keyboard amplifier or guitar amplifier.

You can also use the Model 8051 optional foot switch for controlling on/off of EFFECT MUTE.

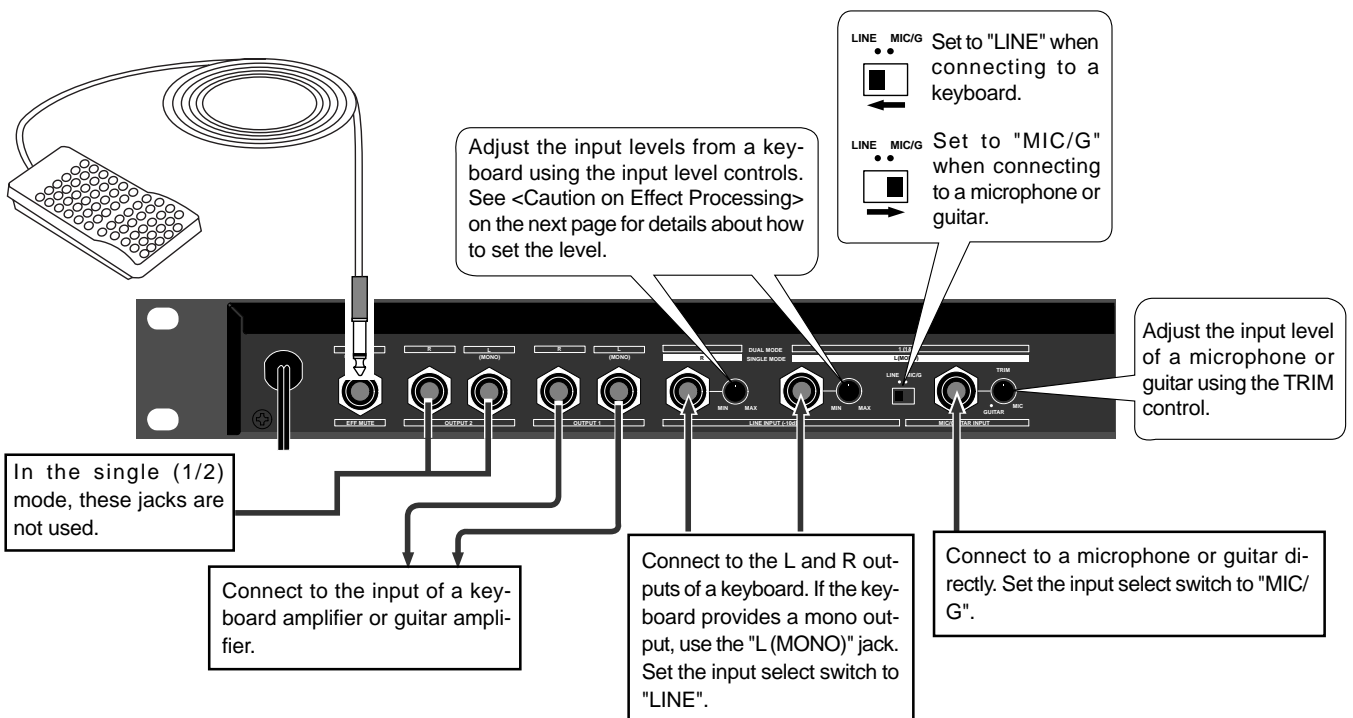
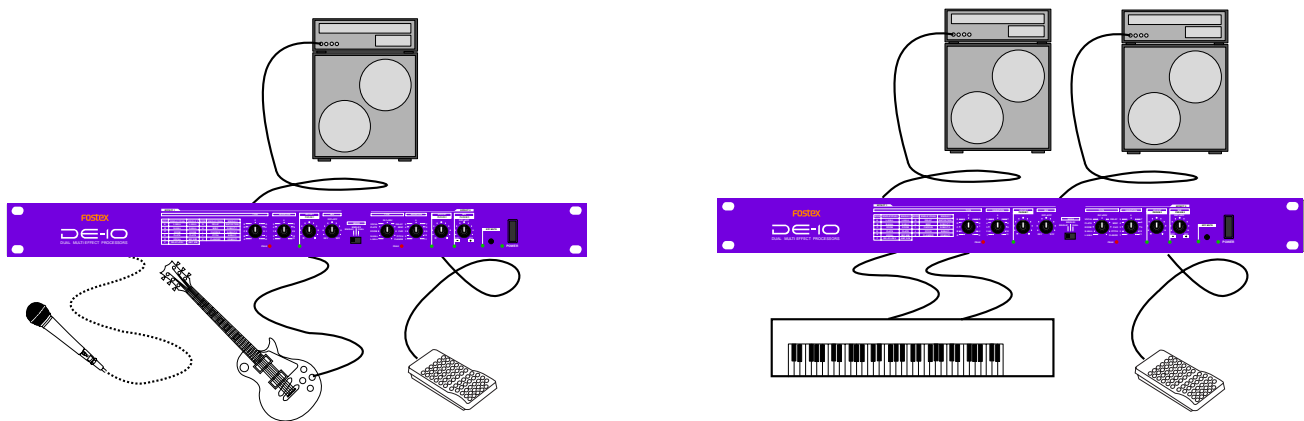

In the single (1/2) mode, these controls and indicators are not used.

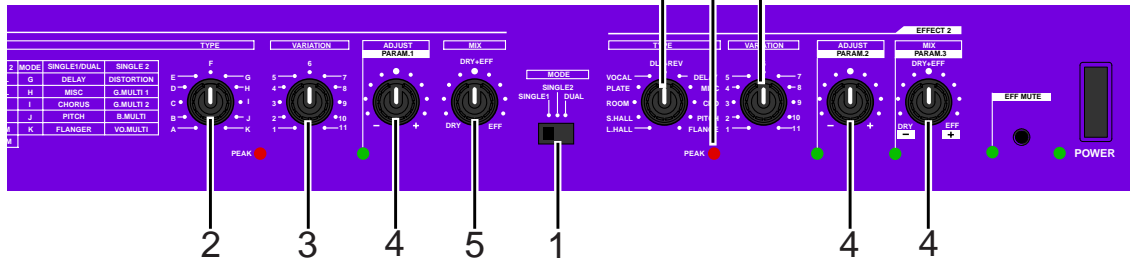

<Front panel settings>

1. Set the **MODE** switch to "SINGLE 1" or "SINGLE 2".

2. Set the **TYPE** switch to the desired position.
 You can select from among the following eleven types for each single mode. See page 8~15 for details about each type.

• **When selecting "SINGLE 1".**

MODE SW	SINGLE 1/DUAL	SINGLE 2	MODE SW	SINGLE 1/DUAL	SINGLE 2
A	L. HALL	L. HALL	G	DELAY	DISTORTION
B	S. HALL	S. HALL	H	MISC	G. MULTI 1
C	ROOM	ROOM	I	CHORUS	G. MULTI 2
D	PLATE	PLATE	J	PITCH	B. MULTI
E	VOCAL	MIC SIM	K	FLANGER	VO. MULTI
F	DELAY + REV	AMP SIM			

• **When selecting "SINGLE 2".**

MODE SW	SINGLE 1/DUAL	SINGLE 2	MODE SW	SINGLE 1/DUAL	SINGLE 2
A	L. HALL	L. HALL	G	DELAY	DISTORTION
B	S. HALL	S. HALL	H	MISC	G. MULTI 1
C	ROOM	ROOM	I	CHORUS	G. MULTI 2
D	PLATE	PLATE	J	PITCH	B. MULTI
E	VOCAL	MIC SIM	K	FLANGER	VO. MULTI
F	DELAY + REV	AMP SIM			

3. Set the **VARIATION** switch to the desired position.

4. Using the **ADJUST (PARAM 1 through PARAM 3)** controls, adjust the effect parameters.

In the single mode, you can control three parameters for each effect, as shown in the table below.

5. Using the **MIX** control, adjust the mixing balance of dry and effect signals fed from the appropriate **OUTPUT** jacks.

<About PEAK indicator>
 The PEAK indicator on the front panel illuminates when the input signal to be monitored reaches 6 dB below the clipping level. Adjust the input level appropriately so that the PEAK indicator occasionally flickers. If you hear the output sound distorted though the PEAK indicator does not steadily light or illuminate so often, it may be due to the signal level increase in the effect processing. In such a case, reduce the input level so that the output sound is not distorted.

<Note on changing the switch position>
 When you change the position of the MODE, EFFECT TYPE, or VARIATION switch, the DE-10 resets the internal DSP and the output signal disappears momentarily. This is due to not a malfunction.

<Notes on using the ADJUST and MIX controls>

- When you turn the ADJUST or MIX control, a click may be generated with some effect type.
- If the default of a parameter is the maximum or minimum value, you cannot increase or decrease the value using the ADJUST control, respectively.

Specifications

<INPUT x 3>

LINE INPUT x 2

- Connector: \varnothing 6mm phone jack/unbalanced
- Input Impedance: 20k Ω or more
- Input Level: -10dBV

MIC/GUITAR x 1

- Connector: \varnothing 6mm phone jack/unbalanced
- Input Impedance: 500k Ω or more
- Input Level: -55dBV ~ -15dBV (Controllable)

<OUTPUT x 4>

- Connector: \varnothing 6mm phone jack/unbalanced
- Output Impedance: 10k Ω or more
- Output Level: -10dBV

<FOOT SW>

- Connector: \varnothing 6mm phone jack (Optional Model 8051)

<OTHERS>

- Frequency Response: 20kHz ~ 20kHz (TYPICAL)
- Dynamic Range: 92dB (TYPICAL)
- AD converter: 20bit 64 times over sampling delta sigma
- DA converter: 24 bit 128 times over sampling delta sigma
- Total Harmonic Distortion: 0.01% (TYPICAL)
- Sampling Frequency: 44.1kHz

<GENERAL>

- Dimensions: 482 (W) x 44 (H) x 230 (D) mm
- Weight: Approx. 2.5kg
- Power Supply: 120V AC 60Hz, 230V ~ 50/60Hz
- Power Consumption: 8W

• Specifications and appearance are subjects to change without notice for product improvement.

Block Diagram

Dual Mode

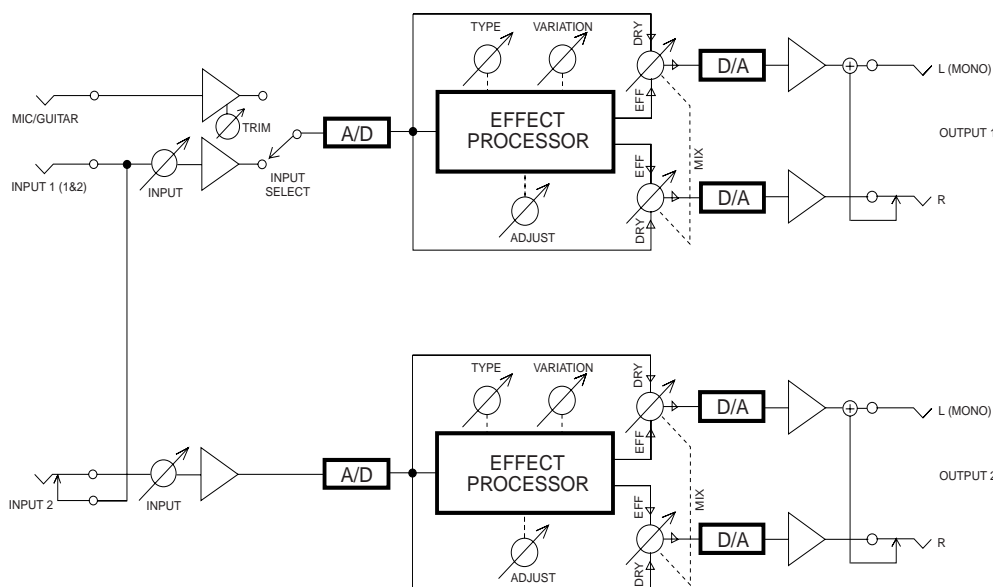

Single 1/2 Mode

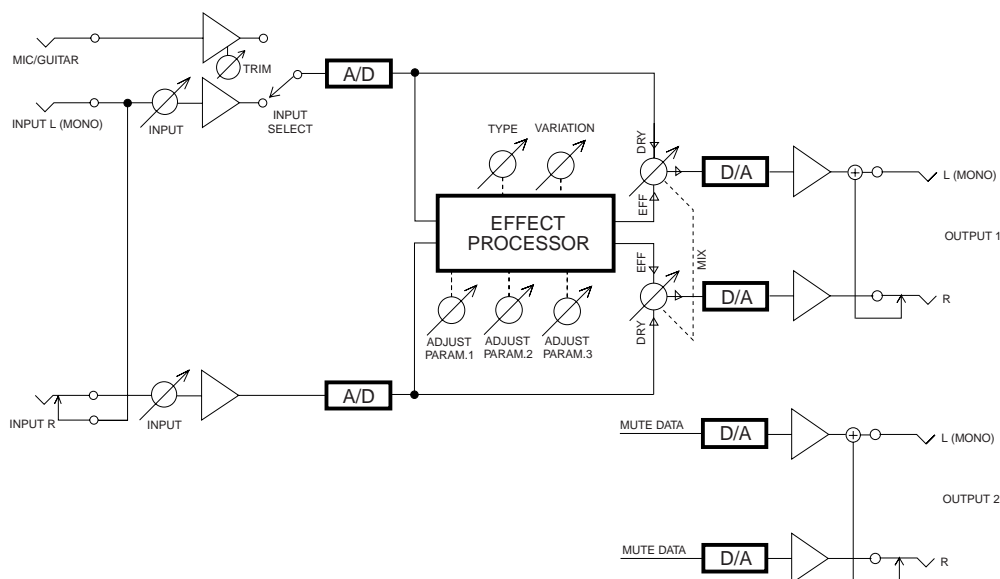

Declaration of EC Directive

This equipment is compatible with the EMC Directive (89/336/EEC) - Directive on approximation of member nation's ordinance concerning the electromagnetic compatibility and with the Low Voltage Directive (73/23/EEC) - Directive on approximation of member nation's ordinance concerning electric equipment designed to be used within the specified voltage range.

The Affect of Immunity on This Equipment

The affect of the European Specification EN61000-6-1 (coexistence of electromagnetic waves - common immunity specification) on this equipment are as shown below.

In the electrical fast transient/burst requirements, surge, conducted disturbances by radio-frequency fields, power frequency magnetic field, radiate electromagnetic field requirements and static electricity discharging environment, this could be affected by generation of noise in some cases.

FOSTEX DISTRIBUTORS LIST IN EUROPE * Including non-EU countries

<AUSTRIA>

NAME: ATEC Audio-u. Videogeraete VertriebsgesmbH.
ADD: Im Winkel 5, A-2325 Velm, Austria
TEL: (+43) 2234-74004, FAX: (+43) 2234-74074

<BELGIUM>

NAME: General Audio
ADD: Albert Temmerstraat 21, 1731 Zellik, Belgium
TEL: (+32) 2-4630650, FAX: (+32) 2-4661500

<DENMARK>

NAME: SC Sound ApS
ADD: Malervej 2, DK-2630 Taastrup, Denmark
TEL: (+45) 4399-8877, FAX: (+45) 4399-8077

<FINLAND>

NAME: Norettron Oy Audio
ADD: P. O. Box 22, FIN-02631 Espoo, Finland
TEL: (+358) 9-5259330, FAX: (+358) 9-52593352

<FRANCE>

NAME: Sennheiser France
ADD: 128 bis, avenue Jean-Jaures, 94851 Ivry-sur-Seine Cedex, France
TEL: (+33) 1 4987 0300, FAX: (+33) 1 4987 0324

<GERMANY>

NAME: Mega Audio GmbH
ADD: Stromberger Str. 32, D-55411 Bingen, Germany
TEL: (+49) 6721-94330, FAX: (+49) 6721-32046

<GREECE>

NAME: Bon Studio S. A.
ADD: 6 Zaimi Street, Exarchia, 106.83 Athens, Greece
TEL: (+30) 210-3809-605, 606, 607, 608
FAX: (+30) 210-3845-755, 210-3827-868

<ICELAND>

NAME: I. D. elrf. electronic Ltd.
ADD: ARMULA 38 108 REYKJAVIK, ICELAND
TEL: (+354) 588 5010, FAX: (+354) 588 5011

<ITALY>

NAME: Proel S. p. A.
ADD: Zona Via Alla Ruenia 37/43 64027 - Sant'Omero (Teramo), Italy
TEL: (+39) 0861-81241, FAX: (+39) 0861-887862

<THE NETHERLANDS>

NAME: IEMKE ROOS AUDIO B. V.
ADD: Kuiperbergweg 20, 1101 AG Amsterdam, The Netherlands
TEL: (+31) 20-697-2121, FAX: (+31) 20-697-4201

<NORWAY>

NAME: Fitzpatrick
ADD: P. B. 4316 Nydalen, 0402 Oslo, Norway
TEL: (+47) 23 400 380, FAX: (+47) 23 400 389

<PORTUGAL>

NAME: Caius - Tecnologias Audio e Musica, Lda.
ADD: Praca do Bom Sucesso, No 61 Bom Sucesso Trade Center, Escritorio 701/702, 4150-1460 Porto, Portugal
TEL: (+351) 22-608-06-10, FAX: (+351) 22-608-06-29

<SPAIN>

NAME: Letusa S. A.
ADD: C/Laguna 10, 28923 Alcorcon, Madrid, Spain
TEL: (+34) 91-4862800, FAX: (+34) 91-9414597

<SWEDEN>

NAME: TTS Scandinavia AB
ADD: Kavallerivagen 24, 172 48 Sundbyberg, Sweden
TEL: (+46) 8-59798000, FAX: (+46) 8-59798001

<SWITZERLAND>

NAME: Audio Bauer Pro AG
ADD: Bernerstrasse-Nord 182, CH-8064 Zurich, Switzerland
TEL: (+41) 1-4323230, FAX: (+41) 1-4326558

<UK>

NAME: SCV London
ADD: 40 Chigwell Lane, Oakwood Hill Industrial Estate, Loughton, Essex IG10 3NY U. K.
TEL: (+44) 20-8418-0778, FAX: (+44) 20-8418-0624

Free Manuals Download Website

<http://myh66.com>

<http://usermanuals.us>

<http://www.somanuals.com>

<http://www.4manuals.cc>

<http://www.manual-lib.com>

<http://www.404manual.com>

<http://www.luxmanual.com>

<http://aubethermostatmanual.com>

Golf course search by state

<http://golfingnear.com>

Email search by domain

<http://emailbydomain.com>

Auto manuals search

<http://auto.somanuals.com>

TV manuals search

<http://tv.somanuals.com>