

Owner's Manual

Model 380S

MULTITRACKER



Fostex®



CAUTION
RISK OF ELECTRIC SHOCK
DO NOT OPEN



**CAUTION: TO REDUCE THE RISK OF ELECTRIC SHOCK,
DO NOT REMOVE COVER (OR BACK).
NO USER-SERVICEABLE PARTS INSIDE.
REFER SERVICING TO QUALIFIED SERVICE PERSONNEL.**

CAUTION:

TO PREVENT ELECTRIC SHOCK, MATCH WIDE BLADE OF PLUG TO WIDE SLOT, FULLY INSERT.

ATTENTION:

POUR ÉVITER LES CHOCS ÉLECTRIQUES, INTRODUIRE LA LAME LA PLUS LARGE DE LA FICHE DANS LA BORNE CORRESPONDANTE DE LA PRISE ET POUSSER JUSQU'AU FOND.



The lightning flash with arrowhead symbol, within an equilateral triangle, is intended to alert the user to the presence of uninsulated "dangerous voltage" within the product's enclosure that may be of sufficient magnitude to constitute a risk of electric shock to persons.



The exclamation point within an equilateral triangle is intended to alert the user to the presence of important operating and maintenance (servicing) instructions in the literature accompanying the appliance.

"WARNING"

"TO REDUCE THE RISK OF FIRE OR ELECTRIC SHOCK, DO NOT EXPOSE THIS APPLIANCE TO RAIN OR MOISTURE."

SAFETY INSTRUCTIONS

1. Read Instructions – All the safety and operating instructions should be read before the appliance is operated.
2. Retain Instructions – The safety and operating instructions should be retained for future reference.
3. Heed Warnings – All warnings on the appliance and in the operating instructions should be adhered to.
4. Follow Instructions – All operating and use instructions should be followed.
5. Water and Moisture – The appliance should not be used near water – for example, near a bathtub, washbowl, kitchen sink, laundry tub, in a wet basement, or near a swimming pool, and the like.
6. Carts and Stands – The appliance should be used only with a cart or stand that is recommended by the manufacturer.



An appliance and cart combination should be moved with care. Quick stops, excessive force, and uneven surfaces may cause the appliance and cart combination to overturn.

7. Wall or Ceiling Mounting – The appliance should be mounted to a wall or ceiling only as recommended by the manufacturer.
8. Ventilation – The appliance should be situated so that its location or position does not interfere with its proper ventilation. For example, the appliance should not be situated on a bed, sofa, rug, or similar surface that may block the ventilation openings; or, placed in a built-in installation, such as a bookcase or cabinet that may impede the flow of air through the ventilation openings.

9. Heat – The appliance should be situated away from heat sources such as radiators, heat registers, stoves, or other appliances (including amplifiers) that produce heat.
10. Power Sources – The appliance should be connected to a power supply only of the type described in the operating instructions or as marked on the appliance.
11. Grounding or Polarization – The precautions that should be taken so that the grounding or polarization means of an appliance is not defeated.
12. Power Cord Protection – Power supply cords should be routed so that they are not likely to be walked on or pinched by items placed upon or against them, paying particular attention to cords at plugs, convenience receptacles, and the point where they exit from the appliance.
13. Cleaning – The appliance should be cleaned only as recommended by the manufacturer.
14. Nonuse Periods – The power cord of the appliance should be unplugged from the outlet when left unused for a long period of time.
15. Object and Liquid Entry – Care should be taken so that objects do not fall and liquids are not spilled into the enclosure through openings.
16. Damage Requiring Service – The appliance should be serviced by qualified service personnel when:
 - A. The power supply cord or the plug has been damaged; or
 - B. Objects have fallen, or liquid has been spilled into the appliance; or
 - C. The appliance has been exposed to rain; or
 - D. The appliance does not appear to operate normally or exhibits a marked change in performance; or
 - E. The appliance has been dropped, or the enclosure damaged.
17. Servicing – The user should not attempt to service the appliance beyond that described in the operating instructions. All other servicing should be referred to qualified service personnel.

Thank you very much

Thank you very much for purchasing the FOSTEX MODEL 380S.

The MODEL 380S is a multi-track, multi-function, mixing console that boasts 12 inputs (four microphone/line inputs and eight line inputs) combined with a high-performance four-track cassette recorder. The MODEL 380S also incorporates a double-speed tape capability and Dolby S noise reduction, ensuring excellent sound quality.

The MODEL 380S is very easy to use, thanks to several elegantly-designed features. The machine features a zero-return function, a variety of locate functions that can memorize and access two points on your tape, and an auto punch-in/out function that also operates in rehearsal mode. You can also perform multi-track recording (like a one-person quartet!), utilizing simultaneous four-channel recording and overdubbing. The MODEL 380S allows you to realize highly-integrated sound production quality over a broad range of studio techniques, including ping-pong recording, an advanced auxiliary signal routing system that utilizes two-way AUX/Insert connectors, and tape sync mixdown using various MIDI devices.

Read this manual thoroughly before you start operating the unit. Follow the steps for proper operation described here to maximize the capabilities of the MODEL 380S, and to provide you years of enjoyment as you meet the challenges of creating your own unique audio masterpieces.

Features of MODEL 380S

- 8 channel, 12 input mixing console with integrated functions
- Built-in SUB mix section (Mixdown input from up to 12 sound sources while playing back tracks 1-4)
- Auto locate and auto punch-in/out functions useful for editing
- Dolby S noise reduction
- Complete Effect Send/Return functions (Two AUX and Insert connectors)
- Large display screen shows operation status clearly
- IN/OUT connectors dedicated for tape sync (Allowing for synchronous playing with various MIDI devices)

Precautions

Before connecting and disconnecting the cables:

Be sure to turn all volume controls and faders of any connected devices to "0", before you connect or disconnect the cables to the input/output connectors on the unit.

Note:

Always grasp the plug part of the power cable when you unplug it from the AC outlet. Do not pull on the cable or you may short circuit the connection.

Warning:

- ① Do not pull on or unplug the power cable to the AC outlet while your hands are wet; otherwise you could suffer electrical shock.
- ② Do not use a worn or frayed power cable. Worn cables can result in electric shock or fire. Handle the power supply cable very carefully.
- ③ Do not remove the case cover. Touching the inside of the unit with your hand is very dangerous. It can result in electric shock or malfunction of the cassette recorder.
- ④ Do not allow liquids, flammable materials, or metal objects such as pins or paper clips to enter the unit; electric shock or malfunction can result.

Before operating the MODEL 380S

● Recording Format

Standard cassette recorders record up to two tracks at a time; two in one direction (Side A) and two in the opposite direction (Side B).

As shown in the diagram below, the multitrack format allows recording of up to four tracks in the same direction.

Standard Cassette Deck

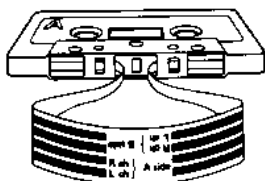

Model 380S

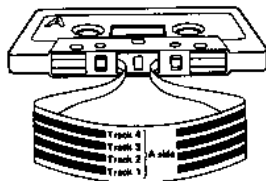

● Write-protect tab

To avoid accidental erasure of recorded material, break off the cassette's write-protect tabs for Sides A and B.

● Recommended cassette tapes

The MODEL 380S has been designed to perform best using a high bias cassette tape (CrO₂, TYPE II). We recommend MAXELL XLII, TDK SA, or the equivalent in durations under 120 minutes. The multiple passes and playbacks of multi-track recording place torturous demands on a tape. Tapes of 120 minutes (C-120) are very thin and less durable than shorter tapes. They are not recommended for this unit.

● Avoid using the unit under the following conditions:

1. Under extremely high, low, or rapidly-changing temperatures
2. Too much dust or high humidity
3. Variation in the power supply voltage (power surges)
4. Strong magnetic fields
5. Substantial vibration

● Cleaning

Use a soft cloth such as a silicon cloth to clean the unit. Wipe heavier dirt with a cloth soaked in a neutral detergent diluted with water. Never use solvents such as thinner or benzene. These can cause coated surfaces and acrylics to melt and display characters to be erased.

● Copyright

You cannot use a recording from an FM broadcast or a compact disc without permission of the copyright owners, except for use as personal entertainment.

Table of Contents

■ Precautions	2
■ Before operating the MODEL 380S	3
Chapter 1: The Basics	4
Chapter 2: Part names and functions	8
Chapter 3: The Locate function	11
◆ What is the Locate function?	11
◆ Keys and indicators for the Locate function	12
◆ Registering Locate points	14
◆ Auto Stop function	15
◆ Auto Play function	15
◆ Auto Repeat function	16
◆ Auto Play & Repeat function	16
Chapter 4: Punch-in/out	17
◆ What is Punch-in/out?	17
◆ How to Manual Punch-in/out	17
◆ How to Auto Punch-in/out	18
◆ Advanced Auto Punch-in/out	20
Chapter 5: Basic operations	22
◆ Direct recording	22
◆ Multi-track recording using overdubbing	22
● STEP1: Recording the drum machine on Track 1	22
● STEP2: Overdubbing the electric bass on Track 2	24
● STEP3-1: Overdubbing (Electric guitar · Track 3)	26
● STEP3-2: Overdubbing (Synthesizer · Track 4)	27
● STEP4: Mixdown	28
◆ Four-channel simultaneous recording	32
Chapter 6: Advanced applications	34
◆ Example 1: 12-input (8 MIDI sound sources) simultaneous stereo recording	34
◆ Example 2: Overdubbing using stereo bus	36
◆ Example 3: Ping-pong recording	38
Chapter 7: Tape sync	40
■ Troubleshooting	42
■ Maintenance	43
■ ON DOLBY S NR	43
■ Specifications	44
■ Block Diagram	45
■ Accessories	46

Chapter 1: The Basics

(To utilize 100% of the MODEL 380S functions.)

This manual includes several technical terms from the world of multi-track recording. To understand the terms used in this manual, read this chapter thoroughly.

Understanding Signal Flow

(Some of the sounds you hear when you monitor the MODEL 380S are being recorded to tape, while others are not.)

① Signal in the bus

The principles of multitrack recording are fairly simple. Once you understand the signal flow of a sound from its source, through a multitrack recorder, to your headphones, the rest of the concepts will be easier to understand. In this manual, all sounds input from musical instruments, as well as all playback sounds, are referred to as "signals". The signal flow is divided into two basic categories: stereo bus and mon-mix bus. (Signal flow to the AUX bus is explained in the AUX section.) In the recording field, the word 'bus' means "a circuit commonly used to send multiple signals to multiple devices." Here in this manual, you can regard it as "the bus which takes various signals (such as the sound of the connected musical instruments and tape playback sound) to their respective destinations, such as the recorder section, the headphone connectors, or the AUX Send connectors.

② Signal traffic control

Signals to be recorded on tape are routed to the stereo bus, and signals not to be recorded are routed to the mon-mix bus. You can select the monitor signal (the signal you listen to through headphones) from the following options using the

- * Stereo bus signal
 - * Stereo bus signal and mon-mix bus signal
 - * Mon-mix bus signal
-]— MONITOR selector¹⁵

Why do we need to simultaneously monitor both the sounds to be recorded and those not to be recorded? Because multi-track recording has always relied on a technique called "overdubbing". Overdubbing is a method of recording new material on the current track while monitoring sounds already recorded on other tracks. During overdubs, "traffic control" of the signals is required to prevent recorded sounds on other tracks from being recorded on the current track by mistake. If the signal flow is well organized, you can perform overdubbing or ping-pong recording from any channel to any other channel very easily. To realize this, it is important to understand the concepts of a stereo bus and a mon-mix bus. First of all, however, you need to understand the difference between a track and a channel.

The difference between a track and a channel

"Track" and "channel" are sometimes used as if they mean the same thing. However, this manual uses these words differently:

- **Channel:** Used for the input/output system of the mixing section. For example, the following expression is used: "Output the electric bass connected to Channel 1 from L channel."
- **Track:** Used for the input/output system of the recorder (tape) section. For example, the following expression is used: "Perform ping-pong recording of playback sound from Tracks 1, 2, and 3 onto Track 4."

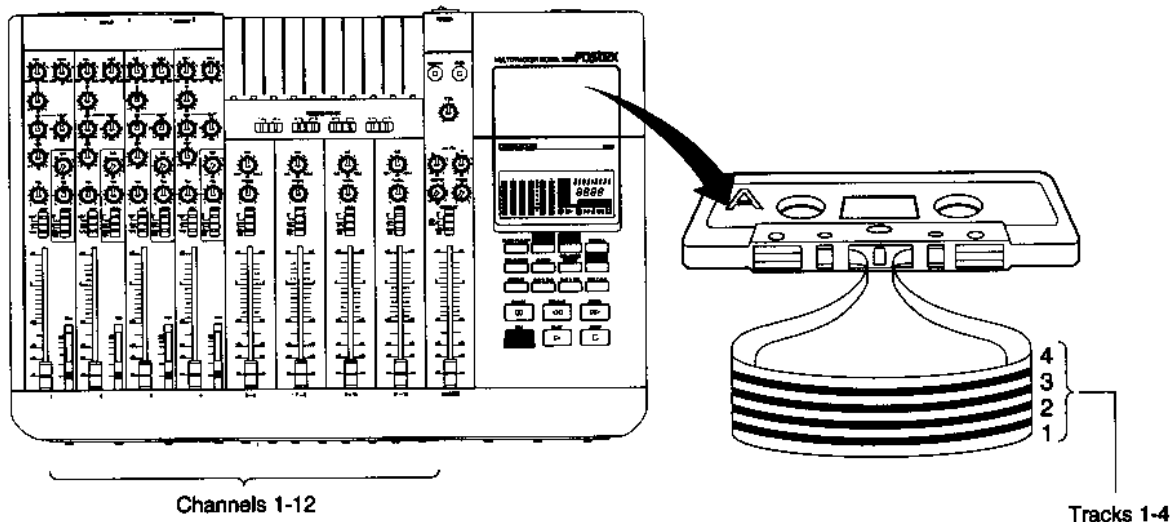

Input monitor and Tape monitor

“Monitoring (listening to) the recorder output” means the following two things:

- **Tape monitor:** Track outputs from the recorder are wired to successive channel inputs. Thus Track 1 to Channel 1, Track 2 to Channel 2, etc.
- **Input monitor:** Whatever signal source is connected to the respective INPUT jack—microphone, musical instrument, etc.—will be active.

For example, “Switching Channel 1 to Tape monitor” means “setting the monitor so that you can listen to the sound being recorded on Track 1”. “Switching Channel 2 to Input monitor” means “setting the monitor so that you can listen to the sound being sent to Track 2 (R channel of the stereo bus).”

You can select the monitor setting for individual channels.

(See the Transport Control section, ⑩: Part name and function on page 9.)

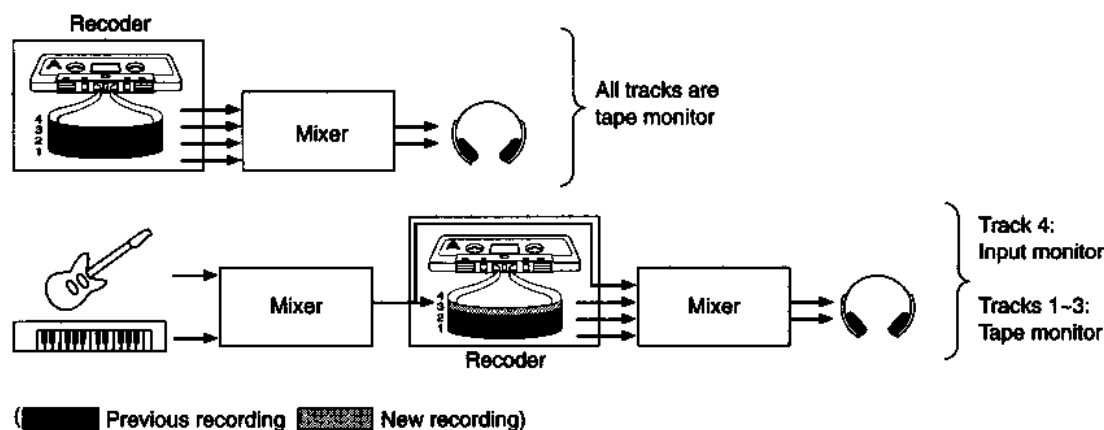

PAN: A turning signal indicator for the stereo bus

The Model 380S has a 12-input mixing function that allows you to mix and record up to 12 sound sources simultaneously. (See the figure on the next page.) The stereo bus corresponds to the two thick signal pathways drawn in the figure. Various signals that have already passed via the PAN settings are collected and summed through these pathways. The master faders determine the final level of these signals, which are then output from the STEREO OUT jack ④. PAN, which is short for panorama, determines the placement of a signal within the stereo bus, effectively enabling you to place your various band members throughout the stereo field.

Recording signal to be routed to stereo bus

Output from the stereo bus is also transmitted to the recorder section. As seen in the figure, L output is routed to Tracks 1 and 3, and R output is routed to Tracks 2 and 4. For example, you can route all signals from Channels 1-12 that are routed to L channel of the stereo bus onto Track 1. You can record the sound of the instrument once the audio signal input to any channel has passed through the pipe called the stereo bus. However, direct recording is an exception. In direct recording, the signal on Channel 1 is recorded on Track 1, and the signal on Channel 2 is recorded on Track 2. In this way, the destination of the signal is assigned. (See “Direct recording” on page 22.)

Non-recording signal to be routed to monmix bus

The monmix bus is just as important a pipe as the stereo bus. MONMIX is an abbreviation for “MONITOR MIX.” Unlike the stereo bus, any combination of audio signals that are not recorded (but can be monitored) are sent to the monmix bus. These signals are output from the PHONES jack ⑤ and MON OUT jack ⑥.

To which bus should the signal be routed? The role of the ASSIGN switch

The assign switch ② assigns signals to the stereo and monmix buses.

(See “ASSIGN ②: Part name and function” on page 8.)

One signal cannot be assigned to both buses. A rule of thumb is “Recording signal to be routed to stereo bus, non-recording signal to be routed to monmix bus.”

Monitoring: Confirming the signal in the bus

As you might understand from the above descriptions, monitoring is an operation that checks the type of signal in the stereo and monmix buses.

By the way, we have already explained that there are three options for signals you can monitor. Look at the control panel figure on page 7.

- MON SELECT**
- ST = Stereo bus signal
 - MONMIX+ST = Stereo bus and monmix bus signals
 - MONMIX = Monmix bus signal

"When you want to overdub the bass sound connected to Channel 2 on Track 2, while listening to the drum sound already recorded on Track1."

According to our rule of thumb, send the bass sound to the stereo bus, and the drum sound to the monmix bus. Use the ASSIGN ② of each channel to assign the signal, as explained above.

- ST = You can monitor only the bass sound.
- MONMIX+ST = You can monitor the drum sound and the bass sound.
- MONMIX = You can monitor only the Drum sound.

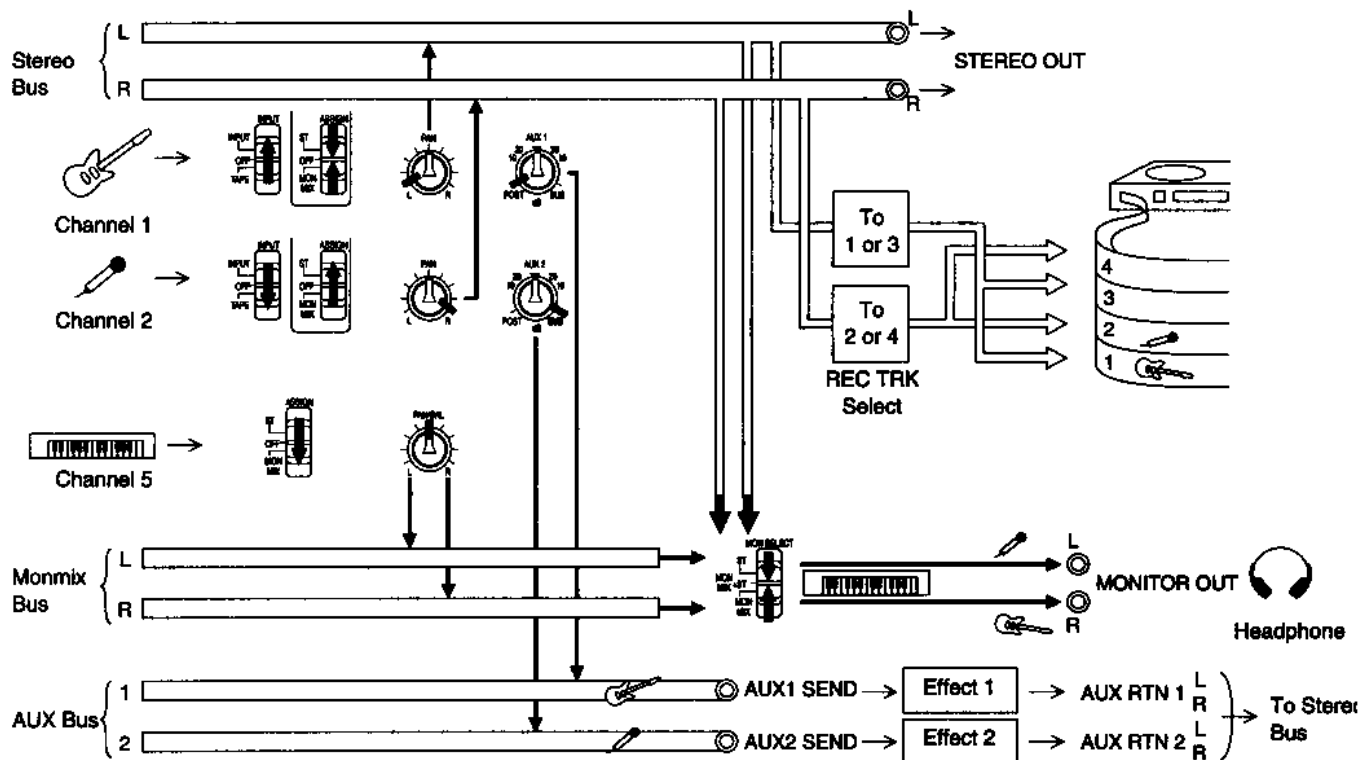

An additional bus: the AUX bus

AUX is an abbreviation for "auxiliary" which means "supplementary". The AUX bus plays a role different than the stereo and monmix buses (through which the input signal generally passes). The AUX bus is a supplemental bus.

With the MODEL 380S, two "AUX Send controls" equip each of Channels 1-4, and AUX collectively cover Channels 5-12. Turning the controls clockwise/counterclockwise will assign the signal to two AUX buses. Signals in these two AUX buses are routed through the AUX1 SEND jack ② and AUX2 SEND jack ③ to the external effect unit for processing (mainly the application of reverb). The wet (processed) signal from the external effect unit is input at the AUX1 RTN jack ④ and AUX2 RTN jack ⑤, and sent to the stereo bus.

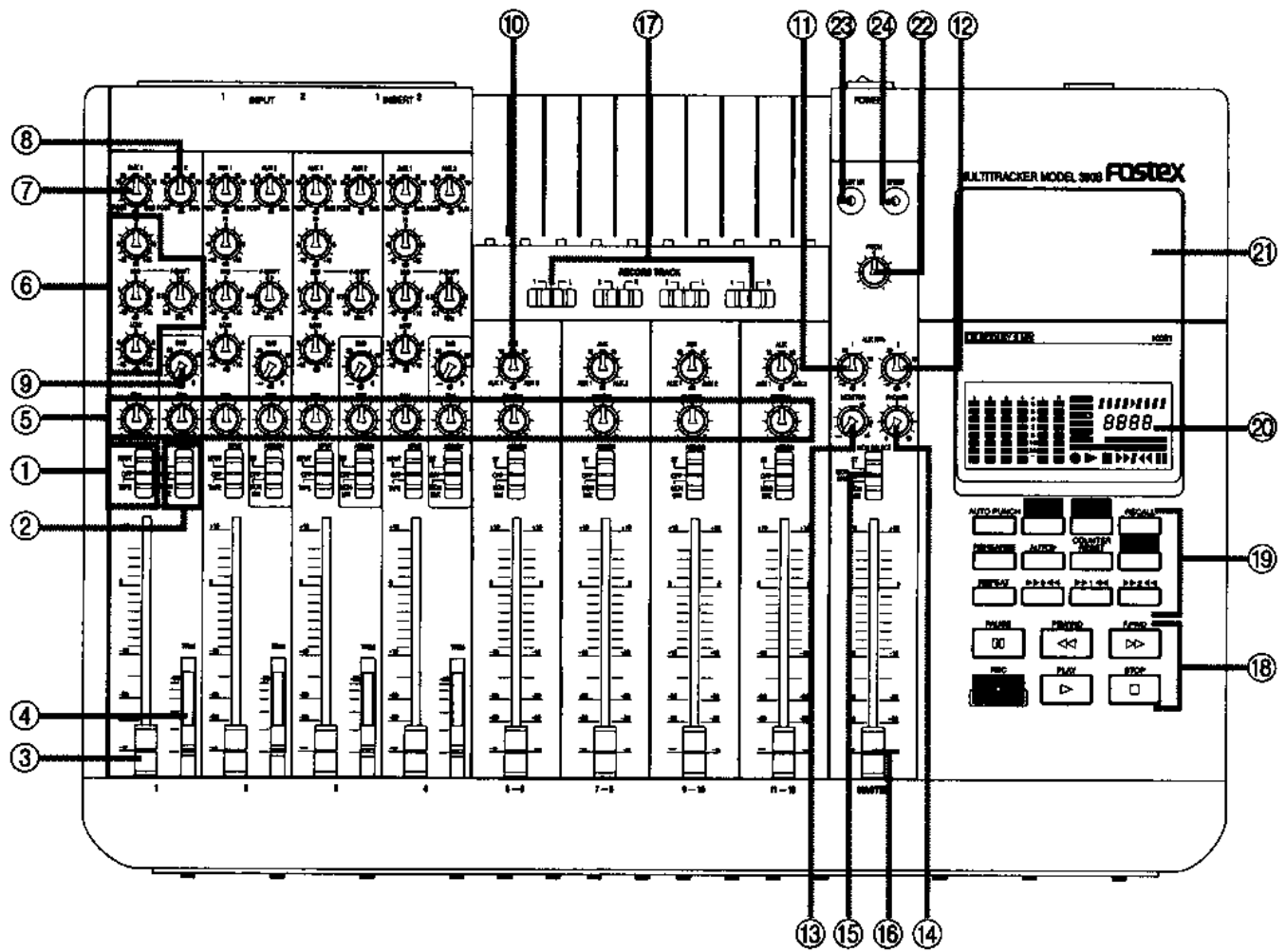

Control Panel

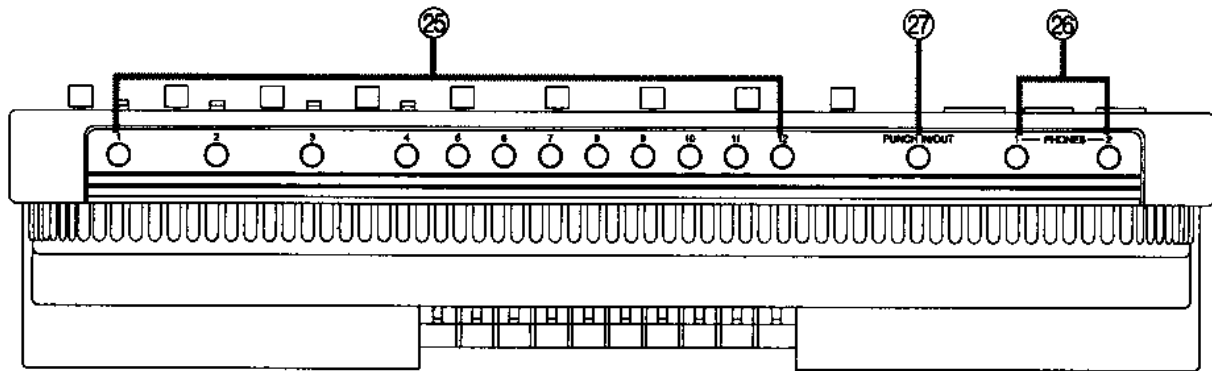

Front Panel

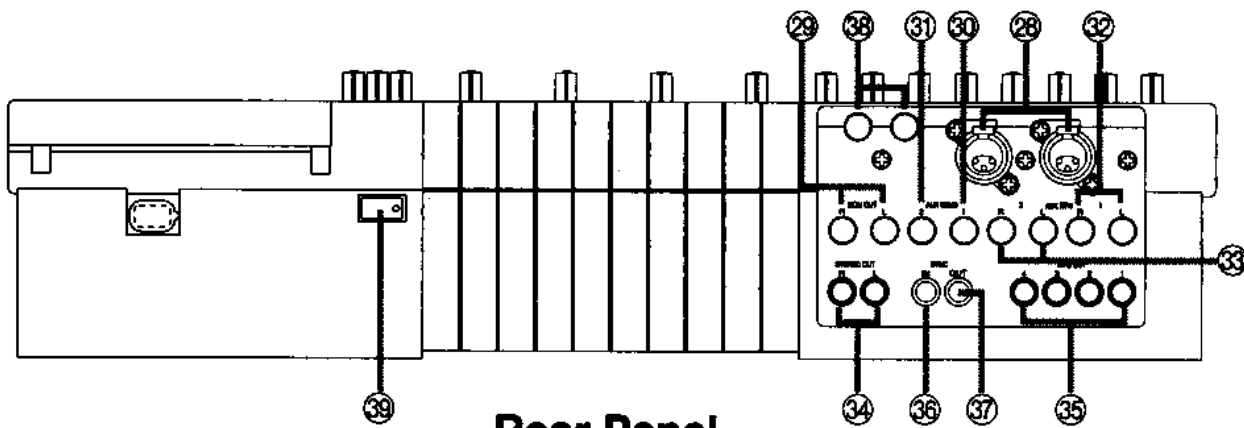

Rear Panel

Chapter 2: Part names and functions

(Numbers in brackets) are the numbers used in this manual.

Control Panel section

① Input Selector Switch [INPUT Selector①]

Input fader and SUB Mix section

In order to enjoy playback with an effective use of MIDI sync, you can choose the destination of the input signals for Channels 1-4 and the tape playback signals. This selection is made with the INPUT Selector①. The use of this selector switch is explained later, in the chapter on basic operation. For a moment, however, focus on understanding the signal flow.

INPUT: Sends the input signal of the same Channel to the INPUT Fader③, and the tape playback signal to the SUB Mix section.

OFF: Input signal is not sent anywhere. If you do not use certain channel(s), set this switch to OFF so that no signal sneaks into the channel.

TAPE: Sends the input signal of the same Channel to the SUB Mix section, and the tape playback signal to the INPUT fader③.

Example: Channel 1

	Input signal	Tape playback signal
INPUT	INPUT fader 1	SUB Mix section 1
OFF	Signal is not sent.	Signal is not sent.
TAPE	SUB Mix section 1	INPUT fader 1

② Assign Switch [ASSIGN②]

Selects the destination of the signal from the SUB Mix section and Inputs 5-12.

ST: Routed to the stereo bus. (See "Glossary" on page 4.)

OFF: Signal is not sent anywhere.

MONMIX: Routed to the monmix bus.

(See "The Basics" on page 4.)

③ Input Fader [INPUT fader③]

Adjusts the volume level of Inputs 1-12.

④ Input Trim [TRIM④]

Adjusts the level according to the output level of the external devices connected to INPUT jacks 1-4②. Raise the level to -60(dBV) when low output devices, such as a microphone, are connected. Lower the level to -10(dBV) when high output devices, such as electronic musical instruments, are connected.

TRIM is applied to the signal input at the INPUT jack② on the front panel, and at the XLR INPUT connector② on the rear panel. When the ASSIGN② switch is set to "INPUT", the TRIM affects the INPUT Fader③; when the ASSIGN② is set to "TAPE", it affects the SUB Mix section.

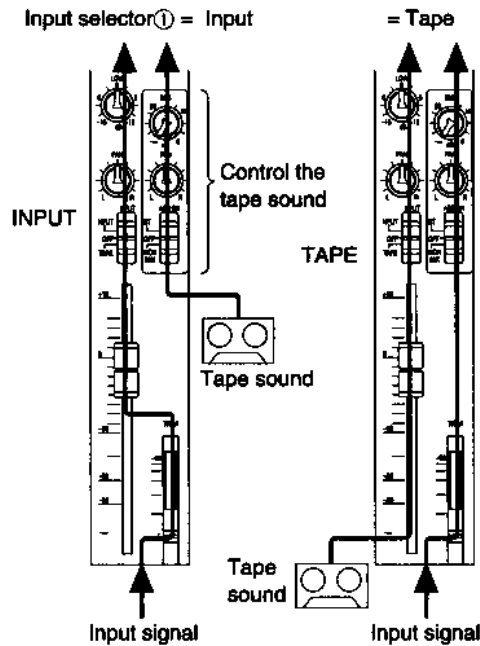

⑤ Pan pot [PAN⑤]

Adjust the stereo image of the Channel signal when it is sent to the stereo bus or MONMIX bus.

⑥ Equalizer [EQ⑥]

Adjusts tonal color of Channels 1-4 input signals. It boosts/cuts the following frequency bands in the range of +/-15dB.

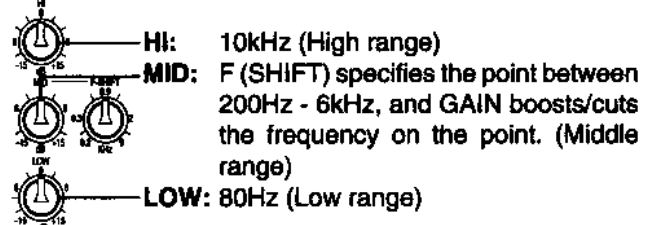

⑦ AUX1 Send control [AUX1⑦]

Mainly used to apply an effect to Channels 1-4 input signals. Rotating this control counterclockwise will output the signal from the INPUT fader③, and rotating it clockwise will output the signal that has been adjusted by the SUB⑨. In either case, the signal is sent to the AUX1 SEND jack⑩.

⑧ AUX2 Send control [AUX2⑧]

Same operation as AUX1⑦. Channels 1-4 input signals are output at the AUX2 SEND jack⑩. Use this control when you want to use a second effect unit.

⑨ SUB Mix volume control [SUB⑨]

Adjusts the volume level of the SUB Mix section input signal and sends it to the stereo bus or MONMIX bus. The volume level of signals routed to AUX1⑦ and AUX2⑧ are adjusted here.

⑩ AUX1&2 Send control [AUX1&2⑩]

Mainly used to apply effects to Channels 5-12 input signals. Once a signal passes through the INPUT fader③ of Channels 5-12, it meets the AUX1&2 Send control. Turning this control counterclockwise routes the signal to the AUX1 SEND jack⑩; turning it clockwise routes the signal to AUX2 SEND jack⑩.

11 AUX1 RTN control [AUX RTN1 11]

A signal that arrives at the AUX1 RTN jack 22 (usually the output from an effect unit) is adjusted by this control and sent to the stereo bus.

12 AUX2 RTN control [AUX RTN2 12]

As with AUX1 RTN 11, a signal that arrives at the AUX2 RTN jack 23 (usually the output from an effect unit) is adjusted by this control and sent to the stereo bus.

13 Monitor Level control [MONITOR level 13]

Adjusts the signal level output from the MON OUT jack 24.

14 Headphone Level control [PHONES level 14]

Adjusts the volume level of the headphones connected to the PHONES jack 25.

15 Monitor Select Switch [MONITOR Selector 15]

Selects the signal to be sent to the MON OUT jack 24 and the PHONES jack 25 for monitoring.

ST: Selects the stereo bus output signal (the signal output from the STEREO OUT jack 34).

(See "The Basics" on page 4.)

MONMIX+ST: Selects the signal mixed from the stereo bus and MONMIX bus.

MONMIX: Selects the signal of the MONMIX bus.

16 Stereo Master Fader [MASTER fader 16]

This stereo bus master fader adjusts the overall level of all signals sent to the stereo bus from PAN 5, AUX RTN1 11, and AUX RTN2 12. The signal adjusted here is output from the STEREO OUT jack 34.

17 REC Select Switch [REC SELECT 17]

Selects a track for recording. The option "•" located in the middle is OFF. When this option is selected, signal will not be recorded on the selected track.

In Direct recording: Selects Channels 1-4.

(See "Direct recording" on page 22.)

In other recording applications: Selects (L, R) if the signal output from the stereo bus L, R is received. Output signal from stereo bus L can be recorded on Tracks 1 and 3, and output signal from stereo bus R can be recorded on Tracks 2 and 4.

Example: Track 1



Audio on Channel 1 will be recorded directly.



Audio on stereo bus L will be recorded on Track 1.

18 Transport Control section**PAUSE button**

Press to pause recording/playback. When you pause recording/playback, the indicator ■■ on the display is lit. To cancel pause, press this button again or press the PLAY button.

REWIND button

Rewinds the tape.

F.FWD button

Transports the tape fast forward.

RECORD button

Pressing this button and the PLAY button simultaneously—when the REC SELECT 17 is switched to ON (record stand-by mode)—starts recording.

(● and ► will be lit.) Pressing only the RECORD button will switch the record stand-by track to input monitor, and ● will blink.

To cancel the input monitor, press this button again.

PLAY button

Press this button to play back a tape.

Press this button together with the RECORD button to start recording.

Press this button after pausing playback/recording to cancel pause. To punch in, press this button together with the RECORD button. To punch out, press this button together with the STOP button.

STOP button

Stops the tape transport.

Press this button and the PLAY button simultaneously to punch out. (See "Punch-in/out" on page 17.)

19 Memory/Auto Function section

In this section you can register location memory, execute the locate operation, and set the parameters for Auto Repeat and Auto Punch-in/out. For details see "The Locate Function" on page 11 and "The Auto Punch-in/out Function" on page 18.

20 Operation Display [DISPLAY 20]

This display provides you with all necessary information, such as various signal output levels and the operational status of the unit.

The status of the indicators changes according to the operations in the Memory/Auto Function section and Transport Control section 18. Details will be explained in the following chapters "The Locate Function" and "The Auto Punch-in/out Function".

21 Cassette Deck Transport [Transport 21]

Load your cassette tape here.

Note: Make sure the cassette is inserted correctly before operating.

22 Pitch Control [PITCH 22]

Changes the tape speed within the range of $\pm 10\%$.

23 Dolby S Noise Reduction Switch [DOLBY NR 23]

Usually set this switch to ON for recording/playback with less noise.

You cannot use the Dolby function if the tape speed is normal (4.75cm/s).

This switch is a non-locking type. Check the switch setting (ON/OFF) on the display.

24 Tape Speed Select Switch [SPEED H/N 24]

Selects a high tape speed of 9.5(cm/s) or a normal speed of 4.75(cm/s).

When the power is turned on to the MODEL 380S, the high speed is selected automatically. This switch is also a non-locking type. Check the tape speed on the display.

Front Panel

② Input jacks 1-12 [INPUT jack②]

Channels 1-4: To these jacks, you can connect both instruments with low output levels (microphones, acoustic instruments) and high output instruments (electronic musical instruments). You can also apply effects to Channel 1-2 input signal independently.

(See **INSERT jack⑳**.)

Channels 5-12: Connect high output devices, such as electronic musical instruments.

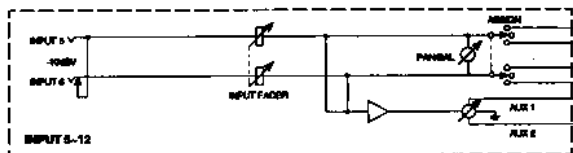

Notes for connection of mono output devices

If you connect mono output devices to Channel 5, 7, 9, or 11, the signal will be output from L and R and you can adjust the stereo image using **PAN**. If you connect the mono output devices to Channels 6, 8, 10, or 12, the signal will be output from only L.

④ Headphones jack [PHONES jack④]

Headphone can be connected to this jack. You can adjust the volume level of the headphones using the **PHONES level**⑭.

⑦ Remote Punch-in/out Jack [PUNCH IN/OUT jack⑦]

Connect the optional FOSTEX 8051 foot switch here to punch in and out.

Rear Panel

① XLR Input connector [XLR INPUT connector①]

Used to connect microphones with a balanced XLR type connector to Channels 1-2. However, if you have already connected devices to the INPUT jacks② 1-2 on the front panel, you cannot use the XLR input connector.

③ Monitor Out Jack [MON OUT Jack③]

Outputs the signal selected by the **MONITOR selector**⑮ (the same signal output from the headphones). These are usually used to connect to the monitor amplifiers and speakers.

⑧ AUX1 Send Jack [AUX1 SEND Jack⑧]

Outputs the AUX1⑦ mix signals of Channels 1-4 and the AUX1 mix signals sent from the AUX1 & 2⑩ of Channels 5-12.

⑨ AUX2 Send Jack [AUX2 SEND Jack⑨]

Outputs the AUX2⑧ mix signals of Channels 1-4 and the AUX2 mix signals sent from the AUX1 & 2⑩ of Channels 5-12.

⑫ AUX1 Return Jack [AUX1 RTN Jack⑫]

⑬ AUX2 Return Jack [AUX2 RTN Jack⑬]

The MODEL 380S has two AUX RTN jacks. Both of them allow for stereo input and are usually used to connect the output signals from two effect units. You can also use these as auxiliary input channels. Thus you can connect up to 16 sound sources for recording from the stereo bus.

When the plug is connected only to L: The signal will be sent to both stereo bus L and R.

When the plug is connected to both L and R (when using a stereo-out type effect unit): L signal is sent to stereo bus L, and R signal is sent to stereo bus R.

When the plug is connected only to R: The signal will be sent to stereo bus R.

The signal routed here will be adjusted for volume level by means of **AUX RTN1**⑪ and **AUX RTN2**⑬, and sent to the stereo bus.

⑭ Stereo Out Jack [STEREO OUT Jack⑭]

The signal from the stereo bus is output here. Usually, this is used to send the signal to the master recorder for mix down.

⑮ Tape Out Jack [TAPE OUT Jack⑮]

Output signal from Tracks 1-4 appears here. Usually, this is used to send the signal to an external mixing console for effect processing.

⑯ Sync In Jack [SYNC IN Jack⑯]

Sync signal from the external sequencer is input here and routed to Track 4.

⑰ Sync Out Jack [SYNC OUT Jack⑰]

Outputs the sync signal recorded on Track 4 to an external sequencer. (This is used in combination with the **SYNC IN jack**⑯).

⑱ Insert Jack [INSERT Jack⑱]

This jack is used for individual effect processing on Channels 1-2.

It is especially useful when acoustic musical instruments or microphones are connected to Channels 1-2, or when you wish to apply effects such as a compressor or aural exciter.

⑲ Power switch ON/OFF Switch.

Chapter 3: The Locate function

What is the Locate function?

The MODEL 380S has a Locate function that is very useful for the rehearsal of recording and mixdown. The locate function uses the keys in the Memory/Auto Function section[Ⓢ] (called Memory section[Ⓢ] for convenience), and the Transport Control section[Ⓢ]. You can check in real time whether or not the Locate function is in use by viewing the indicator's ON/OFF status on the operation display[Ⓢ].

● Three locate points and four types of locate functions

You can use four types of locate functions by registering and combining three locate points.

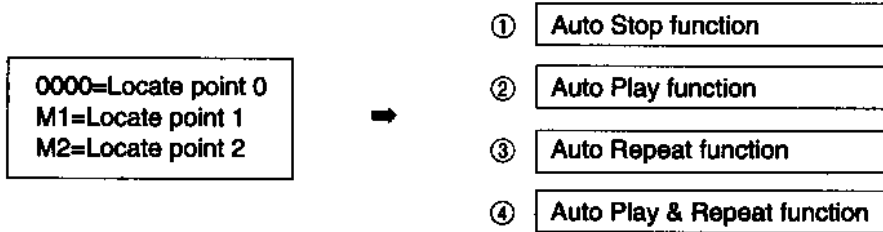

● Auto Repeat function useful for rehearsal

Example: Assume that you are recording a guitar solo in a particular piece of music. The guitar solo covers 18 bars, from Bar 37 to Bar 55. You might want to repeatedly rehearse this part until you are satisfied. In this case, the Auto Repeat function is very useful.

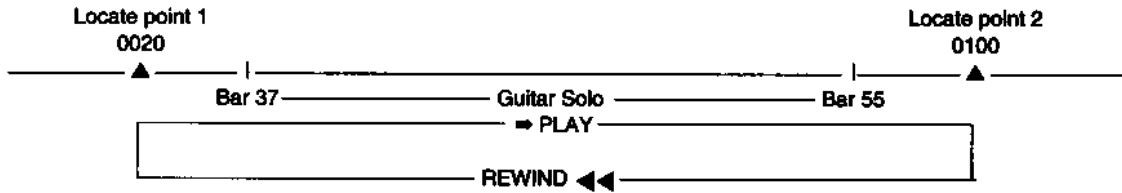

Specify Locate point 1 at a point slightly before the top of Bar 37; specify Locate point 2 at a point slightly after the end of Bar 55.

The Auto Repeat function will automatically repeat the specified part (0020 ► 0100).

Keys and indicators for the Locate function

● Name and description of the Memory/Auto Function section keys

The Memory section ⑨ has 12 control keys in total. The function of each key will be explained in the section on operating the Locate function. The following table contains the names and the description used in this manual.

Description on the panel	Key name	Description in this manual
*	Auto Punch-in/out key	AUTO PUNCH
*	Memory1 key	MEMO1/P.IN
	Punch-in key	MEMO1/P.IN
*	Memory2 key	MEMO2/P.OUT
	Punch-out key	MEMO2/P.OUT
**	Recall key	RECALL
	Rehearsal key	REHEARSE
	Auto Play key	AUTO▶
	Counter Reset key	COUNTER RESET
	Memory Reset key	MEMORY RESET
	Repeat key	REPEAT
	Locate0 key	▶▶0◀◀
	Locate1 key	▶▶1◀◀
	Locate2 key	▶▶2◀◀

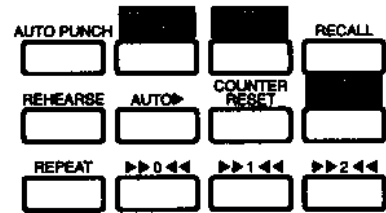

- * Each of these keys has two functions.
 - [1] For the Locate function, they register or cancel Memory point 1 and 2.
 - [2] For the Auto Punch-in/out function, they register and cancel punch-in/out points.
- ** **Recall key:** When you press this key, the display alternately shows the status of locate point memory and punch-in/out point memory.

● Name and function of the indicators on the operation display

The names in brackets [] are used in this manual.

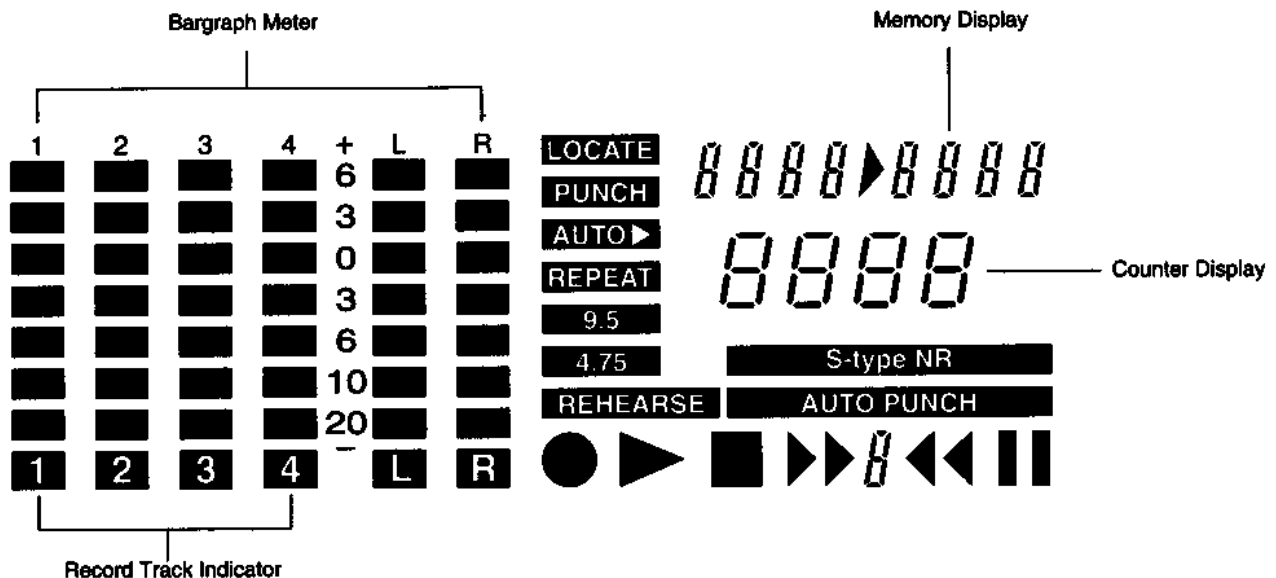

Expression used in this manual:

Example: "Press **REHEARSE** to turn **REHEARSE ON**."

In this manual, "Turn ON" refers to the operation that turns a particular indicator on (lit). "Turn OFF" stands for the operation that turns a particular indicator off.

- **Bargraph Meter [Level Meter]**
 - **Track level 1-4:** Shows the output signal level sent to each Track, or the playback level of each track.
 - **Stereo bus L. R:** Shows the stereo bus output signal level.
- **Record Track Indicator [RETRACK 1 2 3 4]**
Shows the status of each track (1-4)
Blink = Recording stand-by mode
Lit = Recording in progress
- **Locate Indicator [LOCATE]**
Lit when you press [RECALL] and select the Locate function.
- **Punch-in/out Indicator [PUNCH]**
Lit when you press [RECALL] and select Punch-in/out mode.
- **Auto Play Indicator [AUTO▶]**
Press [AUTO▶] to turn AUTO ON when you want to use the Auto Play function.
- **Repeat Indicator [REPEAT]**
Press [REPEAT] to turn REPEAT ON when you want to use Auto Repeat function.
The indicator is lit only when Locate points 1 and 2 have already been registered.
- **Tape Speed Indicator [9.5, 4.75]**
Press SPEEDⓈ on the control panel and select the tape speed.
When [9.5] is ON, high speed is selected.
When [4.75] is ON, normal speed is selected.
* When power is turned on to the MODEL 380S, high speed (9.5) is automatically selected.
- **Rehearsal Indicator [REHEARSE]**
Lit when you press [REHEARSE] and the unit enters Rehearsal mode.
Starting recording or punch-in/out recording in Rehearsal mode will set the track to Input Monitor, and no signal will be recorded.
- **Memory Display [Memory Display]**
Displays locate points and punch-in/out points.

	In Locate function mode	In Punch-in/out mode
Left	Locate point 1	Punch-in point
Right	Locate point 2	Punch-out point

- **Counter Display [Counter Display]**
Shows the current position on the tape (tape counter).
Press [COUNTER RESET] to reset the counter to [0000].
- **Dolby S Noise Reduction ON/OFF Indicator [S-type NR]**
Lit when you press DOLBY NRⓈ to turn Dolby NR ON.
* When the power is turned on, this is set to ON.
* You cannot turn this indicator ON when normal tape speed is selected.
- **Auto Punch-in/out Indicator [AUTO PUNCH]**
Lit when you press [AUTO PUNCH] for Auto Punch-in/out.
* The indicator is not turned ON unless punch-in/out points are registered.

(Transport Indicators)

The following shows the status of each button in the Transport Control section ⑩.

- Recording Indicator [REC ●]
Blink = Input Monitor
Lit = Recording
- Play Indicator [PLAY ▶]
- Stop Indicator [STOP ■]
- Fast Forward Indicator [F.FWD ▶▶]
- Rewind Indicator [REWIND ◀◀]
- Pause Indicator [⏸]
- **Locate Point Indicator [▶▶ ◀◀]**
Pressing these buttons causes the unit to locate to the position in memory.

Registering Locate points

The locate function utilizes three locate points. You do not have to register Locate point 0. Locate point 0 corresponds to the point expressed by [0000] on the Counter Display. In this section, we will explain how to register Locate points 1 and 2.

Example: Registering Locate point 1 to [0020], and Locate point 2 to [0100]

- [1] Prepare for registering the locate points as follows.
Press **RECALL** to turn **LOCATE ON**.
If **PUNCH** is ON, auto punch-in/out points will be registered. Check the indicator status carefully.
- [2] In order to locate the point you wish to register as Locate point 1, advance (or rewind) the tape until the Counter Display shows [0020].
- [3] Press **MEMO1/P.IN** to register Locate point 1.
The Memory Display will show [0020 ▶ - - - -].
- [4] In order to register Locate point 2, first advance the tape to [0100].
- [5] Press **MEMO2/P.OUT** to register Locate point 2.
The Memory Display will show [0020 ▶ 0100].
- [6] Now Locate points 1 and 2 have been registered.

● How to cancel (reset) and re-register the locate points

If you wish to modify the registered locate point (re-register the locate point), reset the settings, following the procedure below.

- [1] First, get ready for resetting the locate points.
Press **RECALL** to turn **LOCATE ON**.
- [2] Reset Locate point 1 by pressing **MEMORY RESET** and **MEMO1/P.IN** simultaneously.
- [3] Reset Locate point 2 by pressing **MEMORY RESET** and **MEMO2/P.OUT** simultaneously.
- [4] Follow the steps for registering the locate points to re-register them.

Note: A basic rule for registering the locate points: Point 1 < Point 2

The value of Locate point 2 should be larger than the value of Locate point 1. If you try to set a value for Locate point 1 that is larger than Locate point 2, the Memory Display will show [- - - E]. If you try to set a value for Locate point 2 that is smaller than Locate point 1, the Memory Display will show [- - - E]. If one of these errors is displayed, check the counter and register the correct value.

● If you have changed Locate point 0 [0000]

If you have reset and changed the position of Locate point 0 (position [0000] on the Counter Display), the registered value of Locate points 1 and 2 will be changed accordingly. Although these values change, the physical position of the points on the tape will remain the same.

Locate point 1 (0020)



Locate point 2 (0100)



▲ (0050)

Example 1: Locate point 1 (0020) is reset.
Locate point 1 ⇒ (0000)
Locate point 2 ⇒ (0080)

Example 2: Locate point 2 (0100) is reset.
Locate point 1 ⇒ (9920)
Locate point 2 ⇒ (0000)

Example 3: Point (0050) is reset.
Locate point 1 ⇒ (9970)
Locate point 2 ⇒ (0050)

Auto Stop function

1. What is the Auto Stop function?

Auto Stop function allows the tape to be automatically fast forwarded or rewound and stopped at one of the three locate points (0, 1, or 2).

2. How to use the Auto Stop function

[1] Auto stop at Locate point 0 [0000]:

Press **▶▶0◀◀**. Regardless of the current position of the tape, the tape will be advanced fast forward or rewound and stopped at the position of [0000] on the Counter Display.

[2] Auto stop at Locate point 1 or 2:

First register Locate points 1 and 2.

Pressing **▶▶1◀◀** will advance fast forward or rewind and stop the tape at Locate point 1. Pressing **▶▶2◀◀** will position the tape at Locate point 2.

Note: If locate points 1 and 2 have not been registered, this function does not work.

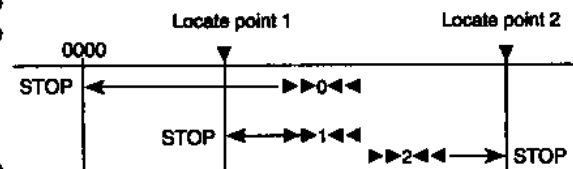

Auto Play function

1. What is the Auto Play function?

The Auto Play function allows the tape to automatically fast forward or rewind to one of three locate points (0, 1, or 2) and to play back from that position.

Before using the Auto Play function, press **AUTO▶** to turn **AUTO▶ ON**.

2. How to use the Auto Play function

[1] Auto Play from Locate point 0 [0000]:

Press **▶▶0◀◀**. Regardless of the current position of the tape, the tape will fast forward or rewind to the position shown as [0000] on the Counter Display. Then playback will start.

[2] Auto Play from Locate point 1 or 2:

First register Locate points 1 and 2.

Pressing **▶▶1◀◀** will fast forward or rewind the tape to Locate point 1. Pressing **▶▶2◀◀** will position the tape at Locate point 2. Then playback will start.

Note: If locate points 1 and 2 have not been registered, this function does not work.

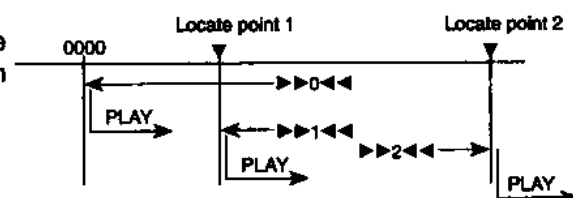

3. How to cancel Auto Play function

Pressing **AUTO▶** a second time will cancel this function.

Auto Repeat function

1. What is the Auto Repeat function?

Auto Repeat function allows the section on the tape specified between Locate points 1 and 2 to repeat playback as many times as you wish.

2. How to use Auto Repeat function

- [1] First register Locate points 1 and 2.
- [2] Press **REPEAT** to turn **REPEAT ON**.
- [3] Be sure to play back the tape slightly before Locate point 2.
- [4] When Locate point 2 is reached, the tape will automatically rewind to Locate point 1, and play back. This will repeat until you stop the tape.

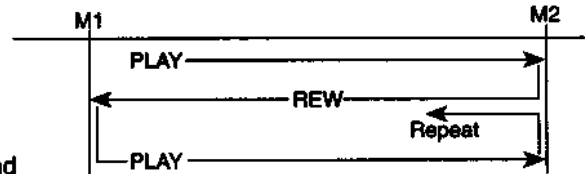

Auto Play & Repeat function

1. What is the Auto Play & Repeat function?

The Auto Play & Repeat function is a combination of the Auto Play function and the Auto Repeat function. The tape will rewind or advance fast forward from any position to Locate point 0 or 1, and play back automatically. Then, playback will repeat between Locate points 1 and 2. Be sure to register Locate points 1 and 2 before using the Auto Play & Repeat function.

2. How to use the Auto Play & Repeat function

2-1. Auto Play & Repeat from Locate point 0 [0000]

- [1] Press **AUTO▶** to turn **AUTO▶ ON**.
- [2] Press **REPEAT** to turn **REPEAT ON**.
- [3] Press **▶▶0◀◀**. Regardless of the current position of the tape, the tape will advance fast forward or rewind to the position shown as [0000] on the Counter Display. Then playback will start.
- [4] When Locate point 2 is reached, the tape will automatically rewind to Locate point 1 and then play back. This cycle will repeat until you stop the tape.

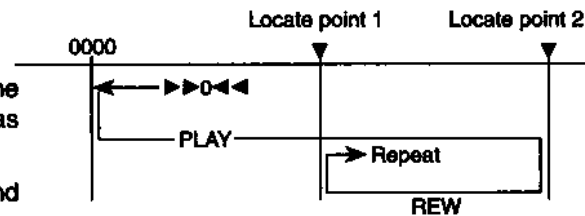

2-2. Auto Play & Repeat from Locate point 1

- [1] Press **AUTO▶** to turn **AUTO▶ ON**.
- [2] Press **REPEAT** to turn **REPEAT ON**.
- [3] Press **▶▶1◀◀**. Regardless of the current position of the tape, the tape will advance fast forward or rewind to Locate point 1. Then playback will start.
- [4] When Locate point 2 is reached, the tape will automatically rewind to Locate point 1 and then play back. This cycle will repeat until you stop the tape.

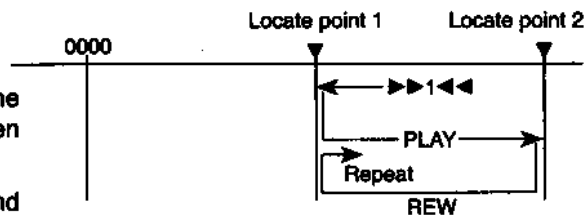

Chapter 4: Punch-in/out

What is Punch-in/out?

Punch-in/out recording allows you to re-record a performance over a certain portion of a pre-recorded track. It is useful in the following example:

You have recorded your guitar solo part. However, you have played a couple of incorrect notes in a few measures. You may want to correct these mistakes, but you do not want to re-record entire solo part from the beginning. In this case, using Punch-in/out, you can re-record (punch-in) starting from the top of those few measures and then stop recording (punch-out) at the end of the measures.

● Two types of Punch-in/out: Manual and Auto

As explained in the Locate function chapter, you can register locate points on the MODEL 380S. In a similar manner, you can register punch-in/out points before performing Auto Punch-in/out. You can also manually choose punch-in/out points in Manual Punch-in/out.

● Convenient Rehearsal function

Using the Rehearsal function allows you to practice the phrases you wish to re-record, accompanied by the recorded material. In this case, you turn the selected track to input monitor. No signal will be recorded.

How to Manual Punch-in/out







There are two methods of Manual Punch-in/out: One uses the optional Model 8051 foot switch; the other uses REC button.

Before starting Manual Punch-in/out, press **AUTO PUNCH** to turn **AUTO PUNCH** OFF.





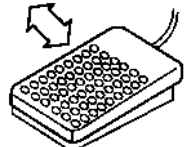
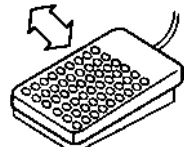

Example: Punch-in/out on Track 1

[1] Using the foot switch:

For rehearsal, press **REHEARSE** to turn **REHEARSE** ON.

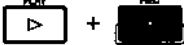
	REC TRACK 	Play (From the position a little before punch-in)	Punch-in	Punch-out
Punch-in/out recording In	Turn REC SELECT  ON, and  will blink.	Press PLAY button. 	Step on the foot switch.  REC ● (Lit) → Lit →	Step on the foot switch.  → Off → Blink
Rehearsal mode Turn REHEARSE ON. Then follow the steps for punch-in/out re-cording			REC  (Blink) → → Lit	→ Off → Blink

[2] Using the REC button

	REC TRACK 	Play (From the position a little before punch-in)	Punch-in	Punch-out
Punch-in/out recording In	Turn REC SELECT (7) ON, and  will blink.	Press the PLAY button. 	Punch-in While holding down the PLAY button, press the REC button.  REC ● (Lit) ⇒ Lit	While holding down the PLAY button, press the STOP button immediately.  ⇒ Off ⇒ Blink
Rehearsal mode Turn REHEARSE OFF.		Press the PLAY button. 	Press the REC button.  REC ● (Blink) ⇒ Blink	Press the REC button again.  ⇒ Off ⇒ Blink

- * Connect the optional Model 8051 foot switch to the PUNCH IN/OUT jack.
- * You can select one or multiple tracks for Punch-in/out recording.

How to Auto Punch-in/out

1. Registering Punch-in/out points

Before you start Auto Punch-in/out, you need to register a punch-in point (IN point) and a punch-out point (OUT point).

Example: Registering IN point to [0020], and OUT point to [0060]

- [1] Press **RECALL** to turn **PUNCH** ON.
- [2] In order to register an IN point, advance (or rewind) the tape until the Counter Display shows [0020].
- [3] Press **MEMO1/P.IN** to register the IN point. The Memory Display will show [0020 ▶ - - - -].
- [4] In order to register an OUT point, first advance the tape to [0060].
- [5] Press **MEMO2/P.OUT** to register OUT point. The Memory Display will show [0020 ▶ 0060].
- [6] Now both Punch-in/out points have been registered.

2. How to cancel (reset) and re-register the IN/OUT points

If you wish to modify the registered IN/OUT points, follow the procedure below.

- [1] First, get ready for resetting the IN/OUT points. Press **RECALL** to turn **PUNCH** ON.
- [2] Reset the IN point by pressing **MEMORY RESET** and **MEMO1/P.IN** simultaneously.
- [3] Reset the OUT point by pressing **MEMORY RESET** and **MEMO2/P.OUT** simultaneously.
- [4] Follow the steps for registering the IN/OUT points to re-register them.

Note: Basic rule for registering the IN/OUT points: IN point < OUT point

The value of the OUT point should be larger than the value of the IN point. If you try to set a larger value for the IN point than the OUT point, the Memory Display will show [- - - E]. If you try to set a smaller value for the OUT point than the IN point, the Memory Display will show [- - - E]. If one of these errors is displayed, check the counter and register the correct value.

● Rehearsal

Example: Registering IN point to [0020] and OUT point [0060], and Auto Punch-in/out on Track 1

- [1] Press **AUTO PUNCH** to turn **AUTO PUNCH** ON.
- [2] Press **REHEARSE** to turn **REHEARSE** ON.
- [3] Turn Track 1 ON using REC SELECT $\text{\textcircled{1}}$.
REC TRACK **1** will blink.
- [4] Rewind the tape to just before the IN point.
- [5] Press the REC button and the PLAY button simultaneously.
PUNCH will be turned ON, and the IN point number [0020] on the left side of the Count Display will start blink.
The tape will be played back until the IN point is reached.
- [6] At the IN point, the track will automatically turn to input monitor (Punch-in start).
REC $\text{\textcircled{2}}$ will blink.
REC TRACK **1** will be lit.
OUT point counter [0060] will start blink.
- [7] When the OUT point is reached, operation shifts back to normal playback.
REC $\text{\textcircled{2}}$ will be turned off.
REC TRACK **1** will blink.
PUNCH will automatically turn OFF, and **LOCATE** will be turned ON. The counter display will show the locate point. If no locate point is registered, the display will show [- - - - ▶ - - - -].

● Recording

Follow the same steps as rehearsal for real punch-in/out recording, with two exceptions.

- [1] Be sure to turn **REHEARSE** OFF.
- [2] When IN point is reached, REC $\text{\textcircled{2}}$ will be lit and the performance will actually be recorded.

■ Indicator status during Auto Punch-in/out (during real recording and rehearsal)

	Setup	Tape playback REC+PLAY	Punch-in	Punch-out
PUNCH LOCATE	Either PUNCH or LOCATE is ON.	PUNCH is ON		⇒ LOCATE is ON
REC TRACK 1	Blink		⇒ Lit	⇒ Blink
REC $\text{\textcircled{2}}$ (Recording) REC $\text{\textcircled{2}}$ (Rehearsal)			Lit Blink	⇒ Off ⇒ Off
[0020 ▶ 0060] Memory Display		[0020 ▶ 0060] The left counter is blink.	[0020 ▶ 0060] The right counter is blink.	The display shows the locate points. [- - - - ▶ - - - -] or [xxxx ▶ xxxx]
		▲ Start	▲ IN point	▲ OUT point

Advanced Auto Punch-in/out

(Combination of Auto Repeat function and Auto Punch-In/out)

● Listening repeatedly to the part you just Punched-in

After you have finished punching-in, you may want to listen to the recorded part. The Auto Repeat function is useful for this purpose. If you have registered Locate point 1 before the IN point and Locate point 2 after the OUT point, you can listen to the part between Locate points 1 and 2 repeatedly after you finish a punch-in.

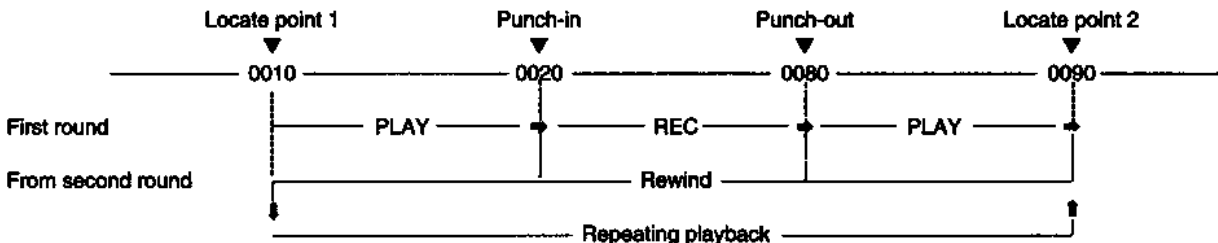

Example: Registering Locate point 1 to [0010], Locate point 2 to [0090], IN point to [0020], and OUT point to [0080], and Auto Punch-In/out on Track 1

- [1] Register these four points, referring to the steps described in the section on registering locate points and Auto Punch-in/out points.
- [2] Press **AUTO PUNCH** to turn **AUTO PUNCH** ON.
Press **REPEAT** to turn **REPEAT** ON.
- [3] Turn Track 1 ON using REC SELECT^⑦.
REC TRACK **1** will blink.
- [4] Rewind the tape to the point just before the IN point, or press **▶|◀** to rewind the tape to Locate point 1.
- [5] Press the REC button and the PLAY button simultaneously.
PUNCH will be turned ON, and the IN point number [0020] on the left side of the Count Display will start blink. The tape plays back until the IN point is reached.
- [6] At the IN point, the track will automatically enter recording mode (Punch-in start).
REC● will be lit. REC TRACK **1** will be lit.
OUT point counter [0080] will start blink.
- [7] When the OUT point is reached, operation shifts back to normal playback.
PUNCH will automatically turn OFF, and **LOCATE** will be turned ON.
REC● will be turned off.
REC TRACK **1** will blink.
The number on the right side of the Memory Display [0010 ▶ 0090] (Locate point 2) will start blink.
- [8] When Locate point 2 is reached, the tape will automatically rewind to Locate point 1. The number on the left side of the Memory Display [0010 ▶ 0090] (Locate point 1) will blink.
- [9] When Locate point 1 is reached, the Auto Repeat function will play back between Locate points 1 and 2.
At this time, the MODEL 380S will not enter Punch-in recording mode when IN point is reached.

● Repeated rehearsal

You can repeatedly rehearse for Punch-in/out, using the Auto Repeat function. The operation is the same as that for "Listening repeatedly to the part you just punched-in" described above, with two exceptions:

- [1] Be sure to turn **REHEARSAL ON**.
- [2] When Locate point 2 is reached, the MODEL 380S will automatically rewind the tape to Locate point 1, and repeat the rehearsal operation.

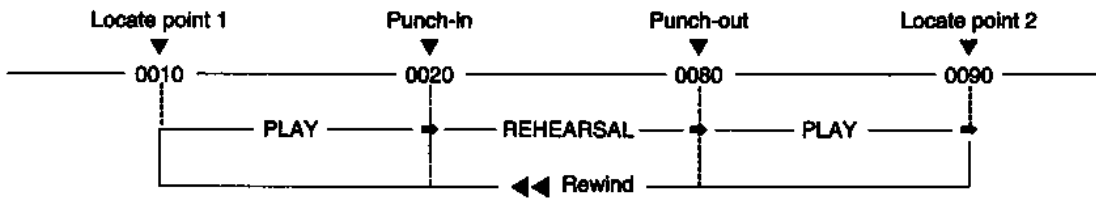

Chapter 5: Basic operations

Direct recording (easy even if you are not familiar with mixing consoles)

This chapter explains two typical recording methods for basic operations.

① Multi-track recording using overdubbing

For this type of recording, we will explain a method to record on a new track while listening to signal already recorded on another track.

② 4-channel simultaneous recording

For this type of recording, we will explain a method to record musical instruments connected to Channels 1-4 on Tracks 1-4.

Both recording methods employ direct recording, in which four sound sources are input to Channels 1-4 to record. In direct recording, the signal is sent to the track that corresponds to the input channel number.

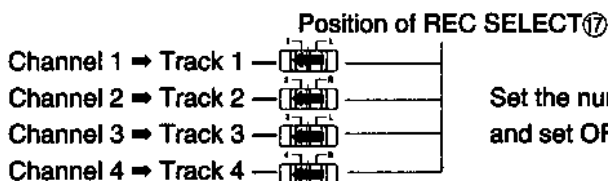

Set the number for the tracks you are going to record, and set OFF for the tracks you are not going to record.

Direct recording is very simple, even for those who try recording for the first time, since it requires only Channels 1-4. For recording additional sound sources connected to Channels 5-12 (multi-track recording using the stereo bus), "Chapter 6: Advanced Applications" will explain the steps.

Note: Check the MODEL 380S for the following items before you start recording.

- Tape speed:** Have you selected a desired tape speed (High or Normal)?
- Dolby NR:** Be sure to play back the tape with Dolby NR ON if it was recorded with Dolby NR ON.
- Pitch:** Always set the pitch to "0" for normal recording.
(Except for mixdown or when you want to create special effects by modifying the pitch)
- Equalizer:** Set the equalizing flat (no equalizing effect) for normal recording.
(It is usually best to apply equalizing while checking the entire balance in mixdown.)

Multi-track recording using overdubbing

STEP1: Recording the drum machine on Track 1

● Table of switch settings

Channel	INPUT fader		SUB Mix section		
	INPUT SELECTOR ^①	PAN ^⑤	ASSIGN ^②	PAN ^⑤	SUB ^③
1	INPUT	****	OFF	****	****
2	OFF	****	OFF	****	****
3	OFF	****	OFF	****	****
4	OFF	****	OFF	****	****

****: The settings here do not affect recording.

MONITOR SELECTOR^⑥: ST + MONMIX

REC SELECT^⑰ [OFF] [1] [2] [3] [4]

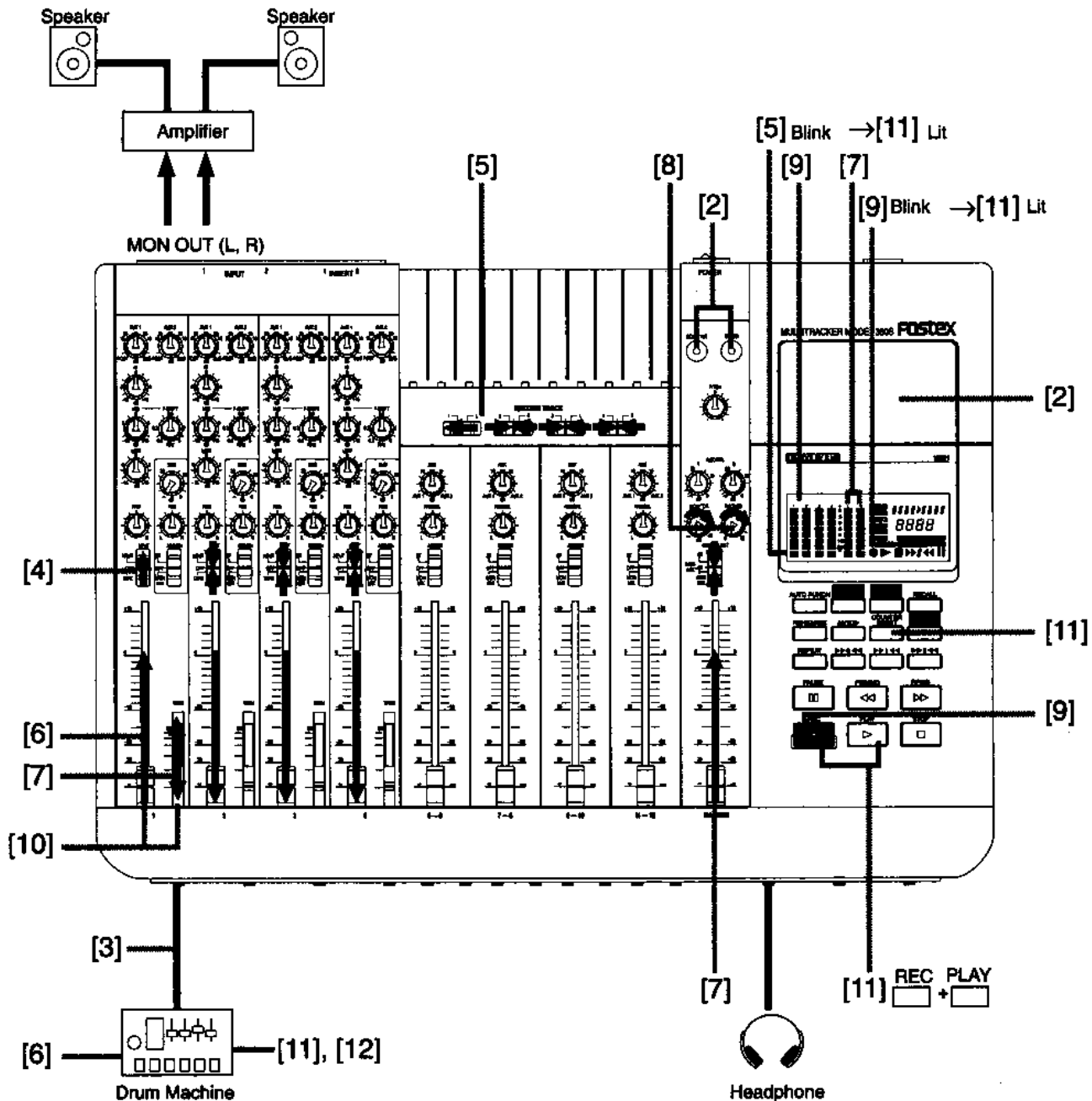

- [1] Position the faders and trim controls all the way down, set all input and assign switches to the middle or OFF position, position all PAN knobs at 12:00, set the sub mix volume control fully counter clockwise, set Hi, Mid and Lo EQ at 12:00, set all AUX 1 & 2 knobs to the 12:00 position, set the Record track select switches to the middle or safe position, set Pitch to 0, AUX returns fully counter clockwise, and the MON SELECT switch to the MONMIX + ST position. All recording sessions should begin with the mixer set in this manner. This is referred to as zeroing out your mixer.
- [2] Insert a blank cassette and cue to the head of the tape. Check that NR is turned ON and that the tape is set for high speed (9.5).
- [3] Use what is currently number 1.
- [4] Set the Input Selector 1 to Input.
- [5] Set track 1 Record Select switch to the 1 position. Record track 1 will blink. Channel 1 Input (Drum sound) will be sent to track 1 directly.
- [6] Start the drum machine and raise Input fader 1 to 0.
- [7] Monitor the drum machine sound. As you move the Master fader to 0, the level meter on the display moves up and down. Set the Master Fader at 0 and move the Channel 1 Trim control until the meters are as close to 0 as possible. Avoid peaking beyond this point.
- [8] Adjust Monitor control and/or Phones control to establish a suitable listening level.
- [9] Press the Record button (the Record light will blink). Track 1 is now in Input Monitor mode and the level meter for track 1 will move.
- [10] Adjust Trim and/or Channel 1 fader so that the level does not exceed 0dB.
- [11] Stop the drum machine. Check that the Counter display is set to 0000. Press and hold Record while pressing Play. you are now recording.
- [12] Start the drum machine.
- [13] Upon completing your recording, stop the drum machine, press Stop on the 380S, and then return the Track 1 Record Track selector switch to the center, or Safe, position.

STEP2: Overdubbing the electric bass on Track 2

● What is overdubbing?

Overdubbing is recording a new performance signal onto a new track while monitoring the pre-recorded track. In STEP 2, you will perform an overdub of an electric bass connected to Channel 2 onto Track 2, while monitoring the drum sound recorded on Track 1.

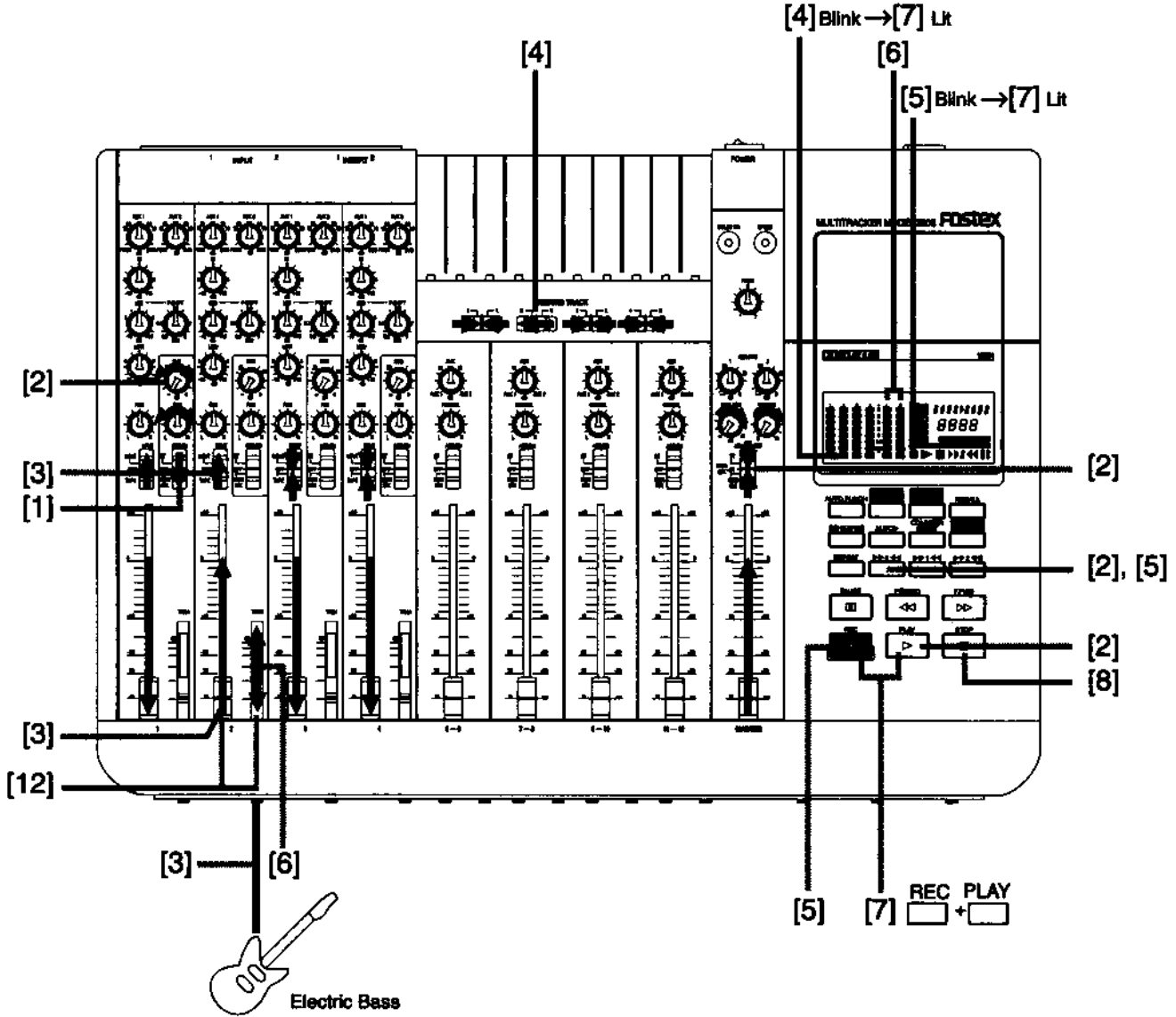

● Table of switch setting

Channel	INPUT fader		SUB Mix section		
	INPUT SELECTOR①	PAN⑤	ASSIGN②	PAN⑤	SUB③
1	INPUT	****	MONMIX	Adjust the stereo placement of Track 1 playback	Adjust the volume of Track 1 playback
2	INPUT	****	OFF	****	****
3	OFF	****	OFF	****	****
4	OFF	****	OFF	****	****

****: The settings here do not affect recording.

MONITOR SELECTOR⑬: MONMIX + ST

REC SELECT⑰ 

● Monitoring Track 1

- [1] Assign 1 to MONMIX.
- [2] Press RTN 0 button to rewind the tape. Press Play to playback the tape. As you rotate the SUB 1 clockwise, you can hear the drum sound.

● Monitoring the electric bass

- [3] Connect the electric bass to Input jack 2. Set the Input selector to Input. Adjust the bass level with Input fader 2.
- [4] Set the Record Select switch for Track 2 to the 2 position. Record Track  will blink. Be certain that Tracks 1, 3 & 4 are in the center, or OFF, position.

● Overdubbing the electric bass onto Track 2

- [5] Rewind the tape to 0000. Press the REC button. Record Track 2 will blink.
- [6] Raise the input fader to 0dB and adjust the level using Trim 2 so that the overall level does not exceed 0dB.
- [7] Check that the Counter display is set to 0000. Press and hold Record while pressing Play. You are now recording. Perform your bass line while monitoring the drum part on Track 1.
- [8] Upon completing your recording, press Stop on the 380S, and then return the Track 2 Record Track selector switch to the center, or Safe, position.

STEP3-1: Overdubbing (Electric guitar → Track 3)

Here you will overdub the electric guitar connected to Channel 3 onto Track 3, while monitoring Tracks 1 and 2.

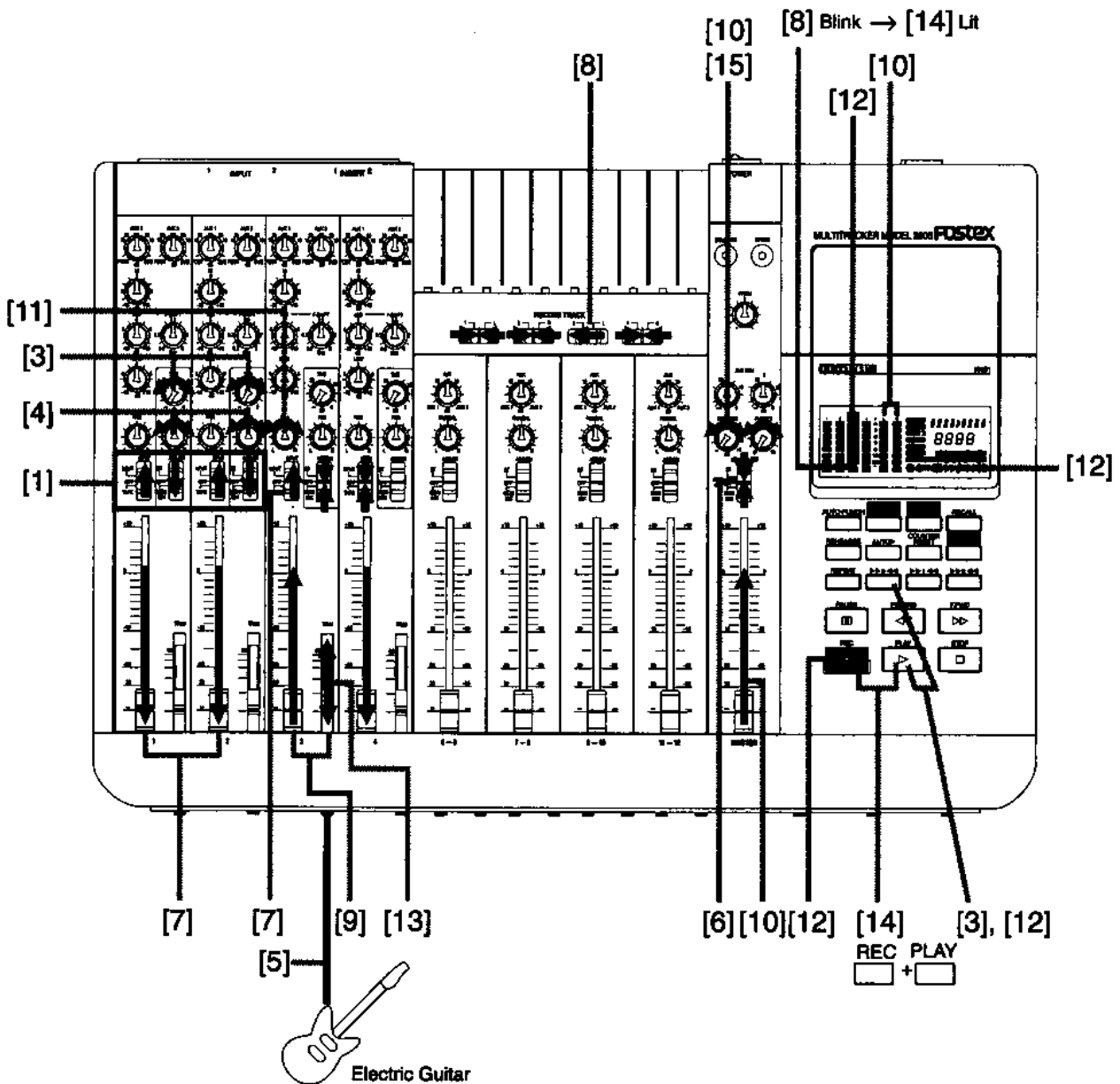

● Table of switch setting

Channel	INPUT fader		SUB Mix section		
	INPUT SELECTOR①	PAN⑥	ASSIGN②	PAN⑤	SUB⑧
1	INPUT	****	MONMIX	Adjust the stereo placement of Track 1 playback	Adjust the volume of Track 1 playback
2	INPUT	****	MONMIX	Adjust the stereo placement of Track 2 playback	Adjust the volume of Track 2 playback
3	INPUT	****	OFF	****	****
4	OFF	****	OFF	****	****

****: The settings here do not affect recording.

MONITOR SELECTOR⑬: MONMIX + ST

REC SELECT⑰:

● Monitoring Track 1 (drum machine) and Track 2 (electric bass)

- [1] Set the INPUT selector 1① to INPUT.
Set the INPUT selector 2① to INPUT.
Set the ASSIGN 1 and 2② to MONMIX.
- [2] The drum sound signal sent to SUB Mix section 1, and electric bass signal sent to the SUB Mix section 2, will be transmitted to the Monmix bus.
- [3] Press to rewind the tape to [0000].
Press the PLAY button to play back the tape.
As you rotate the SUB 1 and 2④ clockwise, you can hear the drum and electric bass sounds.
- [4] Adjust the volume level and pan position using PAN⑤ in the SUB Mix section so that the drum sound, electric bass sound, and electric guitar sound will be well balanced.

● Adjusting the electric guitar sound

- [5] Connect the electric guitar to INPUT jack 3②.
- [6] Leave the MONITOR SELECTOR⑬ set to MONMIX + ST.
- [7] Set the INPUT SELECTOR 3① to INPUT.
The input signal from the electric guitar will be controlled by INPUT fader 3③. Set the INPUT fader 1 and 2③ to the minimum level.

- [8] Set Track 3 to using REC SELECT⑰.
REC TRACK ③ will blink.
Set the other tracks to OFF.
Channel 3 output (electric guitar sound) will be sent to Track 3 directly.
- [9] Adjust the signal level of the electric guitar using the INPUT fader 3③ and TRIM④.
- [10] Monitor the electric guitar sound.
As you raise the Master fader⑱ to 0dB, the level meter on the DISPLAY⑳ fluctuates.
As you raise the MONITOR level⑬, you begin to hear the sound.
- [11] Set PAN3⑤ so that you can monitor the sound easily.
The signal is sent to Track 3 directly regardless of the PAN setting.

● Overdubbing the electric guitar onto Track 3

- [12] Rewind the tape to [0000]. Press the REC button.
REC● and REC TRACK ③ will start blink.
Input signal of Channel 3 is directed to the Input monitor, and the level meter for Track 3 will move.
- [13] Adjust TRIM 3④ so that the maximum level of the meter does not exceed +3.
- [14] Start recording. Press the PLAY button while holding down the REC button.
REC● and REC TRACK ③ will change from blink to illuminated.
- [15] Adjust the monitor level using the MONITOR level⑬.

STEP3-2: Overdubbing (Synthesizer → Track 4)

Here you will overdub the synthesizer sound connected to Channel 4 onto Track 3.
Refer to the steps and the table described in STEP3-1 "Overdubbing the electric guitar to Track 3" for the procedure.

● Table of switch setting

Channel	INPUT fader		SUB Mix section		
	INPUT SELECTOR①	PAN⑤	ASSIGN②	PAN⑤	SUB④
1	INPUT	****	MONMIX	Adjust the stereo placement of Track 1 playback	Adjust the volume of Track 1 playback
2	INPUT	****	MONMIX	Adjust the stereo placement of Track 2 playback	Adjust the volume of Track 2 playback
3	INPUT	****	MONMIX	Adjust the stereo placement of Track 3 playback	Adjust the volume of Track 3 playback
4	INPUT	****	OFF	****	****

****: The settings here do not affect recording.

MONITOR SELECTOR⑬: MONMIX + ST

REC SELECT⑰

Note: The overdubbing procedure for tracks 3 & 4 using direct recording is essentially identical to the procedure documented for overdubbing the bass part on Track 2. By following the above steps 1-8 (beginning with Monitoring Track 1) and substituting your most recently completed track number, adding tracks 3 & 4 should be quite easy.

STEP4: Mixdown

● Mixdown - Final touch-up

What is Mixdown?

Mixdown is the process of playing our four recorded tracks and blending them into a stereo composite signal. This process is the final balancing of the individual tracks in terms of level, pan and depth, or effect setting. Mixdown is the final coming together of all the parts and pieces whereby the finished product is produced and copied to the Master Recorder. The Master Recorder can be a stereo cassette deck, two track open reel recorder, or DAT. Many people consider mixing an art in itself.

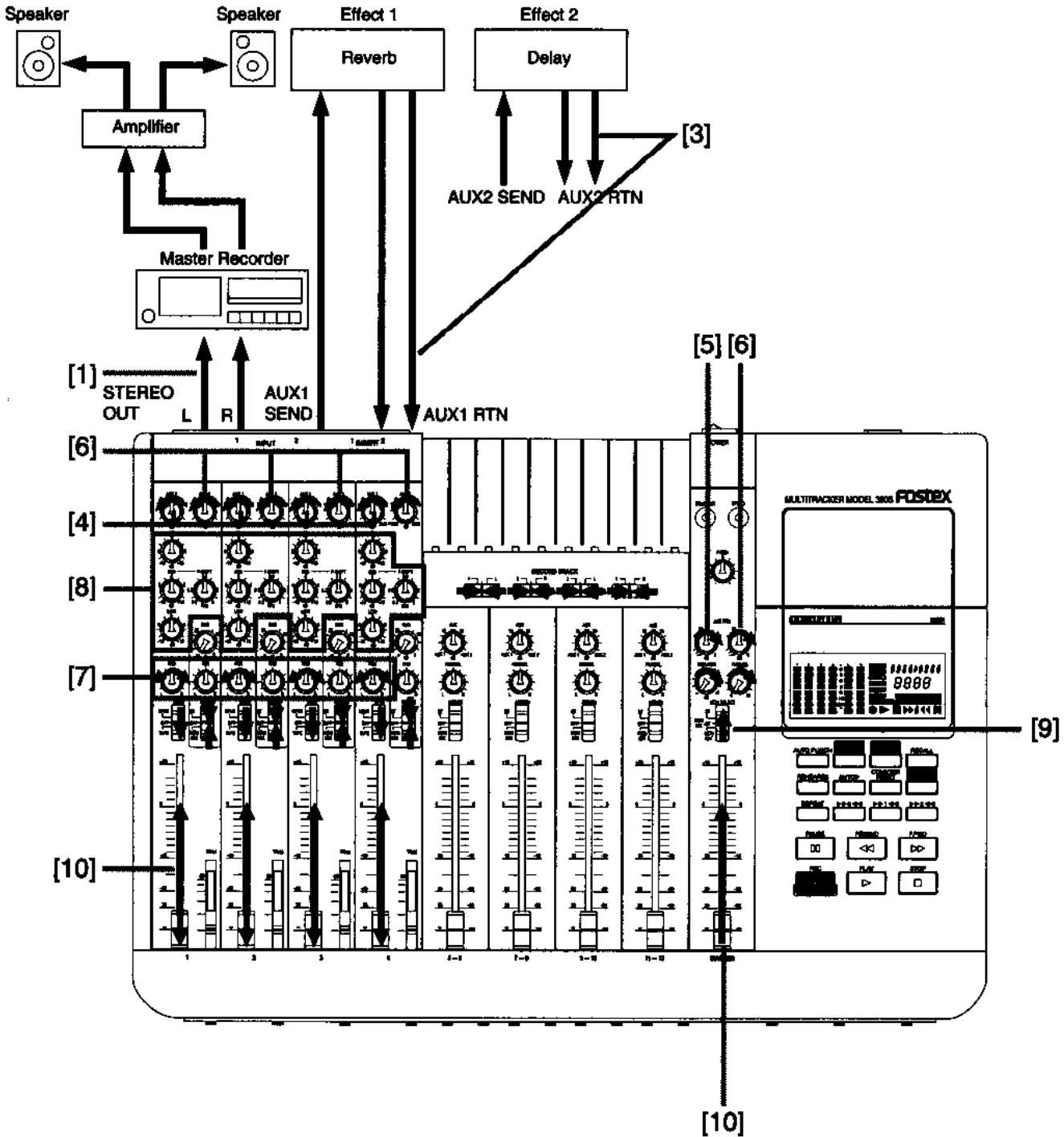

■ Table of switch settings

Channel	INPUT fader		SUB Mix section		
	INPUT SELECTOR①	PAN⑤	ASSIGN②	PAN⑤	SUB⑧
1-4	TAPE	Adjusting the stereo pan position	OFF	***	

***: The settings here do not affect recording.

MONITOR SELECTOR⑮: ST

REC SELECT⑰ 

● Connecting the master recorder

- [1] Connect the MODEL 380S STEREO OUT jacks⑳ to the master recorder line inputs.

● Assign the sound of each track to the INPUT fader③.

- [2] During the mixdown operation, you will assign Tracks 1-4 to INPUT faders 1-4③. Switch settings for mixdown are described below, as well as in the table above.

● Connecting two effect units

- [3] Connect the AUX1 SEND jack㉑ to the input terminal of the digital reverb unit. Connect the AUX1 RTN jack㉒ to the output terminal of the digital reverb unit.
- [4] Turning AUX1 1-4㉓ counter-clockwise will send the signal of channels 1-4 to the effect unit.
- [5] Adjust AUX RTN1⑪ and send the sound with reverb applied by the effect unit to the stereo bus.
- [6] A delay type effect unit has been chosen for the second effect unit. You may want to apply this effect to some parts of the song to make it sound more "live". Adjust the AUX2⑥ and AUX RTN2⑫ and send the delayed signal to the stereo bus. Follow the steps for the first effect unit.

<MEMO>

You can also apply the effect to Channels 1 and 2 independently using the INSERT jacks③. This procedure will be explained in the next section "Four-channel simultaneous recording." (See "Four-channel simultaneous recording" on page 32.)

● Adjusting the stereo image

- [7] You may individually set the stereo pan position of Tracks 1-4, and send them to the master recorder. Adjust the pan position using PAN⑤.

● Equalizing the sound

- [8] Use EQ⑥ to adjust the tonal quality of Tracks 1-4.

● Monitoring the mixed sound

- [9] Make sure that the MONITOR selector⑮ is set to STEREO. You can monitor through the headphones the same sound as that sent to the master recorder. Generally, headphones are used to check the placement (pan position) of instruments in the stereo mix. There is, however, no substitute for a quality pair of studio reference monitors during the mixdown process.
- [10] Raise the MASTER fader⑱ to 0dB. You can control the volume level of Tracks 1-4 already adjusted for balance using the INPUT faders③.

● Efficient rehearsal using the Check Sheet

Repeat rehearsal playing back the tape. It may be helpful to use a Check Sheet like the one shown below, which will allow you to check necessary items during rehearsal and recording. You can also find out which step was not appropriate in case the rehearsal or recording is not successful.

■ Example of Check Sheet

Check Sheet for mixdown	Rehearsal	Recording
● Is the connection of the MODEL 380S and the master recorder correct?		
● Is the sound volume of Tracks 1-4 well balanced?		
● Is the pan position of Tracks 1-4 appropriate?		
● Is equalization of Tracks 1-4 appropriate?		
● Is reverberation appropriate (depth and intensity)?		
● Is the timing and depth of delay appropriate?		
● Do you remember the sequence of operating the faders and controls during the song?		
● Is there any timing problem with the ending?		
● Others:		

■ Example of Mixdown Scenario Sheet

	Introduction	Part A	Guitar solo	Part B	Ending
Counter [0000]	[0010]	[0130]	[0230]	[0360]	[0600]
Effect unit 1 Reverb	Apply the effect lightly over the entire part.				
Effect unit 2 Delay			Start applying the effect here.		
INPUT fader 1 INPUT fader 2 INPUT fader 3 INPUT fader 4		Lower the fader slightly.		Raise the fader slightly.	
MASTER fader	Raise the fader gradually.				Fade out

● Mixdown recording

First repeat rehearsal to achieve the best settings.

The Mixdown Scenario Sheet shown above is something like a scenario book for a drama. You can refer to the tape counter and make notes regarding the timing of the ending or where to apply effects. After finishing rehearsal, start recording. Assign locate points on the tape, and start recording on the master recorder. When you get ready, start playing back the tape. We hope you make a great recording. GOOD LUCK!

Four-channel simultaneous recording

This recording method allows you to record four sound sources simultaneously. The following example (a three-member band, with vocal and acoustic guitar as main) includes three operational procedures. Direct recording is, as already explained, the recording of sound patched to the channels onto tracks of the same number.

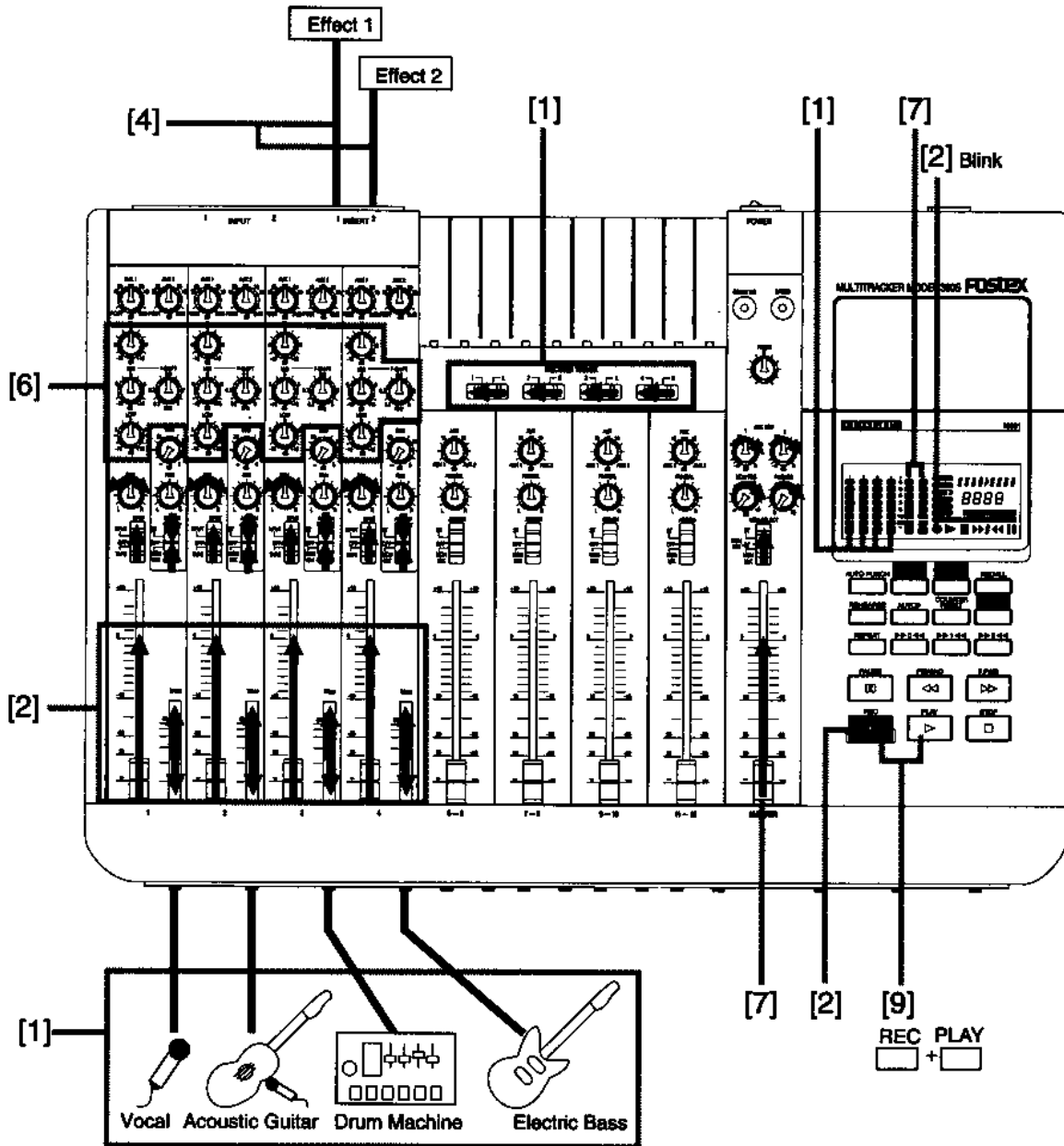

■ Table of switch settings

Channel	INPUT fader		SUB Mix section		
	INPUT SELECTOR①	PAN⑤	ASSIGN②	PAN⑤	SUB⑧
1-4	INPUT	Adjusting the pan position for easier monitoring	OFF	***	

***: The settings here do not affect recording.

MONITOR SELECTOR⑬: ST

REC SELECT⑰ 

● Setting the microphone and musical instruments

- [1] Connect the following musical instruments and microphone to the MODEL 380S. Refer to the Table of switch settings.

Channel 1: Vocal ⇒ Track 1
 Channel 2: Acoustic guitar ⇒ Track 2
 Channel 3: Drum machine ⇒ Track 3
 Channel 4: Electric bass ⇒ Track 4

Connect the microphone to Channels 1 and 2. Channels 1 and 2 have an XLR INPUT connector⑳. Use these jacks to connect a balanced XLR-type microphone.

- [2] Adjust the signal level of each sound source. Press the REC button to turn each track into Input monitor. REC- will blink.
 Set INPUT fader③ to 0dB.
 Adjust TRIM④ so that the level meter will not reach the maximum.

● Setting the effect unit

- [3] Channels 1 and 2 have an INSERT jack㉑.
 Use this jack to apply effects to the microphones connected to Channels 1 and 2 independently.
 It is difficult to set an appropriate volume level for vocal and acoustic instruments due to their wide dynamic range (loudness of the sound). Therefore, you can use effect units such as a compressor to maintain a constant volume level.
- [4] Connect INSERT jacks 1 and 2㉑ to the input/output connectors on the effect units (such as a compressor and limiter). Use the connecting cable as shown in the figure. Adjust the input/output balance on the effect unit, and set the TRIM④ while observing the level meter.

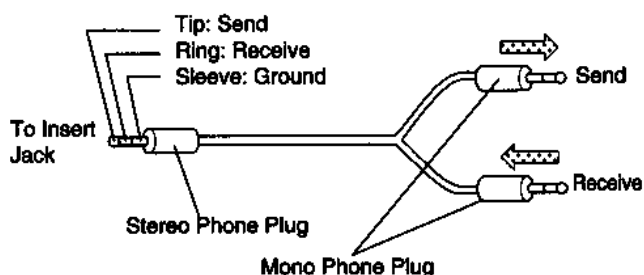

- [5] You may sometimes want to apply an effect such as reverb to all the sound sources, separately from the individual effects applied to Channels 1 and 2. In this case, you may apply the effect during mixdown, rather than during recording. It is generally better to record a sound as close to the real original sound as possible, then process the sound later.

● Setting the recording level, and recording

- [6] Set the equalizer as flat as possible during recording. It is generally better to equalize the sound during mixdown.
- [7] Check the entire volume level balance after adjusting the level of four sound sources. Adjusting the level by raising the MASTER fader⑯ gradually so the level meter for the stereo bus L and R will not reach the maximum.
- [8] Repeat rehearsal throughout the entire song. One of the band members may check the volume level. Check to see that the level meters of each stereo bus and track will not overload at the song's climax.
- [9] After setting the levels and finishing rehearsal, you may start recording.
 Press the REC button and PLAY button to start recording.
- [10] If you are satisfied with the take, you can start mixdown. Refer to step 4 of "Multi-track recording using overdubbing" for the mixdown procedure.

Chapter 6: Advanced applications

The chapter on basic operation explained how to carry out direct recording, in which the input channel maps one-to-one with the recording track (i.e., you record the signal of Channel 1 on Track 1, the signal of Channel 2 on Track 2). Of course, this limits you to four channels.

The MODEL 380S has a total of 12 inputs. If you use inputs 5-12 for stereo signals, you can record four stereo and four monaural sound sources at the same time. The stereo bus is used when you record five or more sound sources.

This chapter provides procedures and three examples of stereo bus usage.

Example: 1 12-input (8 MIDI sound sources) simultaneous stereo recording

This example explains how to patch four monaural sound sources to Channels 1-4, and four stereo sound sources to Channels 5-12, and to record Stereo bus L signal to Track 1 and Stereo bus R signal to Track 2.

Example: 2 Overdubbing using the stereo bus

This example explains how to overdub the synth sound patched to Input 11 onto Track 3, while listening to the playback of Tracks 1 and 2.

Example: 3 Ping-pong recording

This example explains how to perform ping-pong recording. In this example, you transfer (ping-pong) Tracks 1-3 to Track 4 while recording an additional five sound sources on Track 4.

Example 1: 12-input (8 MIDI sound sources) simultaneous stereo recording

● Difference from direct recording

In direct recording, you apply effects and equalize the sound during mixdown. In this example, eight MIDI sound sources are distributed to stereo buses L/R, and recorded on Tracks 1 (L) and 2 (R). Once you have merged tracks by mixing them together, you cannot retrieve or process any of the original, individual signals. Therefore, you need to set the stereo pan position of each sound source and conduct effects processing during the recording. This recording method requires a more precise adjustment of the sound source settings than direct recording.

● Setting the microphone and musical instruments

[1] Refer to the figure to see how to connect the microphone and instruments.

■ Table of switch settings and functions

Channel	INPUT selector①	PAN⑤
1-4	INPUT	Adjusting the stereo image

Channel	ASSIGN②	PAN⑤
5-12	ST	Adjusting the stereo image

MONITOR selector⑥: ST

REC SELECT⑦ 

* SUB Mix section is not used. Set ASSIGN 1-4② to OFF.

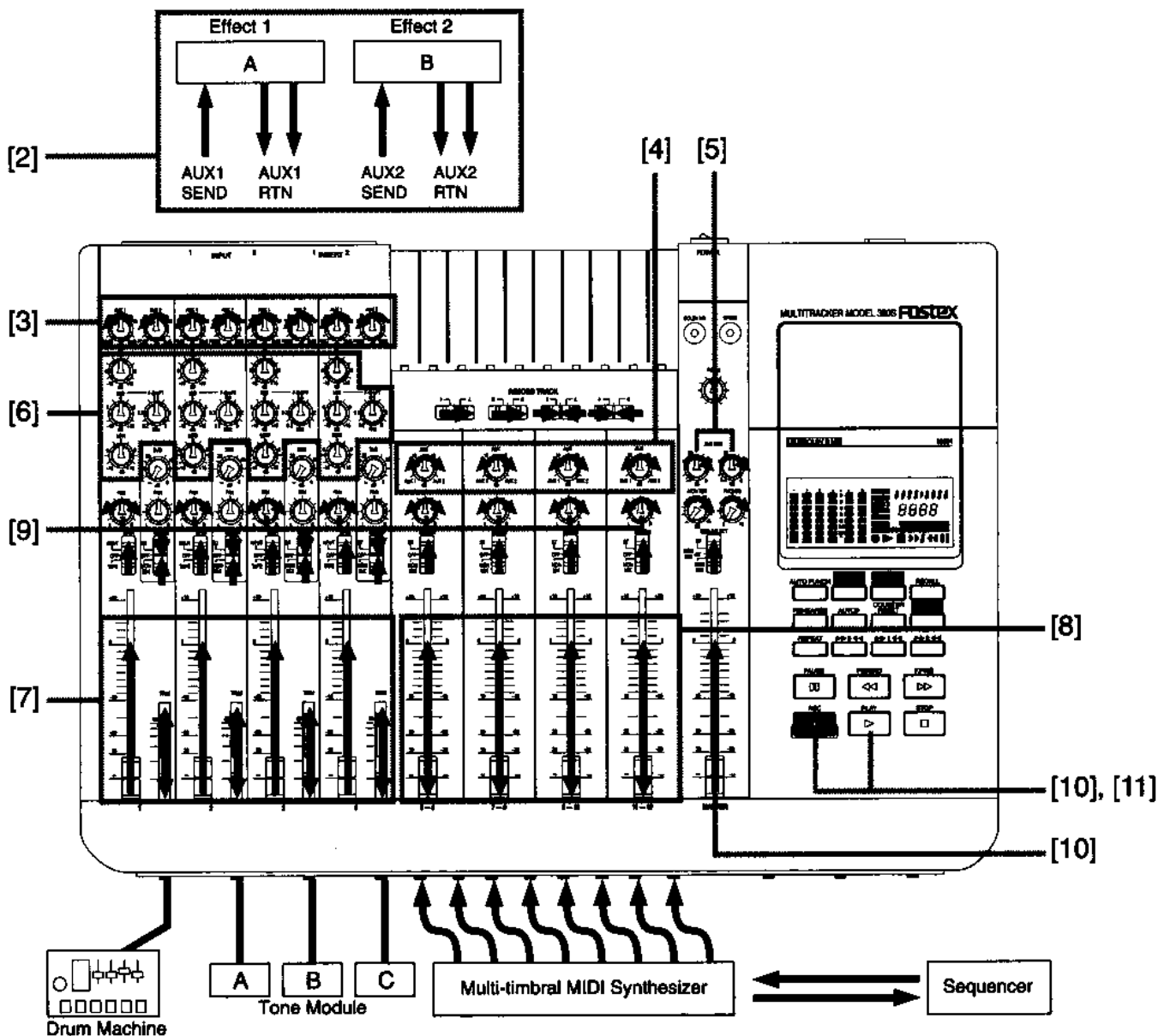

● Setting the effect units

- [2] Use two effect units, A and B.
Connect Effect unit A to AUX1 SEND jack³⁹ and AUX1 RTN jack⁴⁰.
Connect Effect unit B to AUX2 SEND jack³⁹ and AUX2 RTN jack⁴⁰.
- [3] You can use Channels 1-4 for both effects at the same time. Adjust the output level to the effect units using AUX1⁷ and AUX2⁸.
- [4] You can use Channels 5-12 for either effect. Turning AUX 1&2¹⁰ counter-clockwise will output the signal to Effect unit A; turning it clockwise will output the signal to Effect unit B.
- [5] Adjust the Effect unit A output signal using AUX RTN 1¹¹; adjust the Effect unit B output signal using AUX RTN 2¹².

● Adjusting equalization, stereo image, and level

- [6] Adjust the tonal quality of the sound sources patched to Channels 1-4 using EQ⁶.
- [7] Adjust the level of Channels 1-4. Set the INPUT faders 1-4³ to 0dB, and adjust the level using TRIM⁴.
- [8] Adjust the level of Channels 5-12. Since these channels do not have TRIM, adjust the level using the INPUT faders.
- [9] Set the pan position of the eight sound sources using PAN⁵.
- [10] Press the REC button to turn Tracks 1 and 2 to Input monitor. Adjust the entire level using the MASTER fader¹⁶ while observing the level meter of Tracks 1 and 2, and stereo bus.

● Rehearsal, and recording

- [11] After setting up, repeat rehearsal until you are satisfied, then start recording. Press the REC button and PLAY button to start recording.

Example 2: Overdubbing using stereo bus

Here you can overdub the synth sound patched to INPUT 11 onto Track 3 (without changing the synth setting) while listening to the playback of Tracks 1 and 2.

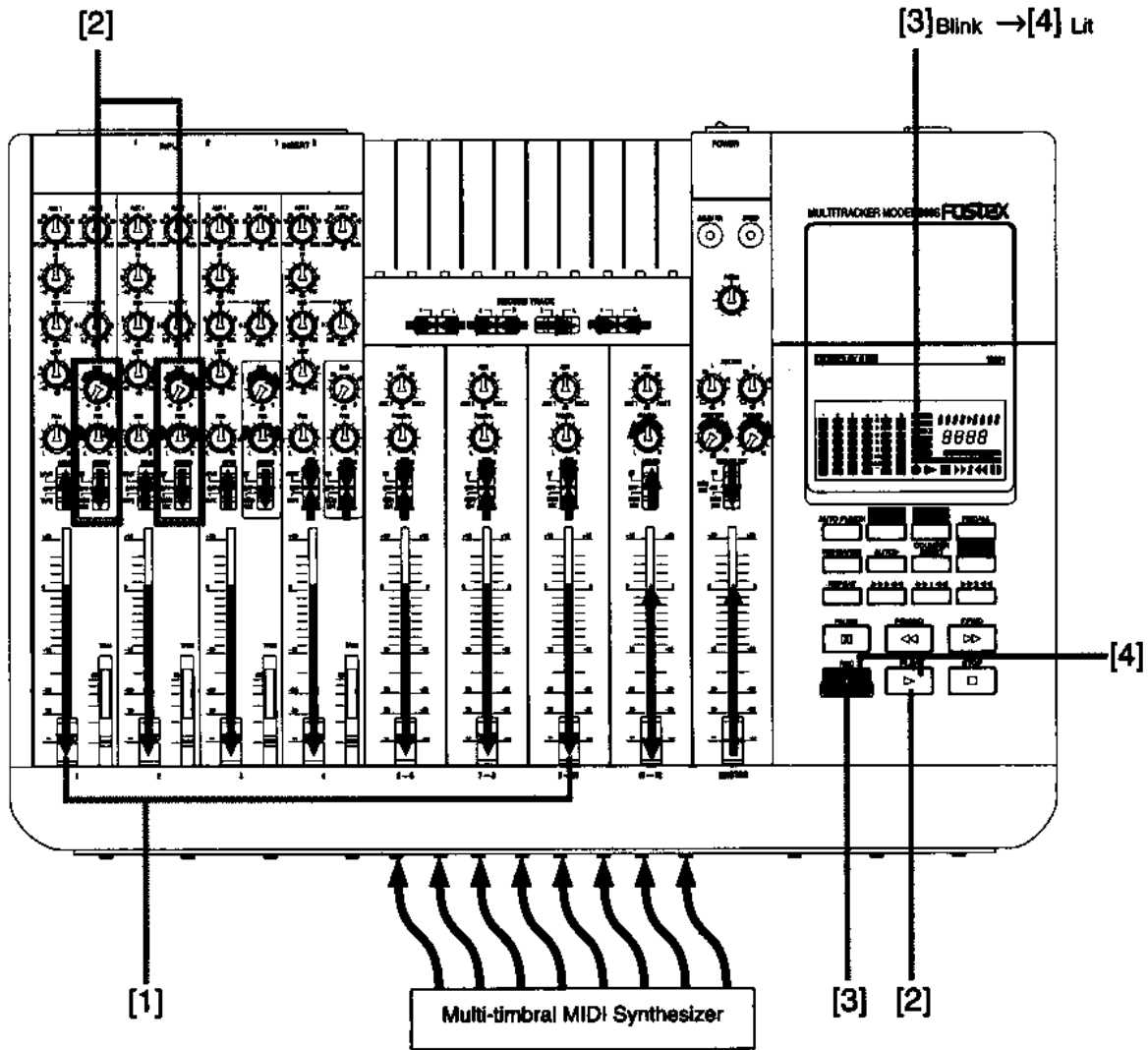

■ Table of switch setting

Channel	INPUT fader		SUB Mix section	
	INPUT selector①	PAN⑤	ASSIGN②	SUB⑨, PAN⑤
1-2	INPUT	****	MONMIX	Adjusting the monitor balance of Tracks 1 and 2
3	INPUT	****	MONMIX	Adjusting the monitor balance of Track 3 input signal
4	OFF	****	OFF	****

Channel 5-10	
ASSIGN②	PAN⑤
OFF	****

Channels 11 and 12	
ASSIGN②	PAN⑤
ST	Left most

MONITOR selector⑮: MONMIX

REC SELECT⑰ 

****: The settings do not affect the operation.

- [1] Refer to the table for the switch settings.
Set all the INPUT faders 1-10③ to the minimum level.
- [2] Press the PLAY button to start rehearsal.
Bring Tracks 1 to the SUB Mix section to monitor them.
Use the INPUT faders 11-12③ to adjust the volume level of the synth patched to INPUTS 11 and 12.
- [3] Press the REC button to turn Track 3 to Input monitor.
REC  will blink.
Use PAN⑤ and SUB⑨ in the SUB Mix section of Channel 3 to adjust the Track 3 monitor balance.
- [4] Repeat rehearsal until you are satisfied; then start recording.
Press the REC button and PLAY button to start recording.

Example 3: Ping-pong recording

● What is ping-pong recording?

Ping-pong recording is a method of mixing the playback of multiple tracks and recording the mix onto another track. Ping-pong recording allows you to overdub new sound on a pre-recorded track to layer additional sound sources.

● Notes for ping-pong recording

Assume you will perform ping-pong recording to the adjacent track, for example, recording the data from Track 2 to Tracks 3 or 1. If oscillation occurs, reduce the output level (lower INPUT fader^③), or attenuate the high range using EQ^⑥. Repeated recording and overdubbing will attenuate the high range, and emphasize the low range. Take this into consideration when you adjust the equalizer for ping-pong recording.

You cannot modify the volume level and tone quality for each track individually once the tracks have been transferred in ping-pong recording. Therefore, repeat rehearsal until you are satisfied before you start recording.

In the following example, ping-pong recording is performed from Tracks 1-3 to Track 4. An additional five sound sources (A-E) are also played and recorded on Track 4 at the same time.

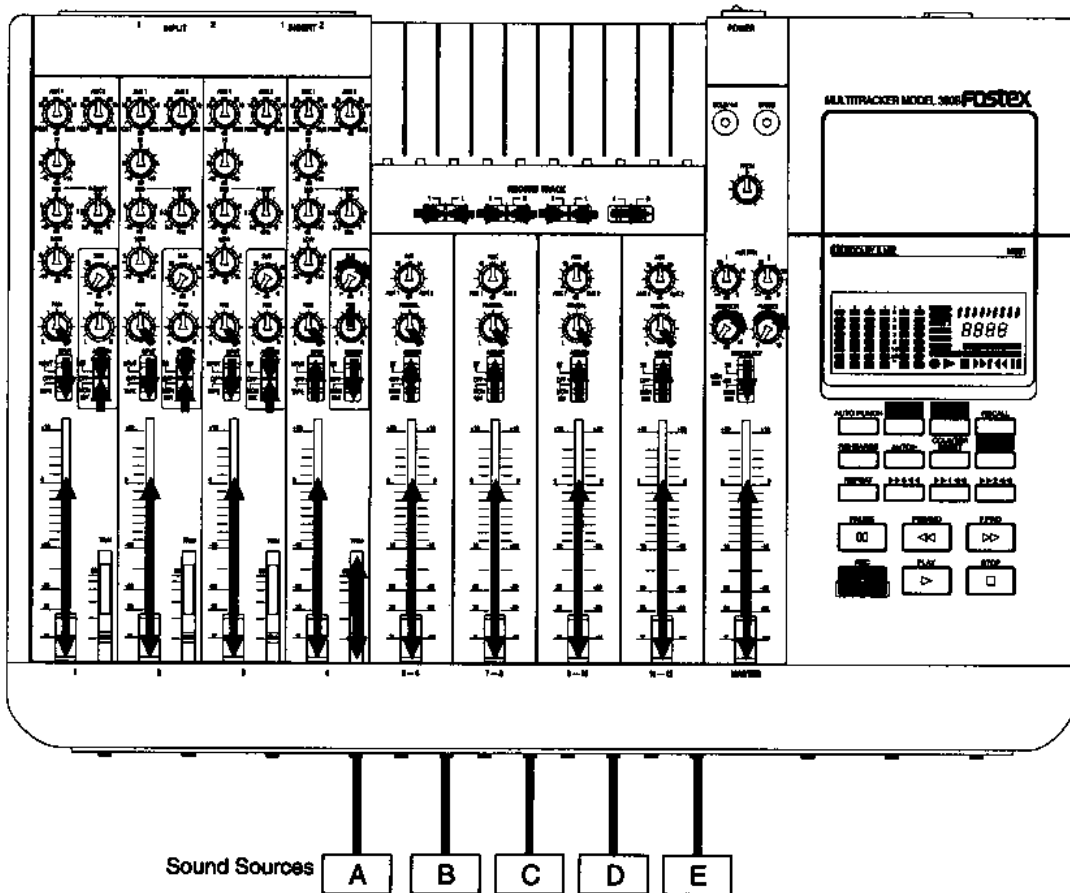

■ Table of switch setting

Channel	INPUT fader		SUB Mix section			Channels 6, 8, 10, and 12	
	INPUT selector①	PAN⑤	ASSIGN②	PAN⑤	SUB⑨	ASSIGN②	PAN⑤
1	TAPE	Right most	OFF	****	****	ST	Right most
2	TAPE	Right most	OFF	****	****		
3	TAPE	Right most	OFF	****	****		
4	INPUT	Right most	MONMIX	Center	Adjusting the monitor balance of Track 4		

****: The settings do not affect the operation.

MONITOR selector⑯: MONMIX

REC SELECT⑰ 

● Setting the musical instruments, microphone and switches

Refer to the table and figure for set-up information.

Following are the main steps to set-up.

- Set Track 4 to R using the REC SELECT⑰.
Set the other tracks to OFF.
Press the REC button to turn the track to Input monitor.
REC- will blink.
- Set the INPUT selector① of Channels 1-3 to TAPE.
Adjust the volume level of Tracks 1-3 signal using the INPUT fader③, and adjust the tonal quality using EQ⑥.
Turn PAN⑤ clockwise all the way to send the signal to the Stereo bus R.
- Set the INPUT selector① of Channel 4 to INPUT.
Adjust the volume level of Sound source A using the INPUT fader③, and adjust the tonal quality using EQ⑥.
Turn PAN⑤ clockwise all the way to send the signal to the Stereo bus R.
- Set ASSIGN② of Channels 6, 8, 10, and 12 to ST. Use the corresponding INPUT fader③ to adjust the volume level.
- Raise SUB⑨ and PHONES level⑭ of the SUB Mix section.
You can monitor the Track 4 input signal (Stereo bus R) at the center position.
Adjust the monitor volume level using SUB⑨ and MONITOR level⑬.

● Rehearsal and recording

After adjusting the entire balance, repeat rehearsal.

Press the REC button and PLAY button to start recording.

* You can also perform ping-pong recording while equalizing the source newly Input. In this case, switch the INPUT selector for Channels 1-3 to "INPUT", and adjust the playback sound from Tracks 1-3 in the Submix section.

Chapter 7: Tape sync

● What is Tape sync?

Tape sync means having the MODEL 380S synchronize to the external MIDI devices such as a sequencer or drum machine. The SUB Mix section of the MODEL 380S allows you to play back Tracks 1-3 and up to 12 sound sources simultaneously for mixdown.

Tape sync offers you the following advantages:

- ① Automated performance of connected MIDI devices is not recorded on the tracks, which saves tracks.
- ② You can mixdown the dynamic sounds of electronic musical instruments such as synthesizer and drum machine, creating a piece with high sound quality.
- ③ You can use advanced edit techniques such as overdubbing an automatic performance or replacing the rhythm pattern of the drum machine independently.
- ④ Virtual tracks expand the scope of your recording.

Tape sync requires a sync signal such as FSK or SMPTE. This signal will be recorded and played back on Track 4. FSK signal is a signal that is modified from the "MIDI clock" (one of the MIDI signals; performance tempo signal output from sequencers and drum machines) so that it can be recorded on the tape. SMPTE is typically converted to MIDI Time Code (MTC) which is read by most software based sequencers. The track that contains the FSK/SMPTE signal plays a role as conductor of the orchestra. When the FSK/SMPTE signal is played and sent to the sequencer and drum machine, those connected MIDI devices will synchronize to the signal. Some types of sequencers and drum machines may not be able to process the FSK/SMPTE signal. Refer to the operating manual of the connected MIDI device for details.

Following are steps to mix down eight sound sources (A-H) syncing to Tracks 1-3 in stereo. Refer to the recording method described earlier in this manual for switch settings.

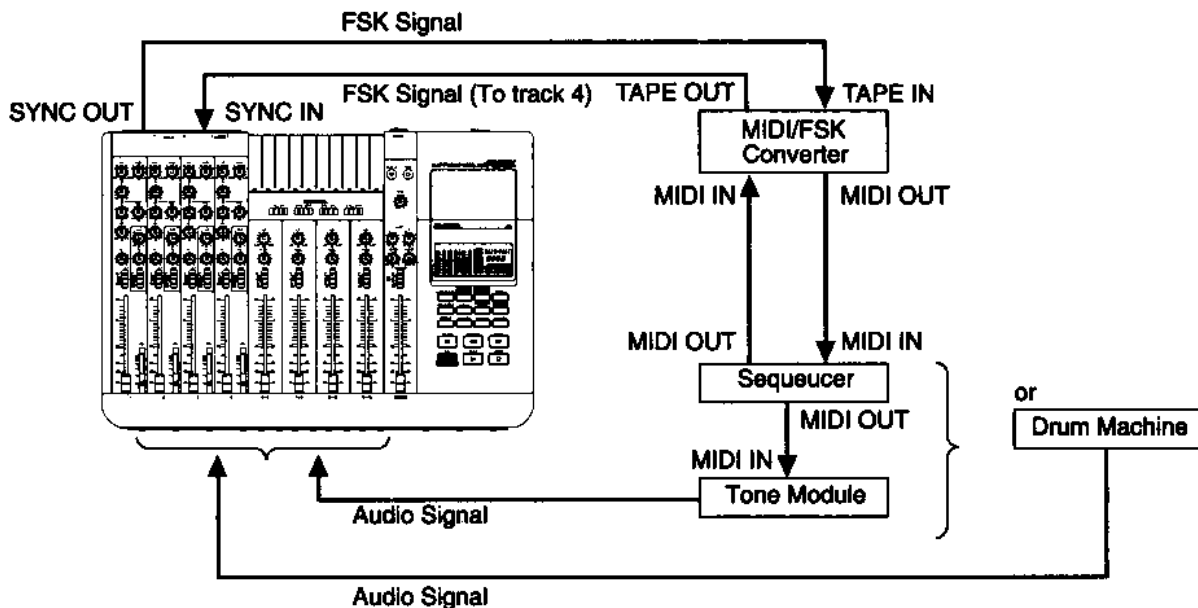

- [1] Store the program of the performance signal on the sequencer, and set the tempo. Once recording is done, the tempo will be fixed.
- [2] Record your sync tone onto track 4 via the 380S SYNC IN jack. We recommend a record level of -3 on the level meter.
- [3] Record the rhythm section, such as a drum part, on Track 1 at the same time. The rhythm part is a temporary part you can use as a guide. After finishing recording on Tracks 2 and 3, record new signal on Track 1.
- [4] Connect sound sources A-H as shown in the figure, and perform a mixdown. Be sure to set INPUT fader 4 to its minimum.

(See "Multi-track recording using overdubs" on page 22.)

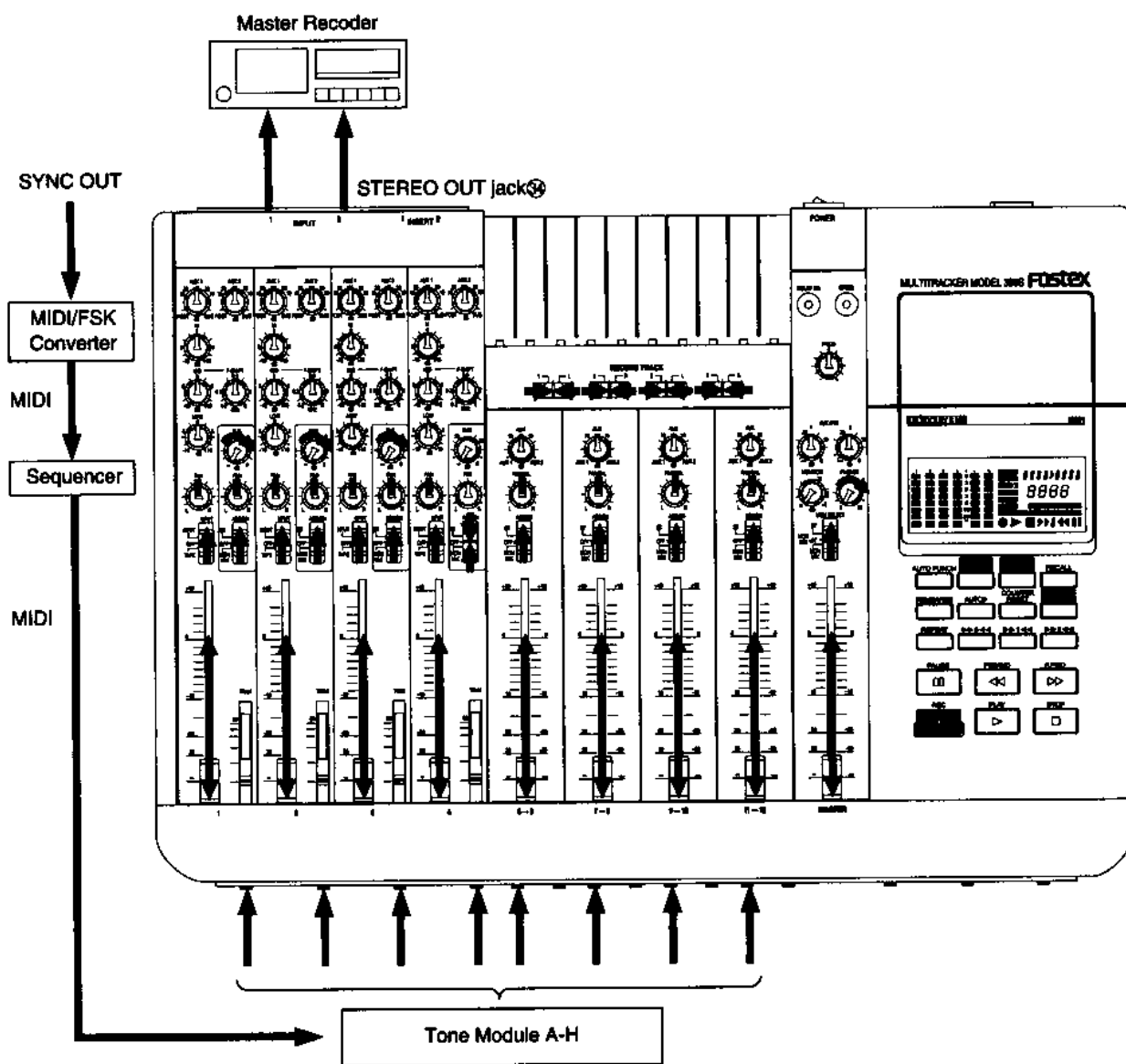

■ Table of switch settings

Channel	INPUT fader		SUB Mix section			Channels 5, 7, 9, and 11	
	INPUT selector ^①	PAN ^⑤	ASSIGN ^②	PAN ^⑤	SUB ^⑧	ASSIGN ^②	PAN ^⑤
1	INPUT: Routing additional sound sources A-D to the INPUT fader ^③ .	Adjusting the stereo image of Sound sources A-D.	ST:	Adjusting the stereo image of Tracks 1-3	Adjusting the volume level of Tracks 1-3	ST: Routing sources E-H to INPUT fader ^③	Adjusting the stereo image of sources E- H
2			Routing				
3			Tracks 1-3 to STEREO bus				
4			OFF				

***: The settings do not affect the operation.

MONITOR selector^⑥: ST

REC SELECT^⑦

[5] Route the sync signal on Track 4 from SYNC OUT jack[Ⓣ] to the input terminal of the sequencer.

[6] Set the sequencer to MIDI slave and start it automatically.

[7] Adjust the balance between the playback of Tracks 1-3 and eight synchronized sources.

[8] Use the Master fader^⑧ to adjust the level of the master recorder that is connected to the STEREO OUT jack[Ⓣ].

Troubleshooting

	Symptom	Check item	Action
Sound trouble	● Pitch is unstable, or notes are skipped.	Are the pinch roller and/or capstan dirty?	Clean them.
		Is the tape damaged?	Use a new, high grade tape.
	● Tonal quality or volume of the playback sound is substantially different from that during recording.	Is the head dirty?	Clean it.
		Are you using the right kind of tape (High position)?	Use a high-position tape (Chrome, TYPEII).
		What is the setting of the Dolby NR switch?	Restore the same setting as recording.
● Distortion/much noise	Are TRIM④ and INPUT faders③ properly set? Is the level meter moving too much or too little?	Adjust the level properly.	
● Playback pitch is different from recording.	Is the PITCH control set in the same position as recording?	Restore the same position.	
Recording trouble	● Cannot send the sound to the desired track, or cannot record.	Is REC SELECT⑰ selected properly? Is PAN⑤ set correctly?	Check them. Tracks 1 and 3 are patched to the stereo bus L, and Tracks 2 and 4 to the stereo bus R.
	● Oscillation occurs during ping-pong recording.	Is the level too high, or is the high frequency range of EQ⑥ boosted too much?	Lower the level or cut the high-frequency range.
	● The sound on the pre-recorded track is inserted during overdubs.	Is the pre-recorded track output to the stereo bus?	Set the output of the pre-recorded track to zero, or do not send the signal of that track to the stereo bus.
	● Cannot record.	Is the record protect tab on the cassette tape broken? Is the MASTER fader⑱ raised?	Apply a piece of cellophane tape. Raise the Master fader⑱.
	● Cannot record the sources patched to INPUT jack⑳ 5-12.	Are the sources routed to the stereo bus?	Set the ASSIGN② to STEREO, and send the signals to the stereo bus.
Transport trouble	● Tape does not transport.	Is the cassette tape installed properly? Is it installed securely?	Install the tape securely.
	● The power is not turned on.	Is the power cable connected properly?	Connect the cable correctly.
Monitoring trouble	● No sound from the headphones	Is the PHONES level⑭ raised?	Raise the level.
	● Distorted sound is output from the monitor amplifier/speaker connected to the MON OUT jack㉑.	Is the MONITOR level⑬ in the appropriate position?	The standard level is 0dB. Adjust the level.
	● The sound of the instruments is muted when the PLAY button is pressed to start rehearsal.	Were you listening to the sound of an instrument track that was turned to Input monitor, before starting rehearsal?	Press the REC button to cancel Input monitor to listen to the sound of the stereo bus.
Effect processing trouble	● Effect is not applied well even if the AUX setting for each channel is raised.	Are the AUX1 RTN⑪ and AUX2 RTN⑫ raised?	Raise the level to an appropriate position.
	● Tape sync does not function well.	Is the recording level of the FSK signal correct? Is the tape dropping out?	Refer to the instruction manual of the drum machine (or sequencer) you are using, and record the signal at a proper level. If the tape is defective, use a new tape.

Maintenance

Cleaning

■ Cleaning a dirty head

A recording/playback head on the tape recorder collects magnetic particle dust from the tape. Dirty heads can cause poor quality recording and playback, deterioration of the sound quality, and playback skipping. Even slight amounts of dirt may affect the high frequency range, resulting in dull sound.

Clean the head frequently. Soak a cotton swab with cleaning solution, and wipe the head gently so that the head will not be scratched.

■ Cleaning a dirty capstan and pinch roller

The capstan and pinch roller are important parts for stable tape transport. If they are dirty with magnetic powder or dust, wow & flutter characteristics may deteriorate, causing pitch deflection or tape jam. Cassette tapes are very thin, and dirty capstan and pinch rollers may cause troubles. Soak a cotton swab or gauze with cleaning solution, and wipe them carefully.

<Warning>

Never use organic solvent such as thinner. It can cause some parts to melt, resulting in a malfunction.

We recommend regular use of the Fostex cleaning kit which contains everything you need to keep your 380S in its optimum operating condition.

Demagnetization

The recording/playback head and capstan become magnetized after being used for a long period of time. They can become magnetized if you hold a magnet or magnetized scissors near them, or touch them with your finger. Disregarding demagnetizing maintenance will cause the frequency characteristics (especially high-end response) to deteriorate, or allow noise to enter the recordings.

Demagnetize those parts using a demagnetizer once a month. Read the instruction manual of the demagnetizer carefully.

ON DOLBY S NR

The Dolby S noise reduction System, used for the first time in a cassette format, is employed in the 380S. Dolby S NR is based on Dolby SR NR, the preferred noise reduction system developed for commercial studio use. Dolby S NR, with its rationalized circuit and other modifications, is a revolutionary noise reduction circuit. At Fostex, we felt it is the ultimate noise reduction system for consumer and professional cassette recording.

Dolby S NR

IN Dolby S NR, as shown in "Basic Concept of Dolby S NR", the entire frequency band is divided into low and high ranges at around 400Hz. The low range is processed from 200Hz and down. Further, the level is divided from Dolby level to -25dB as high level and below this down to -50dB as low level. A maximum of 12dB processing is applied to each high and low level groups.

One stage of the fixed band type (*1) processor for the low level group, and two stages each of the fixed and sliding band type (*2) are provided for the high level group.

Comparison to Conventional Dolby C Type Noise Reduction

Dolby C NR type has a sliding band for the high region in the high and low levels indicated in "Basic concept of Dolby S NR". The reason for dividing it into two levels is to compress, in one step only for the high level input signal and in two steps for the low level signal. This is to maintain optimum processing figures against the signals while attaining noise reduction.

By providing one stage of fixed band in the low region, the noise reduction effect is applied to the entire frequency band. As a result, it can reduce noise in the low region by 10dB. Furthermore, the high region noise suppression amounts to 24dB acquired by two stages of maximum 12dB each which exceeds 20dB in the C type.

Operating merits of each system can be expected in the S type by combining the fixed band system with the sliding type. The real value of Dolby S NR is clearly shown here and the improvement in sound quality is tremendous.

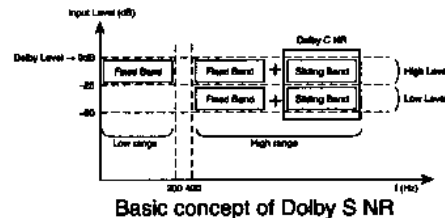

*1. Fixed Band

Sliding band, while superior in many ways to fixed band, also has faults. If the music signal is concentrated in the comparatively high frequencies (3kHz and higher), the noise reduction effect drops in the band lower than the music signal since cutoff slides toward the higher side. To compensate for this, the noise reduction effect is maintained by using a fixed band for the region below 6kHz.

*2. Sliding Band

Compared to full band type noise reduction, even when music signals around 400~1,000Hz exist, sliding band has the superior feature of not degrading the noise reduction effect above 1kHz (hiss noise is concentrated around 1~2kHz) compared to no music signal. This characteristic is employed in the C type.

Therefore, an ideal noise reduction effect throughout the entire band is obtained by combining the two types of processing circuit to utilize the merits of the both systems.

All Dolby NR products are based on the principle of least treatment. While Dolby S NR may sound complicated it is, in principle and practice, the noise reduction system with the least processing in reference to the sonic signal. For this reason, we have employed Dolby S NR in our 380S.

Specifications

Mixer section

INPUT (X12)

Input 1, 2: XLR connector/balanced

MIC impedance	: Less than 600Ω
Input impedance	: Higher than 3kΩ
Rated input level	: MIC-60dBV (1mV)
	LINE-10dBV (0.3V)

Input 1-4: PHONE jack/unbalanced

MIC impedance	: Less than 10kΩ
Input impedance	: Higher than 20kΩ
Rated input level	: MIC-60dBV (1mV)
	LINE-10dBV (0.3V)

Input 5-12: PHONE jack/unbalanced

Input impedance	: Higher than 6kΩ
Rated input level	: -10dBV (0.3V)

AUX RTN 1,2 (L,R): PHONE jack

Input impedance	: Higher than 10kΩ
Rated input level	: -20dBV (0.1V)

Stereo output (L,R): RCA pin jack

Output load impedance	: Higher than 10kΩ
Rated output level	: -10dBV (0.3V)

AUX SEND 1, 2: PHONE jack

Output load impedance	: Higher than 10kΩ
Rated output level	: -10dBV (0.3V)

Monitor output (L,R): PHONE jack

Output load impedance	: Higher than 10kΩ
Rated output level	: -10dBV (0.3V)

Tape output 1-4: RCA pin jack

Output load impedance	: Higher than 10kΩ
Rated output level	: -10dBV (0.3V)

Headphone output (X2): STEREO PHONE jack

Output load impedance	: 8-50Ω
Maximum output	: 25mW

SYNC input: RCA pin jack

Input impedance	: Higher than 5kΩ
Rated input level	: -10dBV (0.3V)

SYNC output: RCA pin jack

Output load impedance	: Higher than 10kΩ
Rated output level	: -10dBV (0.3V)

INSERT input/output: STEREO PHONE jack
SEND (tip)

Output load impedance	: Higher than 10kΩ
Rated output level	: -10dBV (0.3V)

RETURN (ring)

Input impedance	: Higher than 10kΩ
Rated input level	: -10dBV (0.3V)

Equalizer

HIGH	: 10kHz±15dB (Shelving)
MID	: 200Hz-6kHz±15dB (Parametric)
LOW	: 80Hz±15dB (Shelving)
S/N	MIC : 66dB (IHF-A)
	LINE : 76dB (IHF-A)

Frequency response : 20Hz-20kHz

Crosstalk : 60dB (1kHz)

Distortion : Less than 0.05%

Recorder section

Recording tape	: C-60, C-90 (TYPEII/HIGH (CrO ₂) POSITION, TDK SA or MAXELL XLII equivalent)
Recording track	: 4-track one way recording (4-channel simultaneous recording)
Noise reduction	: Dolby S NR type (9.5cm/s: ON-OFF switchable) (4.75cm/s: OFF fixed)
Tape speed	: 9.5cm/s, 4.75cm/s (switchable)
Wow flutter	: +/-0.05% (9.5cm/s)
Fast wind time	: 110 seconds (C-60 tape)
Pitch control	: +/-10% or higher
Recording time	: 22.5 minutes (C-90, 9.5cm/s)
Frequency response	: 40Hz-18kHz (9.5cm/s) 40Hz-12kHz (4.75cm/s)
S/N (Dolby LEVEL=0dB)	: 70dB (CCIR/ARM, 9.5cm/s)
Crosstalk	: 50dB (1kHz)
Distortion	: Less than 1.5% (1kHz, 0dB)
Head	: 4-channel recording/playback 4-channel erase

General

Power supply/power consumption	: 120VAC 60Hz 32W 230V~50/60Hz 32W 240V~50Hz 32W
Weight	: 5.5kg
Dimensions	: 515(W) x 356.7(D) x 110.9 (H)

- * Specifications and appearance of this product subject to change without notice.
- * Dolby noise reduction system manufactured under license from Dolby Laboratories Licensing Corporation.
- * Dolby and the double-D symbol are trademarks of Dolby Laboratories Licensing Corporation.

Block Diagram

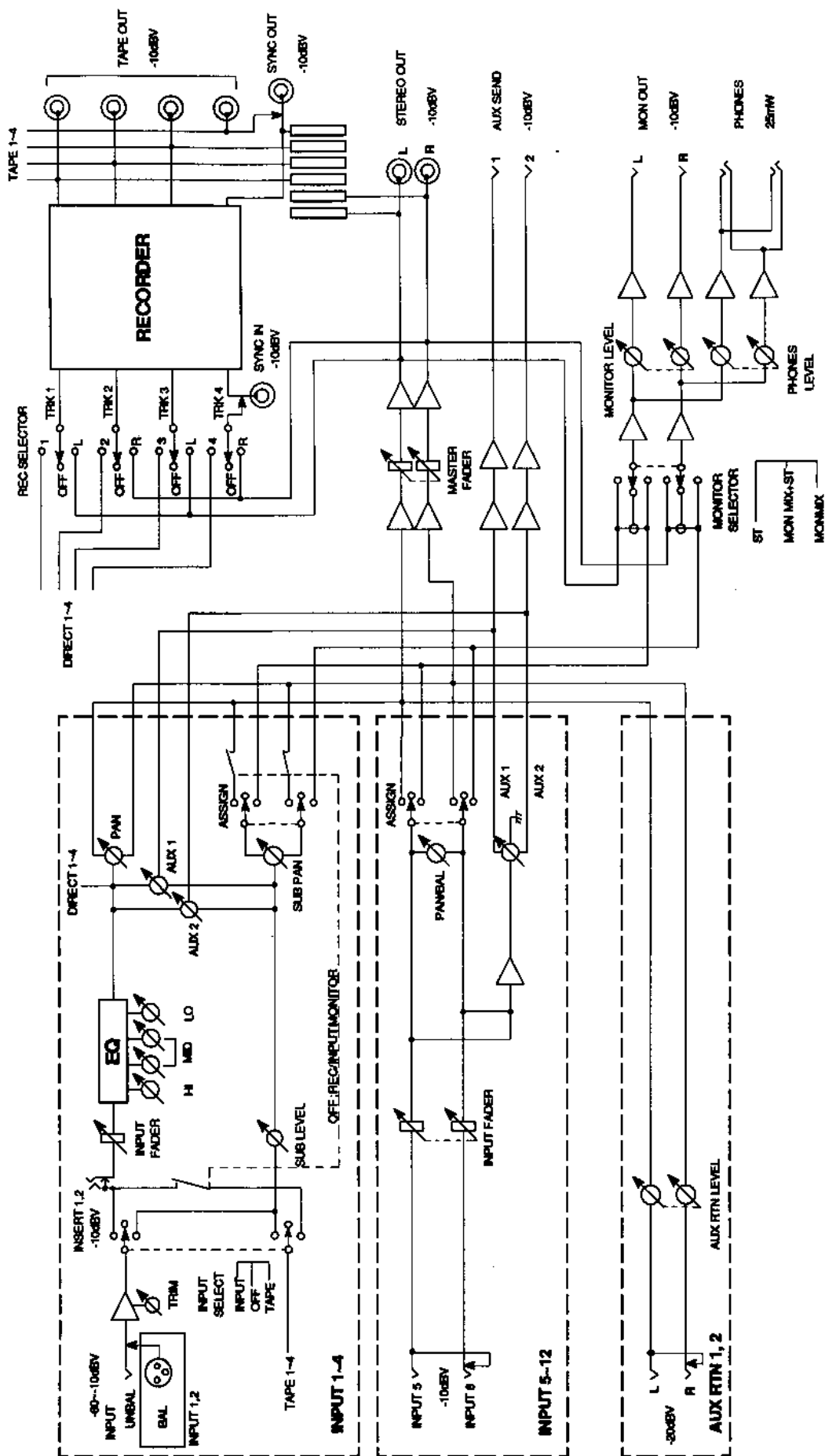

Accessories

Block Diagram

■ Headphones

T20RP



■ Microphone

M301



■ Foot switch

8051



■ Headphones distributor PH5



■ Test tone oscillator

TT15



■ AV compatible personal monitor

6301B (AV)

6301B (XAV)



■ 4-channel color cable (RCA-RCA type)

8041A (1.2m)

8042A (0.5m)

8043A (3.0m)

■ 8-channel color cable (RCA-PHONE type)

8046 (1.5m)

8047 (3.0m)

8048 (4.5m)

Fostex

FOSTEX CORPORATION 3-2-35 Musashino, Akishima-shi, Tokyo, Japan 196

FOSTEX CORPORATION OF AMERICA 15431, Blackburn Ave., Norwalk, CA 90650, U.S.A.

FOSTEX (UK) LTD. Unit 1 Jackson Way Great Western Industrial Park Southall Middx UB2 4SA U.K.

© PRINTED IN JAPAN NOV. 1985 8288 326 100 IM

Download from www.Softmanuals.com. All Manuals Search And Download.

Free Manuals Download Website

<http://myh66.com>

<http://usermanuals.us>

<http://www.somanuals.com>

<http://www.4manuals.cc>

<http://www.manual-lib.com>

<http://www.404manual.com>

<http://www.luxmanual.com>

<http://aubethermostatmanual.com>

Golf course search by state

<http://golfingnear.com>

Email search by domain

<http://emailbydomain.com>

Auto manuals search

<http://auto.somanuals.com>

TV manuals search

<http://tv.somanuals.com>