

Owner's Manual

---

Model  
**D-90**



---

Digital Multitrack Recorder

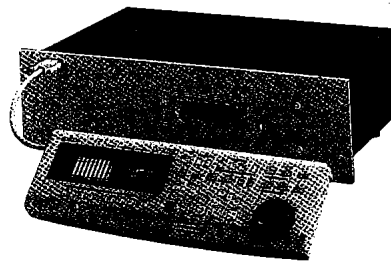
---



**Fostex**

	<p><b>CAUTION</b> RISK OF ELECTRIC SHOCK DO NOT OPEN</p>	
<p>CAUTION: TO REDUCE THE RISK OF ELECTRIC SHOCK, DO NOT REMOVE COVER (OR BACK). NO USER-SERVICEABLE PARTS INSIDE. REFER SERVICING TO QUALIFIED SERVICE PERSONNEL.</p>		
<p><b>CAUTION:</b> TO PREVENT ELECTRIC SHOCK, MATCH WIDE BLADE OF PLUG TO WIDE SLOT, FULLY INSERT.</p>		
<p><b>ATTENTION:</b> POUR ÉVITER LES CHOCS ÉLECTRIQUES, INTRODUIRE LA LAME LA PLUS LARGE DE LA FICHE DANS LA BORNE CORRESPONDANTE DE LA PRISE ET POUSSER JUSQU'AU FOND.</p>		



The lightning flash with arrowhead symbol, within an equilateral triangle, is intended to alert the user to the presence of uninsulated "dangerous voltage" within the product's enclosure that may be of sufficient magnitude to constitute a risk of electric shock to persons.



The exclamation point within an equilateral triangle is intended to alert the user to the presence of important operating and maintenance (servicing) instructions in the literature accompanying the appliance.

### "WARNING"

"TO REDUCE THE RISK OF FIRE OR ELECTRIC SHOCK,  
DO NOT EXPOSE THIS APPLIANCE TO RAIN OR MOISTURE."

### SAFETY INSTRUCTIONS

1. Read Instructions - All the safety and operating instructions should be read before the appliance is operated.
2. Retain Instructions - The safety and operating instructions should be retained for future reference.
3. Heed Warnings - All warnings on the appliance and in the operating instructions should be adhered to.
4. Follow Instructions - All operating and use instructions should be followed.
5. Water and Moisture - The appliance should not be used near water - for example, near a bathtub, washbowl, kitchen sink, laundry tub, in a wet basement, or near a swimming pool, and the like.
6. Carts and Stands - The appliance should be used only with a cart or stand that is recommended by the manufacturer.
7. Wall or Ceiling Mounting - The appliance should be mounted to a wall or ceiling only as recommended by the manufacturer.
8. Ventilation - The appliance should be situated so that its location or position does not interfere with its proper ventilation. For example, the appliance should not be situated on a bed, sofa, rug, or similar surface that may block the ventilation openings, or placed in a built-in installation, such as a bookcase or cabinet that may impede the flow of air through the ventilation openings.
9. Heat - The appliance should be situated away from heat sources such as radiators, heat registers, stoves, or other appliances (including amplifiers) that produce heat.
10. Power Sources - The appliance should be connected to a power supply only of the type described in the operating instructions or as marked on the appliance.
11. Grounding or Polarization - The precautions that should be taken so that the grounding or polarization means of an appliance is not defeated.
12. Power Cord Protection - Power supply cords should be routed so that they are not likely to be walked on or pinched by items placed upon or against them, paying particular attention to cords at plugs, convenience receptacles, and the point where they exit from the appliance.
13. Cleaning - The appliance should be cleaned only as recommended by the manufacturer.
14. Nonuse Periods - The power cord of the appliance should be unplugged from the outlet when left unused for a long period of time.
15. Object and Liquid Entry - Care should be taken so that objects do not fall and liquids are not spilled into the enclosure through openings.
16. Damage Requiring Service - The appliance should be serviced by qualified service personnel when:
  - A. The power supply cord or the plug has been damaged; or
  - B. Objects have fallen, or liquid has been spilled into the appliance; or
  - C. The appliance has been exposed to rain; or
  - D. The appliance does not appear to operate normally or exhibits a marked change in performance; or
  - E. The appliance has been dropped, or the enclosure damaged.
17. Servicing - The user should not attempt to service the appliance beyond that described in the operating instructions. All other servicing should be referred to qualified service personnel.



An appliance and cart combination should be moved with care. Quick stops, excessive force, and uneven surfaces may cause the appliance and cart combination to overturn.

7. Wall or Ceiling Mounting - The appliance should be mounted to a wall or ceiling only as recommended by the manufacturer.

8. Ventilation - The appliance should be situated so that its location or position does not interfere with its proper ventilation.

For example, the appliance should not be situated on a bed, sofa, rug, or similar surface that may block the ventilation openings, or placed in a built-in installation, such as a bookcase or cabinet that may impede the flow of air through the ventilation openings.

## Table of Contents

<b>Introduction</b> .....	6
<b>Precautions</b> .....	6
Notes about power supply.....	6
Notes on handling the hard disk.....	7
Notes on the setup location.....	7
Notes on repair.....	8
About copyrights.....	8
About damages.....	8
Notes on using the Detachable Controller.....	8
How to use a dust cap (included).....	8
<b>Main Features of D-90</b> .....	9
<b>Names and Functions</b> .....	14
Front panel.....	14
Detachable controller.....	15
Rear panel.....	24
Display section.....	26
1. Display shown when the power is turned on.....	26
2. Preset display.....	26
3. Switching the display using the DISP SEL key.....	27
4. Switching the Time Base display using the EXECUTE/YES key and DISP SEL key.....	28
5. Changing Programs using the STORE key and the HOLD/- key.....	29
6. Warning messages.....	30
<b>Before operating the D-90</b> .....	33
1. The difference between a tape-based multitracker and a hard disk multitracker.....	33
2. Input monitor and Repro monitor.....	34
3. Time Base.....	35
4. Installing the hard disk.....	36
Installing a removable hard disk cartridge.....	37
Replacing a removable hard disk cartridge.....	38
Installing a hard disk in removable case Model 9040B.....	39
Formatting a hard disk.....	40
5. Extending the detachable controller.....	41
<b>Recording/Playback</b> .....	43
1. Basic connections.....	43
2. The default setting on the D-90.....	45
2-1. Setting a Program.....	46
2-2. Setting a Sampling Rate.....	47
3. Analog Recording and Playback.....	48
3-1. Basic recording and playback.....	48
3-2. Recording with the Program Change function.....	49
3-3. Playback using the Vari-pitch function.....	51
3-4. Multitrack recording using overdubbing.....	52

3-5. Mixdown.....	53
3-6. Ping-pong recording.....	54
4. Digital Recording.....	55
4-1. Digital recording from an external digital device (S/P DIF).....	55
4-2. Digital recording to an external digital device.....	57
4-3. Connecting a digital mixer.....	59
<b>Locate function.....</b>	<b>61</b>
1. Locate.....	61
2. Auto Play mode.....	62
3. Auto Return mode.....	62
Setting the Auto Return Start/End point.....	63
4. Auto Repeat mode.....	66
<b>Punch In/Out.....</b>	<b>67</b>
1. Auto Punch In/Out.....	68
Storing the Punch In/Out point.....	68
Auto Punch In/Out Rehearsal mode.....	70
Auto Punch In/Out Take mode.....	72
2. Punch In/Out recording using a foot switch.....	73
Punch In/Out Rehearsal.....	74
Punch In/Out Take.....	75
<b>Edit function.....</b>	<b>77</b>
1. Copy & Paste.....	78
Copying.....	78
Copy & Pasting.....	80
Copy & Paste Undo/Redo.....	82
2. Move & Paste.....	83
Moving.....	83
Move & Pasting.....	85
Move & Paste Undo/Redo.....	87
3. Erase & Cut.....	88
Erasing.....	89
Erase Undo/Redo.....	90
Cutting.....	90
Cut Undo/Redo.....	91
<b>Saving/Loading Song Data.....</b>	<b>92</b>
1. Saving data from the DATA OUT connector.....	93
2. Loading data from the DATA IN connector.....	95
3. Saving/Loading data using SCSI.....	97
4. Compatibility with D-80 (V2.0), DMT-8 (V2.0), and DMT-8VL.....	97
<b>MIDI sync function.....</b>	<b>98</b>
1. MIDI clock sync system.....	98
2. MTC sync/MIDI machine control system.....	101
3. Multitrack system by the slave mode.....	104
4. External MIDI equipment sync system by the slave mode.....	108
5. Sync system with "adat" by the slave mode.....	111

<b>Setup mode</b> .....	<b>114</b>
1. Entering Setup mode.....	114
2. Setting the time signature ("BAR").....	118
3. Setting a tempo ("TEMPO").....	120
4. Setting the Metronome function ("CLiCK").....	122
5. Loading song data ("LOAD").....	123
6. Saving song data ("SAVE").....	124
7. Formatting the hard disk ("FORMAT").....	125
8. Setting the preroll time for the locate operation ("PREROLL TIME").....	126
9. Setting MIDI sync signal output ("MIDI SYNC OUT").....	127
10. Setting the MTC frame rate ("FRAME").....	128
11. Setting MTC offset time ("MTC OFFSET").....	129
12. Setting MTC offset mode ("MTC OFFSET ModE").....	130
13. Setting recording Enable/Disable mode ("rEc" ENABLE/DISABLE).....	131
14. Setting a digital input track ("dG in").....	132
15. Setting a digital output track ("dG out").....	134
16. Setting display resolution mode On/Off ("rESoLu").....	135
17. Setting Slave mode("SLAVE").....	136
18. Setting MIDI device ID ("dEVicE").....	138
19. Setting the Undo function range ("Undo").....	139
20. Setting a sampling rate ("FSSEt").....	140
<b>MIDI Implementation Chart</b> .....	<b>141</b>
<b>MMC command list</b> .....	<b>142</b>
<b>Inquiry Message list</b> .....	<b>142</b>
<b>Fostex MIDI System Exclusive Message Format</b> .....	<b>143</b>
<b>Maintenance</b> .....	<b>158</b>
<b>Specifications</b> .....	<b>158</b>

## Introduction

Thank you for purchasing a Fostex Model D-90!

The D-90 is an 8-track digital multitrack recorder with a 3.5-inch E-IDE type removable hard disk. When equipped with an optional 1.3GB removable cartridge Model 9041, the D-90 offers 8-track simultaneous recording, and playback of about thirty minutes (FS: 44.1kHz).

The D-90 enables you to achieve high-quality recording/playback with a quantization of 16-bit and a sampling rate of 44.1kHz, which is approximately equivalent to CD quality. It is also equipped with an adat input and output (available when switched from S/P DIF), and supports a sampling rate of 48kHz. This feature enables various communications with a wide variety of digital mixers.

The adat optical I/Os enable not only 8-track simultaneous recording by sending signals from the adat output of the mixer console, but also allows for digital copy to the Fostex RD-8 or adat. Along with the optional Model 8338 (SCSI interface), the data backup function has been improved. A Vari-pitch function of +/-6% allows you to fine-adjust the pitch without a significant deterioration in quality.

The D-90 has implemented many advanced functions thanks to the incorporation of a hard disk: copy, paste, move, paste, cut, erase (using time value or MIDI bar/beat/clock), and undo/redo. One hard disk can accommodate up to nine Programs (Program Change function), and you can record, play back, edit, and set six non-volatile location memories for each Program.

The D-90 is also equipped with a jog wheel, a shuttle dial for speedy operation, a song data save/load function for an external DAT recorder, and an AUTO function that includes 9-point AUTO locate, AUTO return/play, and AUTO punch in/out (with rehearsal function).

The unit can not only transmit MIDI clock data and Song Position Pointers via the internal programmable tempo map, but also supports MTC and MMC.

You can also machine-control and synchronize an external MIDI sequencer or sequencing software with the D-90. (The D-90 also supports Fostex System Exclusive.)

Please read this User's Guide thoroughly and keep it in a safe place so that you will be able to produce high-definition, high tonal quality music and make the best use of this product for a long time.

## Precautions

### Notes about power supply

- \* Be sure to connect the D-90 to the power supply specified in the Specifications section of this Owner's Manual. Do not use an AC outlet of any other voltage.
- \* Do not connect the D-90 to the same AC outlet to which devices that could generate noise (such as a large motor or dimmer), or the devices that consume a large amount of power (such as an air conditioning system or a large electric heater) are connected.
- \* If you use the unit in an area with a different power voltage, first consult your dealer or the nearest FOSTEX service station. You can use the unit with a power frequency of 50Hz or 60Hz.
- \* It is very dangerous to use a power cord that is frayed or damaged. In such a case, stop using the unit immediately and ask your dealer to repair the cord.

#### D-90 Owner's Manual (Introduction)

- \* To avoid possible electric shock and damage to the D-90, avoid contact with water or other liquids, or do not handle the power plug while your hands are wet.
- \* To prevent possible electric shock and damage to the D-90, do not remove the main unit cover or reach the inside the unit.
- \* Do not let water or other liquid, or metal objects such as pins, accidentally enter the inside of the unit because this may lead to electric shock or damage. Should water enter the inside of the unit, remove the power plug from the AC outlet, and consult your dealer or the nearest FOSTEX service station.
- \* To prevent damage to the D-90, be sure to power on the connected devices first, then turn on the power to the D-90. When you remove or connect the cables to the input/output connectors on the D-90, make sure that the channel INPUT faders and volume controls are set to "0."

#### Notes on handling the hard disk

- \* The D-90 is equipped with a high-precision hard disk. Do not expose the unit to excessive vibration at any time. In particular, do not move the unit or allow an impact to the unit when the power is on.
- \* **Before turning the power off to the D-90, first quit Setup mode and make sure that the recorder section is stopped. Especially, never attempt to turn off the power to the unit while the hard disk is accessing data (the HD ACCESS LED is lit or flashing). Otherwise, not only will you lose recorded data, but you may damage to the unit. FOSTEX is not responsible for data lost during operation of the unit.**
- \* Before you change the location of the D-90, pack the unit in the shipping carton or an impact-resistant case. Make sure that the unit is kept free from external vibration or impact since the unit is very sensitive to vibration.
  - \* If you wish to replace the included removable hard disk with another hard disk, refer to "Before operating the D-90" on page "36."

#### Notes on the setup location

- \* Do not install the unit in locations subject to the following:
  - \* Extremely high or low temperature, or significant changes in temperature
  - \* Excessive humidity or dust
  - \* Excessive changes in power supply voltage
  - \* Unstable or significantly vibrating or shaking surfaces
  - \* Near a strong magnetic field (such as a TV or speakers)
- \* If you move the unit from a place with an excessively low temperature to a warm place, or if you use the unit in a room in which the temperature varies significantly during winter, condensation may occur on the hard disk or other parts. In such cases, leave the unit for about an hour in the new location before you turn on the power.

*D-90 Owner's Manual (Introduction)*

**Notes on repair**

- \* This unit does not use any parts that users can repair easily. Contact your dealer or the nearest FOSTEX service station to ask about repairs.
- \* Use the packing carton designed for the D-90 when you transport the unit to the dealer for repair or return.  
If you have discarded the packing box, try to pack the unit completely using shock absorbing materials. Fostex is not responsible for malfunction or damage due to incomplete packaging or caused during transport.

**About copyrights**

- \* It is prohibited by law to use any part of a CD recording or video images or audio data for which copyright is possessed by a third party for commercial purposes such as contents, broadcasts, sales, or distribution - any purpose other than for your personal pleasure.

**About damages**

- \* Fostex is not responsible for any "direct damage" or "indirect damage" caused by using the D-90.

**Notes on using the Detachable Controller**

- \* When you use the detachable controller remotely using an extension cable, the D-90 may malfunction due to electromagnetic interference. In this case, turn the power off, then on to the D-90 to restore the normal condition.  
Fostex is not responsible for malfunction of the D-90 caused by electromagnetic interference.

**How to use a dust cap (included)**

- \* Plug the included dust cap onto the connector of the D-90's removable hard disk to protect the disk from static electricity, dust and dirt before you store or transport the hard disk.

**<WARNING>**

A hard disk is precision device. Handle it with care and avoid vibration, humidity, strong magnetic fields, static electricity, dust, etc.  
In particular, do not touch the connector with your hands to protect the hard disk from static electricity.

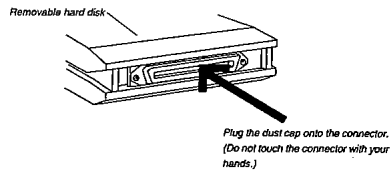



## **Main Features of D-90**

The D-90 is equipped with the following functions:

### **High-quality sound, 8-track digital hard disk recorder**

- \* The D-90 employs a 3.5-inch IDE type hard disk as a recording media, instead of conventional tapes. An optional Model 9041 (1.3GB removable hard disk cartridge) allows you to record or play back up to about thirty minutes.
- \* Containing "adat" input/output ports (switchable between S/P DIF), a full digital recording system can be realized (also possible of simultaneous digital 8 track record/play) by direct digital connection with various types or digital mixer.
- \* The D-90 enables you to achieve high-quality recording/playback with 16-bit quantization, a sampling rate of 44.1kHz, and non-compression recording method, which is approximately equivalent to CD quality. It also supports a sampling rate of 48kHz. (You can switch the frequency value in the "FS SET" menu of Setup mode.)

### **Removable hard disk**

- \* The standard hard disk that comes with the D-90 is removable, allowing you to easily replace it with another hard disk from the front panel. Using a larger hard disk (more than 850MB) will extend available recording time, expanding the D-90's recording and editing capabilities.

### **Managing up to five programs using the Program Change function**

- \* Using the Program Change function allows you to record, play back, and edit up to nine songs individually on the hard disk. The optional Model 9041 (1.3GB removable hard disk cartridge) allows for 30 minutes of recording time in total for nine programs.)  
In this way, you can utilize the hard disk to manage different programs at any time, without the necessity of archiving (backing up) data to an external DAT machine or adat.

### **Versatile editing functions are made possible by the hard disk**

- \* The D-90 allows you to use non-linear, non-destructive audio editing functions, such as copy & paste, move & paste, cut, and erase. These edit operations can refer not only to time values such as ABS and MIDI timecode, but to MIDI bar/beat/clock values.
- \* You need only one action to monitor the copied audio data using the Clipboard Play function.
- \* The Over Time Monitor function lets you know the overtime length when you try to copy & paste or move & paste data in excess of the currently-available disk space.

### **Undo/Redo function to support edit works**

- \* The Undo/Redo functions will cancel the latest edit and restore the data obtained before the edit, or restore the data obtained after the edit respectively.

*D-90 Owner's Manual (Main features of D-90)*

- \* The Can't Undo function provides you with an alarm indicating that the undo area is insufficient for the Auto Punch In/Out operation.

**Song data Save/Load function**

- \* You can save the recordings (audio data plus Setup data) on the hard disk to a DAT machine or an Adat. You can do so for each Program or for all data included on the hard disk. It is also possible to load D-90 data saved on a DAT machine or an Adat into Programs 1-9 on the internal hard disk.

Installing the optional SCSI interface Model 8338 allows you to save and load data to and from an external SCSI device.

**Convenient Disk Remain Display function**

- \* The Disk Remain function facilitates checking the available recording time. This function is compatible with all types of time references - ABS, MTC, MIDI bar, and beat.

**Three types of time reference**

- \* The 10-digit, 7-segment display shows the current time (position) of the recorder using ABS time, MIDI timecode, or MIDI bar/beat.
- \* ABS and MTC function with sub-frame precision (1/100 frame), and the MIDI bar/beat is 96 clock precision. These are used for data display and the memory register.

**Various Auto functions**

- \* The D-90 has six editable, non-volatile time memory locations, which enable you to perform the Auto locate function, the Auto Return/Auto Play function between two points, and the Auto Punch In/Out function (crossfade time: 10ms).

These functions can be set for each Program, and their settings will be retained after you turn off the power to the unit.

- \* Auto locate to ABS 0 or ABS END is also possible. In addition, the LOCATE key has its own memory. This is very useful for a repeated locate operation.

- \* There are two modes for Auto Punch In/Out function: "Take" mode, which is used for actual recording, and "Rehearsal," which is used to switch the part located between the In and Out points to the input monitor.

- \* The Pre-roll function is used to "park" a specified time prior to the locate point. Pre-roll time can be set in the range of 0 - 10 seconds.

**MIDI function using MMC, MTC, and Fostex System Exclusive**

**Message**

- \* You can add an offset of less than six hours to the ABS time value to output MTC (MIDI timecode). The MTC frame rate is compatible with all formats - 24, 25, 30DF, and 30ND.

- \* The D-90 responds to MMC (MIDI Machine Control) and Fostex System Exclusive Message sent from external sequencing software.

**Syncing multiple D-90s by the Slave Sync function**

- \* The Slave Sync function allows you to operate multiple D-90s in synchronization, creating more than 8 to 24-track recording system.

**Internal programmable Tempo Map**

- \* The D-90 is equipped with an internal programmable Tempo Map that allows the MIDI clock and Song Position Pointer to be transmitted to an external sequencer (switchable to MTC output) for complete synchronization with a hardware sequencer. You can also use Track 8 as a Metronome playback track, which will generate counts according to a Tempo Map.
- \* Eleven types of Tempo Map signature are available: 1/4, 2/4, 3/4, 4/4, 5/4, 1/8, 3/8, 5/8, 6/8, 7/8, and 8/8. Maximum 64 points of signature can be set.
- \* Up to 64 points of tempo on a Tempo Map can be set on any point determined by the signature settings, in the range of 30 - 250 per quarter note.

**Setup Menu function**

- \* The D-90 is equipped with the following setup Menu functions for the interactive operation system. You can use a highly visible FL tube display and the jog/shuttle dial to set the parameters.

**Main Setup Menu**

**LOAD** (loading audio and setup data)  
**SAVE** (saving audio and setup data)  
**FORMAT** (formatting the internal hard disk)  
**PREROLL** (setting the Pre-roll time)  
**MIDI SYNC OUT** (selecting MTC, MIDI clock, or OFF)  
**FRAME RATE** (setting the MTC frame rate)  
**MTC OFFSET** (setting the MTC offset value against the ABS time)  
**MTC OFFSET MODE** (setting the MTC offset mode)  
**BAR/BEAT SET** (setting the signature)  
**TEMPO SET** (setting the tempo)  
**CLICK ON/OFF** (switching the Metronome function ON/OFF)  
**REC ENABLE** (setting the REC ENABLE or REG DISABLE)  
**dG in** (selecting a digital input channel)  
**dG out** (selecting a digital output channel)  
**RESOLu** (setting Display Resolution mode ON/OFF)  
**SLAVE [TYPE]** (setting Slave mode [MTC] ON/OFF)  
**DEVIcE** (setting a device ID)  
**FS SET** (setting the Sampling Frequency)  
**undo** (setting an effective range of the Undo function)

**Easy-to-use jog/shuttle dial**

- \* Using the shuttle dial allows for +/-1, 2, 3, 5, 9, 12, or 20-time speed cueing (fast-forward while monitoring audio).
- \* Using the jog dial allows for digital audio scrubbing. Using this function, you can locate data efficiently while monitoring audio without any changes in pitch.
- \* The jog/shuttle dial is also used to recall parameters and to enter data.

**An easy-to-use detachable controller**

- \* The D-90 is equipped with a detachable controller useful not only for remote control but for checking all information at hand. Using an optional extension cable (Model 8551 5m) allows for remote control from a maximum of 10 meters away.

**<WARNING>**  
When you use the detachable controller remotely using an extension cable, the D-90 may malfunction due to electromagnetic interference.  
In this case, turn the power off, then on to the D-90 to restore the normal condition.  
Fostex is not responsible for malfunction of the D-90 caused by electromagnetic interference.

**Other recorder functions**

- \* Contains a +/- 6% variable pitch control function which allows delicate control of pitch with the least amount of sound deterioration.
- \* This can also comply to 8 channels of balanced analog inputs and outputs by installing the optional Model 5040 balanced 8-8 I/O card (To be released soon).
- \* In addition to 30-time speed FF/REW, 5-time speed cueing (PLAY+FF/REW) is also available.
- \* Connect an optional foot switch Model 8051 to the PUNCH IN/OUT connector for punch in/out (and rehearsal) operation to free your hands.
- \* A highly visible FL-tube level meter shows the output level of Tracks 1-8.
- \* The D-90 can record data digitally to and from an external digital device (DAT, MD, adat etc.).

FRONT PANEL

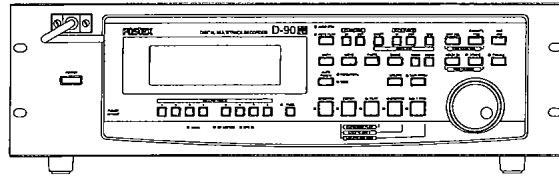

REAR PANEL

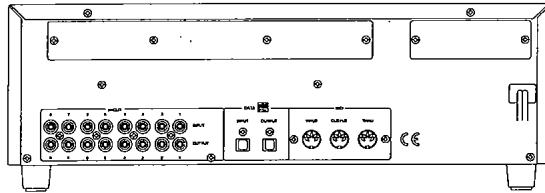

## Names and Functions

<Front Panel (with the detachable controller removed)>

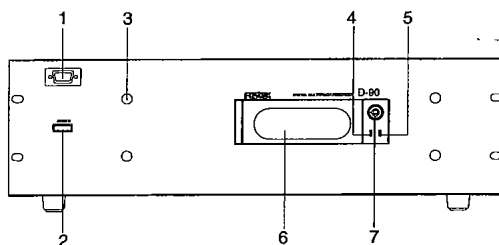

### 1. Detachable remote controller connector

The detachable remote controller is connected here. You can remove the controller. Connect an optional extension cable (Model 8551) to extend the distance.

# Refer to page "41" for information on extending the detachable remote controller connection.

### 2. Power switch

This switch turns the main power to the D-90 on/off.

#### <WARNING >

Before turning the power off to the D-90, first quit Setup mode and make sure that the recorder section is stopped. Especially, never attempted to turn off the power to the unit while the hard disk is accessing data (the HD ACCESS LED is lit or flashing). Otherwise, not only will you lose recorded data, but you may damage to the unit.

### 3. Controller mount

The detachable remote controller is mounted on the front panel.

### 4. Hard disk access LED

This LED lights up or blinks when the hard disk is writing or reading data. (Same as the HD ACCESS LED on the detachable remote controller.)

### 5. Hard disk power LED

This LED lights up if the hard disk operates correctly when you turn the power on to the unit. If the Lock key is not locked, the power to the hard disk will not be turned on, and the LED will not light up.

### 6. Removable hard disk cartridge slot

This slot is used to insert a removable hard disk cartridge. This system allows you to replace the hard disk easily.

# Refer to page "38" for more information on how to replace the removable hard disk cartridge.

#### <Note>

This slot is covered by a dust-proof panel when the unit is shipped from the factory. Remove this panel in order to insert a cartridge.

**<Note>**  
 The D-90 package contains a removable case (without a hard disk). Install your hard disk in this removable case.  
 The optional Model 9041 (1.3GB removable hard disk cartridge) contains a hard disk, which allows you to record and play back about 30 minutes of data (FS: 44.1kHz) without having to install a case.

\* Refer to page "36" for more information on the hard disk models that have already been tested for operation on the D-90.

**7. Lock/Unlock key**

When you remove or install the hard disk cartridge, you need to lock/unlock here using the included key. Be sure to turn the power off to the D-90 before locking or unlocking.

**<Note>**  
 If the key is not locked, the power to the hard disk will not be turned on.  
 After installing the hard disk, be sure to lock the key using the included key.

**<Detachable Controller>**

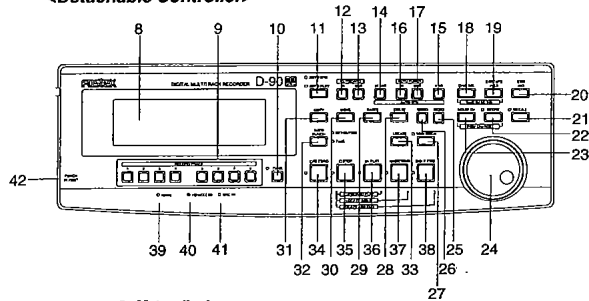

**8. Meter display**

This meter display shows the signal level and settings.

\* Refer to the "Display section" on page "26."

**9. Record Track Select key [RECORD TRACK]**

The Record Track Select key selects "SAFE-READY" for the recording track.  
 When you press this key once, the track enters the READY status, and the track indication on the display will blink. Pressing it again changes this status to "SAFE" and the track indication will go out. When you start recording, the blinking track indication becomes illuminated.

When you press only the RECORD button while the track is in the READY status, the track becomes an input monitor, allowing you to adjust the recording level.  
 Pressing only the RECORD button again, the track become a reproduction monitor.  
 This key is also used to select a track for the Copy & Paste, Move & Paste, Erase, or other editing operation.

\* Refer to page "34" for details about the reproduction monitor and the input monitor.

### 10. Function key [FUNC]

When you configure the sync system using multiple D-90s, use this key to select a "SAFE-READY" recording track of the slave machine from the master machine, and to perform the MMC REC Track Select function. In general, use this key when its LED is turned off.

\* Refer to page "104" for more information on the sync system using multiple D-90s.

### 11. Auto Play/Auto Return key

Pressing this key repeatedly will change Auto Play mode, Auto Return mode, and Repeat mode On/Off as follows: (○: LED off, ●: LED light up)

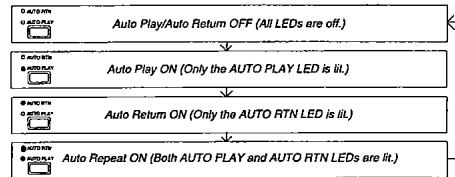

#### Auto Play mode:

In this mode, playback will start automatically after the START point is located. This function is effective at any locate points other than the ABS END point.

#### Auto Return mode:

When the END point is reached during playback, the START point is automatically located in this mode. This function is effective only when the START and END points have been specified.

#### <Note>

Auto Return function is effective only during playback. In recording mode, the START point will not be located automatically when the END point is reached.

#### Auto Repeat mode:

This mode is a combination of Auto Play and Auto Return, and plays back the part between the START and END points repeatedly. The auto repeat function is effective only when the START and END points have been specified correctly.

\* Refer to page "66" for details.

### 12. Clipboard In key [CLIPBOARD IN]

This key is used to store and recall an In point (CLIPBOARD IN point) for the Copy or Move operation. You can locate a stored CLIPBOARD IN point.

\* Refer to page "77" for copying/moving data.

\* Refer to page "78" for locating the CLIPBOARD IN point.

### 13. Clipboard Out key [CLIPBOARD OUT]

This key is used to store and recall an Out point (CLIPBOARD OUT point) for the Copy or Move operation. You can locate a stored CLIPBOARD OUT point.

\* Refer to page "78" for locating the CLIPBOARD OUT point.

\* Refer to page "77" for copying/moving data.

### 14. Auto Return Start key [AUTO RTN START]

This key is used to store and recall a start point (AUTO RTN START point) for the Auto Return or Auto Repeat operation.

You can locate a stored AUTO RTN START point.



\* Refer to page "61" for more information about Auto Return and Auto Repeat.

**15. Auto Return End key [AUTO RTN END]**

This key is used to store and recall an end point (AUTO RTN END point) for the Auto Return or Auto Repeat operation.

You can locate a stored AUTO RTN END point.

\* Refer to page "61" for more information about Auto Return and Auto Repeat.

**16. Auto Punch In key [AUTO PUNCH IN]**

This key is used to store and recall a recording end point (AUTO PUNCH IN point) for the Auto Punch IN/OUT operation. This point is also used as an erase point.

You can locate a stored AUTO PUNCH OUT point.

\* Refer to page "66" for more information about Auto Punch In/Out recording.  
\* Refer to page "77" for more information about pasting data.  
\* Refer to page "88" for more information about the Erase and Cut operations.

**17. Auto Punch Out key [AUTO PUNCH OUT]**

This key is used to store and recall a recording end point (AUTO PUNCH IN point) for the Auto Punch IN/OUT operation. This point is also used as an erase point.

You can locate a stored AUTO PUNCH OUT point.

\* Refer to page "66" for more information about Auto Punch In/Out recording.  
\* Refer to page "88" for more information about the Erase operation.

Memory keys (CLIPBOARD IN, CLIPBOARD OUT, AUTO RTN START, AUTO PUNCH IN, AUTO PUNCH OUT, and AUTO RTN END keys) have the following common functions:

- \* Pressing a Memory key to recall the point that the key is storing (or pressing the RECALL key, then the Memory key) displays the memory data (time, or bar/beat/clock) currently stored in that key; then the unit enters data edit mode. To edit data, use the HOLD/> key or the SHUTTLE dial to move among the digits, then use the JOG dial to change the value.
- \* After you finish editing data, press the STORE key, then press one of the Memory keys into which you want to store the point. The edited data will be stored in the specified Memory key.
- \* While the current position of the recorder is indicated, press the STORE key, then one of the Memory keys into which you want to store the data. The current position or the recorder will be stored in the Memory key. You can do this while the recorder is running or stopped.
- \* Press a desired Memory key, then press the LOCATE key to locate the point stored in that Memory key (time, or bar/beat/clock).
- \* All memory data can be stored to Programs 1-9 individually.
- \* In Setup mode, you can save or load song data for each Program.
- \* All data will be retained after you turn off the power.

# Refer to page "61" for more information on memory data.  
# Refer to page "61" for more information on the Locate function.  
# Refer to pages "33" and "46" for more information on the Program Change function.  
# Refer to page "92" for more information on saving and loading song data.

**18. Display Select key [DISP SEL]**

This key is used to change the display mode. Pressing this key repeatedly will change the display mode as follows:

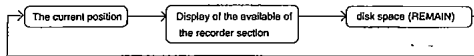

\* Refer to page "27" for more information about the REMAIN.

Pressing this key while holding down the EXECUTE key will switch the Time Base (\*) as follows. The Time Base can be set when the display shows the recorder's current position or the available disk space (REMAIN).

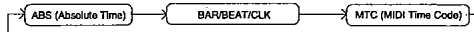

**(\*) Time Base:**

The D-90 uses time display (ABS or MTC) or Bar/Beat/Clock display to indicate the current position of the recorder section. These displays are called "Time Base." ABS (Absolute Time) shows the absolute time of the disk, and MTC (MIDI Timecode) shows the relative time obtained by adding an MTC offset value to the ABS value. Bar/Beat/Clock (BAR/BEAT/CLK) indicates a position within a piece of music and conforms to the MIDI clock and Song Position Pointers created on the Internal Tempo Map.

\* Refer to pages "98", "118" and "120" for more information about MTC and the Internal Tempo Map.

**19. Execute/Yes key [EXECUTE/YES]**

Press this key to execute the operation when you try to edit data on the hard disk using the edit functions such as Paste and Erase, when you put the D-90 into SETUP mode, or when you set the parameters in the SETUP menu. Pressing the DISP SEL key while holding down the [EXECUTE/YES] key allows you to select the Time Base. (Refer to the explanation about the DISP SEL key.)

\* Refer to page "77" for more information about using this key for the Paste or Erase operation.  
\* Refer to page "114" for more information about using this key in SETUP mode.

**20. Exit key/No key [EXIT/NO]**

Contrary to the EXECUTE/YES key, this key is used to stop the operation.

\* Refer to page "77" for more information about using this key for the Paste or Erase operation.  
\* Refer to page "114" for more information about using this key in SETUP mode.

**21. Recall key [RECALL]**

Press this key to recall the stored time value (or Bar/Beat/Clock value). Pressing this key, then one of the following keys will display the data stored at the key you pressed, and you will be able to edit the data.

RECALL key -> CLIPBOARD IN key	The Clipboard in point is recalled and the unit enters edit mode.
RECALL key -> CLIPBOARD OUT key	The Clipboard Out point is recalled and the unit enters edit mode.
RECALL key -> AUTO PUNCH IN key	The Auto Punch in point is recalled and the unit enters edit mode.
RECALL key -> AUTO PUNCH OUT key	The Auto Punch Out point is recalled and the unit enters edit mode.
RECALL key -> AUTO RTH START key	The Auto Return Start point is recalled and the unit enters edit mode.
RECALL key -> AUTO RTH END key	The Auto Return End point is recalled and the unit enters edit mode.
RECALL key -> LOCATE key	The Locate key data is recalled and the unit enters edit mode.

To exit edit mode, press the EXIT/NO key, DISP SEL key, or STOP button.

\* Refer to page "77" for more information about the clipboard.  
 \* Refer to page "67" for more information about Auto Punch In/Out recording.  
 \* Refer to page "61" for more information about Auto Return.

**22. Store key [STORE]**

This key is used to store a time value (or Bar/Beat/Clock value) to one of the memory keys. Pressing this key, then one of the following keys will cause the data shown on the display to be stored to the corresponding memory key you pressed. Pressing the STORE key while holding down the HOLD/> key will change a Program.

STORE key -> CLIPBOARD IN key	Data is stored as a Clipboard In point. The stored data can be used as a locator.
STORE key -> CLIPBOARD OUT key	Data is stored as a Clipboard Out point. The stored data can be used as a locator.
STORE key -> AUTO PUNCH IN key	Data is stored as an Auto Punch In point. The stored data can be used as a locator.
STORE key -> AUTO PUNCH OUT key	Data is stored as an Auto Punch Out point. The stored data can be used as a locator.
STORE key -> AUTO RTN START key	Data is stored as an Auto Return Start point. The stored data can be used as a locator.
STORE key -> AUTO RTN END key	Data is stored as an Auto Return End point. The stored data can be used as a locator.
STORE key -> LOCATE key	Data is stored as a LOCATE key data.

After pressing this key, if you change your mind and wish to cancel the store operation, press the EXIT/NO key, DISP SEL key, or STOP button.

\* Refer to page "77" for more information about the clipboard.  
 \* Refer to page "33" and "46" for more information about Program Change function.  
 \* Refer to page "61" for more information about the Locate function.  
 \* Refer to page "67" for more information about Auto Punch In/Out recording.  
 \* Refer to page "61" for more information about Auto Return.

**23. Hold/Digit Move key [HOLD/>]**

Pressing this key while the recorder transport is operating will hold the time value (or Bar/Beat/Clock value), display the value on the screen, and will place the unit into edit mode. (If you press this key while the recorder section is stopped, the D-90 will enter edit mode.) Pressing this key repeatedly allows you to select the digit (column) to edit. To cancel edit mode, press the STOP button, DISP SEL key, or EXIT/NO key. Pressing the STORE key while holding down the HOLD/> key will change a Program.

\* Refer to pages "63" and "68" for more information about using this key.

**24. Jog/Shuttle dial**

**Jog dial (inside):**  
 Turning the JOG dial while the recorder is stopped performs digital scrubbing in either direction, which allows you to check the audio and locate a point without any change in pitch.

The JOG dial is also used to change values in data edit mode or when the pitch data is displayed. It also allows you to select a parameter to set in Setup mode.

**Shuttle dial (outside):**  
 Turning this dial performs as cueing in either direction at +/- 1, 2, 3, 5, 9, 12, or 20-times speed. In data edit mode, it is used to move among the digits.

\* Refer to pages "63, 68 and 80" for more information about the editing the memory data.  
 \* Refer to page "114" for more information about Setup mode.

**25. Redo key [REDO]**

Pressing this key after you press the UNDO key lets you to restore the status obtained before you undo recording or editing. This key is activated only when the recorder transport section is stopped.

\* Refer to pages "82, 87, and 90" for more information about the Redo operation.

**26. Undo key [UNDO]**

After using an edit function such as Paste, Erase, or Cut, or after auto punch in/out recording, pressing this key will restore the previous status obtained before editing or recording. This key is activated only when the recorder transport section is stopped.

\* Refer to pages "82, 87, and 90" for more information about the Undo operation.

**27. Erase key [ERASE]**

This key has two functions: the Erase function, which erases data (creates silence) within a specified region on the readied track. The other is the Cut function, which cuts data from the region beginning at the specified point. Pressing this key when all tracks are ready will activate the Cut function. Pressing this key while one or more tracks are safe will activate the Erase function.

A region to be erased is defined between the Auto Punch In point and the Auto Punch Out point. A region to be cut is defined only by the Auto Punch In point. This Cut operation requires only the start point of the region to be cut, that is, the Auto Punch In point. Specify the area to be erased, using the Auto Punch In/Out points and the RECORD TRACK select key. To use the Cut function, set all tracks to the ready condition, and set the start point of the data to be cut as the Auto Punch In point.

This key is activated only when the recorder transport section is stopped.

\* Refer to page "88" for more information about the Erase/Cut operation.

**28. Vari-pitch key [VARI PITCH]**

Use this key to turn the Vari-pitch function on and off. When this function is enabled, the corresponding LED lights up. When this function is disabled, the LED turns off. The range of pitch variation for playback and recording is +/-6.0% in 0.1% steps.

Press the RECALL key, then the VARI PITCH key to display the current pitch data. To change the pitch data, use the JOG dial to change the value while the pitch data is displayed.

You can also change the playback speed when the data is being played back with the Vari-pitch function ON.

\* To quit the pitch data display, press the EXECUTE/YES key, the EXIT/NO key, or the STOP button.

**<Note>**

Even when the vari-pitch data is set to 0.0%, pressing this key will turn the LED on.

**<Note>**

You cannot change the pitch data while recording. If the Vari-pitch function has been on, the unit will use the pitch data previously set.

**<Note>**

The Vari-pitch function will be automatically turned off under the following situations:

\* When you turn on the power to the unit (The pitch data will be reset to 0.0%.)

\* When you set Slave mode ON. (The pitch data remembers the previous setting.)

\* When you set up the digital input tracks and "DIGITAL" appears on the display. (The pitch data remembers the previous setting.)

# Refer to page "51" for more information on the Vari-pitch function.

# Refer to page "104" for more information on Slave mode.

# Refer to page "55" for more information on digital signals.

**29. Paste key [PASTE]**

Press this key to copy data or move data that has been copied to the clipboard to a location stored at the AUTO PUNCH IN key. The data will be pasted at the point stored in the Auto Punch In key. You can select the paste destination track using the RECORD TRACK select key. A destination track to which data is pasted is identical to the source track. This key is activated only when the recorder transport section is stopped.

\* Refer to page "77" for more information about the Copy & Paste, and Move & Paste operation.

**30. Move key [MOVE]**

This key is used to enter into the clipboard data stored in memory by the CLIPBOARD IN/OUT keys. Pressing the MOVE key will store the data in the Clipboard as Move data. To enter data to be moved, one or more tracks must be readied, and a correct value must be stored for the In and Out points. If you attempt to enter data when all tracks are safe, all track indications and "SELECT trk" indication on the display will blink to warn you. If a correct value is not set for the Clipboard In or Out, a warning message of "Void In" or "Void Out" will appear.

\* Refer to page "77" for more information about the Copy & Paste, and Move & Paste operation.

**31. Copy key [COPY]**

This key is used to copy data stored in the memory using the CLIPBOARD IN/OUT keys. Pressing the COPY key will store the data in the Clipboard as Copy data. To execute the copy operation, one or more tracks must be readied, and a correct value must be stored for the In and Out points. If you attempt to copy data when all tracks are safe, all track indications and a "SELECT trk" indication on the display will blink to warn you. If a correct value is not set for the Clipboard In or Out points, "Void out" warning will appear.

\* Refer to page "77" for more information about copying data.

**32. Auto Punch Mode On/Off key [AUTO PUNCH]**

Switch this key ON for auto punch In/out. When you press this key while a correct value is stored to the AUTO PUNCH IN key and the AUTO PUNCH OUT key, both the REHEARSAL LED and TAKE LED will blink, indicating that Auto Punch mode is on. (If a correct value is not stored, pressing the AUTO PUNCH key will not turn the parameter ON, and the message "Void Out" will appear.) Pressing the PLAY button under this condition will put the unit into "Rehearsal mode" for Auto Punch In/Out recording. Pressing the PLAY button and RECORD button simultaneously will put the unit into "Take mode." There are five combinations of the REHEARSAL LED and TAKE LED that indicate the status of the unit regarding auto punch recording:

<Note>  
If the correct value is not stored, pressing the AUTO PUNCH key will not enable the function, and the message "Void Out" will appear.

Auto Punch mode OFF	Both REHEARSAL LED and TAKE LED are off.
Auto Punch mode ON	Both REHEARSAL LED and TAKE LED are blinking.
Auto Punch Take mode	Only the TAKE LED (red) is lit.
Auto Punch Rehearsal mode	Only the REHEARSAL LED (green) is lit.
Rehearsal mode entered by means of MMIC or foot switch	Only the REHEARSAL LED (green) is blinking.

\* Refer to page "67" for more information about the Punch In/Out.

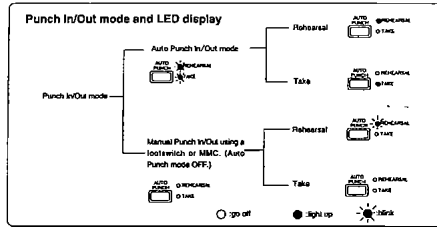

### 33. Locate key [LOCATE]

Press this key to locate a position.

You can locate a point (memory data) (time, or bar/beat/clock) stored in the Memory keys when you press a Memory key (CLIPBOARD IN, CLIPBOARD OUT, AUTO RTN START, AUTO PUNCH IN, AUTO PUNCH OUT, or AUTO RTN END), then press the Locate key.

The data stored in the Locate key is the most-recently located position expressed as a time value (bar/beat/clock). If you wish to locate the same point repeatedly, press this key repeatedly. If you locate a position at a different time value or bar/beat/clock value, the data will be updated. Pressing the RECALL key, then the LOCATE key will display the data stored in the LOCATE key (time or bar/beat/clock) displayed, and cause the unit to enter data edit mode. To edit the data, use the HOLD/> key or the SHUTTLE dial to move around the digits, then use the JOG dial to change the value.

When you finish editing the data, you can store a particular locate point by pressing the STORE key, then the LOCATE key. You can also store a locate point by pressing the STORE key, then the LOCATE key while the recorder's current point is shown. Also, pressing the HOLD/> key to enter data edit mode, and pressing the LOCATE key when you finish editing, will allow you to locate the edited position (bar/beat/clock) directly. This data can be stored individually to each Program P1-P9.

In SETUP mode, you can also save and load the song data to and from each Program individually. The data will be retained after you turn off the power to the unit.

\* Refer to page "61" for more information about the Locate function.

### 34. Record button [RECORD]

Pressing only this button places the readied tracks into Input monitoring status. Pressing this button again will reset the tracks to playback monitoring. (The RECORD LED will blink when the readied tracks are under the Input monitoring status.) Pressing the PLAY button while holding down this button will place the readied tracks into recording. At this time, the PLAY LED and RECORD LED will be lit, and the readied track indication will be lit steadily (instead of blinking).

\* Refer to page "24" of the "Before Starting" section for more information about input monitoring and reproduce monitoring.

### 35. Stop button [STOP]

Pressing this button will stop the transport section of the recorder. Pressing the PLAY, REWIND, or F FWD button while holding down this button will cause the D-90 to perform the following operation:

STOP + PLAY	Clipboard playback (The STOP LED will flash and the PLAY LED will light up.) *3
STOP + REWIND	Locate ABS 0 *4
STOP + F FWD	Locate ABS END *5

## D-90 Owner's Manual (Names and Functions)

Pressing the STOP button will abort the editing operation and display the current position of the recorder, if you wish to:

- \* quit the data edit mode,
- \* cancel the recall or store operation,
- \* quit the pitch data display,
- \* cancel the edit operation, such as pausing, or
- \* cancel the SETUP menu settings.

Pressing the foot switch while holding down this button allows you to turn the punch in/out rehearsal mode ON/OFF.

### \*9 Clipboard playback:

The D-90 plays back the copy data or move data for the Clipboard. During audio playback of the copy or move data, the LCD will display the time length and data type ("COPY" or "MOVE"), and the copy or move source track indicator will flash, enabling you to quickly determine the track and data type.

### \*4 Locate ABS 0:

The D-90 will locate the top of the selected Program (ABS TIME: 00M 00S 00F).

### \*5 Locate ABS END:

The D-90 will locate the end of the selected Program (the end value of ABS TIME).

- \* Refer to page "35" of the "Before Starting" section for more information about ABS 0 and ABS END.
- \* Refer to page "73" for more information about Punch In/Out recording using the foot switch.

### 36. Play button [PLAY]

Pressing this button will cause the recorder to play back data.

Pressing this button while holding down the RECORD button will start recording.

Pressing this button while holding down the STOP button will perform the Clipboard playback operation. (Refer to the section "STOP Button" for more information on the Clipboard playback.)

Pressing the PLAY button during recording will stop recording.

### 37. Rewind button [REWIND]

Pressing this button while the recorder section is stopped will rewind data at 30 times speed. Pressing this button in Play mode will cue data (you can hear sound while rewinding) at five times speed.

Pressing this button while holding down the STOP button will perform the "LOCATE ABS 0" operation, and immediately locate the beginning of the hard disk (ABS TIME: 00M:00S:00F). (Refer to the "STOP button" section for more information about LOCATE ABS 0.)

### 38. Fast Forward button [F FWD]

Pressing this button while the recorder section is stopped will fast forward data at 30 times speed. Pressing this button in Play mode will cue data (you can hear sound during the fast forward operation) at five times speed.

Pressing this button while holding down the STOP button will initiate the "LOCATE ABS END" operation, and immediately locate the end of the recorded data on the hard disk (ABS END). (Refer to the "STOP button" section for more information about LOCATE ABS END.)

### 39. 48kHz LED [48kHz]

This LED displays the sampling rate of the Program you are currently working.

If the sampling rate is 48kHz, the LED lights up. If the sampling rate is 44.1kHz, the LED is turned off.

If the digital input signal has a different sampling rate from the Program you are currently working on, this LED flashes as alarm.

You can set a different sampling rate for each Program.

## D-90 Owner's Manual (Names and Functions)

The sampling rate data will be saved or loaded in each Program in Setup mode when you save or load the song data.

The data will be retained after you turn off the power to the unit.

**<Note>**  
Data with a sampling rate of 48kHz uses more hard disk space than data with a sampling rate of 44.1kHz. Therefore, the available recording time is shorter for 48kHz data.

**<Note>**  
Avoid changing the sampling rate setting of a Program.  
It is possible to change the sampling rate setting, but the Program will be played back at a different speed, causing the data value stored in the Memory keys (time, or bar/beat/clock) to change.

# Refer to page "140" for information on how to set a sampling rate.  
# Refer to page "132" for information on how to set up a digital input track.

### 40. Hard disk access LED

This LED lights up or blinks when the hard disk is writing or reading data.

**<CAUTION>**  
Do not turn the power off while the LED is lit or blinking. Otherwise, the data in the hard disk may be damaged.

### 41. MIDI Time Code In LED [MTC IN]

This LED lights up when MTC (MIDI Time Code) is Input from an external MIDI device to the MIDI IN connector of the D-90.

### 42. Punch In/Out jack [PUNCH IN/OUT] (Connector: PHONE jack)

Connecting the optional foot switch will let you control punch In/Out (and rehearsal) recording. Use a Fostex Model 8051 foot switch.

**<Note>**  
Be sure to use an "unlatch type" foot switch if you wish to use a foot switch other than the Model 8051. Otherwise, a malfunction may occur.

# Refer to page "73" for information about Punch In/Out recording using the foot switch.

## <Rear Panel>

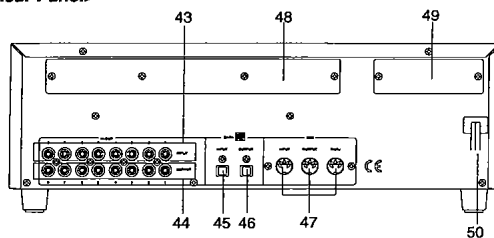

### 43. Input jack [INPUT 1-8] (connector: RCA pin)

Analog audio signal from the mixer is routed here.  
Connect this jack to the Group out (BUSS OUT) connector of the mixer.



D-90 Owner's Manual (Names and Functions)

**44. Output jack [OUTPUT 1-8]** (connector: RCA pin)

Analog audio signal of the D-90 is output here.  
Connect this jack to the TAPE IN connector of the mixer.

**45. Data Input connector [DATA INPUT]** (connector: OPTICAL)

Use this connector to load song data (audio + setup data) from an external device to the D-90. It is also used to input S/P DIF digital signal (from a DAT, CD, or MD) or adat digital signal (from RD-8, CX-8, or adat).

# Refer to pages "92" and "123" for information about "LOAD" function.  
# Refer to page "55" for information "Digital Recording."

**46. Data Output connector [DAT OUTPUT]** (connector: OPTICAL)

Use this connector to save song data (audio + setup data) from the D-90 to an external device. It is also used to output S/P DIF digital signal or adat digital signal to an external digital device.

# Refer to pages "92" and "123" for information about "LOAD" function.  
# Refer to page "55" for information "Digital Recording."

**47. MIDI Input/Output/Thru connector [MIDI INPUT/OUTPUT/THRU]**

(connector: DIN 5-pin)

**MIDI INPUT:**

Connect the MIDI OUT connector of an external MIDI device here.  
The D-90 can be controlled remotely via an external MMC (MIDI Machine Control) or FEX (Fostex System Exclusive Message).

**MIDI OUTPUT:**

Connect the MIDI IN connector of the external MIDI device here.  
The D-90 will output MTC (MIDI Time Code), MIDI Clock signal, MMC (MIDI Machine Control) response, and FEX (Fostex System Exclusive Message) response.

**MIDI THRU:**

This connector outputs the input signal at the MIDI INPUT connector without modification.  
When using multiple D-90s via MIDI, connect this terminal to the MIDI INPUT connector of the second D-90. Refer to page 98 for details.

**48. Panel A for an optional card**

This is the panel used for installing the optional Model 5040 (balanced 8-8 I/O card).  
Using the Model 5040 allows for balanced analog signal input and output. In general, leave the panel in place.

**49. Panel B for an optional card**

This is the panel used for installing the optional Model 8338 (D-90 SCSI card). Using the Model 8338 allows you to save song data and load it to and from a SCSI device. In general, leave the panel in place.

**46. Power cable**

Connect the power cable to an AC outlet of the specified voltage.

<Display Section>

The display of the D-90 integrates the level meter of a high-visibility FL tube with a time display of 10 digits and 7 segments.

The level meter shows the Track 1-8 output level of the recorder section. The time display shows the current time of the recorder section using ABS TIME (Absolute time), MTC (MIDI timecode), or MIDI BAR/BEAT (bar/beat). This display also shows the messages required for interactive operation. The following section explains the display functions and provides with some examples.

**1. Display shown when the power is turned on**

When you turn on the power to the D-90, the display shows "In It II," "wait" (Initializing, Please wait.), and the time display shows the time using the time base (ABS, MTC, or BAR/BEAT/CLK) that was selected before the power was turned off.

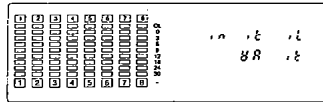

**2. Preset display**

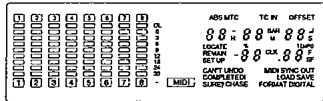

**1. Level meter**

The level meter shows the recorder output level and the recording level for Tracks 1-8.

**2. Track indication**

The track indication blinks when the corresponding track is ready. It turns off when the track is safe, and is lit during recording.

**3. ABS, MTC, BAR/BEAT/CLK**

When Time Base uses ABS time, "ABS" lights up. With MTC time, "MTC" lights up, and with BAR/BEAT/CLK indication, "BAR/BEAT/CLK" lights up.

**4. LOCATE**

This LED lights up when the unit enters data edit mode, enabling you to edit data. Pressing the LOCATE key while this LED is lit will cause the D-90 to locate the position of the displayed time or the bar/beat/clock value.

**5. REMAIN**

Refer to "2. Switching the display using the DISP SEL key."

**6. SETUP**

Refer to "2. Switching the display using the DISP SEL key."

**7. CAN'T UNDO**

If you try to perform Auto Punch In/Out recording after the D-90 enters Auto Punch In/Out mode, this message appears to warn you that you will be unable to undo the recording even if you can record, because there is not enough Undo area on the disk.

**8. COMPLETED**

This message indicates that an operation such as copy, move, and paste has been completed.

**9. SURE?**

This message is shown to confirm whether or not you wish to execute a certain operation.

**10. MIDI SYNC OUT, LOAD, SAVE, FORMAT, MTC OFFSET, TEMPO, BAR,**

When the unit enters Setup mode, the selected parameter name will appear here. The parameter name also appears on the 7-seg Display.

**11. MIDI**

This indication lights up when the D-90 receives effective MIDI messages from an external MIDI device.

**12. DIGITAL**

This indication lights up when the D-90 is receiving a digital signal properly at the DATA IN connector while loading data from an external digital equipment (CD, MD etc.). If this indication is blinking, the digital signal is not being received correctly.

**13. 7-segment Display**

This display indicates the ABS time, MTC time, BAR/BEAT/CLK time value or bar/beat/clock value, a Program number, and a parameter name in Setup mode.

**14. CHASE**

This LED flashes when the D-90 is in Slave mode, and lights up when the unit locks to sync signal.

**15. %**

This LED flashes when the D-90 is in Vari Pitch mode.

**3. Switching the display using the DISP SEL key.**

Let's assume that you turned off the power while the time display was using a time base of "ABS," and then you turned the power on again. The D-90 time display will again use a time base of "ABS." (Underline->Displayed program number)

**ABS TIME display**

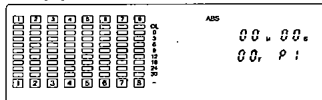

At this time if you press the DISP SEL key, the Disk Remain display (available recording time on the recorder) will appear.

**DISK REMAIN display**

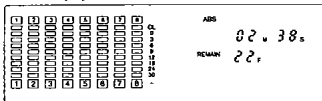

If "BAR/BEAT/CLK" is selected for the timebase (explained later), the DISK REMAIN indication will show a value (in terms of the number of measures) calculated based on the last beat/tempo data on the tempo map of the recorded song.

D-90 Owner's Manual (Names and Functions)

When you press the DISP SEL key again, the Setup mode display will appear. At this time, the D-90 has not entered Setup mode. To put the D-90 into Setup mode, press the EXECUTE/YES key. After pressing the EXECUTE/YES key, if you wish to go back to the previous status, press the EXIT/NO key.

Setup mode display

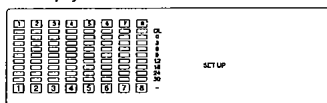

When you press the DISP SEL key again, the screen returns to the "ABS TIME" display.

4. Switching the Time Base display using the EXECUTE/YES key and DISP SEL key

When the screen is showing the ABS TIME or REMAIN display, if you press the DISP SEL key repeatedly while holding down the EXECUTE/YES key, the TIME BASE display will change cyclically. You can select one of the following Time Base displays.

ABS (Absolute Time)

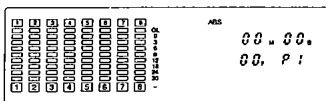

BAR/BEAT/CLK (Bar/Beat/Clock)

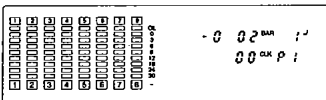

MTC (MIDI Timecode)

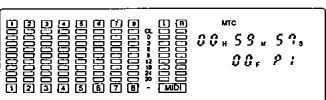

5. Changing Programs using the STORE key and the HOLD/> key

**\* About the Program Change function**

The Program Change function divides the hard disk space (available recording time) into up to nine parts to accommodate nine separate Programs so you can record, play back, edit, and archive (save and load) data for each Program individually. For example, the first song can be Program 1, the second song can be Program 2, etc. You need to recall the desired Program before you start recording, playback, editing, or archiving.

Pressing the STORE key while holding down the [HOLD/>] key will proceed to the next Program. (P1 -> P2 -> P3 -> P4 -> P5 -> P6 -> P7 -> P8 -> P9 -> P1 ...)  
 Pressing the [HOLD/>] key while holding down the STORE key will return to the previous Program. (P1 -> P9 -> P8 -> P7 -> P6 -> P5 -> P4 -> P3 -> P2 -> P1 ...)  
 The Time Base display will indicate the selected Program's Time Base, since you can set the Time Base for each Program individually.

**<Note>**

If you turn the JOG dial while the ABS display or MTC display indicates a Program number, the Program number indication will change to the sub-frame indication. However, if you use a transport button, such as the PLAY button or the Stop button, or if you turn the SHUTTLE dial, the sub-frame indication will change to the Program number indication. (The Program number shown on the BAR/BEAT/CLK display does not change.)

**<Note>**

The maximum total recording time of all nine Programs equals the available recording time of the hard disk. For example, if you use the optional Model 9041 (1.3GB removable hard disk cartridge), the available recording time is about 30 minutes (with a sampling rate of 44.1kHz). If you have recorded 20 minutes of data in Program 1, you can record 10 minutes for the total time of Programs 2-9. That is, you can record data totalling 30 minutes, regardless of whether you use up all nine Programs or you record only one Program.

Program number with the ABS Time Base (ex: Program P1)

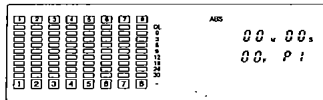

Program number with the BAR/BEAT/CLK Indication (ex: Program P3)

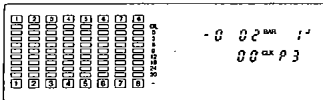

Program number with the MTC Time Base (ex: Program P8)

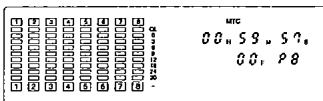

**6. Warning messages**

If you perform an inappropriate operation, input incorrect data, or if an error occurs, the following alarm indication appears:

**Invalid data indication (The input data is not appropriate for the operation).**

Action to take:

Input correct data.

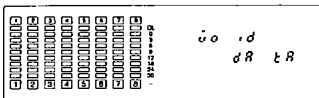

**Invalid In/Out Indication (The In or Out points is not appropriate for the operation).**

Action to take:

Input correct data.

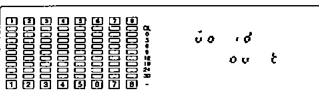
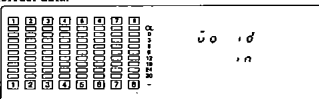

**Overtime Indication (The available disk space is insufficient for the length of time (the number of measures) indicated on the display.)**

Action to take:

During the copy & paste and move & paste operation, try to shorten the length of the copied data by the indicated amount. Alternatively, use the "CUT" function to move the ABS END point backward to obtain enough disk space for editing.

During Auto Punch In/Out mode, shorten the length of data between the In and Out points, or move the ABS END point backward.

If this warning message appears when you start Auto Punch In/Out mode, the message will automatically disappear and the display will show the next message "CAN'T UNDO." This message means that if you try to punch in record, you will be able to record but unable to undo the recording due to insufficient undo space on the disk. If you wish to see the overtime indication again, press the AUTO PUNCH IN/OUT key again.

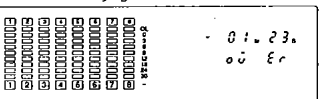

D-90 Owner's Manual (Names and Functions)

**Unassigned track indication (Select any track)**

Action to take:  
Use the RECORD TRACK select key to ready any track.

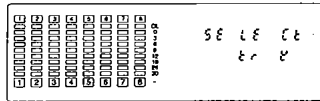

**Event overflow indication (The editing points are overflowed)**

Action to take:  
You edited too much. The warning means "you cannot paste or erase any more." In this case, first use the "SAVE" function from the Setup mode to save data to an external DAT machine, then load the data back to the D-90. In this way, the editing points will be cleared and you will be able to continue editing.

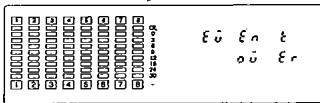

**Load error indication (You cannot load data because the data input to the DATA IN connector contains an error)**

Action to take:  
Check to see if there is an abnormality with the external DAT machine connected to the DATA IN connector or with the DAT type itself. Try to "LOAD" again.

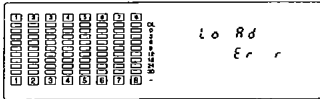

**Un-formatted indication (The internal hard disk is damaged or not formatted yet.)**

After this message is shown for about 10 seconds, "FORMAT" in Setup mode will flash on the display. Pressing the EXECUTE/YES key at this moment will erase all data and reformat the hard disk.

Action to take:  
Press the EXECUTE/YES key to format the disk. (All audio and other data on the disk will be lost.)

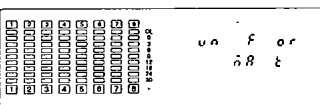

D-90 Owner's Manual (Names and Functions)

**Disk error indication (This disk cannot be read)**

Action to take:

Contact the Fostex service station as soon as possible.

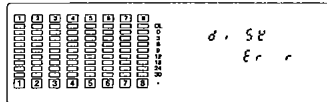

**Error Indication (Internal error occurred)**

Action to take:

Stop the operation, and inform the Fostex service station of the error message number.

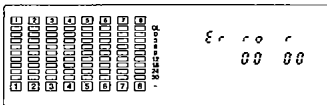

**Disk Lock error: (The hard disk is not installed correctly, or not security locked by the key.)**

Action to take:

Install the hard disk correctly or confirm that the disk is set properly, and be sure to lock it using the included key.

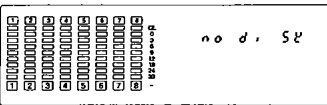

**Recording Disabled (Recording is disabled.)**

Action to take:

Change the "rEc" (recording) ENABLE/DISABLE setting in Setup mode.

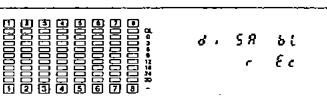



## Before operating the D-90

This section explains the following issues you will need to learn before operating the D-90.

1. The difference between a tape-based multitracker and a hard disk multitracker
2. Input monitoring and playback monitoring
3. Time Base
4. Installing the hard disk
5. Expanding the detachable controller section

### 1. The difference between a tape-based multitracker and a hard disk multitracker

The D-90 uses a hard disk as the recording media. Recording and playing back data on the D-90 is slightly different than on a conventional tape-based multitracker. On a tape-based multitracker, you can play the tape from any point between the beginning and the end of the tape as shown below. However, hard disk recording allows you to play between the ABS time (absolute time) - that is, "0", and the "END" point. (The end point represents the end of the recording.) You could make the analogy that the D-90 has a built-in tape with a maximum duration of 30-minutes. If you made a five-minute recording, you would work with a five-minute tape; if you recorded one additional minute, it would be like using a six-minute tape.

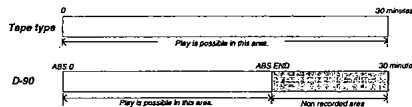

The Program Change function of the D-90 allows you to record and edit up to nine songs individually on the built-in hard disk. This can be described with the analogy of individual rooms as shown below, where you can record, play back, and edit in each room without giving any influence to the other rooms.

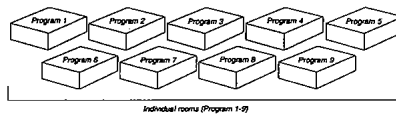

One of the important things here is that the total recording time for nine Programs is 30 minutes using the Model 9041 optional removable hard disk. (If you replace the hard disk, the total time would be the maximum recording time of the new hard disk.)

That is, if you record 30-minutes of data in one Program, you cannot record any more data in the other Programs. (If each song is three-minutes long, you can record each song in nine Programs.)

\* Refer to the "Recording/Playback" section for how to use the Program Change function.

D-90 Owner's Manual (Before operating the D-90)

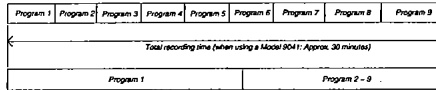

**2. Input monitor and Repro monitor**

There are two ways to monitor track data on the recorder: Input monitor and Repro monitor. These are defined as follows:

**Input monitor:**

Input monitoring enables you to listen to the input signal that is routed to and output through the tracks just as it is. That is, listening to (monitoring) the post-recorder input signal (not the pre recorder signal). Eight tracks on the D-90 can be set to either "Input monitoring" or "Repro monitoring" status. Follow the steps below to set the tracks to Input monitor.

1. Set the track to recording status.

To set the track to recording status, first ready the track, then press the PLAY button while holding down the RECORD button. At this time, the recording track is in Input monitoring status.

**Alternatively,**

2. Ready the track, and press the RECORD button once. (If you press the RECORD button again, the track enters the repro monitoring status.)

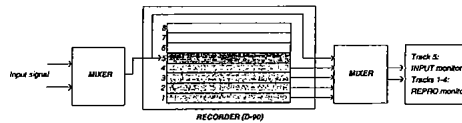

\* At this time, the RECORD LED next to the RECORD button will flash, and the currently selected tracks will enter input monitoring status.

**Repro monitor:**

Repro monitoring enables you to monitor the playback signal on the tracks; that is, to listen to the output of the recorded signal.

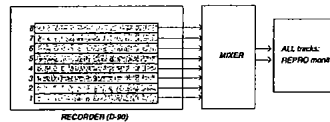

**3. Time Base**

The D-90 indicates the location of the recorder (the current position) using the ABS time, MTC, or MIDI Bar/Beat/Clock. This time reference is called "timebase."

ABS (Absolute Time) refers to an absolute time on the hard disk; MTC (MIDI timecode) refers to a relative time obtained by adding a certain value (MTC offset value) to the ABS value; and BAR/BEAT/CLK (bar/ / clock) indicates a position in a song that corresponds to the MIDI Clock/Song Position Pointer and can be created using the internal Tempo Map. (The following diagram shows the relationship between the three types of timebase.)

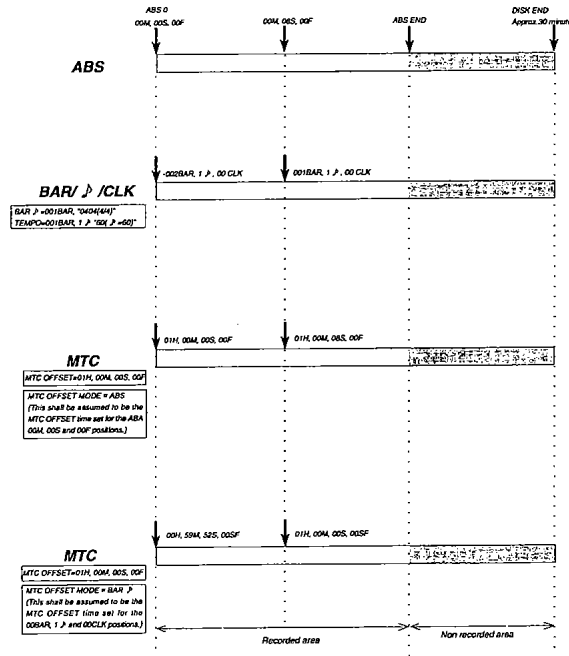

**4. Installing the hard disk**

The D-90 utilizes a removable hard disk cartridge, making it quick and easy to transport and replace the hard disk. (The hard disk is inside this cartridge).

Using an optional removable hard disk cartridge Model 9041 (1.3GB hard disk built-in) allows you to replace the cartridge or extend the recording time (about 30 minutes) very easily.

\* Refer to next page for more information on replacing the removable hard disk cartridge.

You can install an ATA (IDE) standard hard disk in an optional removable case Model 9040B (without hard disk). The following is a hard disks that already been tested for operation on the D-90.

Tested hard disks (as of February 15, 1997): All disks ATA (IDE) standard products.

Manufacturer	Model name	Capacity	Recording time
Quantum	Fireball 2	640MB	About 15 minutes
Quantum	Fireball 2	1.28GB	About 30 minutes
Quantum	Fireball TM	1.3GB	About 30 minutes
Quantum	Fireball TM	2.6GB	About 60 minutes
IBM	DPEA-31080	1.08GB	About 25 minutes
IBM	DJAA-31700	1.71MB	About 40 minutes
Western Digital	AC31600	1.6GB	About 38 minutes
Western Digital	AC21200	1.3GB	About 30 minutes
Western Digital	AC21600	1.6GB	About 38 minutes

**<Note>**  
Using a hard disk that is not recommended may cause malfunction of the D-90 (for example, shorter recording time). The D-90 will accept any ATA (IDE) standard hard disk from the manufactures listed above that has 650MB or more memory space for both sides, with a disk speed of 5,000rpm or higher and a disk cache of 128k or higher.

**<WARNING>**  
Plug the included dust cap onto the connector of the D-90's removable hard disk to protect the disk from static electricity, dust and dirt before you store or transport the hard disk. A hard disk is precision device. Handle it with care and avoid vibration, humidity, strong magnetic fields, static electricity, dust, etc. In particular, do not touch the connector with your hands to protect the hard disk from static electricity.

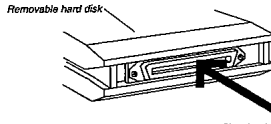

Plug the dust cap onto the connector.  
(Do not touch the connector with your hands.)

**Replacing a removable hard disk cartridge**

Follow the procedure below to replace the removable hard disk cartridge.

1. Turn the power off to the D-90.

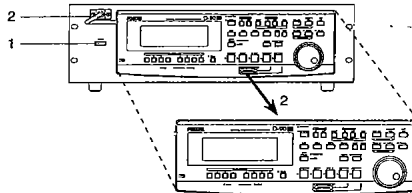

2. Remove the connector from the detachable remote controller section, and remove the controller section.

3. Release the lock using the key included in the package. (Refer to the figure on the right below.)

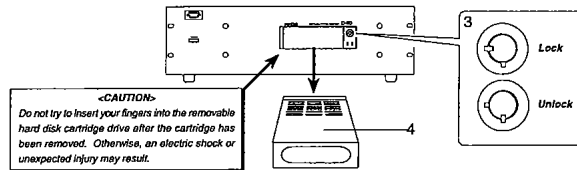

4. Pull the disk cartridge forward you to remove it.  
The hard disk is a precision device. Handle it with care.
5. Insert new disk cartridge.  
Gently push it in until a click noise is heard.
6. Lock the cartridge using the key. (Refer to the figure on the right above.)
7. Install the controller section, and fix the connectors securely using the screws.

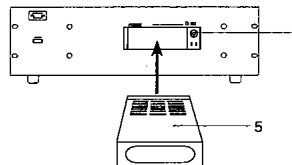

\* When installation is complete, follow the procedure "Formatting a hard disk" on page 40 to format the hard disk.

### Installing a removable hard disk cartridge

A hard disk cartridge is not installed in the D-90 when it is shipped. You will need to install a removable hard disk cartridge in the D-90. (You can use an optional Model 9041 or a hard disk that has been approved for performance and installed in the removable case that came with the D-90.) Follow the procedure below to install a new hard disk cartridge. Be sure to format the hard disk. The following procedure should be performed with the power to the D-90 turned off.

1. Remove the blank panel from the cartridge slot.

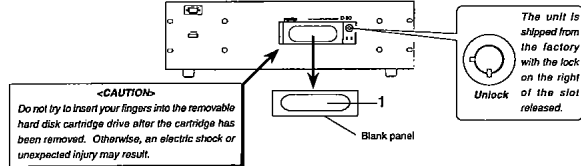

2. Insert the hard disk cartridge (e.g., Model 9041) into the slot. Make sure that you insert the cartridge until it will clicks into place. Be sure to remove the dust cap on the connector of the cartridge case before inserting the cartridge.

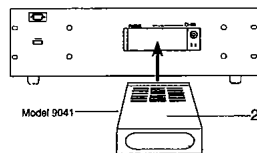

3. Lock the cartridge with the key included in the package.

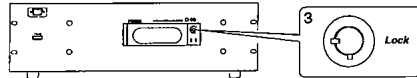

4. Connect the connector of the detachable controller, and install the controller onto the D-90.

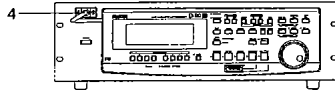

\* When installation is complete, follow the procedure "Formatting a hard disk" on page 45 to format the hard disk.  
\* If you are using a hard disk (that has been approved for performance) and installing it in the removable case that came in the package, refer to "Installing a hard disk in the removable case" on page 39.

**Installing a hard disk in removable case Model 9040B**

If you have purchased one of the hard disks listed in the table on page 36, you need to install the disk in optional removable case Model 9040B or included removable case.

Follow the procedure below to install the disk in the removable case, then install the case in the D-90 as explained on the previous page, and format the disk.

**<WARNING>**

A hard disk consists of precision parts, and is sensitive to strong shocks (such as being dropped). Handle the disk with care. Install the disk on the level, stable surface. Fostex is not responsible for any malfunction or damage caused by incorrect handling.

**<CAUTION>**

If any part of the disk unit touches the case bottom, paste an "insulation seal (diameter: 18mm)" included in the package of the case at the point of contact. Some disk units may be in such a dimension that the part may touch the case. If you use a disk with a part touching the case, a short circuit, malfunction, or damage may result. Make sure that no part of the disk will touch the case, or paste the seal.

**<Note>**

Be sure to set the DIP switch or the JUMPER switch on the hard disk to "MASTER" when you install the hard disk in the removable case. The disk will not operate if the setting is "SLAVE." (Refer to Hard Disk's Owner's Manual for details.)

1. Disassemble the removable case.  
Refer to the diagram to remove the bottom of the case.

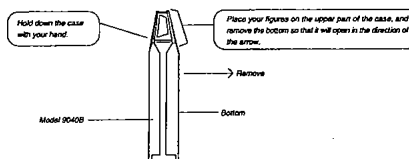

2. Insert the disk unit into the case, and connect the cable connectors on the case to the appropriate connectors on the disk unit.

**<Note on connecting the connector>**

Sometimes it may be difficult or awkward, due to a lack of space, to connect the connectors when you are installing a hard disk into the removable case. In this event, do not apply excessive force on the connector. Use caution to avoid injury or damage to the hard disk.

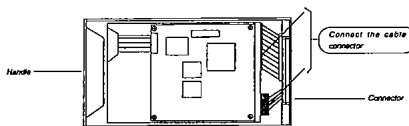

D-90 Owner's Manual (Before operating the D-90)

- Secure the disk unit using the screws that come with the removable case. (Use two screws on each side as shown in the diagram.)

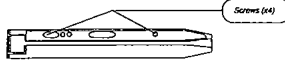

- Replace the bottom. (Before installation, read the following note.)
- Install the entire case and disk in the D-90 following the steps on page "\*\*\*\*" (don't forget to lock the key!) and proceed to formatting.

**Formatting a hard disk**

After replacing the hard disk cartridge, follow this procedure to format the disk. When you turn the power on to a D-90 that has an unformatted disk, the unit automatically enters Setup "FORMAT" mode.

- Confirm that the cartridge is locked by the key, and turn on the power to the D-90. The display will show the initial screen, then change to the following screen:

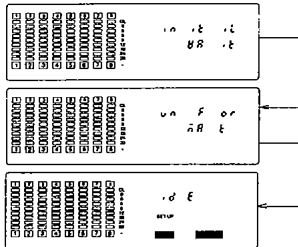

- Press the EXECUTE/YES key. The display will change to the following screen, and formatting will start. The display will show the time required for the formatting operation as a negative value, and count down.

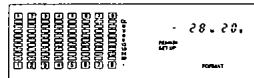

When formatting is complete, the following screen will appear, and the hard disk will stop.

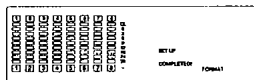

- Press the EXIT/NO key or the STOP button to quit Setup mode.



\* If you are using a hard disk that already contains some data from when it was used in a computer, the D-90 may not enter formatting mode automatically. In this case, press the DISP SEL key to force the unit to enter Setup mode, then select "FORMAT" to format the disk. (See page "125" for more information on "FORMAT" in Setup mode.)

### 5. Extending the detachable controller

You can remove the detachable controller from the main unit and extend it using an optional extension cable Model 8551. This optional cable is five meters long, and is equipped with D-sub 15-pin male and female connectors.

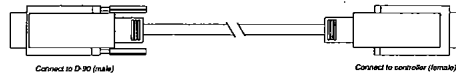

1. Turn the power off to the D-90 before connecting a cable.
2. Loosen the screw for the connector that connects the controller to the D-90, and remove the connector.
3. Remove the controller from the D-90.  
Pull the controller toward you while pushing it up with your hand to remove it easily.

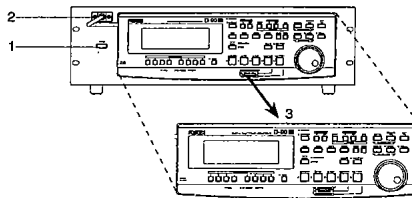

4. Insert the male connector of the extension cable to the D-90's connector, and secure it with a screw.
5. Connect the female connector on the cable and the male connector on the controller cable, and secure them with a screw.

D-90 Owner's Manual (Before operating the D-90)

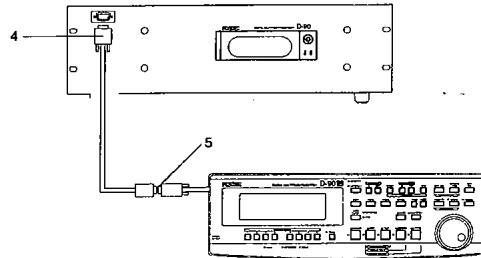

6. Turn the power on to the D-90, and operate the buttons and keys on the controller to confirm that the D-90 operates correctly.

**<WARNING>**

When you use the detachable controller remotely using an extension cable, the D-90 may malfunction due to electromagnetic interference. In this case, turn the power off, then on to the D-90 to restore the normal condition. Fostex is not responsible for malfunction of the D-90 caused by electromagnetic interference.

**<CAUTION>**

Turn off the D-90 before connecting or disconnecting any cables. Connecting or disconnecting the footswitch or detachable controller cables while the D-90 is turned on will cause it to malfunction.

## Recording / Playback

This section explains how to record and playback data on the D-90.

### 1. Basic connections

The D-90 is an 8-track recorder, equipped with analog INPUTs 1-8 and OUTPUTs 1-8. Refer to the following diagram to connect the D-90 to an external mixing console for multitrack recording.

The optimum mixing console for the D-90 would be equipped with 8 TAPE IN connectors and 8 BUSS OUT connectors (or GROUP OUT connectors), although you can also use a mixer with 8 TAPE IN connectors and 4 BUSS OUT connectors. Refer to the following examples depending on your type of your mixer.

#### <Example-1>

Connecting a mixer equipped with 8 TAPE IN, 8 BUSS OUT (or GROUP OUT):

This connection allows for 8-track simultaneous recording.

- \* Connect the mixer TAPE IN 1-8 with the D-90 OUTPUT 1-8.
- \* Connect the mixer BUSS OUT (or GROUP OUT) 1-8 with the D-90 INPUT 1-8.

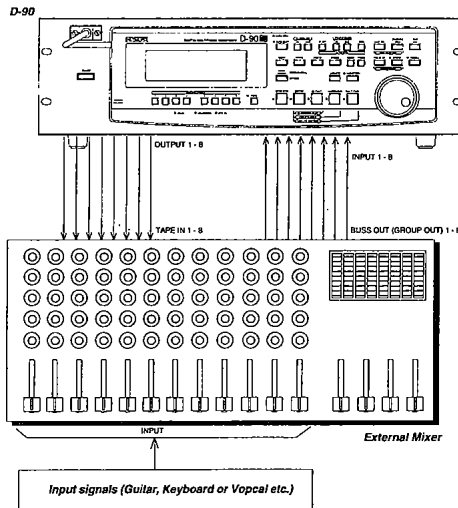

<Example-2>

Connecting a mixer equipped with 8 TAPE IN, 4BUSS OUT (or GROUP OUT):  
In this example, you would record tracks 1-4 first, then tracks 5-8.

- \* Connect the mixer TAPE IN 1-8 with the D-90 OUTPUT 1-8.
- \* Connect the mixer BUSS OUT (or GROUP OUT) 1-4 with the D-90 INPUT 1-4 to record tracks 1-4. To record tracks 5-8, connect INPUT 5-8 instead of INPUT 1-4. (Using a patch bay allows you to change the connection from the front.)

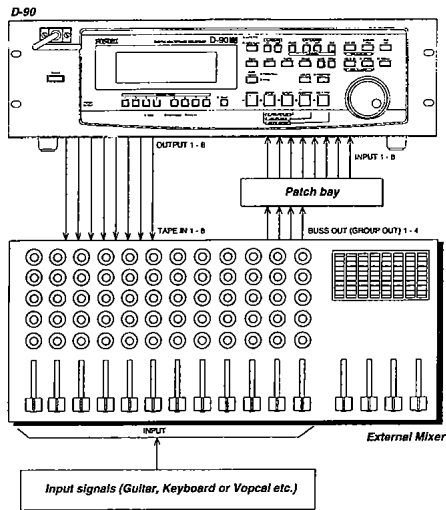

### 2-1. Setting a Program

As explained in "Getting Started," the D-90 features a Program Change function, which allows you to manage up to nine songs (P1-P9) as individual Programs. Therefore, you need to select a Program before you start recording and playback.

There are two methods by which you can select a Program, as follows:

1. Press the STORE key while holding down the HOLD/> key to proceed to the next Program. (P1 → P2 → P3 → P4 → P5 → P6 → P7 → P8 → P9 → P1 ...)

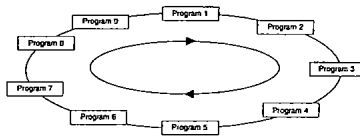

2. Press the HOLD/> key while holding down the STORE key to go back to the previous Program. (P1 → P9 → P8 → P7 → P6 → P5 → P4 → P3 → P2 → P1 ...)

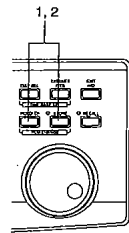
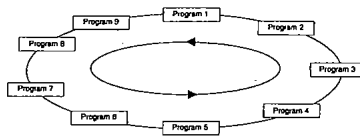

When you select a Program, the Time Base setting (ABS, MTC, or BAR/BEAT/CLK) you used previously for that Program will be used again. You can set the Time Base for each Program individually.

You can also switch to the REMAIN indication by pressing the DISP SEL key. Check to see if there is enough time (bars) remaining for recording. This value is not an available time for each Program, but the total available time for all Programs P1-P9.

**<Note>**

1. The following parameters can be set for each Program individually:  
Memory data (CLIPBOARD IN/OUT, AUTO RTN START/END, AUTO PUNCH IN/OUT)  
Time Base (ABS, MTC, or BAR/BEAT/CLK)

SETUP mode:  
\* Time signature setting (BAR BEAT), \* TEMPO setting, \* CLICK ON/OFF setting, \* PREROLL TIME setting, \* MIDI SYNC OUT setting, \* MTC FRAME RATE setting, \* MTC OFFSET setting, \* MTC OFFSET MODE setting, \* ENABLE/DISABLE REC setting, \* SLAVE ON/OFF setting, \* SLAVE TYPE setting, \* FS (Sampling frequency) setting

2. The following parameters are common to all Programs:  
Auto Play mode ON/OFF, Auto Return mode ON/OFF, Vari-pitch mode ON/OFF, Pitch data

SETUP mode:  
\* DIGITAL IN setting, \* DIGITAL OUT setting, \* RESOLUTION ON/OFF setting, \* DEVICE ID setting, \* UNDO ALL/EDIT setting

## 2. The default setting on the D-90

Before you start operating the D-90 or proceed to the next step, you may want to arrange the controls and switches to restore the initial setting so that you will not, for example, erase important data on a track by using incorrect settings. In this manual, this procedure is called "setting defaults." For default settings, the controls and switches should be arranged as shown in the figure below. Make it a rule to return to these default settings before you proceed to a new step.

### Outline of the Initial Settings:

- \* Turn all the RECORD TRACK select keys to "SAFE." (Track indication is turned off.)
- \* Auto Return/Auto Play mode is "OFF." (The AUTO RTN/AUTO PLAY LEDs are off.)
- \* Auto Punch mode is "OFF." (The REHEARSAL/TAKE LEDs are off.)
- \* The STOP button LED is lit.
- \* The STORE key and the RECALL keys are "OFF." (The STORE/RECALL LEDs are off.)
- \* Enable rEc is selected in Setup mode.
- \* dG In is assigned to "L-, r-" in Setup mode.
- \* "SLAVE" is off in Setup mode.
- \* Setting a Program for recording/playback (See 2-1.)
- \* Setting a sampling rate for recording/playback (See 2-2.)
- \* Turning off the Vari-pitch function. (The LED is turned off.)
- \* The LED of the FUNC key is off.

When the Recording Enabled/Disabled parameter in Setup mode is set to "DISABLE rEc," pressing the RECORD button and the PLAY button will not start recording, and the unit will display "DISABLE rEc" on the panel. Be sure to set the mode to "ENABLE rEc" to enable the recording function.

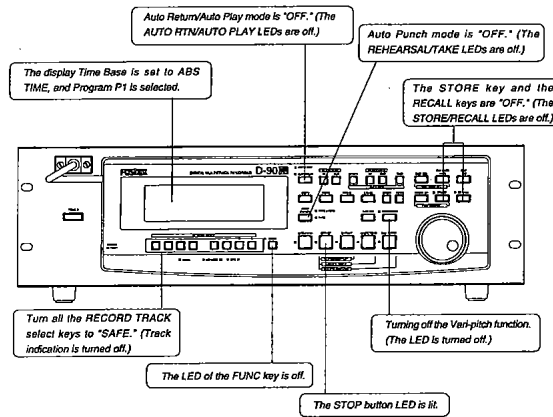

**<Note>**

The maximum total recording time of all nine Programs equals the available recording time of the hard disk. For example, if you use the optional Model 9041 (1.3GB removable hard disk cartridge), the available recording time is about 30 minutes (with a sampling rate of 44.1kHz). If you have recorded 20 minutes of data in Program 1, you can record 10 minutes for the total time of Programs 2-9. That is, you can record data totalling 30 minutes, regardless of whether you use up all nine Programs or you record only one Program.

## 2-2. Setting a Sampling Rate

The D-90 supports two sampling rates: 44.1kHz and 48kHz.

Before you start recording data in a new Program, be sure to set the sampling rate, using the procedure below. After you format the disk or set up a new Program, the sampling rate is set to "44.1kHz." If you wish to use this rate, you do not have to follow the procedure below.

The sampling rate of the Program is indicated by the status of the 48kHz LED above the detachable controller. The LED lights up at a setting of 48kHz, and is turned off at a setting of 44.1kHz.

- \* Default: 44.1kHz
- \* Available sampling rates: 44.1kHz, 48kHz
- \* This parameter can be set for each Program.
- \* This setting can be saved and loaded as part of the song data.
- \* This setting will be retained after the power is turned off.

\* Check to make sure the correct Program has been selected before you set the sampling rate.

# Refer to page 140 of "SETUP mode 20. Setting of the Sampling Frequency" for information on operating procedures.

The sampling rate setting does not greatly affect analog recording or playback. However, it can be an important element when the unit is processing a digital signal. For example, CDs use a sampling rate of 44.1kHz, and you will need to set the sampling rate of the D-90 to 44.1kHz for digital recording from a CD. If you have set the sampling rate on the D-90 to 48kHz when recording from a CD, the 48kHz LED located above the detachable controller will flash to warn you. When you work with a 48kHz digital signal input from an ADAT, set the sampling rate to 48kHz. Also, make sure that the sampling rate of the external device matches that of the D-90 when a digital signal is output from the D-90 to an external device, such as a digital mixer.

**<Note>**

A 48kHz sampling rate setting requires more disk space than the 44.1kHz setting. This means that the available recording time would be shorter. Therefore, the remaining disk space (REMAIN) after recording with a sampling rate of 48kHz would be smaller (shorter in time).

**<Note>**

Do not change the sampling rate of a Program during a session unless it is very important. It is possible to change the sampling rate setting, but the Program will be played back at a speed different from the original recording speed, causing the data value stored in the Memory keys (time, or bar/beat/clock) to change.

# Refer to page 55 for information on recording and playback of a digital signal.

### 3. Analog Recording and Playback

This explanation is based on the assumption that the D-90 is connected to a mixer, and the sound source is input from the mixer's BUS OUT (GROUP OUT) connector, as shown in the "Basic Connection" section.

\* Restore the default settings on the D-90.  
\* Check the Program selection and the sampling rate setting. Do not change these settings until this session is complete.

#### 3-1. Basic recording and playback

Assume that "P1" has been selected for recording. If you wish to record data in another Program, see the section 3-2.

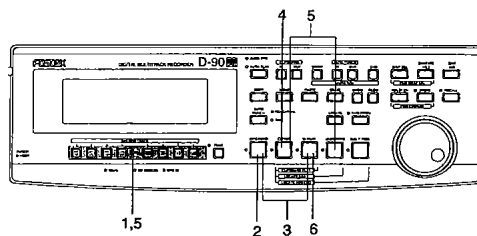

Turn on the power to the D-90, and check to make sure that the Time Base display indicates ABS time "00M 00S 00F" and "P1".

#### Selecting a recording track

1. Press any RECORD TRACK select key (1-8) to "READY" the track.  
The number of the selected track will blink on the display.

#### Adjusting the recording level

The D-90 does not have a recording level control. You need to adjust the recording level on a connected device that sends out sound data. Primarily use the GROUP OUT master faders (or the faders that control the output level of BUSS OUT 1-8) on the mixer. The recording track of the D-90 also needs to enter input monitoring status.

2. Press the RECORD button once.

The READY track enters input monitoring status. Raise the GROUP OUT master fader on the mixer so that the meter of the "READY" track approaches level "0-3" at peak volume. If the "OL" indication is lit, the recording level is too high.

Unlike an analog recorder, if the recording level is too high, the signal may be distorted on a digital recorder. In particular, recording vocal or acoustic musical instruments requires more attention because the recording level may change suddenly, causing signal overflow. It may be a good idea to use a compressor/limiter connected to an INSERT connector on the mixer.

#### Start recording

3. After adjusting the recording level, press the RECORD button while holding down the PLAY button.  
The blinking RECORD LED and track indicator will light up.



4. To stop recording, press the STOP button.

**Playback**

5. Press the "READY" track's RECORD TRACK select key to switch to "SAFE." (The track indicator will turn off.)

6. Press the STOP button and the REWIND button simultaneously to locate the beginning of the disk (ABS 0).

7. Press the PLAY button.

The recorder will start playback data. Adjust the TAPE IN Input level on the mixer while monitoring.

In this way, you can record sound source to any track (a single track or multiple tracks).

**3-2. Recording with the Program Change function (Switching Programs P1-P9)**

As previously explained, the D-90 has a "Program Change Function" to manage up to nine songs. You can record, playback, and edit each Program separately. This section explains how to record and play back Programs using the Program Change function.

\* Restore the default settings on the D-90.

**Changing a Program**

1. There are two methods by which you can select a Program, as follows:

Press the STORE key while holding down the HOLD/> key to proceed to the next Program. (P1 -> P2 -> P3 -> P4 -> P5 -> P6 -> P7 -> P8 -> P9 -> P1 ...)

Press the HOLD/> key while holding down the STORE key to go back to the previous Program. (P1 -> P9 -> P8 -> P7 -> P6 -> P5 -> P4 -> P3 -> P2 -> P1 ...)

When you select a Program, the Time Base setting (ABS, MTC, or BAR/BEAT/CLK) you used previously for that Program will be used again.

To change the Time Base display, Press the DISP SEL key while holding down the EXECUTE/YES key. You can set the Time Base for each Program individually.

You can also switch to the REMAIN indication by pressing the DISP SEL key.

Check to see if there is enough time (bars) remaining for recording.

This value is not an available time for each Program, but the total available time for all Programs P1-P9.

2. Set the sampling rate if necessary.

Refer to section "2-2. Setting a sampling rate" for the correct procedure.

**Recording (Refer to "2-1. Basic recording/playback" for details.)**

3. Press the RECORD TRACK select key (1-8) to set the recording track in ready mode.

4. Press the RECORD button once to set the unit in input monitoring status, and adjust the recording level.

5. Press the RECORD button while holding down the PLAY button.

6. When recording is complete, press the STOP button.

**Playback (Refer to "2-1. Basic recording/playback" for details.)**

7. Press the RECORD TRACK select key for the track in ready mode so that the track becomes "safe."  
The track LED will be turned off.

8. Press the REWIND button while holding down the STOP button to locate the top of the Program (ABS 0) (LOCATE ABS 0).

9. Press the PLAY button.

Playback will start. Adjust the TAPE IN input level from the mixer.

**<Note>**

The maximum total recording time of all nine Programs equals the available recording time of the hard disk. For example, if you use the optional Model 9041 (1.3GB removable hard disk cartridge), the available recording time is about 30 minutes (with a sampling rate of 44.1kHz). If you have recorded 20 minutes of data in Program 1, you can record 10 minutes for the total time of Programs 2-9. That is, you can record data totalling 30 minutes, regardless of whether you use up all nine Programs or you record only one Program. Therefore, the remaining recording time is obtained by subtracting the sum of the recorded time for all recorded Programs from the initial total available time.

For example, if Program 1 contains a recording of ten minutes and Program 2 contains a recording of five minutes, you can use fifteen minutes for recording Programs 3-9. This remaining time is indicated as the REMAIN time when you press the DISP SEL key. Be sure to watch this time when you are recording multiple Programs.

**<Note>**

Data with a sampling rate of 48kHz uses more hard disk space than data with a sampling rate of 44.1kHz. Therefore, the available recording time is shorter for 48kHz data.

# Refer to "2-1. Setting a Program" for more information on Programs.

# Refer to "2-2. Setting a sampling rate" for more information on sampling rates.

### 3-3. Playback using the Vari-pitch function

This section describes how to use the Vari-pitch function to change the playback speed of the recorder.

The D-90's Vari-pitch function allows for pitch control in the range of +/-6.0% in 0.1% steps.

Use the VARI PITCH key to switch the Vari-pitch function on/off. The LED lights up when the function is enabled, and the LED is off when the function is disabled.

\* Restore the default settings on the D-90.  
 \* Check the Program selection and the sampling rate setting. Do not change those settings until this session is complete.  
 \* Assume that a Program has already recorded track according to the procedure described in "Basic Recording."

1. Press the **PLAY** button to start playback.

2. Press the **VARI PITCH** key.

The LED will light up, indicating that the Vari-pitch function is on.

3. Press the **RECALL** key, then the **VARI PITCH** key. ("%" indicator will blink.)

The current pitch data will be indicated on the display. You can now edit the pitch data.

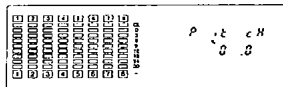

4. Use the **JOG** dial to edit the pitch data.

You will notice a change in the playback speed.

5. Press the **EXECUTE/YES** key, the **EXIT/NO** key, or the **STOP** button to quit the pitch data screen.

The screen will return to the Time Base display.

You can turn the Vari-pitch function on and off and change the pitch data while the recorder is playing back or stopped, but not while the unit is recording.

If the Vari-pitch function is on and the pitch data is set before recording starts, that speed will be used during recording.

While the pitch data is shown on the display, you can turn the function on and off and edit the pitch data. However, the **PLAY** button, or the combination of the **PLAY** button and the **RECORD** button, will be disabled. If you wish to change the pitch while you are listening to the sound, first press the **PLAY** button to start playback, then display the pitch data indication to change the speed.

**<Note>**  
 When you press the **VARI PITCH** key, the **VARI PITCH** LED lights up, even if the pitch data is set to 0.0%. The LED indicates that the Vari-pitch function is turned on.

**<Note>**  
 The Vari-pitch function will be automatically turned off under the following conditions:  
 \* When you turn off the power to the unit. (The pitch data will be reset to 0.0%.)  
 \* When you set the Slave mode to ON. (The Vari-pitch function will retain the pitch data.)  
 \* When you set up a digital input track and the **DIGITAL** indication on the display lights up. (The Vari-pitch function will retain the pitch data.)

# Refer to page 104 for more information on Slave mode.  
 # Refer to page 55 for more information on digital signals.

### 3-4. Multitrack recording using overdubbing

You have mastered basic recording/playback in the previous section. In this section, we will make a multitrack recording.

Multitrack recording is a series of operations in which you record sound sources to multiple tracks and combine these recordings into two mixes (L, R). In this process, the most important step is "overdubbing." "Overdubbing" means recording a new sound source to another track using input monitoring, while listening to the playback of the pre-recorded sound (that is, playback monitoring).

The following is an example of an overdubbing procedure:

Step 1: Record a drum machine to Track 1

Step 2: Overdub an electric bass to Track 2 while listening to Track 1

Step 3: Overdub an electric lead guitar on Track 3 while listening to Track 1 and 2

Step 4: Overdub an electric slide guitar on Track 4 while listening to Track 1, 2 and 3

In this way, we will overdub sound sources to Track 1 through 8 as shown in the diagram below.

Track 1	Track 2	Track 3	Track 4	Track 5	Track 6	Track 7	Track 8
Drum Machine	E. Bass	E. Guitar	E. Guitar	Vocal 1	Vocal 2	Piano	Synth

\* Restore the default setting on the D-90.

\* Stay in the same Program until you finish overdubbing.

#### Selecting a recording track

1. Press the **RECORD TRACK** select key of an overdub track to "READY" the track.

For example, if you are overdubbing Track 2 while listening to Track 1, set the **RECORD TRACK** select key "2" to "READY." (Number "2" will blink.)

#### Adjusting the recording level (rehearsal)

2. Press the **RECORD** button once. (The **RECORD LED** will blink.)

The "READY" track will enter input monitoring mode, and "SAFE" tracks will enter playback monitoring mode.

3. Press the **PLAY** button to play back data from the beginning of the disk (ABS 0).

Adjust the playback monitoring level of the "SAFE" tracks, and play a musical instrument while adjusting the **GROUP OUT** level on the mixer (that is, a recording level on the recorder).

4. Rewind data to the beginning of the disk. (Press the **STOP** button and the **REWIND** button simultaneously.)

#### Start overdubbing

5. Press the **RECORD** button while holding down the **PLAY** button.

Recording will start, and the **RECORD LED** and the "READY" track indicator will light up.

6. **PLAY** the instrument while listening to the playback as you did during rehearsal.

7. When recording is complete, stop the recorder, and locate the beginning of the data.

#### Playback

8. To prevent accidental recording, switch the **RECORD TRACK** select key of the "READY" track to "SAFE."

9. Press the **PLAY** button to start playing back the recording.

On the mixing console, adjust the playback monitoring level of the already recorded tracks and newly recorded track.

Repeat the steps described above to overdub Tracks 1 through 8.

### 3-5. Mixdown

Mixdown is the final step in multitrack recording and allows you to combine multiple track recordings to L and R channels (two mixes), and copy the data to a master recorder. The mixdown signal is output from the STEREO OUT L/R connector. Connect the Inputs of the master recorder to the STEREO OUT L/R.

- \* Set the D-90 to the default setting.
- \* This manual assumes that you have already recorded sound sources to all eight tracks.
- \* Refer to the mixer instruction manual for applying effects.
- \* Connect the master recorder to the mixer STEREO OUT L/R as shown in the diagram.

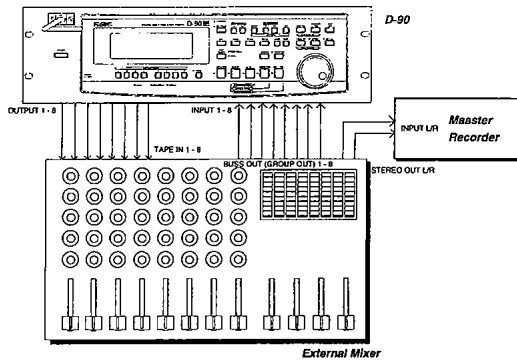

#### Mixdown rehearsal

1. Confirm that all the RECORD TRACK select keys are set to "SAFE."
2. Locate the beginning of the sound data on the recorder. (Press the STOP button and the REWIND button simultaneously.)
3. Set the master recorder to REC-STANDBY mode.
4. Press the PLAY button on the D-90 to play back recordings, adjust the tonal quality and mix balance of the playback sound on the mixer channels, and adjust the recording level on the master recorder.  
Adjust the input level of the master recorder so that the mixer STEREO OUT L/R meters and the level meters of the master recorder move in the same manner.
5. Locate the beginning of the disk (ABS 0).

#### Mixdown

6. Start recording on the master recorder.
7. Press the PLAY button on the D-90 to start playback.
8. When mixdown is complete, press the STOP button to stop the D-90.  
Stop the master recorder, and listen to the mixdown song.

### 3-6. Ping-pong recording

This section explains how to perform ping-pong recording. It also describes the MIDI Clock synchronization system, the MTC sync/machine control system, and recording in D-90 Slave mode, using the D-90 MIDI functions.

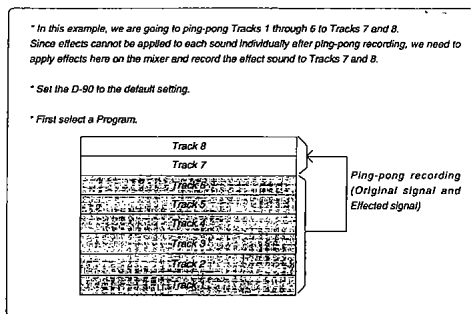

#### Selecting a recording track

1. Press the RECORD TRACK select keys 7 and 8 to "READY" Tracks 7 and 8.

#### Level adjustment/Rehearsal

2. Press the RECORD button once. (The RECORD LED will blink.)  
Tracks 7 and 8 enter input monitoring status.
3. Press the PLAY button to start playback.  
Use the mixer to send the signal in Tracks 1-6 to Tracks 7 and 8 and adjust the recording level.
4. After rehearsal is complete, locate the beginning of the disk (ABS 0).

#### Actual ping-pong recording

5. Press the RECORD button while pressing and holding down the PLAY button to start ping-pong recording.

## 4. Digital Recording

### 4-1. Digital recording from an external digital device (S/P DIF)

This section explains how to record a digital signal from the digital output of an external digital device (CD, MD, DAT, Fostex RD-8, CX-8, etc.) to the D-90.

\* Restore the default settings on the D-90.

#### Connecting an external digital device

Connect the DATA IN connector of the D-90 with the digital output of an external digital device (CD, MD, DAT, Fostex RD-8, CX-8, etc.).

#### <Note>

The D-90 switches the DATA IN connector between an S/P DIF digital signal (OPTICAL) and an adat digital signal during setting of the digital input track in Setup mode. Both signals use the same connector configuration, but carry different data.

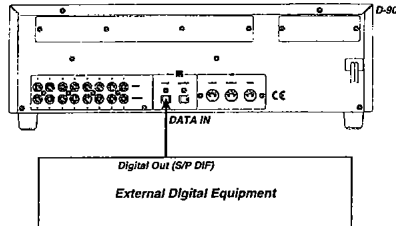

- \* If the external device has only a coaxial (RCA) type digital output connector, use the optional COP-1 optical/coaxial converter to connect the device to transmit S/P DIF digital signal. The operation is the same as that for a device with a coaxial connector.
- \* If you connect both the digital input and output of the D-90 to those of an external digital device, a digital loop may be generated. Refer to "4-3. Connecting a digital mixer" for more information.

#### Setting an external device

Set the external device so that it will output digital signals from the digital output connector. Some devices may output digital signals only when they are in playback mode.

# Refer to the instruction manual that came with the external device for details.

#### Selecting a recording Program

There are two methods by which you can select a recording Program, as follows:

1. Press the STORE key while holding down the HOLD> key to proceed to the next Program.
2. Press the HOLD> key while holding down the STORE key to go back to the previous Program.

# Refer to "2-1. Setting a Program" for more information on Programs.

**Setting the sampling rate for a recording Program**

**\*\*\*\*\*IMPORTANT\*\*\*\*\***

When an S/P DIF digital signal is input to the D-90, be sure to match the sampling rate of the D-90 to that of the external digital device.

\* If the sampling rate setting does not match, you cannot record the S/P DIF digital signal.

\* For an adat digital signal, the D-90 will be able to record data with a different sampling rate setting. However, the data will be recorded at a different speed. The D-90 will lock to the external word clock when the S/P DIF or adat digital signals are input to the digital input tracks. (The D-90 will operate, referencing to the word clock sent from the external device.) However, an adat digital signal does not contain the sampling rate information (48kHz or 44.1kHz) that is included in the S/P DIF digital signal. This is why the D-90 can sync to the external device with a different sampling rate.

- \* Initial setting: 44.1kHz
- \* Sampling rate settings: 44.1kHz, 48kHz
- \* This parameter can be set for each Program.
- \* The setting can be saved and loaded as part of the song data.
- \* This setting will be retained after you turn off the power.

# Refer to "2-2. Setting a sampling rate" on page 47 for information on how to set the sampling rate of the selected Program.

After setting the sampling rate, press the DISP SEL key to display the REMAIN indication and check the remaining time available for recording. If there is not enough time for recording, try to increase the time by using the Cut function to move the ABS END point of another Program forward, or by saving the song data of Programs that are not often used to a DAT machine to clear that data from the unit.

**<Note>**

A 48kHz sampling rate setting requires more disk space than the 44.1kHz setting. This means that the available recording time would be shorter.

- # Refer to page 88 for more information on the Cut function.
- # Refer to page 92 for more information on saving song data.

**Setting up a digital input track**

Set the input tracks according to the type of digital signal selected in "dG in" in Setup mode.

- \* Initial setting: L - R - (No assignment for both L and R)
- \* Options: Lch = 1-8, adtl - (no assignment), Rch = 1-8, - (no assignment)
- \* This parameter is common to all Programs.
- \* This parameter setting cannot be saved or loaded as part of the song data.
- \* This parameter settings will be retained after the power is turned off.

# Refer to "14. Setting digital input track In Setup mode" on page 132 for more information on the procedure and details.

**<Notes>**

- \* Tracks assigned for digital input will accept only a digital signal, not an analog signal. If an adat digital signal is input, all tracks are used for digital input. An analog signal will not be accepted. If you wish to input an analog signal, you need to change the digital input assignment to another track or make no assignment.
- \* This setting will automatically disable the Vari-pitch function (the LED will be turned off).



\* Do not remove the optical cable or perform any other operation that would disconnect the digital signal until the session is complete. Otherwise, the D-90 will generate noise, and affect the connected device.

This is because the D-90 is locking to the word clock signal input from the external device when the digital input track is set and "DIGITAL (red)" lights up. .

**Selecting a recording track**

Press the RECORD TRACK select key of the recording track to set that track in ready mode.

**Recording**

1. Press the REWIND button while holding down the STOP button to locate the top of the Program (ABS 0) (LOCATE ABS 0).
2. Confirm that the "DIGITAL" indicator on the display is lit in red, and press the RECORD button while holding down the PLAY button to start recording. You do not need to adjust the recording level in digital recording.
3. Start playing back on the external digital device. Check to see if the level meter of the D-90 is moving, responding to the input signal.
4. When recording is complete, stop the D-90 and the external device.

**<Note>**

If you do not perform further digital recording, set the L and R channel assignments to "--" (no assignment). This will prevent an interrupted signal or the occurrence of noise due to digital looping.

**4-2. Digital recording to an external digital device**

This section explains how to record a digital data from the D-90 to an external digital device

\* Restore the default settings on the D-90.

**Connecting an external digital device**

Connect the DATA OUT connector of the D-90 with the digital input of an external digital device.

**<Note>**

The D-90 switches the DATA OUT connector between the S/P DIF digital signal (OPTICAL) and the adat digital signal during setting of the digital input track in Setup mode. Both signals use the same connector configuration, but carry different data.

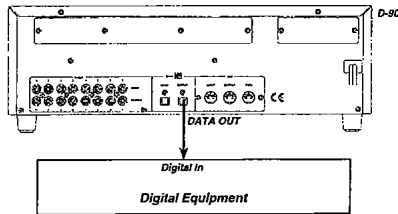

## D-90 Owner's Manual (Recording/Playback)

\* If the external device has only the coaxial (RCA) type digital output connector, use an optional COP-1 optical/coaxial converter to connect the device to transmit an S/P DIF digital signal. The operation is the same as that for a device with a coaxial connector.

\* If you connect both the digital input and output of the D-90 to those of an external digital device, a digital loop may be generated. Refer to "4-3. Connecting a digital mixer" for more information.

### Selecting a playback Program

There are two methods by which you can select a playback Program, as follows:

1. Press the STORE key while holding down the HOLD> key to proceed to the next Program.
2. Press the HOLD> key while holding down the STORE key to go back to the previous Program.

# Refer to "2-1. Setting a Program" for more information on Programs.

### Setting the sampling rate for a playback Program

You need to set the sampling rate of a playback Program to match that of the digital device before recording digital data.

#### \*\*\*\*IMPORTANT\*\*\*\*

When a digital signal is output from the D-90, be sure to match the sampling rate of external digital device to that of the D-90. If the sampling rate setting does not match, you cannot record the S/P DIF digital signal and noise may be generated. Refer to "2-2 Setting a sampling rate" for more information on how to check the sampling rate of the selected Program. You can also check the rate via the 48kHz LED located above the detachable controller. (OFF: 44.1kHz, ON: 48kHz)

### Setting up a digital output track

Set the output tracks according to the type of digital signal selected in "dG out" in Setup mode.

# Refer to "15. Setting a digital output track in Setup mode" on page 134 for more information on the procedure and details.

\* Initial setting: adat

\* Options: adat, ch12, ch34, ch56, ch78

\* This parameter is common to all Programs.

\* This parameter setting cannot be saved or loaded as part of the song data.

\* This parameter settings will be retained after the power is turned off.

\* All tracks including tracks specified for digital output also output analog signal.

### Setting up an external device

Set the external device so that it will accept a digital signal. On some devices, you may need to set it so that the device will synchronize to the input digital signal. For example, if you are using a Fostex RD-8, select "DIGITAL IN" for input, and set "Clock Source" (external sync signal) to "Word Optical (adat)."

#### <Note>

When you are monitoring the digital signal from the external device and notice that the signal cannot be input or digital noise is generated, check the connection, cabling, and settings on the D-90 and the external device.

# Refer to the instruction manual that came with the external digital device for more information.

**Recording**

1. Press the **REWIND** button while holding down the **STOP** button to locate the top of the Program (ABS 0) (LOCATE ABS 0).
2. Start recording on the external device.  
You do not need to adjust the recording level in digital recording.
3. Press the **PLAY** button to start playing back on the D-90.  
Check to see if the level meter of the external device is moving, responding to the input signal.
4. When recording is complete, stop the D-90 and the external device.

**4-3. Connecting a digital mixer**

**\*\*\*\* About Digital Loop \*\*\*\***

As shown in the figure, connecting the input and output connectors of the D-90 to the output and input of a digital mixer respectively may cause digital looping. When you select a digital input track, the D-90 will automatically enter "sync to the external word clock in digital input signal" mode. If you set the connected digital mixer to the same condition (that is, "sync to the external word clock in digital input signal" mode), both devices will try to lock to the external word clock, resulting in a digital loop that prevents synchronization from being established. To avoid this situation, follow one of the suggestions below, depending on the type of the connected mixer.

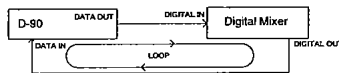

**A. Using a digital mixer that accepts a digital signal if you select its internal clock as sync source:**  
The mixer is always able to input and output a digital signal to and from the D-90. Select an appropriate digital signal to input in the "digital input track" parameter on the D-90. The D-90 will lock to the external word clock.

**B. Using a digital mixer that locks to the external clock when you select digital input on the D-90:**  
You need to change the settings on both devices. If you wish to input a digital signal to the D-90, select an appropriate digital signal to input in the "digital input track" parameter. You cannot select "digital in" on the digital mixer. On the other hand, if you wish to input a digital signal to the digital mixer, select "digital in" on the digital mixer, and set the "digital input track" parameter of the D-90 to "L. R." (no assignment).

This section uses a digital mixer as an example, but the same problem applies to any other digital device. Any digital device (DAT, adat, etc.) can replace the digital mixer in this explanation.

The precaution described above applies to a system in which both the input and output of the D-90 are connected to the output and input of the external device respectively. If you connect either one of them (output or input), the device that accepts the input signal will lock and sync to the output device.

The example here uses a digital mixer that can accept a digital input signal when its internal clock (INTERNAL) is selected.

**Connecting a digital mixer**

Connect the DATA IN jack of the D-90 to the digital output jack of the digital mixer, and the DATA OUT jack of the D-90 to the digital input jack of the mixer.

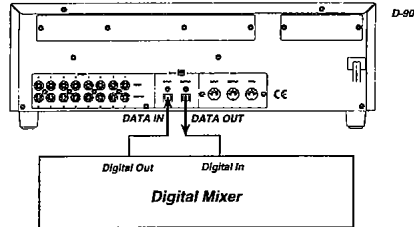

**Setting a digital mixer**

1. Select the internal clock (INTERNAL).
2. Set the mixer so that it will be able to accept a digital input signal.

# Refer to the instruction manual that came with the external digital device.

**Setting the D-90**

1. Select a Program.  
# Refer to "2-1. Setting a Program" for the procedure and details.
2. Set a sampling rate.  
Set the sampling rate of the D-90 to that of the digital mixer.  
# Refer to "2-2. Setting a sampling rate" for the procedure and details.
3. Set the digital input track in Setup mode according to the type of the digital input signal.  
# Refer to "14. Setting a digital input track in Setup mode" on page 132 for the procedure and details.
4. Set the digital output signal in the digital output track parameter in Setup mode.  
# Refer to "15. Setting a digital output track in Setup mode" on page 134 for the procedure and details.

**<Note>**

Avoid the situation in which one type of digital signal is input while a different type of digital signal is output (e.g., the D-90 outputs an S/P DIF digital signal while receiving an ADAT digital signal). The signal may not be output correctly. Select a different type of signal for the output after the D-90 finishes receiving digital data.

## Locate Function

Since the D-90 uses a hard disk as storage media, it can locate any point immediately. Using the Locate function allows you to quickly locate points stored at the CLIP BOARD IN/OUT key, AUTO PUNCH IN/OUT key, AUTO RTN START/END key, LOCATE key, or at the beginning of the hard disk (ABS TIME 0), or at the end of recording area (ABS TIME END).

This function is also very useful for rehearsal before recording, rehearsing during mixdown, and rehearsal for Auto Punch In/Out recording. This chapter describes how to use these Locate functions.

### 1. Locate

Use the following key sequences to locate a certain point. In this table, "+" indicates that you need to press the specified key while pressing and holding down the STOP button. "-"> indicates that you need to first press one key, then press a second key.

1	STOP+REWIND	Locates the beginning of the hard disk (ABS 0).
2	STOP+F FWD	Locates the end of the recorded area on the hard disk (ABS END).
3	CLIPBOARD IN->LOCATE	Locates the stored Clipboard In point.
4	CLIPBOARD OUT->LOCATE	Locates the stored Clipboard Out point.
5	AUTO RTN START->LOCATE	Locates the stored Auto Return Start point.
6	AUTO RTN END->LOCATE	Locates the stored Auto Return End point.
7	AUTO PUNCH IN->LOCATE	Locates the stored Auto Punch In point.
8	AUTO PUNCH OUT->LOCATE	Locates the stored Auto Punch Out point.
9	LOCATE	Locates the stored Locate point (see the note below).

#### <Note>

Please note that each time you use any locate functions other than operations 1, 2, and 9 shown above, the located point data will automatically replace the existing data at the LOCATE key. For example, assume that the LOCATE key has stored data of 00H:05M:30S:00F:00SF. When the Auto Return Start point "00H:03M:00S:00F:00SF" is located, the data stored at the LOCATE key will be changed "00H:03M:00S:00F:00SF." You can check the data stored at the LOCATE key by pressing the RECALL key, then the LOCATE key. You can also edit the data using the JOG dial, and press the STORE key then the LOCATE key to store a locate point which can be accessed by only the LOCATE key itself.

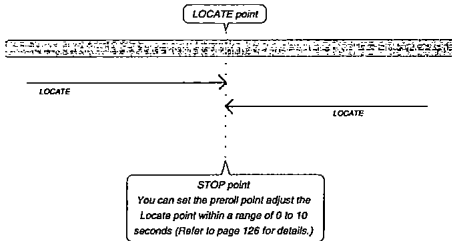

### 2. Auto Play mode

Turn Auto Play mode on before using the Direct Locate function, and the D-90 will automatically start playback from the located point (except when the ABS END point is located). The diagram below illustrates this operation. To turn Auto Play mode on, press the AUTO PLAY/AUTO RTN key so that the AUTO PLAY LED will light up. To cancel this mode, press the AUTO PLAY/AUTO RTN key again so that the AUTO PLAY LED will go off.

# Refer to page "16" "Names and Functions" for instructions on using the AUTO PLAY and AUTO RTN keys.

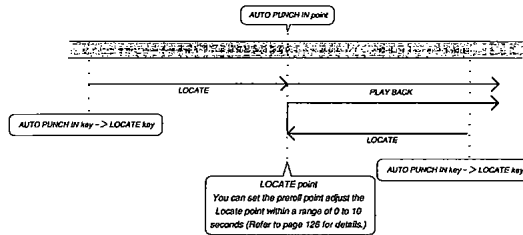

### 3. Auto Return mode

To turn Auto Return mode on, press the AUTO PLAY/AUTO RTN key so that the AUTO RTN LED will light up. To use the Auto Return function, first you need to specify the Auto Return Start point and Auto Return End point. As shown in the diagram below, the D-90 will play back data to the Auto Return End point, then automatically locate the Auto Return Start point, and stop.

<Note>  
The start point will not be locate after the AUTO RTN END point is reached when the D-90 is in record mode.

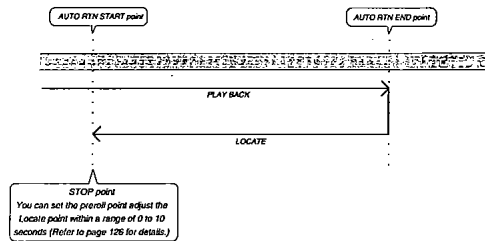

**Setting the Auto Return Start/End point**

There are two ways to set the Auto Return Start point and End point: one is to hold and store a desired time value in real-time during playback or while the D-90 is stopped; the other is to edit and store a desired time.

**Storing the Start/End point in real-time**

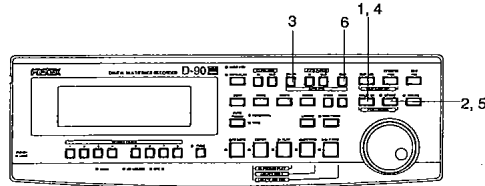

1. While the D-90 is playing back or stopped, press the HOLD/> key at the location you wish to store as a Start point.  
The time value obtained when you press the HOLD/> key will be held, and the D-80 will enter edit mode.

# The display Resolution mode setting is available when BAR/BEAT/CLK is used for the Time Base. Refer to page "135" for details.

2. Press the STORE key. (The STORE LED will light up.)
3. Press the AUTO RTN START key.  
The time value you held will be stored as a Start point, and the display will go back to the previous screen that was obtained before the time value was held. (The STORE LED will go off.)
4. Press the HOLD/> key again at the location you wish to store as an End point.
5. Press the STORE key. (The STORE LED will light up.)
6. Press the AUTO RTN END key.  
The time value you held will be stored as an End point, and the display will go back to the previous screen that was obtained before the time value was held.

\* In steps 1 and 4 described above, you can press the STORE key instead of the HOLD/> key, then press the AUTO RTN START/AUTO RTN END key to set the data more quickly.

**Editing and storing the Start/End point**

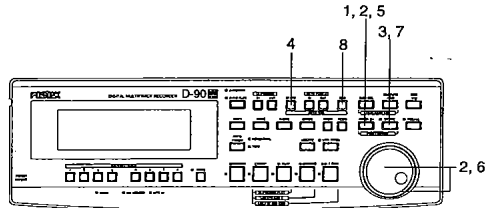

1. Press the **HOLD/>>** key while the D-90 is playing back or stopped.  
The time value at the moment when you pressed the **HOLD/>>** key will be held and the unit will enter edit mode.

\* The display Resolution mode setting is available when BAR/BEAT/CLK is used for the Time Base. Refer to page "135" for details.

2. Move the cursor to the time value (bar) using the **HOLD/>>** key or **SHUTTLE** dial, and use the **JOG** dial to change the value.
3. Press the **STORE** key. (The **STORE LED** will light up.)
4. Press the **AUTO RTN START** key.  
The edited time value will be stored as a Start point, and the display will return to the screen displayed before you held the time value. (The **STORE LED** will go off.)
5. Press the **HOLD/>>** key again.
6. Enter the value as you did in step 2.
7. Press the **STORE** key. (The **STORE LED** will light up.)
8. Press the **AUTO RTN END** key.  
The edited time value will be stored as an End point, and the display will go back to the screen obtained previously before you held the time value.

\* In steps 1 and 5 described above, you can press the **STORE** key instead of the **HOLD/>>** key, edit the time value (bar), then press the **AUTO RTN START/AUTO RTN END** key to set the data more quickly.



**Changing the stored Start / End points**

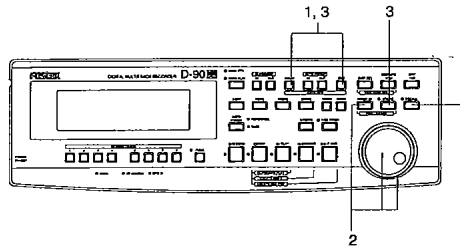

1. Press the **RECALL** key, then the **AUTO RTN START** key or **AUTO RUN END** key.  
(As a short-cut, you can press the **AUTO RTN START** key or **AUTO RTN END** key directly.)  
The display will show the time value stored at the key, and the unit will enter edit mode.
2. Move the cursor to the time value (bar) using the **HOLD/** key or **SHUTTLE** dial, and use the **JOG** dial to change the value.
3. Press the **STORE** key, then press the **AUTO RTN START** key.  
The edited time value will be stored as a Start point or End point.

**<Note>**

Pay attention to the location of the Start and End points. If you have set a larger value to the Start point than the End point while both Auto Return mode and Auto Play mode are on, the D-90 will jump to the Start point and continue to play the rest of the data after playing to the End point (which is located before the Start point). Therefore, the repeat operation (explained later) will not be carried out correctly. Auto Return mode is effective only when the unit is in play mode.

**4. Auto Repeat mode**

The Auto Repeat function is a combination of Auto Play mode and Auto Return mode. To access the Auto Repeat function, press the AUTO PLAY/AUTO RTN key so that both AUTO RTN LED and AUTO PLAY LED will be lit. You also need to set the Auto Return Start point and the Auto Return End point, as you did for the Auto Return function. (Refer to the previous section "Auto Return" for information on setting the Start and End points.) With the Auto Repeat function, the D-90 plays data up to the Auto Return End point, then automatically locates the Auto Return Start point, and plays back data between the Start and End points repeatedly, until you cancel the playback using the STOP button.

# Refer to page "16" of "Names and Functions" for instructions on using the AUTO PLAY and AUTO RTN keys.

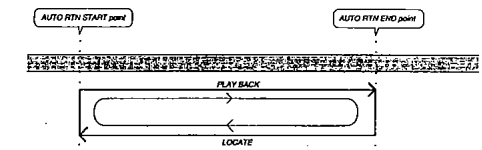

**LOCATE point**  
 You can set the **preread point** adjust the Locate point with a range of 0 to 10 seconds. (Refer to page 126 for details.)

**<Hints>**

When you are rehearsing Auto Punch In/Out recording, using the Auto Repeat function allows you to rehearse as many times as you want without tedious operations. For example, by setting the Start point just before the Auto Punch In point and the End point just before the Auto Punch Out point, you do not worry about locating the data and can concentrate on rehearsing.

Rehearsal will be repeated automatically as many times as you like to make it easier to adjust the recording level.

## Punch In/Out

Punch In/Out recording is used to re-record data onto a certain area of a pre-recorded track. For example, you can replace a phrase from your guitar solo with a better performance.

There are two ways to Punch In/Out record: Auto Punch In/Out recording, in which you specify the Punch In/Out points; and Manual Punch In/Out recording, in which you use optional foot switch Model 8051.

In either case, the Rehearsal function allows you to practice before actual take. Using the Punch In/Out recording technique, you can easily and quickly replace mistakes or phrases you do not like with more desirable takes.

Choose one of these methods to suit your preferences and applications.

- \* The example here explains how to replace "part of the guitar solo" recorded on Track 3 with a new phrase by playing the guitar (connected to Input jack 1), while listening to the drum and bass sound recorded on Tracks 1 and 2. Once you master Punch In/Out recording, you can use this technique for other tracks.
- \* Assume that the guitar is connected to the mixer input, and that the output signal from the mixer is routed to Track 3 of the D-90.
- \* Do not change the Program or sampling rate until the session is complete.
- \* First make sure that the D-90 is set to the default setting.

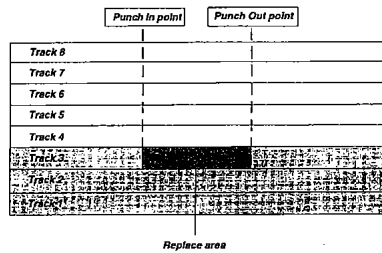

### 1. Auto Punch In/Out

To perform Auto Punch In/Out recording, first you need to specify the In point (recording start point) and the Out point (recording end point). Once these two points are stored, the D-90 automatically starts recording at the In point and stops recording at the Out point while the recorder is in "Take mode." When you use the Auto Punch In/Out function, you can select "Rehearsal mode" to practice to your satisfaction before you record.

#### Storing the Punch In/Punch Out point

Here, we assume that Program 1 with the "ABS" Time Base has been selected. If you wish to choose other Program, press the STORE key while holding down the HOLD/> key.

##### Storing the Punch In point

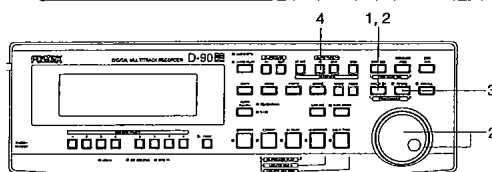

1. Press the HOLD/> key while the recorder is playing back or stopped. The following example shows that a time of two minutes, 40 seconds, 3 frames, and 28 sub-frames is held, and the Program Indication is changed to the sub-frame indication.

ABS  
00 h 02 m 40 s  
03, 28 s

\* Pressing the STORE key will also cause the D-90 to enter hold/edit status. In this case, you can omit step 3 below.

2. Press the HOLD/> key or turn the SHUTTLE dial to select the digit you wish to edit, then use the JOG dial to change the time value.

ABS  
00 h 03 m 15 s  
10, 00 s

3. Press the STORE key. (The STORE LED will light up.)
4. Press the AUTO PUNCH IN key. The specified time value will be stored as a Punch In point, and the STORE LED will go off.

**Storing the Punch Out point**

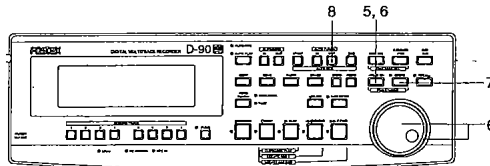

5. Press the **HOLD/>>** key to enter edit mode.

ABS  
00 H 02 M 40 S ——— Blink (Edit point)  
03 F 28 S

6. Press the **HOLD/>>** key or turn the **SHUTTLE** dial to select the digit you wish to edit, then use the **JOG** dial to change the time value.

ABS  
00 H 03 M 35 S  
15 F 00 S

7. Press the **STORE** key. (The **STORE LED** will light up.)

8. Press the **AUTO PUNCH OUT** key.

The specified time value will be stored as a Punch Out point, and the **STORE LED** will go off.

\* To check the stored Punch In/Out point, press the **RECALL** key, then press the **AUTO PUNCH IN** key and/or the **AUTO PUNCH OUT** key. Alternatively, press the **AUTO PUNCH IN/AUTO PUNCH OUT** key. The display will show the stored time value.

**<Note>**

You cannot set the Punch Out point before the Punch In point location. If the Punch Out point precedes the Punch In point and you try to "punch in," the message "Void out" appears on the screen immediately after you press the **AUTO PUNCH** key, indicating that the time value of the Punch Out point is inappropriate. Be sure to specify a larger value for the Punch Out point than for the Punch In point.

**<Hints>**

If "rESolu" mode (Display REsolution mode) has been turned on in Setup mode when the "BAR/BEAT/CLK" Time Based is being used, press the **HOLD/>>** key or the **STORE** key to hold the current bar/beat clock value on the display, and you can round off the clock value to "00" (that is, to a bar/beat value). This function is useful when you wish to use the memory data in beat steps.  
\* Refer to page 135 for more information on Display Resolution mode.

**Auto Punch In/Out Rehearsal mode**

Set the "READY" track into Input monitoring status for the part between the Punch In point and the Punch Out point in Rehearsal mode. (Other tracks are in playback monitoring status.) In Rehearsal mode, nothing is actually recorded. You can repeat rehearsal as many times as you wish adjusting the In point, Out point, and the recording level.

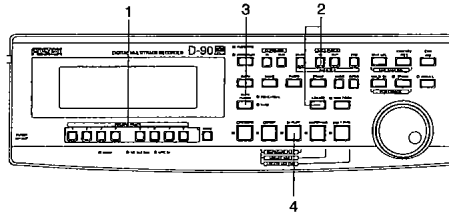

**Rehearsal**

1. Press the RECORD TRACK select "3" key to ready Track 3. ("3" on the display will blink.)
2. Locate a point just before the Punch In point, using one of the following methods: Press the AUTO PUNCH IN key, then the LOCATE key. (The Auto Punch In point will be located.) Then, press the REWIND button, or turn the SHUTTLE dial counter-clockwise to locate a position slightly ahead. Setting a "Pre-roll" value will make it easier to locate a position the specified number of seconds before the Auto Punch In point.)  
Refer to page xx for information on the Pre-roll function.  
Alternatively, you can store the playback start point (time) at the AUTO RTN START for the future locate operations. (You need to use the AUTO RTN START key for step 4 of "Storing the Punch In point.")
3. Press the AUTO PUNCH key. (The REHEARSAL and TAKE LEDs will light up.)  
If the disk does not have enough free space for auto punch in/out, the "Over Time" and "Can't Undo" indications appear. Refer to "Alarm" in the "Display" section in the manual.
4. Press the PLAY button.  
Rehearsal mode is engaged as follows:
5. Rehearse the guitar part while playing back the drum and bass sounds.  
You will hear the guitar sound you are playing only between the punch in and punch out points.

D-90 Owner's Manual (Punch In/Out)

Rehearsal mode (Auto Punch In/Out)		AUTO PUNCH IN point	AUTO PUNCH OUT point
<p>All tracks are under REPRO monitoring status.</p>		<p>Only track 3 enters INPUT monitoring status. (However, the D-90 will not record, and stay in Rehearsal mode.)</p>	<p>All tracks are under REPRO monitoring status.</p>
RECORD TRACK display	3 Blink	3 Light up	3 Blink
REHEARSAL LED TAKE LED	REHEARSAL LED will light up.	REHEARSAL LED will light up.	REHEARSAL LED will light up
PLAY button LED	PLAY LED will light up	PLAY LED will light up	PLAY LED will light up
RECORD button LED		RECORD LED will blink	

**<Hints>**

When you are rehearsing repeatedly, it is an effective time-saver to use the Auto Return function along with the Auto Play function. As shown in the diagram below, specifying the Start and End points for the Auto Return and Auto Play functions allows you to easily rehearse as many times as you like. This enables you to pay more attention to the recording level and your own performance. Refer to pages "63" for more information on setting the Start/End points for the Auto Return/Auto Play functions.

AUTO PUNCH IN point                      AUTO PUNCH OUT point  
AUTO RTN START point                      AUTO RTN END point

Rehearsal will be repeated automatically as many times as you like to make it easier to adjust the recording level.

**Auto Punch In/Out Take mode (actual recording)**

Proceed to recording after rehearsal.

**Take**

1. Check to see which tracks are in ready mode.  
Please note that data will be recorded in all tracks set to ready mode.
2. As in Rehearsal mode, locate the point just before the Punch In point.
3. Auto Punch mode is "on".
4. Press the RECORD button while pressing and holding down the PLAY button.  
The REHEARSAL LED will go off and the TAKE LED will light up.
5. Play the guitar while listening to the playback sound.  
As shown in the illustration below, the recorder will start recording automatically at the Punch In point, and stop recording at the Punch Out point.

\* When recording is finished, Auto Punch mode will be cancelled, and both REHEARSAL and TAKE LEDs will go off.

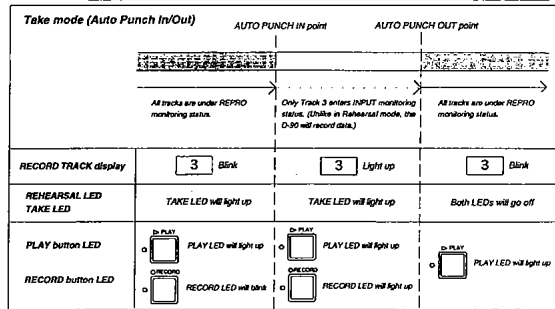

**<Undo/Redo of Auto Punch In>**

When you auto punch in/out record while the "CANT UNDO" warning message is not displayed, you will be able to undo or redo the take.

- \* If you press the UNDO key after performing the auto punch in/out operation, the original sound recorded prior to auto punch in/out will be restored.
- \* If you press the REDO key after undoing the auto punch in/out operation, the auto punch in/out data will be restored.

**<Note>**

You can use the undo/redo functions while the D-90 is in stop mode.  
Under the following circumstances, you will be unable to use the undo/redo functions:

1. if you make a new recording,
2. if you make a new edit (copy & paste, move & paste, erase, or cut),
3. if the Auto Punch In point was passed in play or record mode while Auto Punch mode was on, or
4. if you turned off the power to the D-90, then turned it back on.



## 2. Punch In/Out Recording using a foot switch

"Take mode" and "Rehearsal mode" are also available in this application. Pressing the foot switch repeatedly while holding down the STOP button will toggle between "take" and "rehearsal." The REHEARSAL LED of the AUTO PUNCH key will blink during Rehearsal mode, and the LED will be off during "Take mode."

1. Select the track onto which you wish to punch in/out record.
2. Start playback just before the punch in point.
3. Press the foot switch when you want to start recording.
4. Press the foot switch again when recording is finished.

In this lesson, we are going to replace part of the guitar solo recorded on Track 3, as we did in the Auto Punch In/Out section.

- Set the D-90 to the default setting.
- Use an optional foot switch Model 8051 for punch in/out recording.
- Set Auto Punch mode to OFF. (The REHEARSAL LED and the TAKE LED will be turned off.)
- Do not change the Program or sampling rate until the session is complete.

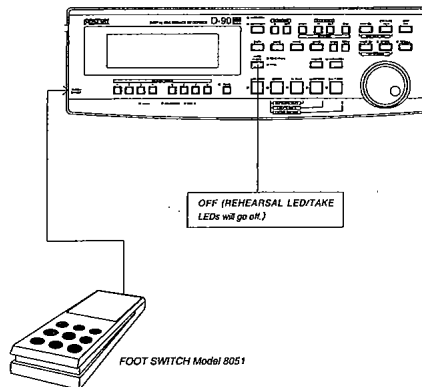

### <CAUTION>

Turn off the D-90 before connecting or disconnecting any cables. Connecting or disconnecting the footswitch or detachable controller cables while the D-90 is turned on will cause it to malfunction.

**Punch In/Out Rehearsal (Using a foot switch)**

**Rehearsal**

1. Press the foot switch once while holding down the STOP button.  
The recorder enters "Rehearsal" mode, and the 7-segment display on the upper row of the screen will show "REHSAL", and the 7-segment display on the bottom row will show "on" for one second. Only the REHEARSAL LED (green) will blink.
2. Press the RECORD TRACK select key "3" to set Track 3 to ready mode. (Indicator "3" will flash.)
3. Press the PLAY button at a location just before the punch in point to play back data.
4. Rehearse the guitar part while playing back the drum and bass sounds.
5. Press the foot switch once at the Punch in point, and press the foot switch again at the Punch Out point. The following diagram illustrates this operation. You will hear the guitar sound you are playing only between the punch in and out points.

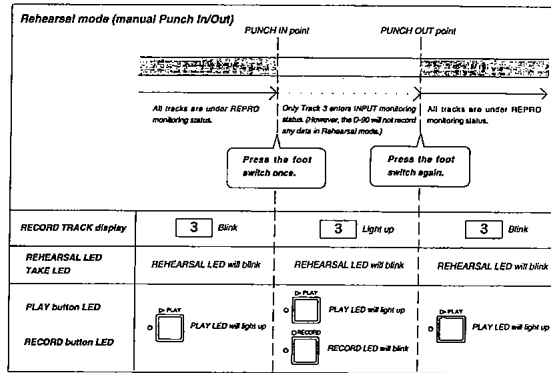

**End of rehearsal**

1. Press the foot switch again while holding down the STOP button to cancel Rehearsal mode.  
The 7-segment display on the upper row of the screen will show "REHSAL", and 7-segment display on the bottom row will show "oFF" for one second. Also, the REHEARSAL LED (green) will turn off, indicating that you quit Rehearsal mode.

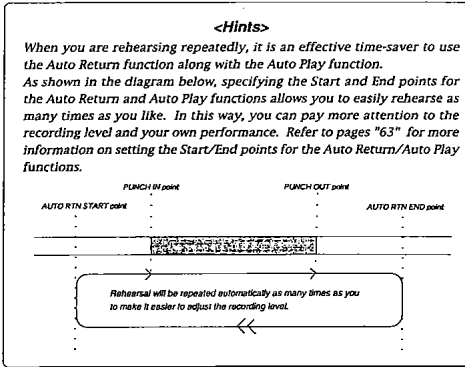

**Punch In/Out Take (manual Punch In/Out)**

1. Locate the point just before the punch in point and play back the data.
  2. Play the guitar while listening to the playback.
  3. Press the foot switch once at the punch in point, and press the foot switch again at the punch out point.
- When you finish punch out recording, the D-90 will quit recording mode.

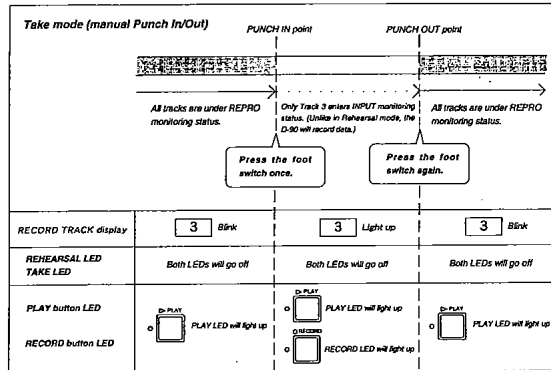

**<Note>**

Once you perform Punch In/Out recording using a footswitch, you need to stop the D-90 before performing the next Punch In/Out take.

**<Hints>**

Besides the foot switch, you can also use the PLAY button and RECORD button for Manual Punch In/Out recording. (Please note that you can use these buttons only once.)

1. Start playing back from a point just before the punch in point.
2. At the punch in point, press the RECORD button while holding down the PLAY button. (Punch In)
3. At the punch out point, press only the PLAY button. (Punch Out)

\* You can also rehearse if you "press only the RECORD button" instead of steps 2 and 3 described above.

**<Note>**

You cannot use the Undo/Redo function for the manual punch in/out operation with a normal setting.

If you wish to use the Undo/Redo function for the manual punch in/out operation (including a punch operation using a foot switch), set a valid area for the Undo function ("Undo") in Setup mode.

Refer to page xx for more information on setting a valid area for the Undo function.

### 1. Copy & Paste

The Copy & Paste functions use the clipboard of the D-90, allowing you to copy sound data and paste it to the specified area. The copied data remains on the clipboard after you paste it, and you can paste the same data as many times as you want to different places. The Copy & Paste functions can reference any one of the following time bases: ABS time, MTC time, MIDI Bar/Beat/Clock.

- To perform the Copy operation, you first need to set the start point (Clipboard In point) and the end point (Clipboard Out point) of the copied data and the copy source track.  
To perform the Paste operation, you need to set the start point (Auto Punch In point) and the paste destination point.

**<Note-1>**

The data on the Clipboard will be replaced by new data each time you press the COPY key of the MOVE key.

**<Note-2>**

If pasted data overlaps the source data, the content of the source data will be altered.

### Copying

First, you need to specify the area to be copied (using the Clipboard In/Out points and copy track).

- The following procedure is based on data with the ABS Time Base.  
To change the Time Base to MTC or MIDI BAR/BEAT/CLK, press the DISP SEL key while pressing and holding down the EXECUTE/YES key.
- Before you start working, restore the default settings on the D-90.
- Do not change Programs or sampling rates until a session is complete.

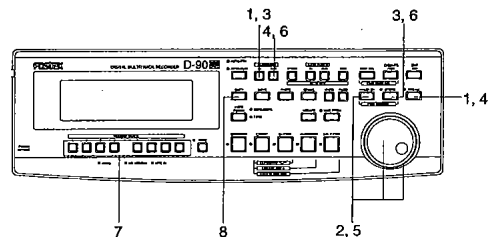

#### Entering and storing the CLIPBOARD IN point

1. Press the RECALL key, then the CLIPBOARD IN key (or press only the CLIPBOARD IN key), and the unit will enter edit mode.
2. Move the cursor to the digit you wish to change using the HOLD/> key or the SHUTTLE dial, and change the value using the JOG dial.

## Edit Function

This chapter describes various editing functions on the D-90. The D-90 uses the hard disk as a recording media, which allows for non-linear, non-destructive, quick audio editing. The edit function includes the Copy & Paste, Move & Paste, Erase, and Cut functions.

### <Precautions for editing>

The D-90 accommodates nine Programs, P1-P9, each of which you can record and edit individually. First, make sure that you are about to edit the correct Program. If you start editing without first checking the Program, you may lose important data. Refer to the previous section, "Setting a Program," for more information on how to set a Program. Do not change Programs or sampling rates until a session is complete.

### <Difference between Copy & Paste and Move & Paste>

- The Copy & Paste function allows you to copy data to the Clipboard, and paste it to any location in any track. In this case, the copy source data remains as is, as does the data on the Clipboard.
- The Move & Paste function is almost the same as the Copy & Paste, except that executing the Move & Paste function will erase the move source data (the Clipboard will be also cleared).

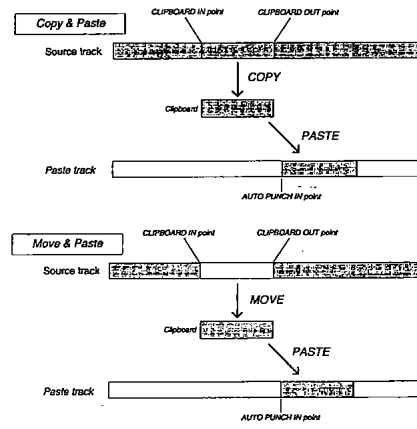

3. After setting the value, press the STORE key, then the CLIPBOARD IN key. The time value will be stored as the Clipboard In time, edit mode will disengage, and the display will return to the previous screen.

**Entering and storing the CLIPBOARD OUT point**

4. Press the RECALL key, then the CLIPBOARD OUT key (or press only the CLIPBOARD OUT key), and the unit enters edit mode.
5. Move the cursor to the digit you wish to change using the HOLD/> key or the SHUTTLE dial, and change the value using the JOG dial.
6. After setting the value, press the STORE key, then the CLIPBOARD OUT key. The time value will be stored as the Clipboard Out time, edit mode will disengage, and the display will return to the previous screen.

- \* To check the stored In/Out points, press the CLIPBOARD IN key and CLIPBOARD OUT key respectively. The time value you just stored will be shown on the display.
- \* You can perform steps 1-3 in real-time. (Pressing the STORE key, then the CLIPBOARD IN key while playing back the recorder will store data.)

**<Hints>**

When you are storing the In/Out points in real-time while using the "BAR/BEAT/CLK" Time Base, you can store them in steps of beats if the "rEsolu" (Display Resolution mode ON/OFF) in Setup mode is "ON."  
When this resolution mode is "ON," the CLK value will be rounded up or off to "00" (at the beginning of the beat) as soon as you press the STORE key. This function is useful when you wish to use the Copy & Paste or Move & Paste function in setups of beats. Refer to page "135" for detailed operation.

**Copying the track data after storing the CLIPBOARD IN/OUT points**

7. Select the copy track using the RECORD TRACK select keys (you can select multiple tracks).

- \* You can select one (mono) track, multiple tracks, or all eight tracks. When using the Copy & Paste function, however, you can change the paste destination track only when you have selected a mono track, or an odd-numbered track and the adjacent even-track (i.e.: 1-2, 3-4, 5-6, or 7-8). If you have copied multiple tracks (other than the above combination), the data will be pasted to the copy source tracks. (track 1-> track 1.....track 3-> track 3 etc.)

8. Press the COPY key. Copy is immediately completed. The display will show "COMPLETED!" and return to the previous screen.

In this way, the specified part of the sound data of the selected track(s) is copied to the clipboard.

**<Note 1>**  
If you press the COPY key without selecting a copy source track by the RECORD TRACK select key, the display will show "SELECt trk" (meaning "Select a copy track.") and return to the previous screen. In this case, select a copy source track and try again to copy the data.

**<Note 2>**  
If the Output point has been specified before the In point (the In point value is the same or larger than the Out point value), the display will show the error message "Void in" or "Void Out" and return to the previous screen. In this case, set correct In/Out points and try again to copy the data.

**<Note 3>**  
The data on the Clipboard will be replaced by new data each time you press the COPY key or the MOVE key.

**Listening to sound data copied on the clipboard (Clipboard Play function)**

To listen to the sound data currently copied to the clipboard, press the PLAY button while holding down the STOP button (Clipboard Play mode). The data will be played back from the beginning. To stop the playback in the middle, press the STOP button.

\* During the clipboard playback, the display shows the position of the source data referenced to the selected time base.

**Copy & Pasting**

You can paste data to the same track as the source. For example, if you copied data on Track 1, data will be pasted on Track 1. Data will be pasted starting from the Auto Punch In point.

**<Note>**  
You need enough unrecorded space on the hard disk to execute the Copy & Paste operation. If you press the EXECUTE/YES key to try to paste data with insufficient disk space, the display will immediately show the error message "Over Time", then show the excess time using the currently-selected Time Base (time or bar). In this case, shorten the copy data by the amount of excess time. Alternatively, move ABS END backward using the CUT function as described in page "88" of this manual in order to obtain more free space on the hard disk.

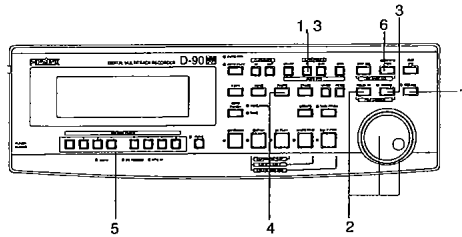



**<Note 1>**

The Copy & Paste function is available only when the hard disk has enough space (REMAIN) to perform the following Undo/Redo operation.

If you try to copy & paste the data without enough free space on the hard disk, the display will indicate the alarm message "ovEr" (overtime error) as soon as you press the PASTE key, then indicate the excessive time in the currently-selected Time Base.

To avoid this, shorten the data to be copied, by the amount of the exceeding time, or use the Cut function to create free disk space as described later in order to move the ABS END point.

**<Note 2>**

Do not copy data and paste it partially over itself (same track and part of the same time frame). This will alter both the copy source data and the data currently contained in the clipboard.

If you accidentally perform this undesirable operation, use the Undo function as explained in the following section. You will not be able to restore the original data if you proceed with editing without first performing the Undo operation.

You can also paste the move data repeatedly by specifying the number of repeats (0-99). The difference between "Move & Paste" and "Copy & Paste" is that moving data will cause the source sound data to move to the Clipboard, then to the destination, and the data in the source or in the Clipboard will be erased. This operation is available with any Time Base.

**<Copy & Paste Undo/Redo>**

If you wish to restore data that existed before you executed the Copy & Paste function, press the UNDO key to restore the status obtained before you pasted the data. Pressing the REDO key after pressing the UNDO key will restore the status before the Undo operation (that is, after pasting). The Undo and Redo functions are effective only while the D-90 is stopped.

After the UNDO key or REDO key is pressed, the display will show "COMPLETED!" and return to the previous screen.

**<Note>**

You can use the undo/redo functions while the D-90 is in stop mode. Under the following circumstances, you will be unable to use the undo/redo functions:

1. if you make a new recording,
2. if you make a new edit (Copy & Paste, Move & Paste, Erase, or Cut),
3. if the Auto Punch In point was passed in play or record mode while Auto Punch mode was on, or
4. if you turned off the power to the D-90, then turned it back on.

**Entering and storing the paste Punch In point**

1. Press the **RECALL** key, then the **AUTO PUNCH IN** key (or press only the **AUTO PUNCH IN** key), and the unit enters edit mode.
2. Move the cursor to the digit you wish to edit using the **HOLD>** key or the **SHUTTLE** dial, and set the value using the **JOG** dial.
3. After setting the time value, press the **STORE** key, then the **AUTO PUNCH IN** key.  
The time value will be stored as the start point of the pasting area, and the display will go back to the previous screen.

**Executing the paste operation**

4. Press the **PASTE** key.  
The display will show the blinking message "SURE!" and the bottom row of the 7-segment display will show "rPt 01" ("01" will blink) and "PAsT."
5. Specifying the copy destination track and the number of repeats to paste.  
  - \* Specifying the Copy & Paste destination track:  
Select the destination track using the **RECORD TRACK** select key. (You do not need to specify the track if you are going to Copy & Paste data in the copy source track.)
  - \* Specifying the number of repeats to Copy & Paste:  
Turn the **JOG** dial to change the blinking number "01" to any value between 01 and 99. (If there is not enough free space on the hard disk, the repeat time will be limited to a number less than 99, and you will be unable to specify a larger number when you turn the **JOG** dial.)
6. Press the **EXECUTE/YES** key.  
The upper row of the display will show the time taken for the Copy & Paste operation, then "CoPY", "PAsT", then "COMPLETED!". Press the **EXIT/NO** key to go back to the previous screen.

Now the audio data on the Clipboard has been pasted to the specified track starting with the **AUTO PUNCH IN** point.  
For example, executing the function with a repeat number of "rPt 03" (three times) will paste the data as shown in the diagram below.

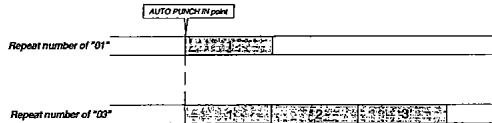

\* To cancel the paste operation, press the **EXIT/NO** key while the message "SURE!" is blinking on the display.  
If you wish to cancel the paste operation after you press the **EXECUTE/YES** key, press the **STOP** button or the **EXIT/NO** key before the "COMPLETED!" message appears on the display.  
If you abort the paste operation using this procedure (even in the middle of the operation), no data will be pasted.

## 2. Move & Paste

The Move & Paste function "moves" sound data to the Clipboard, and "pastes" the data in the same track or another track. You can specify the number of repeats of the paste operation (0-99) to paste data repeatedly. The difference between the Copy & Paste and the Move & Paste operation is that after the Move & Paste operation the source data and the data on the Clipboard will be removed. You can use this function with any Time Base.

\* To perform the Move operation, you first need to set the start point (Clipboard In point) and the end point (Clipboard Out point) of the data to be moved, and the move source track. To perform the Paste operation, you need to set the start point (Auto Punch In point) and the paste destination point.

### <Note>

The data on the Clipboard will be replaced by new data each time you press the COPY key or the MOVE key.

### Moving

First, you need to specify the area to be moved (using the Clipboard In/Out points and move track).

\* The following procedure is based on data with the ABS Time Base.  
To change the Time Base to MTC or MIDI BAR/BEAT/CLK, press the DISP SEL key while pressing and holding down the EXECUTE/YES key.  
\* Before you start working, restore the default settings on the D-90.  
\* Do not change Programs or sampling rates until a session is complete.

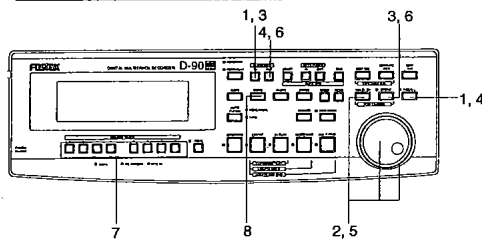

### Entering and storing the CLIPBOARD IN point

1. Press the RECALL key, then the CLIPBOARD IN key (or press only the CLIPBOARD IN key), and the unit will enter edit mode.
2. Move the cursor to the digit you wish to change using the HOLD> key or the SHUTTLE dial, and change the value using the JOG dial.
3. After setting the value, press the STORE key, then the CLIPBOARD IN key. The time value will be stored as the Clipboard In time, edit mode will disengage, and the display will return to the previous screen.

**Entering and storing the CLIPBOARD OUT point**

4. Press the **RECALL** key, then the **CLIPBOARD OUT** key (or press only the **CLIPBOARD OUT** key), and the unit enters edit mode.
5. Move the cursor to the digit you wish to change the **HOLD/** key or the **SHUTTLE** dial, and change the value using the **JOG** dial.
6. After setting the value, press the **STORE** key, then the **CLIPBOARD OUT** key. The time value will be stored as the Clipboard Out time, edit mode will disengage, and the display will return to the previous screen.

- \* To check the stored In/Out points, press the **CLIPBOARD IN** key and **CLIPBOARD OUT** key respectively. The time value you just stored will be shown on the display.
- \* You can perform steps 1-3 in real-time. (Pressing the **STORE** key, then the **CLIPBOARD IN** key while playing back the recorder will store data.)

**<Hints>**

When you are storing the In/Out points in real-time while using the "BAR/BEAT/CLK" Time Base, you can store them in steps of beats if the "rESoLu" (Display Resolution mode ON/OFF) in Setup mode is "ON."  
When this resolution mode is "ON," the CLK value will be rounded up or off to "00" (at the beginning of the beat) as soon as you press the **STORE** key.  
This function is useful when you wish to use the Copy & Paste or Move & Paste function in steps of beats. Refer to page "135" for detailed operation.

**Moving the track data after storing the CLIPBOARD IN/OUT points**

7. Select the move track using the **RECORD TRACK** select keys (you can select multiple tracks).

- \* You can select one (mono) track, multiple tracks, or all eight tracks.  
When using the Copy & Paste or Move & Paste function, however, you can change the paste destination track only when you have selected a mono track, or an odd-numbered track and the adjacent even-numbered track (i.e.: 1-2, 3-4, 5-6, or 7-8).  
If you have moved multiple tracks (other than the above combination), the data will be pasted to the move source tracks. (track 1-> track 1.....track 3-> track 3 etc.)

8. Press the **MOVE** key.

Move is immediately completed.  
The display will show "Move Clip" and "COMPLETED!" and return to the previous screen.

Now the sound data in the specified track has been moved to the Clipboard. At this point, the move source data has yet been deleted. It will be deleted after you perform the paste operation.

**<Note 1>**  
If you press the MOVE key without selecting a move source track by the RECORD TRACK select key, the display will show "SELECT trk" (meaning "Select a move track.") and return to the previous screen. In this case, select a move source track and try again to copy the data.

**<Note 2>**  
If the Output point has been specified before the In point (the In point value is the same or large than the Out point value), the display will show the error message "Void In" or "Void Out" and return to the previous screen. In this case, set correct In/Out points and try again to move the data.

**<Note 3>**  
The data on the Clipboard will be replaced by new data each time you press the COPY key or the MOVE key.

**Listening to sound data moved on the clipboard (Clipboard Play function)**

To listen to the sound data currently moved to the clipboard, press the PLAY button while holding down the STOP button (Clipboard Play mode). The data will be played back from the beginning. To stop the playback in the middle, press the STOP button.

\* During the clipboard playback, the display shows the position of the source data referenced to the selected time base.

**Move & Pasting**

The data will be move & pasted at the point stored in the Auto Punch In key. You can select the paste destination track the RECORD TRACK select key.

**<Note>**  
You need enough unrecorded space on the hard disk to execute the Move & Paste operation. If you press the EXECUTE/YES key to try to paste data with insufficient disk space, the display will immediately show the error message "Over Time," then show the excess time using the currently-selected Time Base (time or bar). In this case, shorten the move data by the amount of excess time. Alternatively, move ABS END backward using the CUT function as described in page "88" of this manual in order to obtain more free space on the hard disk.

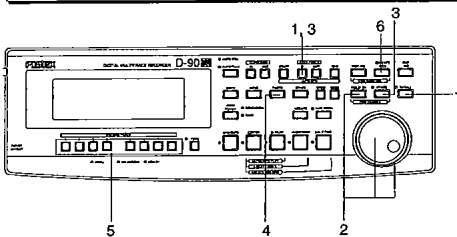

**Entering and storing the paste Punch In point**

1. Press the RECALL key, then the AUTO PUNCH IN key (or press only the AUTO PUNCH IN key), and the unit enters edit mode.
2. Move the cursor to the digit you wish to edit using the HOLD> key or the SHUTTLE dial, and set the value using the JOG dial.
3. After setting the time value, press the STORE key, then the AUTO PUNCH IN key.  
The time value will be stored as the start point of the pasting area, and the display will go back to the previous screen.

**Executing the paste operation**

4. Press the PASTE key.  
The display will show the blinking message "SURE?" and the bottom row of the 7-segment display will show "rPt 01" ("01" will blink) and "MoVE."
5. Specify the Move & Paste destination track and the number of repeats to paste.
  - \* Specifying the Move & Paste destination track:  
Select the destination track using the RECORD TRACK select key. (You do not need to specify the track if you are going to Move & Paste data in the copy source track.)
  - \* Specifying the number of repeats to Move & Paste:  
Turn the JOG dial to change the blinking number "01" to any value between 01 and 99. (If there is not enough free space on the hard disk, the repeat time will be limited to a number less than 99, and you will be unable to specify a larger number when you turn the JOG dial.)
6. Press the EXECUTE/YES key.  
The upper row of the display will show the time taken for the Move & Paste operation, then "MoVE", "PAST", then "COMPLETED!". Press the EXIT/NO key to go back to the previous screen.

Now the audio data on the Clipboard has been pasted to the specified track starting with the AUTO PUNCH IN point.  
For example, executing the function with a repeat number of "rPt 03" (three times) will paste the data as shown in the diagram below.

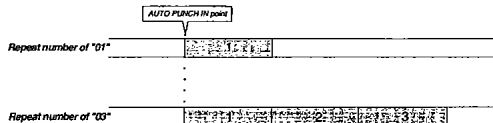

\* To cancel the paste operation, press the EXIT/NO key while the message "SURE?" is blinking on the display.  
If you wish to cancel the paste operation after you press the EXECUTE/YES key, press the STOP button or the EXIT/NO key before the "COMPLETED!" message appears on the display.  
If you abort the paste operation using this procedure (even in the middle of the operation), no data will be pasted.

**<Note 1>**

The data on the Clipboard will be cleared after the Move & Paste operation is complete. Unlike the Copy & Paste operation, you cannot move and paste the same data repeatedly.

**<Note 2>**

The Move & Paste function is available only when the hard disk has enough space (REMAIN) to perform the following Undo/Redo operation. If you try to move & paste the data without enough free space on the hard disk, the display will indicate the alarm message "over" (overtime error) as soon as you press the PASTE key, then indicate the excessive time in the currently-selected Time Base. To avoid this, shorten the data to be copied, by the amount of the exceeding time, or use the Cut function to create free disk space as described later in order to move the ABS END point.

**<Note 3>**

Do not copy data and paste it partially over itself (same track and part of the same time frame). This will alter both the copy source data and the data currently contained in the clipboard. If you accidentally perform this undesirable operation, use the Undo function as explained in the following section. You will not be able to restore the original data if you proceed with editing without first performing the Undo operation. You can also paste the move data repeatedly by specifying the number of repeats (0-99). The difference between "Move & Paste" and "Copy & Paste" is that moving data will cause the source sound data to move to the Clipboard, then to the destination, and the data in the source or in the Clipboard will be erased. This operation is available with any Time Base.

**<Move & Paste Undo/Redo>**

If you wish to restore data that existed before you executed the Move & Paste function, press the UNDO key to restore the status obtained before you pasted the data. Pressing the REDO key after pressing the UNDO key will restore the status before the Undo operation (that is, after pasting). The Undo and Redo functions are effective only while the D-90 is stopped. After the UNDO key or REDO key is pressed, the display will show "COMPLETED!" and return to the previous screen.

**<Note>**

You can use the undo/redo functions while the D-90 is in stop mode. Under the following circumstances, you will be unable to use the undo/redo functions:

1. if you make a new recording,
2. if you make a new edit (Copy & Paste, Move & Paste, Erase, or Cut),
3. if the Auto Punch In point was passed in play or record mode while Auto Punch mode was on, or
4. if you turned off the power to the D-90, then turned it back on.

### 3. Erase & Cut

The Erase function and Cut function are two different function, and are defined as follows on the D-90. Make sure that you understand the difference before using these functions.

**<Note>**  
The Cut/Erase function is effective only for the currently-selected Program.

#### Erase:

This function deletes (creates silence) only a specified area (between the Auto Punch In and Auto Punch Out points) of any track on the hard disk. Refer to the diagram below. You cannot erase data on all tracks simultaneously. (To erase data, "ready" up to seven tracks using the RECORD TRACK select keys.) Refer to the following note for information on erasing all tracks data.

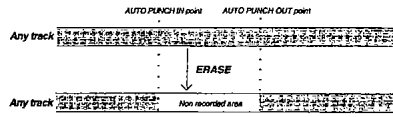

#### <Note>

The Cut function erases data from all tracks simultaneously (described later). To erase data from all tracks, divide the tracks into two groups and apply the Erase function to each group. (For example, first erase Tracks 1-4, then erase Tracks 5-8.)

#### Cut:

This function deletes data starting from a certain point (Auto Punch In point) on the hard disk. You need to set all the tracks RECORD TRACK select keys to "READY." Only the start point is needed. Refer to the following diagram:

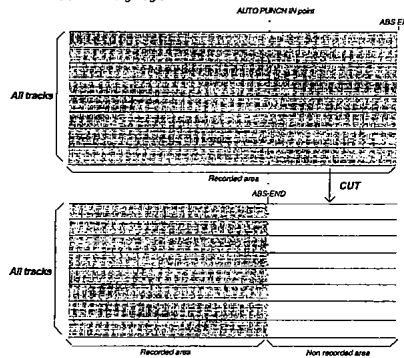



**Erasing**

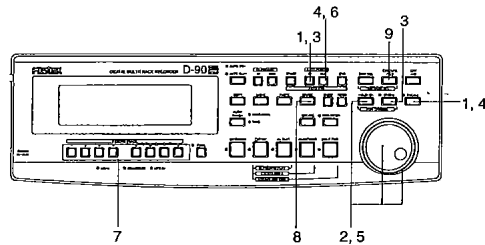

**Entering and storing the erase Punch In (start) point**

1. Press the **RECALL** key, then the **AUTO PUNCH IN** key (or press only the **AUTO PUNCH IN** key), and the unit enters edit mode.
2. Move the cursor to the digit you wish to edit using the **HOLD/SHUTTLE** dial, and set the value using the **JOG** dial.
3. After setting the time value, press the **STORE** key, then press the **AUTO PUNCH IN** key.  
The time value will be stored as a start point of the "pasting area", and the display will return to the previous screen.

**Entering and storing the erase Punch Out (end) point**

4. Press the **RECALL** key, then the **AUTO PUNCH OUT** key (or press only the **AUTO PUNCH OUT** key), and the unit enters edit mode.
5. Move the cursor to the digit you wish to edit using the **HOLD/SHUTTLE** dial, and set the value using the **JOG** dial.
6. After setting the time value, press the **STORE** key, then the **AUTO PUNCH OUT** key.  
The time value will be stored as an end point of the "erasing area," and the display will return to the previous screen.

\* To check the erase In/Out point, press the **AUTO PUNCH IN** and **AUTO PUNCH OUT** keys respectively. The display will show the stored time value.

**Erasing**

7. Press the **RECORD TRACK** select key of the track from which you wish to erase data (to ready the track).

**<Note>**  
Pressing the **RECORD TRACK** select keys to set all tracks in ready status will cut data as described later.

D-90 Owner's Manual (Edit function)

8. Press the ERASE key.

The upper row of the 7-segment display will show "ErAS," and the message "SURE?" will blink.

9. Press the EXECUTE/YES key.

When the operation is completed, the "ErAS" message is lit on the bottom row of the display, and message "COMPLETED!" appears. Press the EXIT/NO key to return to the previous display.

In this way, the sound data of the specified area is erased.

<Note 2>

The Erase function is available only when the hard disk has enough space (REMAIN) to perform the following Undo/Redo operation.

If you try to erase the data without enough free space on the hard disk, the display will indicate the alarm message "ovEr" (overtime error) as soon as you press the ERASE key, then indicate the excessive time in the currently-selected Time Base.

To avoid this, shorten the data to be copied, by the amount of the exceeding time, or use the Cut function to create free disk space as described later in order to move the ARS END point.

<Erase Undo/Redo>

If you wish to restore data that existed before you executed the Erase function, press the UNDO key to restore the status obtained before you erased the data. Pressing the REDO key after pressing the UNDO key will restore the status before the Undo operation (that is, after pasting). The Undo and Redo functions are effective only while the D-90 is stopped.

After the UNDO key or REDO key is pressed, the display will show "COMPLETED!" and return to the previous screen.

<Note>

You can use the undo/redo functions while the D-90 is in stop mode. Under the following circumstances, you will be unable to use the undo/redo functions:

1. If you make a new recording,
2. If you make a new edit (Copy & Paste, Move & Paste, Erase, or Cut),
3. If the Auto Punch In point was passed in play or record mode while Auto Punch mode was on, or
4. If you turned off the power to the D-90, then turned it back on.

Cutting

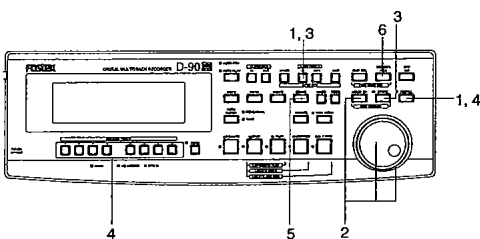

## Saving/Loading Song Data

The D-90 allows you to save the song data (audio data + Setup data) of either the currently-selected Program or all Programs P1-P9 to a DAT in the form of an S/P DIF digital signal, or to an adat in the form of adat digital signal.

You can also load saved song data from an external device into the D-90. This function is useful when there is not enough free space on the disk and you wish to save completed or incomplete song data to a DAT or adat temporarily in order to clear some space.

### \*\* About Song Data \*\*

The data format and time required for saving data vary depending on whether an S/P DIF digital signal is used to save or load to and from a DAT, or an adat digital signal is used to save or load to and from adat device.

#### \* Using S/P DIF digital signal

Following a five-second pilot signal, song data is output.

Audio data (the black part in the figure below) is divided into four parts (each two tracks) to be input or output. This means that it takes about four times the Program recording time (from ABS 0 to ABS END) to save or load one Program.

When the pilot signal and Setup data (the gray area in the figure) are transmitted, a beep sound will be output to tell you the position in the data.



#### \* Using an adat digital signal

Following a five-second pilot signal, the song data is output.

All eight tracks of audio data (black area in the figure below) will be transmitted simultaneously. This means that it takes about the same time as the Program recording time (from ABS 0 to ABS END) to save or load one Program.

When the pilot signal and Setup data (the gray area in the figure) are transmitted, a beep sound will be output to tell you the position in the data.



#### \* Saving all song data

When the song data from all Programs P1-P9 is saved, each Program will be output in its own data format, S/P DIF or adat, and about ten seconds of silence will be generated between Programs.

The order of the Programs to be saved is as follows: P1 -> (10 second interval) -> P2 -> (10 second interval) -> P3 -> (10 second interval) -> ..... P8 -> (10 second interval) -> P9

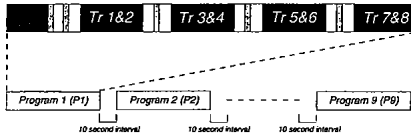

**Entering and storing the cut Punch In (start) point**

1. Press the **RECALL** key, then the **AUTO PUNCH IN** key (or press only the **AUTO PUNCH IN** key), and the unit enters edit mode.
2. Move the cursor to the digit you wish to edit using the **HOLD>** key or the **SHUTTLE** dial, and set the value using the **JOG** dial.
3. After setting the time value, press the **STORE** key, then press the **AUTO PUNCH IN** key.  
The time value will be stored as a start point of the cut area, and the display will return to the previous screen.

\* To check the cut in point, press the **AUTO PUNCH IN** key. The display will show the stored time value.

**Executing the cut operation**

4. Press all **RECORD TRACK** select keys (to ready all tracks).
5. Press the **ERASE** key.  
The upper row of the 7-segment display will show "Cut," and message "ARE YOU SURE?" will blink.
6. Press the **EXECUTE/YES** key.  
When the operation is complete, the display shows the message "COMPLETED," then returns to the previous screen.

\* In this way, sound data starting from a specified position is cut, and an unwritten area will be left on the hard disk.

**<Cut Undo/Redo>**

If you wish to restore data that existed before you executed the Cut function, press the **UNDO** key to restore the status obtained before you cut the data. Pressing the **REDO** key after pressing the **UNDO** key will restore the status before the Undo operation (that is, after pasting). The Undo and Redo functions are effective only while the D-90 is stopped. After the **UNDO** key or **REDO** key is pressed, the display will show "COMPLETED" and return to the previous screen.

**<Note>**

You can use the undo/redo functions while the D-90 is in stop mode. Under the following circumstances, you will be unable to use the undo/redo functions:

1. if you make a new recording,
2. if you make a new edit (Copy & Paste, Move & Paste, Erase, or Cut),
3. if the Auto Punch In point was passed in play or record mode while Auto Punch mode was on, or
4. if you turned off the power to the D-90, then turned it back on.

**<Note>**

If you try to cut the data for a Program in its entirety by storing the **ABS 0** point at the Auto Punch In point, about 100ms of data may remain at the beginning. In this case, use the **ERASE** function to erase the unnecessary part. (The Erase function can erase data that was not deleted by the Cut function.)

**<Note>**

The D-90 can save all Programs 1-9 in one pass, but cannot load them in one pass. You must load Programs one by one.

**<Note>**

The D-90 can only save and load data to and from digital devices that support non-compression recording, and S/P DIF format or adat format digital recording functions. Basically, any device that supports the adat format can be used for the D-90's saving and loading operation.

However, for the S/P DIF format, you cannot use an MD or DCC that employs compression recording system, a CD-R machine that automatically corrects the interval between Programs, or other devices that automatically change the sampling rate. Devices with SCMS can be used if they satisfy the conditions described above.

Basically, any digital device that supports non-compression recording, and the S/P DIF or adat formats, should be able to save and load the D-90's data correctly. However, some devices may not, due to the occurrence of multiple errors. The following Fostex models have been tested and approved for the save and load operation:

FOSTEX: D-16, D-10, D-5

### 1. Saving data from the DATA OUT connector

- \* Restore the default settings on the D-90.
- \* Make sure that the sampling rate of the D-90 matches that of the external digital device.

#### Connecting an external device.

- \* Connect the D-90's DATA OUT connector with the digital input connector of the external digital device.

**<Note>**

The D-90 switches the DATA OUT connector between the S/P DIF digital signal (OPTICAL) and the adat digital signal. Both signals use the same connector configuration, but carry different data.

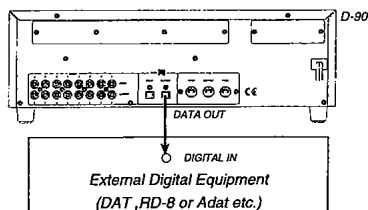

- \* If the external device has only a coaxial (RCA) type digital output connector, use the optional COP-1 optical/coaxial converter to connect the device.

- \* If you connect both the digital input and output of the D-90 to those of an external digital device, a digital loop may be generated. Refer to "4-3. Connecting a digital mixer" for more information.

**Setting an external device**

1. Match the sampling rate of the external device to that of the D-90.
2. Set the external device so that it will accept a digital signal.

On some devices, you may need to set it so that the device will synchronize to the input digital signal.

For example, if you are using a Fostex RD-8, select "DIGITAL IN" for input, and set "Clock Source" (external sync signal) to "Word Optical (adat)."

**<Note>**

When you are monitoring the digital signal from the external device and notice that the signal cannot be input or digital noise is generated, check the connection, cabling, and settings on the D-90 and the external device.

# Refer to the instruction manual that came with the external digital device for more information.

**Saving**

You can save song data by following the "Saving song data" procedure in Setup mode.

- \* Output to : adat, DAT
- \* Program options: P1-P9, ALL
- \* You can select one Program or all Programs to save.

1. Press the DISP SEL key to select "SETUP" ("SETUP" flashes), and press the EXECUTE/YES key. ("SETUP" lights up.)  
The unit enters Setup mode.
2. Use the JOG dial to select "SAVE" (flashing).
3. Press the EXECUTE/YES key ("SAVE" light up).  
The indicator of the currently selected digital signal for saving will flash.
4. Turn the JOG dial to select the type of digital signal to save.  
Selecting "Ad At" will save an adat digital signal.  
Selecting "dAt" will save an S/P DIF digital signal.
5. Press the EXECUTE/YES key. ("SAVE" lights up.)  
The digital signal to save will be selected and the currently-selected Program indicator will flash.
6. Turn the JOG dial to select a Program to save.  
You can select from P1 - P9 or ALL.  
Turn the JOG dial to select a Program, and the recorded time (Time from ABS 0 to ABS END) for that Program will be displayed.

\* If you selected "AdAt" (adat digital signal), the save operation will take almost the time indicated on the display. If you selected "dAt" (S/P DIF digital signal), the save operation will take four times the indicated time.

7. Press the EXECUTE/YES key. ("SURE?" flashes.)  
"Eco rd Ad At" or "rEco rd dAt" will flash on the display.
8. Make sure that the external device is now syncing to the digital input signal, start recording on the device.  
It may be helpful for future loading operation if you set START-ID (DAT) or a locate point at the recording start point.
9. Make sure that the external device has started recording, and press the EXECUTE/YES key.  
("REMAIN" will light up.)  
The D-90 will start saving data, and display the time required for saving, which, after a few seconds, will count down. This gap of a few seconds is due to a pilot signal recorded as a marker for the tape position (used at the time of loading). The actual save operation will begin when the count down starts.

10. When the save operation is complete, "COMPLETED" will light up on the display.

11. Press the STOP button or the EXIT/NO key to quit Setup mode, and the screen will indicate the Time Base display.

\* Press the STOP button or the EXIT/NO key to cancel the operation or to return to the screen shown before you pressed the EXECUTE/YES key. Pressing either key repeatedly will take you back to the previous level one step at a time until the unit quits Setup mode and the screen returns to the Time Base Indication.

If you press the STOP button or the EXIT/NO key after Step 8, saved song data will become invalid.

\* Refer to "Saving/Loading Song Data" on page "92" for more information on saving song data.

## 2. Loading data from the DATA IN connector

\* Restore the default settings on the D-90.  
\* Make sure that the sampling rate of the external digital device matches that of the D-90.

### Connecting an external device.

\* Connect the D-90's DATA IN connector with the digital output connector of the external digital device.

#### <Note>

The D-90 switches the DATA IN connector between the S/P DIF digital signal (OPTICAL) and an adat digital signal. Both signals use the same connector configuration, but carry different data.

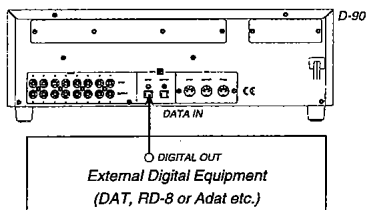

\* If the external device has only a coaxial (RCA) type digital output connector, use the optional COP-1 optical/coaxial converter to connect the device.

\* If you connect both the digital input and output of the D-90 to those of an external digital device, a digital loop may be generated. Refer to "4-3. Connecting a digital mixer" for more information.

### Setting an external device

1. Set the external device so that it can output a digital signal.
2. Locate the top of the pilot signal recorded in the saved song data.

# Refer to the instruction manual that came with the external digital device for details.

**Loading**

You can load song data by following the "Loading song data" procedure in Setup mode.

- \* Input from : edat, DAT
- \* Program options: P1-P9
- \* You can select one Program at a time to load.

1. Press the DISP SEL key to select "SETUP" ("SETUP" flashes), and press the EXECUTE/YES key. ("SETUP" lights up.)  
The unit enters Setup mode.
  2. Use the JOG dial to select "LOAD" (flashing).
  3. Press the EXECUTE/YES key ("LOAD" light up.)  
The indicator of the digital signal currently-selected to load will flash.
  4. Turn the JOG dial to select the type of digital signal to load.  
Selecting "Ad At" will load an adat digital signal.  
Selecting "dA" will load an S/P DIF digital signal.
  5. Press the EXECUTE/YES key. ("LOAD" lights up and "SURE?" flashes.)  
The digital signal to load will be selected and the currently-selected Program indicator will flash. At this time, if the signal is input correctly, "DIGITAL" lights up in red on the display.
- \* If "DIGITAL" is flashing in red, check the connection, cabling, and the settings on the D-90 and the external device again.

**<Notes>**

- \* If the sampling rate setting is wrong for an S/P DIF digital signal, the 48kHz LED will flash to warn you.
- \* The 48kHz LED will not warn you regarding an adat signal. Use caution when you set the sampling rate.

6. Turn the JOG dial to select a Program into which to load data.  
You can select from P1 - P9.  
Turn the JOG dial to select a Program, and the recording time (time from ABS 0 to ABS END) for that Program will be displayed.
- \* If the recording time indicates OOM OOS, that Program does not contain any recording data. If the indication is something other than OOM OOS, the corresponding Program contains some data. Use caution not to erase important Programs accidentally.

**<Note>**

Once you start the loading operation, the previously existing song data in the Program will be overwritten by newly loaded data, even if you cancel an operation in progress. For example, if you load a two-minute song into a Program that contains a five-minute song, the Program will contain only two-minutes of data (ABS END is "two minutes"). Make sure that you have selected the right Program before you start loading data.

7. Press the EXECUTE/YES key to perform the loading operation.  
The screen will display "PL Ay dA t.."
8. Start playback on the external device.  
When the D-90 recognizes that the input digital signal is valid, it will start loading data. The time required for loading will count down on the display.
9. When the loading operation is complete, "COMPLETED" will light up on the display.



10. Press the STOP button or the EXIT/NO key to quit Setup mode, and the screen will indicate the Time Base for the loaded Program.

\* Press the STOP button or the EXIT/NO key to cancel the operation or to return to the screen shown before you pressed the EXECUTE/YES key. Pressing either key repeatedly will take you back to the previous level one step at a time until the unit quits Setup mode and the screen returns to the Time Base indication.  
If you press the STOP button or the EXIT/NO key after Step 8, loaded song data will become invalid, although some part could be played back.

**<Note>**  
Do not remove the optical cable or perform any other operation that would disconnect the S/P DIF signal until the session is complete. Otherwise, the D-90 will generate noise, and affect the connected device.

### 3. Saving/Loading data using SCSI

You can perform the save/load operation using an external SCSI device with the D-90 with an optional Model 8338 SCSI card installed.

# Refer to the instruction manual for the Model 8338 for details.

### 4. Compatibility with D-80 (Version 2), DMT-8 (Version 2), and DMT-8VL

	D-80 (V2.0)	DMT-8 (V2.0)	DMT-8VL
Program	9 (P1-P9)	5 (P1-P5)	1
Editing the program data	00:00:00:00	00:00:00:00	00:00:00:00
Setting of the time base	23:59:59.99	00:00:00:00	00:00:00:00
Backup of the song memory	○	○	○
	○	×	×
<b>SETUP mode</b>			
Sampling Frequency	44.1kHz	44.1kHz	44.1kHz
Number of the time alignment	○ (64 points)	○ (64 points)	○ (16 points)
Setting of the time base	○ (64 points)	○ (64 points)	○ (32 points)
Microphone Function	○	○	○
Loading/Saving Song Data	adat or S/P DIF (P1-P9)	S/P DIF (P1-P5)	S/P DIF (P1-P5)
Setting of the preset time	○	○	○
Setting of the dynamic option align	○	○	○
Setting of the MTC frame rate	○	○	○
	00:00:00:00	00:00:00:00	00:00:00:00
Setting of the MTC offset time	23:59:59.99	00:00:00:00	00:00:00:00
Setting of the MTC offset mode	○	×	×
Setting of the rec enable	○	○	○
Setting of the digital input track	adat or S/P DIF	S/P DIF	×
Setting of the digital output track	adat or S/P DIF	S/P DIF	×
Setting of the display resolution mode	○	○	×
Setting of the time mode	○	○	×
Setting of the auto mode	○	×	×
Setting of the auto mode	○	○	×
Setting of the auto mode	○	○	×

## MIDI sync function

In the following, are examples concerning general types of systems using MIDI related functions contained in the D-90.

### 1. MIDI clock sync system

By setting any desired meter at any desired point of the programmable tempo map contained in the D-90, and by output of a MIDI clock and song position pointer according to the setting, a hardware type MIDI sequencer can be synchronized as a MIDI clock slave. Consequently, in this system, the D-90 will be the master and the MIDI sequencer the slave.

Unlike conventional tape type MTR, all eight tracks can be fully utilized without wasting one track on a sync signal.

- \* Restore the default settings on D-90.
- \* Check for the correct program and proper sampling frequency.

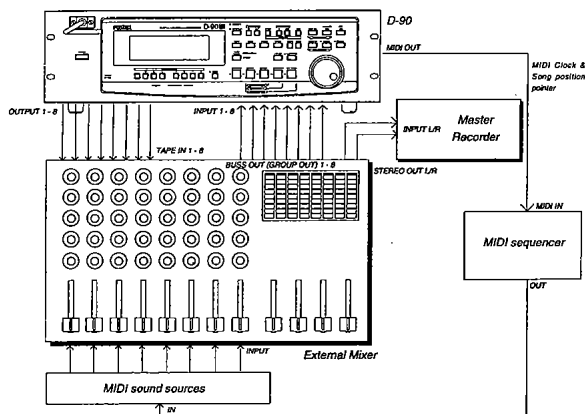

#### Connecting external equipment (Refer to connecting schematic)

1. Connect the D-90 MIDI OUT to MIDI IN of the MIDI sequencer.
2. Set the MIDI sequencer for "external sync mode (EXTERNAL SYNC) by MIDI clock."

\* Refer to the Owners Manual of the equipment in use for details.

**Procedure for synchronizing**

1. Press the desired RECORD TRACK select key of the D-90 and set to the "READY" mode.
2. Start recording by pressing the RECORD and PLAY buttons.  
Because this is only for making a section to allow playback, it is not necessary to input sound (no sound recording). Making a no sound recording for the approximate length of recording is very convenient because this allows you to sync at any point in the tune. However, if something is already recorded, this procedure is unnecessary.

**<Note>**

Because the D-90 can playback the recorded section only (ABS 0, ABS END), if it is in the no recording state, it cannot output MIDI clocks and song position pointers even though meters and tempos are set.

\* Although an unnecessary recording has been made, it can be eliminated using the erase function.

**Setup of D-90**

1. Because MIDI clock and song position pointer will be output from D-90, set the SETUP mode "MIDI sync signal output setting" to "CLOCK."

- \* Initial setting: Clock
- \* Permissible setting: Clock (MIDI clock and song position pointer: "CLOCK") / MTC (MIDI time code: "Mtc") / OFF (No output of MIDI sync signal)
- \* This item can be setup for each program.
- \* The setting can be saved/loaded as song data.
- \* This setting will be held even though power is switched OFF.

# Refer to page "127", SETUP mode "9. Setup of MIDI sync signal output" for correct operating procedures.

2. The meter in the desired bar can be set by "Setup of the time signature" of the SETUP mode.

- \* Initial setting: 001 bar, 4/4 signature.
- \* Permissible bar setting: 001-999
- \* Permissible meter setting: 1/4, 2/4, 3/4, 4/4, 5/4, 1/8, 3/8, 5/8, 6/8, 7/8, 8/8, -- (Elimination of signature)
- \* Permissible setting of maximum number of points: 64 points
- \* This item can be set for each program.
- \* The setting can be saved/loaded as song data.
- \* This setting will be held even though power is switched OFF.

# Refer to page "118", SETUP mode "2. Setup of the time signature" for operating procedure.

3. Tempo in the desired bar can be set by "Setup of tempo" of the SETUP mode.

Tempo map is made in steps 2 and 3.

- \* Initial setting: 001 bar, 1st meter, Tempo120.
- \* Permissible bar setting: Follows the previous "Setup of the time signature."
- \* Permissible signature setting: Follows the previous "Setup of the time signature."
- \* Permissible setting of tempo: Quarter note=30-250 ... (Tempo elimination)
- \* Permissible setting of maximum number of points: 64 points
- \* This item can be set for each program.
- \* The setting can be saved/loaded as song data.
- \* This setting will be held even though power is switched OFF.

# Refer to page "120", SETUP mode "3. Setup of tempo" for operating procedure.

4. Set the SETUP mode "Setup of the metronome function" to ON if click sound is to be output according to the setup tempo map.

- \* Initial setting: OFF
- \* Permissible setup item: OFF, ON
- \* This item can be set for each program.

D-90 Owner's Manual (MIDI sync function)

\* The setting can be saved/loaded as song data.  
\* This setting will be held even though power is switched OFF.

# Refer to page "122", SETUP mode "4. Setup of the metronome function" for operating procedure.

5. Press the DISP SEL key while pressing the EXECUTE/YES key, then change the time base display to BAR/BEAT/CLK.

**Confirming the MIDI clock sync**

During recording and at playback following the recording, time base (BAR/BEAT/CLK) is displayed in accordance to the setup tempo map, and the MIDI clock and song position pointer is also output.

Confirm that the travel position (BAR/BEAT/CLK) of D-90 and travel position of the synchronized MIDI sequencer are matched.

\* If correct sync cannot be obtained, re-check the connections/cables and setting of both equipment.

**<Note>**

In the D-90, the "ABS 0" position is set at "002BAR/1BEAT /00CLK."  
This setting is made in consideration of the time required (it will not sync immediately) for the MIDI sequencer, etc. to enter in sync.  
As a result, if the D-90 is played back from ABS 0 (LOCATE ABS 0), sync will be completed by the time it reaches the first bar, and thus synchronize from head of the tune.

**Execution of recording**

Various ways of recording can be conducted while synchronizing the D-90 and the MIDI sequencer with the MIDI clock.

## 2. MTC sync/MIDI machine control system

The following will explain synchronization by the MTC (MIDI time code) output and the computer controlling system using MMC (MIDI machine control). In this system, D-90 will be the master and the computer (with sequence software) will be the slave.

The D-90 will attach any desired offset (time difference) against ABS time (absolute time) and output it as MTC in any desired frame rate.

It can also carry out the proper operation upon receiving an MMC and Fostex System Exclusive Message from outside. In this case, because the D-90 can setup a DEVICE ID number by the SETUP mode "DEVICE," a multiple number of D-90's can be separately controlled by changing the DEVICE ID numbers in the transmitted message from the computer.

In regards to the corresponding content for MMC, refer to the "MMC list" on page \*\* and on the Fostex System Exclusive Message, the "Fostex Exclusive List" on page \*\*. When the D-90 receives MMC rehearsal (Set by WRITE: 40h, RECORD MODE: 4ch), the REHEARSAL LED will blink to indicate that rehearsal mode of the manual punch in/out is activated.

- \* Set D-90 in the initial state.
- \* Confirm the program and sampling frequency.

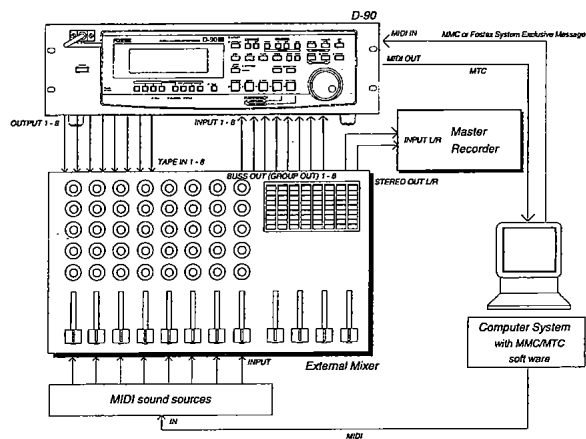

**Connecting to external equipment**

Connect the D-90 MIDI IN/OUT to the computer (with MIDI interface) MIDI IN/OUT (MMC/MTC complied sequence software is activated in the computer).

**Setup of external equipment**

Setup the following in the sequence software.

- \* Set to MTC external sync mode (EXTERNAL SYNC).
- \* Set for output of MMC.
- \* Set to the desired MTC read out frame rate.
- \* Set start time of the tune (which MTC time is to be the first bar). Refer to precaution in regards to MTC offset, farther on.

# For details, refer to Owners Manual of the external equipment.

**Procedure for synchronizing**

1. Press the desired RECORD TRACK select key of D-90 and enter it in the "READY" mode.
2. Start recording by pressing the RECORD and PLAY buttons.  
Because this is only for making a section to allow playback, it is not necessary to input sound (no sound recording). Making a no sound recording for the approximate length of recording is very convenient because this allows you to sync at any point in the tune. However, if something is already recorded, this procedure is unnecessary.

**<Note>**

Because the D-90 can playback the recorded section only (ABS 0, ABS END), if it is in the non-recorded state whereby nothing is recorded, MTC cannot be output.

**Setup of D-90**

1. Because MTC will be output from D-90, set to "Mtc" the SETUP mode "Setting the MIDI sync signal output."

# Refer to page "127", SETUP mode "9. Setup of the MIDI sync signal output" for operating procedure.

2. Set a random offset time by the SETUP mode "Setup of MTC offset time."

- \* Initial setting: 00H (Hour) 59M (Minute) 57S (Second) 00F (Frame) 00SF (SubFrame)
- \* Permissible setup time: 00H 00M 00S 00SF - 23H 59M 59S 29SF
- \* This item can be set for each program.
- \* The setting can be saved/loaded as song data.
- \* This setting will be held even though power is switched OFF.

# Refer to page "129", SETUP mode "11. Setup of the MTC offset time" for operating procedure.

3. In the SETUP mode "Setup of the MTC offset mode," whether the MTC offset time setup in step 2 should be output (ABS) at the ABS 00M 00S 00SF position or at the 001BAR 1BEAT 00CLK (bar, signature) must be selected.

- \* Initial setting: ABS
- \* Permissible setup item: ABS, BAR
- \* This item can be set for each program.
- \* The setting can be saved/loaded as song data.
- \* This setting will be held even though power is switched OFF.

# Refer to page "130", SETUP mode "12. Setup of the MTC offset mode" for operating procedure.

4. Setup to the same frame rate as that setup by the sequence software by "Setup of the MTC frame rate" of the SETUP mode.

- \* Initial setting: 25 frames
- \* Permissible setup of frame rate: 24, 25, 30ND, 30DF
- \* This item can be setup for each program.
- \* The setting can be saved/loaded as song data.
- \* This setting will be held even though power is switched OFF.

# Refer to page "128", SETUP mode "10. Setup of the MTC frame rate" for operating procedure and details.

5. Set to the same figure as the sequence software MMC device number (and Fostex System Exclusive Message device number) by the SETUP mode "Setup of MIDI device ID."
- When the sequence software transmits by "7F," it means "ALL DEVICE" and therefore, it need not be setup. The D-90 transmitting device ID will also function in parallel with this setting.

- \* Initial setting: 00
- \* Permissible setup ID: 00 - 99
- \* This item will be the setting common to all programs.
- \* This setting cannot be saved/loaded as song data.
- \* This setting will be held even though power is switched OFF.

# Refer to page "138", SETUP mode "18. Setup of the MIDI device ID" for operating procedure and details.

6. Press the DISP SEL key while pressing the EXECUTE/YES key to show time base in the MTC display.

<Notes on MTC related setups>

By "Setup of the MTC offset time" and "Setup of the MTC offset mode," at what position (ABS 0 or 001BAR/1BEAT/00CLK) should the setup MTC (MTC offset time) is to be output was set. When setting the start time of the tune in the sequence software by these setups, be careful of the following points.

\* **Offset mode: For ABS**  
If playback is started from ABS 0, since MTC will be output starting from the MTC offset time that has been set, start time of the tune set by the sequence software must be set about 3 seconds later from MTC offset time that was setup. This is to provide time as the sequence software cannot sync immediately after MTC is output. For example, if the initial setting of 00H 57S 00F 00F" is used, set start time of the tune to "01H 00M 00S 00F." If playback is thus started from ABS 0 (LOCATE ABS 0), sync will be obtained by the time it reaches the first bar and therefore it can be made to sync from the head of the tune.

\* **Offset mode: For BAR**  
As mentioned before, because the "ABS 0" position is set at the "002BAR / 1BEAT / 00CLK" position, the setup MTC offset time can be set to the head of the tune without taking into account the time until reaching sync, as mentioned above. The length of the time two bars beforehand will change in accordance to the first bar setting for "signature" and "tempo." For example, it will be long if tempo is set slow. This mode can be effectively applied when using the MIDI clock and MTC in parallel, and when using MTC for the sync signal while controlling D-90 with time base BAR/BEAT/CLK.

Confirming MTC sync/MMC

1. During recording and at playback after recording, time base MTC is displayed according to the setting and MTC is output at the same time.  
Check that the D-90 travelling position (MTC) and the traveling position of the sequence software in sync are matched.
  2. Send MMC commands such as PLAY, STOP and LOCATE from the sequence software to see that D-90 will be properly controlled.  
When a correct MIDI command (MMC or FEX) is received, "MIDI" in the display will be lit for about 40msec. There is no setting in D-90 to receive MMC or FEX but it will operate if a correct MIDI signal is input.
- \* If sync and control cannot be done correctly, re-check connections/cables and setting of both equipment.

**Execution of recording**

Carry out various recordings while synchronizing D-90 and the MIDI sequencer with the MIDI clock.

**3. Multitrack system by the slave mode**

The following will explain an example of constructing a 24 track system using three D-90's and its slave mode functions.

- \* Initialize D-90.
- \* Confirm the program.
- \* Set all three D-90's to the same sampling frequency.

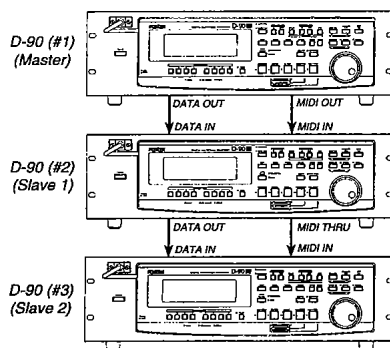

**Equipment interconnections**

1. From D-90 (#1) to D-90 (#2), connect DATA OUT to DATA IN and MIDI OUT to MIDI IN.
2. From D-90 (#2) to D-90 (#3), connect DATA OUT to DATA IN and MIDI THRU (Note!!!) to MIDI IN.

**<Note>**

In order to slave drive a D-90 with each other, the best setting is to supply Adat digital signals together with MTC from the master.

**Procedure in chase lock operation**

1. Press a random RECORD TRACK select key in all three D-90 and enter them in the "READY" mode.  
The tracks of D-90 (#2) and D-90 (#3) can be selected from D-90 (#1).  
Refer to operating procedure in "Record track selecting from the master" farther down.
2. Start recording by pressing the D-90 (#1) RECORD and PLAY buttons.  
When D-90 (#1) starts recording, D-90 (#2) and D-90 (#3) will also start recording.  
This is because the master also outputs the MMC RECORD command.  
Because this recording is only to make a section for the purpose of playback, input of sound is not necessary (no sound recording). Should no sound recording be made in the approximate length for recording, this will be very convenient as sync will be possible at any point in the tune.



3. Individually press the STOP button.

This is not necessary if something is already recorded in all three D-90's.

**<Note>**  
Because the D-90 can playback only the range (ABS 0 through ABS END) where a recording was made, output of MTC and chase lock (sync travel) cannot be done in the no recording state.

This state is not chase lock but is only simply recording. The three D-90's can be set for chase lock by the following procedure.

**Setup of D-90 (#1)**

1. Because MTC, which is the reference for sync, is output from D-90 (#1), set the "Setup of the MIDI sync signal output" of the SETUP mode to "Mtc."

# Refer to page "127", SETUP mode "9. Setup of the MIDI sync signal output" for operating procedure and details.

2. A random offset time is set by the SETUP mode "Setup of MTC offset time."

# Refer to page "129", SETUP mode "11. Setup of MTC offset time" for operating procedure and details.

3. With the SETUP mode "Setup of the MTC offset mode," whether the MTC offset time will be output (ABS) at the ABS 00M 00S 00F 00SF point or at the 001BAR 1BEAT 00CLK (bar/signature) point of the tempo map, is selected.

# Refer to page "130", SETUP mode "12. Setup of MTC offset mode" for operating procedure and details.

4. A random frame rate to be used is set by the SETUP mode "Setup of the MTC frame rate."

# Refer to page "128", SETUP mode "10. Setup of MTC frame rate" for operating procedure and details.

5. "00" is set with the SETUP mode "Setup of the MIDI device ID."

# Refer to page "138", SETUP mode "18. Setup of the MIDI device ID" for operating procedure and details.

6. Set to "Adat" the digital signal to be output by the SETUP mode "Setup of the digital output track."

# Refer to page "134", SETUP mode "15. Setup of the digital output track" for operating procedure and details.

7. Press the DISP SEL key while pressing the EXECUTE/YES key to change the time base display to MTC.

**Setup of D-90 (#2) (Slave 1) and D-90 (#3) (Slave 2)**

1. Set the SETUP mode "Setup of the MTC offset time" to the same offset time as in D-90 (#1).

# Refer to page "129", SETUP mode "11. Setup of the MTC offset time" for operating procedure and details.

2. Set the SETUP mode "Setup of the MTC offset mode" to the same mode as in D-90 (#1).

# Refer to page "130", SETUP mode "12. Setup of the MTC offset mode" for operating procedure and details.

3. Set the SETUP mode "Setup of the MTC frame rate" to the same frame rate as in D-90 (#1).

# Refer to page "128", SETUP mode "10. Setup of the MTC frame rate" for operating procedure and details.

D-90 Owner's Manual (MIDI sync function)

4. Set the SETUP mode "Setup of the MIDI device ID," to "01" in D-90 (#2), and to "02" in D-90 (#3).

# Refer to page "138", SETUP mode "18. Setup of the MIDI device ID" for operating procedure and details.

5. Using the SETUP mode "Setup of the slave mode," set slave mode to "ON," and the sync signal to "adat."

- \* Initial setting: OFF
- \* Permissible setup item: ON, OFF
- \* Permissible setup sync signal: MTC, S/P DIF, adat, Free (Only when set to ON)
- \* This item can be set for each program.
- \* The setting can be saved/loaded as song data.
- \* This setting will be held even though power is switched OFF.

# Refer to page "136", SETUP mode "17. Setup of the slave mode" for operating procedure and details.

6. Press the DISP SEL key while pressing the EXECUTE/YES key to change the time base display to MTC.

<Note>

After this setup, check the following in D-90 (#2) and D-90 (#3).

- \* Blinking of "CHASE" in the display:  
This will change to constant lit upon completing chase lock in later operation.
- \* "DIGITAL" is lit in the display:  
This means it is externally synchronized against the input digital signal.

<Note>

Do not insert or remove the optical cable connected to DATA IN when the slave mode is set to "on." Doing so could generate noise and affect external equipment.

Check chase lock

1. When the master unit (D-90 (#1)) is played back, MTC IN LED of the slave unit (D-90 (#2) and D-90 (#3)) will be lit, "CHASE" in the display will immediately change from blinking to lit and chase lock will be completed.

Check that the MTC time on display are same in both master and slave units.

2. When the master starts recording, the slave will also start recording upon completing chase lock.

3. When the master is stopped, the slave will also stop as MTC from the master will be interrupted. "CHASE" in the display will change from lit to blinking.

4. During FF/REW, the master only will be in the FF/REW mode and the slaves will remain stopped but when playback/recording is started, the slaves will immediately chase lock.

<Note>

The D-90 re-chase window is fixed at "10 frame." In other words, when MTC of the master and slave drifts apart more than 10 frames, it will assume that chase lock is disengaged and the slave will match the position again with the master (= re-chase operation). During the re-chase operation, sound output will be muted. If the drift is within 10 frames, the slave will recognize this and continue to travel. Because the master supplies digital signal to slave in this system, re-chase is rarely carried out following chase lock.

\* Should the D-90 fail to correctly chase lock and control, re-check the connection /cables and each settings.

**Record track selecting from the master**

The slave unit record track can be selected from the master unit by using the master unit FUNC key.

1. Press the D-90 (#1) FUNC key (LED is lit).  
"DEVICE" in the display will blink.
  2. Press the RECORD TRACK select key corresponding to the MIDI DEVICE ID set by each slave.  
Thus, select track 1 for D-90 (#2) (ID 1) and track 2 for D-90 (#3) (ID 2) (Refer to "Setup of the MIDI device ID" mentioned before.)  
"DEVICE" in the display will change to lit and the selected DEVICE ID will be displayed.
  3. Press a random RECORD TRACK select key.  
Record track in the selected slave will be selected.
  4. Press the FUNC key again (LED is extinguished).
- \* Should it fail to control correctly, re-check the connection/cables and each settings.

**Execution of recording**

A variety of recording work can be carried out with all three D-90's in the chase lock mode.

- \* Sound can be exchanged by digital signal between equipment if "Setup of the digital input track" and "Setup of the digital output track" are set as necessary in all three D-90's.  
Please note, however, that when the digital input track is setup, that track will be unable to input analog signal.

**<One point advice>**

"MIDI clock sync" and "MTC sync/MMC system" mentioned before can be combined in this multitrack system.

**Connection**

MIDI OUT of D-90 (#3) is connected to MIDI IN of the external MIDI equipment.

**Setup of the MIDI sync signal**

In D-90 (#3), select either the MIDI clock necessary for synchronizing or MTC.

\* For MIDI clock sync, the external MIDI equipment and D-90 (#3) must be setup by the previously discussed "MIDI clock sync" procedure.

\* For MTC sync, the external MIDI equipment and D-90 (#3) must be setup by the previously discussed "MTC sync/MMC system" procedure.

\* Control of each D-90 becomes possible if the DEVICE ID in the sequence software MMC output (3 channels) is set to comply with the DEVICE ID (00, 01, 02) setup in D-90.

\* When in any mode other than output of MIDI CLOCK from the D-90, MMC from MIDI IN and also FEX are automatically merged and output from MIDI OUT.

In the above schematic, MTC and the reply message of MMC/FEX which are output from D-90 (master) itself and, MMC and FEX output from the computer, are merged and output from MIDI OUT.

#### 4. External MIDI equipment sync system by the slave mode

Up to this point, synchronization with external MIDI equipment has been explained with the D-90 as the master and MIDI equipment as the slave but depending on the slave mode setting, the MIDI equipment can be set as the master and D-90 as the slave.

**<Note>**

External MIDI equipment which can be used as the master is limited to those which can output MTC.

- \* Initialize D-90.
- \* Confirm the program and sampling frequency.
- \* In the following, the explanation will be on the assumption that a computer (with sequence software) is used.

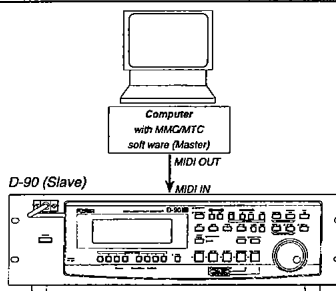

#### Connection to external equipment

Connect MIDI OUT of the computer (with MIDI interface) with MIDI IN of D-90. The computer sequence software complying to MMC/MTC must be activated.

#### Setup of external equipment

- \* Sequence software is setup as follows.
- \* Set for output of MTC.
- \* Set frame rate of the MTC to be output.
- \* Confirm start time of the tune.
- \* Set for output of MMC.

# Refer to Owners Manual of the respective equipment for details.

#### Procedure for synchronizing

1. Press a random RECORD TRACK select key in D-90 and enter it in the "READY" mode.

2. Press the RECORD and PLAY buttons to start recording.

Because this is only to make a section for the purpose of playback, input of sound is not necessary (no sound recording). Making no sound recording for the approximate length of recording is very convenient because this allows you to sync at any point in the tune. However, if something is already recorded, this procedure is unnecessary.

**<Note>**

Because the D-90 can playback the recorded section only (ABS 0, ABS END), if it is in the non-recorded state because nothing has been recorded, MTC cannot be output.

**Setup of D-90**

1. A random offset time can be set by the SETUP mode "Setup of the MTC offset time."

# Refer to page "129", SETUP mode "11. Setup of the MTC offset time" for operating procedure and details.

2. Set to the desired mode by the SETUP mode "Setup of the MTC offset mode."

# Refer to page "130", SETUP mode "12. Setup of the MTC offset mode" for operating procedure and details.

3. Set to same frame rate as the sequence software by the SETUP mode "Setup of the MTC frame rate."

# Refer to page "128", SETUP mode "10. Setup of the MTC frame rate" for operating procedure and details.

4. Set slave mode to "ON" and sync signal to "MTC" by the SETUP mode "Setup of the slave mode."

# Refer to page "136", SETUP mode "17. Setup of the slave mode" for operating procedure and details.

5. Press the DISP SEL key while pressing on the EXECUTE/YES key to change the time base display to MTC.

**<Precautions at MTC related setups>**

The position (ABS 0 or 001BAR/1BEAT/00CLK) when the setup MTC (MTC offset time) should be output was setup by the "Setup of the MTC offset time" and "Setup of the MTC offset mode." In accordance to start time of the tune set by the sequence software, setup as explained below.

**Offset mode: For ABS**

Set the MTC offset time about three seconds prior to the start time of the tune set by the sequence software. Because the D-90 cannot immediately chase lock after input of MTC, in order to sync the D-90 from head of the tune, set preroll using the sequence software, playback from before the actual head of the tune to let the D-90 enter into sync by the time it arrives at the head of the tune.

**Offset mode: For BAR/BEAT**

The MTC offset time can be set to the same time as the start time of the tune set by the sequence software. Because the "ABS 0" position is set at the "0002BAR/1BEAT/00CLK" position in the D-90, as mentioned before, the preceding time required for sync is already set. The preceding time of two bar lengths could change in length depending on the first bar's "signature setting" and "tempo setting" mentioned before. For example, it will be longer if the tempo is slowed down.

**Confirming chase lock**

1. When the sequence software is played, MTC IN LED of the D-90 will light, "CHASE" in the display will change from blinking to lit and the chase lock will be completed. Check that the MTC output by the sequence software and MTC time displayed in D-90 are the same.

2. When MMC RECORD command is output from the sequence software, D-90 will start recording upon completing chase lock.

3. When the sequence software stops, MTC will be interrupted and the D-90 will also stop. "CHASE" in the display will change from lit to blinking.

4. During FF/REW of the sequence software, D-90 will remain stopped but upon starting to record, the D-90 will immediately chase lock.

**<Note>**

Chase lock of the D-90 by MTC only is permissible when speed difference of MTC from the master is within +/- 5.6%. Against MTC within this range, variable pitch will be constantly applied internally for chasing. Chase lock, however, will not function against MTC at a speed difference outside this range.

5. Send MMC commands such as PLAY, STOP and LOCATE from the sequence software to check that the D-90 works correctly.

When a correct MIDI command (MMC or FEX) is received, "MIDI" in the display will be lit for about 40msec. There is no setting in the D-90 for receiving MMC or FEX but will operate if a correct MIDI signal is input.

\* Should it not be possible to chase lock and control, re-check connections / cables and various settings.

**Execution of recording**

Carry out various recordings while D-90 is chase locked to the sequence software.

**<One point advice>**

Sync signal "Free" of the "Setup of the slave mode":

When the D-90 is made to chase lock by MTC only, variable pitch will be constantly applied by external MTC. If a digital signal is output to an external digital equipment from the D-90, it will not be able to follow the speed difference (MTC speed difference of the master) of the D-90 and the external digital equipment. In some cases, may not be able to input a continuous digital signal.

As a counter measure, the sync signal should be set to "Free" by the "Setup of the slave mode." Using this setting, the D-90 will enter self operation by the internal clock after completion of chase lock, and it will be possible to supply a stable digital signal to the external equipment.

Under this setting, when MTC drift between the master unit and slave unit exceeds 10 frames, the D-90 will assume that chase lock has been disengaged and the slave unit will carry out position matching again with the master unit (=re-chase operation). During the re-chase operation, sound output will be muted and the digital signal will also be interrupted. If it is within 10 frames, the slave unit will continue to run while admitting this drift.

### 5. Sync system with "adat" by the slave mode

This section will explain the sync system using "adat" equipment such as the Fostex RD-8.

- \* Initialize D-90.
- \* Confirm the program.
- \* Set RD-8 and D-90 to the same sampling frequency.

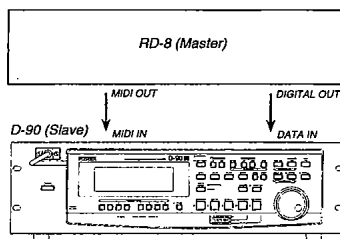

#### Equipment connections

Make connections, respectively, RD-8 DIGITAL OUT to D-90 DATA IN, and RD-8 MIDI OUT to D-90 MIDI IN.

#### <Note>

In order to slave operate adat equipment and the D-90, the best setting is to supply "adat" digital signals together with MTC from the master unit.

#### Procedure for chase lock

1. Press the D-90 RECORD TRACK select key to enter the "READY" mode.
2. Press the D-90 RECORD and PLAY buttons to start recording.  
*Making a no sound recording for the approximate length of recording is very convenient because this allows you to sync at any point in the tune. However, if something is already recorded in the D-90, this procedure is unnecessary.*

#### <Note>

Because the D-90 can playback the recorded section only (ABS 0, ABS END), if it is in the non-recorded state whereby nothing is recorded, output of MTC and chase lock (sync travel) cannot be done.

#### Setup of RD-8 (master)

1. Setup for output of MTC.
2. Check the MTC time to be output.
3. Setup the MTC frame rate to be output.
4. If necessary, set to allow output of "adat" digital signals.  
*This is not necessary for RD-8.*

# Refer to the RD-8 Owners Manual for details.

**Setup of the D-90**

1. The SETUP mode "Setup of the MTC offset time" must be set to the same offset time as in D-90 (#1).

# Refer to page "129", SETUP mode "11. Setup of the MTC offset time" for operating procedure and details.

2. The SETUP mode "Setup of the MTC offset mode" must be set to the same mode as in D-90 (#1).

# Refer to page "130", SETUP mode "12. Setup of the MTC offset mode" for operating procedure and details.

3. The SETUP mode "Setup of the MTC frame rate" must be set to the same frame rate as in D-90 (#1).

# Refer to page "128", SETUP mode "10. Setup of the MTC frame rate" for operating procedure and details.

4. Set the SETUP mode "Setup of the MIDI device ID," to "01" in D-90 (#2), and to "02" in D-90 (#3).

# Refer to page "138", SETUP mode "18. Setup of the MIDI device ID" for operating procedure and details.

5. Set the slave mode to "ON" and the sync signal to "adat" by the SETUP mode "Setup of the slave mode."

\* Initial setting: OFF  
\* Permissible setup item: ON, OFF  
\* Permissible setup of sync signal: MTC, SP DIF, adat, Free (only when set to ON)  
\* This item can be set for each program.  
\* The setting can be saved/loaded as song data.  
\* This setting will be held even though power is switched OFF.

# Refer to page "136", SETUP mode "17. Setup of the slave mode" for operating procedure and details.

6. Press the DISP SEL key while pressing the EXECUTE/YES key to change the time base display to MTC.

**<Note>**

After setting this, check the following points in D-90 (#2) and D-90 (#3).

\* "CHASE" in the display blinks:  
This will change to lit when chase lock is completed in a later procedure.  
\* "DIGITAL" in the display is lit:  
It is externally synchronized against the input digital signal.

**<Note>**

Do not insert or remove the optical cable connected to the DATA IN connector when the slave mode is set to "on."  
It could generate noise from this equipment and also affect external equipment.

**Check chase lock**

1. When the master unit (D-90 (#1)) is played back, MTC IN LED of the slave unit (D-90 (#2) and (#3)) will be lit. "CHASE" in the display will immediately change from blinking to lit, and chase lock will be completed. Check that the MTC time on display are same in both master and slave units.
2. When the master starts recording, the slave will also start recording upon completing chase lock.



D-90 Owner's Manual (MIDI sync function)

3. When the master is stopped, the slave will also stop because MTC from the master will be interrupted.  
"CHASE" in the display will change from constant lit to blinking.
4. During FF/REW, the master only will be in the FF/REW mode and the slaves will remain stopped but when playback/recording is started, they will immediately chase lock.

**<Note>**

The D-90 re-chase window is fixed at "10 frame." In other words, when MTC of the master and slave drifts more than 10 frames, the D-90 will assume that chase lock is disengaged and the slave will match the position again with the master (=re-chase operation). During the re-chase operation, the sound output will be muted. If the drift is within 10 frames, the slave will admit this and continue to travel. Because the master supplies digital signal to slave in this system, re-chase is seldom carried out following chase lock.

- \* Should it fail to correctly chase lock and control, re-check the connection / cables and each settings.

**Record track selecting from the master**

The slave unit record track can be selected from the master unit by using the master unit FUNC key.

1. Press the D-90 (#1) FUNC key (LED is lit).  
"DEVICE" in the display will blink.
  2. Press the RECORD TRACK select key corresponding to the MIDI DEVICE ID set by each slave.  
Thus, select track 1 for D-90 (#2) (ID 1) and track 2 for D-90 (#3) (ID 2) (Refer to "Setup of the MIDI device ID" mentioned before.)  
"DEVICE" in the display will change to lit and the selected DEVICE ID will be displayed.
  3. Press a random RECORD TRACK select key.  
Record track in the selected slave will be selected.
  4. Press the FUNC key again (LED is extinguished).
- \* Should it fail to control correctly, re-check the connection / cables and each settings.

**Execution of recording**

Various recording work is carried out with all three D-90's in the chase lock mode.

- \* Sound can be exchanged digitally between each piece of equipment if "Setup of the digital input track" and "Setup of the digital output track" are set as necessary in all three D-90's.  
Please note, however, that when the digital input track is setup, that track will not be able to input analog signals.

### Setup mode

The Setup mode of the D-90 allows you to set various parameters related to the applications and environment. The following items are included in Setup mode. This chapter explains the basics of Setup mode, including how to set the parameters.

Setup mode parameters are divided into two categories: parameters set for each Program (P1-P9) individually, and parameters with global settings for all Programs. The following table provides the details. ("LOAD", "SAVE", and "FORMAT" are not included here.)

Parameters that can be set for each Program will be saved and loaded as part of the song data. On the other hand, parameters that are common to all Programs cannot be saved or loaded. All parameter settings are retained after the power is turned off.

Indication	Function	Commonness		Default setting
		○:Setup for each program	●:Effective against ALL	
"BAR *	Sets the time signature on the Tempo Map (selected from 11 signatures: 1/4 - 8/8).	○		001 BAR 04 04
"TEMPO"	Sets the tempo on the Tempo Map.	○		001 BAR 1, Tempo120
"Click"	Turns the Metronome function on/off.	○		OFF
"LOAD"	Loads a data file saved on a DAT to the D-80.	—		
"SAVE"	Saves recordings/setup data from the hard disk to the DAT machine.	—		
"FORMAT"	Initializes the hard disk.	—		
"PREROLL TIME"	Sets the preroll value for the locate point.	○		005 (00 second)
"MIDI SYNC OUT"	Selects the signal output from the MIDI OUT connector.	○		CLOCK (MIDI clock)
"FRAME RATE"	Selects the frame rate for MTC output.	○		25 frame
"MTC OFFSET"	Sets the offset value between MTC and ABS time.	○		01 59M 57S 00F 00SF
"MTC OFFSET MODE"	Sets the OFFSET mode.	○		ABS
"ENABLE REC"	Selects recording enable/disable.	○		ENABLE
"IG In"	Selecting a digital input track.	●		L - (no assign), R - (-)
"IG out"	Selecting a digital output track.	●		Adst
"E So Lu"	Setting Display Resolution mode ON/OFF.	●		OFF
"SLAVE" [TYPE]	Setting Slave mode ON/OFF.	○		OFF [MTC]
"de vi ce"	Setting a device ID.	●		00 (device No.=00)
"un do"	Setting an effective range of the Undo function.	●		EDIT (Edit & Auto Punch)
"FS S ET"	Setting a Sampling Frequency.	○		44.1 (44.1kHz)

#### 1. Entering Setup mode

Follow the steps below to select a desired Setup mode.

In all procedures in this manual, it is assumed that a recording Program or a recorded Program has already been selected. Be sure to confirm that you are working on the right Program.

# Refer to the previous section "Setting a Program" for information on how to set the Program.

1. Press the DISP SEL key to select Setup mode. (the "SETUP" indicator will blink.)

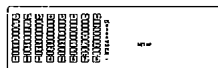

2. Press the EXECUTE/YES key. (The "SETUP" indicator will be lit.)

The display will change as shown below, indicating that the D-90 has entered the first hierarchy.

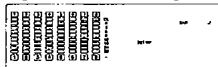

**<Note>**

When you use the D-90 for the first time, or when you turn on the power to the D-90 after initializing the hard disk, "BAR 1" will blink on the first stage. Otherwise, the SETUP item last specified will be shown.

3. Turn the JOG dial to show the desired item.

Turning the dial clockwise or counter-clockwise will show each item's title (blinking) on the display.

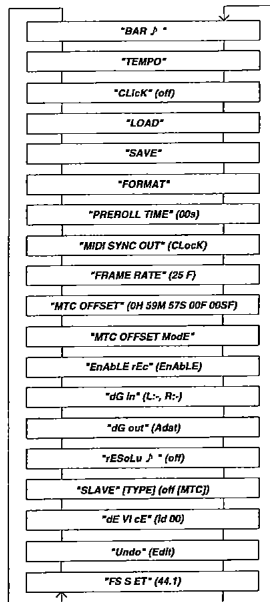

4. After displaying the desired SETUP item, pressing the EXECUTE/YES key again will select each item. (Second stage)

"BAR J" -> Time signature  
(Default: 1 bar - 4/4)

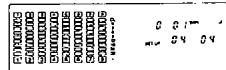

"TEMPO" -> Tempo setting  
(Default: 1 bar - 1st beat - 120)

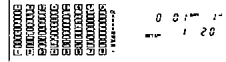

D-90 Owner's Manual (SETUP mode)

\*CLck\*->Metronome function  
(Default: off)



\*LOAD\*->Load function  
(DIGITAL is blinking: This indicates that digital signal is not being transmitted correctly from an external DAT/tadat to the D-90.)

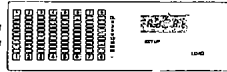

\*SAVE\*->Save function

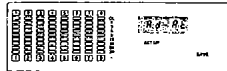

\*FORMAT\*->Format function

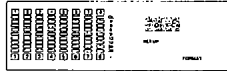

\*PREROLL TIME\*->Preroll Time setting  
(Default: 00s)

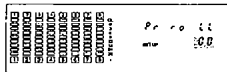

\*MIDI SYNC OUT\*->MIDI SYNC OUT setting  
(Default: Clock signal)

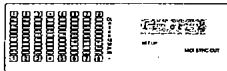

\*FRAME RATE\*->MTC Frame Rate setting  
(Default: 25F)



\*MTC OFFSET\*->MTC OFFSET setting  
(Default: 0H 59M 57S 00F 00SF)



\*MTC OFFSET MODE\*->MTC OFFSET mode setting  
(Default: ABS)



\*rEc\*->Recording enable/disable setting  
(Default: ENABLE)

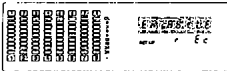

D-90 Owner's Manual (SETUP mode)

"dG In"->Selecting a digital input track  
(Default: L; R; -)

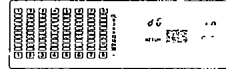

"dG out"->Selecting a digital output track  
(Default: Adat)

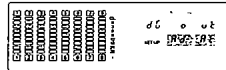

"RESoLu"->Setting display resolution mode  
(Default: oFF)



"SLAVE"->Setting slave mode [type]  
(Default: oFF [MTC])



"dEVICE"->Setting a device ID  
(Default: 00)

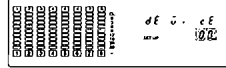

"undo"->Setting an effective range of the  
undo function (Default: Edit)

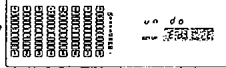

"FS S ET"->Setting a sampling frequency  
(Default: 44.1)

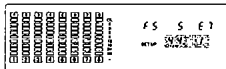

Use the STOP button or the EXIT/NO key to move from the second level of Setup mode (setting the parameters) to the first level of Setup mode (selecting a Setup parameter), or to quit Setup mode. Pressing either key repeatedly will take you back through the previous layers one by one or allow you to select another parameter, and finally the unit will quit Setup mode and return the screen to the Time Base display.

## 2. Setting a time signature ("BAR ♪")

You can set a time signature for any bar (measure) on the internal programmable Tempo Map. For example, you can specify "4/4 from the first measure and 2/4 from the 17th measure."

Setting a time signature and tempo will create a Tempo Map, which the D-90 will use to manage data based on the Time Base of "BAR/♪/CLX," and which will allow you to use the Metronome function. If you wish to send MIDI clock and Song Position Pointer data to an external sequencer, you need to set a time signature and tempo.

\* Refer to page "98" for information on the "MIDI clock synchronization system."

**<Note>**

The D-90 can play back only the recorded area (from ABS 0 to ABS END). It will not output MIDI clock or Song Position Pointer data in an unrecorded area even if you set a time signature and tempo.

- \* Initial setting: Bar 001, Time signature 4/4
- \* Range of bars: 001 - 999
- \* Available time signature: 1/4, 2/4, 3/4, 4/4, 5/4, 1/8, 3/8, 5/8, 6/8, 7/8, 8/8 -- (deleting a time signature)
- \* The maximum number of points: 64 points
- \* This parameter can be set for each Program.
- \* This parameter can be saved and loaded as part of the song data.
- \* This parameter setting will be retained after you turn off the power.
- \* Check to see if you have selected the correct Program.

1. Press the **DSP SEL** key to select "SETUP" ("SETUP" flashes), then press the **EXECUTE/YES** key ("SETUP" lights up).  
The unit enters Setup mode.

2. Use the **JOG** dial to select "BAR ♪" (flashing).

3. Press the **EXECUTE/YES** key. ("BAR ♪" lights up.)

The bar and time signature that were set or used will appear. (The initial setting is bar 001 and the time signature is 4/4.)

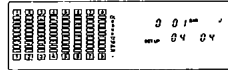

### Checking the stored time signature settings

4. When "BAR ♪" is lit, turn the **JOG** dial.

The stored bar and time signature settings will be displayed one by one (\*\*\*\*BAR \*\* \*\* ♪). When you turn the **JOG** dial clockwise all the way, "— BAR — ♪" appears, indicating that no more settings are stored.

**<Note>**

The last time signature stored (the one before "— BAR — ♪") will be used for the following bars (up to ABS END). In the initial setting, bar 001 (the bar that contains the last time signature) has a setting of 4/4. Therefore, the following bars (starting from bar 002) will use a time signature of 4/4 unless you change it.

### Storing a time signature

5. When "BAR ♪" is lit, press the **EXECUTE/YES** key.

"BAR" will flash and you will be able to edit the bars.

6. Use the **HOLD**> key or the **SHUTTLE** dial to select "BAR (bar)" or "J (time signature)" (the selected parameter will flash), and use the **JOG** dial to set the value.  
 For the bar parameter, you can enter a value in steps of bars, with the range of 001 - 999. The available time signatures are 1/4, 2/4, 3/4, 4/4, 5/4, 1/8, 3/8, 5/8, 6/8, 7/8, and 8/8. "--" means "none" and is used to delete a time signature setting.  
 When "BAR" is flashing, turn the **JOG** dial. If the bars already have a time signature, its setting "\*\*\*" will be displayed. If the bars do not have a time signature, "--" will appear.
7. When you finish setting the bar and the time signature, press the **EXECUTE/YES** key. The values will be stored, and "BAR" will flash on the display.
8. Repeat Steps 5-7 to store a time signature for each Tempo Map bar.

\* Press the **STOP** button or the **EXIT/NO** key to cancel the operation or to return to the screen shown before you pressed the **EXECUTE/YES** key. Pressing either key repeatedly will take you back to the previous level one step at a time until the unit quits Setup mode and the screen returns to the Time Base indication.

<Notes>

\* you can store up to 64 points (time signatures).  
 \* If you specify a time signature for the bar that is beyond the available recording time range, the setting will be ignored since that bar cannot be reached due to lack of recording time.

**Modifying a time signature (delete)**

- Follow Steps 1-5 described above.
6. While "BAR" is flashing, turn the **JOG** dial to display the bar number for which you wish to modify the time signature.  
 If the time signature has already been stored for that bar, the time signature "\*\*\*" will appear.  
 "J" will flash, and you will be able to edit the time signature.
7. Use the **HOLD**> key or the **SHUTTLE** dial to select "J".  
 "J" will flash, and you will be able to edit the time signature.
8. Use the **JOG** dial to edit the value.  
 If you set the time signature to "--", the time signature will be deleted.
9. When modifying or deleting the bar and time signature is complete, press the **EXECUTE/YES** key.

The modified bar and time signature will be stored, or the time signature will be deleted, depending on your operation. The screen will go back to the display in Step 5 ("BAR" flashes).

\* Press the **STOP** button or the **EXIT/NO** key to cancel the operation or to return to the screen shown before you pressed the **EXECUTE/YES** key. Pressing either key repeatedly will take you back to the previous level one step at a time until the unit quits Setup mode and the screen returns to the Time Base indication.

<Notes>

\* You cannot specify "--" for the first bar 001 BAR.  
 \* If modifying or deleting the stored time signature has erased the bar/beat position for which the tempo was stored (see "Setting a tempo" described later), the tempo data for that beat or bar will be automatically deleted. (e.g.: A time signature of 4/4 was changed to 3/4 in 010BAR. --> The tempo information on the fourth beat of the first bar (010 BAR 4 ?) will be automatically deleted.)

**Deleting all stored time signatures**

- Follow Steps 1-5 described above.
6. While "BAR" is flashing, turn the **JOG** dial all the way counter-clockwise.  
 The screen will display "ALL CL Er" and "SURE?" (flashing).
7. Press the **EXECUTE/YES** key.  
 All stored time signatures and tempo information of the bars will be reset to their initial values, and the screen will return to the display in Step 5 ("BAR" flashes).

**<Note>**  
 It should be noted that not only the time signatures but also the tempo information will be erased.

\* Press the STOP button or the EXIT/NO key to cancel the operation or to return to the screen the shown before you pressed the EXECUTE/YES key. Pressing either key repeatedly will take you back to the previous level one step at a time until the unit quits Setup mode and the screen returns to the Time Base indication.

### 3. Setting a tempo ("TEMPO")

You can set a tempo at any point in a song that already contains the time signature setting. For example, you may specify a tempo of 150 to the third beat in the 12th bar. The time signature and tempo settings will generate a Tempo Map, which D-90 will use along with Time Base "BAR/ ♪ /CLK" and allow you to use the Metronome function. You need to set a time signature and tempo so that the D-90 will transmit MIDI clock and Song Position Pointers to an external sequencer.

# Refer to page "98" for information on "MIDI clock sync system."

**<Note>**  
 The D-90 can play back only the recorded area (from ABS 0 to ABS END). It will not output MIDI clock or Song Position Pointer data in an unrecorded area even if you set a time signature and tempo.

- \* Initial setting: Bar 001, First beat - 120
- \* Range of bars: Depends on the time signature setting.
- \* Range of beats: Depends on the time signature setting.
- \* Available tempo settings: 30 - 250, -- (deleting a tempo)
- \* The maximum number of points: 64 points
- \* This parameter can be set for each Program.
- \* This parameter can be saved and loaded as part of the song data.
- \* This parameter setting will be retained after you turn off the power.
- \* Check to see if you have selected the correct Program.

1. Press the DISP SEL key to select "SETUP" ("SETUP" flashes), then press the EXECUTE/YES key ("SETUP" lights up).  
 The unit enters Setup mode.
2. Use the JOG dial to select "TEMPO" (flashing).
3. Press the EXECUTE/YES key. ("BAR ♪ TEMPO" lights up.)  
 The bar, beat, and tempo that were set or used will appear. (The initial setting is the first beat of bar 001 with a tempo of 120.)

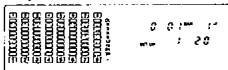

#### Checking the stored tempo settings

4. While "BAR ♪ TEMPO" is lit, turn the JOG dial.  
 The stored bar, beat, and tempo settings will be displayed one by one ("\*\*\*BAR ♪ \*\*\*TEMPO"). When you turn the JOG dial clockwise all the way, "-- BAR - ♪ - TEMPO" appears, indicating that no more settings are stored.

**<Note>**  
 The last tempo setting stored in the bar/beat (one setting before "-- BAR - ♪ -") will be used for the following bars and beats (up to ABS END).  
 In the initial setting, the first beat of bar 001 (the bar and beat that contains the last tempo setting) has a setting of 120. Therefore, the following beats and bars (starting from the second beat of bar 001) will use a tempo of 120 unless you change it or add another setting.



**Storing a tempo**

5. While "BAR ♪ TEMPO" is lit, press the EXECUTE/YES key.  
"BAR" will flash and you will be able to edit the bars.
6. Use the HOLD/> key or the SHUTTLE dial to select "BAR (bar)", "♪ (beat)", or "TEMPO" (the selected parameter will flash), and use the JOG dial to set the value.  
The range of the bar and beat you can set depends on the range of the bar and beat defined in "Setting a time signature." The available tempo settings are 30 - 250 per a quarter note. "-" means "none" and is used to delete a tempo setting.  
While "BAR" or "♪ (beat)" is flashing, turn the JOG dial. If the bars and beats already have a tempo, its value \*\*\*\* will be displayed. If they do not have a tempo, "-" will appear.
7. When you finish setting the bar, beat, and tempo, press the EXECUTE/YES key.  
The values will be stored, and "BAR" will flash on the display.
8. Repeat Steps 5-7 to store a tempo setting.

\* Press the STOP button or the EXIT/NO key to cancel the operation or to return to the screen the shown before you pressed the EXECUTE/YES key. Pressing either key repeatedly will take you back to the previous level one step at a time until the unit quits Setup mode and the screen returns to the Time Base indication.

<Notes>

\* You can store up to 64 points (tempo settings).

\* If you specify a time signature for the bar that is beyond the available recording time range, the setting will be ignored since that bar cannot be reached due to lack of recording time.

e.g.: After setting a time signature as follows, set a desired tempo.

Tempo map	
Time signature	Tempo
001 <sup>BAR</sup> , 0404 <sup>♪</sup>	001 <sup>BAR</sup> , 1 <sup>♪</sup> , 120 TEMPO
005 <sup>BAR</sup> , 0304 <sup>♪</sup>	003 <sup>BAR</sup> , 1 <sup>♪</sup> , 90 TEMPO
	005 <sup>BAR</sup> , 3 <sup>♪</sup> , 60 TEMPO
	007 <sup>BAR</sup> , 2 <sup>♪</sup> , 120 TEMPO

**Modifying a tempo (delete)**

- Follow Steps 1-5 described above.
6. Use the HOLD/> key or the SHUTTLE dial to display the flashing "BAR" or "♪" and select a bar and beat to modify.  
If the tempo has already been stored for that bar and beat, the tempo value \*\*\*\* will appear.
  7. Use the HOLD/> key or the SHUTTLE dial to select "TEMPO."  
"TEMPO" will flash, and you will be able to edit the tempo.
  8. Use the JOG dial to edit the value.  
If you set the tempo to "-", the tempo setting for that bar and beat will be deleted.
  9. When modifying or deleting the bar, beat, and tempo settings is complete, press the EXECUTE/YES key.  
The modified bar, beat, and tempo settings will be stored, or the stored bar, beat, and tempo settings will be deleted, depending on your operation. The screen will return to the display in Step 5 ("BAR" flashes.).

\* Press the STOP button or the EXIT/NO key to cancel the operation or to return to the screen the shown before you pressed the EXECUTE/YES key. Pressing either key repeatedly will take you back to the previous level one step at a time until the unit quits Setup mode and the screen returns to the Time Base indication.

<Note>

You cannot specify tempo "-" for 001 BAR 1 ♪.

**Deleting all stored tempo settings**

By following the steps described in the section "Deleting all time signatures," you can delete all tempo settings along with all time signatures.

# Refer to the section "Deleting all time signatures" for more information.

#### 4. Setting the Metronome function ("CL ic K")

The D-90 can output a metronome sound from Track 8 during playback or recording, according to the Tempo Map specified in sections "Setting a time signature" and "Setting a tempo."

You can play instrument accompanying this metronome sound during a recording session. When this function is on, the D-90 will output a metronome sound from Track 8 during playback or recording.

**<Notes>**

\* When the metronome function is ON, Track 8 will play back the metronome sound. Therefore, you cannot play back recorded audio data on Track 8. Do not set Track 8 to record mode while the metronome sound is playing.

\* The D-90 can play back only the recorded area (from ABS 0 to ABS END). It will not output a metronome sound in an unrecorded area.

\* Initial setting: OFF

Options: OFF, ON

\* This parameter can be set for each Program.

\* This parameter can be saved and loaded as part of the song data.

\* This parameter setting will be retained after you turn off the power.

\* Check to see if you have selected the correct Program.

1. Press the DISP SEL key to select "SETUP" ("SETUP" flashes), then press the EXECUTE/YES key ("SETUP" lights up).  
The unit enters Setup mode.

2. Use the JOG dial to select "CL ic k" (flashing).  
The display will show the current setting. (Initial setting is "oFF.")

3. Press the EXECUTE/YES key. ("CL ic k" lights up.)

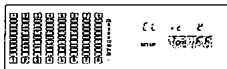

4. Turn the JOG dial to select ON or OFF.  
A click sound will be output with the "on" setting.  
A click sound will not be output with the "oFF" setting.

5. Press the EXECUTE/YES key again.  
The display in step 2 will appear, and the setting is complete.

\* Press the STOP button or the EXIT/NO key to cancel the operation or to return to the screen the shown before you pressed the EXECUTE/YES key. Pressing either key repeatedly will take you back to the previous level one step at a time until the unit quits Setup mode and the screen returns to the Time Base Indication.

### 5. Loading song data ("LOAD")

You need to select "LOAD" in Setup mode before you load song data.  
Loading song data from an external SCSI device (when the optional Model 8338 D-90 SCSI card is installed) is also performed in this mode.

\* Refer to the previous section "Saving and loading song data" for more information on how to load song data.

\* Refer to the instruction guide for information on Model 8338 (D-90 SCSI card).

\* This explanation is based on the assumption that the D-90 is not equipped with the Model 8338.

\* Input options: adat, DAT  
\* Programs: P1-P9  
\* One load operation per one Program

1. Press the DISP SEL key to select "SETUP" ("SETUP" flashes), and press the EXECUTE/YES key. ("SETUP" lights up.)  
The unit enters Setup mode.

2. Use the JOG dial to select "LOAD" (flashing).

3. Press the EXECUTE/YES key ("LOAD" light up.).

The indicator of the digital signal currently-selected to load will flash.

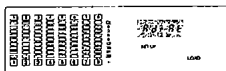

4. Turn the JOG dial to select the type of digital signal to load.

Selecting "Ad At" will load an adat digital signal.

Selecting "dA t" will load an S/P DIF digital signal.

5. Press the EXECUTE/YES key. ("LOAD" lights up and "SURE?" flashes.)

The digital signal to load will be selected and the currently-selected Program indicator will flash.

6. Turn the JOG dial to select a Program into which to load data.

You can select from P1 - P9.

Turn the JOG dial to select a Program, and the recording time (time from ARS 0 to ABS END) for that Program will be displayed.

7. Press the EXECUTE/YES key to perform the loading operation.

"PL Ay dA t" will be displayed.

When the D-90 recognizes that the input digital signal is valid, it will start loading data.

The time required for loading will count down on the display.

8. When the loading operation is complete, "COMPLETED" will light up on the display.

9. Press the STOP button or the EXIT/NO key to quit Setup mode, and the screen will indicate the Time Base for the loaded Program.

\* Press the STOP button or the EXIT/NO key to cancel the operation or to return to the screen the shown before you pressed the EXECUTE/YES key. Pressing either key repeatedly will take you back to the previous level one step at a time until the unit quits Setup mode and the screen returns to the Time Base indication.

<Note>

Do not connect to disconnected the optical cable during the load stand-by status.  
Otherwise, D-90 may generate noise, affecting the external devices.

### 6. Saving song data ("SAVE")

You need to select "SAVE" in Setup mode to save song data. Saving song data to an external SCSI device (when the optional Model 8338 D-90 SCSI card is installed) is also performed in this mode.

\* Refer to the section "Saving and loading song data" for more information on how to save song data.  
\* Refer to the instruction guide for information on Model 8338 (D-90 SCSI card).  
\* This explanation is based on the assumption that the D-90 is not equipped with the Model 8338.

\* Input options: adat, DAT  
\* Programs: P1-P9, ALL  
\* One save operation per Program or all Programs

1. Press the DISP SEL key to select "SETUP" ("SETUP" flashes), and press the EXECUTE/YES key. ("SETUP" lights up.)  
The unit enters Setup mode.
2. Use the JOG dial to select "SAVE" (flashing).
3. Press the EXECUTE/YES key ("SAVE" light up).  
The indicator of the currently selected digital signal for saving will flash.

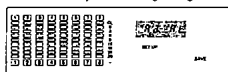

4. Turn the JOG dial to select the type of digital signal to save.  
Selecting "Ad At" will save an adat digital signal.  
Selecting "dA" will save an S/P DIF digital signal.
5. Press the EXECUTE/YES key. ("SAVE" lights up.)  
The digital signal to save will be selected and the currently-selected Program indicator will flash.
6. Turn the JOG dial to select a Program to save.  
You can select from P1 - P9.  
Turn the JOG dial to select a Program, and the recorded time (time from ABS 0 to ABS END) for that Program will be displayed.
7. Press the EXECUTE/YES key. ("SURE?" flashes.)  
"rEco rd Ad At" or "rEco rd dA" will flash on the display.
8. Start recording on the external digital device, then on the D-90 press the EXECUTE/YES key to perform the saving operation. ("REMAIN" lights up.)  
The saving operation will start. The time required for saving will count down on the display.
9. When the save operation is complete, "COMPLETED!" will light up on the display.
10. Press the STOP button or the EXIT/NO key to quit Setup mode, and the screen will indicate the Time Base display.

\* Press the STOP button or the EXIT/NO key to cancel the operation or to return to the screen the shown before you pressed the EXECUTE/YES key. Pressing either key repeatedly will take you back to the previous level one step at a time until the unit quits Setup mode and the screen returns to the Time Base Indication.

### 7. Formatting a hard disk ("FORMAT")

Setup "FORMAT" allows you to format (initialize) the hard disk. When you format the disk, all the existing recordings and their data, as well as the Setup data, will be initialized to factory default settings. You need to format a hard disk such as an optional removable hard disk cartridge if it has not been formatted. Formatting an external SCSI device (when the optional Model 8338 D-90 SCSI card is installed) is also performed in this mode.

\* Refer to page \*\* for more information on replacing the removable hard disk cartridge.  
 \* Refer to the instruction guide for Model 8338 for information on Model 8338 (D-90 SCSI card).  
 \* The explanation here is based on the assumption that the D-90 is not equipped with the Model 8338.

1. Press the DISP SEL key to select "SETUP" ("SETUP" flashes), then press the EXECUTE/YES key ("SETUP" lights up). The unit enters Setup mode.
2. Use the JOG dial to select "FORMAT" (flashing).
3. Press the EXECUTE/YES key. ("id E" flashing.)

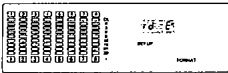

4. Press the EXECUTE/YES key again. ("SURE?" flashing.)

\* To cancel the format operation, press the STOP button or the EXIT/NO key.

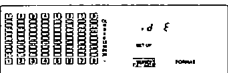

5. Press the EXECUTE/YES key. The format operation will start, and the display will show the available recording time (not the time taken for formatting), and count down the time.

**<Note>**  
 Once you start formatting the disk, you cannot cancel the operation once it is underway. (Even the STOP button and the EXIT/NO key are disable.) If you do not wish to lose the recorded audio data, do not press the EXECUTE/YES key at this time.

6. When formatting is complete, the "COMPLETED" indicator will be lights up.
7. Pressing the STOP button or the EXIT/NO key will allow you to quit Setup mode, and the D-90 will stop at the position (Timebase=ABS 00M 00S 00F) obtained right after you turned on the power to the D-90 for the first time.

\* Press the STOP button or the EXIT/NO key to cancel the operation or to return to the screen the shown before you pressed the EXECUTE/YES key. Pressing either key repeatedly will take you back to the previous level one step at a time until the unit quits Setup mode and the screen returns to the Time Base indication.

**8. Setting the preroll time for the Locate operation ("PREROLL TIME")**

The D-90 is equipped with a preroll function that parks the D-90 a specified time before the locate point when you perform the locate operation.

You can set any preroll time between 0-10 seconds using the Setup "PREROLL TIME" parameter.

This function is useful when you wish to start monitoring data slightly before the stored locate point.

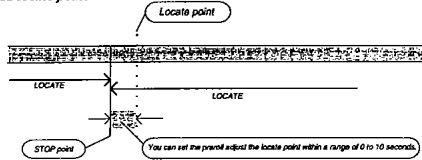

- \* Default setting: 00
- \* Second: 00 - 10 sec.
- \* This parameter can be set for each Program.
- \* This parameter can be saved and loaded as part of the song data.
- \* This parameter setting will be retained after you turn off the power.
- \* Check to see if you have selected the correct Program.

1. Press the DISP SEL key to select "SETUP" ("SETUP" flashes), then press the EXECUTE/YES key ("SETUP" lights up).  
The unit enters Setup mode.

2. Use the JOG dial to select "Pr roll" (flashing).  
The display will show the current setting preroll time. (Initial setting is "00.")

3. Press the EXECUTE/YES key. ("Pr roll" lights up.)  
The current preroll time will be flashing.

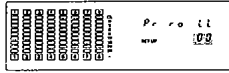

4. Use the JOG dial to enter a desirable preroll time.  
Turning the dial clockwise will increment the value, and turning it counter-clockwise will decrement the value.

5. After setting the value, press the EXECUTE/YES key again.  
The display will go back to that obtained in step 2, and the setting will be complete.

6. Press the STOP button or EXIT/NO key to quit Setup mode.

- \* Press the STOP button or the EXIT/NO key to cancel the operation or to return to the screen the shown before you pressed the EXECUTE/YES key. Pressing either key repeatedly will take you back to the previous level one step at a time until the unit quits Setup mode and the screen returns to the Time Base indication.

### 9. Setting MIDI sync signal output ("MIDI SYNC OUT")

This section explains how to select the type of MIDI sync signal output from the D-90's MIDI OUT connector to an external MIDI device.

The D-90 can output MIDI clock, Song Position Pointers, and MTC (MIDI time code). Select the sync signal that can be received by the connected external MIDI device. If you wish to have MIDI clock and Song Position Pointers transmitted, you need to first set a time signature (see "2. Setting a time signature") and a tempo (see "3. Setting a tempo.").

If you wish to have MTC (MIDI time code) transmitted, you need to set an MTC frame rate (see "10. Setting a MTC frame rate."), MTC offset time (see "11. Setting MTC offset time."), and MTC offset mode (see "12. Setting MTC offset mode.").

# Refer to "MIDI Sync function" on page 98 for more information on MIDI synchronization.

**<Note>**

The D-90 can play back only the recorded area (from ABS 0 to ABS END). It will not output MIDI clock, Song Position Pointer, or MTC data in an unrecorded area.

- \* Initial setting: clock
- \* Options: Clock (MIDI clock & Song Position Pointer: "CL oc K"), MTC (MIDI time code: "Mtc"), OFF (No MIDI sync signal)
- \* This parameter can be set for each Program.
- \* This parameter can be saved and loaded as part of the song data.
- \* This parameter setting will be retained after you turn off the power.
- \* Check to see if you have selected the correct Program.

1. Press the DISP SEL key to select "SETUP" ("SETUP" flashes), then press the EXECUTE/YES key ("SETUP" lights up). The unit enters Setup mode.

2. Use the JOG dial to select "MIDI SYNC OUT" (flashing). The display will show the current setting value. (Initial setting is "CLock.")

3. Press the EXECUTE/YES key. ("MIDI SYNC OUT" lights up.)

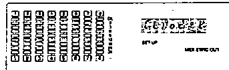

4. Select a desirable option using the JOG dial.

- CLock: MIDI Clock signal and song position pointer is output.
- Mtc: MIDI timecode is output.
- oFF: No signal is output.

5. After selection, press the EXECUTE/YES key again. The display will return to that displayed in step 2, and the setting will be complete.

6. Press the STOP button or the EXIT/NO key to quit Setup mode.

\* Press the STOP button or the EXIT/NO key to cancel the operation or to return to the screen the shown before you pressed the EXECUTE/YES key. Pressing either key repeatedly will take you back to the previous level one step at a time until the unit quits Setup mode and the screen returns to the Time Base Indication.

### 10. Setting a MTC frame rate ("FrAm E")

If you have selected "MTC" in the previous section ("9. Setting MIDI sync signal output"), you need to set an MTC frame rate. An MTC frame rate should be set in order for MTC (MIDI time code) to be output to a computer. Set this field so that the MTC frame rate on the D-90 will match that of the external MIDI device (such as a computer running a sequence software).

# Refer to page 98 for more information on MTC synchronization.

**<Note>**

The D-90 can play back only the recorded area (from ABS 0 to ABS END). It will not output MIDI clock, Song Position Pointer, or MTC data in an unrecorded area.

- \* Initial setting: 25 frames
- \* Options: 24, 25, 30ND, 30DF
- \* This parameter can be set for each Program.
- \* This parameter can be saved and loaded as part of the song data.
- \* This parameter setting will be retained after you turn off the power.
- \* Check to see if you have selected the correct Program.

1. Press the DISP SEL key to select "SETUP" ("SETUP" flashes), then press the EXECUTE/YES key ("SETUP" lights up).  
The unit enters Setup mode.

2. Use the JOG dial to select "Fr AM E" (flashing).  
The display will show the current setting frame rate. (Initial setting is "25F.")

3. Press the EXECUTE/YES key. ("Fr AM E" lights up).  
"F" on the display will blink, indicating that you can edit the parameter.

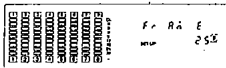

4. Select a desirable option using the JOG dial.

- 25: 25 frames
- 24: 24 frames
- dF 30: 30 drop frames
- nd 30: 30 non-drop frames

5. After you select a frame rate, press the EXECUTE/YES key again.  
The display will return to that displayed in step 2, and the setting will be complete.

6. Press the STOP button or the EXIT/NO key to quit Setup mode.

\* Press the STOP button or the EXIT/NO key to cancel the operation or to return to the screen the shown before you pressed the EXECUTE/YES key. Pressing either key repeatedly will take you back to the previous level one step at a time until the unit quits Setup mode and the screen returns to the Time Base Indication.



### 11. Setting MTC offset time (:MTC OFFSET)

If you have selected "MTC" in the previous section ("9. Setting MIDI sync signal output"), you need to set an MTC offset time.  
 The offset is a time difference between the MTC and ABS 00M 00S 00F 00SF. With the initial setting, MTC of 00M 59S 57F 00SF will be output at ABS 00M 00S 00F 00SF.  
 You can also set an offset between the MTC and 001BAR/ 1 ♪ / 00CLK, depending on the setting of MTC offset mode described later.

# Refer to the section "Getting Started, 3. Time Base" for information on the position of MTC, ABS, and BAR/ ♪ /CLK.  
 # Refer to page 98 for more information on MTC synchronization.

<Notes>  
 The D-90 can play back only the recorded area (from ABS 0 to ABS END). It will not output MIDI clock, Song Position Pointer, or MTC data in an unrecorded area.

\* Initial setting: 00H (Hour) 59M (Minute) 57S (Second) 00F (Frame) 00SF (Sub Frame)  
 \* Range: 00H 00M 00S 00SF - 23H 59M 59S 29SF  
 \* This parameter can be set for each Program.  
 \* This parameter can be saved and loaded as part of the song data.  
 \* This parameter setting will be retained after you turn off the power.  
 \* Check to see if you have selected the correct Program.

1. Press the DISP SEL key to select "SETUP" ("SETUP" flashes), then press the EXECUTE/YES key ("SETUP" lights up).  
 The unit enters Setup mode.
2. Use the JOG dial to select "MTC" "OFFSET" (flashing).  
 The display will show the current setting MTC offset time. (Initial setting is 00H 59M 57S 00F 00SF.)
3. Press the EXECUTE/YES key. ("MTC" "OFFSET" lights up.)  
 "S" on the display will blink, indicating that you can edit the parameter.

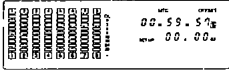

4. Use the HOLD/← key or the SHUTTLE dial to select the digit you wish to edit (hour, minute, second, frame, sub-frame), and use the JOG dial to set or change the value.
5. After setting the value, press the EXECUTE/YES key again.  
 The display will return to that displayed in step 2, and the setting will be complete.
6. Press the STOP button or the EXIT/NO key to quit Setup mode.

\* Press the STOP button or the EXIT/NO key to cancel the operation or to return to the screen the shown before you pressed the EXECUTE/YES key. Pressing either key repeatedly will take you back to the previous level one step at a time until the unit quits Setup mode and the screen returns to the Time Base indication.

**12. Setting MTC offset mode ("MTC OFFSET Mode")**

If you have selected "MTC" in the previous section ("9. Setting MIDI sync signal output"), you need to set MTC offset mode. This setting determines whether the specified MTC time refers to ABS 00M 00S 00F 00SF or to 001BAR 1 ♪ 00CLK on the Tempo Map.

# Refer to the section "Getting Started, 3. Time Base" for information on the position of MTC, ABS, and BAR/CLK.  
 # Refer to page 88 for more information on MTC synchronization.

<Note>  
 The D-90 can play back only the recorded area (from ABS 0 to ABS END). It will not output MIDI time code in an unrecorded area.

\* Initial setting: ABS  
 \* Options: ABS, BAR ♪  
 \* This parameter can be set for each Program.  
 \* This parameter can be saved and loaded as part of the song data.  
 \* This parameter setting will be retained after you turn off the power.  
 \* Check to see if you have selected the correct Program.

1. Press the DISP SEL key to select "SETUP" ("SETUP" flashes), then press the EXECUTE/YES key ("SETUP" lights up).  
 The unit enters Setup mode.
2. Use the JOG dial to select "MTC," "OFFSET," or "ModE" (flashing).  
 The display will show the current setting value. (Initial setting is "ABS.")
3. Press the EXECUTE/YES key. ("MTC," "OFFSET," and "ModE" will light up.)  
 The current setting will be flashing.

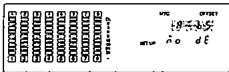

4. Turn the JOG dial to select "ABS" or "BAR ♪".  
 With an "ABS" setting, the MTC offset time will refer to the ABS position 00M 00S 00F 00SF. With a "BAR ♪" setting, the MTC offset time will refer to the position 001BAR 1 ♪ 00CLK on the Tempo Map.
5. After setting, press the EXECUTE/YES key again.  
 The display will go back to that displayed in step 2, and the setting will be complete.
6. Press the STOP button or the EXIT/NO key to quit Setup mode.

\* Press the STOP button or the EXIT/NO key to cancel the operation or to return to the screen the shown before you pressed the EXECUTE/YES key. Pressing either key repeatedly will take you back to the previous level one step at a time until the unit quits Setup mode and the screen returns to the Time Base indication.

### 13. Setting Recording Enable/disable mode ("rEc" ENABLE/DISABLE)

"rEc ENABLE" in Setup mode is used to turn on/off recording enable/disable mode to prevent accidental recording. (This function is similar to breaking the tab on a cassette tape to protect a recording.)

\* Initial setting: ENABLE  
\* Options: ENABLE, DISABLE  
\* This parameter can be set for each Program.  
\* This parameter can be saved and loaded as part of the song data.  
\* This parameter setting will be retained after you turn off the power.  
\* Check to see if you have selected the correct Program.

1. Press the DISP SEL key to select "SETUP" ("SETUP" flashes), then press the EXECUTE/YES key ("SETUP" lights up).  
The unit enters Setup mode.
2. Use the JOG dial to select "rEc" (flashing).  
The display will show the current setting value. (Initial setting is "EnAbLE.")
3. Press the EXECUTE/YES key. ("rEc" lights up.)  
The current setting will be flashing.



4. Turn the JOG dial clockwise to select "rEc di SA bL", or turn it counter-clockwise to select "rEc En Ab LE."  
"EnAb LE": The recording function is enabled. You can use the recording, paste, erase, and cut functions.  
"dISA bL": The recording function is disabled. You cannot use the recording, paste, erase, and cut functions.
5. After setting the value, press the EXECUTE/YES key again.  
The display will return to that displayed in step 2, and the setting will be complete.
6. Press the STOP button or the EXIT/NO key to quit Setup mode.

\* Press the STOP button or the EXIT/NO key to cancel the operation or to return to the screen the shown before you pressed the EXECUTE/YES key. Pressing either key repeatedly will take you back to the previous level one step at a time until the unit quits Setup mode and the screen returns to the Time Base indication.

**14. Setting a digital input track ("dG in")**

The "dG in" parameter in Setup mode allows you to assign a digital signal input at the DATA IN connector to a track of the D-90.

If an S/P DIF digital signal is input, the L and R channels of the signal can be assigned to any track (1-8).

If an adat digital signal is input, 8-track adat signal will be assigned to Tracks 1-8. Make sure that the sampling rate of the input digital signal matches that of the D-90.

*\* Refer to the section "Recording and playback digital signal" for more information on digital signals.*

- \* Initial setting: L - R - (No assignment for both L and R)
- \* Options: Lch = 1-8, adat, - (no assignment), Rch = 1-8, - (no assignment)
- \* This parameter can be set for all Programs.
- \* This parameter can be saved and loaded as part of the song data.
- \* This parameter setting will be retained after you turn off the power.

**<IMPORTANT>**  
When as S/P DIF digital signal is input to the D-90, be sure to match the sampling rate of the D-90 to that of the external digital device.

- \* If the sampling rate setting does not match, you cannot record the S/P DIF digital signal.
- \* For an adat digital signal, the D-90 will be able to record data with a different sampling rate setting. However, the data will be recorded at a different speed. The D-90 will lock to the external Word clock when the S/P DIF or adat digital signals are input to the digital input tracks. (The D-90 will operate, referencing to the word clock sent from the external device.) However, an adat digital signal does not contain the sampling rate information (48kHz or 44.1kHz) that is included in the S/P DIF digital signal. This is why the D-90 can sync to the external device with a different sampling rate.

1. Press the DISP SEL key to select "SETUP" ("SETUP" flashes), then press the EXECUTE/YES key ("SETUP" lights up).  
The unit enters Setup mode.
2. Use the JOG dial to select "dG in" (flashing).  
The display will show the current setting. (Initial setting is "L-, R-".)
3. Press the EXECUTE/YES key. ("dG in" lights up.)  
"L-" on the display will blink, indicating that you can edit the parameter.

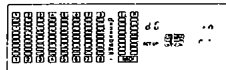

- 4-A. In the case of S/P DIF digital signals, select the S/P DIF digital signal channel (blinking of "L" for the Lch, and "R" for the Rch) and set the D-90 track, to which each channel is to be assigned, with the JOG dial.  
Tracks which can be set here are tracks 1 - 8 and "- (no assign)."  
Any one among these can be freely assigned.

**<Note>**  
Both Lch and Rch cannot be assigned to the same track.  
If mistaken set, the later assigned channel will be effective and the channel assigned before this will be automatically set to "- (no assign). In other words, assignment is given to the later setting.

\* From among the Lch and Rch of the S/P DIF digital signals, one channel only can also be digitally input. For example, if set as "L 4, R-", Lch only of the S/P DIF digital signal can be input to track 4.

D-90 Owner's Manual (SETUP mode)

4-B. In the case of "adat" signals, select the blinking "L" with the HOLD<- key or the SHUTTLE dial, then set to "Adat" (adat) with the JOG dial. It cannot be set when "R" is blinking.

\* "adat" digital signals will be assigned to D-90 in order of the tracks (1->1, 2->2,.....8->8) that are input.

\* If analog instead of digital is to be input, setup to "L-" and "R-."

5. After input, press the EXECUTE/YES key again.

The setting will be registered and the display will return to than in step 2.

Upon confirming input of the digital signal, "DIGITAL (red)" in the display will be lit.

\* If "DIGITAL (red)" blinks, re-check the connections/cables and settings of D-90 and external equipment.

<Notes>

\* In the case of S/P DIF digital signals, if the sampling frequency is different, the 48kHz LED will blink to indicate the setup mistake.

\* In the case of "adat" digital signals, be extremely careful on the sampling frequency setup mistake cannot be indicated by the 48kHz LED.

6. Press the STOP button or the EXIT/NO key to quit Setup mode.

\* Press the STOP button or the EXIT/NO key to cancel the operation or to return to the screen the shown before you pressed the EXECUTE/YES key. Pressing either key repeatedly will take you back to the previous level one step at a time until the unit quits Setup mode and the screen returns to the Time Base indication.

<Notes>

\* Tracks assigned for digital input will accept only a digital signal, not an analog signal.

\* If an adat digital signal is input, all tracks are used for digital input. An analog signal will not be accepted. If you wish to input an analog signal, you need to change the digital input assignment to another track or make no assignment.

\* This setting will automatically disable the Var-pitch function (the LED will be turned off).

15. Setting digital output track ("dG out")

In order for the D-90 to output a digital signal, match the sampling rate of the input digital signal to that of the D-90.

# Refer to the section "Recording and playback digital signal" for more information on digital signals.

- \* Initial setting: adat
- \* Options: adat, ch 12, ch 34, ch 56, ch 78
- \* This parameter can be set for all Programs.
- \* This parameter can be saved and loaded as part of the song data.
- \* This parameter setting will be retained after you turn off the power.

1. Press the DISP SEL key to select "SETUP" ("SETUP" flashes), then press the EXECUTE/YES key ("SETUP" lights up).  
The unit enters Setup mode.
2. Use the JOG dial to select "dG out" (flashing).  
The display will show the current setting value. (Initial setting is "Adat.")
3. Press the EXECUTE/YES key. ("dG out" lights up.)  
The current setting will be flashing.

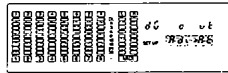

4. Turn the JOG dial to select a digital output channel.  
Selecting "Adat" will cause signal in all the tracks to be output in the form of an adat digital signal.  
Selecting "ch 12," "ch 34," "ch 56," or "ch 78" will cause the signal in the selected two tracks to be output in the form of an S/P DIF digital signal.
5. After setting the value, press the EXECUTE/YES key again.  
The display will return to that displayed in step 2, and the setting will be complete.
6. Press the STOP button or the EXIT/NO key to quit Setup mode.

\* Press the STOP button or the EXIT/NO key to cancel the operation or to return to the screen the shown before you pressed the EXECUTE/YES key. Pressing either key repeatedly will take you back to the previous level one step at a time until the unit quits Setup mode and the screen returns to the Time Base Indication.

### 16. Setting Display Resolution mode On/Off ("rESoLu")

"rESoLu" in Setup menu allows you to turn Display Resolution mode on and off. When you are storing the In/Out points in real-time while using the "BAR/BEAT/CLK" Time Base, you can store them in steps of beats if the "rESoLu" (Display Resolution mode On/Off) in Setup mode is "ON". When this resolution mode is "ON", the CLK value will be rounded up or off to "00" (at the beginning of the beat) as soon as you press the STORE key. This function is useful when you wish to use the Copy & Paste or Move & Paste function in steps of beats.

\* For example, if you try to store value "001BAR", "1BEAT", "46CLK" as the copy start point, and "002BAR", "4BEAT", "51CLK" as the end point while using the BAR/BEAT/CLK Time Base, these values will be stored as follows when they are held if Display Resolution mode has been set to on: The following example uses a time signature of 4/4.  
 "001BAR", "1BEAT", "46CLK" -> "001BAR", "1BEAT", "00CLK" (CLK value is cut off.)  
 "002BAR", "4BEAT", "51CLK" -> "003BAR", "1BEAT", "00CLK" (CLK value is rounded up.)

\* Initial setting: OFF  
 \* Options: OFF, ON  
 \* This parameter can be set for all Programs.  
 \* This parameter can be saved and loaded as part of the song data.  
 \* This parameter setting will be retained after you turn off the power.

1. Press the DISP SEL key to select "SETUP" ("SETUP" flashes), then press the EXECUTE/YES key ("SETUP" lights up).  
The unit enters Setup mode.
2. Use the JOG dial to select "rE So Lu" (flashing).  
The display will show the current setting value. (Initial setting is "oFF.")
3. Press the EXECUTE/YES key. ("rE So Lu" lights up.)  
The current setting will be flashing.

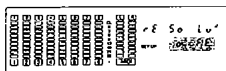

4. Turn the JOG dial to select a digital output channel.  
Turning the JOG dial counter-clockwise will select "oFF," and turning it clockwise will select "on."
5. After setting the value, press the EXECUTE/YES key again.  
The display will return to that displayed in step 2, and the setting will be complete.
6. Press the STOP button or the EXIT/NO key to quit Setup mode.

\* Press the STOP button or the EXIT/NO key to cancel the operation or to return to the screen the shown before you pressed the EXECUTE/YES key. Pressing either key repeatedly will take you back to the previous level one step at a time until the unit quits Setup mode and the screen returns to the Time Base indication.

### 17. Setting Slave mode ("SLAVE")

This parameter toggles the D-90's Slave mode on and off.

With the "ON" setting, the D-90 will lock to MTC (MIDI time code) sent from a connected master device. The D-90 can also run in sync with the selected external sync signal after the sync is complete.

Multiple D-90s will synchronize with each other in a multi-track system. The D-90 also synchronizes with Fostex D-80 (version 2) or DMT-8 (Version 2, or VI). It also locks to MTC sent from a sequence software.

# Refer to the section "MIDI Synchronization function" for more information on MIDI synchronization.

- \* Initial setting: OFF
- \* Options: ON, OFF
- \* Sync signal: MTC, S/P DIF, adat, FREE (only when the mode is set to ON.)
- \* This parameter can be set for each Program.
- \* This parameter can be saved and loaded as part of the song data.
- \* This parameter setting will be retained after you turn off the power.
- \* Check to see if you have selected the correct Program.
- \* Check the sampling rate before the procedure.

1. Press the DISP SEL key to select "SETUP" ("SETUP" flashes), then press the EXECUTE/YES key ("SETUP" lights up).  
The unit enters Setup mode.

2. Use the JOG dial to select "SLAVE" (flashing).  
The display will show the current setting value. (Initial setting is "oFF.")

3. Press the EXECUTE/YES key. ("SLAVE" lights up.)  
The current setting will be flashing.

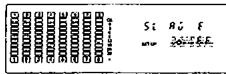

4. Use the JOG dial to select "oFF" or "oN."

5. After setting the parameter, press the EXECUTE/YES key.  
Selecting "oFF" will store the selection and return the screen to the display in Step 2.  
Selecting "oN" will store the selection, then allow you to select the external sync signal (Step 6 and later).

6. The current sync signal setting will flash on the display.

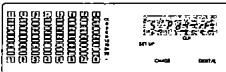

7. Turn the JOG dial to select a type of sync signal.  
Selecting "Mtc" will cause the D-90 to synchronize only with the external MTC.  
Selecting "SPd IF" will cause the D-90 to lock to MTC, then run in sync with the input S/P DIF digital signal.  
Selecting "AdAt" will cause the D-90 to lock to MTC, then run in sync with the input adat digital signal.  
Selecting "FrEE" will cause the D-90 to lock to MTC, then run in sync with its own Internal clock.

8. Press the EXECUTE/YES key again.  
The selection will be stored, and the display in Step 5 will be restored.



9. To set Slave mode to ON, press the STOP button or the EXIT/NO key.  
The display in Step 2 will be restored, and Slave mode will be set to ON.

\* Press the STOP button or the EXIT/NO key to cancel the operation or to return to the screen the shown before you pressed the EXECUTE/YES key. Pressing either key repeatedly will take you back to the previous level one step at a time until the unit quits Setup mode and the screen returns to the Time Base indication.

<Notes>

\* Do not connect or disconnect the optical cable to or from the DATA IN connector while the digital input is routed to any track. Otherwise, the D-90 may generate noise, affecting the external device.

\* The D-90 requires an external digital as well as an external MTC for its slave operation. Therefore, connect the DATA OUT terminal of the master D-90 to the DATA IN terminal of the slave unit using an optical cable. (You do not need to set any other settings on the master unit, since the master unit's DATA OUT connector always outputs digital signal.)

If you have not connected the units as described above (or in the slave unit does not receive digital signals correctly for some reason), the "DIGITAL" indicator of the slave unit will blink, indicating an error.

\* The D-90 re-chase window is fixed at "10 frame." In other words, when MTC of the master and slave drifts more than 10 frames, the D-90 will assume that chase lock is disengaged and the slave will match the position again with the master (=re-chase operation). During the re-chase operation, the sound output will be muted. If the drift is within 10 frames, the slave will admit this and continue to travel.

\* This setting will automatically disable the Vari-pitch function (the LED will be turned off).

### 18. Setting MIDI device ID ("dEvicE")

The "dEvicE" in Setup menu allows you to set the device ID for controlling the D-90 via MMC or Fostex System Exclusive Message sent from external sequencing software. (The transmit device ID is linked to this setting.) The range of the device ID is 00 through 99. (However, if the device ID number of the received message is "7F", the D-90 will follow this message regardless of the device ID setting.) The setting will be shared by all Programs, and once you change this setting, the change will apply to all Programs. This setting is maintained after you turn off the power.

\* Initial setting: 00  
\* Options ID: 00 - 99  
\* This parameter can be set for each Program.  
\* This parameter can be saved and loaded as part of the song data.  
\* This parameter setting will be retained after you turn off the power.

1. Press the DISP SEL key to select "SETUP" ("SETUP" flashes.), and press the EXECUTE/YES key. ("SETUP" lights up.)  
The unit enters Setup mode.
2. Use the JOG dial to select "dEvicE" (flashing).  
The display will show the current setting value. (Initial setting is "00.")
3. Press the EXECUTE/YES key. ("dEvicE" lights up.).  
The current setting will be flashing.

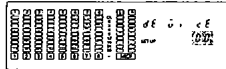

4. Turn the JOG dial to select device ID.
5. Press the EXECUTE/YES key.  
The selected device ID will be stored, and the display in Step 2 will be restored.
6. Press the STOP button or EXIT/NO key to quit Setup mode.

\* Press the STOP button or the EXIT/NO key to cancel the operation or to return to the screen shown before you pressed the EXECUTE/YES key. Pressing either key repeatedly will take you back to the previous level one step at a time until the unit quits Setup mode and the screen will return to the Time Base indication.

**17. Setting the Undo function range ("Undo")**

You can set an effective range for the Undo function in "Undo" in Setup mode. Two modes are available for the Undo function: "Edit": Non-destructive mode OFF - this mode allows for undo of auto punch in/out, copy & paste, and move & paste, and "ALL": Non-destructive mode ON - this mode allows for undo of all types of recording and editing.

**<Note>**  
 When executing direct recording in "undo ALL" mode, you need enough free disk space to accommodate real-time recording data. If you record a large amount of data in this mode, the remaining disk space may run out during your performance.  
 In this case, use the Undo function as soon as possible. (Once you perform any edit operation, you will not be able to use the Undo function.) To maximize the available disk space, cut an unnecessary part of another Programs, and move the ABS END point of each Program backward as much as possible.

- \* Initial setting: Edit
- \* Options: Edit, ALL
- \* This parameter can be set for each Program.
- \* This parameter can be saved and loaded as part of the song data.
- \* This parameter setting will be retained after you turn off the power.

1. Press the DISP SEL key to select "SETUP" ("SETUP" flashes.), and press the EXECUTE/YES key. ("SETUP" lights up.)  
 The unit enters Setup mode.
2. Use the JOG dial to select "undo" (flashing).  
 The display will show the current setting value. (Initial setting is "Edit".)
3. Press the EXECUTE/YES key. ("undo" lights up).  
 The current setting will be flashing.

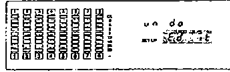

4. Use the JOG dial to select "Edit" or "ALL".  
 Turning the JOG dial counter-clockwise will select "Edit", and turning it clockwise will select "ALL".

"Edit" (Non-destructive mode off)	The Undo function is effective only on the Auto Punch In/Out, Paste, Erase, and Cut functions.
"ALL" (Non-destructive mode on)	The Undo function is effective on normal recording as well as the Auto Punch In/Out, Paste, Erase, and Cut functions.

5. Press the EXECUTE/YES key again.  
 The display in Step 1 will appear, and the setting is complete.
  6. Press the STOP button or the EXIT/NO key to quit Setup mode.
- \* Press the STOP button or the EXIT/NO key to cancel the operation or to return to the screen shown before you pressed the EXECUTE/YES key. Pressing either key repeatedly will take you back to the previous level one step at a time until the unit quits Setup mode and the screen will return to the Time Base indication.

## 20. Setting a sampling rate ("FS SET")

The D-90 supports two sampling rates: 44.1kHz and 48kHz. This parameter allows you to set the sampling rate.

The selected sampling rate will be indicated by the 48kHz LED located above the detachable controller. The LED will light up with the 48kHz setting, and the LED will be turned off with the 44.1kHz setting.

\* Initial setting: 44.1kHz  
\* Options: 44.1kHz, 48kHz  
\* This parameter can be set for each Program.  
\* This parameter can be saved and loaded as part of the song data.  
\* This parameter setting will be retained after you turn off the power.

1. Press the DISP SEL key to select "SETUP" ("SETUP" flashes.), and press the EXECUTE/YES key. ("SETUP" lights up.)  
The unit enters Setup mode.
2. Use the JOG dial to select "FS SET" (flashing).  
The current sampling rate setting will appear. (Initial setting is 44.1kHz).
3. Press the EXECUTE/YES key. ("FS SET" lights up.)  
The current sampling rate indication will flash.

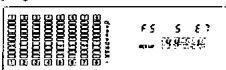

4. Turn the JOG dial to select "44.1 (kHz)" or "48(kHz)."
5. Press the EXECUTE/YES key.  
The selected sampling rate will be stored, and the display in Step 2 will be restored.
6. Press the STOP button or EXIT/NO key to quit Setup mode.

\* Press the STOP button or the EXIT/NO key to cancel the operation or to return to the screen shown before you pressed the EXECUTE/YES key. Pressing either key repeatedly will take you back to the previous level one step at a time until the unit quits Setup mode and the screen will return to the Time Base indication.

### <Notes>

\* A 48kHz sampling rate setting requires more disk space than the 44.1kHz setting. This means that the available recording time would be shorter.  
Therefore, the remaining disk space (REMAIN) after recording with a sampling rate of 48kHz would be smaller (shorter in time).

\* Do not change the sampling rate of a Program during a session unless it is very important.  
It is possible to change the sampling rate setting, but the Program will be played back at a speed different from the original recording speed, causing the data value stored in the Memory keys (time, or bar/beats/clock) to change.

( Digital Multitrack Recorder )

Date :  
Version : V1.00

Model D-90

MIDI Implementation Chart

Function.....	Transmitted	Recognized	Remarks
Basic Channel Default Changed	x x	x x	
Mode Default Message Altered	x x *****	x x x	
Note Number: True voice	x *****	x x	
Velocity Note ON Note OFF	x x	x x	
After Touch Key's Channel's	x x	x x	
Pitch Bend	x	x	
Control Change	x	x	
Program Change: True #	x *****	x x	
System Exclusive	○ (rem. 1)	○ (rem. 2)	
Common : Quarter frame : Song Position : Song Select : Tune	○ ○ x x	○ x x x	
System : Clock Real Time : Commands	○ ○ (rem. 3)	x x	
Aux. : Local ON/OFF Mes- : All Notes OFF sage : Active Sense : Reset	x x x x	x x x x	
Notes	rem. 1: MMC (Device ID=00 ~ 99, 127), MTC, Identity reply, FOSTEX Exclusive rem. 2: MMC (Device ID=00 ~ 99, 127), MTC, Inquiry, FOSTEX Exclusive rem. 3: START, STOP, CONTINUE		

Mode 1: OMNI ON, POLY  
Mode 3: OMNI OFF, POLY

Mode 2: OMNI ON, MONO  
Mode 4: OMNI OFF, MONO

○ : Yes  
x : No

### MMC Command List

● Command List	Movement (Recorder)
01 : STOP	STOP
02 : PLAY	PLAY
03 : DEFERRED PLAY	DEFERRED PLAY
04 : FAST FORWARD	F FWD
05 : REWIND	REWIND
06 : RECORD STROBE	REC
07 : RECORD EXIT	PUNCH OUT
09 : PAUSE	STOP
40 : WRITE	Refer to MMC Response/Information Field List
41 : MASKED WRITE	Refer to MMC Response/Information Field List
42 : READ	Refer to MMC Response/Information Field List
44 : LOCATE	LOCATE to Setting Data
47 : SHUTTLE	CUE/REVIEW (± 1~60 times)
4C : MOVE	Refer to MMC Response/Information Field List
4D : ADD	Refer to MMC Response/Information Field List
4E : SUBTRACT	Refer to MMC Response/Information Field List

● MMC Response/Information Field List	Command
01 : SELECTED TIME CODE	READ/WRITE/MOVE/ADD/SUBTRACT
03 : REQUESTED OFFSET	READ/WRITE
04 : ACTUAL OFFSET	READ
08 : GP0	READ/WRITE/MOVE/ADD/SUBTRACT
09 : GP1	READ/WRITE/MOVE/ADD/SUBTRACT
0A : GP2	READ/WRITE/MOVE/ADD/SUBTRACT
0B : GP3	READ/WRITE/MOVE/ADD/SUBTRACT
0C : GP4	READ/WRITE/MOVE/ADD/SUBTRACT
0D : GP5	READ/WRITE/MOVE/ADD/SUBTRACT
0E : GP6	READ/WRITE/MOVE/ADD/SUBTRACT
0F : GP7	READ/WRITE/MOVE/ADD/SUBTRACT
48 : MOTION CONTROL TALLY	READ
4C : RECORD MODE	READ/WRITE
4E : TRACK RECORD STATUS	READ
4F : TRACK RECORD READY	READ/WRITE/MASKED WRITE
51 : RECORD MONITOR	READ/WRITE

### Inquiry Message List

IDENTITY REQUEST : F0, 7E, <channel>, 06, 01, F7
IDENTITY REPLY : F0, 7E, <channel>, 06, 02, 51, 01, 00, 0B, 00, 01, 00, 7F, 7F, F7
51 : Fostex ID
01, 00 : Device family code
0B, 00 : Device family number D-90
01, 00, 7F, 7F : Software version

**Fostex MIDI System Exclusive Message Format for D-90**

**<Note>**

Following protocol is effective only in equipment which will reply by -  
 Identity Reply=F0 7E<channel>06 02 51 01 00 0B 00 01 00 7F 7F (D-90)  
 against the Inquiry Message=F0 7E<channel>06 01.

**Fostex System Exclusive Message**

General Structure=F0 51<device id><sub id 1><data>F7

\* Numbers are all expressed in hexadecimal units.

Table: <sub id 1> <data>

Command or Model Set Controller to D-90	Acknowledge or Status D-90 to Controller
Loop on/off 12 22 (<on/off>)	
Post locate 12 28 (<post locate mode>)	
Auto rec 12 2D (<on/off>)	32 2D (<edit message>)
Lock enable 12 41 (<lock enable>)	
Lock mode 12 42 (<lock mode>)	
Copy clip 12 45 (<count><mmc track>)	32 45 (<edit message>)
Copy paste 12 46 (<count=01><repeat count>)	32 46 (<edit message>)
or 12 46 (<count><repeat count><mmc track>)	
Erase 12 47 (<count><mmc track>)	32 47 (<edit message>)
Cut 12 48	32 48 (<edit message>)
Clipboard play 12 49	32 49 (<edit message><mmc track>)
Undo 12 4A	32 4A (<edit message>)
Redo 12 4B	32 4B (<edit message>)
Nondes. mode 12 4C (<on/off>) * Refer to Note 1.	
Move clip 12 4D (<count><mmc track>)	32 4D (<edit message>)
Move paste 12 4E (<count=01><repeat count>)	32 4E (<edit message>)
or 12 4E (<count><repeat count><mmc track>)	
Digital in ch. 13 41 (<channel><channels>)	
Digital out ch. 13 42 (<channel><channels>) * Refer to Note 2.	
Program change 13 43 (<program>)	
Click on/off 13 44 (<on/off>)	
Resolution on/off 13 46 (<on/off>)	
Midi Sync out 13 47 (<midi sync>)	
MTC offset mode 13 48 (<MTC offset mode>)	
Vari pitch 13 49 (<count=3><on/off><vari pitch>)	
or 13 49 (<count=1><on/off>)	
Signature set 14 01 (<signature map>)	34 00 (<edit message>)
Tempo set 14 02 (<tempo set map>)	34 00 (<edit message>)
Tempo map all erase 14 03	34 00 (<edit message>)
Preroll time set 14 04 (<mmc time>)	
Frame rate set 14 06 (<frame rate>)	
Fs rate set 14 07 (<fs rate>)	
Time base set 14 08 (<time base>)	

**Status Request**

Status request command Controller to D-90	Status reply D-90 to controller
Loop op. status 22 21	32 21 (<Loop op. mode = 12>)
Loop status 22 22	32 22 (<on/off>)
Post locate status 22 28	32 28 (<post locate status>)
Auto rec status 22 2D	32 2D (<edit message>)
Lock status 22 41	32 41 (<lock status>)
Lock mode status 22 42	32 42 (<lock mode>)
Copy clip status 22 45	32 45 (<edit message=01 or =14>)
Copy paste status 22 46	32 46 (<edit message=02><mmc time>)
	or 32 46 (<edit message=00>)
Erase status 22 47	32 47 (<edit message=02><mmc time>)
	or 32 47 (<edit message=00>)
Nondes. mode 22 4C	32 4C (<on/off>)
Move clip status 22 4D	32 4D (<edit message=01 or =14>)
Move paste status 22 4E	32 4E (<edit message=02><mmc time>)
	or 32 4E (<edit message=00>)
Digital in ch. st. 23 41	33 41 (<channel><channel>)
Digital out ch. st. 23 42	33 42 (<channel><channel>)
Program status 23 43	33 43 (<program>)
Click status 23 44	33 44 (<on/off>)
Level status 23 45	33 45 (<count=08><level data>)
resolution status 23 46	33 46 (<on/off>)
midl sync out status 23 47	33 47 (<midl sync>)
MTC offset mode status 23 48	33 48 (<MTC offset mode>)
vari pitch status 23 49	33 49 (<count=3><on/off><vari pitch>)
signature map 24 01<event numbers>	34 01 (<signature map>)
tempo set map 24 02<event numbers>	34 02 (<tempo set map>)
preroll time 24 04	34 04 (<mmc time>)
remain time 24 05	34 05 (<mmc time>)
frame rate status 24 06	34 06 (<frame rate>)
fs rate status 24 07	34 07 (<fs rate>)
time base status 24 08	34 08 (<time base>)

**<Note 1>**

**Nondes.mode:**

Abbreviation for "non destructive recording mode". When this mode is ON, not only "takes" made by various sound editing or AUTO PUNCH IN/OUT but "takes" recorded by simultaneous pressing of the PLAY and RECORD buttons (direct recording) will always be possible to UNDO (However, free disc memory space equivalent to the recording length will always be required). This is the same function of switching between "undo:ALL (Nondes.mode:on) ↔ Edit (Nondes.mode:off)" in the setup menu on the main unit.

**<Note 2>**

There is a limitation on specifying the <channel><channel> setting. For details, refer to "Explanation on Command/Mode Set" mentioned in later pages.



**<Allocation of GP0-GP7>**

Edit point memory of this equipment is allotted to the response/information field of 08-0F (GP0-GP7) as shown below.

GP7 however, will be used as the work memory for small adjusting of the registered figure (Refer to Examples 4 and 5).

**<Response/Information Field>**

08 GP0 : locate memory	09 GP1 : clipboard in memory
0A GP2 : clipboard out memory	0B GP3 : start memory
0C GP4 : auto punch in memory	0D GP5 : auto punch out memory
0E GP6 : end memory	0F GP7 : reserved

[Example 1] <mmc time> is registered in the start memory (using the write command).  
FO 7F <device ID> 06 <write = 4D> <count> <GP3 = 0B> <mmc time> F7

[Example 2] Locate memory is recalled (using the read command).  
FO 7F <device ID> 06 <read = 42> <count> <GP3 = 0B> <mmc time> F7

[Example 3] On-the-fly registering in the punch in memory (using the move command).  
FO 7F <device ID> 06 <move = 4C> <count> <destination = 0C (GP4)> <source = selected time code = 01> F7

[Example 4] When + 1 frame is to be set in the punch in memory (using the add command).

\* Time figure to be added is pre-registered in GP7 (Set 00h 00m 00s 01f in GP7).  
FO 7F <device ID> 06 <add = 4D> <count> <destination = 0C (GP4)> <source #1 = 01 (GP4)> <source #2 = 0F (GP7)> F7

[Example 5] When -1 frame is to be set in the punch in memory (using the subtract command).

\* Time figure to be subtracted is pre-registered in GP7 (Set 00h 00m 00s 01f in GP7).  
FO 7F <device ID> 06 <subtract = 4E> <count> <destination = 0C (GP4)> <source#1 = 0C (GP4)> <source #2 = 0F (GP7)>F7

## Data Type

<loop op. mode>	12=stop Indicates the next operating mode following locating to the start point (GP3) upon arriving at the end point (GP6) by the play mode. In D-80/DMT-8, 12=stop only is effective.
<post locate mode>	12=stop 15=play Specifies operating mode in which D-80/DMT-8 should enter upon completing the locate operation. Corresponds to the setting of AUTO PLAY ON ("15")/OFF ("12") on the main unit.
<count>	01~7F Specifies succeeding data byte numbers.
<mmc track>	Complies to the MMC (MIDI MACHINE CONTROL) standard track bit map. In D-80/DMT-8, you always need to specify two byte combinations of "00" and "F1."
<edit message>	00 = no message 01 = completed (completion flag) 02 = active (execution flag) 02<mmc time> = Indicates unprocessed time by active (execution flag) and <mmc time>. 02<count><mmc track> = Indicates source track by active (execution flag) and <mmc track>. Used for clipboard play. 03 = cancel (execution stop) 05 = indicates rehearsal (rehearsal mode of auto rec). Possible of undo. 06 = indicates take (take mode of auto rec). Possible of undo. 10 = over value error 10 <mmc time> = Capacity shortage time is indicated by over value error (error by capacity shortage) and <mmc time>. In copy paste, it indicates capacity shortage time required for a minimum one time paste. 11 = indicates in point error (incorrect in point). 12 = indicates out point error (incorrect out point). 14 = indicates void data (data necessary for paste does not exist). 18 = indicates track select error (track necessary to execute copy/move or erase/cut is not correctly setup). 19<repeat count> = Indicates repeat number error and repeat numbers executable by <repeat count>. 1A = indicates disable rec (record disable mode). 25 = indicates can't undo rehearsal (rehearsal mode of auto rec). Impossible to undo. 26 = indicates can't undo take (take mode of auto rec). Impossible to undo. 71 = indicates on. 72 = indicates off.
<mmc time>	hr mm ss fr. [1/2s] complies to the MMC standard time code.
<on/off>	70 = default 71 = on 72 = off
<repeat count>	01~7F Especially when executing commands such as paste, the number of pasting times to be continuously repeated following the auto punch in point is specified.
<channel>	00~08, 7F Select recorder tracks 1~8. "00" in particular, is not specified (default setting). "7F" indicates input/output of Adat optical. For details, refer to explanation on setting the Command/Mode.
<lock enable>	00 = lock disable, chase disable 01 = lock enable, chase enable Corresponds to SLAVE ON ("01")/OFF ("00") in the main unit.
<lock status>	00 = lock disable, chase disable 01 = lock enable (unlocked), chase enable (unlocked) 11 = lock enable (locked), chase enable (locked)
<program>	01~7F Indicates program numbers (P1~P9) on the main unit. However, D-90 can specify only 01 (corresponds to P1)~09 (corresponds to P9).
<lock mode>	40 = Free 42 = MTC 45 = S/P DIF 46 = Adat Indicates the slave mode when this equipment is set to slave ON.

<signature map>	<p>bar2, bar1, bar0, sign, slgd  bar2: The 100th digit of the bar figure is expressed in BCD.  bar1: The 10th digit of the bar figure is expressed in BCD.  bar0: The 1 digit of the bar figure is expressed in BCD.  sign: Numerator of the signature to be set is expressed in BCD.  sgld: Denominator of the signature to be set is expressed in BCD.  When specified as sign=00 and slgd=00, signature data of that bar position will be deleted. Also, bar2=bar1=bar0=sign=sgld=00 indicates "no corresponding data" (such as when a figure specified by &lt;event number&gt; do not exist at receiving the signature map request).</p>
<tempo set map>	<p>bar2, bar1, bar0, beat, tmp2, tmp1, tmp0  bar2: The 100th digit of the bar figure is expressed in BCD.  bar1: The 10th digit of the bar figure is expressed in BCD.  bar0: The 1 digit of the bar figure is expressed in BCD.  beat: The beat figure is expressed in BCD.  tmp2: Numerator of the tempo to be set is expressed in BCD.  tmp1: Denominator of the tempo to be set is expressed in BCD.  tmp0: The 1 digit of the tempo is expressed in BCD.  When specified as tmp2=tmp1=tmp0=00, tempo data of that bar and meter position will be deleted. Also, bar2=bar1=bar0=sign=sgld=00 indicates "no corresponding data" (such as when a figure specified by &lt;event number&gt; do not exist at receiving the signature map request).</p>
<event number>	<p>When one data registered by &lt;signature map&gt; and &lt;tempo set map&gt; is declared as one event, the number of events from head of the tune (the umpteenth event counted from head of the tune) must be specified. &lt;event number="00"&gt; is the first event.</p>
<midi sync>	<p>00: OFF  01: MIDI CLOCK  02: MTC  This corresponds to "MIDI SYNC OUT" of the SETUP menu.</p>
<vari pitch>	<p>Will be composed of two bytes (Q, P).  Q: 00000000 (binary) -&gt; &lt;vari data&gt; = "qqqqqqpppppp" A 14 bit data of X0.1  P: 00000000 (binary)  Vari-pitch must be specified, at +0.1% when MSB (q)=0 (Example: 000000000001), and at -0.1% when MSB (q)=1 (Example: 111111111111).</p>
<frame rate>	<p>00: 30nd  03: 25  04: 24  05: 30df  Corresponds to selecting "FRAME" of the SETUP menu.</p>
<fs rate>	<p>00: 48kHz  01: 44.1kHz  Corresponds to selecting "FS SET" of the SETUP menu.</p>
<MTC offset mode>	<p>00: ABS  01: signature  Corresponds to selecting "MTC OFFSET MODE" of the SETUP menu.</p>
<time base>	<p>00: ABS  01: BAR BEAT  02: MTC  Corresponds to selecting "TIME BASE SEL" of the SETUP menu.</p>
<level data>	<p>t1, t2 ..... tn  n: Indicates the track number.  tn: Indicates absolute 8 bits of the Audio 16 bit data (Range: 00 - 7F).</p>

**Explanation on the Command/Mode Set**

**12 22 (<on/off>): loop on/off command**

The command for setting the "loop mode on/off" (=ON/OFF of AUTO RTN) of D-90. Default figure of the loop operation mode is "12=stop" and this cannot be changed.

**12 28 (<post locate mode>): post locate command**

The command for setting the "post locate mode" (=ON/OFF of AUTO PLAY) of D-90. It will stop after locating if "post locate mode=12." It will enter play after locating if "post locate mode=15."

**12 2D (<on/off>): auto rec command**

The command for setting "auto rec mode on/off" (=ON/OFF of AUTO PUNCH) of D-90. Upon receiving this command, D-90 will immediately reply the operating condition by sending "32 2D (<edit message>)."

**12 41 (<lock enable>): lock enable command**

The command for setting "slave mode on/off" (setup menu) of D-90.

**12 42 (<lock mode>): lock mode command**

The command for setup of the slave mode (setup menu) when this equipment is set to "slave mode on."

**12 45 (<count><mmc track>): copy clip command**

When this command is received, D-90 will copy (multiple number of tracks can be copied simultaneously) the sound data, as data for copy paste, from the pre-registered clipboard-in point to the clipboard-out point in the track specified by <mmc track>.

With completion of copying the data into the clipboard, D-90 will immediately reply with "32 45 (<edit message=01 (completed)>)."

If copy cannot be executed due to improper figures of the pre-registered clipboard in/clipboard out points or incorrect track section, the corresponding <edit message> will be returned.

**12 46 (<count=01><repeat count>): copy paste command**

**12 46 (<count><repeat count><mmc track>): copy paste command**

When this command is received, D-90 will paste the sound data which has been copied into the clipboard, on the same track from the pre-registered auto punch in point as the starting point for the number of time specified by <repeat count>.

However, if the sound data length in the clipboard is less than 10ms, the specifying the <repeat count> will be limited to "01."

Also, by specifying <mmc track>, paste can be executed on other tracks in mono (in one track units) or stereo units (in combinations of tracks 1 & 2, 3 & 4, 5 & 6, 7 & 8).

Since time corresponding to length of the copy clipped sound data is required to complete the copy paste operation, D-90 immediately replies with "32 46 (<edit message=02 (active)>)" after receiving the command.

Successively upon completing the paste operation, "32 46 (<edit message=01 (completed)>)" is transmitted.

If paste cannot be executed due to improper figures of the pre-registered auto punch in point, insufficient disc capacity, no sound data in the clipboard, etc., the corresponding <editmessage> will be replied.

**12 47 (<count><mmc track>): erase command**

When this command is received, D-90 will erase the data (writes in "0" data) in the section from the pre-registered auto punch in point through auto punch out point in the track specified by <mmc track>. Since time corresponding to length of the erase section is required to complete the erase operation, D-90 will immediately reply by "32 47 (<edit

message=02 (active)>)" after receiving the command.

After the completion of erase operation, "32 47 (<edit message=01 (completed)>)" will be transmitted.

If erase cannot be executed due to improper figures of the pre-registered auto punch in point/auto punch out point, incorrect track section, etc., the corresponding <edit message> will be replied.

**12 48: cut**

When this command is received, D-90 will cut whole the section following the pre-recorded auto punch in point under the assumption that whole the tracks are nonrecorded section. With completion of the cut operation, this equipment will immediately reply with "32 48 (<edit message=01 (completed)>)." If cut is unexecutable due to improper figure of the pre-registered auto punch in point, the corresponding <edit message> will be replied.

**12 49: clipboard play**

When this command is received, D-90 will playback once from the head of the sound data copied in the clipboard by the copy clip and move clip commands. Immediately after receiving the command, D-90 will reply with "32 49 (<edit message=02 (active)><count><mmc track>)." The sound data track number is indicated by (mmc track).

Upon completion of playback, "32 49 (<edit message=01 (completed) is sent and clipboard play is ended. If there is no sound data in the clipboard, "32 49 (<edit message=14 (void data)>)" will be sent and clipboard play operation will be interrupted.

**12 4A: undo**

Upon receiving this command, D-90 will revert to the condition prior to editing copy paste, erase, move paste, cut, redo operation. With completion of undo operation, D-90 will reply with "32 4A (<edit message=01 (completed)>)." If D-90 is not possible to undo, "32 4A (<edit message=00 (no message)>)" will be replied.

**12 4B: redo**

When this command is received, D-90 will return to the condition prior to undo operation. With completion of redo operation, D-90 will reply with "32 4B (<edit message=01 (completed)>)." If D-90 is not possible to redo, "32 4B (<edit message=00 (no message)>)" will be replied.

**12 4C: (<on/off>) : nondes. mode**

The command for setting on/off of non destructive mode on D-90.

If <on/off> is set to "on," recording mode of D-90 will enter the non destructive mode, and if "off," in the destructive mode.

**※ Nondes. mode:**

Abbreviation for "non destructive recording mode". When this mode is ON, not only "takes" made by various sound editing or AUTO PUNCH IN/OUT but "takes" recorded by simultaneous pressing of the PLAY and RECORD buttons (direct recording) will always be possible to UNDO (However, free disc memory space equivalent to the recording length will always be required). This is the same function of switching between "undo: ALL (Nondes.mode:on) → Edit (Nondes.mode:off)" in the setup menu on the main unit.

**12 4D (<count><mmc track>): move clip command**

When this command is received, D-90 will copy (multiple tracks can be copied simultaneously) the sound data from the pre-registered clipboard in point to the clipboard out point, as data for move paste operation.

With completion copying the data into the clipboard, D-90 will immediately reply with "32 4D (<edit message=01 (completed)>)." If copy cannot be executed by the reason of pre-registered improper clipboard in/clipboard

out point figures or incorrect track section, etc., the corresponding <edit message> will be replied.

**12 4E (<count=01><repeat count>): move paste command**

**12 4E (<count><repeat count><mmc track>): move paste command**

When this command is received, D-90 will paste the sound data which have been move clipped in the clipboard, for the number of times specified by <repeat count> on the same track from the pre-registered auto punch in point as the starting point. At the same time, the move clipped original sound data will be erased (data "0" is written in). However, when sound data length in the clipboard is less than 10ms, specifying the <repeat count> will be limited to "01."

Also, by specifying the <mmc track>, paste operation can be executed on other tracks in mono (one track unit) or stereo units (tracks 1 & 2, 3 & 4, 5 & 6, 7 & 8).

Since time corresponding to length of the move clipped sound data is required to complete the move paste operation, D-90 will immediately reply with "32 4E (<edit message=02 (active)>)" after receiving the command.

Following completion of the move paste operation, "32 4E (<edit message = 01 (completed)>)" will be sent.

If paste cannot be executed due to improper figures of the previously registered auto punch in point, insufficient disc capacity, no sound data is in the clipboard, etc., the corresponding <edit message> will be replied.

**13 41 (<channel><channel>): digital in ch.select command**

The command assigning the digital audio signal (S/P DIF) input from the D-90 DATA IN connector to the track specified by <channel>. The digital audio signal L channel assignment point is specified by the first <channel> and the R channel assignment point by the second <channel> in the command. If the same figure is specified for both <channels>, L channel will have priority and R channel will be "-" (invalid).

When <channel>=00, it will be set "without assign." Also, if the initially shown <channel> is set to 7F, the digital audio signal will be changed to "Adat."

In such a case, "00" must always be specified for the second <channel>.

When thus specified, digital signals from the Adat optical input will be automatically assigned as Adat ch1 -> track 1 .... Adat ch8 -> track 8 (The relationship between Adat channel and track is fixed and cannot be changed).

**13 42 (<channel><channel>): digital out ch.select command**

This command selects the source track for the digital audio signal (S/P DIF) output from the D-90 DATA OUT connector.

Normally, the track specified by the first <channel> will be the digital audio signal L channel data, and the track specified by the second <channel> will be the digital audio signal R channel data. In this equipment, the five types - (<01><02>), (<03><04>), (<05><06>), (<07><08>) and (<00><00>) - can only be set up.

When <00> <00> is specified, Adat optical signals will be output from DATA OUT when this equipment is in the default state.

Adat optical can also be selected by setting "7F" in the first shown <channel> and "00" in the second one. In this case, they will be automatically assigned as Track 1 -> Adat ch1 .....Track 8 -> Adat ch8 (This relationship cannot be changed).

**13 43(<program>):program change command**

The command for PROGRAM CHANGE of D-90. The present program number can be changed to the figure indicated by <program>.

**13 44 (<on/off>): click on/off command**

The command for setting the metronome on/off of D-90. When ON is set, the metronome signal will be fed to the track 8 output (analog output only) of D-90.

**13 46 (<on/off>): Resolution ON/OFF command**

The command for ON/OFF of the resolution function of this equipments' current program.

**13 47 (<midl sync>): Midi Sync Out command**

The setup command for MIDI Sync Out mode of this equipments' current program.

**13 48 (<MTC offset mode>): MTC offset mode command**

The setup command for MTC offset mode of this equipments' current program.

**13 49 (<count=3> <on/off> <vari data>): Vari pitch command**

**13 49 (<count=1> <on/off>): Vari pitch command**

The command for setting this equipments' vari pitch ON/OFF and pitch data. Control of ON/OFF only is possible at <count=1> and both ON/OFF and pitch data can be set at <count=3>.

**14 01 (<signature map>): Signature set command**

The command for setting the meter of this equipment. If a new data is registered at the bar position where a data exists, the former data will be written over. When this command is received, this equipment will reply with "34 00 (<edit message>)." Upon completing the registration, <edit message> will reply with "01 (completed)," or with "10 (over value error)" if registration is attempted at a non-existing point or an erroneous figure is used.

**14 02 (<tempo set map>): Tempo set command**

The command for tempo set of this equipment. If a new data is registered in a bar/meter where data already exists, the former data will be written over. When this command is received, this equipment will reply with "34 00 (<edit message>)." Upon completing the registration, <edit message> will reply with "01 (completed)," or with "10 (over value error)" if registration is attempted at a non-existing point or an erroneous figure is used.

**14 03 : Tempo map all erase command**

When this command is received, this equipment will erase all meter and tempo data in the current program and thus return it to the default state (meter=4/4, tempo: =120). Also, when this command is received, this equipment will reply with "34 00 (<edit message>)." Upon completing the registration, <edit message> will reply with "01 (completed)," or with "10 (over value error)" if registration is attempted at a non-existing point or an erroneous figure is used.

**14 04 (<mmc time>): Preroll time set command**

The command for setting the current program preroll time at the figure indicated by <mmc time>.

**14 06 (<frame rate>): Frame rate set command**

The command for setting the current program frame rate at the figure indicated by <frame rate>.

**14 07 (<fs rate>): Fs rate set command**

The command for setting the current program fs (sampling frequency) at the figure indicated by <fs rate>.

**14 08 (<time base>): Time base set command**

The command for setting the current program time base of this equipment to that indicated by <time base>.

### The Status Request Command

**22 21: loop operation status request**

The command inquiring the loop operation mode setup status.  
D-90 will reply with "32 21 (<loop op.mode=12>)."

**22 22: loop on/off status request**

The command inquiring the loop on/off (ON/OFF of AUTO RETURN) setup status.  
D-90 will reply with "32 22 (<on/off>)."

**22 28: post locate status request**

The command inquiring the post locate mode (ON/OFF of AUTO PLAY) setup status.  
D-90 will reply with "32 28 (<post locate mode>)."

**22 2D: auto rec status request**

The command inquiring the auto rec mode setup status and this is replied by "32 2D (<edit message>)." Reply from D-90 against this status request will be either one of the following:

<edit message>   =05: Possible to undo rehearsal mode.  
                  =06: Possible to undo take mode.  
                  =25: Impossible to undo rehearsal mode.  
                  =26: Impossible to undo take mode.  
                  =72: off

**22 41: lock status request**

The command inquiring the slave on/off setup status and the lock status.  
D-90 will reply with "32 41 (<lock status>)."

**22 42: lock mode status request**

The command for inquiring the lock mode setup status and this is replied with "32 42 (<loc1 mode>)."

**22 45: copy clip status request**

The command inquiring the clipboard condition. If there is a copy paste data in the clipboard, D-90 will reply with "32 45 (<edit message=01>)." If data in the clipboard is for move paste or there is no valid data in it, it will reply with "32 45 (<edit message=14 (void data)>)."

**22 46: copy paste status request**

The command inquiring execution status of copy paste editing.  
When this command is received, D-90 will reply with either "32 46 (<edit message=02> <mmc time>)" or "32 46 (<edit message=00>)." <mmc time> indicates unprocessed time until completion.

**22 47: erase status request**

The command inquiring execution status of erase.  
When this command is received, D-90 will reply by either "32 47 (<edit message=02> <mmc time>)" or "32 47 (<edit message=00>)." <mmc time> indicates unprocessed time until completion.

**22 4C: nondes.mode request**

The command inquiring the non destructive mode status.  
When this command is received, D-90 will reply with "32 4C (<on/off>)."



※ **Nondes.mode:**

Abbreviation for "non destructive recording mode". When this mode is ON, not only "takes" made by various sound editing or AUTO PUNCH IN/OUT but "takes" recorded by simultaneous pressing of the PLAY and RECORD buttons (direct recording) will always be possible to UNDO (However, free disc memory space equivalent to the recording length will always be required). This is same function of switching between "undo: ALL (Nondes.mode:on) ←→ Edit (Nondes.mode:off)" in the setup menu on the main unit.

**22 4D: move clip status request**

The command inquiring the clipboard status. If there is a move paste data on the clipboard, D-90 will reply with "32 4D (<edit message=01>)." If data in the clipboard is for copy paste or there is no valid data on it, "32 4D (<edit message=14 (void data)>)" will be replied.

**22 4E: move paste status request**

The command inquiring the move paste execution status.

When this command is received, D-90 will reply with "32 4E (<edit message=02><mmc time>)" or "32 4E (<edit message=00>)." <mmc time> Indicates unprocessed time until completion.

**23 41: digital in channel status request**

The command inquiring the digital in channel setup status.

When this command is received, D-90 will reply with "33 41(<channel><channel>)."

**23 42: digital out channel status request**

The inquiring the digital out channel setup status.

When this command is received, D-90 will reply with "33 42(<channel><channel>)."

**23 43: program status request**

The command inquiring the presently operating program number.

When this command is received, D-90 will reply with "33 43 (<program>)."

**23 44: click on/off status request**

The command inquiring the metronome on/off status of D-90.

When this command is received, D-90 will reply with "33 44 (<on/off>)."

**23 45: level status request**

The command inquiring the present output level data of the 1-8 tracks. In D-90 as the level data is updated about every 40msec, inquiry in 40msec, units is effective.

When this command is received, D-90 will reply with "33 45 (<count=08><level data>)."

**23 46: resolution status request**

The command for inquiring the resolution on/off setup status.

When this command is received, this equipment replies with "33 46 <on/off>."

**23 47: resolution status request**

The command for inquiring on status of the midi sync out setup condition.

When this command is received, this equipment replies with "33 47 <midi sync>."

**23 48: MTC offset mode status request**

The command for inquiring the MTC offset mode setup status. When this command is received, this equipment replies with "33 48 <MTC offset mode>."

**23 49: vari pitch status request**

The command for inquiring status of vari pitch on/off and vari pitch data. When this command is received, this equipment replies with "33 49 (<count=3> <on/off> <vari data>)."

**24 01 (<event number>): signature map request**

The command for inquiring the meter setup. Order number counting from the leading tune must be specified in the event number (The first event is expressed as "event number=00." When this command is received, this equipment replies with "34 01 (<signature map>)."

**24 02 (<event number>): Tempo set map request**

The command for inquiring tempo data. Order number from the leading tune must be specified in the event number (The first event is expressed as "event number=00." When this command is received, this equipment replies with "34 02 (<tempo set map>)."

**24 04: preroll time status request**

The command for inquiring the preroll time setup status.  
When this command is received, this equipment replies with "34 04 (<mmc time>)."

**24 05: remain time request**

The command for inquiring the disk remaining time which is recordable.  
When this command is received, this equipment replies with "34 05 (<mmc time>)."

**24 06: frame rate status request**

The command for inquiring the frame rate setup status.  
When this command is received, this equipment replies with "34 06 (<frame rate>)."

**24 07: fs rate status request**

The command for inquiring the fs (sampling frequency) setup status.  
When this command is received, this equipment replies with "34 07 (<fs rate>)."

**24 08: time base status**

The command for inquiring the setup status of the time base shown in the display.  
When this command is received, this equipment replies with "34 08 (<time base>)."

### Explanation on the Status Reply

**32 21 (<loop op.mode>): loop operation mode status reply**

This is the reply against the "22 21" loop operation status request command.  
<loop op.mode=12> is the only status data of D-90 and any other setting is not permissible.

**32 22 (<on/off>): loop on/off status reply**

This is the reply against "22 22" loop on/off status request.

**32 28 (<post locate mode>): post locate mode status reply**

This is the reply against "22 28" post locate status request. <post locate mode=12 or 15> is the only status data of D-90 and any other setting is not permissible.

**32 2D (<edit message>): auto rec status reply**

This is the reply against the "12 2D" auto rec command or the "22 2D" auto rec status request.

**32 41 (<lock status>): lock status reply**

This is the reply against the "22 41" lock status request.

**32 42 (<lock mode>): lock mode status reply**

This is the reply against the "22 42" lock mode status request.

**32 45 (<edit message>): copy clip status reply**

This is the reply against the "12 45" copy clip command or the "22 45" copy clip status request.

**32 46 (<edit message>): copy paste status reply**

**32 46 (<edit message><mmc time>): copy paste status reply**

This is the reply against the "12 46" copy paste command or the "22 46" copy paste status request. <mmc time> indicates the unprocessed time until completion of copy paste editing.

**32 47 (<edit message>): erase status reply**

**32 47 (<edit message><mmc time>): erase status reply**

This is the reply against "12 47" erase command or "22 47" erase status request.

**32 48 (<edit message>): cut status reply**

This is the reply against the "12 48" cut command.

**32 49 (<edit message><count><mmc track>): clipboard play status reply**

This is the reply against the "12 49" clipboard play command. If there is no sound data in the clipboard, "32 49"(<edit message=14 (void data)>) will be replied. <mmc track> indicates the sound data track number.

**32 4A (<edit message>): undo status reply**

This is the reply against the "12 4A" undo command. Either <edit message=01 (completed) or <edit message=00 (no message)> will be replied.

**32 4B (<edit message>): redo status reply**

This is the reply against the "12 4B" redo command. Either <edit message=01 (completed) or <edit message=00 (no message)> will be replied.

**32 4C (<on/off>): nondes.mode status reply**

This is the reply against the "22 4C" nondes.mode status request.

**32 4D (<edit message>): move clip status reply**

This is the reply against the "12 4D" move clip command or "22 4D" move clip status request.

**32 4E (<edit message>): move paste status reply**

**32 4E (<edit message><mmc time>): move paste status reply**

The reply against the "12 4E" move paste command or the "22 4E" move paste status request. <mmc time> indicates the unprocessed time until completion of move paste editing.

**33 41 (<channel> <channel>): digital in channel status reply**

**33 41 (<channel> <count> <mmc track>)**

This is the reply against the "23 41" digital in ch. st. request.

The first <channel> indicates the track number assigned to the L channel of the digital audio signal (S/P DIF) from the DATA IN connector, and the second <channel> the track number assigned to the R channel. If digital in is set to "Adat," the reply for the first <channel> will be 7F and then <count> <mmc track>, in this order.

In the <mmc track>, the track bit map which is the Adat input, is expressed by "1" (In this equipment, the reply will all be "1" or "0", or in other words, all tracks will be collectively converted to Adat inputs or analog inputs).

**33 42 (<channel> <channel>): digital out channel status reply**

This is the reply against the "23 42" digital out ch. st. request.

The first <channel> indicates the track number assigned to the L channel output of the digital audio signal (S/P DIF) from the DATA OUT connector, and the second <channel> the track number as signed to the R channel output. If digital out is set to "Adat," the reply for the first <channel> will be 7F and that for the second <channel> will be 00.

**33 43 (<program>): program status reply**

This is the reply against the "23 43" program status request.

<program> indicates the presently operating program number.

**33 44 (<on/off>): click status reply**

This is the reply against the "23 44" click status request.

It indicates the on/off setting of the metronome function.

**33 45 (<count=08><level data>): level status reply**

This is the reply against the "23 45" level status request and it indicates the present track 1-8 output level data.

In D-90, as level data is updated 40msec., it will be effective if Inquiry is made in 40msec. units.

**33 46 (<on/off>): resolution status reply**

This is the reply against "23 46" resolution status request.

**33 47 (<midi sync>): midi sync out status reply**

This is the reply against "23 47" midi sync out status request.

**33 48 (<MTC offset mode>): MTC offset mode status reply**

This is the reply against "23 48" MTC offset mode status request.

**33 49 (<count=3> <on/off> <vari data>): vari pitch status reply**

This is the reply against "23 49" vari pitch status request and is indicating the vari pitch function on/off and the present vari pitch setup figure.

**34 01 (<signature map>): signature map status reply**

This is the reply against "24 01" (<event number>) signature map request.

The signature map of the event indicated by the <event number> is replied.

If there is no event specified (Example: Such as when <event number=5> is requested even though there is only 5 meters registered), it will be replied with all figures at 00 of the <signature map>.

**34 02 (<tempo set map>): tempo set map status reply**

The reply against "24 02" (<event number>) tempo set map request.

Tempo set map of the event indicated by the <event number> is replied.

If there is no event specified (Example: Such as when <event number=20> is requested although only 10 is setup for tempo), it will be replied with all figures at 00 of the <signature map>.

**34 04 (<mmc time>): preroll set map status reply**

This is the reply against "34 04" preroll time status request and this is replied with the presently set preroll time.

**34 05 (<mmc time>): remain time reply**

This is the reply against "24 05" remain time request, and is replied with the recordable disc remaining time.

*D-90 Owner's Manual (MMC/FEX List/Maintenance/Specifications)*

**34 06 (<frame rate>): frame rate status reply**

*This is the reply against "24 06" frame rate status request, and is replied with the presently set frame rate.*

**34 07 (<fs rate>): fs rate status reply**

*This is the reply against "24 07" fs rate status request, and is replied with the presently set fs (sampling frequency).*

**34 08 (<time base>): time base status reply**

*This is the reply against "24 08" time base status request, and is replied with the presently set time base (in the display).*

## Maintenance

### Cleaning the exterior

\* For normal cleaning, use a soft dry cloth.

For stubborn dirt, moisten a cloth in diluted detergent, wring it out firmly, and wipe the dirt off. Then polish with a dry cloth.

Never use solvents such as alcohol, thinner or benzene, since these will damage the printing and finish of the exterior.

## Specifications

### Input/Output

#### INPUT (1 ~ 8)

Connector : RCA pin jack (X 8)  
Input impedance : 10k  $\Omega$  or more  
Input level : -10dBV

#### OUTPUT (1 ~ 8)

Connector : RCA pin Jack (X 8)  
Load impedance : 10k  $\Omega$  or more  
Output level : -10dBV

#### DATA IN/OUT

Connector : Optical (X 2)  
Format : IEC 958 Part 2 (~S/P DIF)  
: Alesis Proprietary Multi Channel Optical Interface  
(Switchable)

#### MIDI IN/OUT/THRU

Connector : DIN 5PIN (X 3)  
Format : Complying to MIDI standard

#### PUNCH IN/OUT

Connector :  $\phi$  6mm Phone Jack (X 1)  
(An optional FOOT SW Model 8051 can be connected.)

#### REMOTE

Connector : D-sub 15PIN (X 1)

### Recording/Reproducing

Recording medium : 3.5 inch, hard disk x 1 (E-IDE type),  
(Optional hard disk)

Recording format : FDMS-2 Ver.2

Save/Load format : FDIO-1 Ver.2

Sampling frequency : 44.1kHz/48kHz

Quantization : 16-bit linear (Non expanded)  
A/D: 18-bit 64-time, over sampling, Delta-Sigma  
D/A: 20-bit 128-time, over sampling, Delta-Sigma

Recording time : approx. 30 minutes (at Optional Model 9041/  
44.1kHz)

No. of recording track : 8 tracks (Simultaneously recording)

D-90 Owner's Manual (MMC/FEX List/Maintenance/Specifications)

Crossfade : 10msec.

Recording/reproducing  
frequency : 20Hz ~ 20kHz

Dynamic range : 92dB

**General**

Dimensions : 482 (W) X 148 (H) X 329 (D) mm, 3U size

Weight : approx. 7.9kg (with REMOTE controller)

Power supply : 120VAC 60Hz  
: 230V~ 50/60Hz

Power consumption : approx. 25W

\* Specifications and appearance are subject to change without notice for product improvement.

\* "Adat" and the  symbol are trademarks of Alesis Corporation.

## INDEX

- [A]
- About copyrights 8
  - About damages 8
  - Auto play/Auto return key 16
  - Auto punch mode ON/OFF key 21
  - Auto punch in key 17
  - Auto punch out key 17
  - Auto return start key 16
  - Auto return end key 17
  - ABS time display 27
  - ABS 35
  - Analog recording 43
  - Auto Punch In/Out rehearsal mode 70
  - Auto Punch In/Out take mode 72
  - Auto play mode 62
  - Auto return mode 62
  - Auto repeat mode 66
- [B]
- BAR/BEAT/CLK display 28
  - Before operating the D-90 33
  - BAR/BEAT/CLK 35
  - Basic connections 43
  - Basic recording and playback 43
- [C]
- Clipboard in key 16
  - Clipboard out key 16
  - Copy key 21
  - Changing Programs 29, 46
  - Changing the stored start/end point 63
  - Copy and Paste 78
  - Copying 78
  - Copy & pasting 80
  - Cutting 90
  - Can't UNDO 30
- [D]
- Display section 26
  - Display select key 18
  - DATA IN connector 25
  - DATA OUT connector 25
  - DISK remain display 27
  - Disk error indication 32
  - Difference from a tape MTR 33
  - Default settings on the D-90 45
  - Digital recording 55
  - Disable 131
- [E]
- Erase key 20
  - Execute/Yes key 18
  - Exit/No key 18
  - Event overflow indication 31
  - Editing and storing the start/end point 63
  - Edit function 77
  - Erasing 89
  - Entering Setup mode 114
- [F]
- Fast forward button 23
  - Formatting the hard disk 40, 125
  - Frame rate 128
- [H]
- How to use a dust cap (included) 8
  - Hold/Digit move key 19
  - Hard disk operation LED 14, 24
  - Hard disk 36
- [I]
- Introduction 6
  - Input jack 24
  - Invalid data indication 30
  - Invalid In/Out indication 30
  - Input monitor 34
  - Inquiry message list 142
  - Installing a hard disk 36
- [J]
- Jog dial 19
- [L]
- Locate key 22
  - Load error indication 31
  - Locate function 61
  - Loading data from a DAT machine 92
- [M]
- Main features 9
  - Meter display 26
  - MIDI IN connector 25
  - MIDI OUT connector 25
  - MIDI THRU connector 25
  - MTC display 28
  - MTC 35
  - Mixdown 53
  - MIDI clock synchronization system 98
  - MTC synchronization system 101
  - Metronome function ON/OFF 122
  - MIDI SYNC OUT 127
  - MTC OFFSET 129
  - MTC OFFSET MODE 129
  - MIDI implementation chart 141
  - MMC command list 142
  - Maintenance 158
- [N]
- Notes about power supply 6
  - Notes on handling the hard disk 7
  - Notes on the setup location 7
  - Notes on repair 8
  - Notes on using detachable controller 8
- [O]
- Overtime indication 30
  - Overdubbing 52



[P]	Precautions	6	[U]	Undo key	20
	Paste key	21		Un-formatted indication	31
	Play button	23		Undo/Redo of Auto Punch In/Out	72
	Punch in/out jack	24		Undo/Redo the paste operation	82, 87
	Power switch	14		Undo/Redo the erase operation	90
	Power cable	25		Undo/Redo the cut operation	91
	Preset display	26	[W]	Warning message	30
	Ping-pong recording	54			
	Punch In/Out	67			
	Punch In/Out recording using a foot switch	73			
	Punch In/Out rehearsal using a foot switch	74			
	Punch In/Out take using a foot switch	75			
	Pasting	80, 85			
	Paste Undo/Redo	82, 87			
	Preroll time	126			
[R]	Record track select key	15			
	Redo key	20			
	Recall key	20			
	Record button	22			
	Rewind button	23			
	Repro monitor	34			
	REC ENABLE/DISABLE	131			
[S]	Store key	19			
	Shuttle dial	19			
	Stop button	22			
	SETUP mode display	28, 114			
	Storing the Punch In point	68			
	Storing the Punch Out point	68			
	Setting the auto return start/end point	63			
	Storing the start/end point in real-time	63			
	SETUP mode	114			
	Setting the time signature	118			
	Setting tempo	120			
	Saving and Loading the recordings	92, 124			
	Saving data to a DAT machine	92			
	Setting the preroll time for the locate operation	126			
	Selecting the synchronized signal output from the MIDI OUT connector	127			
	Setting the MTC frame rate	128			
	Setting MTC Offset time	129			
	Setting recording enable/disable mode	131			
	Setting a digital input track	132			
	Setting a digital output track	134			
	Setting display resolution mode ON/OFF	135			
	Setting Slave mode ON/OFF	136			
	Setting MIDI device ID	138			
	Setting the Undo function range	139			
	Setting a sampling rate	140			
	Slave mode	104, 108, 111			
	Specifications	158			
[T]	Timebase	35			

## Declaration of EC Directive

This equipment is compatible with the EMC Directive (89/336/EEC) - Directive on approximation of member nation's ordinance concerning the electromagnetic compatibility and with the Low Voltage Directive (73/23/EEC) - Directive on approximation of member nation's ordinance connecting electric equipment designed to be used within the specified voltage range.

### The Affect of Immunity on This Equipment

The affect of the European Specification EN50082-1 (coexistence of electromagnetic waves - common immunity specification) on this equipment are as shown below.

*\* In the electrical fast transient/burst requirements, radiate electromagnetic field requirements and static electricity discharging environment, this could be affected by generation of noise in some cases. The display content could also differ from actual figures.*

Please comply to the precautions below to make this equipment compatible with European Specification EN50082-1 (coexistence of electromagnetic waves - common immunity specification).

#### <NOTE>

*Caps are installed on the rear panel MIDI IN/OUT/THRU connectors. The purpose of these caps are to prevent static electricity from affecting this equipment. Do not remove these caps except when using the MIDI IN/OUT/THRU connectors.*

## FOSTEX DISTRIBUTORS IN EUROPE

\* Including non-EU countries.  
\* underlined: contracted distributors (as of Jun. 1, 1995)

### <AUSTRIA>

NAME: A.T.E.C. Audio- u. Videogeräte VertriebsgesmbH.  
ADD: Im Winkel 5, A-2325 Velm, Austria  
TEL: (+43) 2234-74004, FAX: (+43) 2234-74074

### <BELGIUM>

NAME: E.H.L.N.V.  
ADD: Maastrichterstraat 323, 3740 Mopertingen-  
Bilzen, Belgium  
TEL: (+32) 89-415278, FAX: (+32) 89-491662

### <DENMARK>

NAME: SC Sound ApS  
ADD: Malervej 2, DK-2630 Taastrup, Denmark  
TEL: (+45) 4399-8877, FAX: (+45) 4399-8077

### <FINLAND>

NAME: Noratron Audio  
ADD: Otariinluoma 7, FIN-02200 Espoo, Finland  
TEL: (+358) 0-5259330, FAX: (+358) 0-52593352

### <FRANCE>

NAME: Musikengere  
ADD: ZAC de Follouses, B. P. 609, 01706 Les Echets,  
France  
TEL: (+33) 72 26 27 00, FAX: (+33) 72 26 27 01

### <GERMANY>

NAME: Studiound & Music GmbH  
ADD: Scheppe Gewissegasse 8, D-35039 Marburg,  
Germany  
TEL: (+49) 6421-12071, FAX: (+49) 6421-15522

### <GREECE>

NAME: Bon Studio S. A.  
ADD: 6 Zaimi Street, Exarchia, 106.83 Athens, Greece  
TEL: (+30) 1-3809605-8, 3302059  
FAX: (+30) 1-3845755

### <ICELAND>

NAME: TH Danielsson HE.  
ADD: Skulagata 61, P.O. Box 5066, 125 Reykjavik,  
Iceland  
TEL: (+354) 588 5010, FAX: (+354) 588 5011

### <ITALY>

NAME: Entel S. r. l.  
ADD: V. I Maggio, N 18, 40050 Quarto Inferiore, (BO)  
Italy  
TEL: (+39) 51-768576, FAX: (+39) 51-768336

### <NETHERLANDS>

NAME: IENKE ROOS AUDIO B. V.  
ADD: Kulpwegweg 20, 1101 AG Amsterdam, The  
Netherlands  
TEL: (+31) 20-697-2121  
FAX: (+31) 20-697-4201

### <NORWAY>

NAME: Slv. Ine. Benum A/S  
ADD: P. O. Box 145 Vinderen, 0319 Oslo 3, Norway  
TEL: (+47) 22-145460, FAX: (+47) 22-148259

### <PORTUGAL>

NAME: Caius - Tecnologias Audio e Musica Lda.  
ADD: Rua de Santa Catarina, 131 4000 Porto, Portugal  
TEL: (+351) 2-2084456/325400  
FAX: (+351) 2-314760

### <SPAIN>

NAME: Multitracker S. A.  
ADD: C/Garcilaso No.9, Madrid 28010, Spain  
TEL: (+34) 1-4470700, 1-4470898  
FAX: (+34) 1-5930716

### <SWEDEN>

NAME: TTS Tal & Ton Studioteknik AB  
ADD: Gelbgjutarevagen 4, S-171 48 Solna, Sweden  
TEL: (+46) 8-7340750, FAX: (+46) 8-824476

### <SWITZERLAND>

NAME: Audio Bauer Pro AG  
ADD: Bernerstrasse-Nord 182, CH-8064 Zurich,  
Switzerland  
TEL: (+41) 1-4323230, FAX: (+41) 1-4326558

### <UK>

NAME: SCV London  
ADD: 3A 6-24 Southgate Road, London N1 3JJ,  
England, UK  
TEL: (+44) 171-923-1892  
FAX: (+44) 171-241-3644

**Fostex** FOSTEX CORPORATION  
3-2-35 Musashino, Akishima-shi, Tokyo, Japan 196  
FOSTEX CORPORATION OF AMERICA  
15431, Blackburn Ave., Norwalk, CA 90650, U. S. A

© PRINTED IN JAPAN APR. 1997 8288 290 100 FX

## Free Manuals Download Website

<http://myh66.com>

<http://usermanuals.us>

<http://www.somanuals.com>

<http://www.4manuals.cc>

<http://www.manual-lib.com>

<http://www.404manual.com>

<http://www.luxmanual.com>

<http://aubethermostatmanual.com>

Golf course search by state

<http://golfingnear.com>

Email search by domain

<http://emailbydomain.com>

Auto manuals search

<http://auto.somanuals.com>

TV manuals search

<http://tv.somanuals.com>