

Owner's Manual

Model

DMT-8

Digital Multitracker

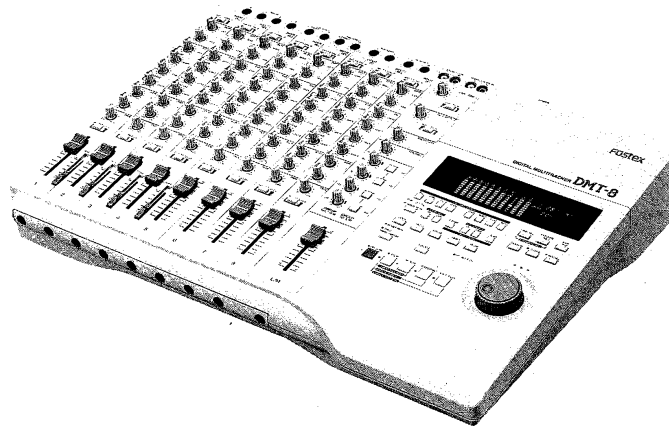

Fostex

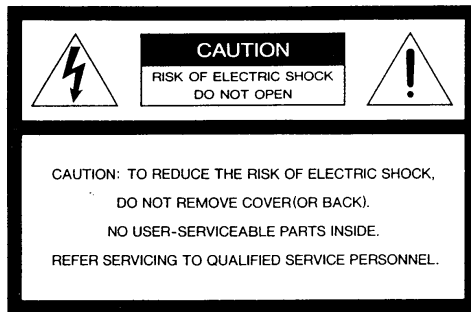

CAUTION:
TO PREVENT ELECTRIC SHOCK, MATCH WIDE BLADE OF PLUG TO WIDE SLOT, FULLY INSERT.

ATTENTION:
POUR ÉVITER LES CHOCs ÉLECTRIQUES, INTRODUIRE LA LAME LA PLUS LARGE DE LA FICHE DANS LA BORNE CORRESPONDANTE DE LA PRISE ET POUSSER JUSQU'AU FOND.



The lightning flash with arrowhead symbol, within an equilateral triangle, is intended to alert the user to the presence of uninsulated "dangerous voltage" within the product's enclosure that may be of sufficient magnitude to constitute a risk of electric shock to persons.



The exclamation point within an equilateral triangle is intended to alert the user to the presence of important operating and maintenance (servicing) instructions in the literature accompanying the appliance.

"WARNING"

"TO REDUCE THE RISK OF FIRE OR ELECTRIC SHOCK, DO NOT EXPOSE THIS APPLIANCE TO RAIN OR MOISTURE."

SAFETY INSTRUCTIONS

1. Read Instructions — All the safety and operating instructions should be read before the appliance is operated.
2. Retain Instructions — The safety and operating instructions should be retained for future reference.
3. Heed Warnings — All warnings on the appliance and in the operating instructions should be adhered to.
4. Follow Instructions — All operating and use instructions should be followed.
5. Water and Moisture — The appliance should not be used near water — for example, near a bathtub, washbowl, kitchen sink, laundry tub, in a wet basement, or near a swimming pool, and the like.
6. Carts and Stands — The appliance should be used only with a cart or stand that is recommended by the manufacturer.
7. Wall or Ceiling Mounting — The appliance should be mounted to a wall or ceiling only as recommended by the manufacturer.
8. Ventilation — The appliance should be situated so that its location or position does not interfere with its proper ventilation. For example, the appliance should not be situated on a bed, sofa, rug, or similar surface that may block the ventilation openings; or, placed in a built-in installation, such as a bookcase or cabinet that may impede the flow of air through the ventilation openings.
9. Heat — The appliance should be situated away from heat sources such as radiators, heat registers, stoves, or other appliances (including amplifiers) that produce heat.
10. Power Sources — The appliance should be connected to a power supply only of the type described in the operating instructions or as marked on the appliance.
11. Grounding or Polarization — The precautions that should be taken so that the grounding or polarization means of an appliance is not defeated.
12. Power Cord Protection — Power supply cords should be routed so that they are not likely to be walked on or pinched by items placed upon or against them, paying particular attention to cords at plugs, convenience receptacles, and the point where they exit from the appliance.
13. Cleaning — The appliance should be cleaned only as recommended by the manufacturer.
14. Nonuse Periods — The power cord of the appliance should be unplugged from the outlet when left unused for a long period of time.
15. Object and Liquid Entry — Care should be taken so that objects do not fall and liquids are not spilled into the enclosure through openings.
16. Damage Requiring Service — The appliance should be serviced by qualified service personnel when:
 - A. The power supply cord or the plug has been damaged; or
 - B. Objects have fallen, or liquid has been spilled into the appliance; or
 - C. The appliance has been exposed to rain; or
 - D. The appliance does not appear to operate normally or exhibits a marked change in performance; or
 - E. The appliance has been dropped, or the enclosure damaged.
17. Servicing — The user should not attempt to service the appliance beyond that described in the operating instructions. All other servicing should be referred to qualified service personnel.



An appliance and cart combination should be moved with care. Quick stops, excessive force, and uneven surfaces may cause the appliance and cart combination to overturn.

7. Wall or Ceiling Mounting — The appliance should be mounted to a wall or ceiling only as recommended by the manufacturer.
8. Ventilation — The appliance should be situated so that its location or position does not interfere with its proper ventilation. For example, the appliance should not be situated on a bed, sofa, rug, or similar surface that may block the ventilation openings; or, placed in a built-in installation, such as a bookcase or cabinet that may impede the flow of air through the ventilation openings.

Table of Contents

Introduction

Precautions

Notes about power supply.....	5
Notes on handling the hard disk.....	6
Notes on the setup location.....	6
Notes on repair.....	6
Warning on oscillation by looping.....	7

Chapter 1 Main Features of DMT-8

Recorder Section.....	8
Mixer Section.....	10

Chapter 2 Names and Functions

2-1. Mixer section.....	13
2-2. Recorder section.....	16
2-3. I/O Connector section-1 (Front panel).....	25
2-4. I/O Connector section-2 (Top panel).....	25
2-5. I/O Connector section-3 (Rear panel).....	26
2-6. Display section.....	28

Chapter 3 Before Starting (Glossary)

3-1. Difference between track and channel.....	34
3-2. Difference from a tape MTR.....	35
3-3. Input monitor and Repro monitor.....	35
3-4. Timebase.....	36
3-5. Three bus line.....	37
3-6. Alternate Mix function.....	38
3-7. Group Assign switch and Group Panpot.....	38
3-8. Effect connection-1 (Using AUX).....	39
3-9. Effect connection-2 (Using INSERT jack).....	40
3-10. Parametric Equalizer.....	40

Chapter 7 Getting Started

4-1. The default settings on the DMT-8.....	41
4-2. Basic recording (before starting multitrack recording).....	42
4-3. Multitrack recording using overdubbing.....	46
Step 1. Recording a drum machine to Track 1.....	46
Step 2. Overdubbing an electric bass to Track 2.....	48
Step 3. Overdubbing an electric guitar on Track 3.....	50
Step 4. Overdubbing the vocal on Track 4.....	52
4-4. Mixdown.....	56
4-5. Recording four tracks simultaneously.....	60

Chapter 5 Application Guide

5-1. Ping-pong recording.....	63
5-2. MIDI Clock synchronization system.....	65

5-3. MTC Synchronization/Machine Control system.....	67
5-4. Using only the DMT-8 recorder section.....	68
Chapter 6 Punch In/Out	
6-1. Auto Punch In/Out.....	70
6-2. Punch In/Out Recording using a foot switch.....	75
Chapter 7 Locate Function	
7-1. Locate.....	79
7-2. Auto Play mode.....	80
7-3. Auto Return mode.....	80
7-4. Auto Repeat mode.....	84
Chapter 8 Edit Function	
8-1. Copy & Paste.....	85
Copying.....	86
Pasting.....	87
8-2. Erase & Cut.....	89
Erasing.....	90
Cutting.....	91
Chapter 9 Setup mode	
9-1. Entering Setup mode.....	92
9-2. Setting the time signature ("BAR J").....	96
9-3. Setting tempo ("TEMPO").....	98
9-4. Metronome Function On/Off ("CLICK" ON/OFF).....	100
9-5. Saving and loading the recordings ("SAVE", "LOAD").....	101
9-6. Formatting the hard disk ("FORMAT").....	104
9-7. Setting the preroll time for the Locate operation ("PREROLL TIME").....	105
9-8. Selecting the synchronized signal output from the MIDI OUT connector ("MIDI SYNC OUT").....	106
9-9. Setting the MTC Frame Rate ("FRAME RATE").....	107
9-10. Setting MTC Offset Time ("MTC OFFSET").....	108
9-11. Setting Recording Enable/Disable mode ("rEc" ENABLE/DISABLE).....	109
MIDI Implementation Chart.....	110
MMC Command List/Inquiry Message List.....	111
Maintenance.....	112
Specifications.....	113
Block Diagram.....	115
INDEX.....	116



Introduction

Thank you for purchasing the Fostex Model DMT-8!

The DMT-8 is an eight-track digital multitrack recorder with an integrated eight-channel analog mixer and a 540Mbyte IDE internal hard disk. It enables you to achieve high-quality recording/playback with a quantization of 16 bit and a sampling rate of 44.1kHz, which is approximately equivalent to CD quality.

The DMT-8 incorporates many advanced functions thanks to the incorporation of a hard disk, such as copy, paste, cut, erase (using time value or MIDI bar/beat/clock), and undo/redo. The DMT-8 is also equipped with a jog wheel, a shuttle dial for speedy operation, a song data save/load function for an external DAT recorder, and an AUTO function that includes 9-point AUTO locate, AUTO return/play, and AUTO punch in/out (with rehearsal function).

The unit can also transmit MIDI clock data and Song Position Pointers via the internal programmable tempo map, as well as MTC and MMC. You can also control and synchronize an external MIDI sequencer or sequencing software from the DMT-8.

The analog mixer section, which is integrated with the hard disk recorder, has Bi-2 AUX send, two parametric equalizers, and stereo submix, offering a mixing function with virtually sixteen inputs.

Please read this Owner's Manual thoroughly and keep it in a safe place so that you will be able to produce high-definition, high tonal quality music.

Precautions

Notes about power supply

- * Be sure to connect the DMT-8 to the power supply specified in the Specifications section of this Owner's Manual. Do not use an AC outlet of any other voltage.
- * Do not connect the DMT-8 to the same AC outlet to which devices that could generate noise (such as a large motor or dimmer), or the devices that consume a large amount of power (such as an air conditioning system or a large electric heater) are connected.
- * If you use the unit in an area with a different power voltage, first consult your dealer or the nearest FOSTEX service station. You can use the unit with a power frequency of 50Hz or 60Hz.
- * It is very dangerous to use a power cord that is frayed or damaged. In such a case, stop using the unit immediately and ask your dealer to repair the cord.
- * To avoid possible electric shock and damage to the DMT-8, avoid contact with water or other liquids, or do not handle the power plug while your hands are wet.
- * To prevent possible electric shock and damage to the DMT-8, do not remove the main unit cover or reach the inside the unit.
- * Do not let water or other liquid, or metal objects such as pins, accidentally enter the inside of the unit because this may lead to electric shock or damage. Should water enter the inside of the unit, remove the power plug from the AC outlet, and consult your dealer or the nearest FOSTEX service station.

- * To prevent damage to the DMT-8, be sure to power on the connected devices first, then turn on the power to the DMT-8.
When you remove or connect the cables to the input/output connectors on the DMT-8, make sure that the channel INPUT faders and volume controls are set to "0."

Notes on handling the hard disk

- * The DMT-8 is equipped with a high-precision hard disk. Do not expose the unit to excessive vibration at any time. In particular, do not move the unit or allow an impact to the unit when the power is on.
- * *Before turning the power off to the DMT-8, first quit Setup mode and make sure that the recorder section is stopped. Especially, never attempt to turn off the power to the unit while the hard disk is accessing data (the HD ACCESS LED is lit or flashing). Otherwise, not only will you lose recorded data, but you may damage to the unit. FOSTEX is not responsible for data lost during operation of the unit.*
- * Before you change the location of the DMT-8, pack the unit in the shipping carton or an impact-resistant case.
Make sure that the unit is kept free from external vibration or impact since the unit is very sensitive to vibration.

Notes on the setup location

- * Do not install the unit in locations subject to the following:
Extremely high or low temperature, or significant changes in temperature
Excessive humidity or dust
Excessive changes in power supply voltage
Unstable or significantly vibrating or shaking surfaces
Near a strong magnetic field (such as a TV or speakers)
- * If you move the unit from a place with an excessively low temperature to a warm place, or if you use the unit in a room in which the temperature varies significantly during winter, condensation may occur on the hard disk or other parts. In such cases, leave the unit for about an hour in the new location before you turn on the power.

Notes on repair

- * This unit does not use any parts that users can repair easily. Contact your dealer or the nearest FOSTEX service station to ask about repairs.
- * Use the packing carton designed for the DMT-8 when you transport the unit to the dealer for repair or return.
If you have discarded the packing box, try to pack the unit completely using shock absorbing materials. Fostex is not responsible for malfunction or damage due to incomplete packaging or caused during transport.

Warning on oscillation by looping

When the DMT-8 enters recording mode (or input monitoring status) due to incorrect operation, the signal may form loops, causing abnormal oscillation to occur.

Follow the procedure below immediately if oscillation occurs. If you continue monitoring the signal through headphones or external monitor speakers without any corrective action, your hearing or the speakers or headphones may be damaged.

Lower the master fader L/R to "0."

The following actions may form loop:

1. You route the recorder playback signal to the channel INPUT fader (the channel INPUT SEL switch is set to "TRK"), you press the RECORD TRACK select key (the same track as the one from which the signal is routed to the INPUT fader) to "READY" the track, and press only the RECORD button to cause the "READY" track to enter input monitoring status, or press the RECORD button and PLAY button to start recording.
2. During ping-pong recording, you select the wrong track (that is, the same track as the playback track), "READY" that track, then start input monitoring or recording.

After one of these operations, loops will form. When you raise the GROUP MASTER control (which corresponds to the channel INPUT fader or the track for ping-pong recording) higher than the standard level (usually "8" on the fader scale or higher; however, it depends on the equalizer setting), oscillation will occur. (The level meter will peak for the oscillating channel signal.)

If you do not correct this situation and you continue to monitor the signal through the headphones or monitor speakers, unexpected oscillation noise will be output, causing damaging your hearing or the headphones or speakers.

Be sure to lower the master fader L/R, correct the position of the switches and controls, and redo the operation.

Chapter 1

Main Features of DMT-8

The DMT-8 is equipped with the following functions:

<Recorder section>

High-quality sound, eight track hard disk digital recorder

- * Instead of conventional cassette tape, the DMT-8 is equipped with a 3.5 inch IDE type 540MB hard disk as the recording media, allowing for about 12.5 minutes of recording/playback.
- * Eight tracks enable four track simultaneous recording. (For details, refer to page 60.)
- * Sixteen bit linear quantization and a sampling rate of 44.1kHz, which enables you to record and playback high quality sounds that are approximately equivalent to CD quality.

Versatile editing functions are made possible by the hard disk

- * The DMT-8 allows you to use non-linear, non-destructive audio editing functions, such as copy, paste, cut, and erase. These edit operations can refer not only to time values such as ABS and MIDI timecode, but to MIDI bar/beat/clock values. (Refer to page 85 for details.)
- * You need only one action to monitor the copied audio data using the Clipboard Play function. (Refer to page 87 for details.)
- * The Over Time Monitor function lets you know the overtime length when you try to copy or paste data in excess of the currently-available disk space. (Refer to page 31 for details.)

Undo/Redo function to support edit works

- * The Undo/Redo functions will cancel the latest edit and restore the data obtained before the edit, or restore the data obtained after the edit respectively. (Refer to pages 88 ~ 91 for details.)
- * The Can't Undo function provides you with an alarm indicating that the undo area is insufficient for the Auto Punch In/Out operation. (Refer to page 31 and 74 for details.)

Song data Save/Load function

- * You can save and load recordings (audio data plus corresponding setup data) to and from an external DAT machine. The Save/Load function will take about four times as long as recording (i.e., it takes 16 minutes to save or load a four-minute song). (Refer to page 101 for details.)

Convenient Disk Remain Display function

- * The Disk Remain function facilitates checking the available recording time. This function is compatible with all types of time references - ABS, MTC, MIDI bar, and beat.

Three types of time reference

- * The 10-digit, 7-segment display shows the current time (position) of the recorder using ABS time, MIDI timecode, or MIDI bar/beat.
- * ABS and MTC function with sub-frame precision (1/100 frame), and the MIDI bar/beat is 96 clock precision. These are used for data display and the memory register.

Various Auto functions

- * The DMT-8 is equipped with six time memories that can be edited. Using these memories, you can perform auto locate, auto return and auto play between two points, and auto punch in/out (crossfade time: 10ms). (Refer to page 70 for details.)
- * Auto locate to ABS 0 or ABS END is also possible. In addition, the LOCATE key has its own memory. This is very useful for a repeated locate operation. (Refer to page 79 for details.)
- * There are two modes for Auto Punch In/Out function: "Take" mode, which is used for actual recording, and "Rehearsal," which is used to switch the part located between the In and Out points to the input monitor. (Refer to page 70 for details.)
- * The Pre-roll function is used to "park" a specified time prior to the locate point. Pre-roll time can be set in the range of 0 - 10 seconds. (Refer to page 105 for details.)

MIDI function using MMC and MTC

- * You can add an offset of less than six hours to the ABS time value to output MTC (MIDI timecode). The MTC frame rate is compatible with all formats - 24, 25, 30DF, and 30ND. (Refer to page 107 for setting the frame rate.)
- * The DMT-8 can be controlled via MMC (MIDI Machine Control) from external sequencing software. (Refer to pages 65 and 67 for more details.)

Internal programmable Tempo Map

- * The DMT-8 is equipped with an internal programmable Tempo Map that allows the MIDI clock and Song Position Pointer to be transmitted to an external sequencer (switchable to MTC output) for complete synchronization with a hardware sequencer. You can also use Track 8 as a Metronome playback track, which will generate counts according to a Tempo Map. (Refer to pages 96 - 99 for details.)
- * Eleven types of Tempo Map signature are available: 1/4, 2/4, 3/4, 4/4, 5/4, 1/8, 3/8, 5/8, 6/8, 7/8, and 8/8. Maximum 16 points of signature can be set.
- * Up to 32 points of tempo on a Tempo Map can be set on any point determined by the signature settings, in the range of 30 - 250 per quarter note. (Refer to page 98 for details.)

Setup Menu function

- * The DMT-8 is equipped with the following setup Menu functions for the interactive operation system. You can use a highly visible FL tube display and the jog/shuttle dial to set the parameters. (Refer to page 92 for details.)

Main Setup Menu

- LOAD (loading audio and setup data)
- SAVE (saving audio and setup data)

FORMAT (formatting the internal hard disk)
PREROLL (setting the Pre-roll time)
MIDI SYNC OUT (selecting MTC, MIDI clock, or OFF)
FRAME RATE (setting the MTC frame rate)
MTC OFFSET (setting the MTC offset value against the ABS time)
BAR/BEAT SET (setting the signature)
TEMPO SET (setting the tempo)
CLICK ON/OFF (switching the Metronome function ON/OFF)
REC ENABLE (setting the REC ENABLE or REC DISABLE)

Easy-to-use jog/shuttle dial

- * Using the shuttle dial allows for +/-1, 2, 3, 5, 9, 12, or 20-time speed cueing (fast-forward while monitoring audio).
- * Using the jog dial allows for digital audio scrubbing. Using this function, you can locate data efficiently while monitoring audio without any changes in pitch.
- * The jog/shuttle dial is also used to recall parameters and to enter data.

Other recorder functions

- * In addition to 30-time speed FF/REW, 5-time speed cueing (PLAY+FF/REW) is also available.
- * Four RECORDER IN connectors (1/5, 2/6, 3/7, 4/8) are used to record data directly into the recorder, bypassing the mixer section.
- * The DMT-8 also offers the RECORDER OUT connectors (1-8) to output data directly from the recorder.
- * Connect an optional foot switch Model 8051 to the PUNCH IN/OUT connector for punch in/out (and rehearsal) operation to free your hands. (Refer to page 75 for details.)
- * A highly visible FL-tube level meter shows the output level of Tracks 1-8 and Stereo L/R.

<Mixer section>

A high-quality eight-channel analog mixer that offers compatibility with four microphones

- * The DMT-8 is equipped with a high-quality eight-channel analog mixer with four groups and compatibility with four microphones.
- * The stereo L/R output can be routed to the DATA OUT connectors (optical, S/P DIF format).
- * Channels 1-4 for microphones are equipped with a TRIM fader with a continuous range of -10dBV - -50dBV.
- * Channels 1-4 have an INSERT jack through which you can route dynamic effects such as a compressor and noise gate.

SUB MIX section that simulates a virtual 16-channel mixing

- * Each input channel has a SUB MIX section (stereo-type in-line monitor section), which allows for more real monitoring of the recorder output/input signal with a stereo image.
- * Using the Alternate Mix function, input signal and recorder output can be routed to the channel fader and the SUB MIX section alternately. Virtual 16-channel mixing

without an external mixer is a powerful feature--especially for mixdown while syncing with a MIDI source. (Refer to page 65 for details.)

Flexible two AUX send/return

- * Each input channel has two AUX sends. You can select the post channel fader or post SUB MIX as a source. It is useful as a monitor reverb send during overdubbing, as well as for effect processing during mixdown.
- * The mixer section has two stereo AUX returns. You can assign RTN 1 to Group 1/2 or stereo L/R, and RTN 2 to Group 3/4 or stereo L/R.

Two parametric EQs for detailed sound making

- * Each input channel has two parametric EQs for flexible sound making. (Refer to page 40 for details.)

Other mixer functions

- * GROUP TO L/R function used to route four group outputs to stereo L/R.
- * STEREO BUSS IN connectors for the external mixer output or effect return. (Refer to page 68 for details.)
- * MON OUT connector and MONITOR volume for audio monitoring through the amplifier or speakers.
- * One headphone jack and PHONES volume control.

Chapter 2

Names and Functions

Rear Panel (Input/Output Section)

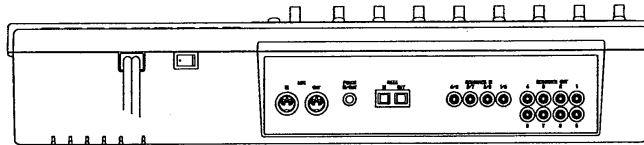

Top Panel (Mixer Control, Recorder Control, and Input/Output Section)

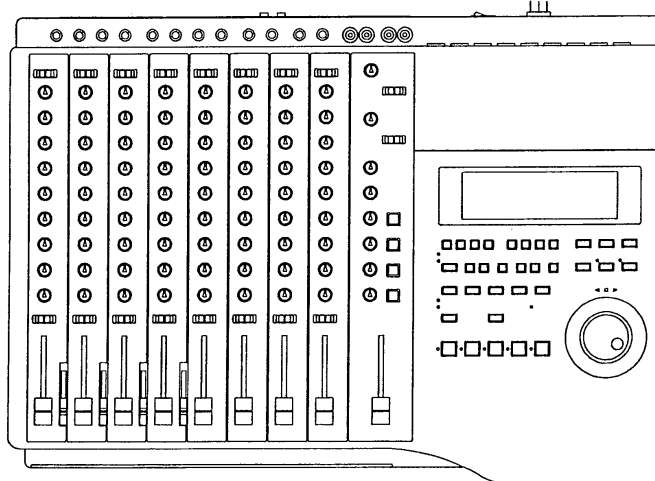

Front Panel (Input/Output Section)

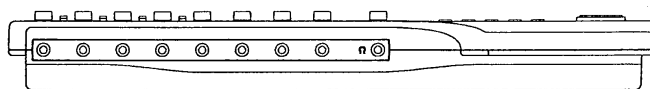

2-1. Mixer section

(Words in this manual that appear in brackets [] are used on the panel.)

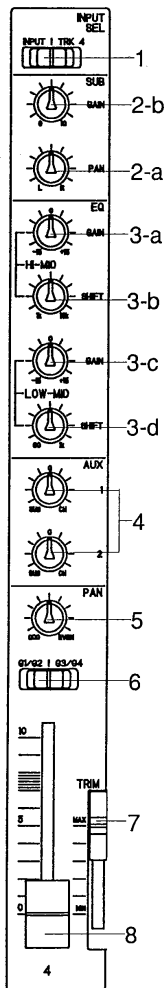

1. Input Select switch [INPUT SEL INPUT/TRK]

This switch selects the signal routed to the INPUT fader of each channel.

INPUT	Signal of the instrument or microphone connected to the INPUT jack is routed to the INPUT fader. At this time, the recorder output signal will be sent to the SUB MIX section.
center	Switch OFF (No signal will be routed.)
TRK	Recorder output signal will be routed to the INPUT fader. The track signal will be routed to the same number of the channel as the Track. For example, the Track 1 signal is routed to Channel 1, and the Track 2 signal is routed to Channel 2. At this time, the signal input to the INPUT jack will be sent to the SUB MIX section.

■ Refer to page "38" of Chapter 3 for instructions on using the INPUT SEL switch.

2. SUB MIX section

According to the selection of the INPUT SEL switch, the input signal from the INPUT jack or the recorder output signal will be routed to this section. This section is usually used to monitor the recorder playback signal during overdubbing.

2-a. SUB panpot knob [SUB PAN]

This knob is used to adjust the L/R balance of the SUB MIX signal before it is sent to the stereo bus L/R.

2-b. SUB gain control knob [SUB GAIN]

This control knob is used to adjust the output level of the SUB MIX signal before it is sent to the stereo bus L/R. Level 6 or 7 is a standard level, and a gain of about 6dB will be obtained with level 10.

3. Equalizer section

This section allows you to adjust the tonal quality of the signal routed to the INPUT fader.

3-a. HI-MID gain control knob [HI-MID GAIN]

This knob is used to boost or cut the frequency set via the HI-MID SHIFT knob in the range of +/-15dB.

3-b. HI-MID shift knob [HI-MID SHIFT]

This knob allows you to specify the frequency to be increased or decreased in the range of 1kHz - 16kHz.

3-c. LOW-MID gain control knob [LOW-MID GAIN]

This knob is used to boost or cut the frequency set via the LOW-MID SHIFT knob in the range of +/-15dB.

3-d. LOW-MID shift knob [LOW-MID SHIFT]

This knob allows you to specify the frequency to be increased or decreased in the range of 60Hz - 1kHz.

■ Refer to page "40" of Chapter 3 for a detailed description of the equalizer frequency response.

4. AUX send knob [AUX 1, 2]

This knob is used to select the signal that is output to the AUX SEND 1 or AUX SEND 2 jack, and to adjust the output level. Once adjusted, the signal is sent from the AUX SEND jack to an external device such as an effect unit.

SUB	This option selects the SUB MIX signal (its level has been adjusted by SUB GAIN) to be output. Rotating the knob counter-clockwise will increase the output level.
0	No signal will be output.
CH	This option selects the INPUT fader signal (its level has been adjusted by the INPUT fader) to be output. Rotating the knob clockwise will increase the output level.

The signal controlled via the AUX 1 knob will be output from the AUX SEND 1 jack, and the signal controlled via the AUX 2 knob will be output from the AUX SEND 2 jack.

5. Group Assign Panpot knob [PAN ODD/EVEN]

In combination with the Group Assign switch, this knob is used to determine the routing of the INPUT fader signal to the Group Buses.

ODD	The signal is routed to Group Buses 1 or 3.
center	The signal is routed to Group Buses 1 and 2 (or 3 and 4) with the same level.
EVEN	The signal is routed to Group Buses 2 or 4.

6. Group Assign switch [G1/G2, G3/G4]

In combination with the Pan knob, this switch sends the INPUT fader signal to Group Buses.

G1/G2	When the Panpot knob is set to ODD, the signal is sent to Group Bus 1. When the Panpot knob is set to EVEN, the signal is sent to Group Bus 2.
center	No signal is sent to any bus line.
G3/G4	When the Panpot knob is set to ODD, the signal is sent to Group Bus 3. When the Panpot knob is set to EVEN, the signal is sent to Group Bus 4.

■ Refer to page "38" for a detailed description of the Group Assign switch and the Group Assign Panpot knob.

7. INPUT faders [1-8]

The INPUT fader controls the input level of the signal selected via the INPUT SEL switch (that is, the input signal from the INPUT jack, or the recorder output signal). Level 7 or 8 is a standard level, and a gain of about 6dB will be obtained with level 10.

8. TRIM faders [TRIM 1-4]

The TRIM faders control the signal level according to the output level of the devices connected to INPUT jacks 1-4. The adjustable range is -10dBV (LINE level) to -50dBV (MIC level) continuous.

Example

MAX: -50dBV (MIC level)	↑	Mic (Low output type) Mic (High output type) E. Guitar/E. Base (Single coil type) E. Guitar/E. Base (Harmbacking type)
MIN: -10dBV (LINE level)	↓	Keyboard, Drum machine

9. AUX Return 1 Level control [AUX RTN 1]

This control adjusts the signal level input from the effect unit connected to the AUX RTN 1 jack. The volume level changes equally for the L and R channels.

10. AUX Return 1 Assign switch [G1/G2, L/R]

This switch determines the routing of the signal (after level adjustment via AUX RTN1) to the bus line.

G1/G2	A signal routed to the AUX RTN jack L is sent to Group Bus 1, and a signal routed to the AUX RTN jack R is sent to Group Bus 2.
center	No signal is sent to any bus line.
L/R	A signal routed to the AUX RTN jack L is sent to Group Bus L, and a signal routed to the AUX RTN jack R is sent to Group Bus R.

11. AUX Return 2 Level control [AUX RTN2]

This control adjusts the signal level input from the effect unit connected to the AUX RTN 2 jack. The volume level changes equally for the L and R channel.

12. AUX Return 2 Assign switch [G3/G4, L/R]

This switch determines the routing of the signal (after level adjustment via AUX RTN2) to the bus line.

G3/G4	A signal routed to the AUX RTN jack L is sent to Group Bus 3, and a signal routed to the AUX RTN jack R is sent to Group Bus 4.
center	No signal is sent to any bus line.
L/R	A signal routed to the AUX RTN jack L is sent to Stereo Bus L, and a signal routed to the AUX RTN jack R is sent to Stereo Bus R.

13. Monitor Level control [MONITOR]

This control adjusts the signal level output to an external amplifier or speakers (or powered speakers) connected to the MON OUT jack. Increasing the monitor level while the Master faders L/R are raised allows you to monitor the Stereo Bus L/R output signal via an external amplifier or speakers. Level 7 or 8 is a standard level, and a gain of about 6dB will be obtained with level 10.

14. Headphone Level control [PHONES]

This control adjusts the volume level of the sound output via connected headphones. Increasing the headphone level while the Master faders L/R are raised allows you to monitor the Stereo Bus L/R output signal via the headphones.

15. Group Master Level control [GROUP MASTER G1, G2, G3, G4]

These control knobs adjust the output level of Group Buses 1-4--that is, the master volume level of the signal routed by means of the Group Assign Panpot/Group Assign switch. These knobs are used to adjust the level of the final send signal sent to Tracks 1-4 and Tracks 5-8 of the recorder section.

16. Group TO L/R switch [GROUP TO L/R G1, G2, G3, G4]

These switches are pressed ON to send the signal to Stereo Buses L/R (after its level is adjusted via the G1 - G4 knobs).

If you press either G1 or G2 ON, the selected Group Bus signal will be sent to Stereo Bus L/R in monaural. In the same way, if you press either G3 or G4 ON, the selected Group Bus signal will be sent to Stereo Bus L/R in monaural. To send the signal in

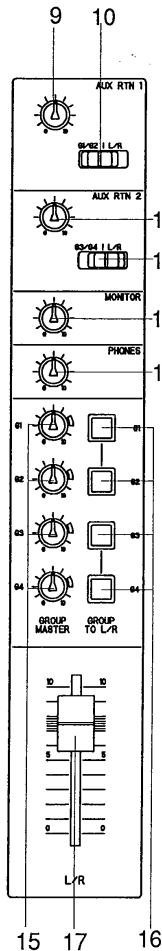

stereo, press both G1 and G2, and G3 and G4 ON.

Press all these switches ON in order to remix the signal routed to Groups 1-4 (via the Group Assign Panpot/Group Assign switches) into Stereo Buses L/R, then mix down the signal from the STEREO OUT jacks L/R into the master recorder.

17. Master fader [L/R]

This fader adjusts the output signal level at the STEREO OUT Jacks L/R (Stereo Bus L/R output signal).

The settings will affect the output level of MON OUT and PHONES. Make sure that the master fader level is raised while you are monitoring the sound.

2-2. Recorder section

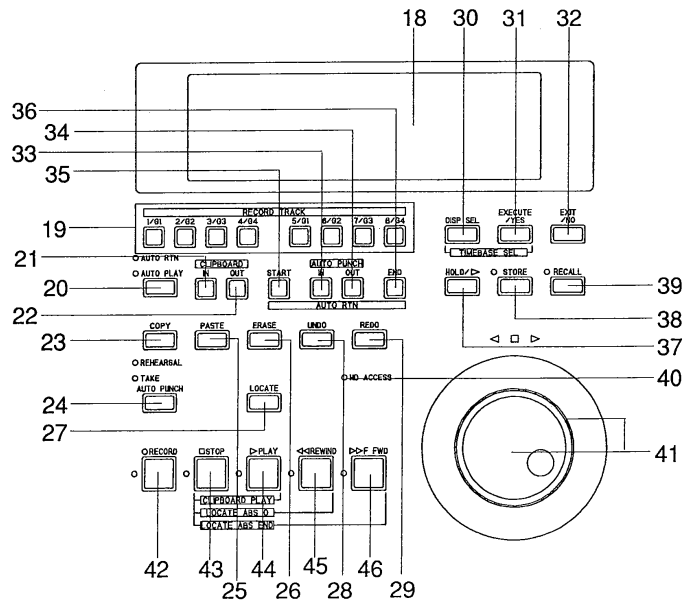

18. Meter display

This meter display shows the signal level and settings.

Refer to the "Display section" on page "28."

19. Record Track Select key [RECORD TRACK]

The Record Track Select key selects "SAFE-READY" for the recording track.

When you press this key once, the track enters the READY status, and the track indication on the display will blink. Pressing it again changes this status to "SAFE" and the track indication will go out. When you start recording, the blinking track indication becomes illuminated.

When you press only the RECORD button while the track is in the READY status, the track becomes an input monitor, allowing you to adjust the recording level. Pressing only the RECORD button again, the track become a reproduction monitor.

■ Refer to page "35" of Chapter 3 for details about the reproduction monitor and the input monitor.

Eight tracks may be selected simultaneously, and each track will record the following signal:

Group Bus 1 output signal (signal at G1) ->	Tracks 1 and 5
Group Bus 2 output signal (signal at G2) ->	Tracks 2 and 6
Group Bus 3 output signal (signal at G3) ->	Tracks 3 and 7
Group Bus 4 output signal (signal at G4) ->	Tracks 4 and 8

20. Auto Play/Auto Return key

Pressing this key repeatedly will change Auto Play mode, Auto Return mode, and Repeat mode On/Off as follows: (○: LED off, ●: LED light up)

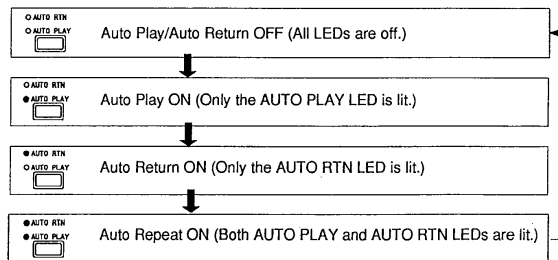
**Auto Play mode:**

In this mode, playback will start automatically after the START point is located. This function is effective at any locate points other than the ABS END point.

Auto Return mode:

When the END point is reached during playback, the START point is automatically located in this mode. This function is effective only when the START and END points have been specified.

<Note>

Auto Return function is effective only during playback. In recording mode, the START point will not be located automatically when the END point is reached.

Auto Repeat mode:

This mode is a combination of Auto Play and Auto Return, and plays back the part between the START and END points repeatedly. The auto repeat function is effective only when the START and END points have been specified correctly.

■ Refer to page "79" of Chapter 7 for details.

21. Clipboard In key [CLIPBOARD IN]

When audio data is copied, the start point of the copied part is stored in memory. Pressing this key following the RECALL key (or pressing only this key) will show the stored data on the display and the recording section will enter edit mode. In edit mode, use the HOLD/> key or shuttle dial to move around the digits, and use the jog dial to increase/decrease the value. If you press this key following the STORE key after the edit operation, the edit value will be stored into the key memory. The data stored by this key can be used as locate data. When you turn the power to the DMT-8, the memory will be reset to the factory default setting.

- Refer to page "79" of Chapter 7 for locating the CLIPBOARD IN point.
- Refer to page "85" of Chapter 8 for copying data to the clipboard.

22. Clipboard Out key [CLIPBOARD OUT]

When audio data is copied, the end point of the copied part is stored in the memory. Pressing this key following the RECALL key (or pressing only this key) will show the stored data on the display and the recording section enters edit mode. In edit mode, use the HOLD/> key or shuttle dial to move around the digits, and use the jog dial to increase/decrease the value. If you press this key following the STORE key after the edit operation, the edit value will be stored into the key memory. The data stored by this key can be used as locate data. When you turn the power to the DMT-8, the memory will be reset to the factory default setting.

- Refer to page "79" of Chapter 7 for locating the CLIPBOARD OUT point.
- Refer to page "85" of Chapter 8 for copying data.

23. Copy key [COPY]

This key is used to copy data stored in the memory using the CLIPBOARD IN/OUT keys. To execute the copy operation, one or more tracks must be readied, and a correct value must be stored for the In and Out points. If you attempt to copy data when all tracks are safe, all track indications and a "SELECT trk" indication on the display will blink to warn you. If a correct value is not set for the Clipboard In or Out points, "Void out" warning will appear.

- Refer to page "85" for more information about copying data.

24. Auto Punch Mode On/Off key [AUTO PUNCH]

Switch this key ON for auto punch in/out.

When you press this key while a correct value is stored to the AUTO PUNCH IN key and the AUTO PUNCH OUT key, both the REHEARSAL LED and TAKE LED will blink, indicating that Auto Punch mode is on.

Pressing the PLAY button under this condition will put the unit into "Rehearsal mode" for Auto Punch In/Out recording. Pressing the PLAY button and RECORD button simultaneously will put the unit into "Take mode."

There are five combinations of the REHEARSAL LED and TAKE LED that indicate the status of the unit regarding auto punch recording:

Auto Punch mode OFF	Both REHEARSAL LED and TAKE LED are off.
Auto Punch mode ON	Both REHEARSAL LED and TAKE LED are blinking.
Auto Punch Take mode	Only the TAKE LED (red) is lit.
Auto Punch Rehearsal mode	Only the REHEARSAL LED (green) is lit.
Rehearsal mode entered by means of MMC or foot switch	Only the REHEARSAL LED (green) is blinking.

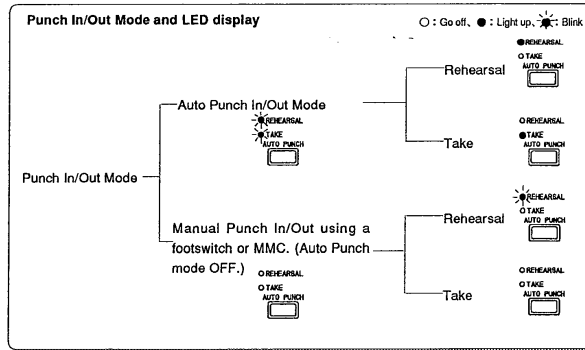

■ Refer to page "69" for more information about the Punch In/Out.

25. Paste key [PASTE]

Press this key to paste data that has been copied to the clipboard to a location stored at the AUTO PUNCH IN key. A destination track to which data is pasted is identical to the source track.

<Note>

This key is activated only when the recorder transport section is stopped.

■ Refer to page "85" for more information about the Paste operation.

26. Erase key [ERASE]

This key has two functions: the Erase function, which erases data (creates silence) within a specified region on the readied track. The other is the Cut function, which cuts data from the region beginning at the specified point. Pressing this key when all tracks are ready will activate the Cut function. Pressing this key while one or more tracks are safe will activate the Erase function.

A region to be erased is defined between the Auto Punch In point and the Auto Punch Out point. A region to be cut is defined only by the Auto Punch In point. This Cut operation requires only the start point of the region to be cut, that is, the Auto Punch In point.

<Note>

This key is activated only when the recorder transport section is stopped.

■ Refer to page "89" for more information about the Erase/Cut operation.

27. Locate key [LOCATE]

Press this key to locate a data point.

The DMT-8 will locate the point stored in the CLIPBOARD IN/OUT key, AUTO PUNCH IN/OUT key, or AUTO RTN START/END key when you press the corresponding key and then press the LOCATE key.

The LOCATE key has a memory and stores the previously-located point. Therefore, you only need to press this key to locate the same point repeatedly.

To check the memory of the LOCATE key, press the RECALL key, then the LOCATE key. You can also store a locate point by pressing the STORE key, then the LOCATE key after you edit data using the JOG dial and/or the HOLD/> key.

When you turn off the power to the DMT-8, the memory will be reset to the factory default setting.

■ Refer to page "79" for more information about the Locate function.

18. Undo key [UNDO]

After using an edit function such as Paste, Erase, or Cut, or after auto punch in/out recording, pressing this key will restore the previous status obtained before editing or recording. This key is activated only when the recorder transport section is stopped.

■ Refer to page "74", "88", "90" and "91" for more information about the Undo operation.

29. Redo [REDO]

Pressing this key after you press the UNDO key lets you to restore the status obtained before you undo recording or editing. This key is activated only when the recorder transport section is stopped.

■ Refer to pages "74", "88", "90" and "91" for more information about the Redo operation.

30. Display Select key [DISP SEL]

This key is used to change the display mode. Pressing this key repeatedly will change the display mode as follows:

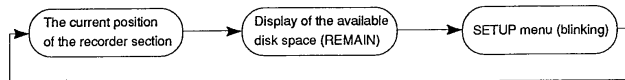

■ Refer to page "29" for more information about the REMAIN.

■ Refer to page "92" for more information about the SETUP mode.

Pressing this key while holding down the EXECUTE key will switch the Time Base (*) as follows. The Time Base can be set when the display shows the recorder's current position or the available disk space (REMAIN).

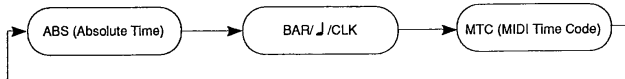

(* Time Base:

The DMT-8 uses time display (ABS or MTC) or Bar/Beat/Clock display to indicate the current position of the recorder section. These displays are called "Time Base."
 ABS (Absolute Time) shows the absolute time of the disk, and MTC (MIDI Timecode) shows the relative time obtained by adding an MTC offset value to the ABS value.
 Bar/Beat/Clock (BAR/|/CLK) indicates a position within a piece of music and conforms to the MIDI clock and Song Position Pointers created on the internal Tempo Map.

■ Refer to pages "97", "107" and "108" for more information about MTC and the internal Tempo Map.

■ Refer to page "36" for more information about Timebase.

31. Execute/Yes key [EXECUTE/YES]

Press this key to execute the operation when you try to edit data on the hard disk using the edit functions such as Paste and Erase, when you put the DMT-8 into SETUP mode, or when you set the parameters in the SETUP menu.

Pressing the DISP SEL key while holding down the [EXECUTE/YES] key allows you to select the Time Base. (Refer to the explanation about the DISP SEL key.)

■ Refer to page "85" for more information about using this key for the Paste or Erase operation.

■ Refer to page "92" for more information about using this key in SETUP mode.

32. Exit key/No key [EXIT/NO]

Contrary to the EXECUTE/YES key, this key is used to stop the operation.

■ Refer to page "85" for more information about using this key for the Paste or Erase operation.

■ Refer to page "92" for more information about using this key in SETUP mode.

33. Auto Punch In key [AUTO PUNCH IN]

This key stores the Punch In point for Auto Punch In/Out recording. Pressing the RECALL key, then this key (or pressing only this key) will display data currently stored at this key, and will place the unit in Edit mode.

If you press the STORE key, then this key after editing, the edited value will be stored at this key. In addition to storing a Punch In point, this key can store the paste start point, erase start point, and cut start point. Data stored at this key can be used as a locator. When you turn off the power to the DMT-8, the memory will be set to the factory default value.

■ Refer to page "69" for more information about Auto Punch In/Out recording.

■ Refer to page "85" for more information about pasting data.

■ Refer to page "89" for more information about the Erase and Cut operations.

34. Auto Punch Out key [AUTO PUNCH OUT]

This key stores the Punch Out point for Auto Punch In/Out recording. Pressing the RECALL key, then this key (or pressing only this key) will display data currently stored at this key, and will place the unit in Edit mode.

If you pressing the STORE key, then this key after editing, the edited value will be stored at this key. In addition to storing a Punch Out point, this key can store the erase end point. Data stored at this key can be used as a locator.

When you turn off the power to the DMT-8, the memory will be set to the factory default value.

- Refer to page "69" for more information about Auto Punch In/Out recording.
- Refer to page "89" for more information about the Erase operation.

35. Auto Return Start key [AUTO RTN START]

This key stores the Start point for Auto Return or Auto Repeat. Pressing the RECALL key, then this key (or pressing only this key) will display data currently stored at this key, and put the unit into Edit mode.

If you press the STORE key, then this key after editing, the edited value will be stored at this key. Data stored at this key can be used as a locator.

When you turn off the power to the DMT-8, the memory will be set to the factory default value.

- Refer to page "79" for more information about Auto Return and Auto Repeat.

36. Auto Return End key [AUTO RTN END]

This key stores the End point for Auto Return or Auto Repeat. Pressing the RECALL key, then this key (or pressing only this key) will display data currently stored at this key, and will place the unit into Edit mode.

If you press the STORE key, then this key after editing, the edited value will be stored at this key. Data stored at this key can be used as a locator.

When you turn off the power to the DMT-8, the memory will be set to the factory default value.

- Refer to page "79" for more information about Auto Return and Auto Repeat.

37. Hold/Digit Move key [HOLD/>]

Pressing this key while the recorder transport is operating will hold the time value (or Bar/Beat/Clock value), display the value on the screen, and will place the unit into edit mode. (If you press this key while the recorder section is stopped, the DMT-8 will enter edit mode.) Pressing this key repeatedly allows you to select the digit (column) to edit. To cancel edit mode, press the STOP button, DISP SEL key, or EXIT/NO key.

- Refer to pages "81" and "82" in Chapter 7 for more information about using this key.

38. Store key [STORE]

This key is used to store a time value (or Bar/Beat/Clock value) to any memory key. Pressing this key, then one of the following keys will cause the data shown on the display to be stored to the memory key you pressed.

STORE key -> CLIPBOARD IN key	Data is stored as a Clipboard In point. The stored data can be used as a locator.
STORE key -> CLIPBOARD OUT key	Data is stored as a Clipboard Out point. The stored data can be used as a locator.
STORE key -> AUTO PUNCH IN key	Data is stored as an Auto Punch In point. The stored data can be used as a locator.
STORE key -> AUTO PUNCH OUT key	Data is stored as an Auto Punch Out point. The stored data can be used as a locator.
STORE key -> AUTO RTN START key	Data is stored as an Auto Return Start point. The stored data can be used as a locator.
STORE key -> AUTO RTN END key	Data is stored as an Auto Return End point. The stored data can be used as a locator.
STORE key -> LOCATE key	Data is stored as a LOCATE key data.

After pressing this key, if you change your mind and wish to cancel the store operation, press the EXIT/NO key, DISP SEL key, or STOP button.

- Refer to page "85" for more information about the clipboard.
- Refer to page "79" for more information about the Locate function.
- Refer to page "69" for more information about Auto Punch In/Out recording.
- Refer to page "80" for more information about Auto Return.

39. Recall key [RECALL]

Press this key to recall the stored time value (or Bar/Beat/Clock value). Pressing this key, then one of the following keys will display the data stored at the key you pressed, and you will be able to edit the data.

RECALL key -> CLIPBOARD IN key	The Clipboard In point is recalled and the unit enters edit mode.
RECALL key -> CLIPBOARD OUT key	The Clipboard Out point is recalled and the unit enters edit mode.
RECALL key -> AUTO PUNCH IN key	The Auto Punch In point is recalled and the unit enters edit mode.
RECALL key -> AUTO PUNCH OUT key	The Auto Punch Out point is recalled and the unit enters edit mode.
RECALL key -> AUTO RTN START key	The Auto Return Start point is recalled and the unit enters edit mode.
RECALL key -> AUTO RTN END key	The Auto Return End point is recalled and the unit enters edit mode.
RECALL key -> LOCATE key	The Locate key data is recalled and the unit enters edit mode.

To exit edit mode, press the EXIT/NO key, DISP SEL key, or STOP button.

- Refer to page "85" for more information about the clipboard.
- Refer to page "69" for more information about Auto Punch In/Out recording.
- Refer to page "80" for more information about Auto Return.

40. Hard Disk Operation LED [HD ACCESS]

This LED is lit when the DMT-8 is writing data to the hard disk or reading data from the hard disk.

41. Jog/Shuttle dial

Jog dial (inside)

If you turn the jog dial when the recorder is stopped, you can perform jogging (forward and reverse digital audio scrubbing), without altering the audio quality. In edit mode, turning the jog dial will increase/decrease the value. In Setup mode, using the jog dial allows you to set the parameters.

Shuttle dial (outside)

The shuttle dial is used for the forward and reverse cueing at +/-1, 2, 3, 5, 9, 12, or 20 times speed. In edit mode, it is used to move around the digits.

- Refer to pages "71", "72", "82" and "83" for more information about the editing the memory data.
- Refer to page "92" for more information about Setup mode.

42. Record button [RECORD]

Pressing only this button places the readied tracks into input monitoring status. Pressing this button again will reset the tracks to playback monitoring. (The RECORD LED will blink when the readied tracks are under the input monitoring status.) Pressing the PLAY button while holding down this button will place the readied tracks into recording. At this time, the PLAY LED and RECORD LED will be lit, and the readied track indication will be lit steadily (instead of blinking).

■ Refer to page "35" of the "Before Starting" section for more information about input monitoring and reproduce monitoring.

43. Stop button [STOP]

Pressing this button will stop playback of the recorder section. Pressing the PLAY, REWIND, or F FWD button while holding down this button will execute the following operation:

STOP button + PLAY button	Clipboard Play operation (The STOP LED will blink, and the PLAY LED will be lit.)
STOP button + REWIND button	ABS 0 will be located.
STOP button + F FWD button	ABS END will be located.

You can turn Rehearsal mode on/off by pressing the foot switch while holding down this button for Punch In/Out recording.

Clipboard Play operation:

This operation plays from the beginning to the end of the data in the clipboard. During the operation, the track indication of the track (from which the data was copied) will blink so that you will know that the track data is on the clipboard.

Locating to ABS 0 (LOCATE ABS 0):

The DMT-8 will locate the beginning of recorded audio on the hard disk (ABS TIME: 00M 00S 00F).

Locating to ABS END (LOCATE ABS END):

The DMT-8 will locate the end of recorded audio on the hard disk (the end ABS TIME).

■ Refer to pages "35" and "36" of the "Before Starting" section for more information about ABS 0 and ABS END.

■ Refer to page "75" for more information about Punch In/Out recording using the foot switch.

44. Play button [PLAY]

Pressing this button will start playback on the recorder section. Pressing this button while holding down the RECORD button will start recording. Pressing this button while holding down the STOP button will execute the Clipboard Play operation. (Refer to the "STOP button:" section for more information about the Clipboard Play operation.)

45. Rewind button [REWIND]

Pressing this button while the recorder section is stopped will rewind data at 30 times speed. Pressing this button in Play mode will cue data (you can hear sound while rewinding) at five times speed. Pressing this button while holding down the STOP button will perform the "LOCATE

ABS 0" operation, and immediately locate the beginning of the hard disk (ABS TIME: 00M:00S:00F). (Refer to the "STOP button" section for more information about LOCATE ABS 0.)

46. Fast Forward button [F FWD]

Pressing this button while the recorder section is stopped will fast forward data at 30 times speed. Pressing this button in Play mode will cue data (you can hear sound during the fast forward operation) at five times speed.

Pressing this button while holding down the STOP button will initiate the "LOCATE ABS END" operation, and immediately locate the end of the recorded data on the hard disk (ABS END). (Refer to the "STOP button" section for more information about LOCATE ABS END.)

2-3. I/O Connector Section-1 (Front Panel)

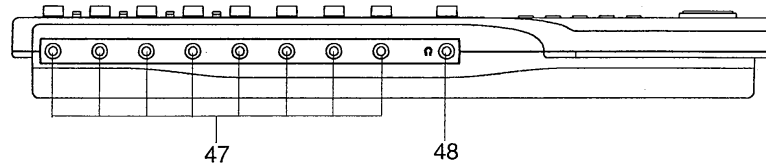

47. Input jack [INPUT 1-8] (Connector: PHONE jack)

Connect your audio source, such as a musical instrument or microphone, to these inputs. Connect the microphone to INPUTS 1-4. These inputs are equipped with TRIM faders that allow you to adjust the input level according to the output level of the connected microphone.

48. Headphone connector [] (Connector: Stereo PHONE jack)

Connect the headphones to this jack. You can control the headphone volume using the PHONES knob.

2-4. I/O Connector Section-2 (Top Panel)

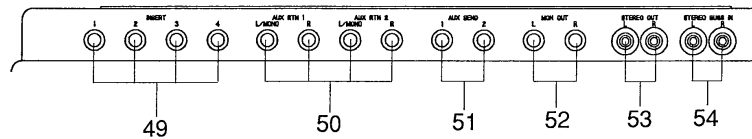

49. Insert jack [INSERT 1-4] (Connector: Stereo PHONE jack)

These connectors are used to route the Channel 1-4 input signal to the effect unit for signal processing, and apply the compressor/limiter to the signal.

■ Refer to page "40" for how to use the Insert jacks.

50. AUX Return 1, 2 jack [AUX RTN 1, 2 L/MONO, R] (Connector: PHONE jack)
 Connect these jacks to the OUTPUT jacks on the effect unit. These jacks can be used as auxiliary inputs. If the effect unit has MONO output, use the L/MONO jack. The R jack will receive the same signal.

51. AUX Send 1, 2 jack [AUX SEND 1,2] (Connector: PHONE jack)
 Connect these jacks to the INPUT jacks on the effect unit. The signal selected and level-adjusted by the AUX Send1 knob or AUX Send2 knob will be output to the effect unit.

52. Monitor Out jack [MON OUT] (Connector: PHONE jack)
 Connect a monitoring amplifier and speakers, or powered speakers here. The Stereo Bus L, R signal will be output. Use the MONITOR knob to adjust the output level.

53. Stereo Out L, R jack [STEREO OUT L,R] (Connector: RCA pin jack)
 Connect the INPUT jack of the master recorder here. The Stereo Bus L, R signal will be output. Use the master fader L/R to adjust the output level.

54. Stereo Bus In jack [STEREO BUS IN] (Connector: RCA pin jack)
 Connect the STEREO OUT jack of the external console here. Signal input here will be routed directly to the Stereo Bus L/R.

2-5. I/O Connector Section-3 (Rear panel)

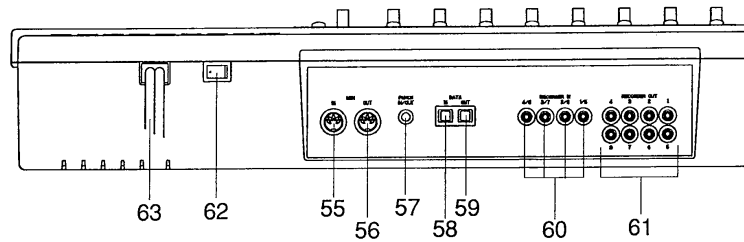

55. MIDI IN connector [MIDI IN] (Connector: DIN 5-pin)
 Connect the MIDI OUT connector on the external MIDI device here. Sending an MMC (MIDI Machine Control) signal allows you to control the DMT-8 remotely.

56. MIDI OUT connector [MIDI OUT] (Connector: DIN 5-pin)
 Connect the MIDI IN connector on the external MIDI device here. This connector will output MTC (MIDI timecode) / MMC (MIDI Machine Control) response / MIDI clock.

57. Data In connector [DATA IN] (Connector: Optical)

Connect the optical output connector of a DAT machine here.

■ Refer to page "101" for more information about loading song data.

58. Data Out connector [DATA OUT] (Connector: Optical)

Connect the optical input connector of the DAT machine. This connector is usually used to save song data created on the DMT-8 (audio data and setup data) to the digital master recorder (DAT).

During any operations other than save and load, analog output signal at STEREO OUT L/R will be digitized and output from this connector.

■ Refer to page "101" for more information about saving song data.

59. Punch In/Out jack [PUNCH IN/OUT] (Connector: PHONE jack)

Connecting the optional foot switch will let you control punch In/Out (and rehearsal) recording. Use a Fostex Model 8051 foot switch.

■ Refer to page "75" for information about Punch In/Out recording using the foot switch.

60. Recorder In jack [RECORDER IN] (Connector: RCA pin jack)

These connectors are used to send an external signal directly to the recorder section when you are using the recorder section independently. The signal will be sent to two tracks simultaneously: the input signal at RECORDER IN 1/5 is routed to Tracks 1 and 5, the input signal at 2/6 is routed to Tracks 2 and 6, and so on.

Connect the OUTPUT jack of the external console here.

■ Refer to page "68" for information on using only the recorder section.

<Note>

If a plug is connected to this jack, input signal at this jack will have priority, and recording signal will not be routed via the GROUP MASTER controls.

61. Recorder Out jack [RECORDER OUT] (Connector: RCA pin jack)

These analog connectors are used to output Track 1-8 signals directly. When you are using the recorder section independently, connect the INPUT jack of the external console here.

■ Refer to page "68" for information on using only the recorder section.

62. Power switch

This switch turns the main power to the DMT-8 on/off.

<Warning!>

Before turning the power off to the DMT-8, first quit Setup mode and make sure that the recorder section is stopped. Especially, never attempted to turn off the power to the unit while the hard disk is accessing data (the HD ACCESS LED is lit or flashing). Otherwise, not only will you lose recorded data, but you may damage to the unit.

63. Power cable

Connect the power cable to an AC outlet of the specified voltage.

2-6. Display Section

The display of the DMT-8 integrates the level meter of a high-visibility FL tube with a time display of 10 digits and 7 segments.

The level meter shows the Track 1-8 output level of the recorder section and the Stereo L/R output of the mixer section simultaneously. The time display shows the current time of the recorder section using ABS TIME (Absolute time), MTC (MIDI timecode), or MIDI BAR/BEAT (bar/beat).

This display also shows the messages required for interactive operation. The following section explains the display functions and provides with some examples.

Display shown when the power is turned on

When you turn on the power to the DMT-8, the display shows "in it L," "wait" (Initializing. Please wait.), and the time display shows the time using the time base (ABS, MTC, or BAR/BEAT/CLK) that was selected before the power was turned off.

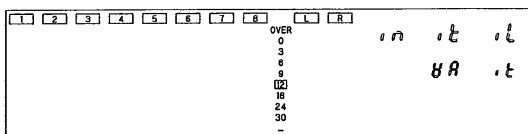

1. Preset display

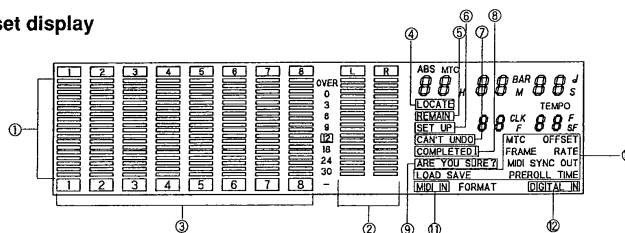

1. Level meter

The level meter shows the recorder output level and the recording level for Tracks 1-8.

2. Level meter 2

The level meter shows the Stereo Out L/R output level of the mixer section.

3. Track indication

The track indication blinks when the corresponding track is ready. It turns off when the track is safe, and is lit during recording.

4. LOCATE

This appears when the DMT-8 enters edit mode, telling you that pressing the LOCATE key will cause the point to be located.

5. REMAIN

Refer to "2. Switching the display using the DISP SEL key."

6. SETUP

Refer to "2. Switching the display using the DISP SEL key."

7. CAN'T UNDO

If you try to perform Auto Punch In/Out recording after the DMT-8 enters Auto Punch In/Out mode, this message appears to warn you that you will be unable to undo the recording even if you can record, because there is not enough Undo area on the disk.

8. COMPLETED!

This message indicates that an operation such as copy and paste has been completed.

9. ARE YOU SURE?

This message is shown to confirm whether or not you wish to execute a certain operation.

10. LOAD, SAVE, FORMAT, MTC OFFSET, FRAME RATE, MIDI SYNC OUT, PREROLL TIME, TEMPO, BAR, J

When the DMT-8 enters Setup mode, the preceding words appear as names for the parameters being set.

11. MIDI IN

This indication lights up when the DMT-8 receives effective MIDI messages from an external MIDI device.

12. DIGITAL IN

This indication lights up when the DMT-8 is receiving a digital signal properly at the DATA IN connector while loading data from a DAT machine. If this indication is blinking, the digital signal is not being received correctly.

2. Switching the display using the DISP SEL key.

Let's assume that you turned off the power while the time display was using a time base of "ABS," and then you turned the power on again. The DMT-8 time display will again use a time base of "ABS."

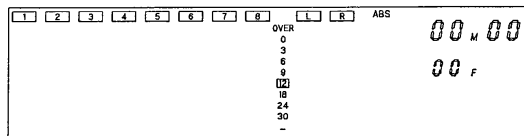
ABS TIME display

At this time if you press the DISP SEL key, the Disk Remain display (available recording time on the recorder) will appear.

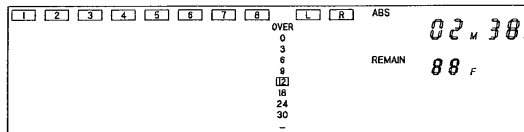
DISK REMAIN display

If "BAR/J/CLK" is selected for the timebase (explained later), the DISK REMAIN indication will show a value (in terms of the number of measures) calculated based on the last beat/tempo data on the tempo map of the recorded song.

When you press the DISP SEL key again, the Setup mode display will appear. At this time, the DMT-8 has not entered Setup mode. To put the DMT-8 into Setup mode, press the EXECUTE/YES key. After pressing the EXECUTE/YES key, if you wish to go back to the previous status, press the EXIT/NO key.

Setup mode display

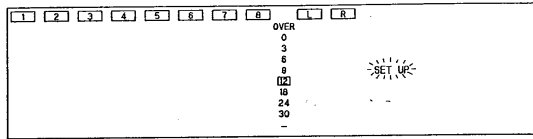

When you press the DISP SEL key again, the screen returns to the "ABS TIME" display.

3. Switching the Time Base display using the EXECUTE/YES key and DISP SEL key

When the screen is showing the ABS TIME or REMAIN display, if you press the DISP SEL key repeatedly while holding down the EXECUTE/YES key, the TIME BASE display will change cyclically. You can select one of the following Time Base displays.

ABS (Absolute Time)

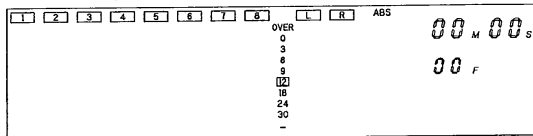

BAR/BEAT/CLK (Bar/Beat/Clock)

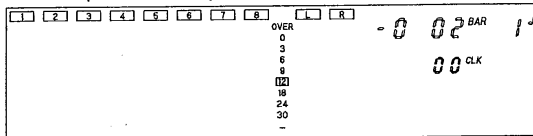

MTC (MIDI Timecode)

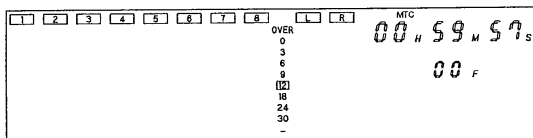

4. Warning messages

The following warning messages appears automatically when you operate the DMT-8 incorrectly, input invalid or improper data, or when their errors occur:

Invalid data indication (The input data is not appropriate for the operation).

Action to take:

Input correct data.

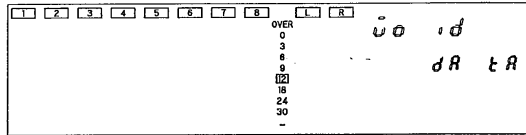

Invalid In/Out indication (The In or Out points is not appropriate for the operation).

Action to take:

Input correct data.

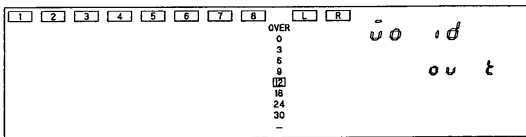
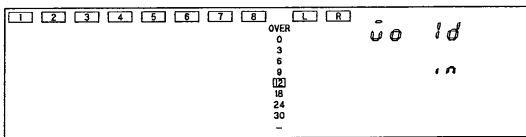

Overtime indication (The available disk space is insufficient for the length of time (the number of measures) indicated on the display.)

Action to take:

During the paste operation, try to shorten the length of the copied data by the indicated amount. Alternatively, use the "CUT" function to move the ABS END point backward to obtain enough disk space for editing.

During Auto Punch In/Out mode, shorten the length of data between the In and Out points, or move the ABS END point backward.

If this warning message appears when you start Auto Punch In/Out mode, the message will automatically disappear and the display will show the next message "CAN'T UNDO." This message means that if you try to punch in record, you will be able to record but unable to undo the recording due to insufficient undo space on the disk. If you wish to see the overtime indication again, press the AUTO PUNCH IN/OUT key again.

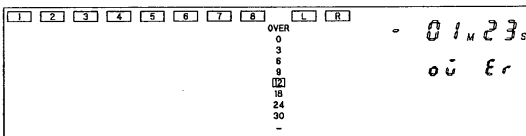

Unassigned track indication (Select any track)

Action to take:

Use the RECORD TRACK select key to ready any track.

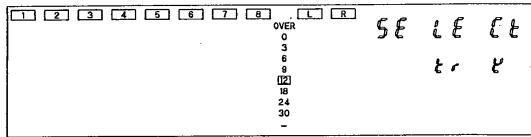

Event overflow indication (The editing points are overflowed)

Action to take:

You edited too much. The warning means "you cannot paste or erase any more."

In this case, first use the "SAVE" function from the Setup mode to save data to an external DAT machine, then load the data back to the DMT-8. In this way, the editing points will be cleared and you will be able to continue editing.

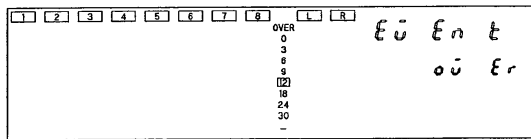

Load error indication (You cannot load data because the data input to the DATA IN connector contains an error)

Action to take:

Check to see if there is an abnormality with the external DAT machine connected to the DATA IN connector or with the DAT type itself. Try to "LOAD" again.

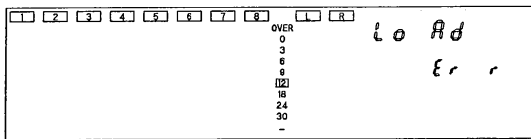

Un-formatted indication (The internal hard disk is damaged or not formatted yet.)

After this message is shown for about 10 seconds, "FORMAT" in Setup mode will flash on the display. Pressing the EXECUTE/YES key at this moment will erase all data and reformat the hard disk.

Action to take:

Press the EXECUTE/YES key to format the disk. (All audio and other data on the disk will be lost.)

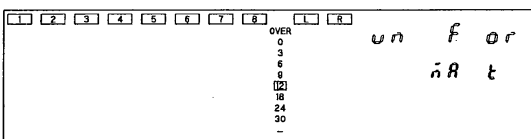

Disk error indication (This disk cannot be read)

Action to take:

Contact the Fostex service station as soon as possible.

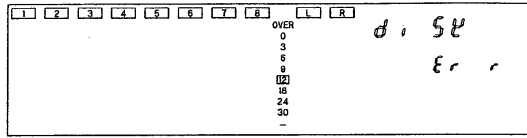

Error indication (Internal error occurred)

Action to take:

Stop the operation, and inform the Fostex service station of the error message number.

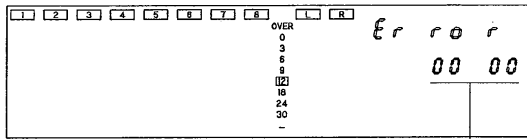

Displayed "ERROR No."

Chapter 3

Before Starting (Glossary)

This chapter explains the following items with which you should become familiar prior to operating the DMT-8:

1. Difference between track and channel
2. Difference from a tape MTR
3. Input monitor and repro monitor
4. Timebase
5. Three bus lines
6. Alternate Mix function
7. Group Assign switch and Group Panpot
8. Effect connection 1 (Using AUX)
9. Effect connection 2 (Using the INSERT jack)
10. Parametric Equalizer

3-1. Difference between track and channel

The terms "track" and "channel" can sometimes be confusing. In this manual, they are differentiated as follows:

Channel:

"Channel" is used to define the input and output system on the mixer section (e.g., the bass signal routed to Channel 1 is output from Channel L.)

Track:

"Track" is used to define the input and output system in the recorder section (that is, the hard disk on the DMT-8) e.g., Ping-pong record playback signal on Tracks 1, 2, and 3 to Track 4.

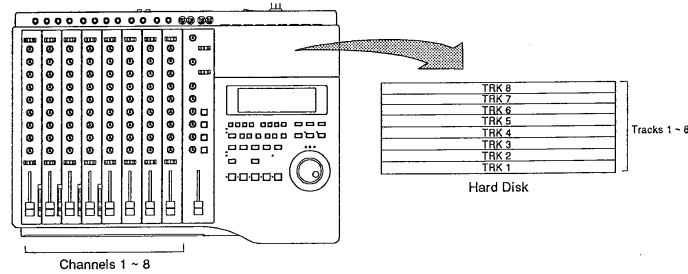

3-2. Difference from a tape MTR

The DMT-8 uses a hard disk as a recording media. Therefore, the concept of recording and playback on the DMT-8 is somewhat different from that of conventional tape MTR. As shown in the diagram below, you can play a tape from the beginning to the end of the tape. On the DMT-8, you can play data only between the ABS time (absolute time) "0" and the End point (the end of recording).

If we use the analogy of a tape recorder, the DMT-8 would have a tape with a maximum of 12.5 minutes. For example, the tape recorder would have a five-minute tape after a five-minute recording, and a six-minute tape if the recording lasts six minutes.

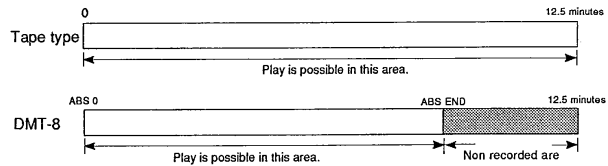

3-3. Input monitor and Repro monitor

There are two ways to monitor track data on the recorder: Input monitor and Repro monitor. These are defined as follows:

Input monitor:

Input monitoring enables you to listen to the input signal that is routed to and output through the tracks just as it is. That is, listening to (monitoring) the post-recorder input signal (not the pre recorder signal). Eight tracks on the DMT-8 can be set to either "Input monitoring" or "Repro monitoring" status. Follow the steps below to set the tracks to Input monitor.

1. Set the track to recording status.

To set the track to recording status, first ready the track, then press the PLAY button while holding down the RECORD button. At this time, the recording track is in Input monitoring status.

Alternatively,

2. Ready the track, and press the RECORD button once. (If you press the RECORD button again, the track enters the repro monitoring status.)

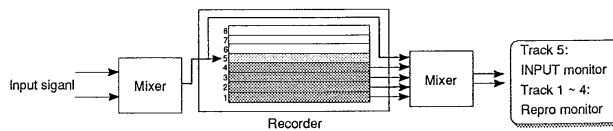

At this time, the RECORD LED next to the RECORD button will flash, and the currently selected tracks will enter input monitoring status.

Repro monitor:

Repro monitoring enables you to monitor the playback signal on the tracks; that is, to listen to the output of the recorded signal.

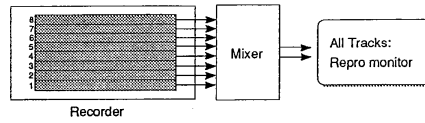

3-4. Timebase

The DMT-8 indicates the location of the recorder (the current position) using the ABS time, MTC, or MIDI Bar/Beat/Clock. This time reference is called "timebase." ABS (Absolute Time) refers to an absolute time on the hard disk; MTC (MIDI timecode) refers to a relative time obtained by adding a certain value (MTC offset value) to the ABS value; and BAR/BEAT/CLK (bar/beat/clock) indicates a position in a song that corresponds to the MIDI Clock/Song Position Pointer and can be created using the internal Tempo Map. (The following diagram shows the relationship between the three types of timebase.)

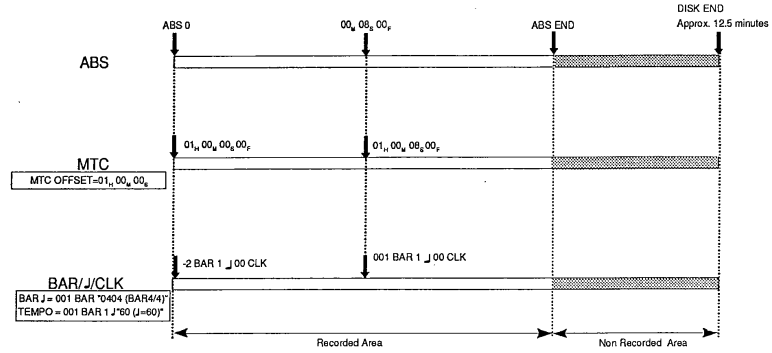

3-5. Three bus lines

The DMT-8 mixer section has an internal path called a "bus line" in which signals are mixed. Using an analogy, you could consider the eight INPUT jacks "branches", and the bus line as a "main stream." There are the following three bus lines on the DMT-8, and the following signals are mixed on these bus lines:

Group Bus: (Recording signal is routed to the Group Bus.)

Group Bus consists of four lines (G1-G4), where the signal sent to the INPUT faders and the signals returning from the effect unit are mixed. The mixed signal is then converted to digital and recorded to the specified tracks. This mix signal can be routed to the Stereo Bus for mixdown. (Refer to the explanation on the operation of the GROUP TO L/R switch.)

Stereo Bus: (Signal not to be recorded (only for the purpose of monitoring) is routed to the Stereo Bus.)

There are two Stereo Bus lines (L and R), where the signal sent to the SUB mix section, the signal returning from the effect unit, and the signal from the Group Bus are mixed.

The signal mixed in the Stereo Bus is output from the STEREO OUT jack, and at the same time converted to digital (S/P DIF format) and output from the DATA OUT connector to the master recorder. The signal mixed in the Stereo Bus is also output from the MON OUT and PHONES jacks.

AUX Bus: (Route the signal to the AUX Bus to apply effects.)

There are two AUX Bus lines (AUX 1 and AUX 2). These are used to apply effects to the signal routed to the INPUT faders or the signals routed to the SUB mix section.

The signal mixed in the AUX Bus is sent to an external effect unit via the AUX SEND 1 or AUX SEND 2 jacks, then effects are applied, and the signal is returned to the Stereo Bus L/R or Group Bus from the AUX RTN 1 or AUX RTN 2 jack.

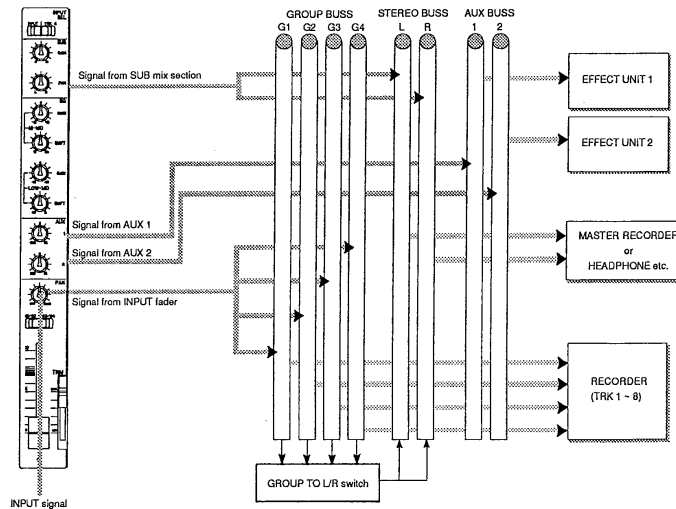

3-6. Alternate Mix function

The DMT-8 is equipped with a SUB mix section that is like a twin brother of the channel INPUT faders. Usually a signal (from the INPUT jacks, or the recorder output signal) is routed to these two sections (INPUT faders and SUB mix section). Depending on your purposes, you can switch and select one of these signals to the INPUT faders or the SUB mix section. This function is called the "Alternate Mix" function. Use the INPUT SEL switch to select the signal. (Refer to the table below.)

This Alternate Mix function allows you to use the SUB mix section as a monitoring section when the INPUT SEL switch is set to "INPUT." When "TRK" is selected, you can perform mixdown on up to 16 channels by syncing the MIDI device.

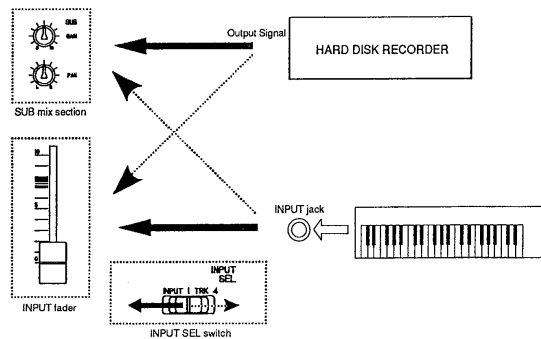

3-7. Group Assign switch and Group Panpot

The Group Assign switches and Group panpot of each channel of the DMT-8 mixer section function as a guide to the Group Bus. The input signal at the INPUT jack is distributed to G1-G4 by means of these switches and panpot settings, and is recorded on the tracks.

The Assign switch selects a combination of the Group Buses (G1/G2 or G3/G4). Then, the PAN setting determines the signal destination: odd-numbered bus (ODD: G1 or G3), or even-numbered bus (EVEN: G2 or G4). (If you set PAN to the center, the same level of the signal will be sent to odd-numbered and even-numbered buses.)

The GROUP MASTER control adjusts the level of the signal sent from the Group Bus to the recorder, and the RECORD TRACK select key selects the recording track.

Send to GROUP BUS 1	Send to GROUP BUS 2	Send to GROUP BUS 3	Send to GROUP BUS 4	Send to GROUP BUS 1 and GROUP BUS 2 with the same level.	Send to GROUP BUS 3 and GROUP BUS 4 with the same level.
01/02 03/04	01/02 03/04	01/02 03/04	01/02 03/04	01/02 03/04	01/02 03/04

3-8. Effect connection 1 (Using AUX)

The DMT-8 is equipped with two sets of AUX send (mono out)/return (stereo in), allowing two effect units with mono in/stereo out to be connected. (See the figure below.)

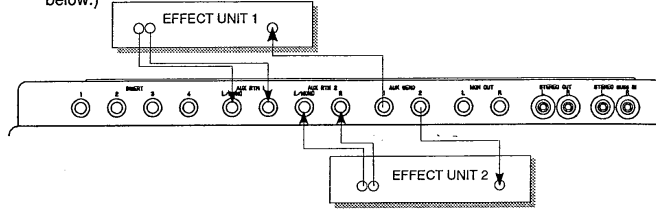

If the effect unit has a mono output, use the L/MONO connector of the AUX RTN 1 and AUX RTN 2 jacks. (When the effect unit is connected to the L/MONO jack, the same signal is input to the R jack.)

Using the AUX send control

Use the AUX send 1 and AUX send 2 controls to select and adjust the output level of the signal sent to each AUX SEND jack.

Turning the AUX send control toward "CH" will send the post fader signal at the INPUT fader to the effect unit. Turning the AUX send control toward "SUB" will send the post SUB gain signal at the SUB mix section to the effect unit.

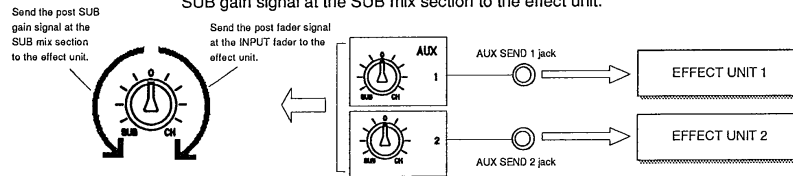

Using the AUX return control and the AUX RTN Assign switch

After the level of the effect return signal is adjusted by the AUX RTN control at the AUX RTN jack, the signal is routed either to the Stereo Bus or Group Bus depending on the setting of the AUX RTN Assign switch. (The AUX RTN 1 signal is sent to the Stereo bus or Group Bus 1/2, and the AUX RTN 2 signal is sent to the Stereo bus or Group Bus 3/4.)

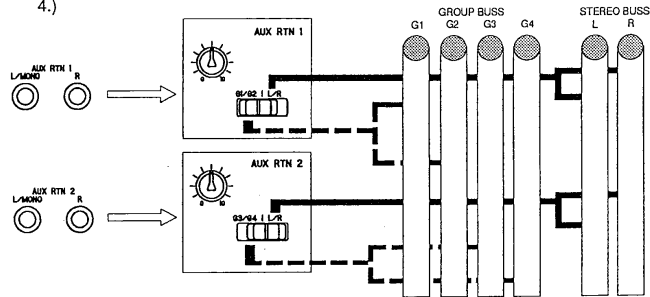

3-9. Effect connection 2 (Using the INSERT jack)

Channels 1-4, which can be used with a microphone, are equipped with the INSERT jacks for effect processing. In particular, it is very effective to apply raw sound processing effects such as a compressor/limiter or noise gate.

To connect the effect unit to the INSERT jack, prepare the following connecting cables.

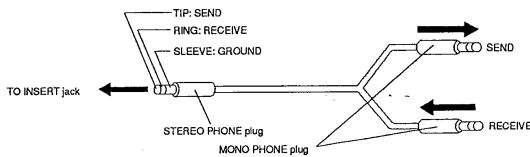

E.g.: Connecting a compressor

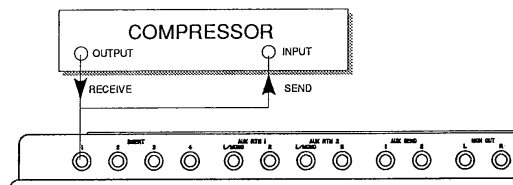

3-10. Parametric Equalizer

The DMT-8 is equipped with a two-band parametric equalizer for each INPUT channel. You can set any frequency from 60Hz through 1kHz, and from 1kHz through 16kHz, and boost or cut in the range of +/-15dB.

These equalizers are powerful tools to add color and character to the sound by adjusting the basic frequency components and harmonics which determine the tonal color of instrumental and vocal sounds.

<Notes>
 The parametric equalizers are effective only on the signal routed to the INPUT faders by the Alternate Mix function (via the INPUT SEL switch). They are not effective on signals routed to the SUB mix.

Frequency response

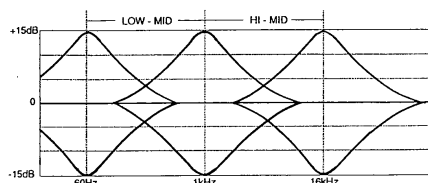

Chapter 4

Getting Started

This chapter describes the basic recording and playback procedure on the DMT-8. Basic recording is the same as that on conventional cassette tape or reel-to-reel multitracker. To get used to the DMT-8, first understand and master the basic operations described here before proceeding to the application section. You can start recording immediately since the DMT-8 hard disk has already been formatted at the factory.

4-1. The default settings on the DMT-8

Before you start operating the DMT-8 or proceed to the next step, you may want to arrange the controls and switches to restore the default settings so that you will not, for example, erase important data on a track by using incorrect settings. As default settings, the controls and switches should be arranged as shown in the figure below. Remember to make it a rule to return to these default settings before you proceed to a new step.

Default settings:

- All the INPUT fader, TRIM fader, and the Stereo Master faders, should be lowered to the minimum.
- All controls and switches should be in the center position "I" or "0."
- Turn all the GROUP TO L/R switches to "OFF." (The switches should protrude.)
- Turn all the RECORD TRACK select keys to "OFF."
- Turn all the operation/setting keys to "OFF." (The LEDs should be off.)

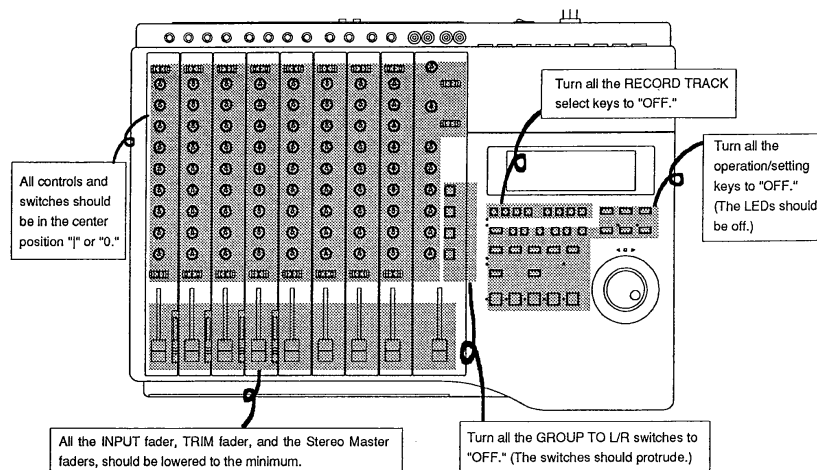

4-2. Basic recording (before starting multitrack recording)

Before you start multitrack recording, first try to record one sound source to one track. Any sound source will do. Here, as an example, we are going to connect an electric guitar to INPUT jack 1 to record the guitar sound to Track 1.

* First, set the DMT-8 to the default settings.

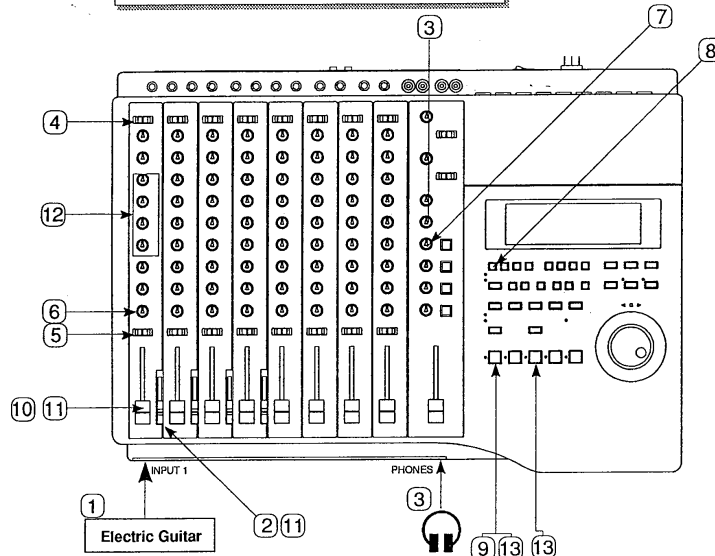

Connecting the sound source and headphone

1. Connect an electric guitar to **INPUT jack 1**.
2. Lower the **TRIM** fader to "**MIN.**" (This position will be adjusted later.)
3. Make sure that the **PHONES** control is set to "**0**" and connect the monitoring headphone to the **PHONES jack**.

Setting the switches/controls

4. Turn the **INPUT SEL** switch to "**INPUT.**"
The electric guitar signal will be routed to the **INPUT** fader.
5. Set the **Group Assign** switch to "**G1/G2.**"
The electric guitar signal will be routed to **Group 1/2**.
6. Turn the **Group PAN** control all the way to "**ODD.**"
The electric guitar signal will be routed to **Group 1**.
7. Turn the **GROUP MASTER** control **G1** to "**7-8.**"
The master volume level of the electric guitar at **Group 1** will be raised.
8. Press the **RECORD TRACK** select **1/G1** switch to ready **Track 1**. (**1** on the display will blink.)

Monitoring the recording signal

9. Press the **RECORD** button. (The RECORD LED will blink.)

The readied track (Track 1) enters input monitoring status. That is, the electric guitar signal sent to Track 1 via Group 1 is "throughput" from Track 1 output. Track 1 output is sent to Channel 1 SUB mix section due to the setting in step 4. Raising the SUB GAIN level will allow you to monitor the electric guitar sound through the headphones.

This signal is sent to the Stereo Bus L/R by the SUB PAN control. Raise the Master fader L/R to 7-8 (the Master fader controls the master volume level of the Stereo Bus L/R). Also, adjust the SUB PAN control and PHONES control to a desirable stereo position and volume level respectively (these settings do not affect the recording level). *The headphones (and MON OUT) always output the Master fader L/R signal.

Adjusting the recording level

10. Raise the INPUT fader to "7-8," and check the recording level on the level meter 1 while playing the electric guitar.

Adjust the TRIM control so that the meter approaches level "0" at a peak volume (and "OVER" will not be lit). If the level is too low, raise the TRIM level gradually.

If you have connected a microphone or other low output sound source, instead of a line-output source such as an electric guitar, you may want to raise the TRIM level up nearly to the "MAX" position.

11. If the level is still too high even if the TRIM is lowered to "MIN," lower the INPUT fader below "7-8."

12. Adjust the equalizer, if necessary.

If adjusting the equalizer has changed the level, adjust the INPUT fader again.

<Summary of level adjustment>

1. Use Input Monitoring to monitor and adjust the level of the signal.
2. Use the SUB Mix section and Master fader L/R to monitor the signal. (You can listen to the signal at the Master fader L/R through the headphones.)
3. Set the GROUP MASTER control to "7-8."
4. Adjust the TRIM (to a lower level for a line source, or to a higher level for a microphone source), then adjust the INPUT fader.
5. If equalization has changed the level, adjust it using the INPUT fader again.

Start recording

13. Press the **PLAY** button while pressing and holding down the **RECORD** button.

The blinking RECORD LED and track indication [1] will light up, indicating that the recorder section has entered recording mode. (The recording track, Track 1 in this example, is always in the Input Monitoring status.)

Finish recording

You can record for about "12.5 minutes."

To end recording, press the **STOP** button. At the same time, the Input Monitoring status will be cancelled, and the recorder will enter playback monitoring status. (The RECORD LED will go off.)

<Note>

Press the STOP button immediately to finish recording when your performance is complete. If recording mode continues after your performance is finished (as occurs sometimes on tape MTRs), the editing functions (such as Paste and Erase) may be restricted. Refer to pages "31" and "85" for details.

In addition to recording sound from INPUT jack 1 to Track 1, you can also record data from any INPUT jack to any track. The table below shows some quick setting hints. Try recording to see how and where the input signal is routed and recorded. (You can use the same settings regardless of which INPUT jack (of Channels 1-8) is connected to the source.)

Playback

You can play back data you just recorded using the procedure below:

































1. Press the **REWIND** button while holding down the **STOP** button.
The DMT-8 will locate the beginning of the hard disk immediately using the LOCATE ABS 0 operation.
2. To prevent accidental recording, turn the RECORD TRACK key 1/G1 "OFF." (The track indicator will change from blinking to off.)
3. The INPUT SEL switch should stay at "INPUT."
As before, the signal from Track 1 is routed to Channel 1 SUB mix section.
4. Press the **PLAY** button to start play back.
Currently Track 1 is in playback monitoring status. Track 1 output (at Channel 1 SUB mix) is the actual recorded sound, not the signal being input.
5. Adjust the volume level using the SUB GAIN control, and adjust the panpot using the SUB PAN control. Raise the Master fader L/R to "7-8." Adjust the headphone volume level using the PHONES knob.

<Note>

When you are monitoring the sound for a long period of time, do not raise the phone level too high. Otherwise, you could damage your hearing.

Hints

When the INPUT SEL switches are set to "INPUT," the track output signal is routed to the SUB mix section of the same channel number as the track number. That is, Track 1 signal is sent to Channel 1 SUB mix section, Track 8 signal is sent to Channel 8 SUB mix section, etc. In this way, you can monitor Track 1-8 output signals without affecting the INPUT fader 1-8 settings for sound sources.

Recording Track	Setting of the RECORDER section	Setting of the MIXER section (channel 1 ~ 8)		
	REC TRACK select key	Group ASSIGN switch	Group PANPOT knob	GROUP MASTER knob
Track 1				
Track 2				
Track 3				
Track 4				
Track 5				
Track 6				
Track 7				
Track 8				

4-3. Multitrack recording using overdubbing

Now you should understand how to record a sound source to a specific track, as well as the basic signal flow and switch/control functions on the DMT-8.

Here, we will make a multitrack recording.

Multitrack recording is a series of operations in which you record sound sources to multiple tracks and combine these recordings into two mixes (L, R). In this process, the most important step is "overdubbing."

"Overdubbing" means to record a new sound source to another track using input monitoring, while listening to the playback of the pre-recorded sound (that is, playback monitoring).

Step 1: Recording a drum machine to Track 1

Refer to the "Basic Recording" section to record the drum machine to Track 1.

Hint 1: Stereo recording of a drum machine

If you wish to record a drum machine in stereo, not in monaural, you can just record the L signal to Track 1 and the R signal to Track 2. Follow the settings described below:

<Channel 1 setting>

Connect the L output jack of the drum machine to the INPUT jack 1 of the DMT-8.

INPUT SEL switch: "INPUT"

GROUP Assign switch: "G1/G2"

GROUP PAN control: Turn all the way to "ODD."

SUB mix: Use the GAIN control to adjust the L channel monitoring level. Set the PAN control to all the way to the left.

INPUT fader and TRIM: accordingly

<Channel 2 setting>

Connect the R output jack of the drum machine to the INPUT jack 2 of the DMT-8.

INPUT SEL switch: "INPUT"

GROUP Assign switch: "G1/G2"

GROUP PAN control: Turn all the way to "EVEN."

SUB mix: Use the GAIN control to adjust the R channel monitoring level. Set the PAN control all the way to the right.

INPUT fader and TRIM: accordingly

<Recorder setting>

RECORD TRACK select key: Turn "1/G1" and "2/G2" on.

<Master setting>

GROUP MASTER control: Set G1/G2 to "7-8."

Master fader L/R: Set to "7-8."

Hint 2: Applying reverb to the snare sound

If you have a drum machine that has parallel outputs, it may be a good idea to apply reverb to the snare sound before recording the sound to Tracks 1 and 2. It is very effective to use the AUX function of the DMT-8 to apply ambience effects such as reverb. (Refer to the section "Step 4: overdubbing the vocal sound to Track 4" or "Mixdown" for more information on the AUX function.) You can refer to the settings below:

<Channel 1 setting>

Same as Hint 1.

<Channel 2 setting>

Same as Hint 1.

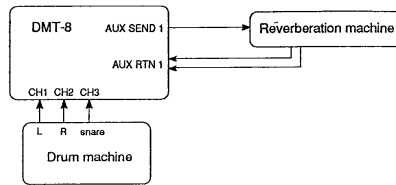

<Channel 3 setting>

Connect the snare output of the drum machine to the INPUT jack 3 of the DMT-8.

INPUT SEL switch: "INPUT"

GROUP Assign switch: "G1/G2"

GROUP PAN control: Center (The snare sound is centered between "ODD" and "EVEN.")

SUB mix: Set the GAIN control to "0."

INPUT fader and TRIM: accordingly

<Channel 3 AUX setting>

AUX 1 control: Turn the knob toward "CH" (clockwise) to adjust the reverb amount.

<Master settings>

AUX RTN 1 control: Set this knob to "10" (all the way to the right, which is the standard level).

AUX RTN 1 Assign switch: "G1/G2" (to record the sound and effect at the same time).

GROUP MASTER control: Set G1/G2 to "7-8."

Master fader L/R: "7-8"

Step 2: Overdubbing an electric bass to Track 2

Now, we are going to overdub. Assume that you have recorded the drum machine to Track 1 in monaural, and we are recording the bass to Track 2 while monitoring the drum sound.

** Set the DMT-8 to the default settings. Make sure that you have set Track 1 as a safe track. (The track indicator will go off.)*

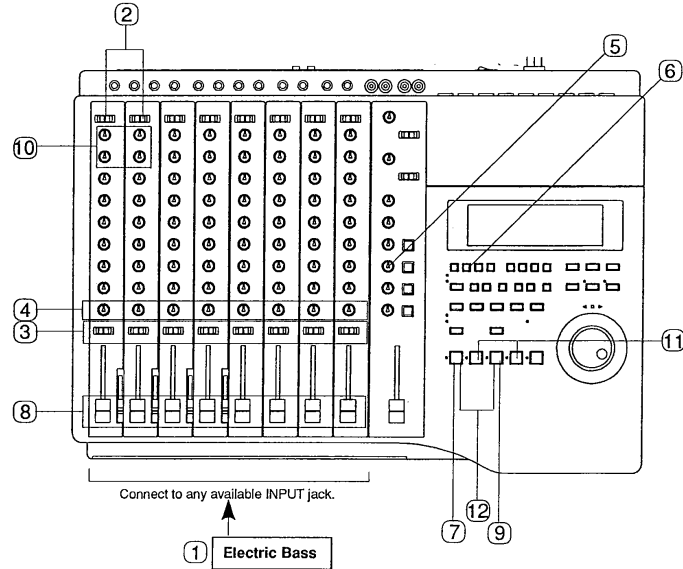

Connecting the sound source

1. Connect the electric bass to any available **INPUT jack**.

If you connect the bass to Channel 1-4, lower the TRIM fader to the "MIN" position, as we did in the basic recording.

Hints:

If you wish to apply the compressor/limiter to the bass sound to record a dynamic sound, connect the bass to any INPUT jack 1-4. INPUT jacks 1-4 are equipped with an INSERT connector that can be used to connect an effect unit (dynamic effect unit) such as compressor/limiter, noise gate, etc. Refer to the figure below for information on connecting the effect unit.

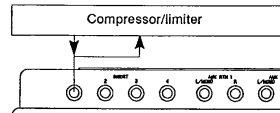

See the section regarding Using the INSERT jack of "Before Starting" for information on connecting cables.

Switch/control settings

2. Set the INPUT SEL switch of Channels 1 and 2 to "INPUT."
Track 1 output is routed to Channel 1 SUB mix, and Track 2 output is routed to Channel 2 SUB mix. If you have connected an electric bass to any jack other than INPUT jacks 1 and 2, set the corresponding channel's INPUT SEL switch to "INPUT."
3. Set the GROUP Assign switch of the electric bass channel to "G1/G2."
4. Turn the Group PAN control of the electric bass channel all the way to "EVEN."
5. Set GROUP MASTER knob G2 to "7-8."
6. Press the RECORD TRACK select key 2/G2 to "ready" Track 2. (2 on the display will blink.)

Monitoring the recording signal

7. Press the RECORD button once. (The RECORD LED will blink.)
The readied track "2" enters input monitoring status. As we discussed in the basic recording section, set the monitoring volume level and pan position of the electric bass sound using the GAIN and PAN controls of Channel 2 SUB mix. (Set the Master fader L/R to 7-8.) These settings will not affect the recording level.

Adjusting the recording level

8. Raise the INPUT fader of the electric bass channel to "7-8," check the level on the meter "2", and use the TRIM, INPUT fader, and equalizer to create a desirable tonal color and level. (This is the same step as in the basic recording section.)

Practicing overdubbing

Now, we are going to play back the drum sound on Track 1 and monitor the sound in conjunction with the electric bass sound.

9. Press the PLAY button to start the recorder.
10. Adjust the monitoring volume level and stereo position of Track 1 (drum machine) playback sound (playback monitoring) at Channel 1 SUB mix, and adjust the monitoring level and panpot of the electric bass sound (Track 2 input monitoring sound) at Channel 2 SUB mix. You can practice your performance with these settings as many times as you like.

Start/stop recording

If you are satisfied with your rehearsal, start recording.

11. Press the REWIND button while holding down the STOP button to locate the ABS 0 point (the beginning of the hard disk).
12. Press the PLAY button while holding down the RECORD button.
The drum machine sound on Track 1 will be played back with the monitor balance setting specified in the previous step. Play the electric bass to overdub the bass sound on Track 2.
13. When completed, press the STOP button to stop recording.
The RECORD LED goes off, and Track 2 enters playback monitoring status.

Playback

1. Press the **REWIND** button while holding down the **STOP** button.
The DMT-8 locates ABS 0: the beginning of the hard disk.
2. To prevent accidental recording, turn the **RECORD TRACK** select key 1/G1 "OFF."
(The track indication will change from blinking to off.)
3. The **INPUT SEL** switch for Channels 1 and 2 should stay at "INPUT."
The playback signal on Track 1 is routed to the Channel 1 SUB mix section, and the playback signal on Track 2 is routed to the Channel 2 SUB mix section.
4. Press the **PLAY** button to start playback.
5. Set the Master fader L/R to "7-8," adjust the headphone volume level using the **PHONES** knob, and adjust each SUB mix to change the entire volume and panpot.

Step 3: Overdubbing an electric guitar on Track 3

Just as in Step 2, overdub the electric guitar on Track 3 while listening to the recorded drum machine and electric bass.

** Set the DMT-8 to the default setting. (Do not forget to set Tracks 1 and 2 as a safe track.)*

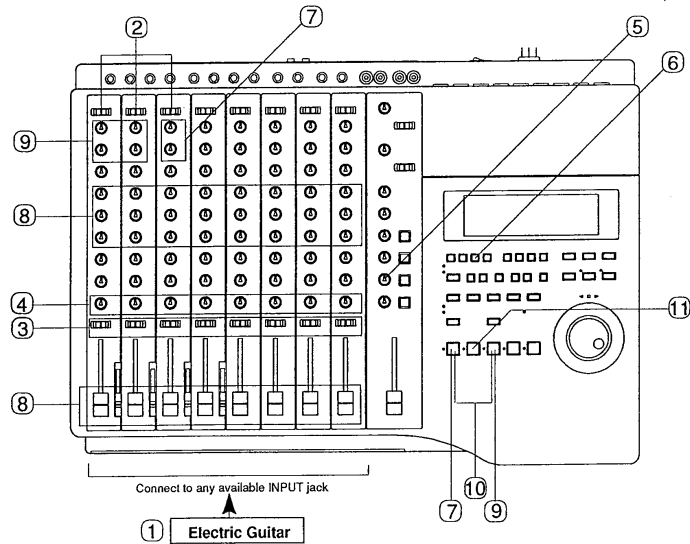

Connecting the sound source

1. Connect the electric guitar to any available **INPUT** jack.
If you connect the guitar to Channel 1-4, lower the **TRIM** fader to the "MIN" (line level) position, as we did in basic recording.

Switch/control settings

2. Set the INPUT SEL switch of Channels 1, 2, and 3 to "INPUT."
Track 1-3 output signals are routed to the Channel 1-3 SUB mix respectively. If you have connected the electric guitar to any jack other than INPUT jacks 1-3, set the corresponding channel's INPUT SEL switch to "INPUT."
3. Set the GROUP Assign switch of the electric guitar channel to "G3/G4."
The electric guitar signal will be patched to Group 3/4.
4. Turn the Group PAN control of the electric guitar channel all the way to "ODD."
The electric guitar signal will be routed to Group 3.
5. Set GROUP MASTER knob G3 to "7-8."
The volume level of the electric guitar in Group 3 will be raised.
6. Press the RECORD TRACK select key 3/G3 to "ready" Track 3. ( on the display will blink.)

Monitoring the recording signal

7. Press the RECORD button once. (The RECORD LED will blink.)
The readied track "3" enters input monitoring status. As in Step 2, set the monitoring volume level and pan position of the Channel 3 SUB mix. (Set the Master fader L/R to 7-8.) These settings will not affect the recording level.

Adjusting the recording level

8. While checking the level on meter "3", use the TRIM, INPUT fader, and equalizer to create a desirable tonal color and level.

Practicing overdubbing

9. Press the PLAY button to start the recorder, adjust the monitoring level and pan position of the electric guitar using the Channel 3 SUB mix section while listening to the playback on Tracks 1 and 2, and practice the guitar.

Start/stop recording

10. When practice is completed, press the PLAY button while holding down the RECORD button to overdub the electric guitar sound on Track 3.
11. When overdubbing is completed, stop recording by pressing the STOP button.
The RECORD LED will go off, and Track 3 enters the playback monitoring status as Tracks 1 and 2.

Playback

1. Set the RECORD TRACK select key 3/G3 to "OFF." The setting of Channel 1-3 INPUT SEL switches should stay "INPUT." Playback signals on Tracks 1-3 will be routed to the SUB mix section of Channels 1-3.
2. Press the PLAY button to start playback.
3. Try different monitor balance settings using the SUB GAIN control and SUB PAN control.

Step 4: Overdubbing the vocal on Track 4

Now, overdub the vocal on Track 4 while listening to the recorded drum sound, electric bass, and electric guitar. At this time, you can use the AUX function to apply "monitoring reverb" to the vocal sound during recording.

What is monitoring reverb?
During multitrack recording process, reverberation is usually applied during mixdown. However, you may sometimes want to monitor the sound to which reverberation is applied during overdub in order to simulate the mixdown sound. In particular, a vocal with reverberation sounds much different from a vocal without reverberation. Monitoring reverb is a technique that applies reverberation to only the monitor sound (the reverb sound will not be recorded). On the other hand, recording the original sound along with the reverberation sound on the same track is called "recording with reverb."

** Set the DMT-8 to the default settings. (Do not forget to set Tracks 1-3 as a safe track.)*

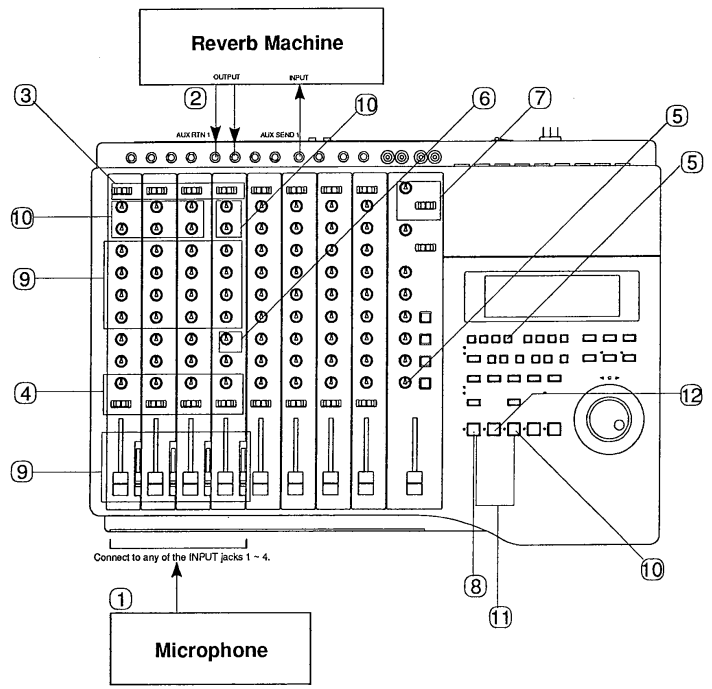

Connecting the sound source and reverb (effect) unit

1. Connect the vocal microphone to any of the **INPUT jacks 1-4**.
Lower the TRIM fader to the "MIN" position as you did in the previous steps.
2. Connect the **AUX SEND 1** jack of the DMT-8 with the **INPUT** connector of the reverb unit, and the **AUX RTN 1 L/R** jack with the **OUTPUT L/R** connector of the reverb unit. Set the reverb unit so that it will output only the effect sound (so that the original sound will not be duplicated). If the effect unit is equipped with the input/output level switch (such as +4/0/-10/-20dBV), select **"-20dBV"**, which is the rated input level of the AUX RTN 1 L/R jack of the DMT-8. If the effect unit has only monaural output, connect it to the L/MONO connector on the DMT-8.

Switch/control settings

3. Set the INPUT SEL switch of Channels 1-4 to **"INPUT."**
Track 1-4 output signals are routed to Channel 1-4 SUB mix respectively.
4. Set the GROUP Assign switch of the microphone channel to **"G3/G4."**
Turn the PAN control knob all the way to **"EVEN."**
5. Set GROUP MASTER knob G4 to 7-8. Press the RECORD TRACK select key 4/G4 to **"ready"** Track 4. (4 on the display will blink.)
6. Turn Channel 4 AUX 1 knob toward **"SUB"** accordingly.
In this way, the vocal monitoring sound is adjusted for the level at Channel 4 SUB mix section (thus, called "post SUB gain signal"), and output from the AUX SEND 1 jack.

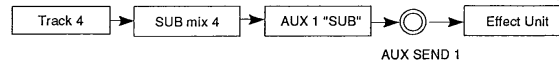

7. Set the AUX RTN 1 knob to "10" and set the AUX RTN 1 Assign switch to **"L/R."**
The signal returning from the effect unit to the AUX RTN 1 L/R jack will be routed to the Stereo Bus L/R, and you will be able to monitor the SUB mix sound (which is usually sent to the Stereo Bus L/R) through the headphones.

Monitoring the recording signal and reverb sound

8. Press the **RECORD** button once. (The RECORD LED will blink.)
The readied track "4" enters input monitoring status. As we did in Step 3, set the monitoring volume level and pan position of the vocal sound at the Channel 4 SUB mix section. (Set the Master fader L/R to 7-8.)
Fine-tune the Channel 4 AUX 1 knob (in the range of "SUB") to set the monitoring reverb level. (This setting does not affect the recording level of either the original sound or the reverb sound.) You can also use the AUX RTN 1 knob to control the return level of the reverb sound.

Adjusting the recording level

9. While checking the level on meter "4", use the TRIM, INPUT fader, and equalizer for the microphone channel to create a desirable tonal color and level.

Practicing overdubbing

10. Press the **PLAY** button to start the recorder, and adjust the monitoring level of Tracks 1-3 using the Channel 1-3 SUB mix sections. Also, adjust the monitoring

sound (original vocal sound) on Track 4 using the Channel 4 SUB mix section, and adjust the monitoring reverb level using the Channel 4 AUX 1 knob while practicing the vocal part.

Start/stop recording

11. Press the **PLAY** button while holding down the **RECORD** button to overdub the vocal sound on Track 4.
Only the original vocal sound (without reverb) will be recorded on Track 4. (Only you heard the reverberation.)
12. When overdubbing is completed, stop recording by pressing the **STOP** button.
The **RECORD** LED goes off, and Track 4 enters the playback monitoring status.

Playback

1. Set the **RECORD TRACK** key 4/G4 to "**OFF**." The setting of Channel 1-4 **INPUT SEL** switches should remain as "**INPUT**." Press the **PLAY** button.
2. You can change the volume level and pan position of the sound recorded on Tracks 1-4 at **SUB** mix sections 1-4. At this time, try to change Channel 4 **AUX 1** control setting. When it is set to "0," you will hear only the dry vocal sound, and you will notice more reverberation when you turn the control toward "**SUB**."

Now you should understand how to overdub. You can repeat this procedure for Tracks 5, 6, 7, and 8. The following figure shows the next page.

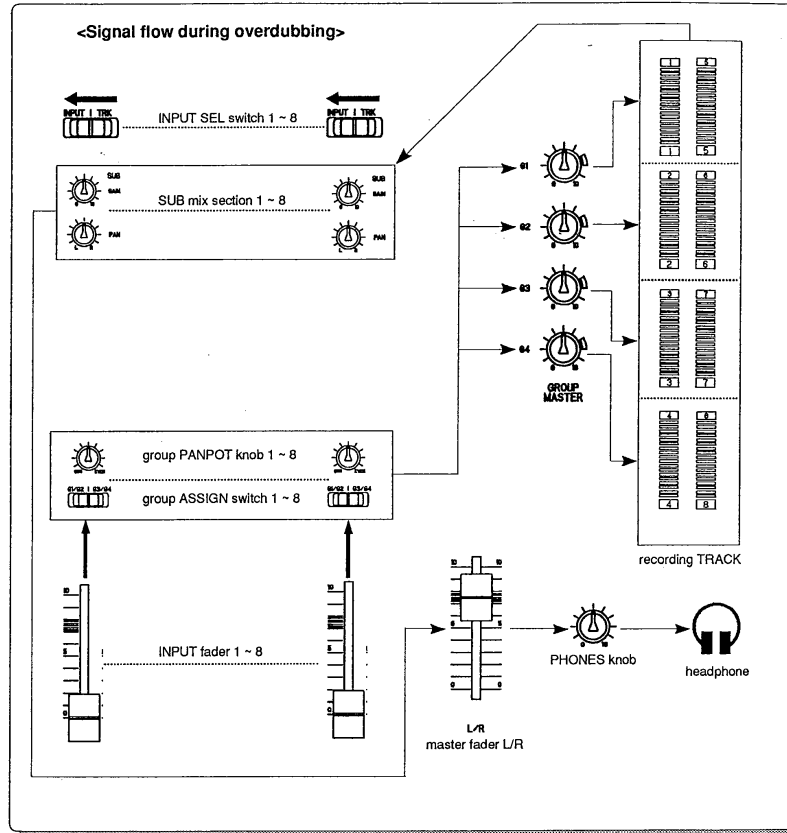

4-4. Mixdown

Mixdown is the final step in multitrack recording and allows you to combine multiple track recordings to L and R channels (two mixes), and copy the data to a master recorder.

For example, we will mix down eight tracks (drum machine, electric bass, electric guitar, vocal, etc.) after applying effects using the AUX function, equalizing, and adjusting the panpot balance and volume level.

The DMT-8 is equipped with a DATA OUT connector that outputs a digital signal (in S/P DIF format), as well as STEREO OUT L/R jacks that output analog signal for mixdown output (which corresponds to Stereo Bus L/R output). Therefore, you can connect a DAT machine equipped with an optical input for high-quality digital mixdown without sound deterioration.

* Set the DMT-8 to the default settings.
 * Assume that the following sound sources have already been recorded to eight tracks.

1	2	3	4	5	6	7	8
E. Bass	L	R	Vocal	Rhythm	Lead	Plano	Synth
		Drums		Guitar	Guitar		

* Here, we are using two effect units; reverb unit (connected to AUX 1) and chorus unit (connected to AUX 2).

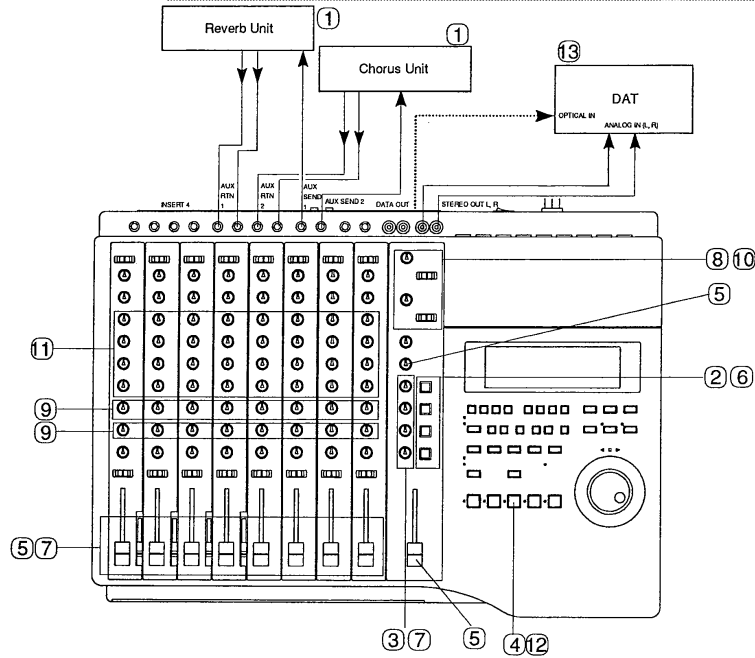

Connecting the effect units and master recorder

1. Refer to the figure below to connect two effect units and a master recorder (DAT or analog master recorder).

Channel switch settings

CH	INPUT SEL switch	Group ASSIGN switch	Group PANPOT knob
1			
2			
3			
4			
5			
6			
7			
8			

*** INPUT SEL switch**

In the figure above, all the INPUT SEL switches are set to "TRK."
 During the overdubbing operation, these switches were set to "INPUT" or "OFF" (center).
 Make sure that all these switches are set to "TRK" during mixdown.
 With these settings, all Track 1-8 outputs will be routed to INPUT faders 1-8, instead of the SUB mix section. The signals input from INPUT jacks 1-8 are now sent to SUB mix sections 1-8. (That is, the track signal and INPUT signal take an alternate route.)

Now, you can adjust the recorded track balance using the INPUT faders (which is easier than using the SUB mix), and apply equalization. (Equalization is effective only on signal routed to the INPUT fader, not on the signal routed to the SUB mix sections.)
 On the other hand, if you do not want to apply equalization to certain tracks, set the INPUT SEL switch for the corresponding channels to "INPUT" to route those track outputs to the SUB mix section.

*** Assign switches and PAN controls**

The settings shown above allow for the following grouping and stereo image settings.
 ("Grouping" refers to assigning tracks to groups (such as "rhythm" and "front") to facilitate mixdown, depending on the source.)

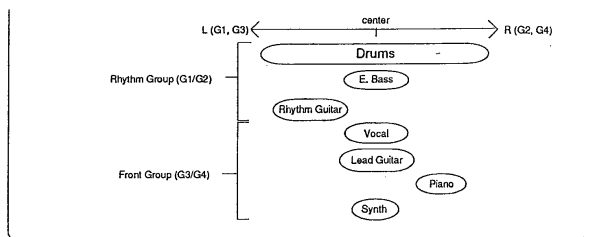

Setting the Group Master section

2. Set GROUP TO L/R switches G1-G4 to "ON."
- The signals distributed into Groups 1-4 can be sent to the Stereo Bus L/R.
3. Set GROUP MASTER controls G1-G4 to "7-8." (This setting will be adjusted later.)

- * During overdubbing, the GROUP MASTER controls were used to adjust the master level of the signals sent to the recording tracks. However, during mixdown, they are used to adjust the master level of the grouped signals.
In this example, GROUP MASTER controls G1 and G2 adjust the master level for the rhythm group (drum, electric bass, and rhythm guitar), and GROUP MASTER controls G3 and G4 adjust the master level for the front group (vocal, lead guitar, piano, synth).
- * During overdubbing, the GROUP TO L/R switches were all off, but during mixdown, turn these switches on. In this way, signals that were grouped to a rhythm group and front group will be sent to the Stereo Bus L/R, and will be output from STEREO OUT L/R (output to the master recorder).
At this time, Groups 1 and 3 are patched to "L" and Groups 2 and 4 are patched "R."
(If either G1 or G2 is turned on, the signal of the corresponding group will be sent to L/R with a center pan position. The same thing applies to G3 and G4.)

Adjusting the output level on the DMT-8 and the recording level on the master recorder

4. Press the **PLAY** button to play back data on the recorder section.
5. Raise the Master fader L/R to "7-8," then raise the Channel INPUT faders, and adjust the playback level of each track while monitoring the sound through the headphones.
6. To obtain a good level balance, press only the GROUP TO L/R switches "G1" and "G2" to monitor only the rhythm group. (Alternatively, press only "G3" and "G4" to adjust the balance of the front group.)
7. While observing the meter L/R on the DMT-8, adjust the INPUT faders so that the "OVER" indication will not light up with the peak signal. After adjusting the balance using the INPUT fader, adjust the balance between groups using the GROUP MASTER control.

Setting AUX and applying effects

- * Refer to "Applying monitoring reverb" in Step 4 for information on connecting reverb and chorus units, and detailed notes.
- 8. Set the AUX RTN 1 control to "10" and the AUX RTN 1 Assign switch to "L/R" so that the reverb output will return to Stereo Bus L/R.
Set the AUX RTN 2 control to "10" and set the AUX RTN 2 Assign switch to "L/R" so that the chorus output will return to Stereo Bus L/R.

Hints:

You can also assign the reverb and chorus outputs into groups by setting the AUX RTN 1 Assign switch to "G1/G2" and setting the AUX RTN 2 Assign switch to "G3/G4."
Try various settings.

- 9. Turn the AUX 1 control of the channel of the track to which you wish to apply reverb toward "CH." Turn the AUX 2 control of the channel of the track to which you wish to apply reverb toward "CH."
Now, the post-fader signal (signal adjusted by the Channel INPUT faders) will be output from AUX SEND 1 and 2, and routed to the reverb and chorus units respectively.
- 10. You can use the **AUX RTN 1** and **2** controls to adjust the reverb/chorus return level.
- 11. Use Channel equalizers to adjust the tonal color of Track 1-8.

Actual mixdown

- 12. Press the **PLAY** button to start playback from the beginning.
Use the Master fader L/R to add fade-in/out.
- 13. When you are satisfied with tonal color, level, and effect balance, and the meter L/R shows an appropriate level, set the master recorder to recording mode.
You also need to adjust the input level on the master recorder if you are mixing down analog data from the STEREO OUT L/R jacks to the master recorder so that the level meter on the master recorder will show the same level as the meter L/R on the DMT-8.

4-5. Recording four tracks simultaneously

This section explains how to record up to eight sound sources to four tracks simultaneously. (The DMT-8 can record up to four tracks simultaneously.) Here, all the band members will play instruments and record music simultaneously.

* Connect the instruments as shown in the figure and record music following the track chart.

1	2	3	4
L	R	E. Bass	Synth.
Drums		Side Guitar	L. Guitar

- * Apply compressor/limiter to the drum sound on Channels 1-4.
- * Set the DMT-8 to the default settings.

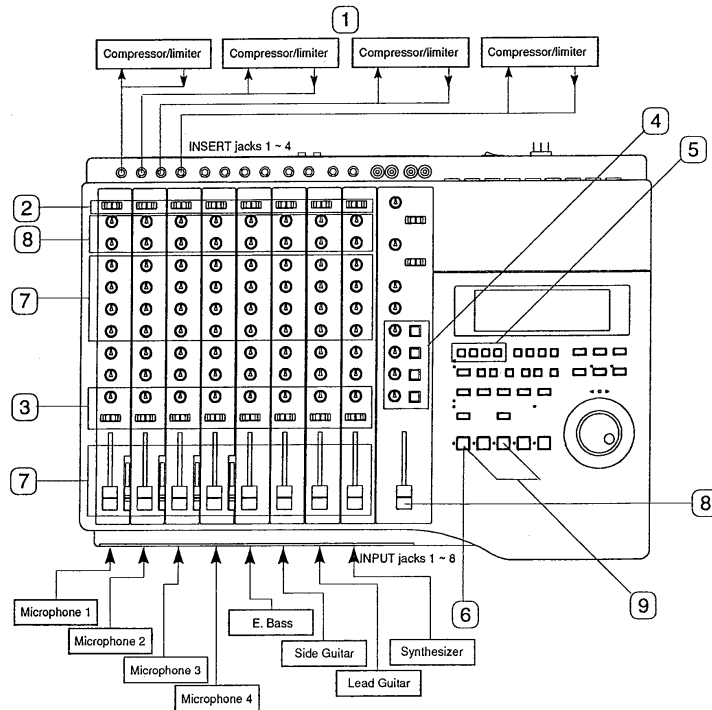

Connecting the effect units

1. Connect four compressor/limiters to **INSERT jacks 1-4**.

Switch settings

2. Set all Channel 1-8 **INPUT SEL** switches to **"INPUT."**
3. Set the Channel **group Assign switch** and **group PANPOT** as follows.

Input Channel	Group ASSIGN switch	Group PANPOT knob
Channel 1		
Channel 2		
Channel 3		
Channel 4		
Channel 5		
Channel 6		
Channel 7		
Channel 8		

4. Set **GROUP MASTER** controls G1-G4 to **"7-8."** (Turn all the **GROUP TO L/R** switches to **"OFF."**)
5. Press the **RECORD TRACK** select key 1/G1-4/G4 to ready Tracks **"1-4."** (Track **1** - **4** indicators will blink.)

Now, each sound source signal is sent to the corresponding track according to the track chart. The snare and kick sounds have a center pan position (so the same level of the signal is sent to Group 1 and Group 2.)

Hints:

The drums have been recorded in stereo to Tracks 1 and 2. Therefore, you cannot apply reverberation to only the snare sound during mixdown. In this case, you can use **AUX** to apply reverb to the snare sound, recording the original sound along with the reverb sound to Tracks 1 and 2 simultaneously. For more details, refer to "Hint 2" in Step 1.

Monitoring the recording signal and adjusting the level

6. Press the **RECORD** button once (the RECORD LED will blink) to set readied Tracks 1-4 to input monitoring status.
7. While playing the instrument, use the Channel INPUT faders/TRIM/Equalizers to adjust the signal level and tonal color.
8. Raise the Master fader L/R to "7-8," and monitor the sound at Channel 1-4 SUB mix sections.
Turn Channel 1 and 2 SUB PAN controls all the way to L and R respectively so that the drums sound can be monitored in stereo.

Start recording

9. Press the **PLAY** button while holding down the **RECORD** button.

Playback

1. Turn RECORD TRACK select keys 1/G1-4/G4 to "OFF" and press the **PLAY** button to start playback.
Adjust the playback level using the GAIN controls and adjust the pan position using the PAN controls in Channel 1-4 SUB mix sections. Use the Master fader L/R to adjust the entire volume level.

Chapter 5

Application Guide

This chapter explains how to perform ping-pong recording. It also describes the MIDI Clock synchronization system and the MTC sync/machine control system, which work with the DMT-8 MIDI functions. This chapter also explains various applications of the recorder section.

5-1. Ping-pong recording

Ping-pong recording enables you to combine multiple recorded tracks and record them to an empty track. You can then overdub additional sounds onto the previously-recorded tracks, adding instrumentation or musical parts to your recording.

** In this example, we are going to ping-pong Tracks 1 through 6 to Tracks 7 and 8. Since effects cannot be applied to each sound individually after ping-pong recording, we need to apply effects here and record the effect sound to Tracks 7 and 8.*

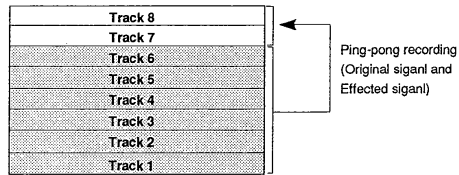

** Set the DMT-8 to the default setting.*

Connecting the effect unit

As in the Getting Started chapter, connect your favorite effect unit using the **AUX** connection. Only **AUX RTN 2** is used to send the effect sound to Tracks 7 and 8. Select "**G3/G4**" using the AUX RTN 2 Assign switch to send the effect return signal to Tracks 7 and 8. (AUX RTN 1 selects "**G1/G2**.") (Check the relationship between Groups and Tracks.)

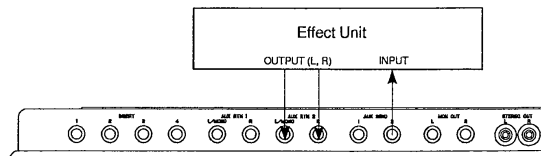

Switch settings

1. Set the channel switches as follows:

Channel	INPUT SEL	GROUP Assign SW	GROUP PAN
1-6	"TRK"	"G3/G4"	accordingly
7, 8	"INPUT"	"OFF"	

- * Set the Channel 1-6 **GROUP PAN** controls if necessary. The stereo pan position is created by Tracks 7 and 8 (Track 7: L, Track 8: R).
2. Turn the GROUP MASTER controls G3 and G4 to "7-8." Set all the GROUP TO L/R switches to "OFF."
 3. Press the RECORD TRACK select keys 7/G3 and 8/G4 to "ready" Tracks 7 and 8. (Track indicators [7] and [8] will blink.)

Monitor/Level adjustment/Rehearsal

4. Press the **RECORD** button once. (The RECORD LED will blink.) Tracks 7 and 8 enter input monitoring status.
To monitor the signal at the SUB mix section, raise the Master fader L/R to 7-8, and raise the SUB GAIN level for Channels 7 and 8 (to which Track 7 and 8 output signals are routed). (Set the SUB GAIN controls for Channels 1-6 to "0.") Turn the SUB PAN control for Channel 7 all the way to "L" and turn the SUB PAN control for Channel 8 all the way to "R" to create a stereo image.
5. Press the **PLAY** button to start playback.
6. Adjust the track level balance using INPUT faders 1-6, and adjust the effect balance by turning the AUX2 controls 1-6 toward "CH" so that the "OVER" indicator will not light up on meters 7 and 8.

Hints:

As discussed in the "Summary of level adjustment" section of the Getting Started chapter, set the GROUP MASTER controls to "7-8." This is for the following reason:
If the entire volume level (adjusted by the INPUT faders) is too high, lowering the level using the GROUP MASTER controls G3 and G4 will correct the movement of the Track 7 and 8 level meters; however, the level of the signal immediately preceding GROUP MASTER controls G3 and G4 will be too high, causing the signal to distort. To prevent ping-pong recording a distorted signal, you need to set the GROUP MASTER controls to 7-8.

Actual ping-pong recording

7. To start ping-pong recording, press the **PLAY** button while holding down the **RECORD** button. Depending on the PAN control settings, the playback sound on Tracks 1-6 will be recorded to Track 7 (L) or Track 8 (R), along with the effect sound.

5-2. MIDI Clock synchronization system

In this section, we will learn how to insert a time signature at any location of the song and set the tempo using the internal programmable Tempo Map, in order to synchronize an external MIDI sequencer to the MIDI Clock. You can use all eight tracks on the DMT-8 (unlike conventional tape multi-track recorders, on which you must sacrifice one track for the FSK signal).

You can also set the INPUT SEL switches so that the signal from the INPUT jack and output signal from the recorder section can be routed to the INPUT faders and SUB mix sections alternately (this is called the "Alternate mix function"). Therefore, it is possible to send the recorder output to the INPUT faders, and connect up to eight MIDI sound sources to the INPUT jacks to patch the input signals to the SUB mix sections, allowing for mixdown of a total of 16 channels. At such time, you can set the AUX 1 and AUX 2 knobs to "CH"/"SUB" for effect send so that you can apply effects to both the track playback signal at the INPUT faders and the MIDI sound source signal at the SUB mix sections.

** Set the DMT-8 to the default setting.*

Connecting external MIDI devices

1. Connect the DMT-8 **MIDI OUT** connector to the **MIDI IN** connector on the MIDI sequencer.
2. Set the MIDI sequencer to "**MIDI Clock Slave mode**" and connect the MIDI source that plays sequence data to the INPUT jack of the DMT-8.
3. If necessary, connect the effect units for monitoring or simultaneous recording.
(AUX SEND 1 (2) -> Effect unit 1 (2) -> AUX RTN 1 (2))

MIDI SYNC OUT settings

1. Set "**MIDI SYNC OUT**" in Setup mode to "**MIDI Clock (CLock) OUT.**" If you wish to use the metronome function, set "**CLICK**" in Setup mode to ON. Refer to pages "100" and "106" for details.

Creating a Tempo Map

1. Set a time signature for each measure using the "**BAR J**" parameter in Setup mode. Then, set the tempo for each bar/beat location using the "**TEMPO**" parameter in Setup mode. Refer to pages "96" and "98" for details.
2. Run the DMT-8 in record mode (you do not have to record any sound since the purpose is only to create a recorded disk area) and confirm that the MIDI sequencer is running in sync with the tempo map. (If some data has already been recorded up to the end point of the song, you can only play back data.). Set the timebase to "**BAR/J/CLK**" to check whether the playback position on the MIDI sequencer matches that on the DMT-8.

Overdubbing

3. Overdub performance data to Tracks 1-8 while accompanying the synchronizing **MIDI source output** (as if the source was data already recorded on the track). Alternatively, you can actually record the MIDI sound source on a track as a guide or accompaniment track.

Mixdown while synchronizing the MIDI sound source

When overdubbing is complete, you can start the mixdown.

As shown in the figure, connect the MIDI sound source to the DMT-8 to route the source signal to SUB mix 1-8, and using this as a virtual track, synchronize other tracks while applying effects and mixing down.

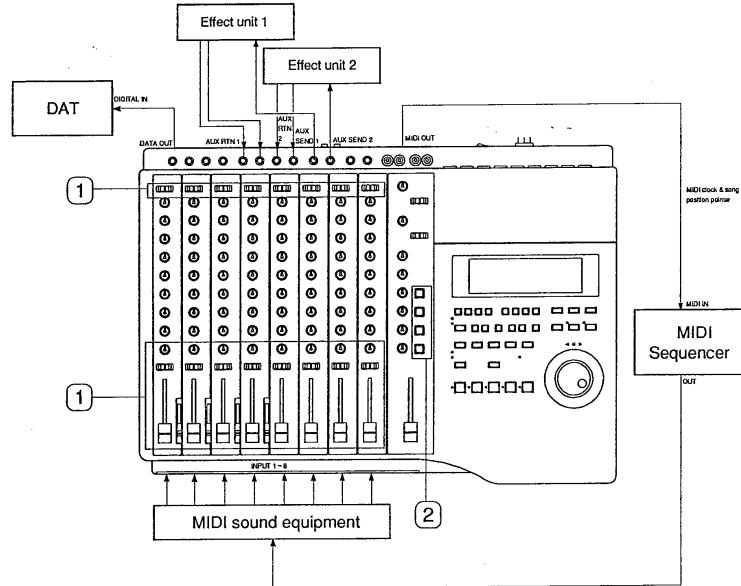

Switch setting

1. Set the channel switches as follows:

Channel	INPUT SEL switch	GROUP Assign switch	GROUP panpot
1-8	TRK	Accordingly	Accordingly

- * Set the GROUP Assign switches and PAN controls, as well as the AUX RTN 1 and AUX RTN 2 Assign switches, according to grouping. Refer to page "57" for details.
2. Turn all the GROUP TO L/R switches G1-G4 "ON."
Track 1-8 output signal will be sent via Group Buses 1, 2, 3, and 4 to the Stereo Bus L/R, and will be mixed with the MIDI source output signal on the SUB mix section. Both mixed signals will be routed via the Master fader L/R to the STEREO OUT L/R connectors, then via the DATA OUT connector to the master recorder.
 3. Place the master recorder in record mode, and start playback on the **DMT-8**. If you wish to apply an effect to the MIDI sound source, turn the AUX 1 (or AUX 2) control of the connected channel toward "SUB." If you wish to apply the effects to the track playback signal, turn the control toward "CH." (Refer to the "Mixdown" section for information on setting the output level on the DMT-8 and other notes.)

5-3. MTC Synchronization/Machine Control system

This section explains how to control the DMT-8 from a computer using MMC (MIDI Machine Control) and how to synchronize the system to MIDI timecode output from the DMT-8.

The DMT-8 can output MTC at any frame rate by adding a time offset (less than six hours) to the ABS (absolute) time of the hard disk. You can also control the DMT-8 from an external device by sending MMC (MIDI Machine Control). Refer to page 110, "MMC List," for more information about MMC compatibility. When the DMT-8 receives MMC Rehearsal message (set by WRITE: 40h, RECORD MODE: 4ch), the REHEARSAL LED will flash, indicating that Manual Punch-in/out Rehearsal mode is engaged.

** Set the DMT-8 to the default setting.*

Connecting an external device

1. Connect the **MIDI IN/OUT** connectors on the DMT-8 to the **MIDI IN/OUT** connectors of a computer (using a MIDI interface). (Start a sequencer software application on your computer that is compatible with MMC/MTC.)
2. Set the sequencer software application to **MTC slave mode** and **MMC output mode**, and select a desirable frame rate. Refer to the "MIDI Clock Synchronization system" section for connecting the MIDI sound source and effect units to the DMT-8.

Setting the MIDI SYNC OUT

1. Select "**MTC (mtc)**" for "**MIDI SYNC OUT**" in Setup mode. At this time, it is useful to set timebase to "MTC." Refer to page "106" for more detail.

Setting MTC OFFSET

2. Set the difference in time (offset time - less than six hours) from ABS time for "**MTC OFFSET**" in Setup mode. Refer to page "108" for more detail.

Setting frame rate

3. Select the same MTC frame rate as that of the sequencer software application for the "**FRAME RATE**" parameter in Setup mode. Refer to page "107" for detail.

Checking synchronization and machine control

4. Run the DMT-8 in record mode (you do not have to record any sound since the purpose is only to create a recorded disk area) and confirm that the MIDI sequencer is running in sync with the tempo map. (If some data has already been recorded up to the end point of the song, you can only play back data.). Also, check to see that the DMT-8 responds correctly when you use the **PLAY**, **STOP**, or **LOCATE** functions on the computer.

Overdubbing

5. Overdub performance data to Tracks 1-8, as explained in "**MIDI Clock synchronization system**."

Mixdown while synchronizing a MIDI sound source

Connect a MIDI sound source as shown in the figure below, patching the MIDI source signal to SUB mix sections 1-8 (or INPUT faders 1-8) as a virtual track to which to synchronize, and apply the effect and mixdown.

Refer to the "MIDI Clock synchronization system" section for the switch settings.

The recorder output is routed to the SUB mix section of the channel which has the MIDI sound source signal routed to the INPUT fader.

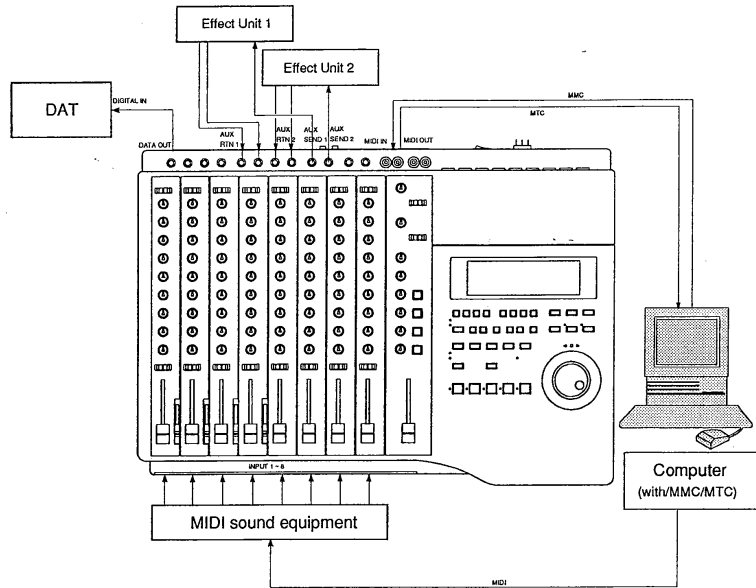

5-4. Using only the DMT-8 recorder section

You can use only an internal hard disk recorder.
 Connect an external mixer that has eight monitor mix channels (that correspond to "SUB mix section" on the DMT-8) to the RECORDER IN jack on the DMT-8, and connect the RECORDER OUT jack to the tape input (x8) of the external mixer.

<Note>
 If you connect a plug to the RECORDER IN jack on the DMT-8, this connection takes priority and you will be unable route the recording signal via the GROUP MASTER controls. If you wish to use the mixer function of the DMT-8 for recording, be sure to remove any plug from the RECORDER IN jack.

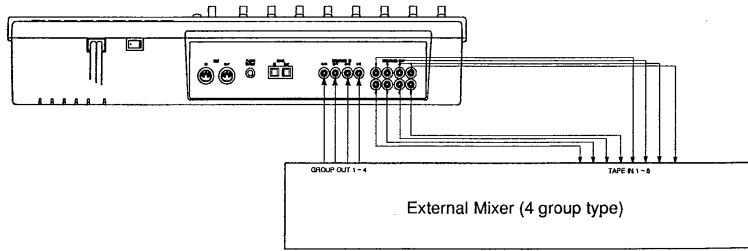

Chapter 6

Punch In/Out

Punch In/Out recording is used to re-record data onto a certain area of a pre-recorded track. For example, you can replace a phrase from your guitar solo with a better performance.

There are two ways to Punch In/Out record: Auto Punch In/Out recording, in which you specify the Punch In/Out points; and Manual Punch In/Out recording, in which you use optional foot switch Model 8051. In either case, the Rehearsal function allows you to practice before actual take. Using the Punch In/Out recording technique, you can easily and quickly replace mistakes or phrases you do not like with more desirable takes. Choose one of these methods to suit your preferences and applications.

The example here explains how to replace "part of the guitar solo" recorded on Track 3 with a new phrase by playing the guitar (connected to Input jack 1), while listening to the drum and bass sound recorded on Tracks 1 and 2. Once you master Punch In/Out recording, you can use this technique for other tracks.

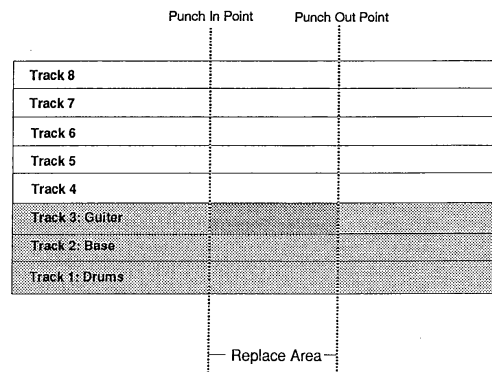

6-1. Auto Punch In/Out

To perform Auto Punch In/Out recording, first you need to specify the In point (recording start point) and the Out point (recording end point). Once these two points are stored, the DMT-8 automatically starts recording at the In point and stops recording at the Out point while the recorder is in "Take mode." When you use the Auto Punch In/Out function, you can select "Rehearsal mode" to practice to your satisfaction before you record.

*** Set the DMT-8 to the default setting.**

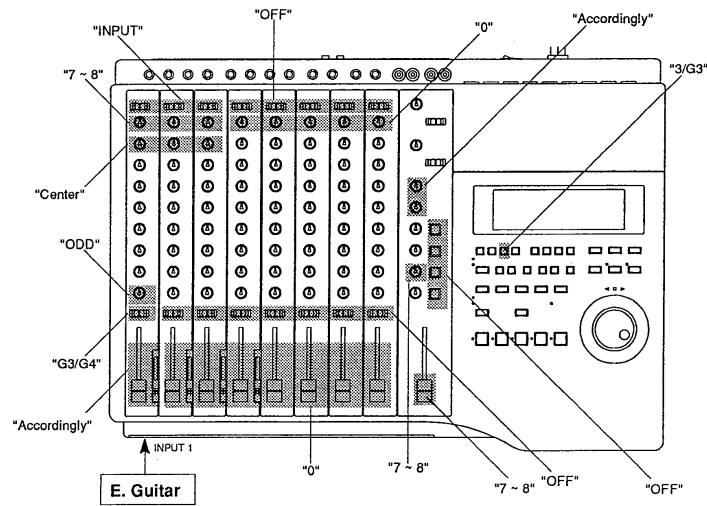

Preparation

1. Connect the guitar to Input jack 1. Refer to 4-3. "Basic Recording" for more information on adjusting the recording level.

Switch settings

INPUT SEL switch	Channel 1 ~ 3: "INPUT" Channel 4 ~ 8: "off" (center)
SUB GAIN knob	Channel 1 ~ 3: "7 ~ 8" (Adjust the level for easier monitoring.) Channel 4 ~ 8: "0"
SUB PAN knob	Channel 1 ~ 3: "center" (Adjust the level for easier monitoring.)
Group ASSIGN switch	Channel 1: "G3/G4", Channel 2 ~ 8: "OFF"
Group PANPOT (Channel 1)	"ODD" (Turn the knob fully counter-clockwise.)
INPUT fader & TRIM	Channel 1: "Accordingly", Channel 2 ~ 8: "0"
GROUP MASTER knob	G3: "7 ~ 8", G1, G2, G4: "0"
GROUP TO L/R switch	G1 ~ G4: "OFF"
MONITOR & PHONES knobs	"Accordingly"
Master fader L/R	"7 ~ 8"
RECORD SELECT key	Press "3/G3" to ready Track 3.

Storing the Punch In point

Here, we assume that "ABS" has been selected for the timebase.

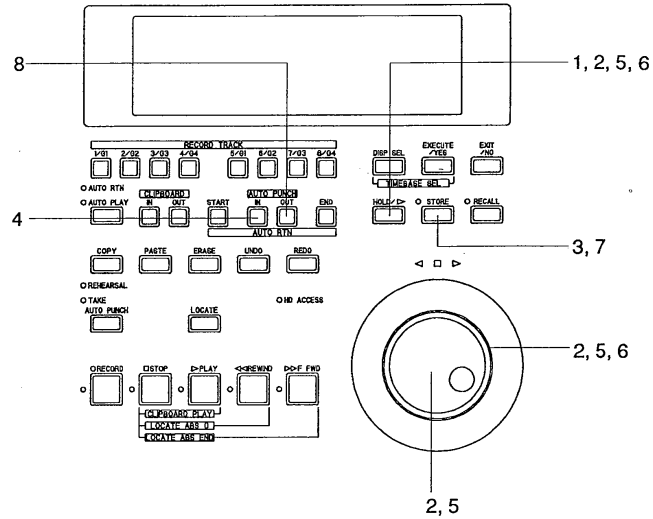

1. Press the **HOLD/>** key to enter edit mode.

ABS
00 H 02 M 40 S blink (Edit is possible)
03 F 28 SF

- * Pressing the **STORE** key will also cause the DMT-8 to enter hold/edit status. In this case, you can omit step 3 below.

2. Press the **HOLD/>** key or turn the **SHUTTLE** dial to select the digit you wish to edit, then use the **JOG** dial to change the time value.

ABS
00 H 03 M 15 S
10 F 00 SF

3. Press the **STORE** key. (The **STORE** LED will light up.)

4. Press the **AUTO PUNCH IN** key.

The specified time value will be stored as a Punch In point, and the **STORE** LED will go off.

Storing the Punch Out point

5. Press the **HOLD/>** key to enter edit mode.

ABS
00 H 02 M 40 S blink (Edit is possible)
03 F 28 SF

6. Press the **HOLD/>** key or turn the **SHUTTLE** dial to select the digit you wish to edit, then use the **JOG** dial to change the time value.

ABS
00 H 03 M 35 S
15 F 00 SF

7. Press the **STORE** key. (The **STORE** LED will light up.)

8. Press the **AUTO PUNCH OUT** key.

The specified time value will be stored as a Punch Out point, and the **STORE** LED will go off.

- * To check the stored Punch In/Out point, press the **RECALL** key, then press the **AUTO PUNCH IN** key and/or the **AUTO PUNCH OUT** key. Alternatively, press the **AUTO PUNCH IN/AUTO PUNCH OUT** key. The display will show the stored time value.

<Note>

You cannot set the Punch Out point before the Punch In point location. If the Punch Out point precedes the Punch In point and you try to "punch in," the message "Void out" appears on the screen immediately after you press the **AUTO PUNCH** key, indicating that the time value of the Punch Out point is inappropriate. Be sure to specify a larger value for the Punch Out point than for the Punch In point.

Auto Punch In/Out Rehearsal mode

In Rehearsal mode, the recorder enters input monitoring status between the Auto Punch In and Out points. The recorder will not record any data, allowing you to fine-tune the In/Out points or the recording level until the settings are satisfactory.

1. Locate a point just before the Punch In point, using one of the following methods:
Press the **AUTO PUNCH IN** key, then the **LOCATE** key. The display will show the Punch In point parameter, and the Punch In point will be located immediately. Press the **REWIND** button or turn the **SHUTTLE** dial counter-clockwise to rewind a little. Alternatively, you can store the playback start point (time) at the **AUTO RTN START** for the future locate operations. (You need to use the **AUTO RTN START** key for step 4 of "Storing the Punch In point.")
2. Press the **AUTO PUNCH** key. (The **REHEARSAL** and **TAKE** LEDs will light up.)
If there is not enough disk space for the undo operation, the display will show an "overtime indication" and a "CAN'T UNDO" indication at this time. For more details, refer to "Warning Message" in the 2-6 "Display Section."
3. Press the **PLAY** button.
Rehearsal mode is engaged as follows:

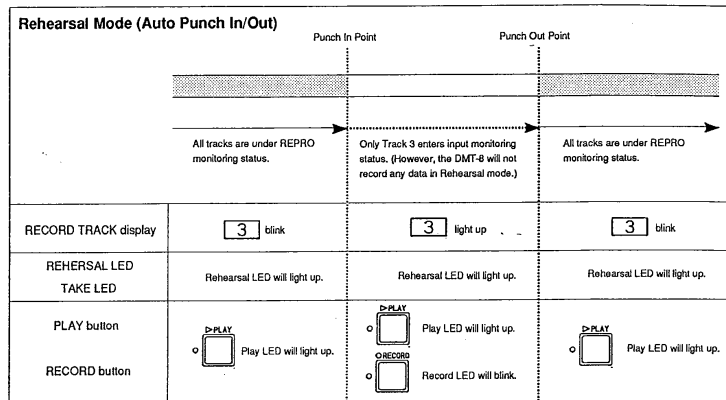

4. Rehearse the guitar part while playing back the drum and bass sounds. You will hear the guitar sound you are playing only between the punch in and punch out points.

* Hints

When you are rehearsing repeatedly, it is an effective time-saver to use the Auto Return function along with the Auto Play function.

As shown in the diagram below, specifying the Start and End points for the Auto Return and Auto Play functions allows you to easily rehearse as many times as you like. This enables you to pay more attention to the recording level and your own performance. Refer to pages "81" ~ "83" for more information on setting the Start/End points for the Auto Return/Auto Play functions.

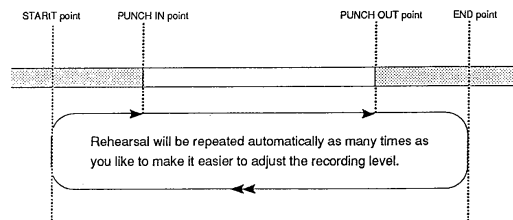

Auto Punch In/Out Take mode (actual recording)

1. As in Rehearsal mode, locate the point just before the Punch In point. (Assume that Auto Punch mode is on; that is, both REHEARSAL and TAKE LEDs are blinking.)
2. Press the **PLAY** button while pressing and holding down the **RECORD** button. (The REHEARSAL LED will go off and the TAKE LED will light up.)
3. Play the **guitar** while listening to the playback sound.

As shown in the illustration below, the recorder will start recording automatically at the Punch In point, and stop recording at the Punch Out point.

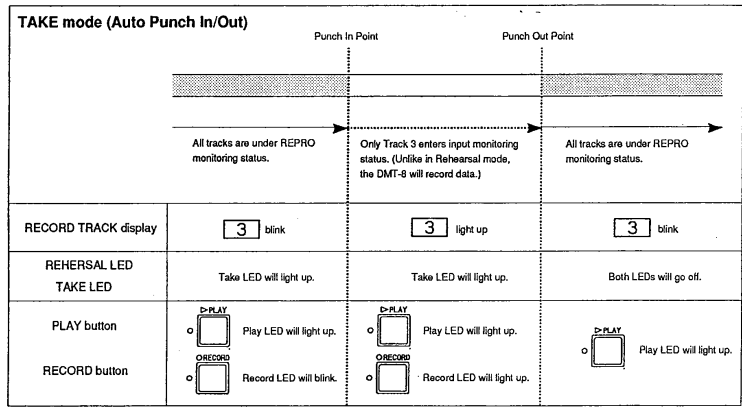

* When recording is finished, Auto Punch mode will be cancelled, and both REHEARSAL and TAKE LEDs will go off.

Undo/Redo of Auto Punch In

When you auto punch in/out record while the "CAN'T UNDO" warning message is not displayed, you will be able to undo or redo the take.

Pressing the UNDO key after recording will restore the status obtained before you made Punch In/Out recording. Pressing the REDO key will restore the status obtained before you pressed the UNDO key.

<Note>

You can use the undo/redo functions while the DMT-8 is in stop mode. Under the following circumstances, you will be unable to use the undo/redo functions;

1. if you make a new recording,
2. if you make a new edit (paste, erase, or cut),
3. if the Auto Punch In point was passed in play or record mode while Auto Punch mode was on, or
4. if you turned off the power to the DMT-8, then turned it back on.

6-2. Punch In/Out Recording using a foot switch

"Take mode" and "Rehearsal mode" are also available in this application. Pressing the foot switch repeatedly while holding down the STOP button will toggle between "take" and "rehearsal." The REHEARSAL LED of the AUTO PUNCH key will blink during Rehearsal mode, and the LED will be off during "Take mode."

1. Select the track onto which you wish to punch in/out record.
2. Start playback just before the punch in point.
3. Press the foot switch when you want to start recording.
4. Press the foot switch again when recording is finished.

In this lesson, we are going to replace part of the guitar solo recorded on Track 3, as we did in the Auto Punch In/Out section.

- * Set the DMT-8 to the default setting.
- * Use an optional foot switch Model 8051 for punch in/out recording.
- * To use a foot switch, be sure to turn the AUTO PUNCH key OFF. (The REHEARSAL LED and TAKE LED will go off.)

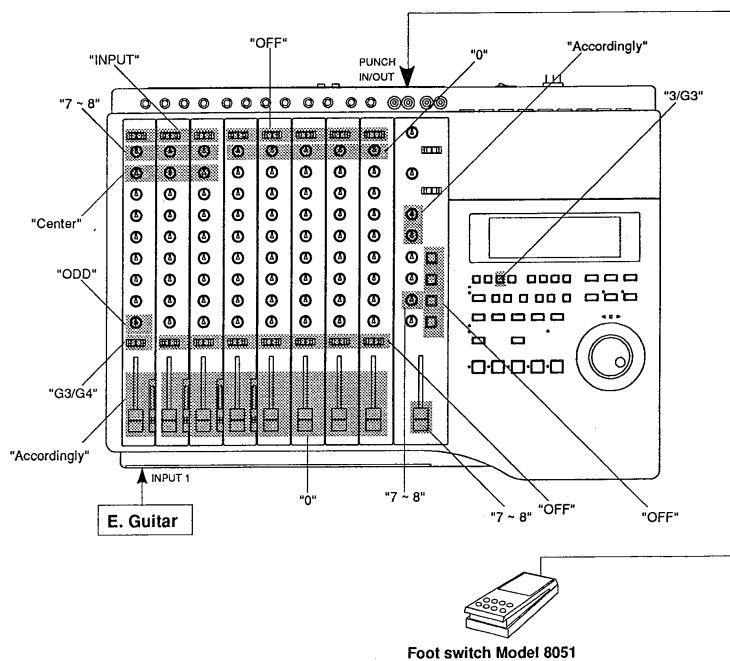

Preparation

1. Connect the guitar to **Input jack 1** (or any Input jack available).
Refer to 4-3 "Basic Recording" for more information on adjusting the record level.
2. Connect the foot switch Model 8051 to the **PUNCH IN/OUT jack** on the rear panel of the DMT-8.

Switch settings

INPUT SEL switch	Channel 1 ~ 3: "INPUT" Channel 4 ~ 8: "OFF" (center)
SUB GAIN knob	Channel 1 ~ 3: "7 ~ 8" (Adjust the level for easier monitoring.) Channel 4 ~ 8: "0"
SUB PAN knob	Channel 1 ~ 3: "center" (Adjust the level for easier monitoring.)
Group ASSIGN switch	Channel 1: "G3/G4", Channel 2 ~ 8: "OFF"
Group PANPOT (channel 1)	"ODD" (Turn the knob fully counter-clockwise.)
INPUT fader & TRIM	Channel 1: "Accordingly", Channel 2 ~ 8: "0"
GROUP MASTER knob	G3: "7 ~ 8", G1, G2, G4: "0"
GROUP TO L/R switch	G1 ~ G4: "OFF"
MONITOR & PHONES knobs	"Accordingly"
Master fader L/R	"7 ~ 8"
RECORD TRACK select key	Press "3/G3" to ready Track 3.

Punch In/Out Rehearsal

1. Press the foot switch once while holding down the **STOP** button.
The recorder enters "Rehearsal" mode, and the 7-segment display on the upper row of the screen will show "REHSAL", and the 7-segment display on the bottom row will show "on" for one second. Only the REHEARSAL LED (green) will blink.
2. Press the **PLAY** button at a location just before the punch in point to play back data.
3. Rehearse the guitar part while playing back the drum and bass sounds.

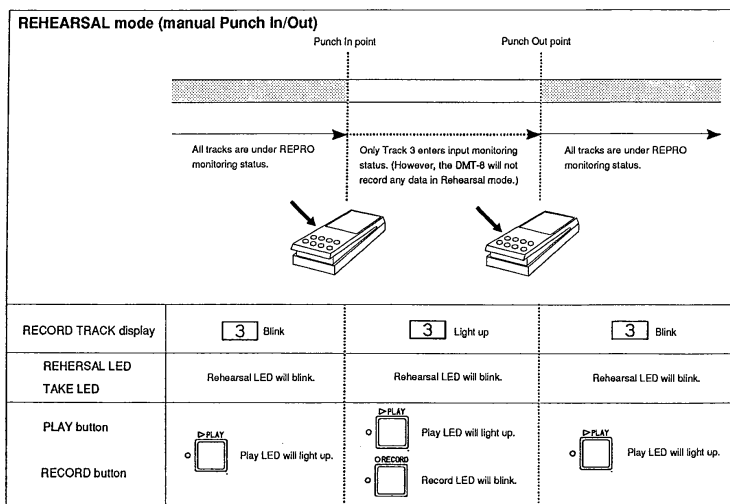

4. Press the **foot switch** once at the Punch In point, and press the **foot switch** again at the Punch Out point. The following diagram illustrates this operation. You will hear the guitar sound you are playing only between the punch in and out points.

End of rehearsal

1. Press the foot switch again while holding down the **STOP** button to cancel Rehearsal mode. The 7-segment display on the upper row of the screen will show "rEHSAL", and 7-segment display on the bottom row will show "oFF" for one second. Also, the REHEARSAL LED (green) will turn off, indicating that you quit Rehearsal mode.

*Hints

When you are rehearsing repeatedly, it is an effective time-saver to use the Auto Return function along with the Auto Play function.

As shown in the diagram below, specifying the Start and End points for the Auto Return and Auto Play functions allows you to easily rehearse as many times as you like.

In this way, you can pay more attention to the recording level and your own performance.

Refer to pages "81" ~ "83" for more information on setting the Start/End points for the Auto Return/Auto Play functions.

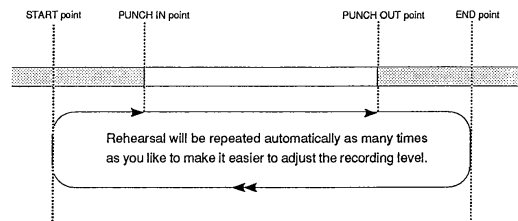

Punch In/Out Take

1. Locate the point just before the punch in point and play back the data.
2. Play the **guitar** while listening to the playback.
3. Press the **foot switch** once at the punch in point, and press the **foot switch** again at the punch out point. When you finish punch out recording, the DMT-8 will quit recording mode.

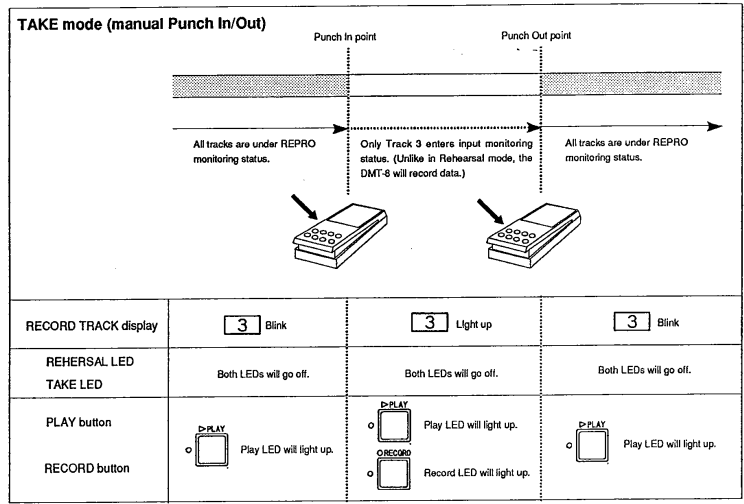

*** Hints**
 Besides the foot switch, you can also use the PLAY button and RECORD button for Manual Punch In/Out recording. (Please note that you can use these buttons only once.)

1. Start playing back from a point just before the punch in point.
2. At the punch in point, press the RECORD button while holding down the PLAY button. (Punch In)
3. At the punch out point, press only the PLAY button. (Punch Out)

* You can also rehearse if you "press only the RECORD button" instead of steps 2 and 3 described above.

Chapter 7

Locate Function

Since the DMT-8 uses a hard disk as storage media, it can locate any point immediately. Using the Locate function allows you to quickly locate points stored at the CLIP BOARD IN/OUT key, AUTO PUNCH IN/OUT key, AUTO RTN START/END key, LOCATE key, or at the beginning of the hard disk (ABS TIME 0), or at the end of recording area (ABS TIME END).

This function is also very useful for rehearsal before recording, rehearsing during mixdown, and rehearsal for Auto Punch In/Out recording. This chapter describes how to use these Locate functions.

7-1. Locate

Use the following key sequences to locate a certain point. In this table, "+" indicates that you need to press the specified key while pressing and holding down the STOP button. "-" indicates that you need to first press one key, then press a second key.

1	STOP+REWIND	Locates the beginning of the hard disk (ABS 0).
2	STOP+F FWD	Locates the end of the recorded area on the hard disk (ABS END).
3	CLIPBOARD IN->LOCATE	Locates the stored Clipboard In point.
4	CLIPBOARD OUT->LOCATE	Locates the stored Clipboard Out point.
5	AUTO RTN START->LOCATE	Locates the stored Auto Return Start point.
6	AUTO RTN END->LOCATE	Locates the stored Auto Return End point.
7	AUTO PUNCH IN->LOCATE	Locates the stored Auto Punch In point.
8	AUTO PUNCH OUT->LOCATE	Locates the stored Auto Punch Out point.
9	LOCATE	Locates the stored Locate point (see the note below).

<Note>

Please note that each time you use any locate functions other than operations 1, 2, and 9 shown above, the located point data will automatically replace the existing data at the LOCATE key. For example, assume that the LOCATE key has stored data of 00^h:05^m:30^s:00^f:00^{sf}. When the Auto Return Start point "00^h:03^m:00^s:00^f:00^{sf}" is located, the data stored at the LOCATE key will be changed "00^h:03^m:00^s:00^f:00^{sf}." You can check the data stored at the LOCATE key by pressing the RECALL key, then the LOCATE key. You can also edit the data using the JOG dial, and press the STORE key then the LOCATE key to store a locate point which can be accessed by only the LOCATE key itself.

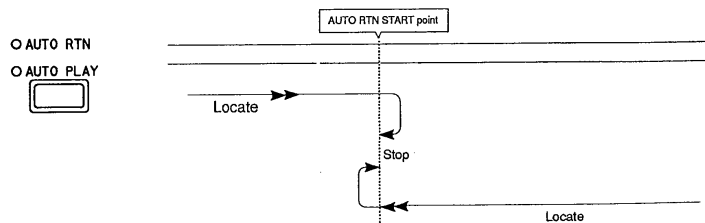

7-2. Auto Play mode

Turn Auto Play mode on before using the Direct Locate function, and the DMT-8 will automatically start playback from the located point (except when the ABS END point is located). The diagram below illustrates this operation.

To turn Auto Play mode on, press the AUTO PLAY/AUTO RTN key so that the AUTO PLAY LED will light up. To cancel this mode, press the AUTO PLAY/AUTO RTN key again so that the AUTO PLAY LED will go off. Refer to page "17" of chapter 2 "Names and Functions" for instructions on using the AUTO PLAY and AUTO RTN keys.

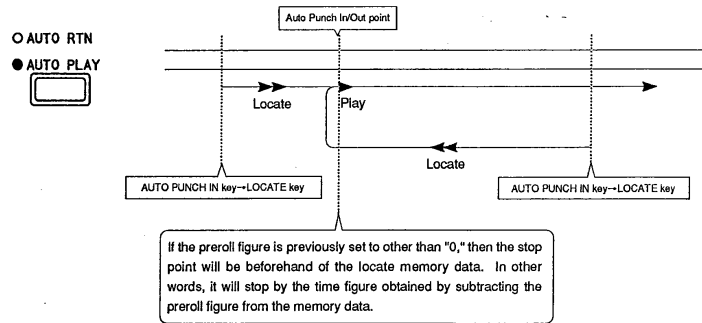

7-3. Auto Return mode

To turn Auto Return mode on, press the AUTO PLAY/AUTO RTN key so that the AUTO RTN LED will light up.

To use the Auto Return function, first you need to specify the Auto Return Start point and Auto Return End point.

As shown in the diagram below, the DMT-8 will playback data to the Auto Return End point, then automatically locate the Auto Return Start point, and stop.

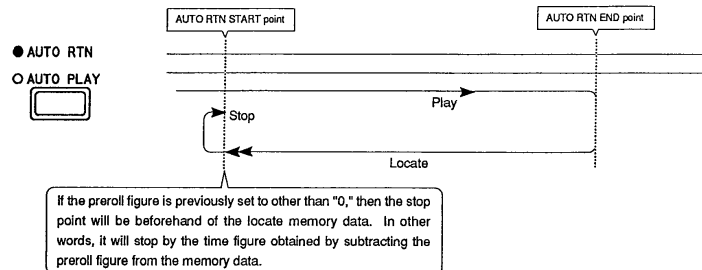

<Note>

The start point will not be locate after the AUTO RTN END point is reached when the DMT-8 is in record mode.

Setting the Auto Return Start/End point

There are two ways to set the Auto Return Start point and End point: one is to hold and store a desired time value in real-time during playback or while the DMT-8 is stopped; the other is to edit and store a desired time.

Storing the Start/End point in real-time

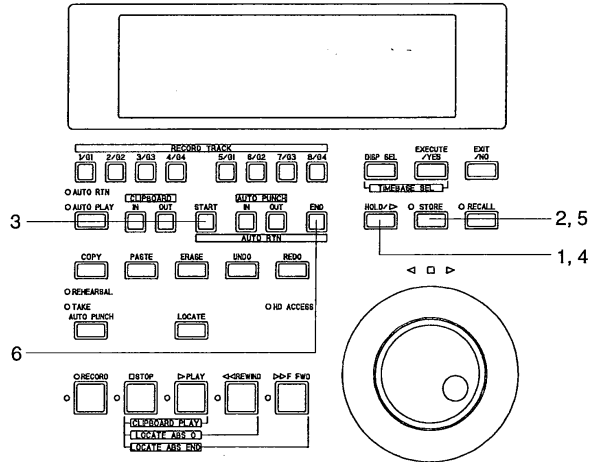

1. While the DMT-8 is playing back or stopped, press the **HOLD/>>** key at the location you wish to store as a Start point.
The time value obtained when you press the **HOLD/>>** key will be held, and the DMT-8 will enter edit mode.
 2. Press the **STORE** key. (The STORE LED will light up.)
 3. Press the **AUTO RTN START** key.
The time value you held will be stored as a Start point, and the display will go back to the previous screen that was obtained before the time value was held. (The STORE LED will go off.)
 4. Press the **HOLD/>>** key again at the location you wish to store as an End point.
 5. Press the **STORE** key. (The STORE LED will light up.)
 6. Press the **AUTO RTN END** key.
The time value you held will be stored as an End point, and the display will go back to the previous screen that was obtained before the time value was held.
- * In steps 1 and 4 described above, you can press the STORE key instead of the HOLD/>> key, then press the AUTO RTN START/AUTO RTN END key to set the data more quickly.

Editing and storing the Start/End point

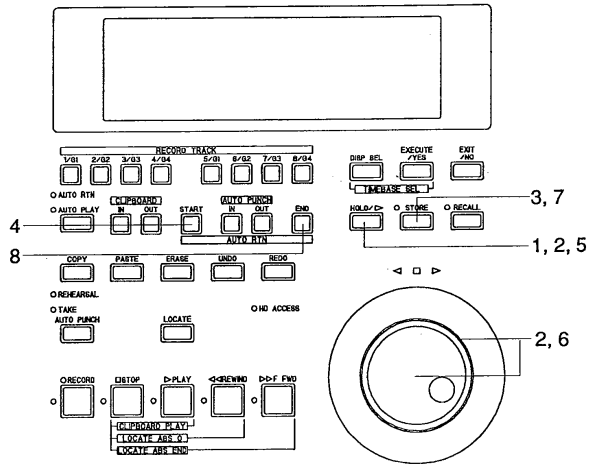

1. Press the **HOLD/>** key while the DMT-8 is playing back or stopped.
The time value at the moment when you pressed the **HOLD/>** key will be held and the unit will enter edit mode.
 2. Move the cursor to the time value (bar) using the **HOLD/>** key or **SHTUTTLE** dial, and use the **JOG** dial to change the value.
 3. Press the **STORE** key. (The **STORE** LED will light up.)
 4. Press the **AUTO RTN START** key.
The edited time value will be stored as a Start point, and the display will return to the screen displayed before you held the time value. (The **STORE** LED will go off.)
 5. Press the **HOLD/>** key again.
 6. Enter the value as you did in **step 2**.
 7. Press the **STORE** key. (The **STORE** LED will light up.)
 8. Press the **AUTO RTN END** key.
The edited time value will be stored as an End point, and the display will go back to the screen obtained previously before you held the time value.
- * In steps 1 and 5 described above, you can press the **STORE** key instead of the **HOLD/>** key, edit the time value (bar), then press the **AUTO RTN START/AUTO RTN END** key to set the data more quickly.

Changing the stored Start/End points

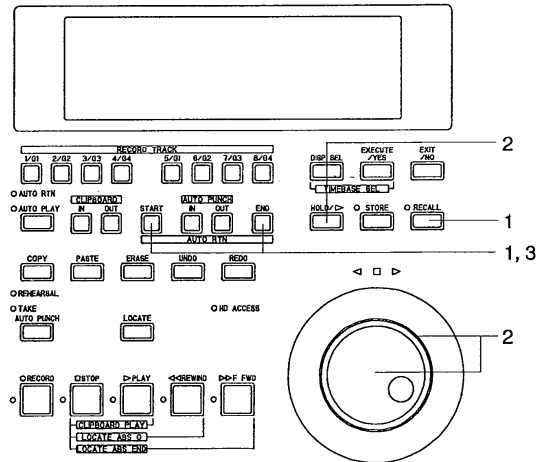

1. Press the **RECALL** key, then the **AUTO RTN START** key or **AUTO RTN END** key. (As a short-cut, you can press the **AUTO RTN START** key or **AUTO RTN END** key directly.)
The display will show the time value stored at the key, and the unit will enter edit mode.
2. Move the cursor to the time value (bar) using the **HOLD/>** key or **SHUTTLE** dial, and use the **JOG** dial to change the value.
3. Press the **STORE** key, then press the **AUTO RTN START** key.
The edited time value will be stored as a Start point or End point.

<Note>

Pay attention to the location of the Start and End points. If you have set a larger value to the Start point than the End point while both Auto Return mode and Auto Play mode are on, the DMT-8 will jump to the Start point and continue to play the rest of the data after playing to the End point (which is located before the Start point). Therefore, the repeat operation (explained later) will not be carried out correctly). Auto Return mode is effective only when the unit is in play mode.

7-4. Auto Repeat

The Auto Repeat function is a combination of Auto Play mode and Auto Return mode. To access the Auto Repeat function, press the AUTO PLAY/AUTO RTN key so that both AUTO RTN LED and AUTO PLAY LED will be lit.

You also need to set the Auto Return Start point and the Auto Return End point, as you did for the Auto Return function. (Refer to the previous section "Auto Return" for information on setting the Start and End points.)

With the Auto Repeat function, the DMT-8 plays data up to the Auto Return End point, then automatically locates the Auto Return Start point, and plays back data between the Start and End points repeatedly, until you cancel the playback using the STOP button. Refer to page 17 of chapter 2 "Names and Functions" for instructions on using the AUTO PLAY and AUTO RTN keys.

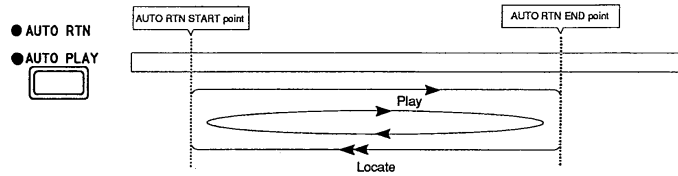

Hints:

When you are rehearsing Auto Punch In/Out recording, using the Auto Repeat function allows you to rehearse as many times as you want without tedious operations. For example, by setting the Start point just before the Auto Punch In point and the End point just before the Auto Punch Out point, you do not worry about locating the data and can concentrate on rehearsing.

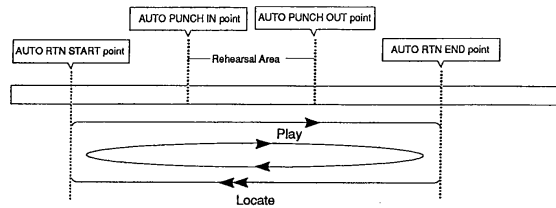

Chapter 8

Edit Function

This chapter describes various editing functions on the DMT-8. The DMT-8 uses the hard disk as a recording media, which allows for non-linear, non-destructive, quick audio editing. The edit function includes the Copy, Paste, Erase, and Cut functions.

8-1. Copy & Paste

The Copy & Paste functions use the clipboard of the DMT-8, allowing you to copy sound data and paste it to the specified area. The copied data remains on the clipboard after you paste it, and you can paste the same data as many times as you want to different places. The Copy & Paste functions can reference any one of the following time bases: ABS time, MTC time, MIDI Bar/Beat/Clock.

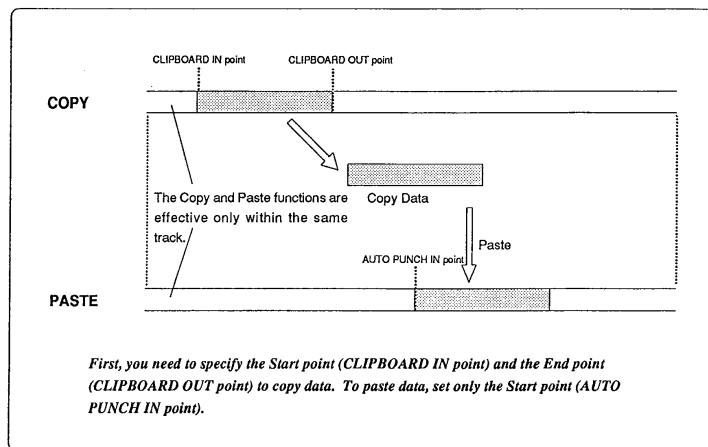

<Note-1>

You cannot paste data to a different track. For example, you cannot copy and paste Track 1 data to Track 2. When you copy and paste data of multiple tracks simultaneously, the data will be pasted to identical tracks.

<Note-2>

If pasted data overlaps the source data, the content of the source data will be altered.

Copying

First, you need to specify the area to be copied (using the Clipboard In and Out points).

<Note>

The following procedure uses the ABS time as time base on the display. If you wish to use the MTC time or MIDI Bar/Beat/Clock, press the DISP SEL key while holding down the EXECUTE/YES key to change the time base.

Entering and storing the CLIPBOARD IN point

1. Press the **RECALL** key, then the **CLIPBOARD IN** key (or press only the **CLIPBOARD IN** key), and the unit will enter edit mode.
 2. Move the cursor to the digit you wish to change using the **HOLD/>>** key or the **SHUTTLE** dial, and change the value using the **JOG** dial.
 3. After setting the value, press the **STORE** key, then the **CLIPBOARD IN** key. The time value will be stored as the Clipboard In time, edit mode will disengage, and the display will return to the previous screen.
- * You can perform steps 1-3 in real-time. (Pressing the STORE key, then the CLIPBOARD IN key while playing back the recorder will store data.)

Entering and storing the CLIPBOARD OUT point

1. Press the **RECALL** key, then the **CLIPBOARD OUT** key (or press only the **CLIPBOARD OUT** key), and the unit enters edit mode.
 2. Move the cursor to the digit you wish to change using the **HOLD/>>** key or the **SHUTTLE** dial, and change the value using the **JOG** dial.
 3. After setting the value, press the **STORE** key, then the **CLIPBOARD OUT** key. The time value will be stored as the Clipboard Out time, edit mode will disengage, and the display will return to the previous screen.
- * To check the stored In/Out points, press the **CLIPBOARD IN** key and **CLIPBOARD OUT** key respectively. The time value you just stored will be shown on the display.

Copying the track data after storing the CLIPBOARD IN/OUT points

1. Select the copy track using the **RECORD TRACK** select keys (you can select multiple tracks).
 2. Press the **COPY** key. Copy is immediately completed. The display will show "COMPLETED!" and return to the previous screen.
- * In this way, the specified part of the sound data of the selected track(s) is copied to the clipboard.

<Note 1>

If you try to press the COPY key without selecting the copy track(s), the message "SELEct trk" (select a copy track) appears and the display returns to the previous screen. In this case, first select a copy track, then press the COPY key.

<Note 2>

If you set the same or larger value to the In point than Out point and try to execute the Copy function, the display will show "Warning Message" (refer to page "31") and go back to the previous screen. In this case, set the correct In/Out points first.

<Note 3>

The DMT-8 can store only one piece of data on the clipboard. If you copy other data, the new data will replace the existing data.

Listening to sound data copied on the clipboard (Clipboard Play function)

To listen to the sound data currently copied to the clipboard, press the PLAY button while holding down the STOP button (Clipboard Play mode). The data will be played back from the beginning. To stop the playback in the middle, press the STOP button.

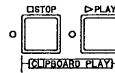

During the clipboard playback, the display shows the position of the source data referenced to the selected time base.

Pasting

You can paste data to the same track as the source. For example, if you copied data on Track 1, data will be pasted on Track 1. Data will be pasted starting from the Auto Punch In point.

<Note>

You cannot out a paste operation if there is insufficient space available on the hard disk. In this case, the "overtime" warning message appears on the display (refer to page "31") as soon as you press the PASTE key, indicating the excessive time calculated using the selected timebase. To prevent this from happening, shorten the copy data by the length of excessive time, or use the Cut function to move the ABS END point backward in order to increase the disk space.

Entering and storing the paste Punch In point

1. Press the **RECALL** key, then the **AUTO PUNCH IN** key (or press only the **AUTO PUNCH IN** key), and the unit enters edit mode.
2. Move the cursor to the digit you wish to edit using the **HOLD/>** key or the **SHUTTLE** dial, and set the value using the **JOG** dial.
3. After setting the time value, press the **STORE** key, then the **AUTO PUNCH IN** key. The time value will be stored as the start point of the pasting area, and the display will go back to the previous screen.

Executing the paste operation

1. Press the **PASTE** key.
The display will show the blinking message "ARE YOU SURE?" and the bottom row of the 7-segment display will show "PAST."
 2. Press the **EXECUTE/YES** key.
When the paste operation is executed, the upper row of the 7-segment display will count the time required to complete the paste operation. When the operation is completed, the display will show "COMPLETED!." Press the **EXIT/NO** key to return to the previous display.
- * In this way, sound data copied on the clipboard can be pasted from the specified Auto Punch In point.
 - * To cancel the paste operation, press the **EXIT/NO** key while the message "ARE YOU SURE?" is blinking on the display.

- If you wish to cancel the paste operation after you press the **EXECUTE/YES** key, press the **STOP** button or the **EXIT/NO** key before the "**COMPLETED!**" message appears on the display.
If you abort the paste operation using this procedure (even in the middle of the operation), no data will be pasted.

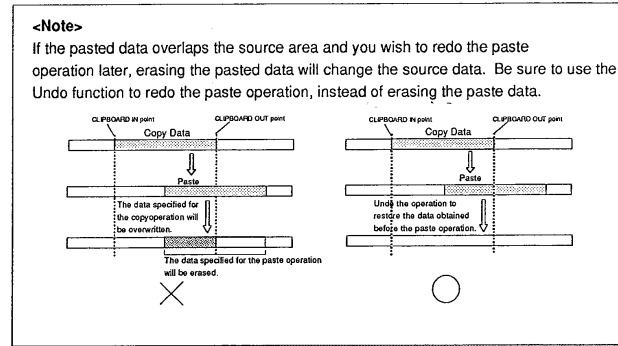

Paste Undo/Redo

If you wish to restore data that existed before you executed the Paste function, press the **UNDO** key to restore the status obtained before you pasted the data. Pressing the **REDO** key after pressing the **UNDO** key will restore the status before the Undo operation (that is, after pasting). The Undo and Redo functions are effective only while the DMT-8 is stopped.

After the **UNDO** key or **REDO** key is pressed, the display will show "**COMPLETED!**" and return to the previous screen.



<Note>

You can use the undo/redo functions while the DMT-8 is in stop mode.

Under the following circumstances, you will be unable to use the undo/redo functions:

1. if you make a new recording,
2. if you make a new edit (paste, erase, or cut),
3. if the Auto Punch In point was passed in play or record mode while Auto Punch mode was on, or
4. if you turned off the power to the DMT-8, then turned it back on.

8-2. Erase & Cut

The Erase function and Cut function are two different function, and are defined as follows on the DMT-8. Make sure that you understand the difference before using these functions.

Erase:

This function deletes (creates silence) only a specified area (between the Auto Punch In and Auto Punch Out points) of any track on the hard disk. Refer to the diagram below. You cannot erase data on all tracks simultaneously. (To erase data, "ready" up to seven tracks using the RECORD TRACK select keys.) Refer to the following note for information on erasing all track data.

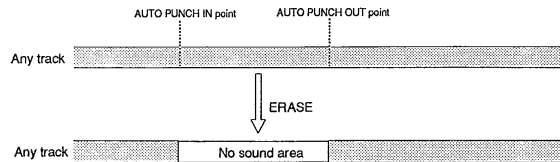

<Note>

The Cut function erases data from all tracks simultaneously (described later).

To erase data from all tracks, divide the tracks into two groups and apply the Erase function to each group. (For example, first erase Tracks 1-4, then erase Tracks 5-8.)

Cut:

This function deletes data starting from a certain point (Auto Punch In point) on the hard disk. You need to set all the tracks RECORD TRACK select keys to "READY." Only the start point is needed. Refer to the following diagram:

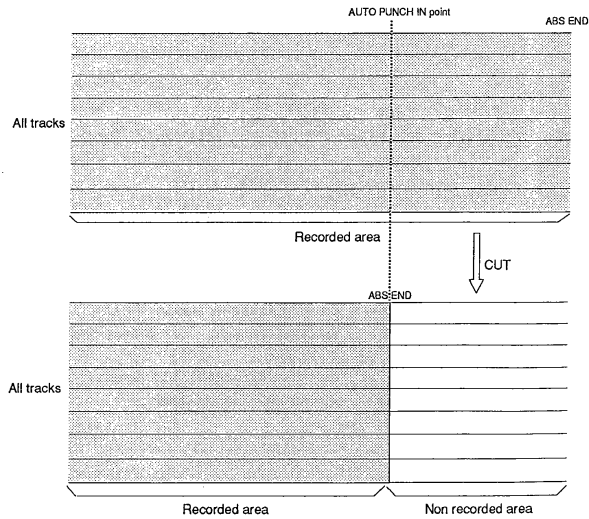

Erasing

Entering and storing the erase Punch In (start) point

1. Press the **RECALL** key, then the **AUTO PUNCH IN** key (or press only the **AUTO PUNCH IN** key), and the unit enters edit mode.
2. Move the cursor to the digit you wish to edit using the **HOLD/>>** key or the **SHUTTLE** dial, and set the value using the **JOG** dial.
3. After setting the time value, press the **STORE** key, then press the **AUTO PUNCH IN** key. The time value will be stored as a start point of the "pasting area", and the display will return to the previous screen.

Entering and storing the erase Punch Out (end) point

1. Press the **RECALL** key, then the **AUTO PUNCH OUT** key (or press only the **AUTO PUNCH OUT** key), and the unit enters edit mode.
 2. Move the cursor to the digit you wish to edit using the **HOLD/>>** key or the **SHUTTLE** dial, and set the value using the **JOG** dial.
 3. After setting the time value, press the **STORE** key, then the **AUTO PUNCH OUT** key. The time value will be stored as an end point of the "erasing area," and the display will return to the previous screen.
- * To check the erase In/Out point, press the **AUTO PUNCH IN** and **AUTO PUNCH OUT** keys respectively. The display will show the stored time value.

Erasing

1. Press the **RECORD TRACK select key** of the track from which you wish to erase data (to ready the track).
 2. Press the **ERASE** key.
The upper row of the 7-segment display will show "ERAS," and the message "ARE YOU SURE?" will blink.
 3. Press the **EXECUTE/YES** key.
The Erase operation starts, and the display counts the time required for the operation in the upper row of the 7-segment display. The bottom row of the 7-segment display will show the blinking message "ERAS."
When the operation is completed, the "ErAS" message is lit on the bottom row of the display, and message "COMPLETED!" appears. Press the **EXIT/NO** key to return to the previous display.
- * In this way, the sound data of the specified area is erased.

Undo/Redo the Erase operation

If you wish to restore data that existed before you executed the Erase function, press the **UNDO** key to restore the status of the DMT-8 before you erased the data. Pressing the **REDO** key after pressing the **UNDO** key will restore the status of the DMT-8 prior to the Undo operation. The Undo and Redo functions are effective only while the DMT-8 is stopped.

After the **UNDO** key or **REDO** key is pressed, the display will show "COMPLETED!" and return to the previous screen.



<Note>

You can use the undo/redo functions while the DMT-8 is in stop mode.

Under the following circumstances, you will be unable to use the undo/redo functions:

1. if you make a new recording,
2. if you make a new edit (paste, erase, or cut),
3. if the Auto Punch In point was passed in play or record mode while Auto Punch mode was on, or
4. if you turned off the power to the DMT-8, then turned it back on.

Cutting

Entering and storing the cut Punch In (start) point

1. Press the **RECALL** key, then the **AUTO PUNCH IN** key (or press only the **AUTO PUNCH IN** key), and the unit enters edit mode.
 2. Move the cursor to the digit you wish to edit using the **HOLD/>>** key or the **SHUTTLE** dial, and set the value using the **JOG** dial.
 3. After setting the time value, press the **STORE** key, then press the **AUTO PUNCH IN** key. The time value will be stored as a start point of the cut area, and the display will return to the previous screen.
- * To check the cut In point, press the **AUTO PUNCH IN** key. The display will show the stored time value.

Executing the cut operation

1. Press the **RECORD TRACK** select key of the track from which you wish to erase data (to ready the track).
 2. Press the **ERASE** key.
The upper row of the 7-segment display will show "Cut," and message "ARE YOU SURE?" will blink.
 3. Press the **EXECUTE/YES** key.
When the operation is complete, the display shows the message "COMPLETED!" then returns to the previous screen.
- * In this way, sound data starting from a specified position is cut, and an unwritten area will be left on the hard disk.

Undo/Redo the Cut operation

If you wish to restore data that existed before you executed the Cut function, press the **UNDO** key to restore the status of the DMT-8 prior to the cut. Pressing the **REDO** key after you press the **UNDO** key will restore the status prior to the Undo operation. The Undo and Redo functions are effective only while the DMT-8 is stopped. After the **UNDO** key or **REDO** key is pressed, the display will show "COMPLETED!" and return to the previous screen.



<Note>

You can use the undo/redo functions while the DMT-8 is in stop mode.

Under the following circumstances, you will be unable to use the undo/redo functions:

1. if you make a new recording,
2. if you make a new edit (paste, erase, or cut),
3. if the Auto Punch In point was passed in play or record mode while Auto Punch mode was on, or
4. if you turned off the power to the DMT-8, then turned it back on.

Chapter 9

Setup mode

The Setup mode of the DMT-8 allows you to set various parameters related to the applications and environment. The following items are included in Setup mode. This chapter explains the basics of Setup mode, including how to set the parameters.

Indication	Function
"BARJ"	Sets the time signature on the Tempo Map (selected from 11 signatures: 1/4 - 8/8).
"TEMPO"	Sets the tempo on the Tempo Map.
"CLICK"	Turns the Metronome function on/off.
"LOAD"	Loads a data file saved on a DAT to the DMT-8.
"SAVE"	Saves recordings/setup data from the hard disk to the DAT machine.
"FORMAT"	Initializes the hard disk.
"PREROLL TIME"	Sets the preroll value for the locate point.
"MIDI SYNC OUT"	Selects the signal output from the MIDI OUT connector.
"FRAME RATE"	Selects the frame rate for MTC output.
"MTC OFFSET"	Sets the offset value between MTC and ABS time.
"ENABLE REC"	Selects recording enable/disable.

9-1. Entering Setup mode

Follow the steps below to select a desired Setup mode:

Procedure:

1. Press the **DISP SEL** key to select Setup mode (the "SETUP" indicator will blink).

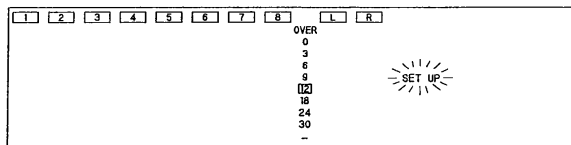

2. Press the **EXECUTE/YES** key. (The "SETUP" indicator will be lit.)
The display will change as shown below, indicating that the DMT-8 has entered the first hierarchy.

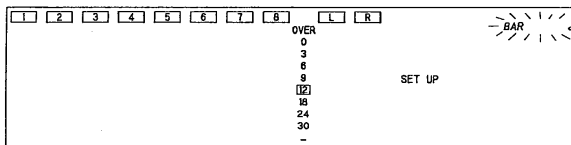

<Note>

When you use the DMT-8 for the first time, or when you turn on the power to the DMT-8 after initializing the hard disk, "BARJ" will blink on the first stage. Otherwise, the SETUP item last specified will be shown.

- Turn the **JOG** dial to show the desired item.
Turning the dial clockwise or counter-clockwise will show each item's title (blinking) on the display.

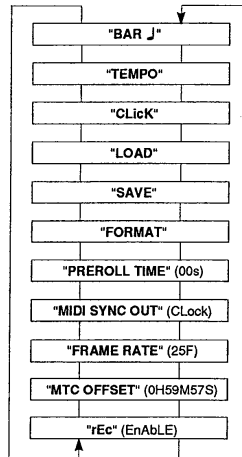

- After displaying the desired **SETUP** item, pressing the **EXECUTE/YES** key again will select each item. (Second stage)

"BAR J" -> Time signature (Default: 1 bar - 4/4)

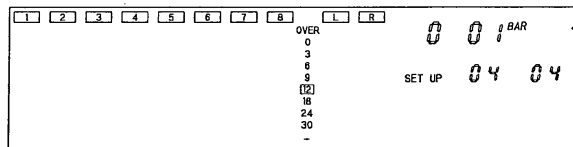

"TEMPO" -> Tempo setting (Default: 1 bar - 1st beat - 120)

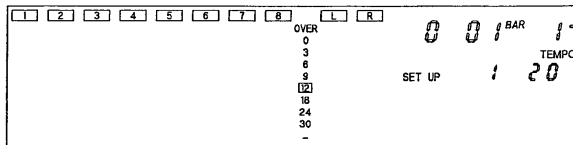

"CLICK"->Metronome function (Default: off)

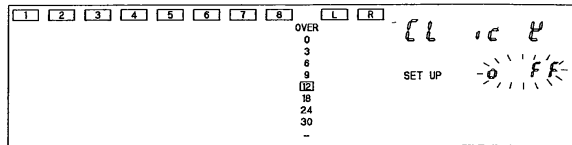

"LOAD"->Load function (DIGITAL IN is blinking: This indicates that digital signal is not being transmitted correctly from an external DAT to the DMT-8.)

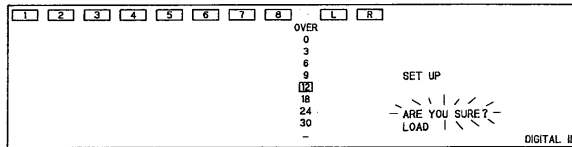

"SAVE"->Save function

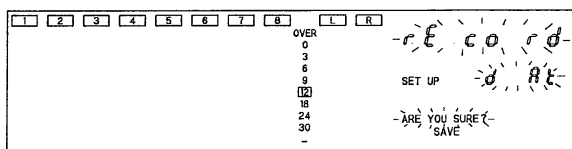

"FORMAT"->Format function

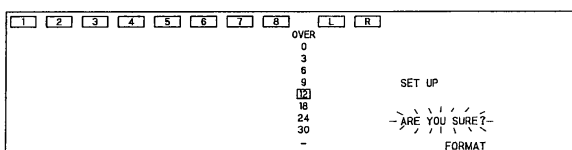

"PREROLL TIME"->Preroll Time setting (Default: 00s)

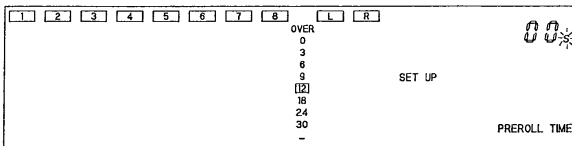

"MIDI SYNC OUT"->MIDI SYNC OUT setting (Default: Clock signal)

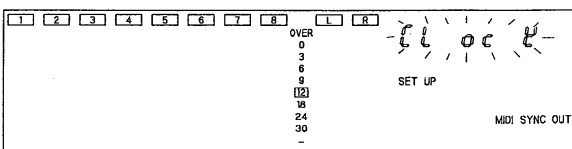

"FRAME RATE"->MTC Frame Rate setting (Default: 25F)

1	2	3	4	5	6	7	8	L	R
								OVER	
								0	
								3	
								6	
								9	SET UP
								12	25*
								18	FRAME RATE
								24	
								30	
								-	

"MTC OFFSET"->MTC Offset setting (Default: 0H:59M:57S)

1	2	3	4	5	6	7	8	L	R
								OVER	
								0	0 H 59 M 57 S*
								3	
								6	
								9	SET UP
								12	MTC OFFSET
								18	
								24	
								30	
								-	

"rEc"->Recording enable/disable setting (Default: ENABLE)

1	2	3	4	5	6	7	8	L	R
								OVER	
								0	- E n A b l E -
								3	
								6	
								9	SET UP
								12	r E c
								18	
								24	
								30	
								-	

- Press the **STOP** button or the **EXIT/NO** key to change your selection or to exit Setup mode. Each time you press the **STOP** button or the **EXIT/NO** key, the display will return to the previous stage, allowing you to select a different item or to exit Setup mode. Now you have selected the SETUP items. The following paragraphs explain how to set and execute each item. Refer to the following information on each item for details.

9-2. Setting the time signature ("BAR J")

Setup item "BAR J" sets a time signature for a measure.

For example, the first and second measures could have a time signature of 4/4, and the third and subsequent measures could have a time of 2/4. You can set up 16 points in any time signature for each measure.

Procedure:

1. Press the **DISP SEL** key to select "SETUP", then press the **EXECUTE/YES** key. (The "SETUP" indicator will light up.) Use the **JOG** dial to select "BAR J" (blinking), then press the **EXECUTE/YES** key. (The "BAR J" indicator will light up.) (In the initial setting, the first measure has a time signature of 4/4. This means that the following measures will be played with a time signature of 4/4 unless you set a different time signature after the first measure.)

In this case, turning the **JOG** dial will allow you to check the current time signatures one by one.

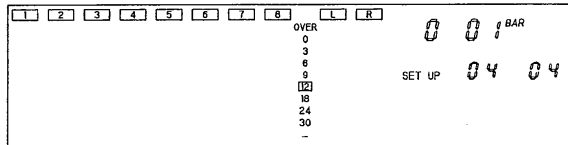

2. Press the **EXECUTE/YES** key again. "BAR" on the display will blink, and you will be able to edit the BAR (measure) parameter. Use the **JOG** dial to enter a desired measure number, then use the **HOLD/>** key or the **SHUTTLE** dial so that "J" is blinking, enabling you to edit a time signature. Turn the **JOG** dial to enter a time signature value for the specified measure.

Measures for the "BAR" parameter:	001 - 999
Time signature for the "J" parameter:	1/4, 2/4, 3/4, 4/4, 5/4, 1/8, 3/8, 5/8, 6/8, 7/8, 8/8, ---, * "--" means "none" and is used to delete time signature data.

3. Each time you enter bar and time signatures, press the **EXECUTE/YES** key to store the setting. Repeat this step to set the necessary time signature for the bar.
 - * You cannot assign "--" to measure 001.
 - * To cancel edit or quit Setup mode, press the **STOP** button or the **EXIT/NO** key. Pressing the **STOP** button or the **EXIT/NO** key repeatedly will step back through the previous settings, then quit Setup mode.

Follow the procedure below to modify (delete) a stored time signature

1. While the "BAR" indicator is blinking, turn the **JOG** dial to enter the number of the measure you wish to modify. The measure number and time signature you set will be displayed.
2. Use the **HOLD/>** key or the **SHUTTLE** dial to move the cursor to the blinking "J" field.
3. Use the **JOG** dial to enter a new time signature value. Assigning "--" deletes the stored value.

4. After modifying the value, press the **EXECUTE/YES** key.

- If the bar/beat position of the tempo data (stored by the tempo setting procedure explained later) is lost when you modify or delete the stored beat data, the tempo data will be automatically erased for ever. (For example, if you change the time signature to 3/4 for BAR 001, the existing tempo data at BAR 001 4J will be automatically deleted.)
- To cancel a selection or quit Setup mode, press the **STOP** button or the **EXIT/NO** key.
Pressing the **STOP** button or the **EXIT/NO** key repeatedly will step you back through the previous settings, then quit Setup mode.

Follow the procedure below to clear all stored beat/tempo data

1. While "BAR" is blinking, turn the **JOG** dial counter-clockwise. The information on the first measure will appear, followed by subsequent information. The beat data and the tempo data (explained later) will be ready for the all-clear operation.

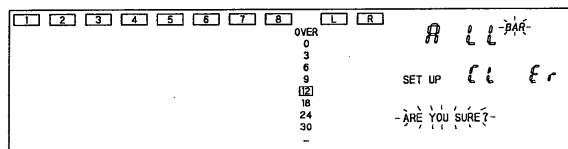

2. Press the **EXECUTE/YES** key.

All stored time signature and tempo data will be cleared, and the default setting will be restored.

- If you do not want to clear all of the time signature and tempo data, press the **STOP** button or the **EXIT/NO** key.

<Note>

If you attempt to enter time signature and tempo data in a position that exceeds the maximum recording time, the value will be not effective.

9-3. Tempo setting ("TEMPO")

The Setup "TEMPO" allows you to set the tempo on the tempo map.

You can set up to 32 points in the range of quarter note = 30 to 250 at any position in the song (if it has been structured by the beat settings). For example, you can set a specific tempo value on a specific beat in the certain measure.

The setting sequence is "BAR" -> "J" -> "TEMPO."

Procedure:

1. Press the **DISP SEL** key to select "**SETUP**" and press the **EXECUTE/YES** key. ("SETUP" will light up.) Then, use the **JOG** dial to select "**TEMPO**" (blinking) and press the **EXECUTE/YES** key. ("TEMPO" will light up.)

At this time, turning the **JOG** dial allows you to check the current tempo settings one by one. (The default value for the first beat of the first bar is 120. This means that unless you set a different tempo after the first beat of the first measure, the tempo will continue to be J = 120.)

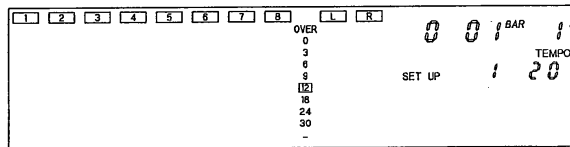

2. Press the **EXECUTE/YES** key again.

"**BAR**" on the display will blink, indicating that "**BAR**" (measure) can be edited now. Use the **HOLD/>** key or **SHUTTLE** dial to select a desirable editing item ("**BAR**", "**J**", or "**TEMPO**"), modify the value using the **JOG** dial, and press the **EXECUTE/YES** key.

- * Bar and beat values for "BAR J" -> The range of the bar and beat specified by the time signature settings.
- * Values for "TEMPO" -> 30 to 250, and -- ("--" indicates "none" and is used to delete tempo data.)
- * You cannot store "--" in the position of 001^{BAR} 1^J.

<Example>

After setting the time signature as follows, set a desired tempo.

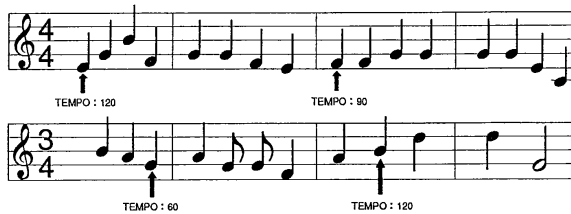

Tempo Map	
Time Signature	Tempo
001 ^{BAR} 0404	001 ^{BAR} 1 ^J 120 ^{TEMPO}
	003 ^{BAR} 1 ^J 90 ^{TEMPO}
005 ^{BAR} 0304	005 ^{BAR} 3 ^J 60 ^{TEMPO}
	007 ^{BAR} 2 ^J 120 ^{TEMPO}

Follow the procedure below to modify or delete stored tempo data

1. While "**BAR**" is blinking, turn the **JOG** dial to recall the measure in which the tempo data to be modified is stored.
2. While "**J**" is blinking (move the cursor here using the **HOLD/>>** key or the **SHUTTLE** dial), use the **JOG** dial to recall the beat at which the tempo data to be modified is stored. (The display will show the current tempo data setting.)
3. While "**TEMPO**" is blinking, enter a new tempo value using the **JOG** dial.
If you select "- --" (located between 30 and 250), stored data will be deleted.
4. When you finish modifying the value, press the **EXECUTE/YES** key.
 - * If you wish to cancel the procedure or quit Setup mode, press the **STOP** button or the **EXIT/NO** key.
Pressing the **STOP** button or the **EXIT/NO** key repeatedly will take you to the step just before you quit Setup mode.

Follow the procedure below to clear all stored tempo data

Refer to "9-2 Setting the Time Signature" to clear all tempo data along with the time signature data.

So far, the time signature and tempo have been set on the tempo map.

The tempo map information will be output as the MIDI clock and Song Position Pointer information to an external sequencer via the DMT-8 MIDI OUT connector. (Refer to page "65" for details about the MIDI clock sync system.)

In addition, using the metronome function on the DMT-8 allows you to play back the tempo map data on track 8 using the click sound. Refer to the following section for information on the metronome function.

<Note>

The DMT-8 will play back only recorded data from the disk.
If nothing has been recorded, no tempo map information will be output from the MIDI OUT connector.

9-4. Metronome Function On/Of ("CLICK" ON/OFF)

You can listen to the data set in the "Setting the time signature" and "Setting the tempo" using the metronome sound. You can also record the parts to accompany the metronome sound.

<Note>

When the metronome function is ON, Track 8 will play back the metronome sound. Therefore, you cannot play back recorded audio data on Track 8. Do not set Track 8 to record mode while the metronome sound is playing.
When the metronome function is ON, Track 8 will play the metronome sound regardless of the MIDI SYNC OUT setting.

Procedure:

1. Press the **DISP SEL** key to select "**SETUP**," and press the **EXECUTE/YES** key. Use the **JOG** dial to select "**CLiCk**" (blinking) and press the **EXECUTE/YES** key. "**CLiCk**" will light up, and the display will show the current setting. (The default setting is "off.")

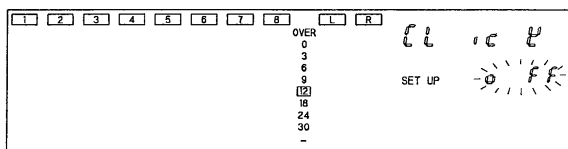

2. Use the **JOG** dial to select "on" or "off."
Turning the **JOG** dial clockwise will select "on," and turning it counter-clockwise will select "off." (In this example, turn the dial clockwise to select "on.")
3. Press the **EXECUTE/YES** key again.
Press the **STOP** button or the **EXIT/NO** key to quit Setup mode (as explained previously).
4. Set the recorder in Play mode to monitor the metronome sound.
Set the Track 8 **INPUT SEL** switch to "**INTPUT**," the master fader **L/R** to "7-8," and **PHONES** knob accordingly. Then, use the **SUB GAIN** control and **PAN** control to adjust the volume level and stereo image.

<Note>

The DMT-8 will play back only recorded data from the disk. If nothing has been recorded, the metronome sound will not play.

9-5. Saving and loading the recordings ("SAVE", "LOAD")

You can save recordings (audio data + Setup data) from the hard disk of the DMT-8 to an external DAT machine. Also, you can load and play back data saved on a DAT machine.

The Save and Load functions are useful when you wish to start a new project, since you can save complete or partial projects.

It takes four times longer to save or load data to/from a DAT machine than the actual length of the audio data on the hard disk, because the Save and Load functions are executed as illustrated below.

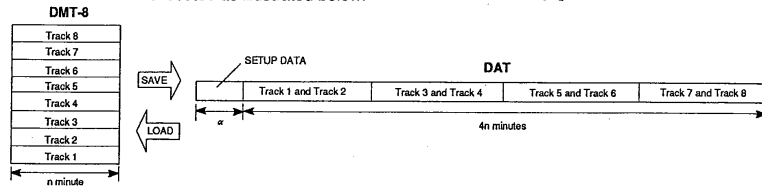

Connecting a DAT machine to save/load data

- * Use optical cables to connect the DMT-8 DATA IN connector with the DAT OPTICAL OUT connector, and the DMT-8 DATA OUT connector with the DAT OPTICAL IN connector.
- * Insert a DAT recording tape in the DAT machine.
- * Set the DAT machine so that it will record digital data input from the optical connector. For more information on DAT settings, refer to the instruction manual that came with your DAT machine.

<Note>

To save and load data, you can use only a DAT machine that allows for digital recording with 16 bit/44.1kHz, non-compression recording, optical, S/P DIF format. Other media cannot be used appropriately for save/load operations. For example, you cannot use an MD or DCC that uses a compression recording method, a CD-R machine that makes an automatic correction between songs, any devices that convert sampling rates, or any devices that have Adat optical connectors. Some devices equipped with SCMS can be used if they satisfy the conditions described above.

The following models can correctly save/load data. Basically, any DAT machines equipped with optical in/out connectors in the S/P DIF format should work fine. However, please note that some models may cause errors to occur.

FOSTEX: D-10, D-5
SONY: DTC-D7, DTC-790

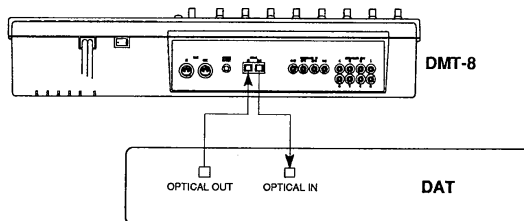

<Note>

When you are loading data from a DAT connected to the DMT-8 (as shown in the figure on page 101), and if that DAT plays back data in sync with an external clock (e.g., if it is a professional level DAT machine) with its INPUT (or EXTERNAL SYNC) switch set to "OPTICAL," the digital clock will form loops as shown below, preventing the DMT-8 from loading data correctly.

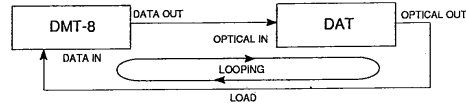

In this case, set the DAT sync mode to "INTERNAL" or remove the optical cable from the DMT-8 DATA OUT connector. (On the other hand, while data is saved, its DATA IN will not function. Thus, no problem will occur.)

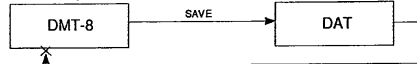
**Saving data to a DAT machine (SAVE)**

1. Press the **DISP SEL** key to select "SETUP" and press the **EXECUTE/YES** key. ("SETUP" will light up.) Turn the **JOG** dial to select "SAVE" (blinking) and press the **EXECUTE/YES** key. The display will change as shown below, and the DMT-8 will enter save stand-by mode.

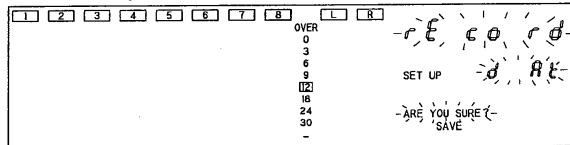

2. Start recording on the **DAT** machine, and press the **EXECUTE/YES** key again on the DMT-8. The Save operation will start, and the display will count down the time (a negative number appears) required for the save operation.
 - * To save the entire data, it takes four times longer than the actual length of the data recorded on the hard disk. For example, if the data is four-minutes long, it will take about 16 minutes to save the data.
3. When saving all data is finished, the display will show "COMPLETED!" and the unit will automatically quit Setup mode.

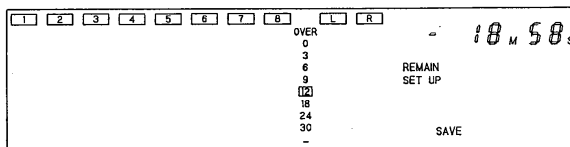

- * To cancel the save operation or quit Setup mode, press the **STOP** button or the **EXIT/NO** key. Each time you press the **STOP** button or the **EXIT/NO** key, the display will return to the previous stage, allowing you to select a different item or exit Setup mode.

Loading data from a DAT machine (LOAD)

1. Press the **DISP SEL** key to select **"SETUP"** and press the **EXECUTE/YES** key. ("SETUP" will light up.) Turn the **JOG** dial to select **"LOAD"** (blinking) and press the **EXECUTE/YES** key. The display changes as shown below, and the DMT-8 enters load stand-by mode.

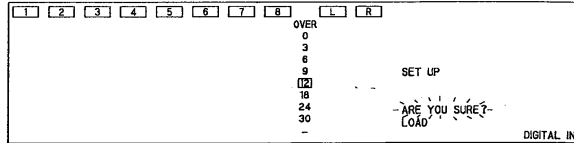
**<Note>**

If optical cables are not connected to the DATA IN/OUT connectors, or if a correct signal (digital clock) is not being supplied to the DMT-8, "DIGITAL IN" on the display will blink, indicating that you are unable to load data. In this case, check the optical cable connections, the DAT output settings, and the contents of the DAT tape.

2. Press the **EXECUTE/YES** key again.

"PLAY dAt" starts blinking on the display as shown below. Place the DAT machine in playback mode. The Load operation will start, and the display will count down the time (a negative number appears) required for the load operation.

- To cancel the load operation, press the **STOP** button or the **EXIT/NO** key. Pressing this key will cancel the load operation, and the unit will quit Setup mode.

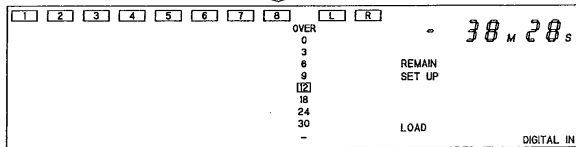
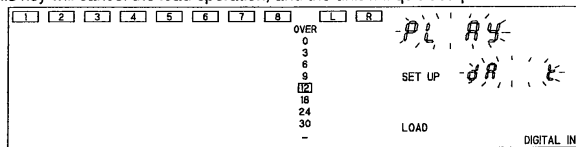

3. When loading all data is finished, the display will show **"COMPLETED !"** and the unit will automatically quit Setup mode.

<Note>

Once you start loading data from a DAT machine, all data existing on the hard disk will be erased, even if you cancel the operation in progress, and only new data (the portion of the data after you cancelled) will be effective. For example, if you load a new song of two minutes duration to a DMT-8 that already contains a six-minute song, no data will remain after two minutes. (At this time, the ABS END time becomes "2 minutes.") Bear this in your mind, and be sure to save important data from the hard disk to a safe place before loading additional data.

9-7. Setting the preroll time for the Locate operation ("PREROLL TIME")

The DMT-8 is equipped with a preroll function that parks the DMT-8 a specified time before the locate point when you perform the locate operation.

You can set any preroll time between 0-10 seconds using the Setup "PREROLL TIME" parameter. This function is useful when you wish to start monitoring data slightly before the stored locate point.

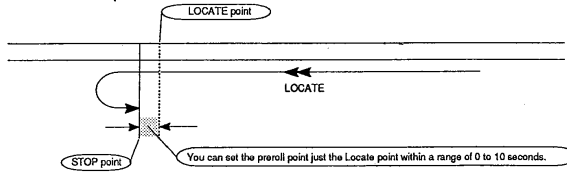

Procedure:

1. Press the **DISP SEL** key to select "SETUP" and press the **EXECUTE/YES** key. ("SETUP" will light up.) Turn the **JOG** dial to select "PREROLL TIME" (blinking), and press the **EXECUTE/YES** key.

The display will change as shown below, and will show the default value. (The default setting is 00 second.)

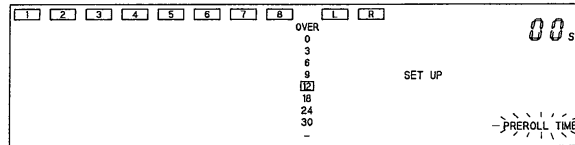

2. Press the **EXECUTE/YES** key again. ("PREROLL" will light up.) "S" on the display will blink, indicating that you can edit the value.

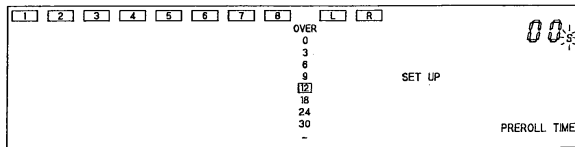

3. Use the **JOG** dial to enter a desirable preroll time. Turning the dial clockwise will increment the value, and turning it counter-clockwise will decrement the value.
4. After setting the value, press the **EXECUTE/YES** key again. The display will go back to that obtained in step 2, and the setting will be complete.
5. Press the **STOP** key or **EXIT/NO** key to quit Setup mode.

9-8. Selecting the synchronized signal output from the MIDI OUT connector ("MIDI SYNC OUT")

Setup "MIDI SYNC OUT" allows you to select the sync signal output from the DMT-8 MIDI OUT connector to the external MIDI device.

Output signals can be MIDI Clock & Song Position Pointer, or "Mtc" (MIDI timecode). Select "Clock signal," "Mtc," or "None" according to your application.

Procedure:

1. Press the **DISP SEL** key to select **"SETUP"** and press the **EXECUTE/YES** key. ("SETUP" will light up.) Turn the **JOG** dial to select **"MIDI SYNC OUT"** (blinking), and the display will change as shown below and show the default setting. (The default setting is "CLock.")

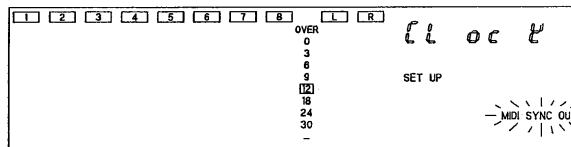

2. Press the **EXECUTE/YES** key again. "CLock" on the display will blink, indicating that you can edit the parameter.

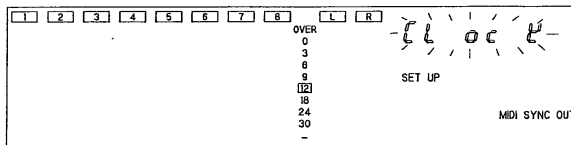

3. Select a desirable option using the **JOG** dial.

CLock	MIDI Clock signal and song position pointer is output.
Mtc	MIDI timecode is output.
oFF	No signal is output.

4. After selection, press the **EXECUTE/YES** key again. The display will return to that displayed in step 1, and the setting will be complete.
5. Press the **STOP** button or the **EXIT/NO** key to quit Setup mode.

■ See pages "64" and "66" for more information on using a DMT-8 connected to a MIDI sequencer or computer.

9-9. Setting the MTC Frame Rate ("FRAME RATE")

"FRAME RATE" in Setup mode allows you to set the MTC frame rate when you select "MTC" for the "MIDI SYNC OUT" parameter to output MIDI timecode to an external computer. You can select 25F, 24F, 30DF, or 30ND for a frame rate.

Procedure:

1. Press the **DISP SEL** key to select **"SETUP"** and press the **EXECUTE/YES** key. ("SETUP" will light up.) Turn the **JOG** dial to select **"FRAME RATE"** (blinking), and the display will change as shown below and will display the default setting. (The default setting is "25F".)

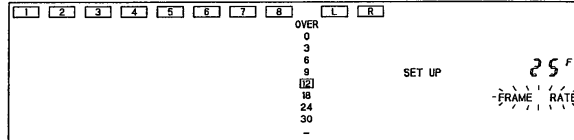

2. Press the **EXECUTE/YES** key again. "F" on the display will blink, indicating that you can edit the parameter.

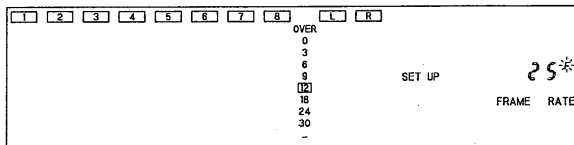

3. Select a desirable option using the **JOG** dial.

25	25 frames
24	24 frames
dF 30	30 drop frames
nd 30	30 non-drop frames

4. After you select a frame rate, press the **EXECUTE/YES** key again. The display will return to that displayed in step 1, and the setting will be complete.
5. Press the **STOP** button or the **EXIT/NO** key to quit Setup mode.

9-10. Setting MTC Offset Time ("MTC OFFSET")

"MTC OFFSET" in Setup mode allows you to create a time offset from ABS time when you select "MTC" for the "MIDI SYNC OUT" parameter to output MIDI timecode to an external computer. You can specify any time within a range of 0^H:00^M:00^S - 5^H:59^M:59^S.

Procedure:

1. Press the **DISP SEL** key to select "**SETUP**" and press the **EXECUTE/YES** key. ("SETUP" will light up.) Turn the **JOG** dial to select "**MTC OFFSET**" (blinking), and the display will change as shown below and will display the default setting. (The default setting is "0:59:57.")

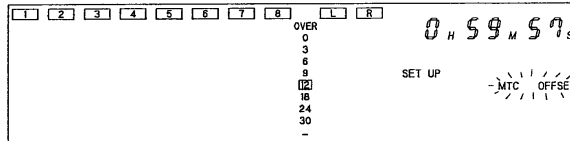

2. Press the **EXECUTE/YES** key again. "S" on the display will blink, indicating that you can edit the parameter. Use the **HOLD/>** key or the **SHUTLE** dial to select the digit you wish to edit (hour, minute, second), and use the **JOG** dial to set or change the value.

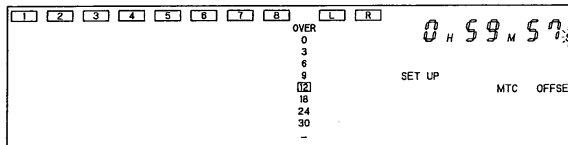

3. After setting the value, press the **EXECUTE/YES** key again. The display will return to that displayed in step 1, and the setting will be complete.
4. Press the **STOP** button or the **EXIT/NO** key to quit Setup mode.

9-11. Setting Recording Enable/Disable mode ("rEc" ENABEL/DISABLE)

"REC ENABLE" in Setup mode is used to turn on/off recording enable/disable mode to prevent accidental recording. (This function is similar to breaking the tab on a cassette tape to protect a recording.)

<Note>

If you select record disable mode (rEc DISABLE), and you try to record, paste, erase, or cut data on any selected track, the display will show "diSAbL rEc" for about one second, indicating that these operations are disabled. If you wish to use one of these operations, first select record enable mode (rEc ENABLE).

Procedure:

1. Press the **DISP SEL** key to select "SETUP" and press the **EXECUTE/YES** key. ("SETUP" will light up.) Turn the **JOG** dial to select "ENABLE REC" (blinking), and the display will change as shown below and will display the default setting. (The default setting is "ENABLE.")

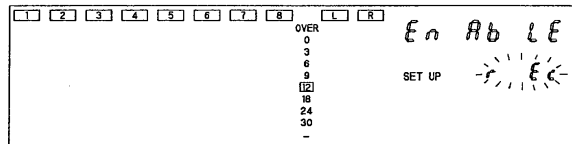

2. Press the **EXECUTE/YES** key again.

"ENABLE" on the display will blink, indicating that you can edit the parameter.

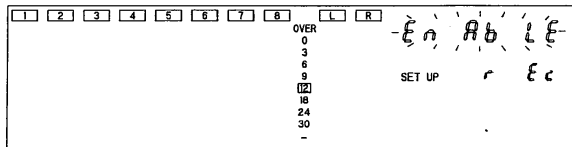

3. Turn the **JOG** dial clockwise to select "REC DISABLE," or turn it counter-clockwise to select "REC ENABLE."
4. After setting the value, press the **EXECUTE/YES** key again.
The display will return to that displayed in step 1, and the setting will be complete.
5. Press the **STOP** button or the **EXIT/NO** key to quit Setup mode.

Model DMT-8		MIDI Implementation Chart		Date: V1.10
Function.....		Transmitted	Recognized	Remarks
Basic Channel	Default	x	x	
	Changed	x	x	
Mode	Default	x	x	
	Message	x	x	
	Altered	*****	x	
Note Number:	True voice	x	x	
		*****	x	
Velocity	Note ON	x	x	
	Note OFF	x	x	
After Touch	Key's	x	x	
	Ch's	x	x	
Pitch Bend		x	x	
Control Change		x	x	
Prog Change:	True #	x	x	
		*****	x	
System Exclusive		○ (rem. 1)	○ (rem. 2)	
Common	: Song Position	○	x	
	: Song Select	x	x	
	: Tune	x	x	
System Real Time	: Clock	○	x	
	: Commands	x	x	
Aux Messages	: Local ON/OFF	x	x	
	: All Notes OFF	x	x	
	: Active Sense	x	x	
	: Reset	x	x	
Notes		rem. 1: MMC (Device ID=00), MTC, Identity reply rem. 2: MMC (Device ID=00 or 7F), Identity request		

Mode 1: OMNI ON, POLY Mode 2: OMNI ON, MONO ○ : Yes
 Mode 3: OMNI OFF, POLY Mode 4: OMNI OFF, MONO x : No

MMC Command List

●Command List	Movement (Recorder)
01: STOP	STOP
02: PLAY	PLAY
03: DEFERRED PLAY	DEFERRED PLAY
04: FAST FORWARD	F FWD
05: REWIND	REWIND
06: RECORD STROBE	REC
07: RECORD EXIT	PUNCH OUT
40: WRITE	Refer to MMC Response/Information Field List.
41: MASKED WRITE	Refer to MMC Response/Information Field List.
42: READ	Refer to MMC Response/Information Field List.
44: LOCATE	LOCATE to Setting Data
47: SHUTTLE	CUE/REVIEW ($\pm 1 \sim 60$ times)

●MMC Response/Information Field List	Command
01: SELECTED TIME CODE	READ
48: MOTION CONTROL TALLY	READ
4C: RECORD MODE	READ/WRITE
4E: TRACK RECORD STATUS	READ
4F: TRACK RECORD READY	READ/WRITE/MASKED WRITE
51: RECORD MONITOR	READ/WRITE

Inquiry Message List

IDENTITY REQUEST: F0, 7E, 01, 06, 01, F7
 IDENTITY REPLY: F0, 7E, 01, 06, 02, 51, 01, 00, 09, 00, 01, 00, 7F, 7F, F7

51: Fostex ID
 01, 00: Device family code
 09, 00: Device family number DMT
 01, 00, 7F, 7F: Software version

Maintenance

Cleaning the exterior

*** For normal cleaning, use a soft dry cloth.**

For stubborn dirt, moisten a cloth in diluted detergent, wring it out firmly, and wipe the dirt off. Then polish with a dry cloth.

Never use solvents such as alcohol, thinner or benzene, since these will damage the printing and finish of the exterior.

Specifications

Mixer Section

Input/Output

Input (x 8)

Input 1 ~ 4

Connector : ϕ 6 phone jack/unbalanced
 Input impedance : 20k Ω or more
 Input level : -50dBV ~ -10dBV variable

Input 5 ~ 8

Connector : ϕ 6 phone jack/unbalanced
 Input impedance : 20k Ω or more
 Input level : -10dBV

Insert (x 4) input and output

Connector : Stereo ϕ 6 phone jack/unbalanced

Output (TIP)

Load impedance : 10k Ω or more
 Output level : -10dBV

Input (RING)

Input impedance : 20k Ω or more
 Input level : -10dBV

AUX SEND 1, 2

Connector : ϕ 6 phone jack
 Load impedance : 10k Ω or more
 Output level : -10dBV

AUX RTN 1, 2 (L, R)

Connector : ϕ 6 phone jack
 Input impedance : 10k Ω or more
 Input level : -20dBV

STEREO BUSS IN (L, R)

Connector : RCA pin jack
 Input impedance : 10k Ω or more
 Input level : -10dBV

RECORDER IN (x 4)

Connector : RCA pin jack
 Load impedance : 20k Ω or more
 Output level : -10dBV

RECORDER OUT (x 8)

Connector : RCA pin jack
 Load impedance : 10k Ω or more
 Output level : -10dBV

STEREO OUT (L, R)

Connector : RCA pin jack
 Load impedance : 10k Ω or more
 Output level : -10dBV

MONITOR OUT (L, R)

Connector : ϕ 6 phone jack
 Load impedance : 10k Ω or more
 Output level : -10dBV

HEADPHONE

Connector : ϕ 6 stereo phone jack
 Matching load impedance : 8 ~ 50 Ω
 Maximum output level : 100mW or more

EQUALIZER

Parametric type
 HI - MID : 1kHz ~ 16kHz +/- 15dB
 LOW - MID : 60Hz ~ 1kHz +/- 15dB

FREQUENCY RESPONSE

: 20Hz ~ 20kHz +/- 15dB

DYNAMIC RANGE

: 105dB or more

Recorder Section**Input/Output****DATA IN/OUT**

Connector : Optical (x 2)
 Format : IEC 958 Part 2 (=S/P DIF)

MIDI IN/OUT

Connector : DIN 5PIN (x 2)
 Format : Complying to MIDI standard

PUNCH IN/OUT

Connector : ϕ 6 phone jack (An optional FOOT SW Model 8051 can be connected.)

Recording/reproducing

Recording medium : 3.5 inch, 54MB, hard disk x 1 (IDE type)
 Sampling frequency : 44.1kHz
 Quantization : 16-bit linear
 Recording time : About 12.5 min.

No. of recording track : 8 tracks
Crossfade : 10msec.
Recording/reproducing frequency : 20Hz ~ 20kHz
Dinamic range : 92 dB or more

General

Dimensions : 568 (W) x 121 (H) x 432 (D) mm
Weight : About 7.5kg
Power supply : 120VAC 60Hz
: 230V~ 50/60Hz
Power consumption : About 33W

*** Specifications and appearance are subject to change without notice for product improvement.**

Block Diagram

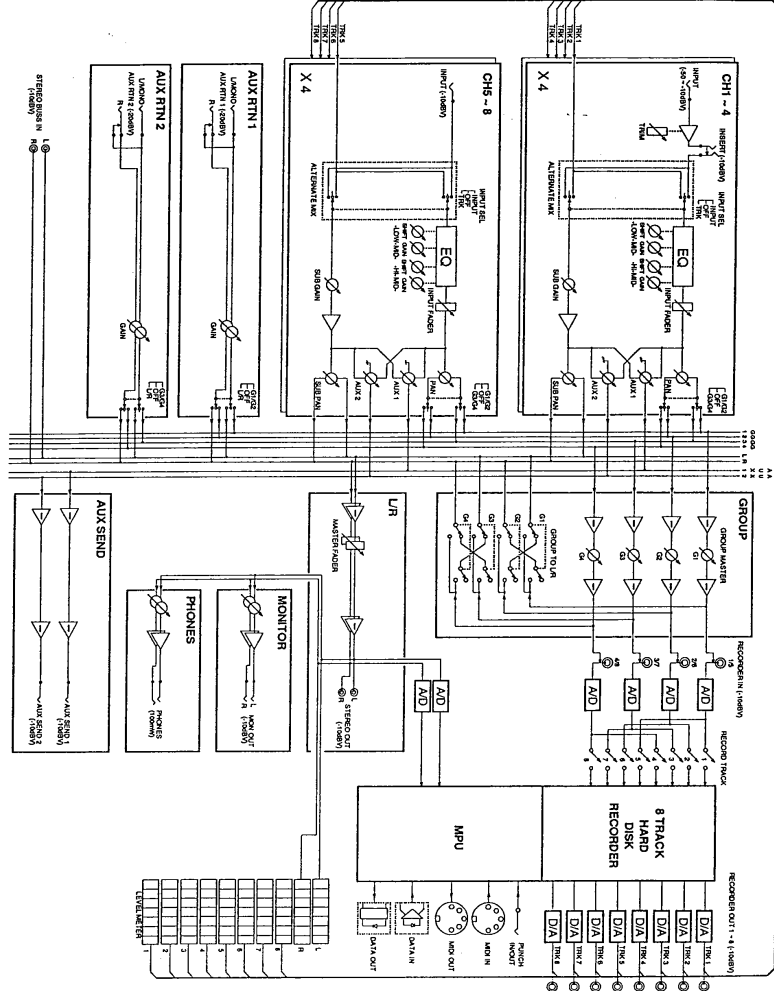

INDEX

- [A]**
- AUX send knob 14
 - AUX return level control 15
 - AUX return assign switch 15
 - Auto play/Auto return key 17
 - Auto punch mode ON/OFF key 18
 - Auto punch in key 21
 - Auto punch out key 21
 - Auto return start key 22
 - Auto return end key 22
 - AUX return jack 26
 - AUX send jack 26
 - ABS time display 29
 - ABS 36
 - AUX bus 37
 - Alternate mix section 38
 - Auto Punch In/Out rehearsal mode 72
 - Auto Punch In/Out take mode 74
 - Auto play mode 80
 - Auto return mode 80
 - Auto repeat mode 84
- [B]**
- BAR/BEAT/CLK display 30
 - Before strating (Glossary) 34
 - BAR/BEAT/CLK 36
 - Basic recording 42
 - Block diagram 115
- [C]**
- Clipboard in key 18
 - Clipboard out key 18
 - Copy key 18
 - Channel 34
 - Changing the stored start/end point 83
 - Copying 86
 - Cutting 91
 - Can't UNDO 31, 74
- [D]**
- Display select key 20
 - DATA IN connector 27
 - DATA OUT connector 27
 - DISK remain display 29
 - Disk error indication 33
 - Difference between track and channel 34
 - Difference from a tape MTR 35
 - Default settings on the DMT-8 41
 - Direct locate 79
- [E]**
- Equalizer section 13
 - Erase key 19
 - Execute/Yes key 21
 - Exit/No key 21
 - Display 28
 - Event overflow indication 32
 - Error indication 33
 - Effect connection 39, 40
 - Editing and storing the start/end point 82
 - Edit function 85
 - Erasing 90
 - Entering Setup mode 92
- [F]**
- Fast forward button 25
 - Formatting the hard disk 104
 - Frame rate 107
- [G]**
- Group assign panpot knob 14, 38, 57
 - Group assign switch 14, 38, 57
 - Group master level control 15
 - Group to L/R switch 15
 - Group bus 37
- [H]**
- HI-MID gain control knob 13
 - HI-MID shift knob 13
 - Headphone level control 15
 - Hold/Digit move key 22
 - Hard disk operation LED 23
 - Headphone connector 25
- [I]**
- Introduction 5
 - Input select switch 13, 57
 - INPUT fader 14
 - Input jack 25
 - Insert jack 25
 - Invalid data indication 31
 - Invalid In/Out indication 31
 - Input monitor 35
 - Inquiry message list 111
- [J]**
- Jog dial 23
- [L]**
- LOW-MID gain control knob 13
 - LOW-MID shift knob 13
 - Locate key 20

- | | |
|--|---------|
| Load error indication | 32 |
| Locate function | 79 |
| Loading data from a DAT machine | 102 |
| [M] | |
| Main features of recorder section | 8 |
| Main features of mixer section | 10 |
| Monitor level control | 15 |
| Master fader | 16 |
| Meter display | 16 |
| Monitor out jack | 26 |
| MIDI IN connector | 26 |
| MIDI OUT connector | 26 |
| MTC display | 30 |
| MTC | 36 |
| Monitoring reverb | 51 |
| Mixdown | 56 |
| MIDI clock synchronization system | 65 |
| MTC synchronization system | 67 |
| Metronome function ON/OFF | 100 |
| MIDI SYNC OUT | 106 |
| MTC OFFSET | 108 |
| MIDI implementation chart | 110 |
| MMC command list | 111 |
| Maintenance | 112 |
| [N] | |
| Notes about power supply | 5 |
| Notes on handling the hard disk | 6 |
| Notes on the setup location | 6 |
| Notes on repair | 6 |
| [O] | |
| Overtime indication | 31 |
| Overdubbing | 46 ~ 55 |
| [P] | |
| Precautions | 5 |
| Paste key | 19 |
| Play button | 24 |
| Punch in/out jack | 27 |
| Power switch | 27 |
| Power cable | 27 |
| Preset display | 28 |
| Parametric equalizer | 40 |
| Ping-pong recording | 63 |
| Punch In/Out | 69 |
| Punch In/Out recording using a foot switch | 75 |
| Punch In/Out rehearsal using a foot switch | 76 |
| Punch In/Out take using a foot switch | 78 |
| Pasting | 87 |
| Paste Undo/Redo | 88 |
| Preroll time | 105 |
| [R] | |
| Record track select key | 17 |
| Redo key | 20 |
| Recall key | 23 |
| Record button | 24 |
| Rewind button | 24 |
| Recorder in jack | 27 |
| Recorder out jack | 27 |
| Repro monitor | 35 |
| Recording four tracks simultaneously | 60 |
| REC ENABLE/DISABLE | 109 |
| [S] | |
| SUB mix section | 13 |
| SUB panpot knob | 13 |
| SUB gain control knob | 13 |
| Store key | 22 |
| Shuttle dial | 23 |
| Stop button | 24 |
| Stereo out L/R jack | 26 |
| Stereo bus in jack | 26 |
| SETUP mode display | 30 |
| STEREO bus | 37 |
| Storing the Punch In point | 71 |
| Storing the Punch Out point | 72 |
| Setting the auto return start/end point | 81 |
| Storing the start/end point in real-time | 81 |
| SETUP mode | 92 |
| Setting the time signature | 96 |
| Setting tempo | 98 |
| Saving and Loading the recordings | 101 |
| Saving data to a DAT machine | 102 |
| Setting the preroll time for the locate operation | 105 |
| Selecting the synchronized signal output from the MIDI OUT connector | 106 |
| Setting the MTC frame rate | 107 |
| Setting MTC Offset time | 108 |
| Setting recording enable/disable mode | 109 |
| Specifications | 112 |
| [T] | |
| TRIM fader | 14 |
| Track | 35 |
| Timebase | 36 |
| Three bus lines | 37 |
| [U] | |
| Undo key | 20 |
| Unassigned track indication | 32 |
| Un-formatted indication | 32 |
| Using only the DMT-8 recorder section | 68 |
| Undo/Redo of Auto Punch In | 3 |
| Undo/Redo the erase operation | 90 |
| Undo/Redo the cut operation | 91 |
| [W] | |
| Warning on oscillation by looping | 7 |
| Warning message | 31 |

MEMO

A series of horizontal dotted lines for writing a memo.

Vertical text on the right margin, possibly a page number or reference code.





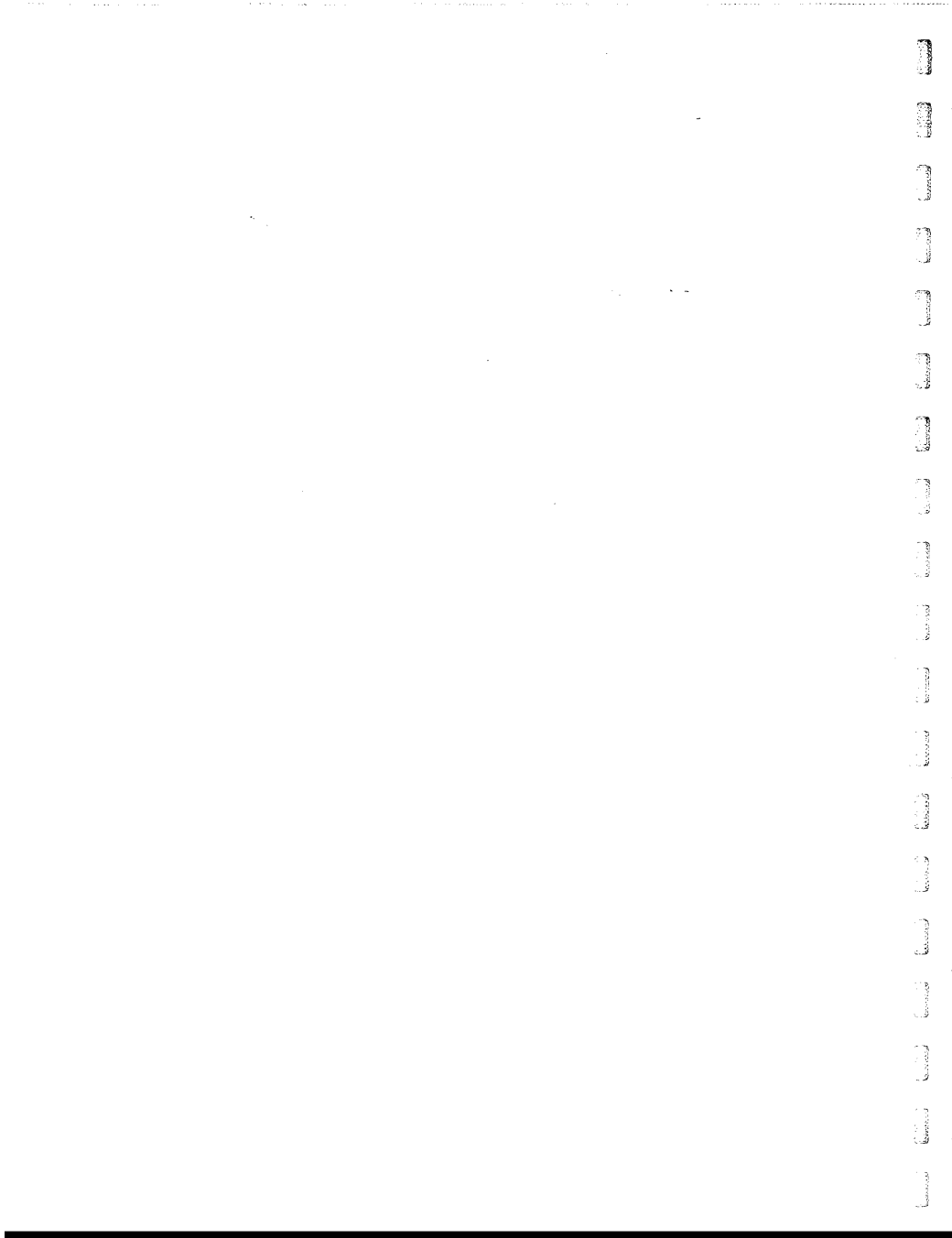

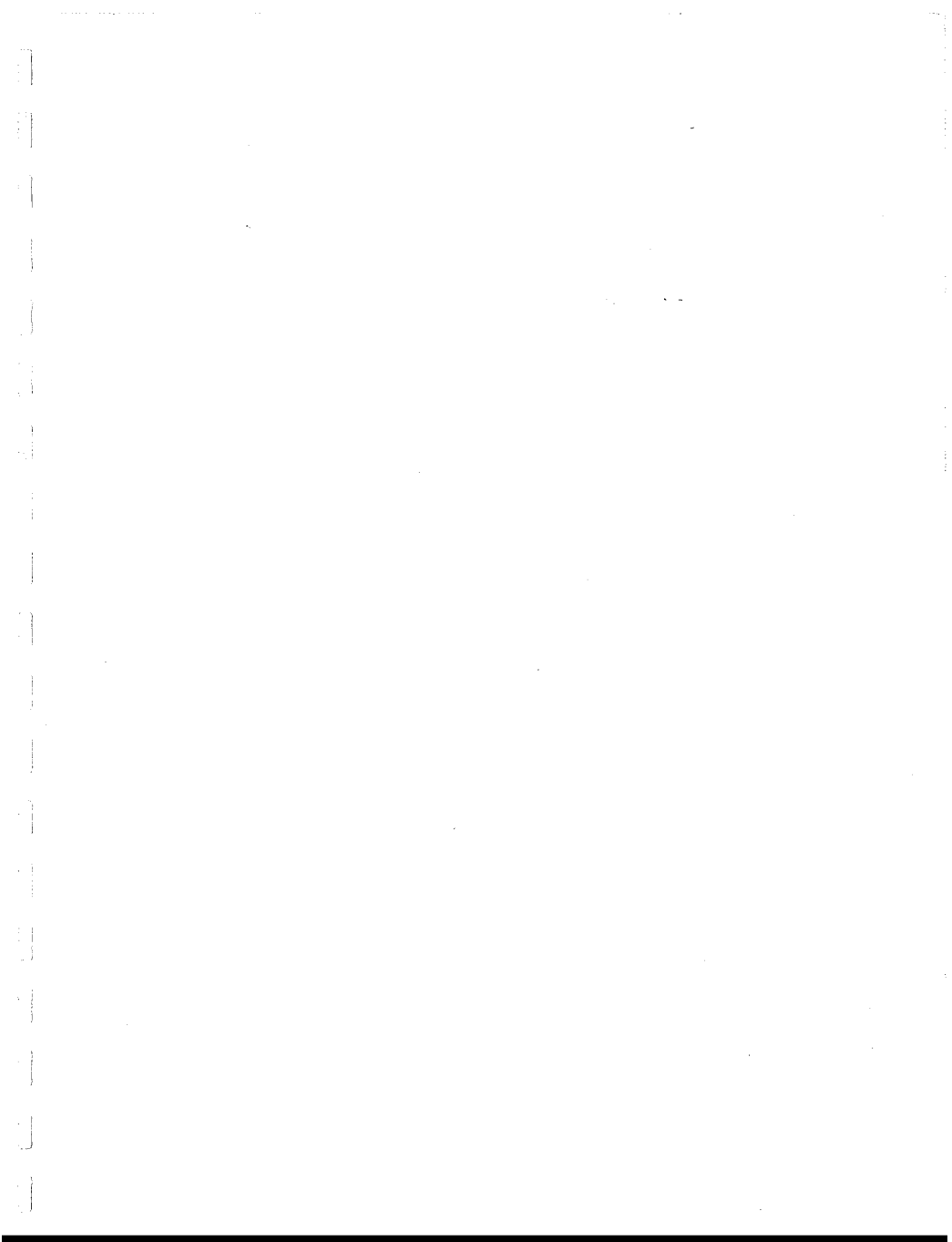

Fostex

FOSTEX CORPORATION

3-2-35 Musashino, Akishima, Tokyo, Japan 196

FOSTEX CORPORATION OF AMERICA

15431, Blackburn Ave., Norwalk, CA 90650, U.S.A.

© PRINTED IN JAPAN NOV. 1995 8288 357 200 FX (T.M)

Free Manuals Download Website

<http://myh66.com>

<http://usermanuals.us>

<http://www.somanuals.com>

<http://www.4manuals.cc>

<http://www.manual-lib.com>

<http://www.404manual.com>

<http://www.luxmanual.com>

<http://aubethermostatmanual.com>

Golf course search by state

<http://golfingnear.com>

Email search by domain

<http://emailbydomain.com>

Auto manuals search

<http://auto.somanuals.com>

TV manuals search

<http://tv.somanuals.com>