

8588103000  
(479095)

# Model LR16



LIVE RECORDING MIXER

## Owner's manual



**<Note>**: The LR16 will be upgraded to a new version for feature enhancement or improvement. Check the information about the latest software version from the Fostex website (<http://www.fostexinternational.com/>), Fostex service station or your local Fostex dealer. You can upgrade the software yourself. See page 80 for details about how to upgrade the software.

# Fostex®

 <div style="display: inline-block; text-align: center; background-color: black; color: white; padding: 5px; margin: 0 10px;"> <b>CAUTION</b>                  RISK OF ELECTRIC SHOCK                  DO NOT OPEN             </div> 
<p>CAUTION: TO REDUCE THE RISK OF ELECTRIC SHOCK, DO NOT REMOVE COVER (OR BACK). NO USER - SERVICEABLE PARTS INSIDE.</p> <p>REFER SERVICING TO QUALIFIED SERVICE PERSONNEL.</p>

**"WARNING"**

"TO REDUCE THE RISK OF FIRE OR ELECTRIC SHOCK, DO NOT EXPOSE THIS APPLIANCE TO RAIN OR MOISTURE."

**SAFETY INSTRUCTIONS**

1. Read Instructions - All the safety and operating instructions should be read before the appliance is operated.
2. Retain Instructions - The safety and operating instructions should be retained for future reference.
3. Heed Warnings - All warnings on the appliance and in the operating instructions should be adhered to.
4. Follow Instructions - All operating and use instructions should be followed.
5. Water and Moisture - The appliance should not be used near water - for example, near a bathtub, washbowl, kitchen sink, laundry tub, in a wet basement, or near a swimming pool, and the like.
6. Carts and Stands - The appliance should be used only with a cart or stand that is recommended by the manufacturer.



An appliance and cart combination should be moved with care. Quick stops, excessive force, and uneven surfaces may cause the appliance and cart combination to overturn.

7. Wall or Ceiling Mounting - The appliance should be mounted to a wall or ceiling only as recommended by the manufacturer.
8. Ventilation - The appliance should be situated so that its location or position does not interfere with its proper ventilation. For example, the appliance should not be situated on a bed, sofa, rug, or similar surface that may block the ventilation openings; or, placed in a built-in installation, such as a bookcase or cabinet that may impede the flow of air through the ventilation openings.
9. Heat - The appliance should be situated away from heat sources such as radiators, heat registers, stoves, or other appliances (including amplifiers) that produce heat.
10. Power Sources - The appliance should be connected to a power supply only of the type described in the operating instructions or as marked on the appliance.
11. Grounding or Polarization - The precautions that should be taken so that the grounding or polarization means of an appliance is not defeated.

**CAUTION:**  
TO PREVENT ELECTRIC SHOCK, MATCH WIDE BLADE OF PLUG TO WIDE SLOT, FULLY INSERT.

**ATTENTION:**  
POUR ÉVITER LES CHOCS ÉLECTRIQUES, INTRODUIRE LA LAME LA PLUS LARGE DE LA FICHE DANS LA BORNE CORRESPONDANTE DE LA PRISE ET POUSSER JUSQU' AU FOND.



The lightning flash with arrowhead symbol, within an equilateral triangle, is intended to alert the user to the presence of uninsulated "dangerous voltage" within the product's enclosure that may be of sufficient magnitude to constitute a risk of electric shock to persons.



The exclamation point within an equilateral triangle is intended to alert the user to the presence of important operating and maintenance (servicing) instructions in the literature accompanying the appliance.

12. Power Cord Protection - Power supply cords should be routed so that they are not likely to be walked on or pinched by items placed upon or against them, paying particular attention to cords at plugs, convenience receptacles, and the point where they exit from the appliance.
13. Cleaning - The appliance should be cleaned only as recommended by the manufacturer.
14. Nonuse Periods - The power cord of the appliance should be unplugged from the outlet when left unused for a long period of time.
15. Object and Liquid Entry - Care should be taken so that objects do not fall and liquids are not spilled into the enclosure through openings.
16. Damage Requiring Service - The appliance should be serviced by qualified service personnel when:
  - A. The power supply cord or the plug has been damaged; or
  - B. Objects have fallen, or liquid has been spilled into the appliance; or
  - C. The appliance has been exposed to rain; or
  - D. The appliance does not appear to operate normally or exhibits a marked change in performance; or
  - E. The appliance has been dropped, or the enclosure damaged.
17. Servicing - The user should not attempt to service the appliance beyond that described in the operating instructions. All other servicing should be referred to qualified service personnel.
18. The appliance should be situated away from drops of water or spray of water.
19. Objects containing liquid such as vase must not be put on the appliance.
20. The appliance is not completely isolated from the power supply even if the power switch is at off position.
21. Apparatus shall not be exposed to dripping or splashing and no objects filled with liquids, such as vases, shall be placed on the apparatus.
22. Only use attachments/accessories specified by the manufacturer.
23. An appliance with a protective earth terminal should be connected to a mains outlet with a protective earth connection.
24. An appliance should be placed in a position where an AC plug / inlet can be easily pulled out by hand.
25. Main plug is used as the disconnection device. It shall remain readily operable and should not be obstructed during intended use. To be completely disconnected the apparatus from supply mains, the mains plug of the apparatus shall be disconnected from the mains socket outlet completely.

## Important Safety Instructions

- 1) Read these instructions.
- 2) Keep these instructions.
- 3) Heed all warnings.
- 4) Follow all instructions.
- 5) Do not use this apparatus near water.
- 6) Clean only with dry cloth.
- 7) Do not block any ventilation openings. Install in accordance with the manufacturer's instructions.
- 8) Do not install near any heat sources such as radiators, heat registers, stoves, or other apparatus (including amplifiers) that produce heat.
- 9) Do not defeat the safety purpose of the polarized or grounding-type plug. A polarized plug has two blades with one wider than the other. A grounding type plug has two blades and a third grounding prong. The wide blade or the third prong are provided for your safety. If the provided plug does not fit into your outlet, consult an electrician for replacement of the obsolete outlet.
- 10) Protect the power cord from being walked on or pinched particularly at plugs, convenience receptacles, and the point where they exit from the apparatus.
- 11) Only use attachments/accessories specified by the manufacturer.
- 12) Use only with the cart, stand, tripod, bracket, or table specified by the manufacturer, or sold with the apparatus. When a cart is used, use caution when moving the cart/apparatus combination to avoid injury from tip-over.



- 13) Unplug this apparatus during lightning storms or when unused for long periods of time.
- 14) Refer all servicing to qualified service personnel. Servicing is required when the apparatus has been damaged in any way, such as power-supply cord or plug is damaged, liquid has been spilled or objects have fallen into the apparatus, the apparatus has been exposed to rain or moisture, does not operate normally, or has been dropped.
- 15) Excessive sound pressure from earphones and headphones can cause hearing loss.

# Table of contents

**Safety instructions .....2**

## **Introduction .....9**

**About power supply .....9**

**Precautions in installation .....9**

**Notes on handling the internal hard disk drive .....9**

**About version upgrade .....10**

**Condensation .....10**

**Cleaning the exterior .....10**

**About copyrights .....10**

**About damage .....10**

## **Overview .....11**

**Main features .....11**

    Mixer section (control unit) features .....11

    Recorder section (main unit) features .....17

## **Before using the unit .....13**

**Unpacking the carton .....13**

**Usage examples of LR16 .....14**

    <Usage example 1> Integrating the main unit and control unit .....17

    <Usage example 2> Mounting the main unit and control unit on the rack .....17

    <Usage example 3> Setting the main unit and control unit separately .....17

**Integrating the control unit and main unit .....15**

**Preparation of power supply .....17**

    Connecting the power cord .....17

    Turning on the power .....17

    Procedures of turning on the power after connecting peripheral devices .....17

    Procedures of turning off the power after connecting peripheral devices .....17

**Connection to external devices .....18**

Connection example (live recording) .....	18
Connection example (home recording) .....	19
Balanced and unbalanced inputs/outputs .....	20

**Names and functions .....21**

Control unit (input channel 1 through 16) .....	22
Control unit (master channel) .....	24
Control unit (rear panel) .....	27
Main unit (front panel) .....	27
Main unit (rear panel) .....	29
Display details .....	30
HOME screen .....	30
MENU mode screen .....	31
Memory play setup mode screen .....	31

**Mixer functions (Mixer basics) .....34**

Signal flow of the mixer .....	34
Connecting sources .....	35
Connecting sources to the input connectors .....	35
Phantom power supply setting .....	35
Selecting channel source .....	35
Adjusting the input level .....	35
Low-cut filter .....	36
Limiter .....	36
Equalizer .....	36
EQ HIGH .....	37
EQ MID .....	37
EQ LO .....	37

**Using an external effect processor .....37**

    Using AUX 1, 2 and 3 .....37

    Using Insert .....38

**Using the internal effects processor .....38**

    Applying the internal effects .....38

    About the effect types .....39

**Monitoring .....39**

    Solo monitor .....40

**Channel grouping .....40**

**Using SUB IN .....41**

**Block diagram .....42**

**Recorder functions (Recording/Playback) .....43**

**The basics of the recorder .....44**

    Recording types .....44

    Recording modes .....45

    Project .....45

**Live recording .....46**

    Preparation of recording .....48

    Adjusting recording level of each channel .....48

    Adjusting output level of the stereo L/R bus .....49

    Performing recording .....49

    Playback of the project .....50

**Multitrack recording .....51**

    Overdubbing .....51

    Mixdown .....52

**Punch in/out .....54**

    Punch in/out using the keys .....54

    Punch in/out using the footswitch .....55

**Recorder functions (Memory play) .....57**

<b>Setting on the memory play setup screen .....58</b>	
Assigning stereo mix files .....58	
Selecting a channel pair for memory play .....59	
Selecting the memory play mode .....59	
<b>Performing memory play .....60</b>	

**Recorder functions (Mark function) .....61**

<b>Adding a mark .....61</b>	
Adding a mark on-the-fly .....61	
Adding a mark via the mark list screen .....61	
<b>Locating to a mark point .....62</b>	
<b>Editing a mark .....62</b>	
Editing a mark label .....62	
Editing a mark position .....63	
<b>Deleting a mark .....64</b>	

**Recorder functions (Project management) .....65**

<b>Selecting a project .....65</b>	
<b>Creating a new project .....65</b>	
<b>Editing a project name .....66</b>	
<b>Rolling back a project .....67</b>	
<b>Saving a project to an external medium .....68</b>	
<b>Copying a stereo mix file to an external medium .....70</b>	
<b>Protecting a project .....72</b>	
<b>Deleting a project .....72</b>	

**Recorder functions (File transfer to/from a computer) .....74**

**Connecting the LR16 to a personal computer .....74**  
**Enabling USB connection .....74**  
**Copying data from the LR16 to a computer .....76**  
**Copying data from a computer to the LR16 .....76**

**Recorder functions (Other functions) .....77**

**Adjusting the display contrast .....77**  
**Selecting the footswitch function .....77**  
**Formatting the internal hard disk .....78**  
**Initializing the system memory .....78**  
**Assigning the destinations of SUB IN and the memory play signals .....79**  
     To assign the destination channels of SUB IN .....79  
     To assign the destination channels of Memory play .....80  
**Software version upgrade .....80**  
**MIDI synchronization .....82**  
     Setting frame rate .....82  
**Setting FS/Bit of project .....83**

**Specifications .....84**

**Inputs/Outputs .....84**  
**Recording/Playback .....84**  
**General .....85**  
**Physical dimensions .....85**  
**MIDI Implementation Chart .....86**  
**Declaration of EC Directive .....87**  
**FOSTEX AMERICA LIMITED WARRANTY .....88**  
**INDEX .....90**



# Introduction

Thank you very much for purchasing the Model LR16.

The LR16 is a live recording mixer which consists of the control unit which is equipped with a digital mixer and the main unit which is equipped with a recorder and I/O connectors.

To ensure the best performance, read this manual thoroughly before using the LR16. Keep this manual handy for future reference.

## About power supply

- Be sure to connect the LR16 to the power supply specified in the specifications section of this owner's manual. Do not use an AC outlet of any other voltage.
- Do not connect the LR16 to the same AC outlet to which devices that could generate noise (such as a large motor or dimmer), or the devices that consume a large amount of power (such as an air conditioning system or large electric heater) are connected.
- If you use the LR16 in an area with a different power voltage, first consult your dealer or the nearest Fostex service station. You can use the LR16 with a power frequency of 50Hz or 60Hz.
- It is very dangerous to use a power cord that is frayed or damaged. In such a case, stop using the LR16 immediately and ask your dealer to repair the cord.
- To avoid possible electric shock and damage to the LR16, avoid contact with water or other liquids, or do not handle the power plug while your hands are wet.
- To prevent possible electric shock and damage to the LR16, do not remove the main unit cover or reach the inside of the LR16.
- Do not let water or other liquid, or metal objects such as pins, accidentally enter the inside of the LR16 because this may lead to electric shock or damage. Should water enter the inside of the LR16, remove the power plug from AC outlet, and consult your dealer or the nearest Fostex service station.

- To prevent damage to the LR16, be sure to power on the connected devices first, then turn on the power to the LR16. When you remove or connect the cables to the input/output connectors on the LR16, make sure that the channel and master faders and volume controls are set "∞".

## Precautions on installation

- Do not install the unit in the following conditions.
  - \* In an extremely hot or cold place
  - \* In a moist place
  - \* In a vibrated place
  - \* In a dusty place
  - \* In a strong magnetic field or near a device which generates a magnetic field
  - \* In the direct sunshine
  - \* In the direct shower or rain
- To integrate the main unit and control unit or mount them to a rack, follow the instruction described in this manual (note that screws for rack mounting are not supplied with the LR16).

## Notes on handling the internal hard disk drive

- A hard disk drive for recording/playback is built in the recorder section of the main unit. When you move or install the LR16, do not apply mechanical shock or drop the unit. When you install the main unit and control unit separately, wire the CAT-5 cable between these units with care to avoid catching the cable with your foot.

**<Note>**: The replacement of the internal hard disk drive should be done by an authorized service person. If the hard disk drive malfunctions, contact your dealer or the nearest Fostex service station.

- You can format the internal hard disk drive via the MENU mode. For details, see “Formatting the internal hard disk drive” on page 78.

### About version upgrade

- The software of the LR16 will be upgraded in the future. You can download the latest software from our website and upgrade the LR16 yourself. For details about how to upgrade the LR16 to the latest software version, see page 80.

### Condensation

- When temperature and humidity change suddenly (for example, when you move the LR16 from a cold place to a warm place), moisture condensation may occur to the drive, display and panel. In such a case, leave it with the power turned off for some time until the moisture evaporates.

### Cleaning the exterior

- For normal cleaning, use a soft dry cloth. For stubborn dirt, moisten a cloth in diluted detergent, wring it out firmly, and wipe the dirt off. Then polish with a dry cloth. Never use solvents such as alcohol, thinner or benzene, since these will damage the printing and finish of the exterior.

### About copyrights

- It is prohibited by law to use any part of a CD recording or video images or audio data for which copyright is possessed by a third party for commercial purposes such as contents, broadcasts, sales, or distribution—any purpose other than for your personal pleasure.

### About damage

- Fostex is not responsible for any “direct damage” or “indirect damage” caused by using the LR16.

### About CAT-5 cable

- Use only a CAT-5 STP cable for connection between the main unit and the control unit.

**<Note>**: Do not connect or disconnect a CAT-5 cable while the LR16 is powered on. When you connect or disconnect a CAT-5 cable, make sure that the LR16 is powered off.

# Overview

The Model LR16 consists of the control unit which is equipped with a digital mixer with intuitive analog like operation and the main unit which is equipped with a recorder and I/O connectors. You can install the LR16 flexibly by integrating these units, mounting them on a rack or setting them away from each other (up to 50 meter distance using a CAT-5 cable).

The LR16 is an ideal tool for schools, houses of worship, clubs, coffee houses, project studios, mobile recording, rental sound/recording, etc.

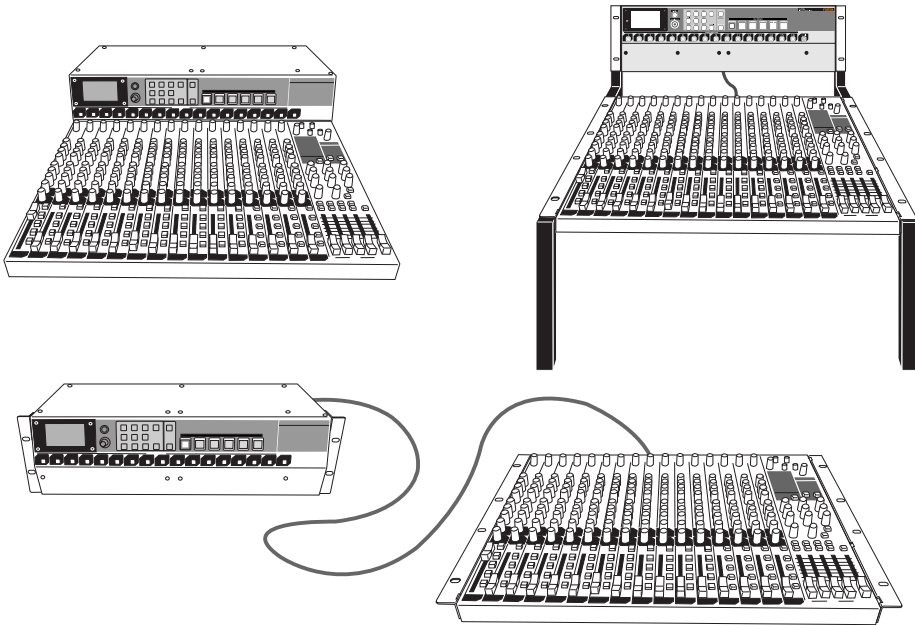

**<Note>**: The CAT-5 cable supplied with the LR16 is approximately 50 cm length. This cable can be used when installing the LR16 by integrating the control and main units. To mount them on a rack or set them away from each other, prepare an appropriate CAT-5 cable which has enough length (up to 50 m).

## Main features

### Mixer section (control unit) features

- Digitally controlled trim on each input channel, allowing optimum input level adjustment for each mic/line input.
- Fostex originally-developed digital effect unit (reverb/delay) is built in, allowing selection from 12 effect types.
- Provides 16 input faders, four group faders and stereo master fader, allowing analog like operation.

- 3-band (High/Mid/Low) input equalizer on each input channel.
- Insertion point on input channel 1 through 8, allowing connection to an external comp/limiter, etc.
- XLR-phone combo type connector provided on each input channel, allowing mic or line connection. In addition, phantom power can be supplied to each XLR connector, allowing use of a condenser microphone. (You can turn on or off phantom power in eight channel groups.)
- Four group outputs allow connection to an external mixer or multitrack recorder.
- Aux and effect sends allow connection to an external effect unit, a stage monitor system, etc.

### **Recorder section (main unit) features**

---

- Built in a large capacity hard disk drive which allows up to 16 track digital recording (approx. 16 hour recording in 44.1 kHz/16 bit, 80GB).
- In addition to up to 16 track recording, stereo mix recording is possible. Also, multitracks and stereo mix can be recorded simultaneously.
- Mark function allows locating to a mark.
- 132 x 64 dot graphic LCD allows viewing the level meters and information at a glance.
- Memory play function is provided, allowing instant playback using the numeric keys as well as a footswitch (the footswitch function can be selected using the System menu of the MENU mode).
- Punch in/out function using the panel keys as well as a footswitch.
- By connecting a computer to the [USB PC] port, you can transfer audio files (note that you cannot simultaneously use the [USB HOST] port).
- By connecting a FAT16 and FAT32 formatted USB flash memory stick, you can copy audio files or version upgrade file.
- From the [MIDI OUT] port, MTC (MIDI Time Code) can be output, allowing synchronization with external MIDI devices (the MTC frame rate can be selected between 25 fps and 30 fps via the System menu of the MENU mode).

# Before using the unit

Read this chapter carefully before using the unit.

## Unpacking the carton

Unpack the carton and inspect the contents for damage or shortages. The following contents should be found in the carton. If you find any damage or shortages, contact your Fostex dealer.

Main unit (including recorder section and I/O connector sections) x 1

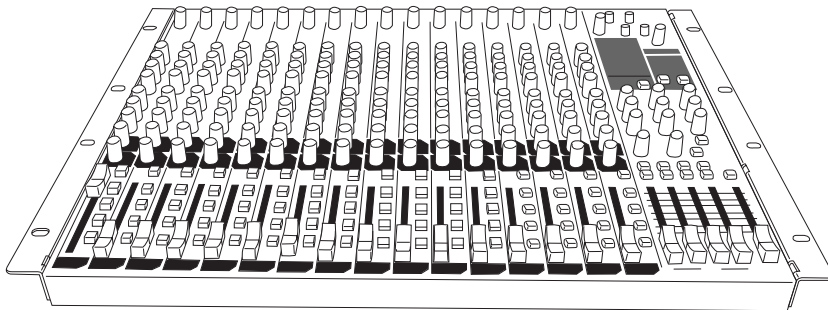
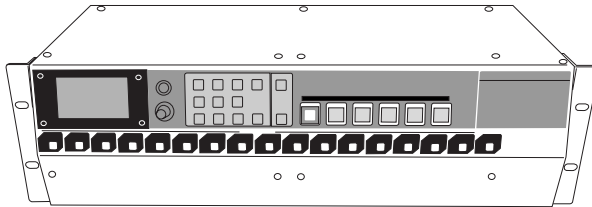

Controller unit x 1

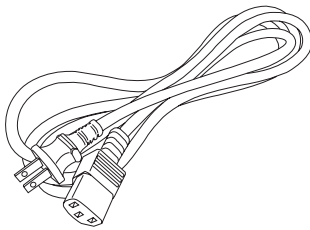

Power cord x 1

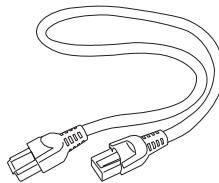

CAT-5 STP cable (approx. 50 cm) x 1

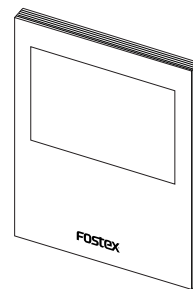

Operation manual x 1

## Usage examples of LR16

The control unit and main unit of the LR16 are separated. You can set these units flexibly.

### <Usage example 1> Integrating the main unit and control unit.

You can integrate the main unit and control unit.

Use the supplied CAT-5 cable (approx. 50 cm length) to connect between the units. See the next page for details about how to integrate the units.

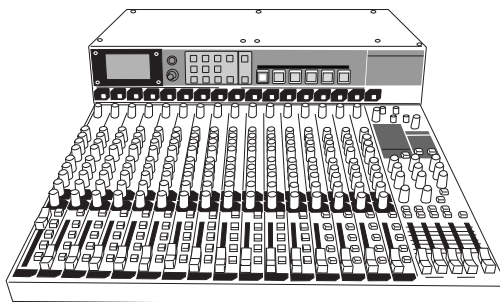

### <Usage example 2> Mounting the main unit and control unit on the rack.

As shown on the right, you can mount each unit to the rack. In this case, use a CAT-5 cable which has enough length for connecting between the units (the cable supplied with the LR16 is approximately 50 cm length).

**<Note>:** Use only a CAT-5 STP cable for connection between the main unit and the control unit.

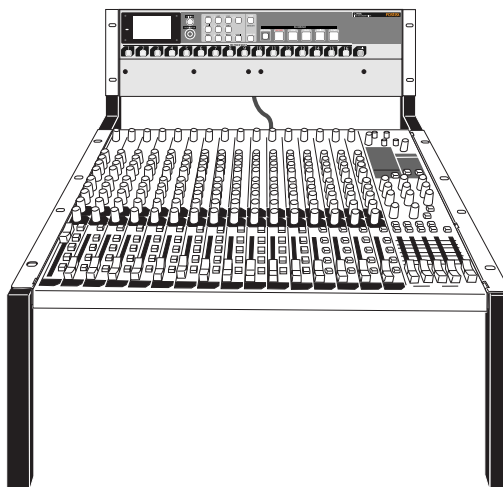

### <Usage example 3> Setting the main unit and control unit separately.

You can set the main unit and control unit over a 50 meter distance. In such a case, use a CAT-5 cable which has enough length for connecting between the units (the cable supplied with the LR16 is approximately 50 cm length).

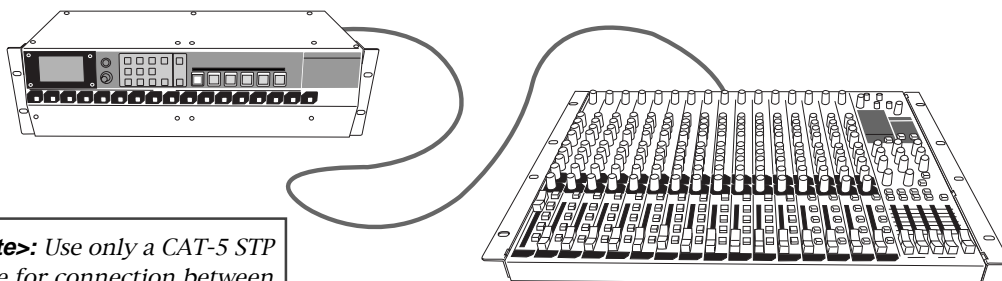

**<Note>:** Use only a CAT-5 STP cable for connection between the main unit and the control unit.

## Integrating the control unit and main unit

Follow the procedure below to integrate the control unit and main unit.

**<Note>**: Work on a flat and stable surface. It is recommended to put the units on a soft cloth (or blanket) to protect the units.

**<Necessary items>**

- Phillips-head screwdriver (which matches the fixing screws for rack mounting)
- The supplied CAT-5 cable

**(1) Remove the rack mount angles attached to the side panels of each unit.**

The removed rack mount angles and fixing screws are used in step (3) below, so be careful not to lose them.

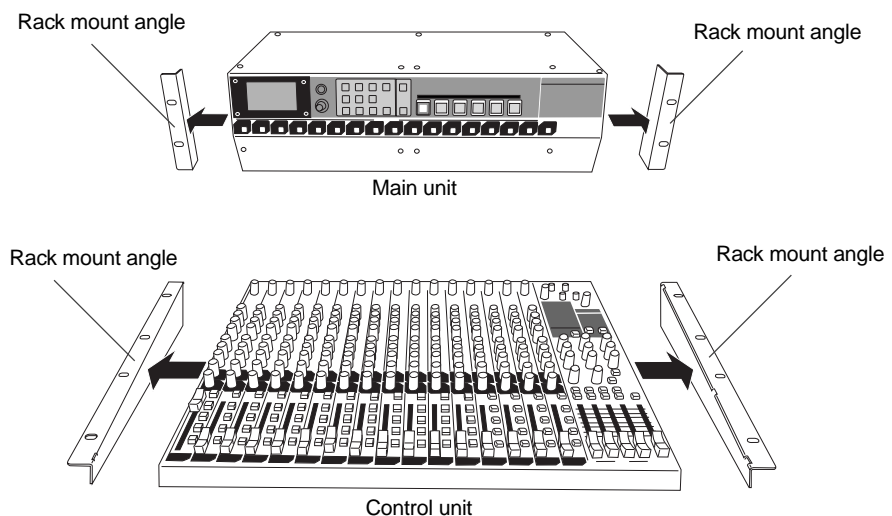

**(2) Connect the [ETHER] connector of the control unit and the [CONTROLLER] connector of the main unit using the supplied CAT-5 cable.**

The cable should run through the cable guides fixed near the connectors of the both units (see below).

**<Note>**: Do not connect or disconnect a CAT-5 cable while the LR16 is powered on. When you connect or disconnect a CAT-5 cable, make sure that the LR16 is powered off.

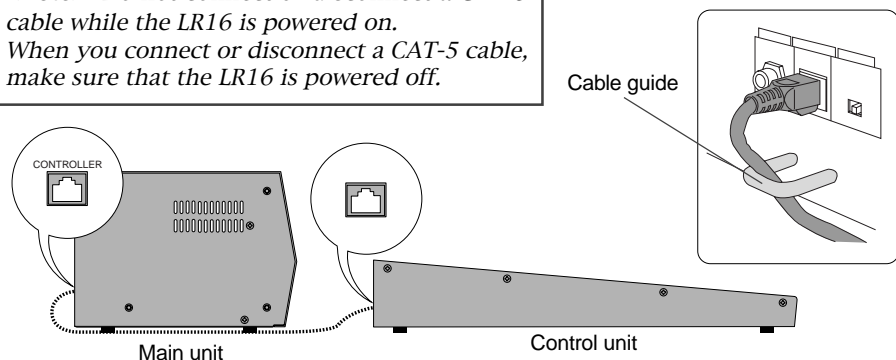

**<Note>**: Insert the connector of the cable firmly in the correct direction.

**(3) Using the rack mount adaptors removed from the control unit, fix the control unit and main unit.**

Attach the rack mount adaptors to the both left and right sides in the direction shown below. Use four screws for each side.

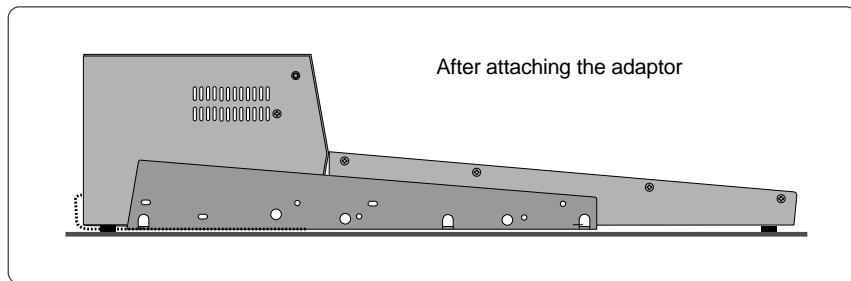
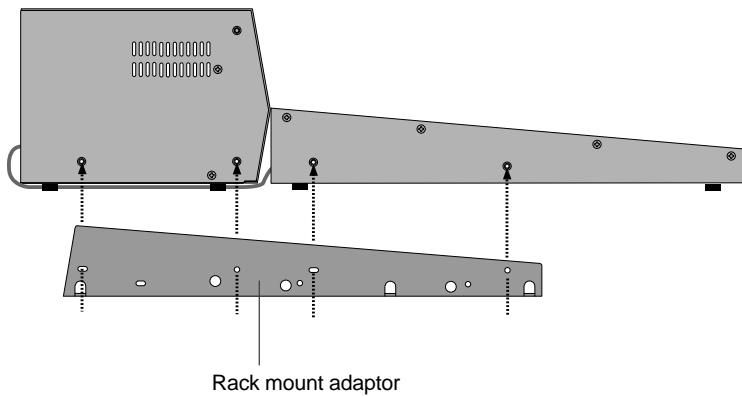

**(4) Put the CAT-5 cable into the space between the rubber feet and mounting bracket (indicated by arrows below).**

The space between the rubber feet and mounting bracket is narrow, so be careful not to damage the cable when you put it into the space.

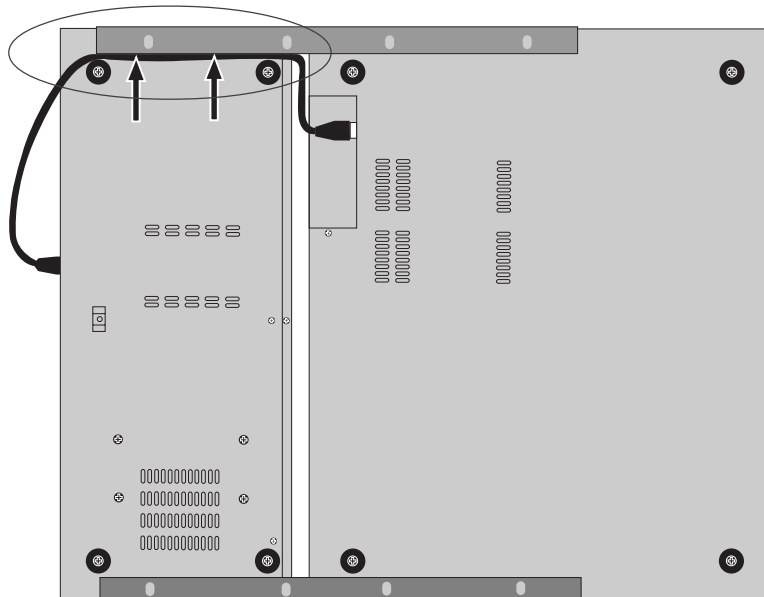



## Preparation of power supply

### Connecting the power cord

Using the supplied power cord, connect the [AC IN] connector on the rear panel of the main unit and the AC outlet.

**<Note>**: Use only the supplied power cord.

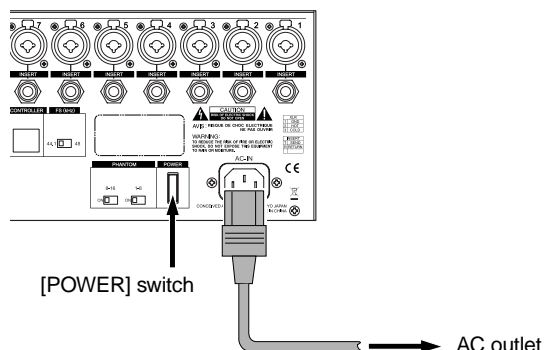

### Turning on the power

Press down the [POWER] switch on the rear panel of the main unit to turn on the power.

After a while, the LR16 normally starts up and the display on the recorder unit shows "<No project>" (indicating that nothing is recorded on the recorder's hard disk).

For details about recording, see "Mixer function" on page 33 and "Recorder function" on page 43.

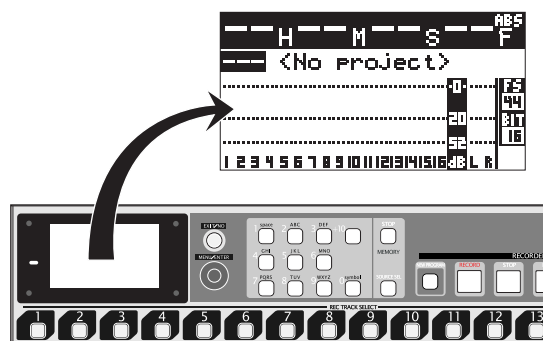

To turn on or off the LR16 and peripheral devices which are connected to the LR16, follow the proper procedures described below.

### Procedures of turning on the power after connecting peripheral devices

**<Note>**: Before turning on or off the LR16 and peripheral devices which are connected to the LR16, make sure that the channel faders and monitor gain control of the LR16, as well as the volume control of an monitor amplifier (or powered monitor speaker), are set to minimum. Otherwise, a loud sound may be produced suddenly that may damage the speaker or your hearing.

- (1) Turn on the devices connected to the [INPUT] connectors to the LR16.
- (2) Turn on the LR16.
- (3) Turn on the monitor amplifier (or powered monitor speaker).

### Procedures of turning off the power after connecting peripheral devices

- (1) Turn off the monitor amplifier (or powered monitor speaker).
- (2) Turn off the LR16.
- (3) Turn off the devices connected to the [INPUT] connectors to the LR16.

# Connection to external devices

## Connection example (live recording)

**<Note>**: Before making connection between the LR16 and external devices, make sure that all devices including the LR16 are turned off, as well as all faders and level controls are down.

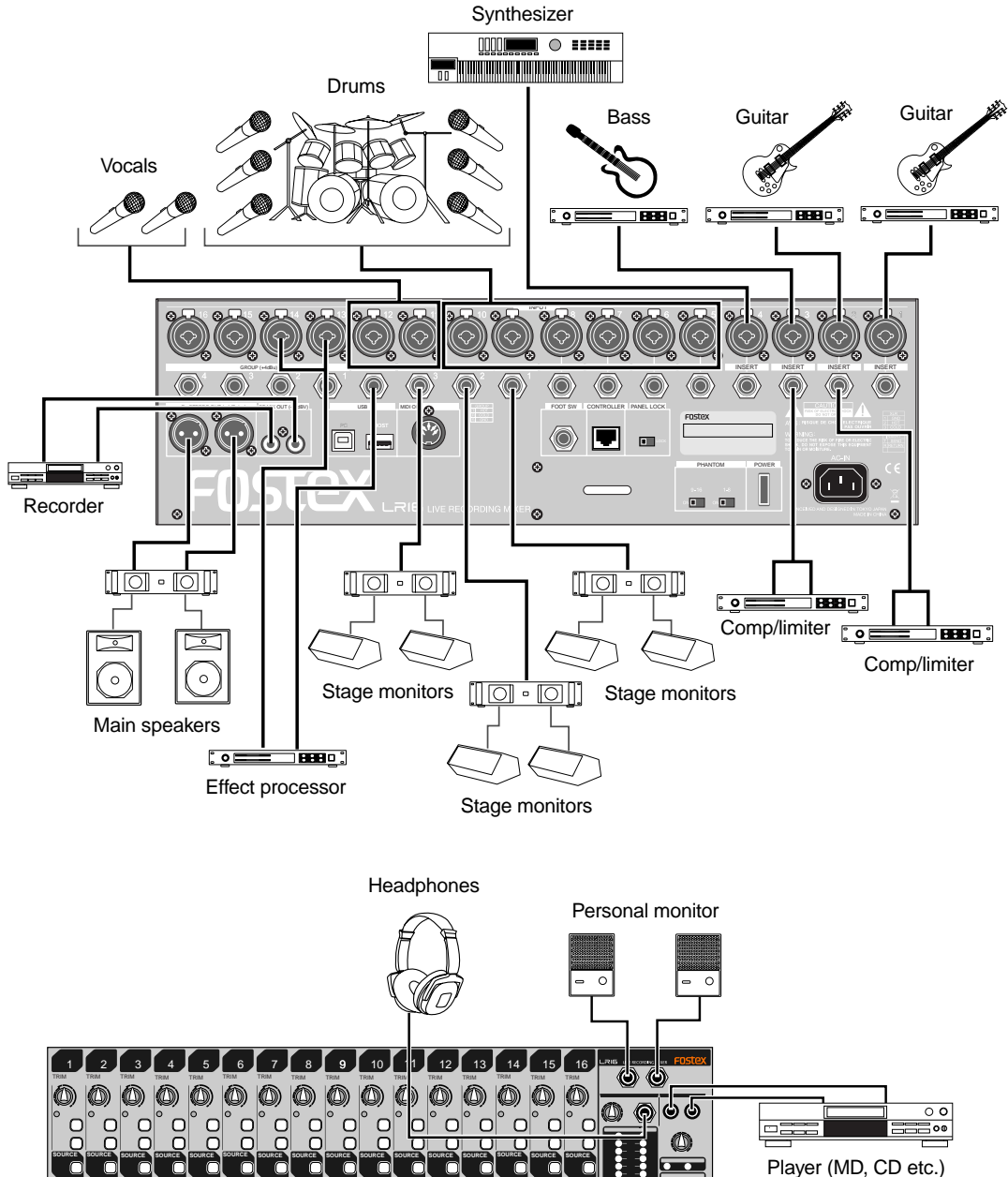

**Connection example (home recording)**

*<Note>: Before making connection between the LR16 and external devices, make sure that all devices including the LR16 are turned off, as well as all faders and level controls are down.*

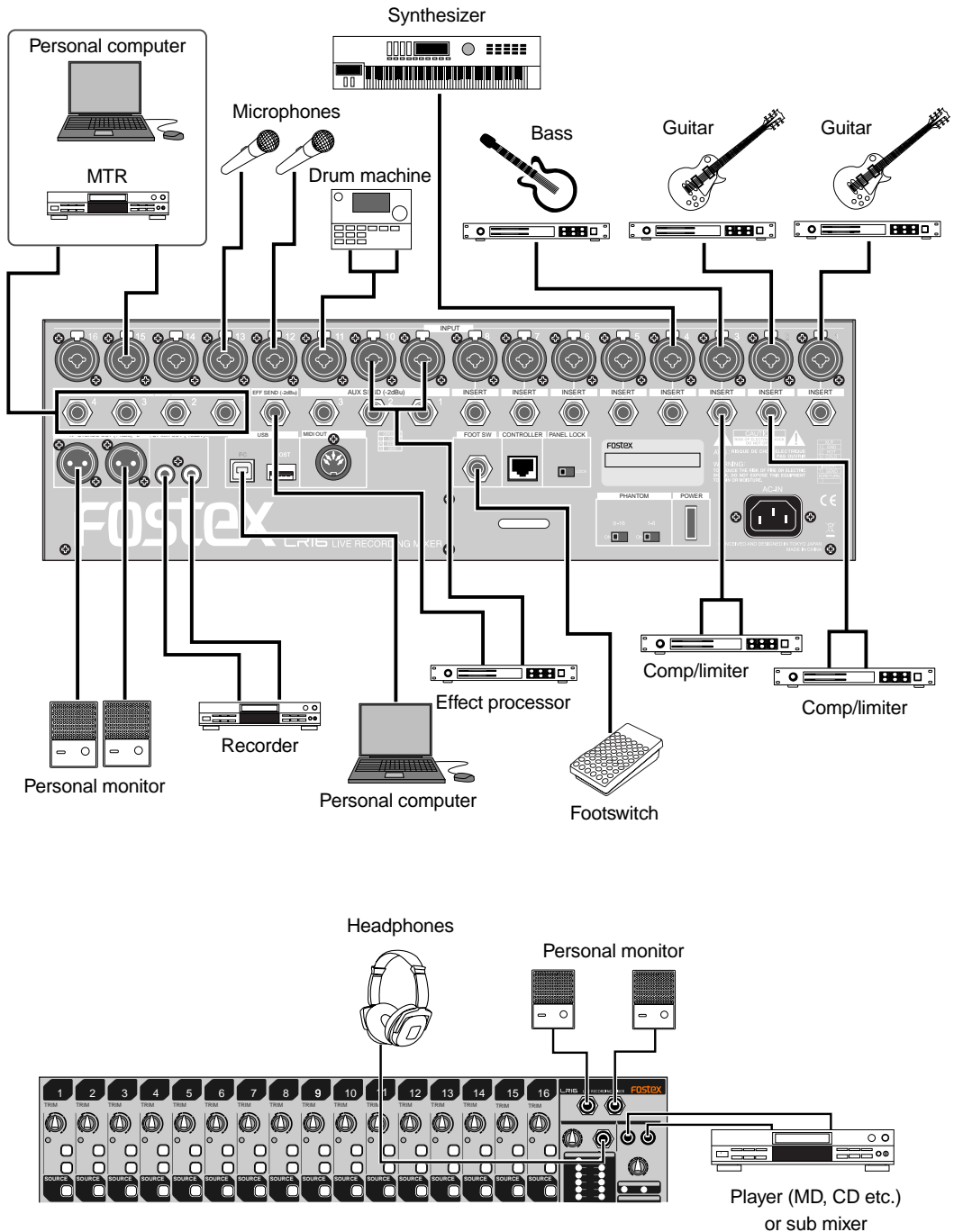

## Balanced and unbalanced inputs/outputs

For connection between a recording mixer such as the LR16 and external devices (such as a microphone, keyboard, recorder, etc), shielded cables are used. There are two types of cables - balanced and unbalanced.

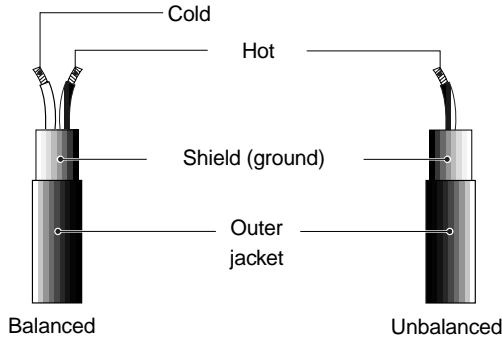

### Balanced

The advantage of a balanced cable is its ability to reject external interference. Therefore, it is suitable for handling a small level signal or transferring over long distances. The LR16 provides the following balanced connectors.

Inputs/outputs	Connectable connectors
[INPUT 1-16]	XLR-3-12 connector, 3-conductor TRS or 2-conductor phone plug
[STEREO OUT (L, R)]	XLR-3-11 connector
[GROUP OUT 1 - 4]	2-conductor phone plug
[PHONES]	3-conductor TRS phone plug

### Unbalanced

An unbalanced cable is mainly used for handling line level signals. The LR16 provides the following unbalanced connectors.

Inputs/outputs	Connectable connectors
[INSERT 1 - 8]	3-conductor TRS phone plug
[EFF SEND]	2-conductor phone plug
[AUX SEND 1 - 3]	2-conductor phone plug
[ST MIX OUT (L, R)]	RCA pin plug
[MONITOR OUT (L, R)]	2-conductor phone plug
[TAPE IN (L, R)]	RCA pin plug

Connector types	
 XLR-3-11 connector (balanced)	 XLR-3-12 connector (balanced)
 RCA pin plug (unbalanced)	 3-conductor TRS phone plug (balanced)
 2-conductor phone plug (unbalanced)	 3-conductor TRS phone plug (balanced)

 1 2 3	 1 2 3												
<table border="1" style="width: 100%; border-collapse: collapse;"> <tr><td style="width: 20px;">1</td><td>Ground</td></tr> <tr><td>2</td><td>Hot</td></tr> <tr><td>3</td><td>Cold</td></tr> </table>	1	Ground	2	Hot	3	Cold	<table border="1" style="width: 100%; border-collapse: collapse;"> <tr><td style="width: 20px;">1</td><td>Ground</td></tr> <tr><td>2</td><td>Hot</td></tr> <tr><td>3</td><td>Cold</td></tr> </table>	1	Ground	2	Hot	3	Cold
1	Ground												
2	Hot												
3	Cold												
1	Ground												
2	Hot												
3	Cold												

 Tip Sleeve	<table border="1" style="width: 100%; border-collapse: collapse;"> <tr><td style="width: 20px;">Tip</td><td>Hot</td></tr> <tr><td>Sleeve</td><td>Ground</td></tr> </table>	Tip	Hot	Sleeve	Ground
Tip	Hot				
Sleeve	Ground				

 Sleeve Tip Ring	<table border="1" style="width: 100%; border-collapse: collapse;"> <tr><td style="width: 20px;">Tip</td><td>Hot</td></tr> <tr><td>Ring</td><td>Cold</td></tr> <tr><td>Sleeve</td><td>Ground</td></tr> </table>	Tip	Hot	Ring	Cold	Sleeve	Ground
Tip	Hot						
Ring	Cold						
Sleeve	Ground						

**MON OUT/AUX SEND GROUP OUT/EFF SEND**

Tip	Hot
Ring	Cold
Sleeve	Ground

 Tip Sleeve	<table border="1" style="width: 100%; border-collapse: collapse;"> <tr><td style="width: 20px;">Tip</td><td>Output</td></tr> <tr><td>Ring</td><td>Input</td></tr> <tr><td>Sleeve</td><td>Ground</td></tr> </table>	Tip	Output	Ring	Input	Sleeve	Ground
Tip	Output						
Ring	Input						
Sleeve	Ground						

**INSERT**

Tip	Output
Ring	Input
Sleeve	Ground

  

 Tip Sleeve	<table border="1" style="width: 100%; border-collapse: collapse;"> <tr><td style="width: 20px;">Tip</td><td>L</td></tr> <tr><td>Ring</td><td>R</td></tr> <tr><td>Sleeve</td><td>Ground</td></tr> </table>	Tip	L	Ring	R	Sleeve	Ground
Tip	L						
Ring	R						
Sleeve	Ground						

**PHONES/INPUT**

Tip	L
Ring	R
Sleeve	Ground

# Names and functions

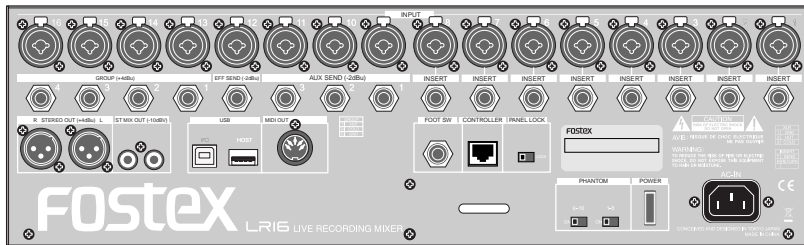

Main unit (Rear panel)

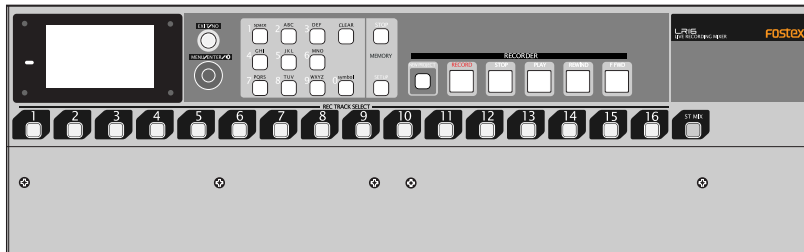

Main unit (Front panel)



Control unit (Rear panel)

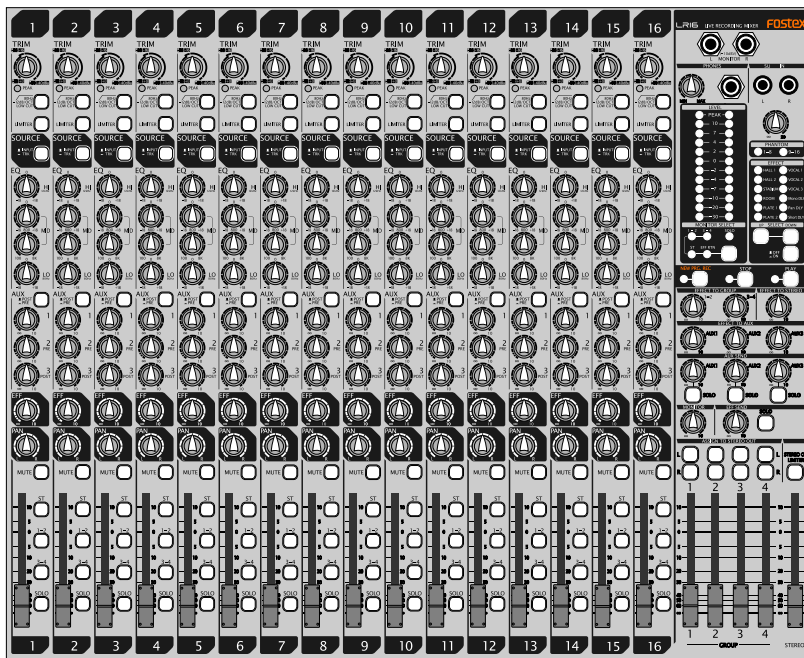

Control unit (Top panel)

**Control unit (input channel 1 through 16)**

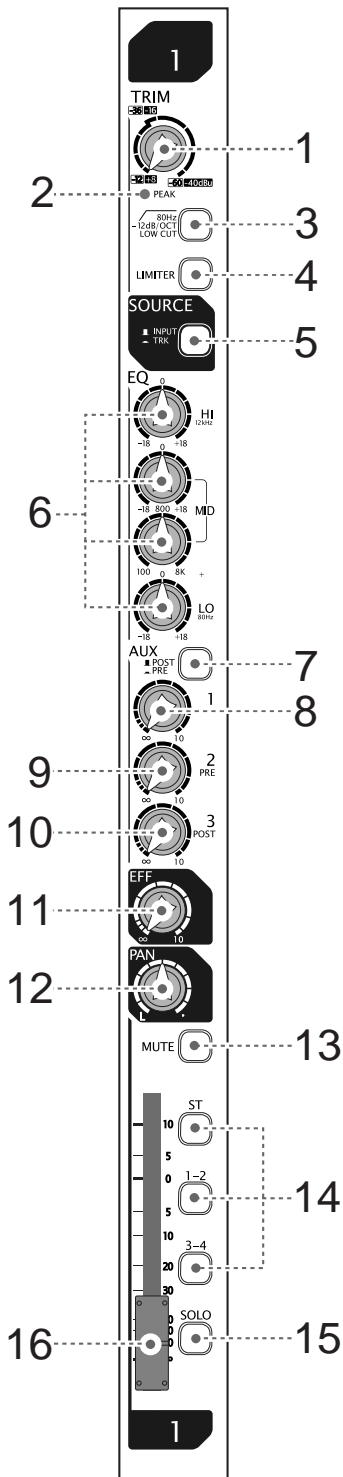

**(1) [TRIM] control**

Adjusts the gain of each input signal. Set this control appropriately so that the [PEAK] indicator lights at the maximum input level. By adjusting this control appropriately, the LR16 can accept a signal within -60dBu and -12dBu for mic input, while it can accept a signal within -40dBu and +8dBu for line input.

**<Notes>**: When the [SOURCE] select switch is set to "TRK", the [TRIM] control is ineffective to the source signal (recorder track signal or the signal from the [SUB IN] connector).

**(2) [PEAK] indicator**

Lights up when an input channel signal overloads. You should set the [TRIM] control appropriately so that this indicator does not light frequently.

**(3) [LOW CUT] switch**

Switches on (▲) or off (■) of the low cut filter (high pass filter). When on, the frequency range below 80 Hz is cut at -12 dB/oct. This function is performed in the analog stage.

**(4) [LIMITER] switch**

Switches on (▲) or off (■) of the limiter function. The limiter works to prevent signal clipping when the input level exceeds the certain level. The limiter function is performed in the analog stage.

**(5) [SOURCE (INPUT/TRK)] switch**

Selects the source signal for each input channel. When the switch is set to the up position (▲), the signal fed to the [INPUT] connector is selected. When the switch is set to the down position (■), the recorder playback signal is selected. Pressing the switch toggles the source signal. When selecting the recorder playback signal (■), the [TRIM] control is not effective.

**(6) [EQ HI/MID/LO] controls**

These controls control gain for each EQ band (high, middle, and low), as well as the middle frequency. When you set the gain control at the center position, no boost or cut is applied.

The following table shows the EQ type, center (or cut-off) frequency and boost/cut range of each EQ band.

Band	EQ type	Center (or cut-off) frequency	Boost/cut range
HIGH	Shelving type	12kHz	+/-18dB
MID	Peaking type	100 Hz to 8 kHz (sweepable)	
LOW	Shelving type	80Hz	

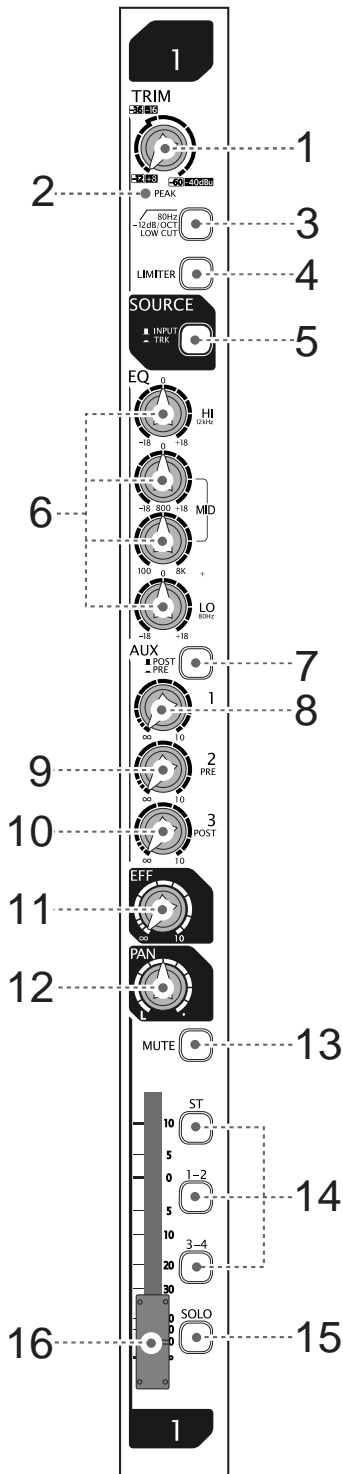

**(7) [POST/PRE] switch**

Selects post-fader or pre-fader feed of the AUX 1 buss (each press of the switch alternates the selection).

When the switch is set to the up (▲) position, post-fader is selected. When the switch is set to the down (▼) position, pre-fader is selected.

**(8) [AUX 1] control**

Adjusts the signal level fed to the AUX 1 buss from each input channel. The post-fader or pre-fader signal selected by the [POST/PRE] switch is fed to the AUX 1 buss.

**(9) [AUX 2 (PRE)] control**

Adjusts the signal level fed to the AUX 2 buss from each input channel. The pre-fader signal is fed to the AUX 2 buss.

**(10) [AUX 3 (POST)] control**

Adjusts the signal level fed to the AUX 3 buss from each input channel. The post-fader signal is fed to the AUX 3 buss.

**(11) [EFF] send control**

Adjusts the signal level fed to the EFF buss from each input channel. The post-fader signal is fed to the EFF buss, therefore, fader setting affects the signal sent to the [EFF] buss.

**(12) [PAN] control**

Determines the signal balance between the left and right of the stereo busses or odd and even busses of group buss pairs 1-2 and 3-4.

Rotating the control to the right (clockwise) increases the amount of the signal from the channel going to the right of the stereo buss, while decreases the amount of the signal going to the left of the stereo buss.

Rotating the control to the left (counterclockwise) increases the amount of the signal from the channel going to the left of the stereo buss, while decreases the amount of the signal going to the right of the stereo buss.

**(13) [MUTE] switch**

Switches the mute function on or off. When the switch is set to the down position (▼), the post fader signal of the channel is muted.

**(14) [ST/1-2/3-4] assign switches**

Assign or deassign the input channel signal to the corresponding buss pairs (Stereo, groups 1-2 or groups 3-4). When the switch is set to the down position (▼), the signal is assigned to the corresponding buss pair. You can assign the signal to more than one buss pair at the same time.

**(15) [SOLO] switch**

Switches the solo function on or off. When the switch is set to the down position (▼), the pre-fader signal can be monitored via the solo buss. When the [SOLO] switch on any input channel is set to ON, the [SOLO] indicator on the monitor section flashes.

**(16) Channel fader**

Adjusts the output level of the input channel.

## Control unit (Master channel)

### (17) [SUB IN] jacks and control

You can connect a CD player, MD player, etc to the jacks and adjust the input level using the control. By default, the input signals from the [SUB IN] jacks are assigned to input channel 15 and 16, however, you can change the assignment to any desired channel pairs using the "Input" menu of the MENU mode.

### (18) Monitor section

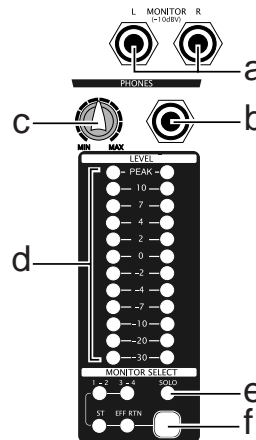
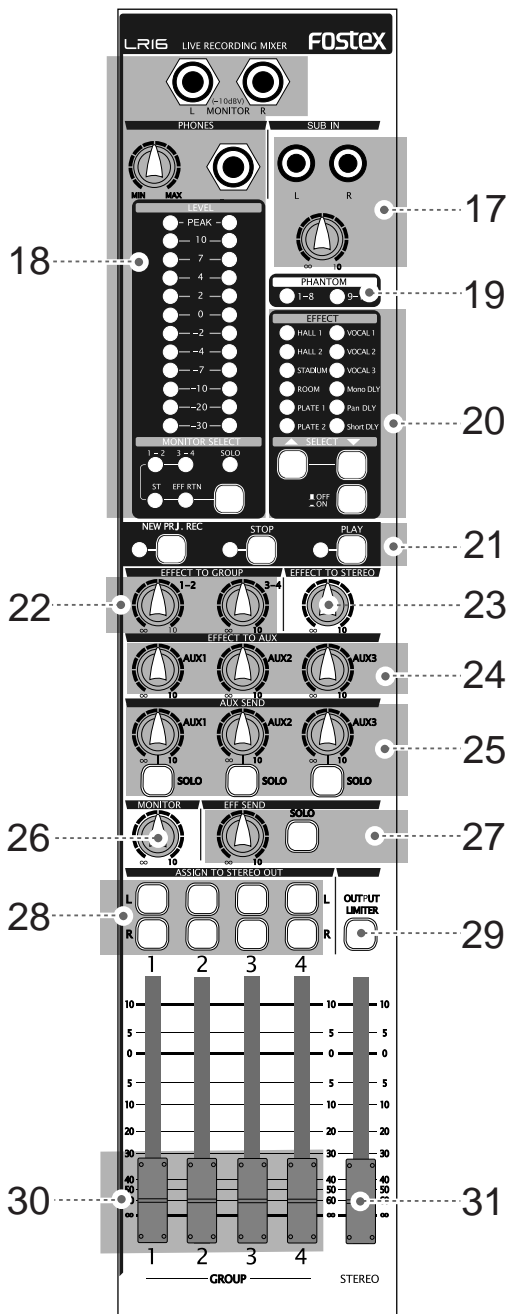

#### (a) [MONITOR L/R] jacks

You can connect a monitor amplifier or powered monitor speakers to these jacks. The output level can be adjusted by the [MONITOR] control.

#### (b) [PHONES] jack

Connects headphones. You can adjust the output level using the [PHONES] and [MONITOR] controls.

#### (c) [PHONES] control

Adjusts the output level of the [PHONE] jack.

#### (d) [MONITOR LEVEL] indicators

Indicate the output level of the monitor signal selected by the [MONITOR SELECT] switch (or the solo monitor signal).

#### (e) [SOLO] indicator

When at least one of the [SOLO] switches is set to ON, the [SOLO] indicator slowly flashes, while the solo monitor signal is output from the [MONITOR (L/R)] and [PHONES] jacks.

#### (f) [MONITOR SELECT] switch

Selects signals to be monitored. You can select from Groups 1-2, Groups 3-4, Stereo and Effect return by pressing the switch as many time as required. When solo monitor is active, the selection is not effective.



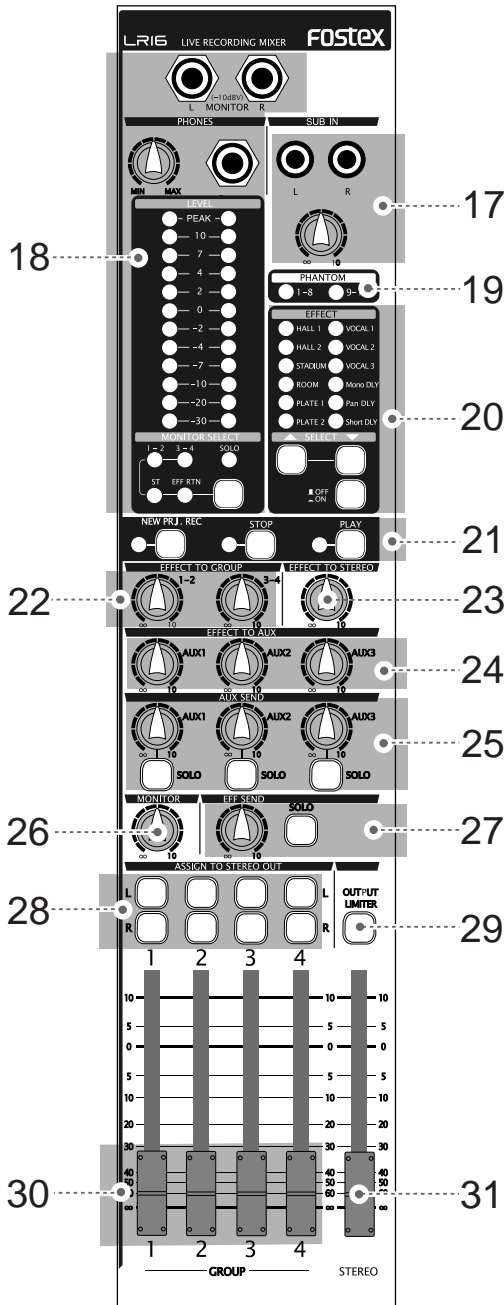

**(19) [PHANTOM (1-8, 9-16)] indicators**

Each indicator illuminates when the corresponding [PHANTOM] switch ([1-8] or [9-16]) is set to ON. The phantom power is supplied to the XLR connectors in eight input groups.

**(20) Internal effects section**

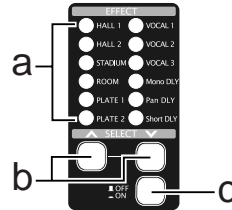

**(a) [EFFECT] indicator**

The current effect type selected by the [SELECT] up/down switches illuminates.

**(b) [SELECT] up/down switches**

Select an effect type (the indicator for the selected effect type illuminates).

When the [EFFECT] on/off switch is set to ON (▲), the current effect is effective.

**(c) [EFFECT] on/off switch**

Switches the internal effects on (▲) or off (■). When the switch is set to the down position (ON), the current effect selected by the [SELECT] up/down switches is effective.

**(21) Recorder control section**

The keys in this section are used for controlling the recorder on the main unit.

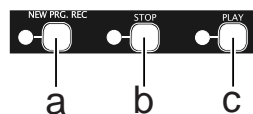

**(a) [NEW PRJ. REC] key**

Pressing the key while at least one of tracks is record-armed creates a new project onto the internal hard disk and starts recording. (Note: Do not use this key when you start recording in Insert mode.)

**(b) [STOP] key**

Locates to the beginning of the current project (ABS 0) and stops.

**(c) [PLAY] key**

Starts playback of the current project.

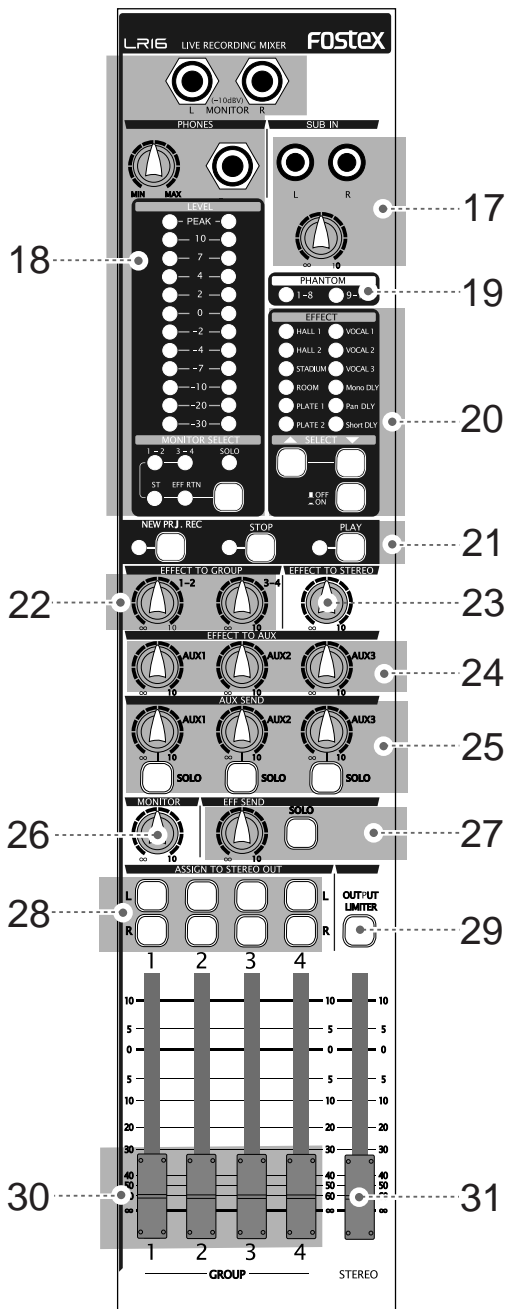

**(22) [EFFECT TO GROUP] controls**

Each control adjusts the output level from the internal effects to the corresponding group buss pairs (1-2 or 3-4).

**(23) [EFFECT TO STEREO] control**

Adjusts the output level from the internal effects to the stereo busses.

**(24) [EFFECT TO AUX (1, 2, 3)] controls**

Each control adjusts the output level from the internal effects to the corresponding AUX buss (1, 2 or 3).

**(25) [AUX SEND] controls / [SOLO] switches**

Each [AUX SEND] control adjusts the output level of the corresponding AUX SEND (1, 2 or 3) output. Each [SOLO] switch allows you to monitor the soloed signal of the corresponding AUX SEND (1, 2 or 3) output. When the switch is down, the solo function is engaged. Each press of the switch toggles between on and off.

**(26) [MONITOR] control**

Adjusts the output level of the [MONITOR (L/R)] and [PHONES] jacks.

The output level of the [PHONES] jack is controlled by the [PHONES] and [MONITOR] controls.

**(27) [EFF SEND] control / [SOLO] switch**

Adjusts the output level of the EFFECT SEND . Each [SOLO] switch allows you to monitor the soloed signal of the EFFECT SEND output. When the switch is down (■), the solo function is engaged. Each press of the switch toggles between on and off.

**(28) [ASSIGN TO STEREO OUT] switches**

Each switch allows you to send the post signal of the corresponding GROUP fader to the [STEREO OUT L/R] jacks. When the switch is down, the signal is sent.

**(29) [OUTPUT LIMITER] switch**

Activates or deactivates the limiter function for all the buss outputs (stereo L/R outputs, group outputs 1 through 4, Aux send outputs 1 through 3, effect send output, and monitor outputs). When the switch is down (■), the limiter function is active.

**(30) [GROUP 1-4] faders**

Each fader adjusts the output level of the corresponding group output signal which is output from the [GROUP OUT] jack.

**(31) [STEREO] fader**

Adjusts the output level of the stereo output signal which is output from the [STEREO OUT (L/R)] and [ST MIX OUT (L/R)] jacks.

## Control unit (rear panel)



### (1) [TO CONTROLLER] connector

Used to connect to the [CONTROLLER] connector of the main unit using the supplied (or a different) CAT5 cable.

## Main unit (front panel)

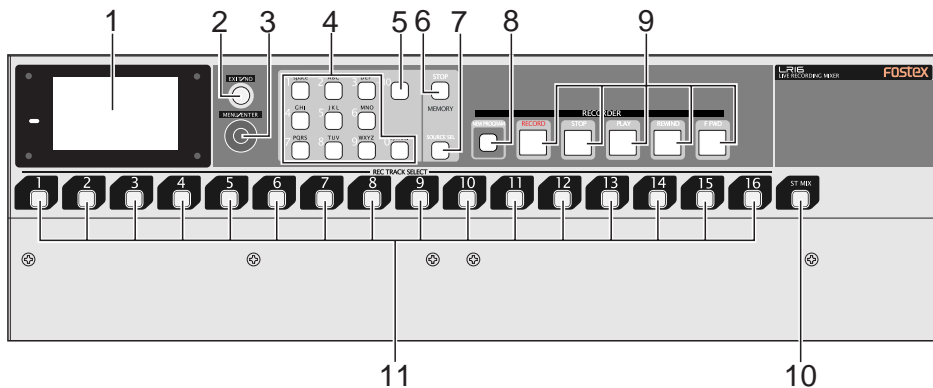

### (1) Display

Displays the input/output level of audio signals or project information.

### (2) [EXIT/NO] key

Used to exit the MENU mode or cancel the setting in the MENU mode.

### (3) [MENU/ENTER] knob

This knob has two functions. Rotating this knob functions as the [MENU] dial, while pressing this knob functions as the [ENTER] key. In this manual, we describe it as the "[MENU] dial" or "[ENTER] key" depending on whether you use it by rotating it or pressing it.

#### [ENTER] key function:

Pressing it while the recorder is stopped enters the MENU mode. It is also used to confirm a setting or execute a function in the MENU mode.

#### [MENU] dial function:

In the MENU mode, rotating it selects an option or enters an alphanumeric character for a name.

While the Home screen is shown, you can adjust the display contrast by rotating it.

### (4) Numeric keys

Pressing a numeric key performs instant start of a mixed file set to the memory play list. When you enter/edit a name (for example, when editing a project name via the "Rename" menu item in the "Project" menu of the MENU mode), you can enter a desired character by using an appropriate key.

### (5) [CLEAR] key

When you edit a name (for example, when editing a project name via the "Rename" menu item in the "Project" menu of the MENU mode), you can delete a character. When you edit time data, you can reset the time value.

### (6) [MEMORY STOP] key

Stops playback in memory play mode. This key does not work except in memory play mode.

### (7) [MEMORY SETUP] key

Pressing this key enter the memory setup mode, in which you can make setting required for memory play.

**(8) [NEW PROJECT] key**

Toggles the new project mode on and off. When the new project mode is set to on, the key illuminates. In this mode, if you press the [PLAY] key while holding down the [RECORD] key, the LR16 automatically creates a new project onto the hard disk drive and starts recording.

**(9) Transport keys**

**[RECORD] key**

If you press the key alone, the recorder enters record ready mode. The key starts flashing while the track meter for a record-armed track on the display shows the input level of the track.

If you press the [PLAY] key while holding down the [RECORD] key, the LR16 performs as follows depending on whether the LR16 is in new project mode or not.

**•When the LR16 is in new project mode:**

The LR16 creates a new project and starts recording.

**•When the LR16 is not in new project mode:**

The LR16 starts recording to the current project in insert mode.

In this condition, you can make additional recording to the project or editing such as punch in/out.

**[STOP] key**

Stops the transport except when memory play is being performed.

If you press the [REWIND] or [F FWD] key while holding down the [STOP] key, the LR16 performs as follows.

**• [STOP] key + [REWIND] key**

The LR16 locates to the beginning of the project (ABS 0).

**• [STOP] key + [F FWD] key**

The LR16 locates to the recording end position (REC END).

**[PLAY] key**

Starts playback of the current project.

**[REWIND] key**

When the transport is stopped, pressing this key fast-rewinds the transport. During playback, pressing this key rewinds the transport at 5x speed with audible cue.

If you press this key while holding down the [STOP] key, the LR16 locates to the beginning of the project (ABS 0).

**[F FWD] key**

When the transport is stopped, pressing this key fast-forwards the transport. During playback, pressing this key forwards the transport at 4x speed with audible cue.

If you press this key while holding down the [STOP] key, the LR16 locates to the recording end position (REC END).

**(10) [ST MIX] key**

You can record a stereo mix signal to the stereo mix track. This key arms or disarms the stereo mix track. When armed, the key flashes.

After recording starts, the key lights up.

You can record to the stereo mix track and multitracks (1 through 16) simultaneously.

**(11) [REC TRACK SELECT (1-16)] keys**

Each of these keys arms or disarms the corresponding track. When armed, the key flashes. After recording starts, the key lights up.

**<Note>:** *If you start playback of the project while no track is record-armed (i.e. all the [REC TRACK SELECT] keys are unlit), the LR16 automatically stops at the recording end position (REC END). If you start playback while one or more tracks are record-armed, the LR16 automatically stops at 24h00m00s. If you start playback at any position after the recording end position (REC END), the LR16 locates to REC END and stops.*

## Main unit (rear panel)

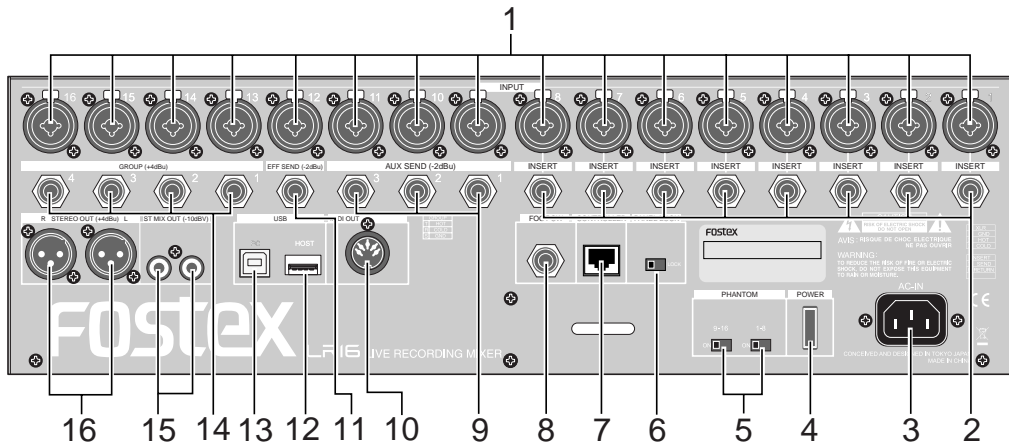
**(1) [INPUT (1 through 16)] connectors**

Each connector accepts a mic or line level analog audio signal. The connector is a combo type - a combined XLR connector and phone jack in one. You can connect a microphone to the XLR connector or connect a line signal to the phone jack. (Note that you cannot use the XLR receptacle and phone jack on a same combo connector simultaneously.)

**(2) [INSERT (1 through 8)] jacks**

Each jack is used for connecting an external effects processor such as a compressor/limiter. To connect an external effects processor, use a Y-cable as shown below.

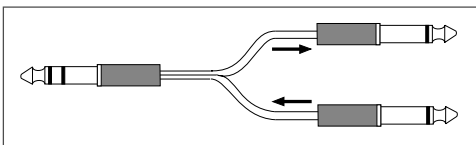
**(3) [AC IN] connector**

Used to connect the supplied power cord.

**<Note>**: Use only the supplied power cord. A different power cord may cause fire, etc. Also note that when you hear thunder rumbling, disconnect the power cord from the AC outlet.

**(4) [POWER] switch**

Turns on or off the LR16.

**<Note>**: Do not turn off the LR16 while accessing the internal hard disk. Doing so may destroy data. Even if you turn off the LR16, it consumes a very small amount of power. Therefore, it is recommended to disconnect the power cord from the AC outlet if you do not use the LR16 for a long time.

**(5) [PHANTOM (1-8, 9-16)] switches**

You can supply phantom power to the XLR INPUT connectors in eight channel groups (1-8 and 9-16) using these switches. When the [PHANTOM] switch is set to ON, the corresponding [PHANTOM] indicator on the control panel is illuminated.

**(6) [PANEL LOCK (ON/OFF)] switch**

You can disable the recorder operation from the panel by setting this switch to "LOCK". In this condition, the lock icon is shown on the display. You can switch the panel lock setting even during recording.

**(7) [CONTROLLER] connector**

Used to connect to the [TO CONTROLLER] connector on the rear panel of the control unit using the supplied (or a different) CAT-5 cable.

**(8) [FOOT SW] jack**

Used to connect to a footswitch for performing punch in/out or memory play start. You can set the footswitch function via the "Foot SW" menu item in the "System" menu of the MENU mode.

**(9) [AUX SEND (1, 2, 3)] jacks**

Each of these unbalanced phone jacks outputs the corresponding AUX SEND buss signal at -2dBu nominal level. You can connect to a stage monitor, effects processor, etc.

**(10) [MIDI OUT] port**

Used to connect to the MIDI IN port of an external MIDI device. From this port, MTC (MIDI Time Code) is output. The MTC frame rate can be set using the "Default frame" menu item in the "System" menu of the MENU mode.

**(11) [EFF SEND] jack**

This unbalanced phone jack outputs the EFFECT buss signal at -2dBu nominal level. You can connect to the input jack of an effects processor, etc.

**(12) [USB HOST] port**

By connecting a FAT16 or FAT32 USB memory stick to this port, you can copy project data (or stereo mix file) to the memory stick and then transfer it to a computer. You can also use the USB memory stick when upgrading the version. (Note that you cannot use the [USB HOST] and [USB PC] ports simultaneously.)

**(13) [USB PC] port**

By connecting to the [USB] port of a personal computer using a USB cable, you can transfer files between the computer and the LR16 by the computer operation. (Note that you cannot use the [USB HOST] and [USB PC] ports simultaneously.)

**(14) [GROUP OUT (1, 2, 3, 4)] connectors**

These balanced phone jacks output the group buss signals at +4dBu nominal level. You can connect these jacks to input connectors of an external mixer, etc.

**(15) [ST MIX OUT (L, R)] jacks**

These unbalanced RCA pin jacks output the stereo L and R buss signals. You can connect these jacks to an external master recorder, etc.

**(16) [STEREO OUT (L, R)] connectors**

These XLR balanced connectors output the stereo L and R buss signals. You can connect these connectors to a power amplifier for driving main speakers on stage, etc.

**Display details**

**HOME screen**

While stopped or during playback or recording, the Home screen as below is shown. On the Home screen, the following items are displayed.

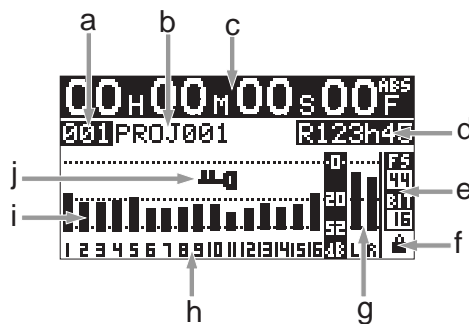

**a) Project number**

The project number of the current project is displayed in three digits. The project number of the first project created on the internal hard disk is "001" and the project number is counted up each time a project is created.

**b) Project name**

The project name of the current project is displayed. The project name of the first project created on the internal hard disk is "PROJ001" and the last three-digit number is counted up each time a project is created. You can specify the default project name via the "Rename" menu item in the "Project" menu of the MENU mode.

**c) Time display**

The current ABS time of the current project is displayed in "hour:minute:second:frame" format. If no recording has been made to the internal hard disk, the time display shows "--H--M--S--F". During recording or playback, the current recorder status icon is shown in the frame digit, as below.

Recorder	Icon
During playback	▶
During recording	●
During forwarding	▶▶
During rewinding	◀◀

**d) Remain**

The remaining time of the hard disk is displayed. It is displayed only while arming tracks or during recording. Increasing the number of recording tracks decreases the remaining time.

**e) Sampling frequency and bit rate**

The combination of sampling frequency and bit rate currently selected in the "Default FS" menu item in the "System" menu of the MENU mode is displayed. When recording a new project, this combination is applied. If the displayed combination does not match the current project, it flashes.

**f) Protection**

The lock icon is displayed when the current project is protected. You cannot make recording or editing when a protected project is loaded. You can protect or deprotect the current project using the "Protect" menu item in the "Project" menu of the MENU mode.

**g) Level meters for stereo busses**

The signal levels of the stereo L and R busses are displayed.

**h) Tracks**

A record-armed track is displayed in flashing. When you starts recording, it changes from flashing to lighting.

**<Examples>**

If you arm track 4: "4" flashes.

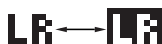

If you arm stereo mix track using the [ST MIX] key: "LR" flashes.

**i) Level meters for tracks 1 through 16**

Each level meter shows the input (recording) level when the corresponding track is in record ready or record mode, while it shows the track playback level when the corresponding track is being played back.

**j) Panel lock**

When the panel lock function is engaged, the panel lock key icon is displayed. When the lock key is displayed, the operation keys on the recorder section of the main unit are disabled.

**MENU mode screen**

While the recorder stopped, pressing the [ENTER] key in the recorder section of the main unit enters the MENU mode and brings up the following screen.

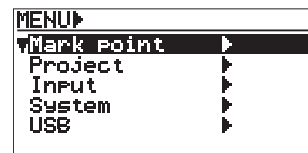

This screen allows you to select a main menu. By using the [MENU] dial to highlight the desired main menu and pressing the [ENTER] key, the display shows the next menu level. (The ">" icon on the screen indicates that the next menu level exists.)

There are the following five main menus.

1. Mark point menu
2. Project menu
3. Input menu
4. System menu
5. USB menu

**Memory play setup mode screen**

While the recorder stopped, pressing the [MEMORY SETUP] key in the recorder section of the main unit brings up the memory play setup screen as below.

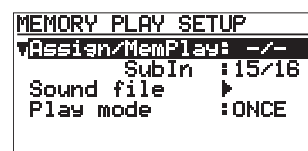

In this screen, you can make setting for memory play including the channel assignment, playlist setting and play mode setting, as well as destination assignment of the "Sub In" signal.





# Mixer functions

# Mixer basics

## Signal flow of the mixer

A mixer accepts audio signals and modifies them, then mixes them.

The following diagram shows how the input signals flow through the mixer section of the LR16. As the diagram indicates, an analog signal from the [INPUT] connector is level-adjusted by the [TRIM] control and converted to digital, then sent to the channel fader via the EQ. After the channel fader, the pan control adjusts the left and right (or odd and even) balance of signal sent to stereo left and right busses (or odd and even group busses). Then the stereo signal is finally level-adjusted by the [STEREO] fader and output from the [STEREO OUT (L, R)] connectors.

A buss sums signals and mixes them. In the diagram below, busses are shown as pipes. The LR16 provides the following eleven busses: stereo busses (L, R), group busses (1, 2, 3, 4), AUX busses (1, 2, 3), effect buss and solo buss. Each buss sums signals. The mixed signal may be D/A converted and fed to an external device, or directly fed to the internal effects.

The LR16 is equipped with a hard disk drive for recording and playback. You can perform up to 16 track multitrack recording as well as stereo mix recording. (You can perform multitrack and stereo recording simultaneously.)

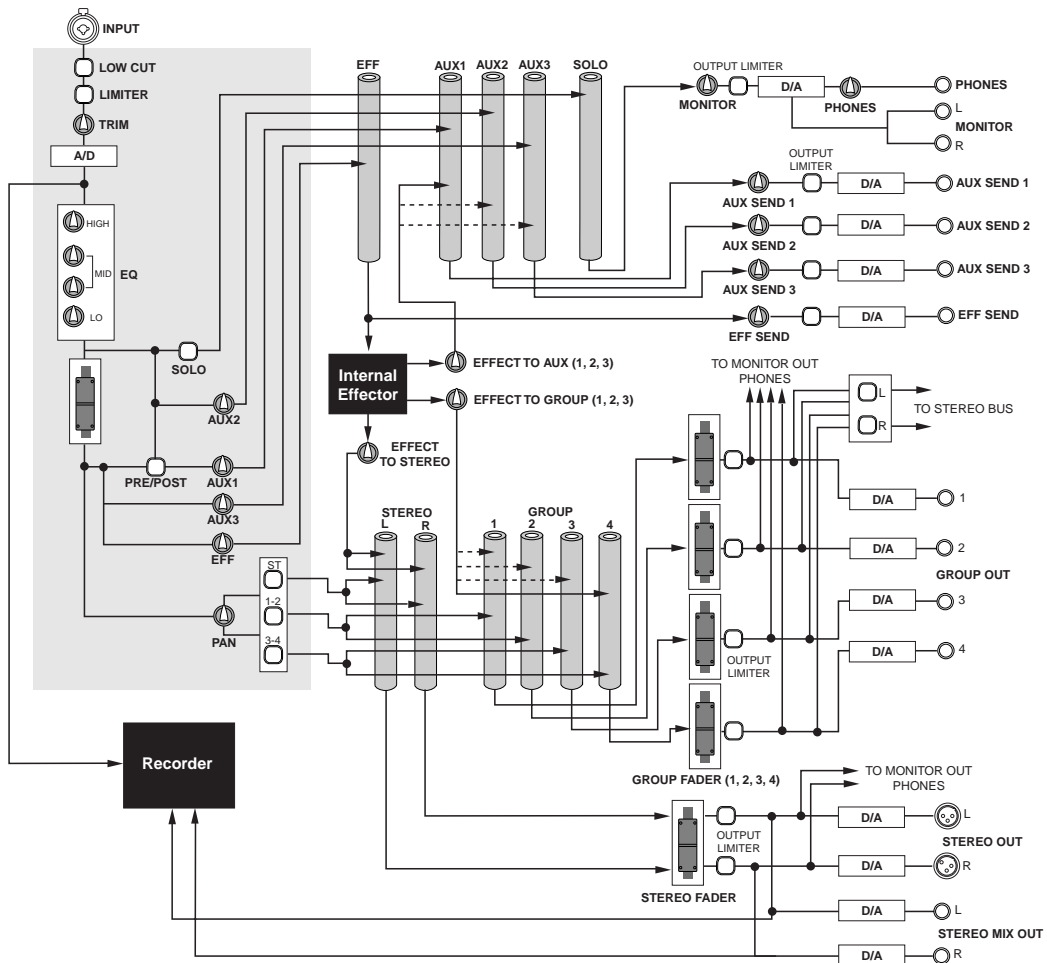

## Connecting sources

### • Connecting sources to the input connectors

Each of mixer channels 1 through 16 provides a combo type -- a combined XLR connector and phone jack in one. You can connect a microphone to the XLR connector or connect a line signal to the phone jack. (The phone jack can accept both balanced and unbalanced signals.)

You can adjust the input gain using the [TRIM] control on each mixer channel strip.

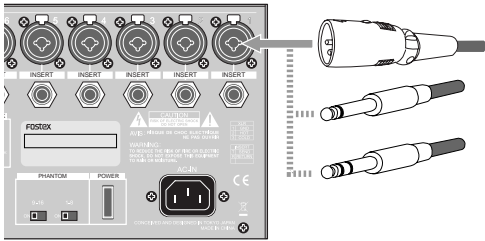

### • Phantom power supply setting

48 V phantom power can be supplied to the XLR input connectors. For most of condenser microphones, the phantom power is required.

You can turn on or off phantom power using the [PHANTOM] switches in eight channel groups (1-8 and 9-16) using these switches.

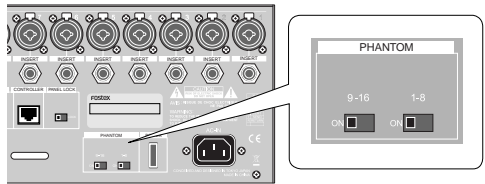

**<Memo>**: When the [PHANTOM] switch is set to ON, the corresponding [PHANTOM] indicator on the control panel is illuminated.

PHANTOM

1-8

9-16

**<Note>**: When you turn off phantom power, the indicator is not immediately turned off, however, phantom power is immediately turned off.

**<Note>**: When you turn on the phantom power, make sure that the [TRIM] controls on the corresponding mixer channels are set fully left (minimum) or the LR16 is powered off.

Usually phantom power does not damage a dynamic microphone, however, do not connect an old ribbon microphone to an input connector to which phantom power is supplied.

### • Selecting channel source

Setting the [SOURCE] switch on each mixer channel to "INPUT" (■) selects the channel input signal. Setting the [SOURCE] switch to "TRK" (▲) selects the track playback signal, or the [SUB IN] signal or the memory play signal when it is assigned to the channel.

## Adjusting the input level

The [TRIM] control adjust the head amp gain of each input signal. To get the optimum gain, set this control appropriately so that the [PEAK] indicator lights at the maximum input level.

By adjusting this control appropriately, the LR16 can accept a signal within -60dBu and -12dBu for an XLR connector is connected, while it can accept a signal within -40dBu and +8dBu when a phone plug is connected.

**<Memo>**: It is important to set the [TRIM] control appropriately. Otherwise, the signal may be distorted or noisy.

The diagram shows three waveforms between horizontal dashed lines representing clipping levels. The first waveform is labeled 'Optimum gain' and shows a clean sine wave. The second is labeled 'Too high' and shows a distorted, clipped sine wave. The third is labeled 'Too low' and shows a smaller amplitude sine wave.

**<Note>**: The [TRIM] control the gain of the head amplifier with a two-stage pre-amp and there is a point where the gain is switched (at approx. -35 dBu for XLR input, -15 dBu for phone input). At this point, a noise may be generated.

### <Gain adjustment while monitoring>

To adjust the gain while monitoring an input signal, connect headphones to the [PHONES] jack (or connect a powered monitor speaker to the [MONITOR OUT] jacks) and rotate the [PHONES] control (or [MONITOR] control) little to the right from the leftmost position. In this condition, perform the following.

- 1) Press the [SOLO] switch on the mixer channel to solo the channel.
- 2) Input the source sound (from a microphone or line).
- 3) Rotate the [PHONES] control (or [MONITOR] control) clockwise gradually.
- 4) Adjust the [TRIM] control to get the optimum gain.
- 5) After adjusting the gain, press the [SOLO] switch to de-solo the channel.

### • Low-cut filter

The low-cut filter is often known as a high-pass filter. It passes high frequencies and eliminates low frequencies.

By pressing the [LOW CUT] switch to set to "ON" (—), the ultra low frequencies under 80 Hz are eliminated with a -12 dB/octave slope.

The low-cut filter helps prevent wind noise, mic handling noise, etc. It is recommended to enable the low-cut filter when you connect a microphone.

### • Limiter

The limiter can be used to prevent clipping when a too hot signal is input.

The limiter does not work as far as an input signal is below the threshold level. When the input signal exceeds the threshold level, it reduces or attenuates the input signal thereby holding the output signal level too high.

The output limiter provided in the master section is effective to prevent damaging the main speakers in live or PA applications.

## Equalizer

You can tailor the sound using the channel equalizer. For best results, the equalizer should be used to make the sound natural.

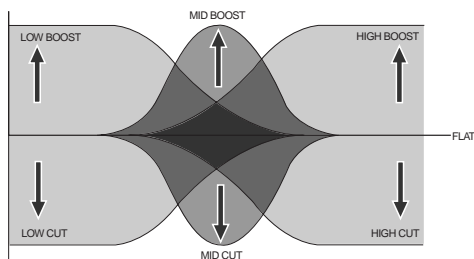

**<Note>**: You can equalize the pre-fader signal which is not affected by the channel fader. Note that you cannot equalize the signal sent to a track for recording.

**<Memo>**: In general, the range of frequency of sound that human beings can hear is about 20 Hz to 20 kHz. The following shows the frequency ranges of instruments and vocals.

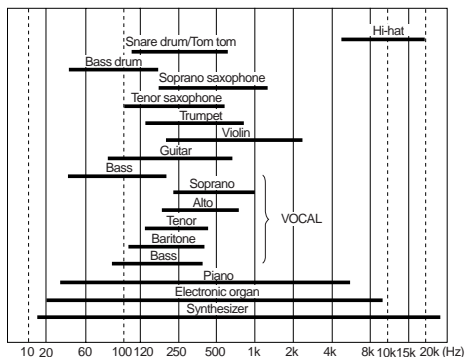

### <Tips for equalizing>

If the mixed sound is not clear, we recommend to find the channel which makes the mixed sound unclear and slightly cut the frequency range of the channel. Too much boosting may make the mixed sound unclear.

Listen to the mixed sound repeatedly, comparing with the original (non-EQ) sound, and challenge to make your favorite sound.

Using of low-cut filter may be effective when you use a microphone.

### EQ HIGH

The EQ HIGH is a shelving type EQ which provides up to 18 dB of boost or cut above 12 kHz. The center detent position of the control is the flat position. You can emphasize a cymbal or sharpen a vocal, keyboard or guitar by boosting the EQ HIGH. You can soften the high frequency sound by cutting the EQ HIGH.

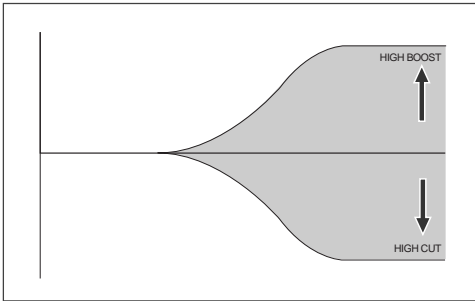

### EQ MID

The EQ MID is a peaking type EQ which provides up to 18 dB of boost and cut at the center frequency. You can sweep the center frequency between 100 Hz and 8 kHz. The center detent position of the control is the flat position. For most of sound sources, the mid frequency range absolutely effects the sound. Therefore, you can dramatically tailor the sound using the EQ MID.

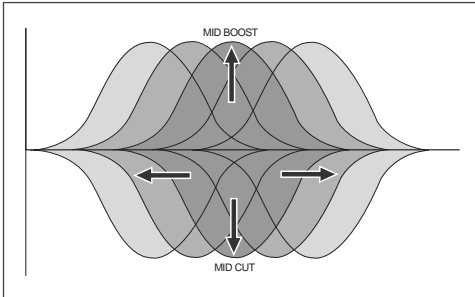

### EQ LO

The EQ LO is a shelving type EQ which provides up to 18 dB of boost or cut below 80 Hz. The center detent position of the control is the flat position. You can emphasize a kick, guitar, bass, etc.

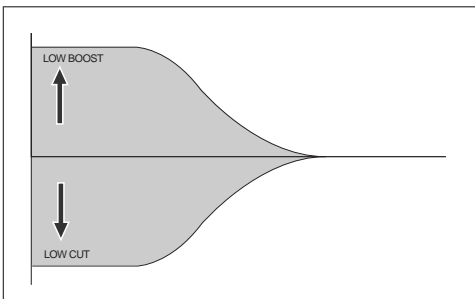

## Using an external effect processor

### • Using AUX 1, 2 and 3

You can use AUX busses for sending channel signals to an external effects processor or stage monitor, etc.

The [AUX] send control on each mixer channel adjusts the amount of the channel signal sent to the AUX buss. The signal after the [AUX SEND] control in the master section which adjusts the total AUX buss level is output from the [AUX SEND] jack.

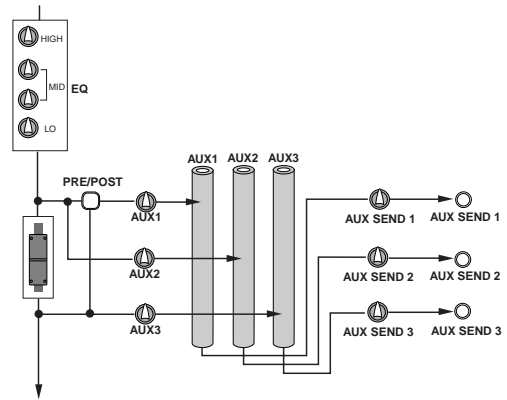

There are two send signal types - pre-fader and post-fader. You can select pre- or post-fader for the AUX 1 buss. The AUX 2 buss is fixed to pre-fader, while the AUX 3 buss is fixed to post-fader.

In general, you send a post-fader signal to an effects processor, while you send a pre-fader signal for stage monitoring.

#### Pre-fader

A channel signal before the channel fader is sent to the buss. You can make a mix which is completely independent from the main mix. Pre-fader AUX sends are generally used for the monitor mix, because the channel faders don't affect the AUX send signals. Any adjustments made to the front-of-the-house mix don't affect the balance heard by the performers onstage.

#### Post-fader

A channel signal after the channel fader is sent to the buss. Post-fader Aux sends are generally used for connecting to external effects processors. The send signal is raised or lowered according to the channel fader.

**• Using Insert**

The [INSERT] jack, as well as the AUX post send, is used for connecting to an external processor. Unlike the AUX send, you can apply effects to a single channel signal.

The LR16 provides the [INSERT] jacks for mixer channels 1 through 8. Each jack is used mainly for connecting a compressor, limiter, equalizer, etc.

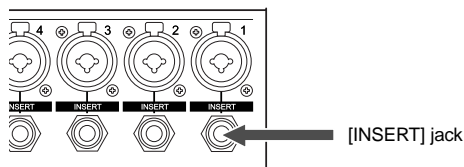

By connecting an external effect processor to the [INSERT] jack, you can send the channel signal to the processor and receive the processed signal.

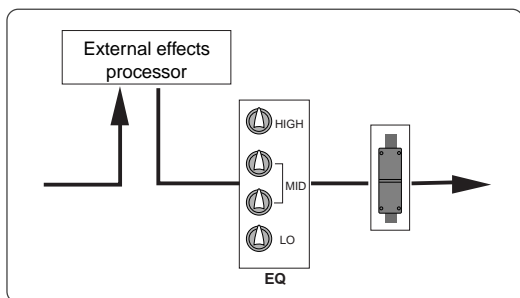

The [INSERT] jack on the LR16 is the TRS-type unbalanced phone jack. You can make bidirectional connection with the effect processor using a "Y" cable as shown below.

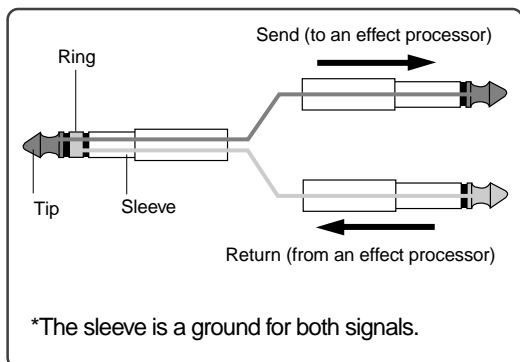

**Using the internal effects processor**

The LR16 features the internal effects (reverb/delay) processor, which allows applying effects to the mixer channel signals.

The effect send signal of each channel is adjusted by the [EFF] control after the channel fader. The effected (wet) signal is adjusted using the controls in the [EFFECT TO STEREO], [EFFECT TO GROUP] and [EFFECT TO AUX] sections and sent to the stereo, group and AUX busses.

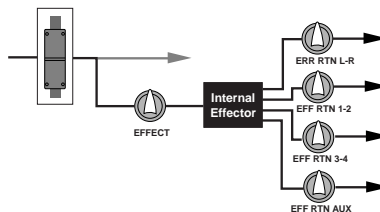

**• Applying the internal effects**

The following shows how to send the effected (wet) signal from the internal effects processor to the stereo L/R buss.

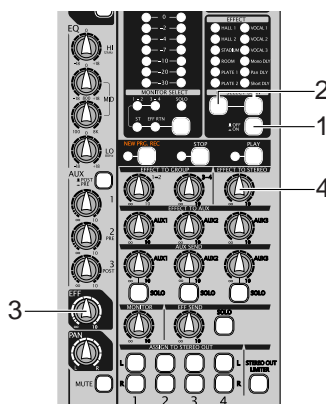

- (1) Set the [EFFECT ON/OFF] switch to "ON" (—).
- (2) Select the desired effect type using the [SELECT UP/DOWN] switch. The indicator for the selected type is illuminated. (See the next page for details about each effect type.)
- (3) Adjust the effect send level of the channel signal using the [EFF] control on each mixer channel. Note that the effect send level is affected by the channel fader.

**(4) Adjust the effected (wet) signal level sent to the stereo L/R buss using the control in the [EFFECT TO STEREO] section**

Adjust the effected signal level while monitoring the stereo buss signal using headphones or monitor speakers.

**<Memo>**: To send the effected signal to the group or AUX busses, use the controls in the [EFFECT TO GROUP] or [EFFECT TO GROUP] section.

**• About the effect types**

<b>HALL 1</b>	Standard hall reverb; detailed and transparent, with a moderate amount of early reflections.
<b>HALL</b>	Stadium reverb characterized by long early reflections.
<b>STADIUM</b>	Reverb simulating an auditorium with suppressed reverberation.
<b>ROOM</b>	Room reverb simulating a moderate space with some sparkle.
<b>PLATE 1</b>	Modem-sounding plate reverb with wide bandwidth.
<b>PLATE 2</b>	Plate reverb with a gentle character.
<b>VOCAL1</b>	All-purpose hall reverb with no early reflections, and uniform decay at all frequencies.
<b>VOCAL 2</b>	Plate-like reverb is added to a spacious short delay. This blends well with any genre of music.
<b>VOCAL 3</b>	All-purpose reverb (karaoke style) that makes any vocal sound professional.
<b>Mono DLY</b>	Mono delay.
<b>Pan DLY</b>	Panning delay.
<b>Short DLY</b>	Short delay.

**Monitoring**

You can monitor the signal using headphones via the [PHONES] jack or using monitor speakers via the [MONITOR L/R] jacks.

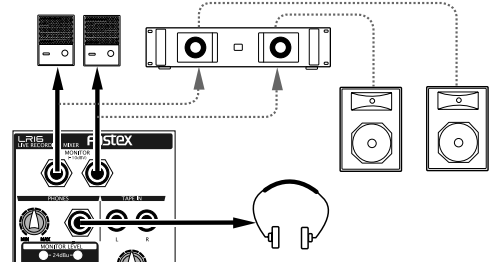

The signal to be monitored can be selected using the [MONITOR SELECT] switch. Each press of the switch changes the monitor signals and the indicator for the current monitor signal (ST, 1-2, 3-4 or EFF RTN) is lit.

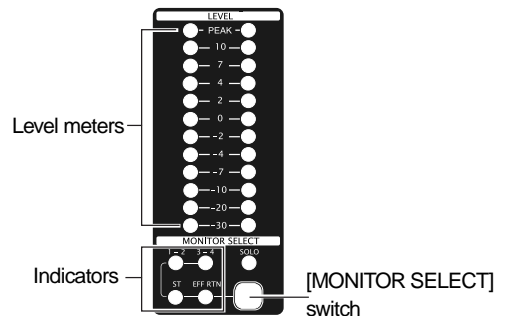

<b>ST</b>	You can monitor the stereo L and R buss signal, which is output from the [STEREO OUT (L, R)] jacks.
<b>1-2</b>	You can monitor the group 1 and 2 buss signals, which are output from the [GROUP (1, 2)] jacks.
<b>3-4</b>	You can monitor the group 3 and 4 buss signals, which are output from the [GROUP (3, 4)] jacks.
<b>EFF RTN</b>	You can monitor the output signal (wet signal) of the internal effects processor.

The output level of the [PHONES] jack is controlled by the [MONITOR] and [PHONES] controls, while the output level of the [MONITOR L/R] jacks is controlled by the [MONITOR] control. The output levels of the monitoring signals are shown on the level meters above the [MONITOR SELECT] switch.

**<Note>**: If any of the [SOLO] switches is set to ON, the solo signal is monitored, while the signal selected by the [MONITOR SELECT] switch is interrupted.

• Solo monitor

By setting the [SOLO] switch(es) to ON (—), you can solo monitor the corresponding channel signal(s).

If at least one of the [SOLO] switches is set to ON, the [SOLO] indicator slowly flashes.

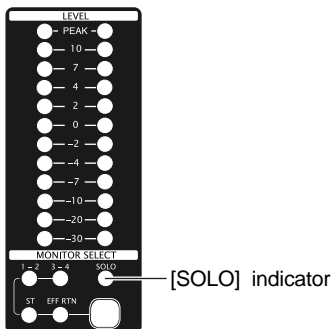

You can find the [SOLO] switches on channels 1 through 16, the effect send, and AUX sends 1 through 3 (see below).

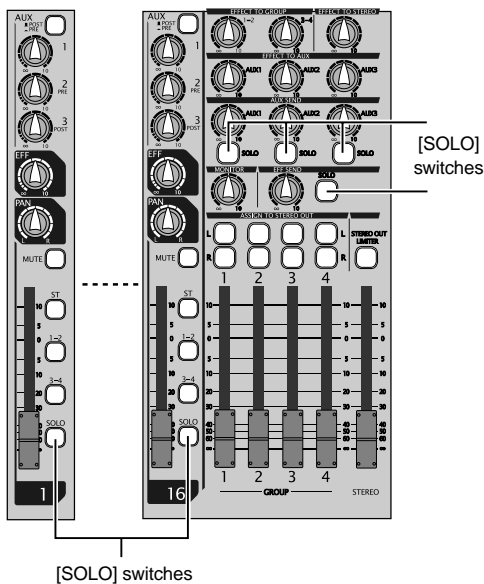

**<Note>**: If any of the [SOLO] switches is set to ON, the solo signal is monitored, while the signal selected by the [MONITOR SELECT] switch is interrupted.

Channel grouping

You can group channels to group busses for effective mixing.

Using the channel grouping function, you can adjust levels of grouped channels using a single fader while maintaining the balance between channels.

By setting the group assign switch (1-2 or 3-4) of a channel to ON, the channel signal is sent to group busses 1 and 2 or 3 and 4. A group buss signal is output from the [GROUP OUT] jacks.

When the [ASSIGN TO STEREO OUT] switch above the group fader is set to ON, the group buss signal is output to the corresponding stereo buss.

For example, it would be a good idea to assign channels for drums to a group. You can control the level of drums using the corresponding group fader without altering the balance.

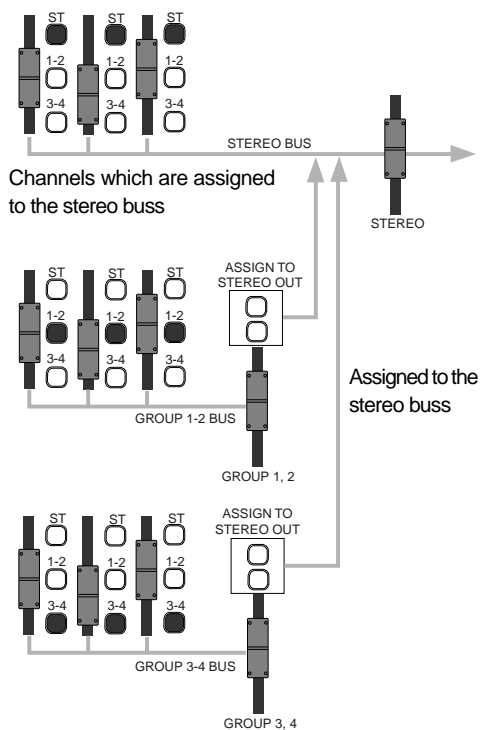

Channels which are assigned to the group busses



## Using SUB IN

You can connect a stereo audio source such as a CD player, MD player, etc., to the [SUB IN (L, R)] jacks and output it directly from the control unit.

Therefore, you can connect a BGM source and play it back during a break in the show, etc.

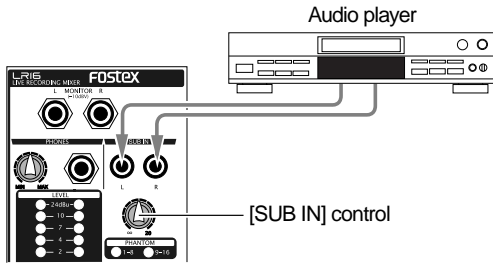

The input signals from the [SUB IN] jacks are level-adjusted by the [SUB IN] control. The signals from the [SUB IN] jacks are assigned to channels 15 and 16 by default, however, you can change the assignment using the "Input" menu of the MENU mode (see "Other functions" on page 79 for details).

The following shows the setting example for playing back the signals from the [SUB IN] jacks by the main speakers of a live stage.

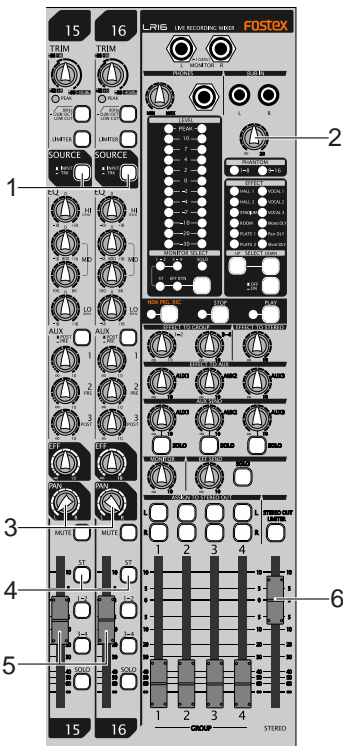

- (1) **Set the [SOURCE] switches on channels 15 and 16 to "TRK" (—).**  
The input signals from the [SUB IN] jacks are selected as the sources of channels 15 and 16.
- (2) **Use the [SUB IN] control to adjust the level of the signals from the [SUB IN] jacks.**  
You can use the [SUB IN] control to adjust the level of the signals from the [SUB IN] jacks, but cannot use the [TRIM] control for them.  
The level of the signals after the [SUB IN] control are displayed on the level meters of the display.
- (3) **To output the signals from the [SUB IN] jacks in stereo, set the [PAN] control on channel 15 to "L" and set the [PAN] control on channel 16 to "R".**
- (4) **Set the [ST] assign switches on channels 15 and 16 to "ON" (—).**  
The signal from the [SUB IN] jacks is routed to the stereo L/R buss.
- (5) **Use the channel faders on channel 15 and 16 to control the output level of the channel signals sent to the stereo L/R buss.**
- (6) **Use the [STEREO] faders on channels 15 and 16 to control the level of the stereo buss signal output from the [STEREO OUT (L, R)] connectors, which affects the main speaker volume.**

**<Memo>**: The [SUB IN] jacks can be used to increase the total number of inputs by connecting to a sub mixer.

# Block diagram

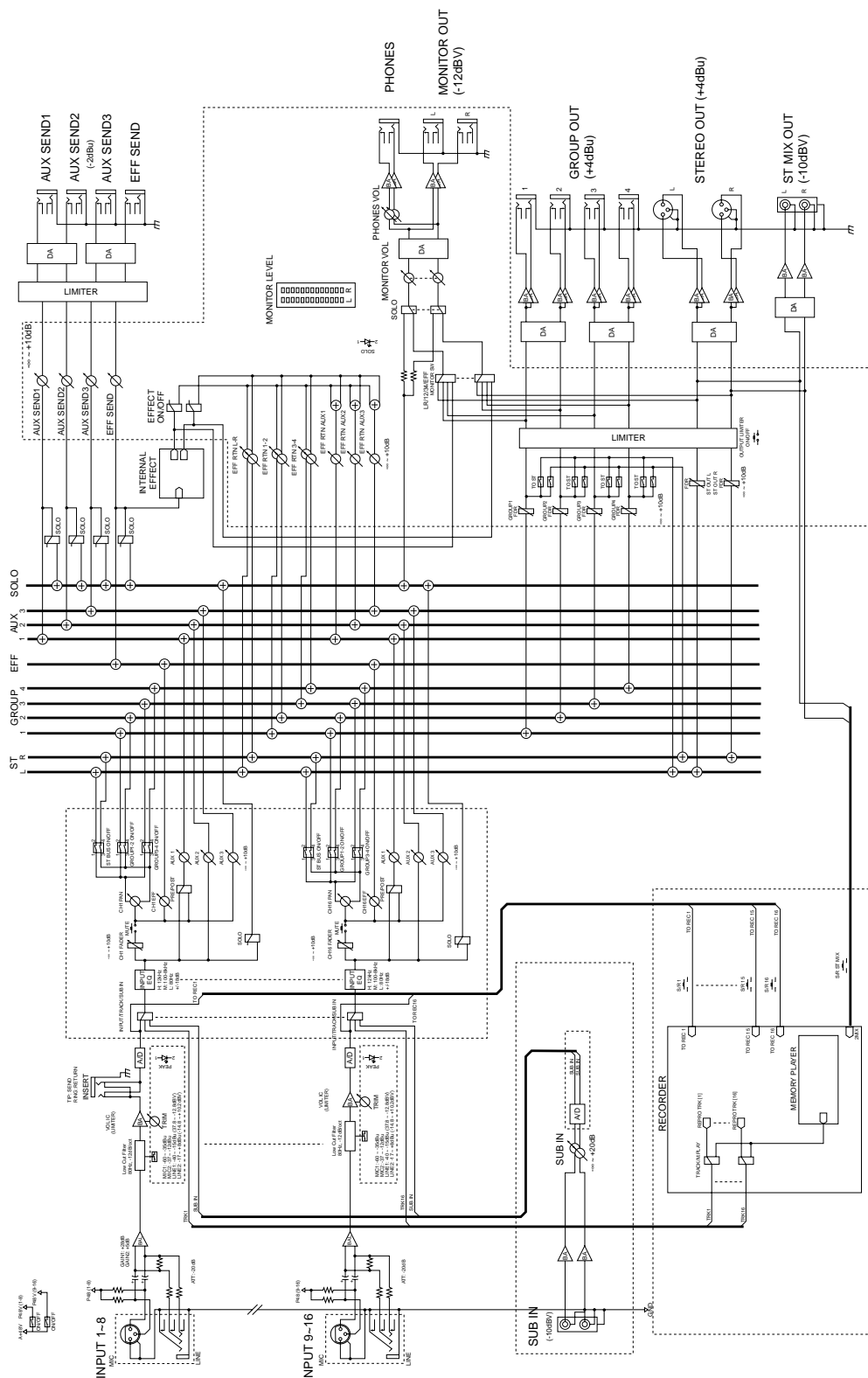

# Recorder functions

# Recording/playback

## Recorder basics

Before starting recording, understand the basics of the recorder of the LR16.

### Recording format

The recorder section of the main unit is equipped with the 3.5 inch hard disk drive. You can record a linear 16 or 24 bit audio file at 44.1kHz or 48 kHz Fs.

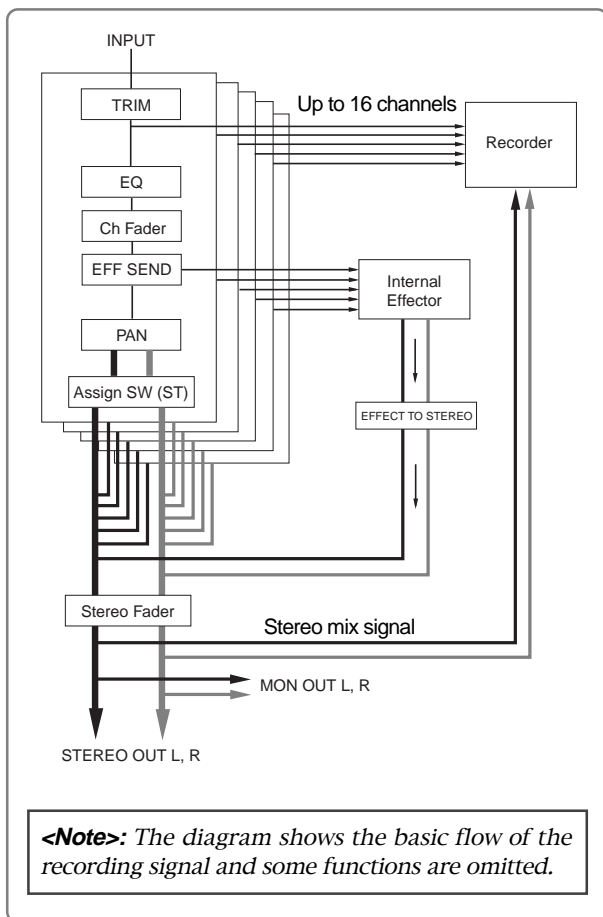
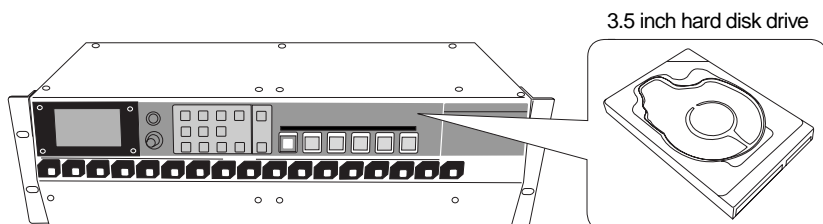

The recorder section of the LR16 provides 16 multitracks and stereo L and R tracks. It allows direct recording of up to 16 channel analog signals and stereo mix recording simultaneously. Each analog input signal is converted to digital after being level-adjusted using the [TRIM] control and directly sent to the corresponding track, while it can be sent to the stereo tracks through the mixer channel where you can tailor the signal using the mixer functions including the equalizer, internal effects processor, etc. Therefore, you can simultaneously perform multitrack recording and rough mix recording during live performance.

The recorder also provides basic multitrack recorder functions such as overdubbing and punch-in/out.

**<Memo>:** The hard disk of the recorder is FAT32 formatted and a file recorded by the LR16 is compatible with a personal computer. You can export a file to a computer or copy a file from a computer.

## Recording mode

The LR16 recorder provides two recording modes: the new project mode and insert mode.

<b>New project mode</b>	The LR16 automatically creates a new project and starts recording from the beginning of the project. To perform recording in new project mode, press the [PLAY] key while holding down the [RECORD] key when the [NEW PROJECT] key is set to "ON", or press the [NEW PRJ.REC] key regardless of [NEW PROJECT] key setting.
<b>Insert mode</b>	The LR16 starts recording from the beginning of an existing project or performs additional recording on an existing project which has been recorded. You can perform overdubbing, punch in/out, etc. To perform recording in insert mode, press the [PLAY] key while holding down the [RECORD] key when the [NEW PROJECT] key is set to "OFF".

## Project

When you perform recording in new project mode (or when you create a new project using the "Project" menu of the MENU mode), three folders as shown on the right are created in the root of the hard disk.

The folder at the top ("PROJ001") is called "project". You can make up to 250 projects on the hard disk.

Each project on the hard disk is independent and you can perform recording, playback, punch in/out, etc. without affecting the other projects. The LR16 automatically gives a project name to each project. The name of the first created project is "PROJ001" and the number (given by the last three digits) is automatically counted up each time a new project is created.

You can change a project name automatically given to a desired one later. (See page 66 for details.)

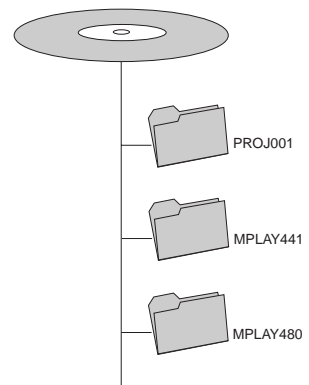

**<Memo>**: The "MPLAY441" and "MPLAY480" folders shown right above are empty when they are created. Only one "MPLAY441" folder and only one "MPLAY480" folder exist in the LR16 hard disk even if you create more than one project. These folders are used to store stereo files transferred from a computer to the LR16. As the folder names imply, the "MPLAY441" folder stores 44.1 kHz files, while the "MPLAY480" folder stores 48 kHz files.

When you start recording for the first time, 16 mono WAV files for tracks 1 through 16, as well as the "2mix" and "LOG" folders, are automatically created in the "PROJ001" folder.

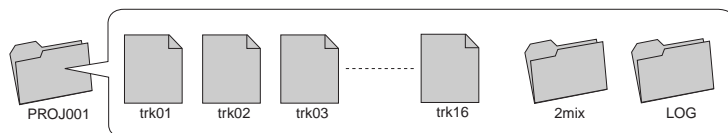

In the "2mix" folder, stereo mix files (stereo WAV files) created by stereo mix recording of the LR16 are stored. In the "LOG" folder, the ADL files of the project is stored.

You can play back mono files for tracks 1 through 16.

A stereo mix file can be played back using the memory play function. The ADL files stored in the "LOG" folder are used when you retrieve the pre-edited condition of an edited project, instead of the undo/redo function often found on other digital recorders. (See page 67 for details.)

## Live recording

The following shows the setting example of live recording in which the LR16 is used as a PA mixer.

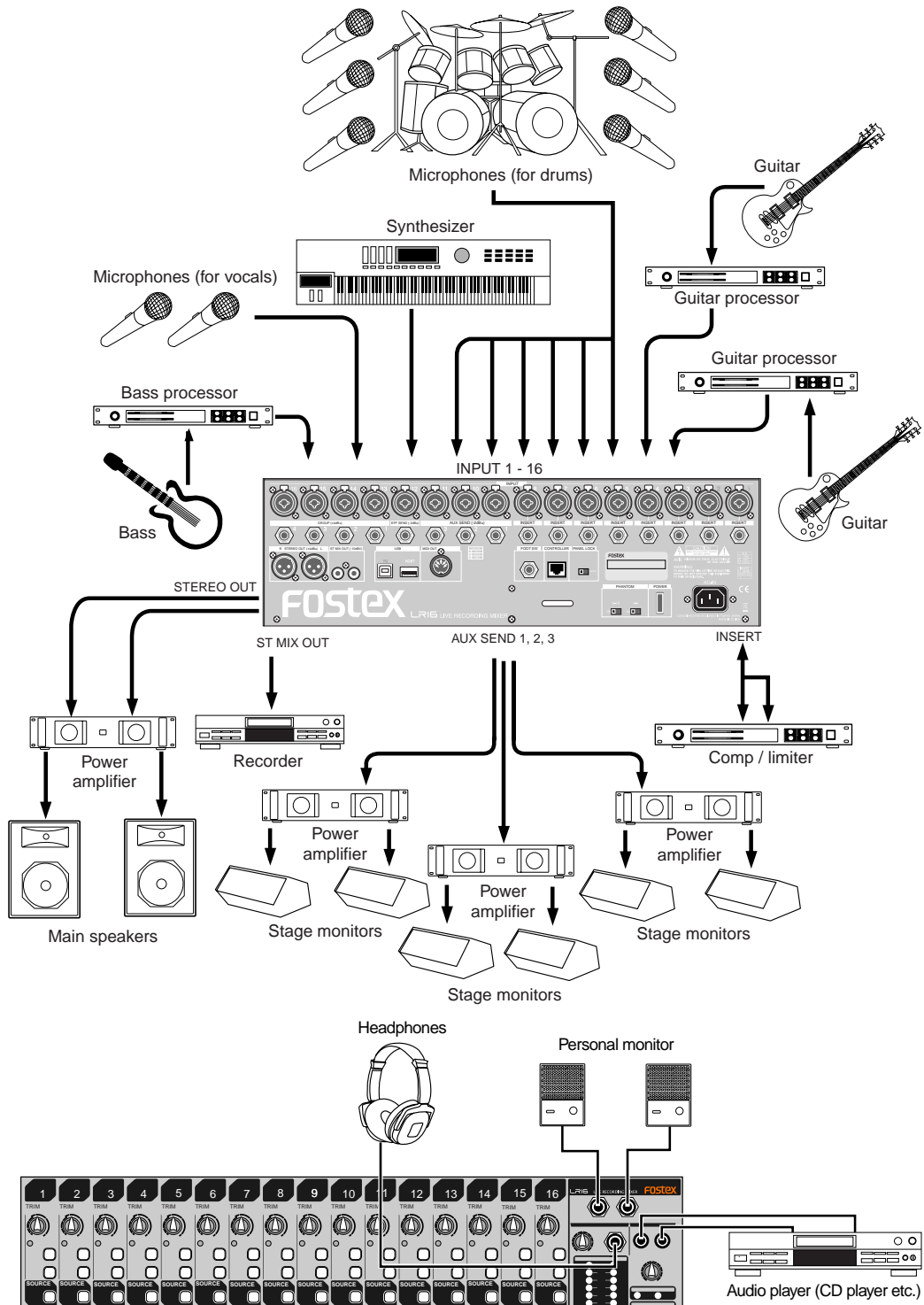

You can perform live recording while you use the LR16 as a PA mixer on live stage.

**<Recording to tracks 1 through 16>**

Each channel input signal is directly routed to the corresponding recorder track (shown by the heavy line in the diagram on the right).

Each input signal is level-adjusted by the [TRIM] control and converted to digital, then routed to the recorder track, without being tailored by the equalizer, etc. Therefore, you can record pure input signals which are not affected by mixer setting for PA.

You can edit and mix down the signals recorded on tracks 1 through 16 after live performance.

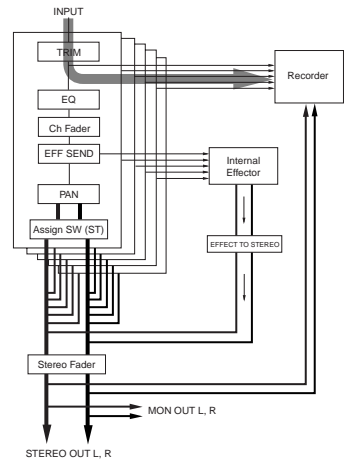

**<Recording the stereo mix>**

Mixed channel input signals are routed to the stereo mix track through the mixer channel (shown by the heavy line in the diagram on the right).

Each input signal goes to the mixer channel and is tailored using the EQ, internal effects, etc., then is routed to the stereo buss where all input signals are mixed, and then routed to the stereo mix track.

Therefore, the same signal as the [STEREO OUT] and [MON OUT] signal is recorded to the stereo mix track.

In other words, you can record the same signal as the PA output signal.

You can play back a stereo mix file recorded to the stereo mix track using the memory play function.

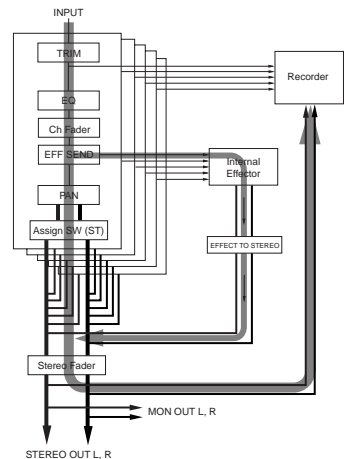

**<Recording to tracks 1 through 16 and stereo mix track simultaneously>**

You can record each input signal individually to the corresponding track (shown by the dotted line on the right diagram), while recording the stereo-mixed signal to the stereo mix track simultaneously.

In other words, you can record the same signal as the PA output signal, as well as record individual signals independently. You can edit and mix down the individual signals recorded on tracks 1 through 16 after live performance.

\* You can play back the project recorded on tracks 1 through 16, while you can play back the stereo mix using the memory play function.

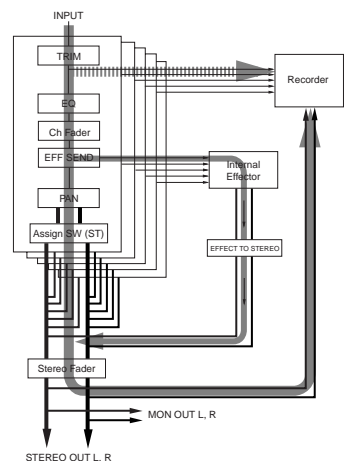

The following shows the procedure for rehearsing recording to tracks 1 through 16 as well as to the stereo mix track simultaneously in new project mode during live performance. In the following description, it is assumed that no project is created to the internal hard disk ("No project" is shown on the display).

**<Memo>**: To perform recording to an existing project, use the insert mode (see page 65 for details about how to create a new project).

**Preparation**

- (1) **Select Fs/bit of the project and MTC frame rate.**  
By default, Fs/bit is set to "44.1kHz/16 bit" while MTC frame rate is set to "25fps". You can change them before recording.

**<Memo>**: See pages 82 and 83 for details about how to change settings of Fs/bit and MTC frame rate.

- (2) **Change the destination channels of Sub In from "15/16" (default) to "-/-" (no channels are assigned).**  
You can now record to all of tracks 1 through 16.

**<Memo>**: See page 79 for details about how to assign the destination channels of Sub In.

**Adjusting input level (=recording level) of each mixer channel**

- (1) **Set the [SOURCE] switch on each of mixer channels 1 through 16 to "INPUT" (■).**  
The input source from the corresponding [INPUT] connector is selected as the channel source of each channel.
- (2) **Set all the [REC TRACK SELECT] keys (1 through 16) and the [ST MIX] key in the recorder section to ON.**  
All the keys start flashing. On the display, track numbers "1" through "16" and "LR" start flashing, while the recordable remaining time is shown.

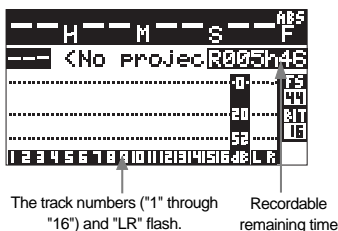

**<Memo>**: To record only tracks 1 through 16, set only the [REC TRACK SELECT] keys 1 through 16 to ON. To record only the stereo mix track, set only the [ST MIX] key to ON.

- (3) **Press the [RECORD] key.**  
The key lights up and the level meters 1 through 16 on the display now show the recorder input levels (= mixer channel levels).

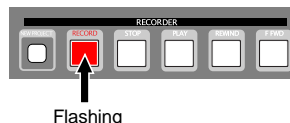

- (4) **Use the [TRIM] control each of mixer channels 1 through 16 to adjust the input level.**  
Adjust the [TRIM] control appropriately so that the [PEAK] indicator is lit at the loudest part of playing.



**<Note>**: The recording level of each track is equal to the mixer channel level adjusted by the [TRIM] control. Therefore, levels shown on the display can be regarded as recording levels as well as mixer channel levels.

**<Memo>**: If you want to adjust the input level of each mixer channel while monitoring, set the [SOLO] switch on the desired channel(s) to "ON" (■). When any [SOLO] switch is "ON", the [SOLO] indicator in the MONITOR SELECT section flashes slowly.

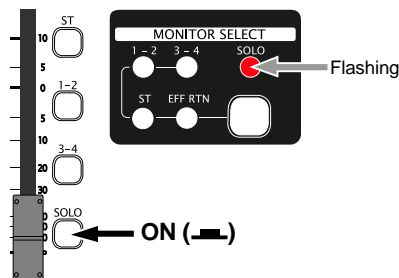



**<Memo>**: You can monitor an input signal via headphones or monitor speakers when the solo function is engaged. The monitor level can be controlled by using the [MONITOR] and [PHONES] controls (the latter only affects headphone monitoring).

**Adjusting the channel output levels sent to the stereo buss**

After adjusting the input level of each channel, you can tailor the channel signal and send it to the stereo buss via the pan pot and channel fader. (This determines the sound output from the main speaker in live performance.)

Before executing the following procedure, make sure that the "ST" indicator is lit and the [SOLO] indicator is unlit in the [MONITOR SELECT] section.

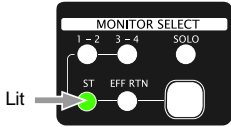

In this condition, you can monitor the stereo buss signal via headphones or monitor speakers. The monitor level can be controlled by using the [MONITOR] and [PHONES] controls (the latter only affects headphone monitoring).

- (1) Set the [ST] switch on each of mixer channels 1 through 16 to "ON" (—), and raise the [STEREO] fader to the "0" position.

In this condition, by raising the channel fader, each channel signal is sent to the stereo L/R buss.

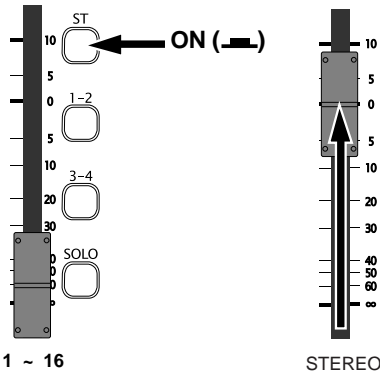

- (2) Raise each of the channel faders appropriately while rehearsing.

Each channel fader adjusts the channel output level sent to the stereo buss. The "LR" meters on the display shows the stereo L and R buss output levels, while the channel meters shows the channel input levels.



Input levels of channels 1 through 16  
Stereo L and R buss output levels

The total output levels of the stereo L and R buss (= the input levels for stereo mix recording) can be adjusted using the [STEREO] fader.

**<Memo>**: You can use the equalizer and the internal effects for each mixer channel signal. See "Mixer function" on page 33 for details about the equalizer and the internal effects.

Now you have completed all the adjustment and are ready for both PA and recording of the actual live performance.

**Recording**

**<Note>**: The maximum file size for each recording file is 4 GB. The LR16 automatically stops when the file size reaches 4 GB or when there is no recordable space left.

- (1) Press the [NEW PROJECT] key in the recorder section to turn on the key.

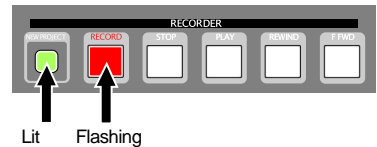

**<Memo>**: If you press the [NEW PRJ. REC] key in the mixer section, the recording starts in new project mode regardless of the on/off setting of the [NEW PROJECT] key.

- (2) Press the [PLAY] key while holding down the [RECORD] key (or press the [NEW PRJ. REC] key) to start recording.

**<Note>**: To record to an existing project already created, do not start recording using the [NEW PRJ.REC] key. This operation creates a new project and starts recording to it.

The LR16 automatically creates a new project (PROJ001) and starts recording to tracks 1 through 16 and the stereo mix track simultaneously.

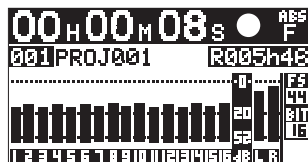

**(3) To stop recording, press the [STOP] key in the recorder or mixer section.**

If you press the [STOP] key in the recorder section, the recorder stops at the recording end position (REC END).

If you press the [STOP] key in the mixer section, the recorder skips back to the beginning of the project (ABS 0) and stops.

**<Note>**: When you stop recording, the display shows the following message while the LR16 is performing post recording. The more times you edit the project or the more tracks you record to, the longer it takes for post recording.

Post Recording  
Please Wait...

**<Memo>**: The recording file for each track is stored to the "PROJ001" folder as a mono WAV file, while the stereo mix file is stored to the "2mix" folder as a stereo WAV file.

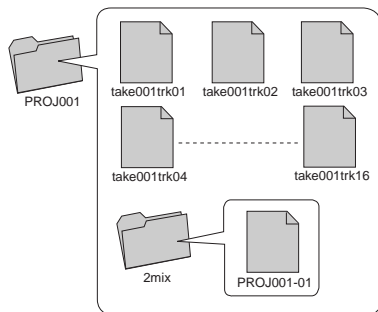

**Playing back a project**

After you have performed live recording to tracks 1 through 16, you can check the result in the following procedure.

**<Note>**: You can directly play back only tracks 1 through 16. To play back a stereo mix file, use the memory play function (see "Memory play function" on page 57 for details).

**<Memo>**: When more than one project is recorded, you can select a project to be played back using the "Select" menu item in the "Project" menu of the MENU mode (see page 65).

**(1) Turn off all the [REC TRACK SELECT] keys (1 through 16) and the [ST MIX] key.**

**(2) Set the [SOURCE] switch on each of mixer channels 1 through 16 to "TRK" (TRK).**

The corresponding recorder track output is selected as the channel source of each channel.

**(3) Locate to the beginning of the project.**

When you stop the recorder using the [STOP] key in the recorder section, press the [REWIND] key while holding down the [STOP] key to locate to the beginning of the project.

**(4) Press the [PLAY] key in the recorder or mixer section.**

The project starts from the beginning.

**<Memo>**: Use each channel fader to adjust the corresponding track playback level and use the [MONITOR] and [PHONES] controls to adjust the monitor level.

**<Note>**: If you do not want to output the sound from the main speakers, use the solo monitor function by turning on the [SOLO] switch on each channel.

**<Memo>**: When you play back a project while all [REC TRACK SELECT] keys are OFF, the LR16 automatically stops at the recording end position (REC END). If at least any one of the [REC TRACK SELECT] keys is ON, the LR16 does not automatically stop at the recording end position and continues running until it reaches at 24h00m00s.

**(5) To stop playback, press the [STOP] key in the recorder or mixer section.**

**<Memo>**: You can transfer a project (or a stereo mix file) to a personal computer by directly connecting the computer to the LR16 or via a USB memory stick. (See page 74 for details about how to transfer to a computer. See page 68 for details about how to copy to a USB memory stick.) You can mix down the project recorded on tracks 1 through 16, as well as can replace a part with the new one using the punch in/out function (see the next pages).

## Multitrack recording

The LR16 provides multitrack recording functions including overdubbing, mixdown and punch in/out.

### Overdubbing

The overdubbing function allows you to record to the desired track(s) while monitoring the playback signal(s) of the other recorded track(s). The overdubbing can be performed in insert mode. The following shows the procedure example of recording a guitar to track 3 while monitoring the keyboard recorded on tracks 1 and 2. It is assumed that the recorder is stopped at the beginning of the project (PRO001).

**<Note>**: If the FS of the project to be overdubbed does not match the "Default FS" setting in the "System" menu of the MENU mode, you cannot perform overdubbing (the "FS/Bit" indication flashes on the display for warning). In such a case, change the "Default FS" setting to match the project.



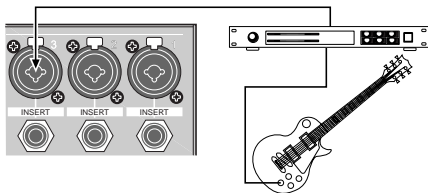

### Connecting a sound source

- (1) Connect a guitar to the [INPUT 3] connector.



### Preparation

- (1) Set the [SOURCE] switch on channels 1 and 2 to "TRK" (  ), and set the [SOURCE] switch on channel 3 to "INPUT" (  ).  
The playback signals of tracks 1 and 2 are routed to mixer channels 1 and 2 respectively, while the guitar signal is routed to mixer channel 3.
- (2) Press the [REC TRACK SELECT 3] key to flash the key.  
On the display, track number 3 also starts flashing, while the recordable remaining time is shown.

- (3) Press the [NEW PROJECT] key in the recorder section to turn off the key.
- (4) Press the [RECORD] key in the recorder section to flash the key.
- (5) Set the [SOLO] switches for channels 1 through 3 to ON (  ).

### Adjusting the input level while playing back tracks 1 and 2

- (1) Press the [PLAY] key in the recorder or mixer section.  
The LR16 starts playback from the beginning of the project. You can hear the playback signals of tracks 1 and 2 by raising the [PHONES] and [MONITOR] controls.
- (2) While playing the guitar, adjust the input level appropriately using the [TRIM] control on channel 3.  
The display shows the playback levels of tracks 1 and 2 as well as the input level of track 3



- (3) **After adjusting the input level of channel 3, stop the recorder by pressing the [STOP] key in the recorder or mixer section.**

If you press the [STOP] key in the recorder section, the recorder stops at the current position. If you press the [STOP] key in the mixer section, the recorder skips back to the beginning of the project (ABS 0) and stops.

### Performing overdub

- (1) **Press the [PLAY] key while holding down the [RECORD] key to start recording (overdubbing) and play the guitar.**

You can play the guitar while monitoring the playback signals of tracks 1 and 2.

**<Note>:** Do not press the [NEW PRJ. REC] key in the mixer section.

- (2) **When recording finishes, press the [STOP] key in the recorder or mixer section to stop the recorder.**

You can check the result of the overdubbed project (see "Playing back a project" on page 50 for details about how to play back a project).

**<Memo>:** When you stop recording, the display shows the following message while the LR16 is performing post recording. The more times you edit the project or the more tracks you record to, the longer it takes for post recording.

Post Recording  
Please Wait...

**<Memo>:** The data before performing overdubbing is stored to the "LOG" folder in the project as an ADL file. If you are not satisfied with the result, you can roll back the previous project data before overdubbing (see page 67 for details).

### Mixdown

Regardless of whether a project has been recorded track by track using overdubbing technique or recorded all tracks simultaneously, you can play back tracks 1 through 16 of the project and tailor them using the equalizers and internal effects, then send them to the stereo buss via the pan and fader on each mixer channel. In the following procedure, it is assumed that the recorder is stopped at the beginning of the recorded project.

**<Hint>:** To mix down the recorded project, set the channel source of each mixer channel to the recorder track and play back the recorder. Then tailor each mixer input signal (= each track signal) using the channel equalizer and internal effects, and send it to the stereo buss via the pan and fader. In result, all recorder track signals are mixed to the stereo buss.

**<Note>:** The mixed stereo signal can be recorded internally using the insert mode.

**<Note>:** If the FS of the project to be mixed down does not match the "Default FS" setting in the "System" menu of the MENU mode, you cannot record the stereo mix signal (the "FS/Bit" indication flashes on the display for warning). In such a case, change the "Default FS" setting to match the project.

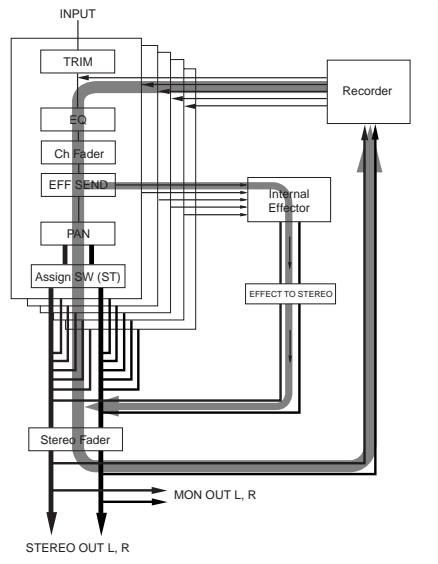

### Preparation

- (1) Set the [SOURCE] switch on each of mixer channels 1 through 16 to "TRK" (  ). The corresponding recorder track output is selected as the channel source of each channel.
- (2) Turn off the [NEW PROJECT] key in the recorder section.
- (3) Change the destination channels of Sub In from "15/16" (default) to "-/-" (no channels are assigned).  
See page 79 for details about how to assign the destination channels of Sub In.

### Adjusting level and sound of each track

- (1) Set the [ST] switch on each of mixer channels 1 through 16 to ON (  ). Each input signal is routed to the stereo L/R buss via the input fader.
- (2) Raise the [STEREO] fader to the "0" position.
- (3) Press the [PLAY] key in the recorder or mixer section to start playback of the project.
- (4) Use the channel fader on each mixer channel to adjust the track level.  
The display shows the levels of tracks 1 through 16 as well as the stereo L/R buss.

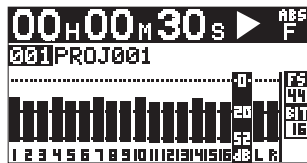

You can also control each track sound using the equalizer on each channel and the internal effects processor, as well as set pan. For details about the mixer function, see "Mixer function" on page 33.

- (5) Use the [STEREO] fader to adjust the total level of the stereo L/R buss.  
You can monitor the stereo L/R buss by raising the [PHONES] and [MONITOR] controls.
- (6) After finishing adjustment, press the [STOP] key in the recorder or mixer section to stop the recorder.  
If you press the [STOP] key in the recorder section, the recorder stops at the recording end position (REC END).  
If you press the [STOP] key in the mixer section, the recorder skips back to the beginning of the project (ABS 0) and stops.

### Starting mixdown recording

- (1) Press the [ST MIX] key in the recorder section to turn it on.  
"LR" starts flashing on the display and the recordable remaining time is shown.

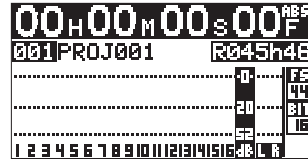

- (2) Press the [PLAY] key while holding down the [RECORD] key to start mixdown recording.

**<Note>**: Do not press the [NEW PRJ. REC] key in the mixer section.

- (3) After finishing mixdown recording, press the [STOP] key in the recorder or mixer section to stop the recorder.  
If you press the [STOP] key in the recorder section, the recorder stops at the recording end position (REC END).  
If you press the [STOP] key in the mixer section, the recorder skips back to the beginning of the project (ABS 0) and stops.

**<Memo>**: The mixed down file (stereo WAV file) is stored to the "2mix" folder in the current project.

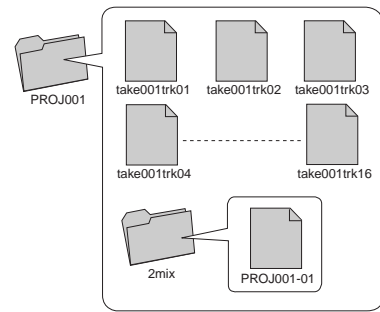

You can copy the mixed down file to a personal computer by directly connecting the computer to the LR16 or via a USB memory stick. (See page 73 for details about how to transfer to a computer. See page 67 for details about how to copy to a USB memory stick.)

**<Note>**: You cannot play back a mixed down file directly, however, you can play it back using the memory play function (see page 57).

## Punch in/out

The punch in/out function allows replacing the desired part of the desired track already recorded, instead of re-recording the entire track. While a project is playing, the recorder switches from playback to recording at the "punch in" point, and switches from recording to playback at the "punch out" point. You can punch in and out using the transport control keys on the recorder section or using a footswitch.

### <Notes>

- \* *Punch in/out can be performed in insert mode. You cannot perform punch in/out in new project mode.*
- \* *Repeating punch in/out decreases the recordable remaining space of the hard disk. It is recommended to delete an unnecessary project using the "Delete" item in the "Project" menu of the MENU mode (see page 72).*
- \* *After performing punch out, it takes a few seconds until the LR16 outputs the playback signal (non-seamless punch in/out).*

**<Memo>**: The data before performing punch in/out is stored to the "LOG" folder in the project as an ADL file. If you are not satisfied with the result, you can roll back the previous project data before punch in/out (see page 67 for details).

**<Note>**: If you perform the above operation while playing your instrument, you may not be able to concentrate on playing. In such a case, ask someone to operate the recorder or use a footswitch described in the next page.

The following procedure example describes how to perform punch in/out to track 3 of the project whose tracks 1 through 8 have been recorded. It is assumed that you have completed source connection, level adjustment, mixer settings, etc.

- (1) Turn off the [NEW PROJECT] key in the recorder section.

**<Note>**: If the [NEW PROJECT] key is lit, you cannot perform punch in/out.

- (2) Turn on the [REC TRACK SELECT] key for track 3.

Track 3 is record-armed.

- (3) Set the [SOURCE] switches on mixer channels 1 through 8 to "TRK" (  ).

The playback signals of tracks 1 through 8 are routed to the mixer input channels.

- (4) Set the [ST] switches on mixer channels 1 through 8 to "ON" (  ).

**<Note>**: Make sure that all the [SOLO] switches on the mixer channel to "OFF" and the [MONITOR SELECT] switch is set to "ST".

- (5) Raise the [STEREO] fader to the "0" position.

- (6) Locate the recorder to the point earlier than the punch-in point and press the [PLAY] key to start playback.

**<Memo>**: Use channel faders 1 through 8 to adjust the playback signal levels on tracks 1 through 8 individually, and use the [MONITOR] and [PHONES] controls to adjust the total monitor level.

### Punch in/out using the transport control keys

You can manually punch in and out using the [RECORD] and [PLAY] keys on the recorder section.

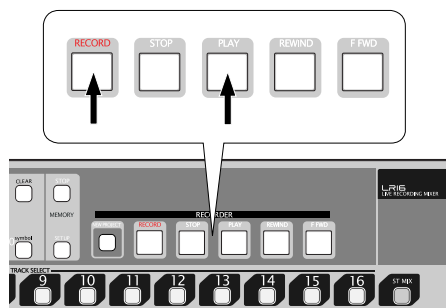

Press the [PLAY] key while holding down the [RECORD] key (punch in).

Press only the [PLAY] key (punch out).

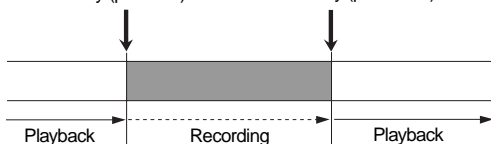

- (7) **At the punch in point, press the [RECORD] key while holding down the [PLAY] key.**  
Track 3 is punched in (switches from playback to recording).

**<Note>:** To perform punch in, do not forget to hold down the [PLAY] key when pressing the [RECORD] key.

- (8) **At the punch out point, press only the [PLAY] key.**  
Track 3 is punched out (switches from recording to playback).

**<Note>:** You cannot perform punch in/out successively without stopping the recorder. To perform more than one punch in/out operation, stop the recorder each time you finish punch in/out.

- (9) **Press the [STOP] key to stop the recorder, and locate the recorder back to the punch in position.**

**<Memo>:** By pressing the [STOP] key on the mixer section, the recorder automatically skips to the beginning of the project (ABS 0) and stops.

- (10) **Press the [PLAY] key to play back the project to check the result.**  
If you are not satisfied with the result, roll back the previous project data before punch in/out (see page 76 for details).

### Punch in/out using a footswitch

You can perform punch in/out using a footswitch connected to the [FOOT SW] jack on the rear panel of the main unit.

The following procedure example describes how to perform punch in/out to track 3 of the project whose tracks 1 through 8 have been recorded. It is assumed that you have completed source connection, level adjustment, mixer settings, etc.

**<Note>:** To use a footswitch for punch in/out, the "Foot SW" item in the "System" menu of the MENU mode must be set to "P I/O". Though it is set to "P I/O" by default, if it is set to an option other than "P I/O", change it to "P I/O" (see page 77 for details).

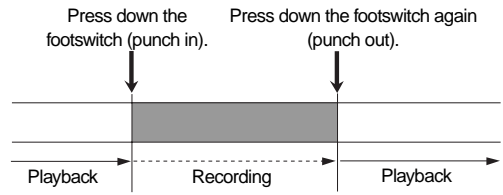
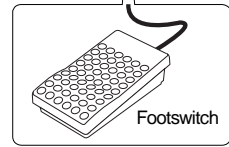
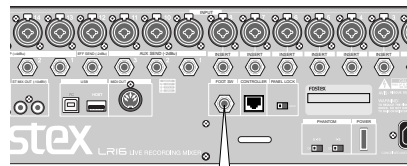

- (1) **Connect an unlatched footswitch to the [FOOT SW] jack.**

**<Note>:** Do not use a footswitch which is not the unlatched type. Connecting an improper footswitch may cause malfunction.

- (2) **Turn off the [NEW PROJECT] key in the recorder section.**
- (3) **Turn on the [REC TRACK SELECT] key for track 3.**
- (4) **Set the [SOURCE] switches on mixer channels 1 through 8 to "TRK" (—).**  
The playback signals of tracks 1 through 8 are routed to the mixer input channels.

- (5) **Set the [ST] switches on mixer channels 1 through 8 to "ON" (—).**

**<Note>**: Make sure that all the [SOLO] switches on the mixer channel to "OFF" and the [MONITOR SELECT] switch is set to "ST".

- (6) **Raise the [STEREO] fader to the "0" position.**

- (7) **Locate the recorder to the point earlier than the punch-in point and press the [PLAY] key to start playback.**

**<Hint>**: To perform punch in smoothly, it is recommended to play your instrument along with the playback sound.

**<Memo>**: Use channel faders 1 through 8 to adjust the playback signal levels on tracks 1 through 8 individually, and use the [MONITOR] and [PHONES] controls to adjust the total monitor level.

**<Note>**: You cannot perform punch in/out successively without stopping the recorder. To perform more than one punch in/out operation, stop the recorder each time you finish punch in/out.

- (10) **Press the [STOP] key to stop the recorder, and locate the recorder back to the punch in position.**

**<Memo>**: By pressing the [STOP] key on the mixer section, the recorder automatically skips to the beginning of the project (ABS 0) and stops.

- (11) **Press the [PLAY] key to play back the project to check the result.**

If you are not satisfied with the result, roll back the previous project data before punch in/out (see page 67 for details).



# Memory play

The LR16 provides the memory play function. This function allows you to perform instant start playback of a stereo mix file which is assigned to any of the numeric keys (0 through 9). The assigned file can be a file recorded by the LR16 or a file copied from a computer, etc. Before performing the memory play function, use the Memory play setup screen to assign a stereo mix file to a numeric key, assign the destination channels of playback audio and set the play mode.

Only the following stereo mix files can be used for memory play.

- stereo mix files in the "2mix" folder of each project
- stereo mix files copied to the "MPLAY441" or "MPLAY480" folder from a computer, etc.

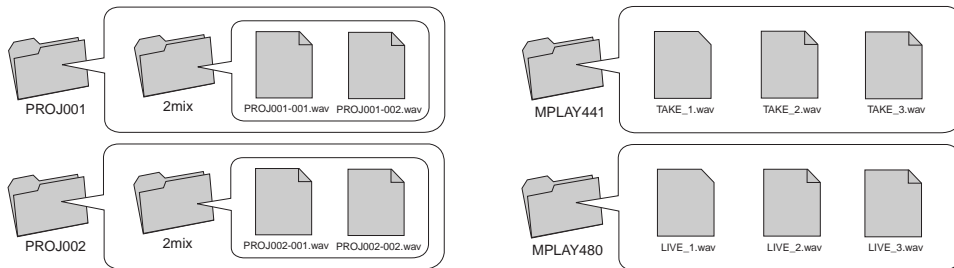

**<Note>**: The setting in the memory play setup screen is stored to the "MPLAY441" or "MPLAY480" folder. The former stores the setting for FS 44.1 kHz files, while the latter stores the setting for FS 48 kHz files. Depending on the current "Default FS" setting, the corresponding setting is used. For example, if the "Default FS" is set to 44.1 kHz, memory play is performed according to the setting stored in the "MPLAY441" folder.

**<Note>**: Only stereo mix files whose FS matches the setting of the "Default FS" menu item in the "System" menu of the MENU mode can be assigned to the numeric keys. You cannot assign a file whose FS does not match the "Default FS" setting.

**Setting on the memory play setup screen**

- 1) While the recorder is stopped, press the [MEMORY SETUP] key in the recorder section of the main unit.

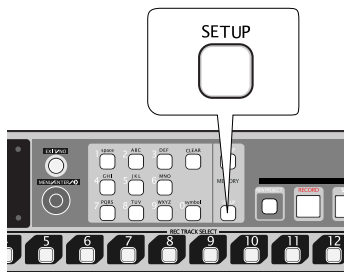

The display shows the memory play setup screen. On this screen, you can assign stereo mix files to the numeric keys, assign the channel pair to which the memory play signal is output, and set the play mode. (You can make these settings in any order.)

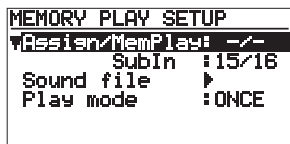

**<Memo>**: On the memory play setup screen, you can also select the channel pair to which the Sub in signal (from the [SUB IN] inputs) is assigned.

**• Assigning stereo mix files**

- 2) Use the [MENU] dial to highlight "Sound file" and press the [ENTER] key.

The display now shows the file assignment to the numeric keys.

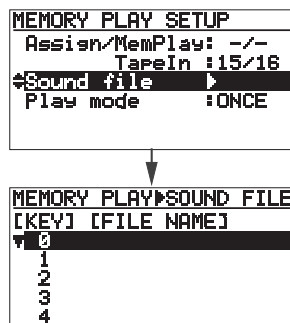

You can scroll the screen using the [MENU] dial for selecting a desired numeric key (0 through 9).

- 3) Use the [MENU] dial to select a desired numeric key number (0 through 9) and press the [ENTER] key.

The display now shows the folder list.

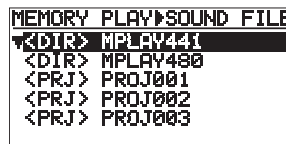

- 4) Use the [MENU] dial to select a desired folder and press the [ENTER] key.

The display now shows the stereo mix files in the selected folder.

**<Memo>**: If no stereo mix file exists in the selected folder, nothing is shown.



- 5) Use the [MENU] dial to select a desired stereo mix file and press the [ENTER] key.

The stereo mix file is assigned to the numeric key selected in step 3) above, and the display returns to show the file assignment to the numeric keys.

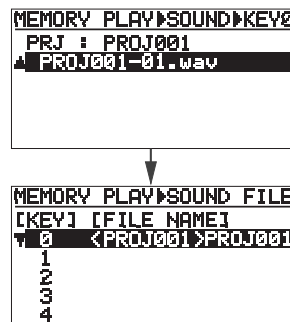

Repeat steps 3) to 5) to assign desired stereo mix files to other numeric keys.

**<Memo>**: To deassign a stereo mix file, select a desired numeric key when the display shows the file assignment to the numeric keys (see step 2) above) and press the [CLEAR] key.

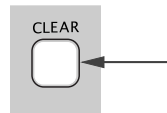

6) **After you complete assignment, press the [EXIT/NO] key.**

The display returns to the memory play setup screen, where "Sound file" is highlighted.



**• Selecting a channel pair for memory play**

Using the "Assign/MemPlay" menu item, you can select a mixer channel pair to which the memory play signal is assigned. By default, No channels are selected ("-/-" is shown).

In the following description, it is assumed that the memory play setup screen is shown.

**<Note>:** To enable the memory play function, you have to select a channel pair (other than "-/-").

7) **Use the [MENU] dial to highlight "Assign/MemPlay" and press the [ENTER] key.**

You can select an odd/even channel pair from 1/2 to 17/18, or -/-.

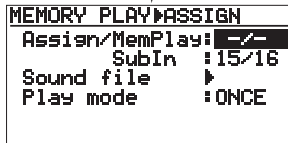
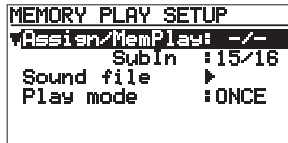

**<Note>:** You cannot assign the memory play and the Sub in signals to the same channel pair. If you attempt to assign the memory play signal to the same channel pair as the Sub in signal, the following message is shown for a few seconds.

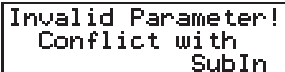

If you want to assign the memory play signal to the channel pair to which the Sub in signal is currently assigned, change the assignment of the Sub in signal in the following steps before selecting the channel pair for the memory play signal.

1. Use the [MENU] dial to highlight "SubIn" and press the [ENTER] key.
2. Use the [MENU] dial to select a desired channel pair and press the [ENTER] key.

**<Note>:** If you attempt to assign the memory play signal to a channel whose corresponding track is currently recorded, the following message is shown for a few seconds.

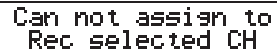

8) **Use the [MENU] dial to select a desired channel pair and press the [ENTER] key.**

The memory play signal is now assigned to the selected channel pairs.

If necessary, select the memory play mode as described below.

**• Selecting the memory play mode**

You can select the memory play mode between "ONCE" and "REPEAT". By default, it is set to "ONCE". When you perform memory play in this mode, the LR16 plays back a stereo mix file once and stops.

The following describes how to select the memory play mode. It is assumed that the memory play setup screen is shown.

9) **Use the [MENU] dial to highlight "Play mode" and press the [ENTER] key.**

The current setting flashes. You can select between "ONCE" and "REPEAT".

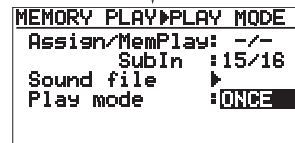
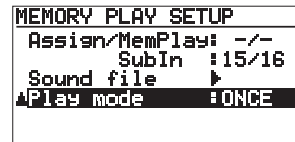

<b>ONCE</b>	The LR16 plays back a stereo mix file once and stops.
<b>REPEAT</b>	The LR16 plays back a stereo mix file repeatedly until the [MEMORY STOP] key is pressed.

10) Use the [MENU] dial to select a desired memory play mode and press the [ENTER] key.

11) After finishing all necessary settings, press the [STOP] key.  
 The LR16 dismisses the memory play setup screen while lights up the numeric keys to which stereo mix files are assigned. You can see the memory play function is enabled when any numeric key(s) are illuminated.

### Performing memory play

While any one or more numeric keys are illuminated, you can perform memory play.

1) Set the [SOURCE] switches of the mixer channel pair (to which the memory play signal is assigned using the memory play setup screen) to "Trk".

2) Press an illuminated numeric key.  
 The stereo mix file assigned to the key immediately starts playback, while the numeric key starts flashing.

You can send the memory play signal to the stereo L and R busses via the input faders. You can also solo-monitor the memory play signal using the [SOLO] switches on the mixer channels.

**<Note>**: During memory play, the playback levels are shown on the display, however, the Home screen shows the information of the project loaded before you perform memory play. So the time counter does not change.

**<Memo>**: You can also perform memory play using a footswitch, as well as the numeric keys. To perform memory play using a footswitch, set the footswitch function appropriately using the "Foot SW" menu item in the "System" menu of the MENU mode (see page 77 for details).

3) To stop memory play in the middle, press the [MEMORY STOP] key.

**<Note>**: To stop memory play in the middle, press the [MEMORY STOP] key. You cannot stop memory play by using the [STOP] key in the recorder or mixer section.

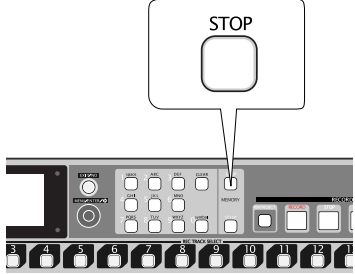

**<Memo>**: To cancel the memory play function, set the "Assign/MemPlay" item on the memory play setup screen to "-/-". The memory play function is disabled and the numeric keys are unlit.

# Mark function

The recorder of the LR16 features the mark function. You can add a mark to a desired position in a song and can quickly locate to the mark position. You can edit the position or label of a mark, as well as delete a mark.

## Adding a mark

You can add a mark by either of the following two methods. Up to 99 marks can be added.

- 1) Adding a mark on-the-fly during audio recording
- 2) Adding a mark via the mark list screen

### • Adding a mark on-the-fly

During audio recording, pressing the [ENTER] key at the desired position adds a mark there. This method can be used during audio recording in New Project mode and Insert mode. When you press the [ENTER] key, a popup screen as below is briefly shown. Each time a mark is added, the mark number counts up.

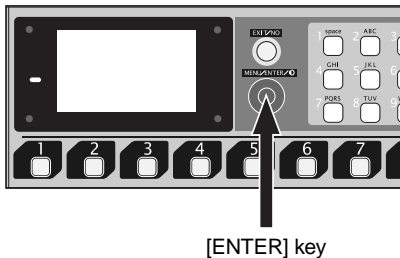

By pressing the [ENTER] key repeatedly during recording, marks are added to the project as below.

```
MARK 01 stored
00h03m45s12f
[MARK01]
```

By pressing the [ENTER] key repeatedly during recording, marks are added to the project as below.



### • Adding a mark via the mark list screen

You can add a mark while playing back a project. Using this method, you can add a mark after recording.

(1) While the recorder is stopped, press the [ENTER] key to bring up the MENU screen. When you bring up the MENU screen for the first time, "Mark point" is highlighted.

(2) While "Mark point" is highlighted, press the [ENTER] key.

The display now shows the mark list screen. If no mark is set, all mark slots show "--h-m-s-f".

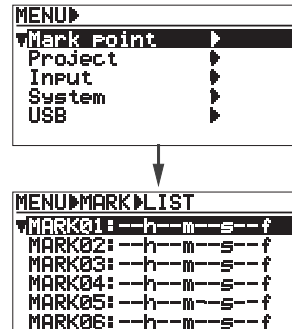

<Memo>: Pressing the [ENTER] key after starting playback also brings up the mark list screen.

(3) Press the [PLAY] key to start playback of the project, and press the [ENTER] key at the position you want to add a mark.

The position is set to MARK01 and you are now ready to set MARK02.

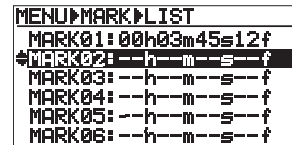

By pressing the [ENTER] key repeatedly, you can add marks repeatedly to the project.

(4) After adding marks, press the [STOP] key to exit the MENU mode.

## Locating to a mark point

You can locate to a mark point while stopped or during playback.

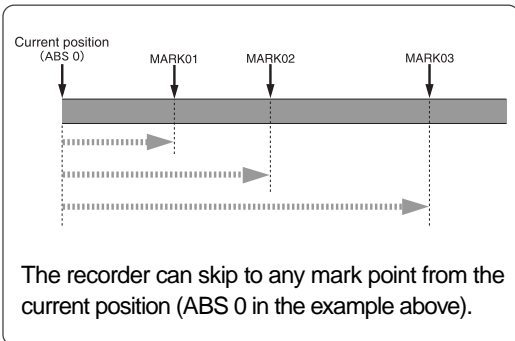

- (1) **Press the [ENTER] key to bring up the MENU screen.**  
When you bring up the MENU screen for the first time, "Mark point" is highlighted.
- (2) **While "Mark point" is highlighted, press the [ENTER] key.**  
The display now shows the mark list screen.

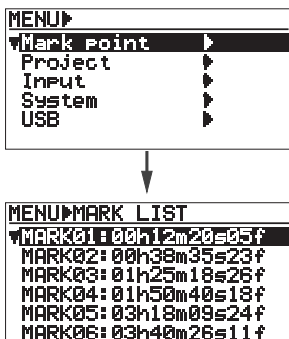

- (3) **Use the [MENU] dial to highlight a desired mark point and press the [ENTER] key.**  
The display now shows the edit screen for the selected mark.

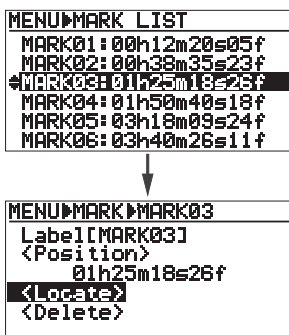

- (4) **Use the [MENU] dial to highlight "<Locate>" and press the [ENTER] key.**  
The recorder skips to the point of mark 03 ("01h25m18s26f" in the example below) and the display returns to the Home screen.

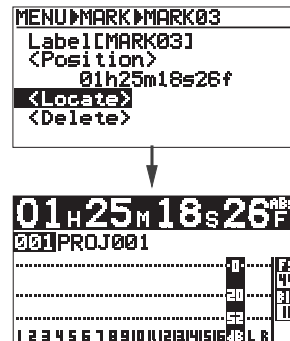

If you execute the above operation during playback, the recorder automatically starts playback from the mark point.

## Editing a mark

You can edit a mark label or mark position, as well as can delete a mark.

### • Editing a mark label

When a mark is set, a mark label ("MARK" + number (01~99)) is automatically given. You can edit this mark label later.

- (1) **Press the [ENTER] key to bring up the MENU screen.**  
When you bring up the MENU screen for the first time, "Mark point" is highlighted.
- (2) **While "Mark point" is highlighted, press the [ENTER] key.**  
The display now shows the mark list screen.

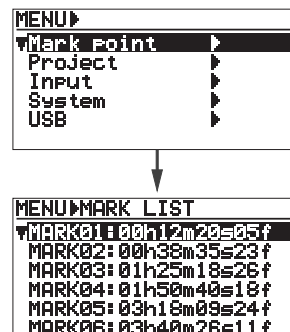

- (3) Use the [MENU] dial to highlight a desired mark point and press the [ENTER] key. The display now shows the edit screen for the selected mark.

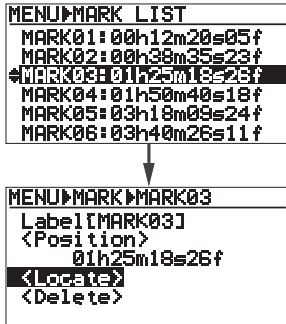

- (4) Use the [MENU] dial to highlight "Label" and press the [ENTER] key. The rightmost character of the label starts flashing.

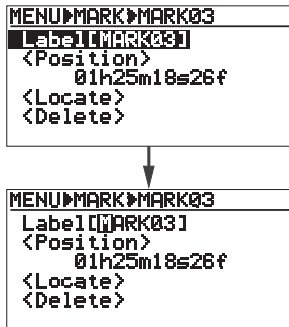

- (5) Use the numeric keys and [MENU] dial to enter the desired label. Use the [MENU] dial to move the cursor (flashing point) and use the numeric keys to enter the desired character. Pressing the [CLEAR] key deletes the character at the cursor position. Up to six characters can be entered. See <Example of label editing> in the right column of this page.

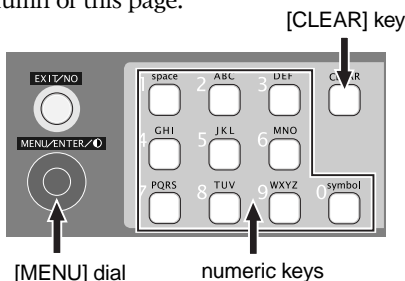

- (6) After entering the label, press the [ENTER] key to confirm the setting.  
 (7) Press the [STOP] key to exit the MENU mode.

<Example of label editing>

The following procedure example shows how to change "MARK03" which is the current label to "Take3".

- 1) Press the [CLEAR] key repeatedly until the whole current name ("MARK03") is deleted.
- 2) Use the [8] key to enter "T".
- 3) Use the [2] key to enter "a".
- 4) Use the [5] key to enter "k".
- 5) Use the [3] key to enter "e".
- 6) Use the [MENU] dial to move the cursor to the right.
- 7) Use the [3] key to enter "3".

• Editing a mark position

You can edit the position of a mark later.

- (1) Press the [ENTER] key to bring up the MENU screen. When you bring up the MENU screen for the first time, "Mark point" is highlighted.
- (2) While "Mark point" is highlighted, press the [ENTER] key. The display now shows the mark list screen.

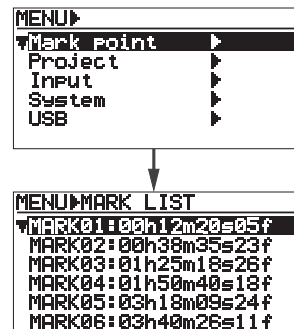

- (3) Use the [MENU] dial to highlight a desired mark point to be edited and press the [ENTER] key. The display now shows the edit screen for the selected mark.

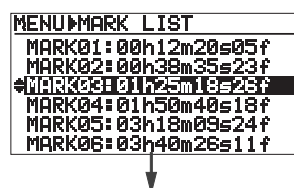



- (4) Use the [MENU] dial to highlight "<Position>" and press the [ENTER] key. The flame digit of the time data for the selected mark starts flashing.

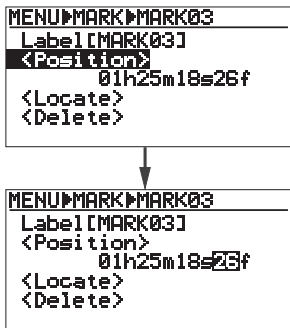

- (5) **Edit the time data in the following manner.**  
 Use the [REWIND] or [F FWD] key to move the cursor (flashing point) to the desired digit to be edited.  
 Use the [MENU] dial or numeric keys to enter the desired value at the flashing point.  
 Pressing the [CLEAR] key resets the time data to "00h00m00s00f".  
 You can set any of the following values to each digit.

- Hour digit: 00 through 23
- Minute digit: 00 through 59
- Second digit: 00 through 59
- Flame digit: 00 through 24 (or 00 through 29)

- (6) Press the [ENTER] key to confirm the duration setting.
- (7) Press the [STOP] key to exit the MENU mode.

### Deleting a mark

- (1) **Press the [ENTER] key to bring up the MENU screen.**  
 When you bring up the MENU screen for the first time, "Mark point" is highlighted.
- (2) **While "Mark point" is highlighted, press the [ENTER] key.**  
 The display now shows the mark list screen.

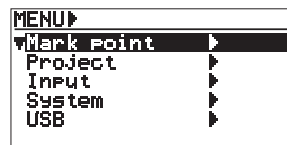

- (3) Use the [MENU] dial to highlight a desired mark point to be deleted and press the [ENTER] key. The display now shows the edit screen for the selected mark.



- (4) Use the [MENU] dial to highlight "<Delete>" and press the [ENTER] key. The display returns to the mark list screen on which the time data for the deleted mark shows "--h--m--s--f". You can set this mark again by the procedure described in "Adding a mark via the mark list screen" on page \*\*.



- (5) Press the [STOP] key to exit the MENU mode.



# Project management

## Selecting a project

You can select the desired project by the following procedure.

**<Note>**: If you select a project which does not match the setting of the "Default FS" menu item in the "System" menu of the MENU mode, the "FS/Bit" information flashes on the Home screen for warning (the information shows the current setting of the "Default FS" menu item).

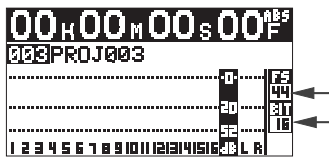

In such a condition, you cannot perform playback or recording. To perform playback or recording, reselect the "Default FS" menu item to the same FS/Bit as the project (see page 83 for details about how to set it).



By selecting "<New project>" shown at the bottom of the list, you can create a new project on the hard disk (see "Creating a new project" below).

- (4) Use the [MENU] dial to highlight a desired project and press the [ENTER] key.

The display now shows the Home screen for the selected project.

## Creating a new project

You can create a new project on the hard disk by selecting "<New project>" shown at the bottom of the list.

**<Note>**: You can make recording to the project created by the following procedure only in the insert mode (i.e., the [NEW PROJECT] key is off).

- (1) Press the [ENTER] key to bring up the MENU screen.  
When you bring up the MENU screen for the first time, "Mark point" is highlighted.
- (2) Use the [MENU] dial to highlight "Project" and press the [ENTER] key.  
The display now shows the project menu.

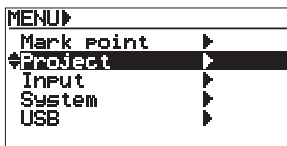

- (3) While "Select" is highlighted, press the [ENTER] key.  
The display now shows the project list.

- (1) Press the [ENTER] key to bring up the MENU screen.  
When you bring up the MENU screen for the first time, "Mark point" is highlighted.
- (2) Use the [MENU] dial to highlight "Project" and press the [ENTER] key.  
The display now shows the project menu.

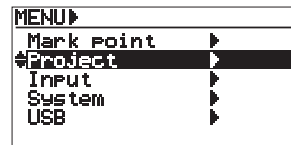

- (3) While "Select" is highlighted, press the [ENTER] key.  
The display now shows the project list.



- (4) Use the [MENU] dial to select "**<New project>**" and press the [ENTER] key. The display now shows the Home screen for the new project (see the next page).

If "<New project>" is hidden on the screen, scroll down the list.

The following shows the Home screen of project "005" created on the hard disk.

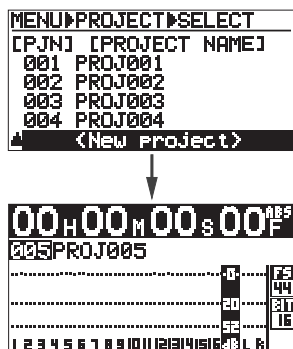

**<Memo>**: If you bring up the project list screen when no project is created, it only shows "<New project>" as below.



While the above screen is shown, pressing the [ENTER] key creates a new project (you can make recording to the project in the insert mode).

## Editing a project name

You can edit the name of the current project.

**<Note>**: Project name editing is not reflected to the name of a stereo mix file.

**<Note>**: The maximum name length is 16 characters.

- Press the [ENTER] key to bring up the MENU screen. When you bring up the MENU screen for the first time, "Mark point" is highlighted.
- Use the [MENU] dial to highlight "Project" and press the [ENTER] key. The display now shows the project menu.

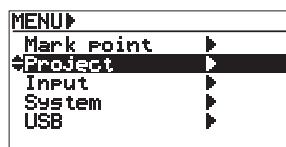

- Use the [MENU] dial to highlight "Rename" press the [ENTER] key. The display now shows the screen for editing a project name.



- Use the [MENU] dial, numeric keys and [CLEAR] key to edit the name. See <Name editing example> on the next page for details of how to edit a name.

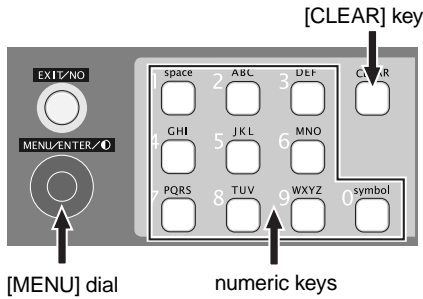

**<Name editing example>**

The following shows the procedure of completely deleting "PROJ001", the current project name, and entering "Live3" as the new name.

- (1) Rotate the [MENU] dial counterclockwise to move the cursor to the leftmost position.
- (2) Press the [CLEAR] key repeatedly until all characters of the current name are deleted.
- (3) Use the "5" key to enter an uppercase "L".
- (4) Use the "4" key to enter a lowercase "i".
- (5) Use the "8" key to enter a lowercase "v".
- (6) Use the "3" key to enter a lowercase "e".
- (7) Use the [MENU] dial to move the cursor to the right.
- (8) Use the "3" key to enter a "3".



- (5) After editing the name, press the [ENTER] key. The display now shows the Home screen of the renamed project.



**Rolling back a project**

Instead of the undo/redo function, you can retrieve the pre-edited condition of an edited project.

**<Memo>**: Each time you perform recording or editing (including punch-in/out, additional recording, etc.), the LR16 stores the previous project data as an ADL file to the LOG folder on the hard disk, as shown below. By selecting a desired ADL file, you can roll back the project to the previous condition, which is similar to the undo function.



Each ADL file is stored with a different file name as below.

- TAKE01:** ADL file for a newly created (blank) project.
- TAKE02:** ADL file for a project which has been recorded for the first time.
- TAKE03:** ADL file for a project which has been edited for the first time.
- TAKE04:** ADL file for a project which has been edited for the second time.

The following shows the procedure of replacing the current project (TAKE04) with the pre-edited project (TAKE02).

- (1) Press the [ENTER] key to bring up the MENU screen. When you bring up the MENU screen for the first time, "Mark point" is highlighted.
- (2) Use the [MENU] dial to highlight "Project" and press the [ENTER] key. The display now shows the project menu.

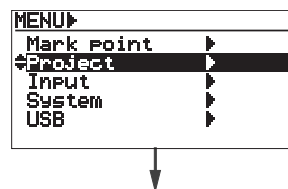

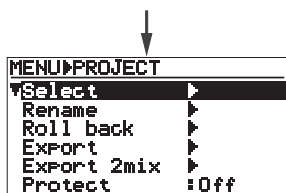

- (3) Use the [MENU] dial to highlight "Roll back" and press the [ENTER] key.

The display now shows the list of ADL files stored in the LOG folder.

The screen example below shows TAKE001 (blank), TAKE002 (after the first recording), TAKE003 (after the first editing).



- (4) Use the [MENU] dial to highlight "TAKE002" and press the [ENTER] key.

The project is rolled back and the display shows the Home screen of the pre-edited project.

**<Memo>** If you bring up the screen showing the list of ADL files after rolling back the project, it looks as below. You can see TAKE002 replaces TAKE004.

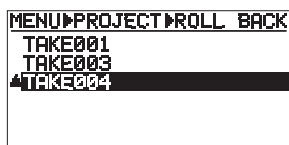

**<Note>** Each time you make editing, a new ADL file is created and the disk space is consumed. Therefore, it is recommended to delete unnecessary projects or format the internal hard disk.

### Saving a project to an external medium

You can save the current project to an external USB memory stick.

**<Note>** Connect a FAT16- or FAT32-formatted USB memory stick to the [USB HOST] port of the main unit before executing the following procedure.

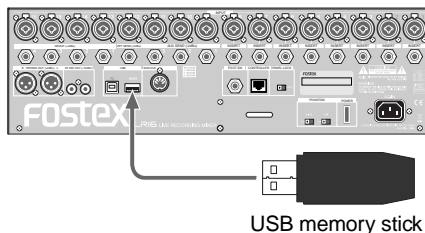

**<Note>** If no USB memory stick is connected or a USB memory stick is not FAT16- or FAT32-formatted, the appropriate popup as below is shown and the LR16 cannot enter the Export mode.

No USB device!

<When no USB memory stick is set>

USB Unformat!

<When a USB memory stick is not FAT16- or FAT32-formatted>

- Press the [ENTER] key to bring up the MENU screen.  
When you bring up the MENU screen for the first time, "Mark point" is highlighted.
- Use the [MENU] dial to highlight "Project" and press the [ENTER] key.  
The display now shows the project menu.

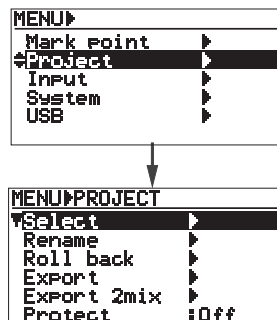

- (3) Use the [MENU] dial to highlight "Export" press the [ENTER] key.  
After the LR16 checks the USB memory, the display shows the export screen.

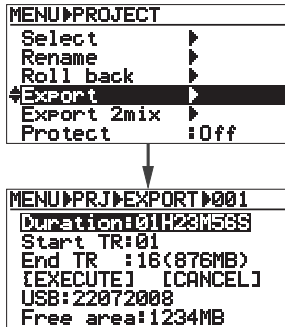

For details about the information shown on this screen, see "Export screen details" described below.

If you simply execute step (4) on the next page without changing any parameter, data of full length (from ABS 0 to REC END) of all tracks (1 through 16) is exported to the USB memory stick.

Before you execute step (4), however, you can shorten the length of the project or select tracks to be exported (see the right column on this page for details).

**<Export screen details>**



①	Duration of the project to be exported. By default, the full length (from ABS 0 to REC END) is shown. You can edit and shorten it.
②	The start track to be exported (by default, 01). You can change it.
③	The end track to be exported (by default, 16). You can change it. The value in parentheses shows the required space for storing.
④	The volume label of the USB memory stick.
⑤	The free area of the USB memory stick. <b>&lt;Note&gt;:</b> If you attempt to export the project data which exceeds the free area of the USB memory stick, "Over size!" is shown and you cannot execute exporting data.

**<Editing the duration>**

- 1) While "Duration" is highlighted, press the [ENTER] key.  
The second digit starts flashing.

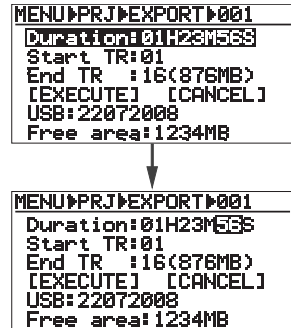

- 2) Use the [MENU] dial or numeric keys to enter the desired value at the flashing point, and press the [ENTER] key.  
You can use the [REWIND] or [F FWD] key to move the cursor (flashing point).

**<Note>:** Pressing the [CLEAR] key resets the duration to "00H 00M 00S". If you shorten the duration, the value in parentheses shown at the right of the "End TR" number gets smaller.

**<Selecting tracks>**

- 1) Use the [MENU] dial to highlight "Start TR" (or "End TR") and press the [ENTER] key.  
The track number of the starting track (or ending track) starts flashing.

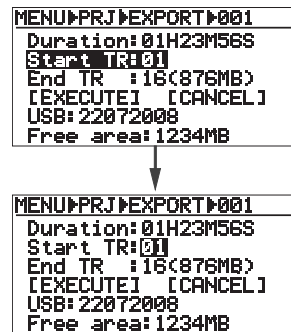

- 2) Use the [MENU] dial to enter the desired track number and press the [ENTER] key to confirm the setting.

**<Note>:** If you limit the tracks, the value in parentheses shown at the right of the "End TR" number gets smaller.

- (4) Use the [MENU] dial to highlight "[EXECUTE]" and press the [ENTER] key.

**<Note>**: If the data of a project with the same name exists on the USB memory stick when you attempt to execute exporting the project data by pressing the [ENTER] key, the following popup appears.

To overwrite the existing data, press the [ENTER] key. If you do not want to overwrite the existing data, press the [EXIT/NO] key to cancel exporting data. You can export data without overwriting the existing data after changing the project name.

```
Same PRJ exist
Over write sure?
Yes:ENTER No:EXIT
```

The LR16 starts exporting data to the USB memory stick and the display shows the progress. The display also shows the approximate finish time and remaining size of the USB memory stick.

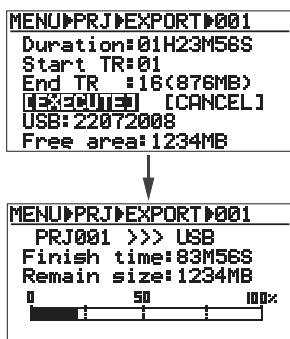

After completing exporting data, the following popup appears.

```
Completed
Pls hit any keys
```

- (5) Press any operation key. The LR16 exit the MENU mode and the display returns to the Home screen.

### Copying a stereo mix file to an external medium

You can copy a stereo mix file in the "2 mix" folder of the current project to an external USB memory stick. You can copy all or any desired stereo mix files.

**<Note>**: Connect a FAT16- or FAT32-formatted USB memory stick to the [USB HOST] port of the main unit before executing the following procedure.

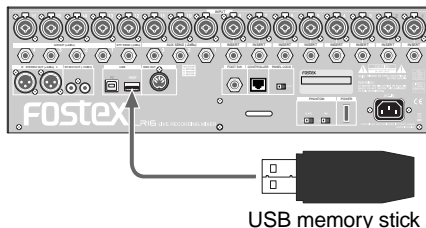

**<Note>**: If no USB memory stick is connected, or if a USB memory stick is not FAT16- or FAT32-formatted, or if no stereo mix file exists, the appropriate popup as below is shown and the LR16 cannot enter the Export mode.

```
No USB device!
```

<When no USB memory stick is set>

```
USB
Unformat!
```

<When a USB memory stick is not FAT16- or FAT32-formatted>

```
No 2mix files!
```

<When no stereo mix file exists>

- (1) Press the [ENTER] key to bring up the MENU screen. When you bring up the MENU screen for the first time, "Mark point" is highlighted.
- (2) Use the [MENU] dial to highlight "Project" and press the [ENTER] key. The display now shows the project menu.

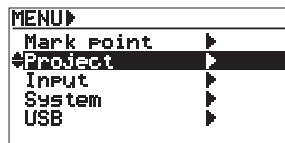

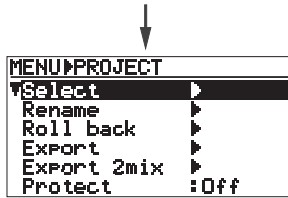

- (3) Use the [MENU] dial to highlight "Export 2mix" press the [ENTER] key. After the LR16 checks the USB memory, the display shows the "export 2 mix" screen.

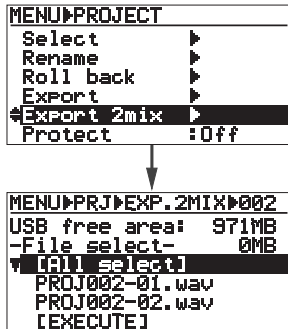

On this screen, stereo mix files in the "2 mix" folder of the current project are listed up. In the screen example above, two stereo mix files exists.

- (4) Select the file(s) to be exported. You can export any desired file(s) or all files.

**<Selecting a desired file>**

By using the [MENU] dial to select a desired file and pressing the [ENTER] key, you can put a checkmark to the left of the file name, while the volume of the selected file is shown on the right of "-File select-". By repeating the operation above, you can put a checkmark to another file.

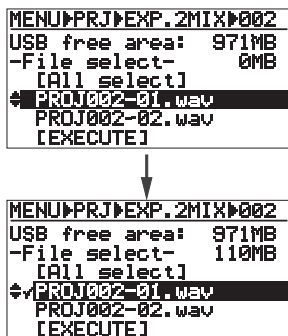

**<Selecting all files>**

By pressing the [ENTER] key while "[All select]" is highlighted, a checkmark is put to every file as below.

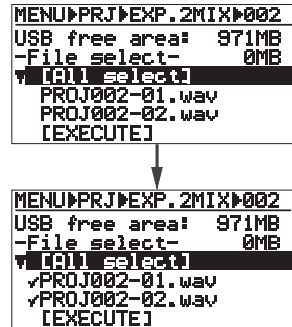

**<Memo>**: To deselect a file, highlight a desired file with a checkmark and press the [ENTER] key. The checkmark is removed.

- (5) Use the [MENU] dial to highlight "[EXECUTE]" at the bottom and press the [ENTER] key.

**<Note>**: If the data of a project with the same name exists on the USB memory stick when you attempt to execute exporting the project data by pressing the [ENTER] key, the following popup appears. To overwrite the existing data, press the [ENTER] key. If you do not want to overwrite the existing data, press the [EXIT/NO] key to cancel exporting data.



The LR16 starts exporting data to the USB memory stick and the display shows the progress. The display also shows the approximate finish time and remain size of the USB memory stick.

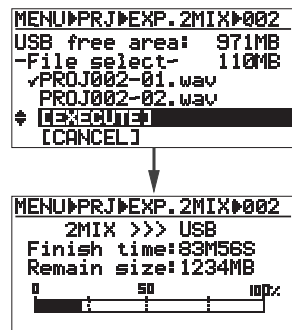

After completing exporting data, the following popup appears.



- (5) **Press any operation key.**  
The LR16 exit the MENU mode and the display returns to the Home screen.



- (4) **Use the [MENU] dial to select "On" (or "Off") and press the [ENTER] key to confirm the setting.**

- (5) **Press the [STOP] key or repeatedly press the [EXIT/NO] key to exit the MENU mode.**  
The display returns to the Home screen of the project.  
On the Home screen of a protected project, the "locked" icon is shown as below.

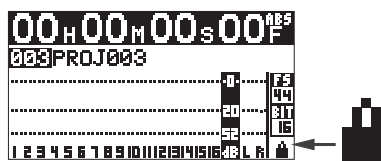

## Protecting a project

You can protect the current project.

**<Note>:** You cannot execute punch in/out or additional recording to a protected project.

- (1) **Press the [ENTER] key to bring up the MENU screen.**  
When you bring up the MENU screen for the first time, "Mark point" is highlighted.
- (2) **Use the [MENU] dial to highlight "Project" and press the [ENTER] key.**  
The display now shows the project menu.

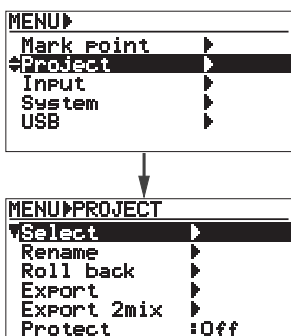

- (3) **Use the [MENU] dial to highlight "Protect" and press the [ENTER] key.**  
The current protection setting (Off or On) flashes and you can now change the setting.

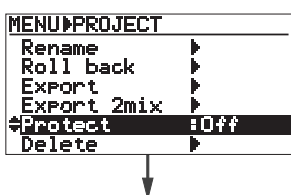

## Deleting a project

You can delete an unnecessary project from the hard disk.

**<Note>:** You cannot undo deleting a project. Make sure before deleting a project.

- (1) **Press the [ENTER] key to bring up the MENU screen.**  
When you bring up the MENU screen for the first time, "Mark point" is highlighted.
- (2) **Use the [MENU] dial to highlight "Project" and press the [ENTER] key.**  
The display now shows the project menu.

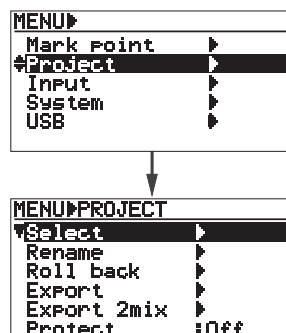



- (3) Use the [MENU] dial to highlight "Delete" and press the [ENTER] key. The display now shows the project list screen.

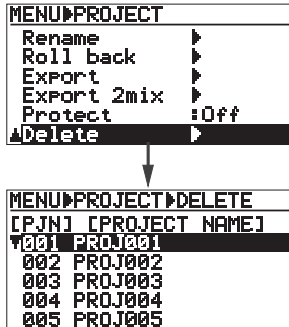

**<Note>**: When you delete a project, the recordable remaining space does not increase immediately. It increases after turning off the power and then on again.

- (4) Use the [MENU] dial to select the project you want to delete and press the [ENTER] key.

For example, if you select project 003 ("PROJ003"), the confirmation screen as below is shown.

To cancel the delete operation, press the [EXIT/NO] key. The display returns to the previous screen.



- (5) While holding down the [RECORD] key, press the [ENTER] key to delete the project.

The display shows the project list screen which does not contain the deleted project (PROJ003 in this example). Projects after the deleted project (PROJ004 and PROJ005 in this example) move up in the list, as shown below.

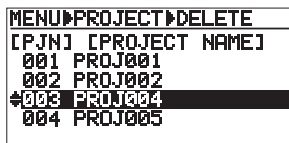

- (6) Press the [STOP] key or repeatedly press the [EXIT/NO] key to exit the MENU mode.

# File transfer to/from a computer

By connecting the [USB PC] port of the main unit to your personal computer, you can transfer audio files between the LR16 and the personal computer.

You can copy audio data recorded by the LR16 to the hard disk of your computer and import to a computer software application such as Digidesign Pro Tools.

You can also transfer the software upgrade file downloaded from our website to the LR16.

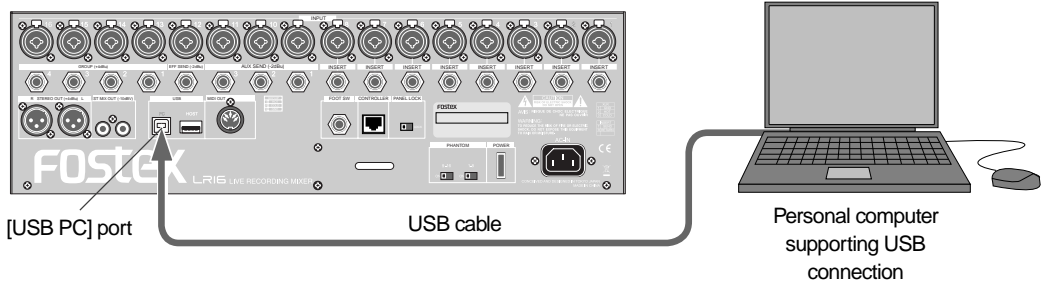

**<Note>**: The LR16 can connect to a computer running Windows ME/2000/XP/Vista or Macintosh OS X. Check the OS of your computer before using it with the LR16.

\* All company names and product names on this manual are trademarks, registered trademarks, or trade names of their respective holders.

## Connecting the LR16 to a personal computer

Connect the [USB PC] port of the LR16 to the USB port of your computer using a USB cable, as shown above. (Note that no USB cable is supplied with the LR16.)

**<Note>**: Before you connect the LR16 to your computer, turn off the power of both the machines.

**<Note>**: While a USB memory stick is connected to the [USB HOST] port, you cannot connect a personal computer to the [USB PC] port. When you connect a personal computer to the [USB PC] port, do not connect any device to the [USB HOST] port.

## Enabling USB connection

After you connect the LR16 to your computer, turn on the both machines and follow the procedure below to enable USB connection. In the following procedure, it is assumed that any project is loaded to the recorder of the LR16.

- (1) **Press the [ENTER] key to bring up the MENU screen.**  
When you bring up the MENU screen for the first time, "Mark point" is highlighted.
- (2) **Use the [MENU] dial to highlight "USB" and press the [ENTER] key.**  
The display now shows the USB menu screen.

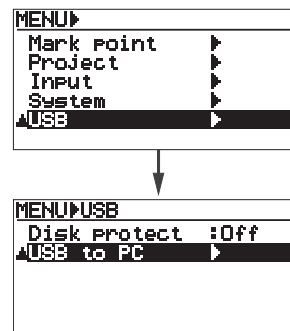

- (3) While "USB to PC" is highlighted, press the [ENTER] key.

The display now shows the screen below, in which "?" is flashing.

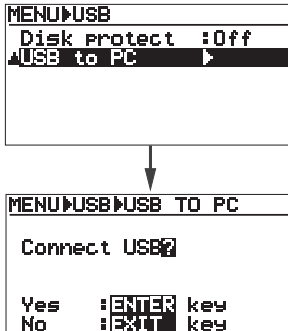

**<Memo>**: To cancel USB connection, press the [EXIT/NO] key. The display returns to show the previous screen. You can exit the MENU mode by pressing the [EXIT/NO] key repeatedly.

- (4) While "?" is flashing on the screen, press the [ENTER] key.

USB connection is enabled and the display shows the screen below.

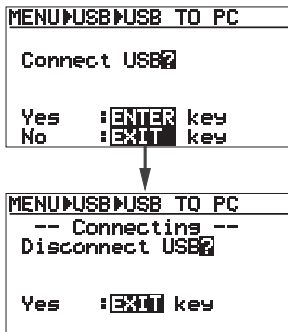

While the screen above is shown, you can transfer audio data between the LR16 and the personal computer.

**<Memo>**: When USB connection is enabled, the icon of a removable disk drive as below is shown on the "My computer" window (the icon may be different depending on computers).



**<Protecting the internal hard disk>**

On the USB menu screen, you can also select "Disk protect" menu item.

This menu item allows you to enable or disable the protection of the internal hard disk.

By default, it is set to "Off" and you can read from or write to the internal hard disk by computer operation.

If you want to protect the internal hard disk from destroying file data on the hard disk by accidental computer operation, it is recommended to enable the "Disk protect" function. When the "Disk protect" function is enabled, you can only read data from the internal hard disk by computer operation.

To enable the Disk protection function, follow the procedure below.

In the description below, it is assumed that the USB menu is shown on the display.

**<Note>**: It is recommended to enable "Disc protect" before you enable USB connection.

- (1) Use the [MENU] dial to highlight "Disk protect" and press the [ENTER] key.

The current setting ("Off" by default) starts flashing.

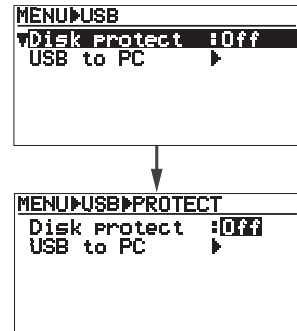

- (2) Use the [MENU] dial to select "On" and press the [ENTER] key.

The disk protect function is now enabled and the display returns to the previous screen. Then enable USB connection. To disable the disk protect function, perform the same procedure as above.

**<Memo>**: If you initialize the system memory via the "Sys default memory" menu item of the "System" menu, the disk protect function reverts back to "Off".

### Copying data from the LR16 to a computer

You can copy data from the internal hard disk of the LR16 to the hard disk of a personal computer.

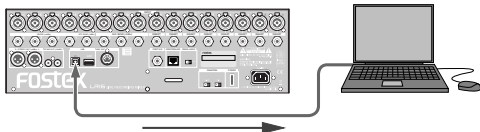

**<Note>**: When you copy data to the hard disk of a personal computer, "copy" a desired data folder. Do not "move" a desired folder. If you move a folder, the original folder on the internal hard disk of the LR16 is removed.

**<Memo>**: You can also copy data from the internal hard disk to an external USB memory stick by connecting the USB memory stick to the [USB HOST] port of the LR16 (see page 68).

**(1) Open the removable disk drive added to My computer on a personal computer.**

The window shows project folders, memory play folders, etc., on the internal hard disk, as shown below. (The following shows a window example of Window XP. See "Recording" on page 45 for details about files, etc., stored in each folder.)

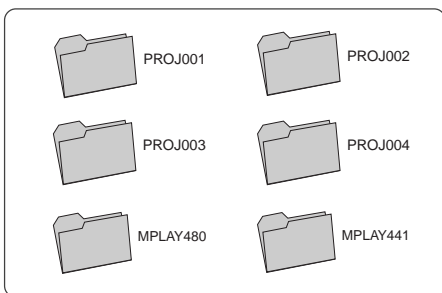

- (2) Select a desired data folder and copy the folder to the hard disk of the computer.**
- (3) After copying the data folder to the hard disk of the personal computer, remove the LR16 from the personal computer and disconnect the USB cable.**
- (4) Press the [EXIT/NO] key to disconnect the USB connection.**

### Copying data from a computer to the LR16

You can copy data from the hard disk of a personal computer to the internal hard disk of the LR16. You can also copy the downloaded software upgrade file from a personal computer to the internal hard disk of the LR16.

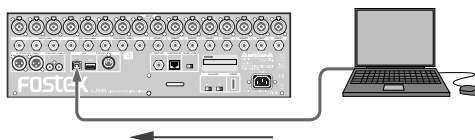

**<Note>**: When you copy data from the hard disk of a personal computer to the internal hard disk of the LR16, disable the "disk protect" function. If the "disk protect" function is enabled, you cannot copy data to the hard disk of the LR16.

**<Memo>**: You can also copy upgrade file from the personal computer to a USB memory stick and then copy the file from the USB memory stick to the LR16 (see page 80).

**(1) Copy an audio file from the hard disk of a personal computer to the "Project folder" in the "Removable disk drive" added to the "My computer" window of the computer.**

**<Memo>**: When you copy a version upgrade file, copy it to the "root" of the removable disk drive (drag & drop to the following icon).



For details about upgrading, see "Upgrade of the LR16" in "Other functions" on page 80.

**<Note>**: When you copy a stereo file from a computer to the LR16, put the file into the "2mix", "MPLAY441" or "MPLAY480" folder in the project.

- (3) After copying data from the personal computer, safety remove the LR16 from the personal computer and disconnect the USB cable.**
- (4) Press the [EXIT/NO] key to disconnect the USB connection.**

# Other functions

## Adjusting the display contrast

If the display is difficult to see, you can adjust the display contrast by rotating the [MENU] dial while the LR16 is turned on.

Rotating the [MENU] dial counterclockwise increases the contrast. Rotating the [MENU] dial clockwise decreases the contrast.

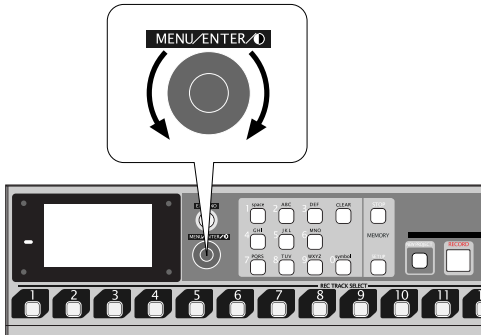

**<Memo>**: The contrast setting remains in effect even if you turn off the LR16. If you initialize the system memory via the "Sys default memory" menu item of the "System" menu, the contrast reverts back to the default setting.

## Setting the footswitch function

You can select the function of a footswitch connected to the [FOOT SW] jack on the rear panel of the main unit between the punch in/out function and memory play start/stop function.

- (1) **Press the [ENTER] key to bring up the MENU screen.**  
When you bring up the MENU screen for the first time, "Mark point" is highlighted.
- (2) **Use the [MENU] dial to highlight "System" and press the [ENTER] key.**  
The display now shows the system menu screen.

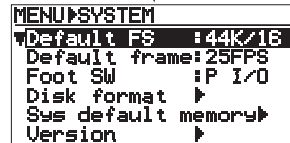
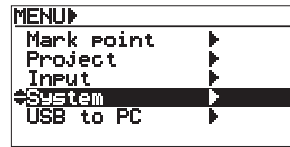

- (3) **Use the [MENU] dial to highlight "Foot SW" and press the [ENTER] key.**

The current setting starts flashing and you can now change the setting (by default, "P I/O" flashes).

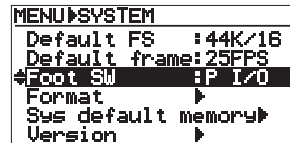

You can select from the following options.

<b>P I/O</b>	A connected footswitch acts as the punch in/out switch.
<b>MEM 0</b> <b>I</b> <b>I</b> <b>MEM 9</b>	A connected footswitch acts the same as the associated memory key. Pressing the footswitch starts or stop memory play.

- (4) **Use the [MENU] dial to highlight the desired option and press the [ENTER] key to confirm the setting.**
- (5) **Press the [STOP] key to exit the MENU mode.**

**<Memo>**: If you initialize the system memory via the "Sys default memory" menu item of the "System" menu, the footswitch function reverts back to the default setting (P I/O).

## Formatting the internal hard disk

You can format the internal hard disk of the main unit. Formatting the internal hard disk erases all the data on the disk.

**<Note>**: Formatting the internal hard disk erases all the data on the disk. Before you format the hard disk, back up the necessary data by copying to a hard disk of your personal computer or an external USB memory stick, etc. (See page 74 for details about how to copy data to your personal computer and page 68 for detail about how to copy data to a USB memory stick.)

- (1) Press the [ENTER] key to bring up the MENU screen.

When you bring up the MENU screen for the first time, "Mark point" is highlighted.

- (2) Use the [MENU] dial to highlight "System" and press the [ENTER] key.

The display now shows the system menu screen.

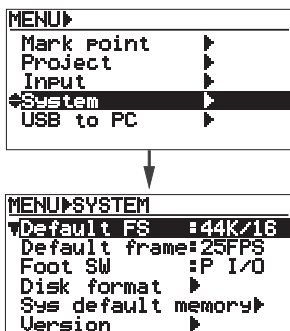

- (3) Use the [MENU] dial to highlight "Disk Format" and press the [ENTER] key.

The confirmation screen as below is shown.

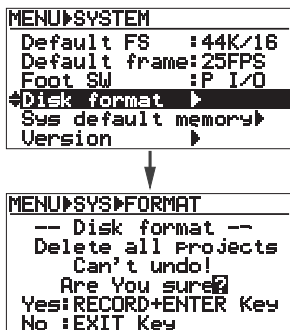

**<Memo>**: To cancel disk formatting, press the [STOP] key.

- (4) While holding down the [RECORD] key, press the [ENTER] key.

Disk formatting starts and the display as below is shown. When disk formatting is completed, the display shows "Completed!".

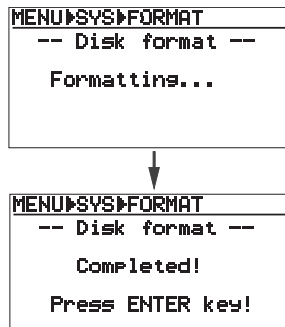

- (5) Press the [ENTER] key.

The LR16 exits MENU mode and the display shows the Home screen of an empty disk as below.



## Initializing the system memory

You can initialize the system memory in the internal flash ROM and revert the following system setting items back to the default condition.

Setting items	Default
Assign Sub In	15/16
Assign MemPlay	-/-
Default Frame	25FPS
Foot SW	P I/O
Default FS	44K/16
Disk Protect	Off
Contrast level	-

- (1) Press the [ENTER] key to bring up the MENU screen.

When you bring up the MENU screen for the first time, "Mark point" is highlighted.

- (2) Use the [MENU] dial to highlight "System" and press the [ENTER] key.

The display now shows the system menu screen.

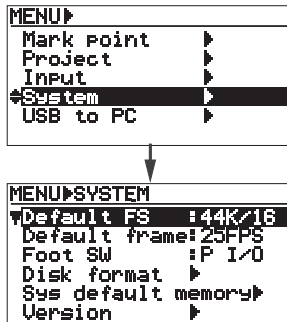

- (3) Use the [MENU] dial to highlight "Sys default memory" and press the [ENTER] key.

The confirmation screen as below is shown.



<Memo>: To cancel system initialization, press the [STOP] key.

- (4) While holding down the [RECORD] key, press the [ENTER] key. System initialization is performed immediately and the display returns to the Home screen previously shown before entering MENU mode.

### Assigning the destinations of SUB IN and the memory play signals

You can assign the destination channels of the signal received from the [SUB IN] jacks on the control panel as well as the memory play signal.

- (1) Press the [ENTER] key to bring up the MENU screen. When you bring up the MENU screen for the first time, "Mark point" is highlighted.
- (2) Use the [MENU] dial to highlight "Input" and press the [ENTER] key. The display now shows the screen on which you can assign the destination channels of "SubIn" and "MemPlay".

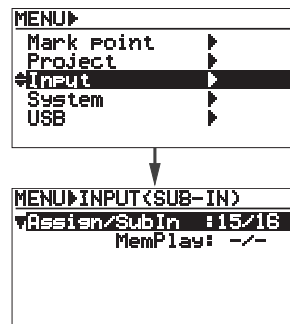

#### •To assign the destination channels of SUB IN

- (3) While the "Assign/SubIn" item is highlighted, press the [ENTER] key. The current setting ("15/16" by default) starts flashing.

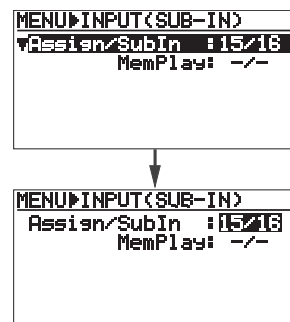

- (4) Use the [MENU] dial to select the destination channels and press the [ENTER] key. You can select from channel pairs ("1/2", "3/4" and "5/6") as well as "-/-". When "-/-" is selected, no channel is assigned.

**<Note>**: If you attempt to select the same destination channels as the memory play signal, the warning message as below is shown and you cannot select the channels.

```
Invalid Parameter!
Conflict with
MemPlay
```

•To assign the destination channels of Memory play

- (3) Use the [MENU] dial to highlight "MemPlay" item and press the [ENTER] key.

The current setting ("-/-" by default) starts flashing.

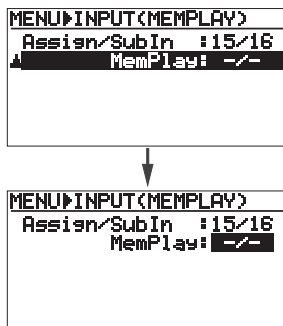

- (4) Use the [MENU] dial to select the destination channels and press the [ENTER] key.

You can select from channel pairs ("1/2", "3/4" and "5/6") as well as "-/-". When "-/-" is selected, no channel is assigned.

**<Note>**: If you attempt to select the same destination channels as the SUB IN signal, the warning message as below is shown and you cannot select the channels.

```
Invalid Parameter!
Conflict with
SubIn
```

- (5) Press the [STOP] key to exit the MENU mode.

**<Memo>**: If you initialize the system memory via the "Sys default memory" menu item of the "System" menu, these items revert back to the default settings.

### Software version upgrade

When the software version of the LR16 is upgraded, you can upgrade the LR16 by yourself. The upgraded software can be downloaded via the Fostex website (<http://www.fostexinternational.com/>).

Use either of the methods below to upgrade the software.

The downloaded software file has the ".mot" extension. See the Fostex website for details about how to download the file.

**<Note>**: If you cannot download the file from the Fostex website, consult the Fostex service station or your nearest dealer.

#### <Method 1>

Use the "USB" menu in the MENU mode to connect the LR16 to a personal computer and transfer the downloaded upgrade file to the internal hard disk of the LR16. For details about how to transfer a file, see page 74.

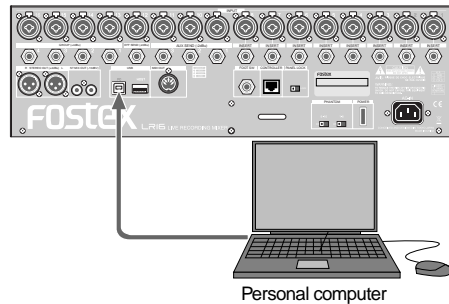

#### <Method 2>

Connect a USB memory stick to a personal computer and copy the downloaded upgrade file to the USB memory stick, then connect the USB memory stick to the [USB HOST] port of the LR16.

Note that you cannot connect a personal computer to the LR16 while a USB memory stick is connected to the LR16.

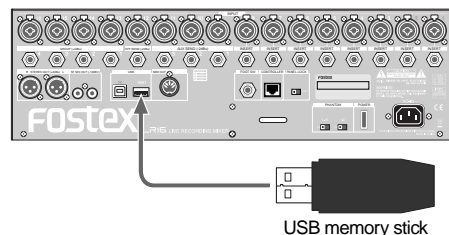



In the following procedure, it is assumed the following. The upgrade file is transferred to the internal hard disk of the LR16 or the USB memory stick to which the upgrade file is copied from a personal computer is connected to the [USB HOST] port of the LR16, The LR16 is turned off.

- (1) Turn on the LR16.
- (2) Press the [ENTER] key to bring up the MENU screen.  
When you bring up the MENU screen for the first time, "Mark point" is highlighted.
- (3) Use the [MENU] dial to highlight "System" and press the [ENTER] key.  
The display now shows the system menu screen.

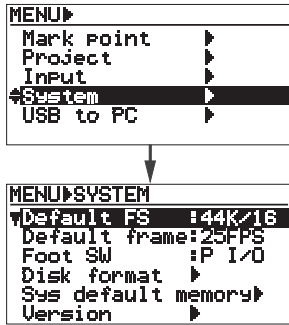

- (4) Use the [MENU] dial to highlight "Version" and press the [ENTER] key.  
The current software version is shown.

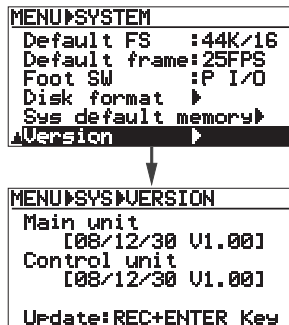

- (5) While holding down the [RECORD] key, press the [ENTER] key.  
The upgrade file which is stored to the internal hard disk (or the USB memory connected to the [USB HOST] port) is displayed.



- (6) Use the [MENU] dial to highlight the upgrade file (with ".MOT" extension) and press the [ENTER] key.  
The confirmation message appears.

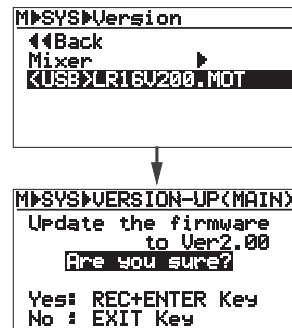

<Memo>: To cancel version upgrading, press the [STOP] key.

- (7) While holding down the [RECORD] key, press the [ENTER] key.  
The LR16 starts upgrading the software version and the display changes as follows. It takes some time until completing the software upgrade.

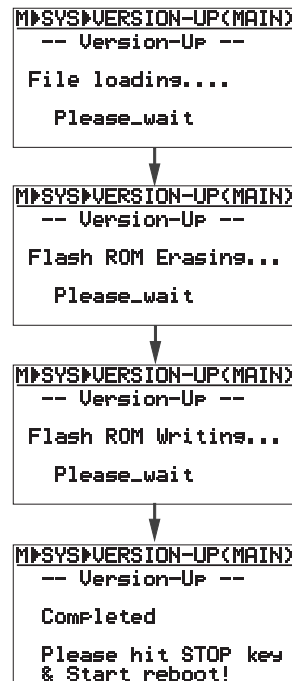

- (8) When upgrading is completed, press the [STOP] key to exit the MENU mode.
- (9) Turn the LR16 off and then on.

## MIDI synchronization

MIDI (Musical Instrument Digital Interface) is an industry-standard protocol which enables electronic musical instruments, computers, and other equipment to communicate, control, and synchronize with each other.

### <MIDI connection>

To send MIDI message from the LR16 to external MIDI equipment, connect the [MIDI OUT] port of the LR16 to the [MIDI IN] port of external MIDI equipment using a MIDI cable.

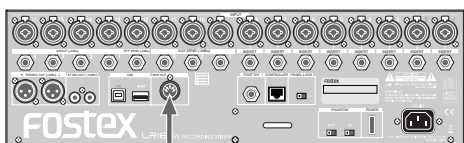

MIDI IN  
External MIDI equipment

### <MIDI message supported by the LR16>

The [MIDI OUT] port of the LR16 sends MTC (MIDI Time Code) message which allows synchronization between the LR16 and external MIDI equipment. The frame rate of MTC is set to 25 fps by default, however, you can also set it to 30 fps (see the right column on this page for details about how to set the frame rate).

**<Note>**: It is recommended to set the frame rate before you make recording in the new project mode or you create a new project using the "Project" menu in the MENU mode.

**<Note>**: The LR16 can be a master but cannot be a slave.

**<Memo>**: This manual contains the MIDI implementation chart of the LR16 on page 86. When you use MIDI equipment with the LR16, check the MIDI implementation charts of the LR16 and MIDI equipment.

## • Setting frame rate

- (1) **Press the [ENTER] key to bring up the MENU screen.**  
When you bring up the MENU screen for the first time, "Mark point" is highlighted.
- (2) **Use the [MENU] dial to highlight "System" and press the [ENTER] key.**  
The display now shows the system menu screen.

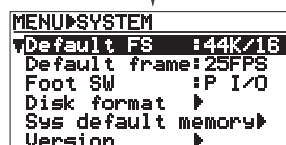
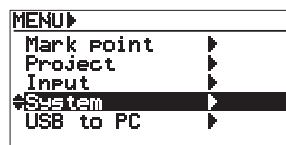

- (3) **Use the [MENU] dial to highlight "Default frame" and press the [ENTER] key.**  
The current frame setting starts flashing (by default, "25FPS" is selected).

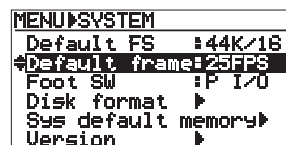

- (4) **Use the [MENU] dial to select the desired frame rate and press the [ENTER] key.**  
You can select between "25FPS" and "30FPS".
- (5) **Press the [STOP] key to exit the MENU mode.**

**<Memo>**: If you initialize the system memory via the "Sys default memory" menu item of the "System" menu, the frame rate reverts back to the default setting ("25FPS").

## Setting FS/Bit of project

You can select the FS (sampling frequency) and Bit length combination of a newly created project. By default, it is set to 44 kHz/16 bits.

**<Note>**: The FS/Bit setting here does not affect to existing projects. The setting affects to a project recorded by the new project mode or a project newly created via the "Project" menu of the MENU mode.

- (1) **Press the [ENTER] key to bring up the MENU screen.**  
When you bring up the MENU screen for the first time, "Mark point" is highlighted.
- (2) **Use the [MENU] dial to highlight "System" and press the [ENTER] key.**  
The display now shows the system menu screen.

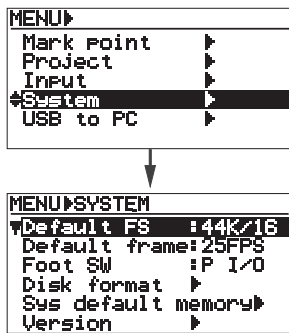

- (3) **While "Default FS" menu is highlighted, press the [ENTER] key.**  
The current setting starts flashing (by default, "44K/16" is selected).

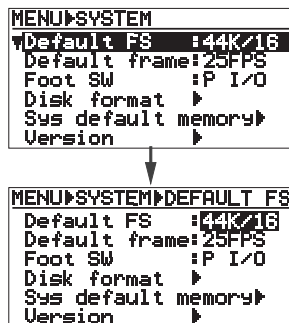

- (4) **Use the [MENU] dial to select the desired FS/Bit combination and press the [ENTER] key to confirm the setting.**  
You can select from "44K/16" (default), "44K/24", "48K/16" and "48K/24".

- (5) **Press the [STOP] key to exit the MENU mode.**

The selected FS/Bit combination is shown on the Home screen.

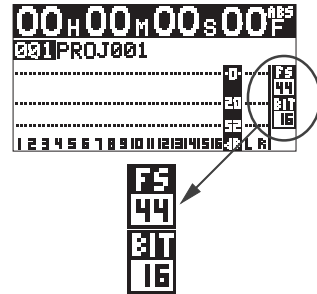

**<Note>**: If you change the FS/Bit combination of an existing project and attempt to make recording, the following warning message appears. Revert to the original FS/Bit combination of the project.

Different type of FS! Please adjust Default FS.

**<Memo>**: If you initialize the system memory via the "Sys default memory" menu item of the "System" menu, the FS/Bit combination reverts back to the default setting ("25FPS").

# Specifications

## Inputs/Outputs

0dBV = 1.0 Vrms, 0dBu = 0.775 Vrms  
Reference level: -20dBfs

### Input and Output (Main unit)

#### [MIC INPUT (1 - 16)]

Connectors: XLR3-31, balanced (combo)  
Nominal input level: -60dBu ~ -12dBu  
Input impedance: more than 1.5k $\Omega$   
Phantom Power: P48V (1-8ch & 9-16ch switchable, on/off)

#### [LINE INPUT (1 - 16)]

Connectors:  $\phi$ 6.3mm TRS phone, balanced (combo)  
Nominal input level: -40dBu ~ +8dBu  
Input impedance: more than 10k $\Omega$

#### [INSERT (1 - 8)]

Connectors:  $\phi$ 6.3mm TRS phone, (Tip: Output, Ring: Input)  
Load impedance: more than 10k $\Omega$   
Nominal output level: -10dBV  
Input impedance: more than 10k $\Omega$   
Nominal input level: -10dBV

#### [STEREO BUS OUT (L, R)]

Connectors: XLR3-31, balanced  
Reference output level: +4dBu  
Load impedance: more than 10k $\Omega$

#### [GROUP BUS OUT (1 - 4)]

Connectors:  $\phi$ 6.3mm TRS phone, balanced  
Reference output level: +4dBu  
Load impedance: more than 10k $\Omega$

#### [AUX SEND (1 - 3)]

Connectors:  $\phi$ 6.3mm phone, unbalanced  
Reference output level: -2dBu  
Load impedance: more than 10k $\Omega$

#### [EFFECT SEND]

Connector:  $\phi$ 6.3mm phone, unbalanced  
Reference output level: -2dBu  
Load impedance: more than 10k $\Omega$

#### [STEREO MIX OUT (L, R)]

Connectors: RCA, unbalanced  
Reference output level: -10dBu  
Load impedance: more than 10k $\Omega$

#### [FOOT SW]

Connector:  $\phi$ 6.3mm phone,  
Level: TTL level (unlatched type)

#### [USB (PC)]

Device: USB2.0 Hi-speed for PC connection  
Connector: B type

#### [USB (HOST)]

Device: USB2.0 Hi-speed for storage connection  
Connector: A type

#### [MIDI OUT]

Connector: DIN 5-pin

#### [TO CONTROL BOX]

Connector: RJ45 (CAT5, straight)

### Input and Output (Controller unit)

#### [PHONES]

Connector:  $\phi$ 6.3mm Stereo Phone  
Load impedance: more than 32 $\Omega$

#### [MONITOR OUT (L, R)]

Connector:  $\phi$ 6.3mm Phone, unbalanced  
Reference output level: -12dBV  
Load impedance: more than 32 $\Omega$

#### [SUB IN (L, R)]

Connector: RCA, unbalanced  
Reference input level: -10dBV  
Input impedance: more than 10k $\Omega$

#### [TO I/O BOX]

Connector: RJ45 (CAT5, straight)

## Recording/Playback

**Recording media:** Internal 3.5" HDD

**Sampling frequency:** 44.1/48kHz

**Quantization:** 16bit/24bit

**File system:** FAT32 (WAV)

**Number of recording tracks:** 1 - 16

**Recording time:** approx. 16 hours (80GB HD, 16bit/44.1kHz, 16 tracks)

**Frequency response:** 20Hz - 20kHz +1dB, -2dB (44.1/48kHz)

**S/N:** Line (Trim Min) 95dB or more (typical)  
Mic (Trim Max) 90dB or more (typical)

**Dynamic range:** 100dB or more (Trim Min)(Typical)

**T.H.D.:** Mic (Trim Max) -> ST out: 0.01% or less (1kHz, -2dBFS)  
Line (Trim Min) -> ST out: 0.01% or less (1kHz, -2dBFS)  
Line (Trim Min) -> Phones: 0.1% or less (1kHz, 70mW, 32Ω)

**General**

**Dimensions:** 482 (W) x 136 (H) x 570 (D) mm

**Weight:** approx. 13kg

**Power Requirement:** 120VAC 50/60Hz  
230VAC 50/60Hz  
240VAC 50/60Hz

**Power Consumption:** approx. 60W

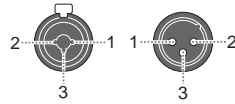

1	GND
2	HOT
3	COLD

**Physical dimensions**

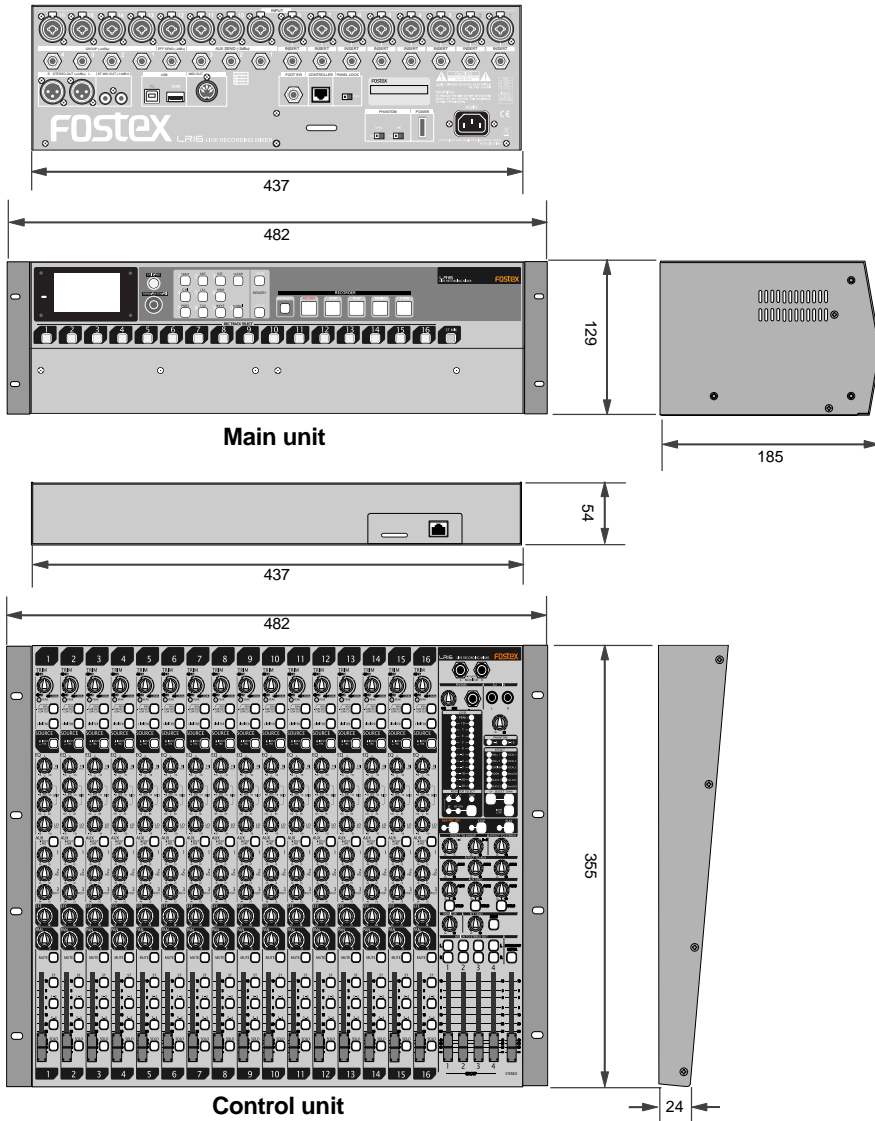

**[LIVE RECORDING MIXER]**

Date: 2008.12.24

**Model LR16**

**MIDI Implementation Chart**

Version: V1.00

Function.....		Transmitted	Recognized	Remarks
Basic Channel	Default	X	X	
	Changed	X	X	
Mode	Default	X	X	
	Message	X	X	
	Altered	*****	X	
Note Number:	True Voice	X	X	
		*****	X	
Velocity	Note ON	X	X	
	Note OFF	X	X	
After Touch	Key's	X	X	
	Channel's	X	X	
Pitch Bend		X	X	
Control Change		X	X	
Program Change	True #	X	X	
		*****	*****	
System Exclusive		X	X	
Common	: Quarter Frame	O	X	
	: Song Position	X	X	
	: Song Select	X	X	
	: Tune	X	X	
System Real Time	: Clock	X	X	
	: Commands	X	X	
Aux. Message	: Local ON/OFF	X	X	
	: All Notes OFF	X	X	
	: Active Sense	X	X	
	: Reset	X	X	
Notes				

Mode 1: OMNI ON, POLY  
 Mode 3: OMNI OFF, POLY

Mode 2: OMNI ON, MONO  
 Mode 4: OMNI OFF, MONO

O: Yes  
 X: No

## Declaration of EC Directive

This equipment is compatible with the EMC Directive (2004/108/EC) - Directive on approximation of member nation's ordinance concerning the electromagnetic compatibility and with the Low Voltage Directive (73/23/EEC) - Directive on approximation of member nation's ordinance concerning electric equipment designed to be used within the specified voltage range.

### The Affect of Immunity on This Equipment

The affect of the European Specification EN61000-6-1 (coexistence of electromagnetic waves - common immunity specification) on this equipment are as shown below.

In the electrical fast transient/burst requirements, surge, conducted disturbances by radio-frequency fields, power frequency magnetic field, radiate electromagnetic field requirements and static electricity discharging environment, this could be affected by generation of noise in some cases.

### FOSTEX DISTRIBUTORS LIST IN EUROPE

\* Including non-EU countries (as of March 2007)

#### <AUSTRIA>

NAME: ATEC Audio-u. Videogeraete VertriebsgesmbH.  
ADD: Im Winkel 5, A-2325 Velm, Austria  
TEL: (+43) 2234-74004, FAX: (+43) 2234-74074

#### <BELGIUM>

NAME: General Audio  
ADD: Raymond Pelgrimsaan 101, B-1702 Groot-Bijgaarden, Belgium  
TEL: (+32) 2-4630650, FAX: (+32) 2-4661500

#### <DENMARK>

NAME: SC Sound ApS  
ADD: Malervej 2, DK-2630 Taastrup, Denmark  
TEL: (+45) 4399-8877, FAX: (+45) 4399-8077

#### <FINLAND>

NAME: Norettron Oy Audio  
ADD: P. O. Box 22, FIN-02631 Espoo, Finland  
TEL: (+358) 9-5259330, FAX: (+358) 9-52593352

#### <FRANCE>

NAME: Sennheiser France  
ADD: 128 bis, avenue Jean-Jaures, 94851 Ivry-sur-Seine Cedex, France  
TEL: (+33) 1 4987 0300, FAX: (+33) 1 4987 0324

#### <GERMANY>

NAME: Mega Audio GmbH  
ADD: Stromberger Str. 32, D-55411 Bingen, Germany  
TEL: (+49) 6721-94330, FAX: (+49) 6721-32046

#### <GREECE>

NAME: Bon Studio S. A.  
ADD: 6 Zaimi Street, Exarchia, 106.83 Athens, Greece  
TEL: (+30) 210-3809-605, 606, 607, 608  
FAX: (+30) 210-3845-755, 210-3827-868

#### <ICELAND>

NAME: I. D. elf. electronic Ltd.  
ADD: ARMULA 38 108 REYKJAVIK, ICELAND  
TEL: (+354) 588 5010, FAX: (+354) 588 5011

#### <ITALY>

NAME: Proel S. p. A.  
ADD: Zona Via Alla Ruenia, 37/43 64027 - Sant'Omero (Teramo), Italy  
TEL: (+39) 0861-81241, FAX: (+39) 0861-887862

#### <THE NETHERLANDS>

NAME: IEMKE ROOS AUDIO B. V.  
ADD: Kuiperbergweg 20, 1101 AG Amsterdam, The Netherlands  
TEL: (+31) 20-697-2121, FAX: (+31) 20-697-4201

#### <NORWAY>

NAME: Siv. Ing. Benum AS  
ADD: P. O. Box 145, Vinderen, 0319 Oslo, Norway  
TEL: (+47) 2213 9900, FAX: (+47) 2214 8259

#### <SPAIN>

NAME: Letusa S. A.  
ADD: C/Laguna 10, 28923 Alcorcon, Madrid, Spain  
TEL: (+34) 91-4862800, 91-4470898  
FAX: (+34) 91-6414597

#### <SWEDEN>

NAME: Kinovox-Benum A/B  
ADD: Solna Strandvag 78 171 54 Solna, Sweden  
TEL: (+46) 8 5052 1176, FAX: (+46) 8 5052 1010

#### <SWITZERLAND>

NAME: Audio Bauer Pro AG  
ADD: Bernerstrasse-Nord 182, CH-8064 Zurich, Switzerland  
TEL: (+41) 1-4323230, FAX: (+41) 1-4326558

#### <UK>

NAME: SCV London  
ADD: 40 Chigwell Lane, Oakwood Hill Industrial Estate, Loughton, Essex IG10 3NY U. K.  
TEL: (+44) 20-8418-0778, FAX: (+44) 20-8418-0624

# FOR THE US CUSTOMERS ONLY

## FOSTEX AMERICA LIMITED WARRANTY

The following statement defines specific legal rights. You may also have additional rights depending on the state in which the Fostex product was purchased.

### WARRANTY PROTECTION

All Fostex parts are warranted for one (1) year from the date of original purchase, except for recording media, such as hard disc drives and compact flash cards, heads, lamps and fuses, which are warranted, for one hundred-eighty (180) days. Fostex America will repair and / or replace parts during the term of this warranty. Labor costs are also covered by Fostex America for one (1) year from the date of original purchase. Except as specified below, this warranty covers all defects in material and workmanship in this product.

The following are not covered by this warranty:

1. Batteries.
2. Damage to any product that has been altered.
3. Damage to any product on which the original serial number has been defaced, modified or removed.
4. Damage to or deterioration of the external cabinet.
5. Damage occurring during shipment of the product. (**NOTE:** Shipping claims must be presented to the carrier.)
6. Damage resulting from accident, misuse, abuse or neglect.
7. Damage resulting from failure to perform routine maintenance and / or calibration procedures.
8. Damage resulting from failure to follow instruction in the owner's manual.
9. Damage resulting from repair or attempted repair or by someone other than a Fostex America Service technician or a technician at an authorized Fostex America service station.
10. Damage resulting from causes other than product defects, including lack of technical skill, competence or experience on the part of the user.
11. External appearance items such as cosmetic parts, knobs, liquid crystal displays, buttons, etc.
12. Replacements or repairs necessitated by loss or damages resulting from any cause beyond the control of Fostex America.
13. Damage resulting from misuse or abuse on rental units.

**NOTE: FOSTEX AMERICA IS NOT RESPONSIBLE FOR DATA LOST OR DAMAGED DURING OPERATION OF THIS PRODUCT. CALIBRATION AND MAINTENANCE PROCEDURES ARE NOT COVERED BY THIS WARRANTY.**

Fostex America reserves the right to inspect all products submitted pursuant to this warranty. If such an inspection shows reasonable cause to believe that any of the above exclusions to the above warranty are applicable, then Fostex America or the authorized service station will charge prevailing service rates and parts, costs for any repairs.



## FOSTEX AMERICA LIMITED WARRANTY

To claim all warranty service, first access [www.fostex.com](http://www.fostex.com) to receive service authorization (RMA number). Then present the authorization together with the bill of sale, which shows the date of original purchase to Fostex America. This warranty is not transferable.

### SHIPPING

If this product needs service, you must take it, or package it carefully, using ample packaging materials to prevent damage during shipment and mail it to the distributor from whom you have purchased this product, postage pre-paid and insured.

**NOTE:** Fostex America will not assume responsibility for damages or losses occurred in transit, but will reasonably assist the sender in processing any claims whenever possible (such as submitting statements to the carriers when applicable).

Any collect or C.O.D. shipments will be refused. In order to obtain warranty repairs, you must include the following:

1. Date proof of original purchase (copy of bill of sale or charge slip).
2. A note describing the problem with sufficient particularity to allow Fostex America to inspect or adjust the problem.
3. All accessory items appurtenant to that problem.

### LIMITATIONS OF IMPLIED WARRANTIES AND EXCLUSIONS OF CERTAIN DAMAGES

Unless considered unenforceable or unlawful under applicable law:

- A. All implied warranties - including warranties of merchantability and fitness for a particular purpose - are limited in duration to term of this warranty and to the express coverage of this warranty;
- B. Fostex America's liability for any defect product is expressly limited to repair or replacement of the product, at the sole discretion and / or option of Fostex America. Fostex America shall not under any circumstances be liable for:
  1. Damaged based on inconvenience, loss of use of the product, loss of time, interrupted operation or commercial loss, OR;
  2. Any damages, whether incidental, consequential or otherwise, except damages which may not be excluded by under applicable law.
- C. Fostex America makes no other warranties, express or implied, above and / or beyond the representations made herein.

### WARRANTY APPLIES ONLY TO THOSE PRODUCTS SOLD AND DISTRIBUTED BY FOSTEX AMERICA

Service Department

#### FOSTEX AMERICA

9 Mars Court Boonton, NJ 07005

TEL: 973-394-0015 FAX: 973-394-0800

Email: [support@fostexusa.com](mailto:support@fostexusa.com)

Web: [www.fostex.com](http://www.fostex.com)

## Index

<b>&lt;A&gt;</b>	
Assign channel .....	59, 79
ADL file .....	45, 52, 66
<b>&lt;B&gt;</b>	
Balanced type .....	20
Bus .....	34
Block diagram .....	42
<b>&lt;C&gt;</b>	
CAT-5 cable .....	13
Condensation .....	10
Connector .....	20
Contrast .....	77
Control unit .....	15, 24
Connection .....	18, 35
<b>&lt;D&gt;</b>	
Display .....	30
<b>&lt;E&gt;</b>	
Equalizer .....	36
Effect processor .....	37, 38
Effect type .....	39
Folder .....	45
<b>&lt;F&gt;</b>	
Footswitch .....	55, 60, 77
Format .....	78
Frame rate .....	48, 82
File transfer to/from a computer .....	74
<b>&lt;G&gt;</b>	
Grouping .....	40
<b>&lt;H&gt;</b>	
Hard disk drive .....	9, 44, 78
Home recording .....	19
Home screen .....	30
<b>&lt;I&gt;</b>	
Insert mode .....	45
INSERT connector .....	38
Initializing .....	78
Internal effect processor .....	38
Input level .....	35, 48
<b>&lt;L&gt;</b>	
Live recording .....	48, 46
Limiter .....	36
Low cut .....	36
LOG folder .....	45, 52, 67
<b>&lt;M&gt;</b>	
Memory play mode .....	59
My computer .....	75
Master channel .....	24
Mark .....	60
Mixer functions .....	33
MIDI .....	82, 86
Mixdown .....	52
Memory play .....	57
Main unit .....	15, 27
MENU mode screen .....	31
Monitoring .....	39
<b>&lt;N&gt;</b>	
New project mode .....	45
<b>&lt;O&gt;</b>	
Overdubbing .....	51
<b>&lt;P&gt;</b>	
Physical dimensions .....	85
Playback .....	50
Power supply .....	9, 17
Panel rock .....	31
Punch in/out .....	54
Personal computer .....	74
Phantom power .....	35
Project .....	45, 65
Protect .....	75
Pre-fader .....	37
Post-fader .....	37
<b>&lt;R&gt;</b>	
Recording format .....	44
Recording mode .....	45
Recording .....	44
Recorder functions .....	43
Roll back .....	67
<b>&lt;S&gt;</b>	
SUB IN .....	41, 79
Sampling frequency .....	48, 83
Signal flow of the mixer .....	34
System memory .....	78
Specifications .....	84
Stereo bus .....	49
Stereo mix .....	47
Solo monitoring .....	40
Stereo mix file .....	45, 58, 70
Stereo mix folder .....	45, 50, 70
<b>&lt;T&gt;</b>	
Trim control .....	22, 35
<b>&lt;U&gt;</b>	
USB .....	73
USB flash memory stick .....	68, 80
Unbalanced type .....	20
<b>&lt;V&gt;</b>	
Version upgrade .....	10, 80
<b>&lt;Y&gt;</b>	
Y cable .....	29, 38



**Fostex**

**FOSTEX CO.**

3-2-35 Musashino, Akishima-shi, Tokyo Japan 196-0021

© PRINTED IN JAPAN DEC. 2008 8588103000 479095

## Free Manuals Download Website

<http://myh66.com>

<http://usermanuals.us>

<http://www.somanuals.com>

<http://www.4manuals.cc>

<http://www.manual-lib.com>

<http://www.404manual.com>

<http://www.luxmanual.com>

<http://aubethermostatmanual.com>

Golf course search by state

<http://golfingnear.com>

Email search by domain

<http://emailbydomain.com>

Auto manuals search

<http://auto.somanuals.com>

TV manuals search

<http://tv.somanuals.com>