

---

# Foundry FastIron GS Compact Layer 2 Switch POE and POE-Upgradeable Hardware Installation Guide

FGS624P

FGS624P-POE

FGS648P

FGS648P-POE

FGS624XGP

FGS624XGP-POE

FGS Release 04.0.00



4980 Great America Parkway  
Santa Clara, CA 95054  
Tel 408.207.1700  
www.foundrynetworks.com

September 2007

---

Copyright © 2007 Foundry Networks, Inc. All rights reserved.

No part of this work may be reproduced in any form or by any means – graphic, electronic or mechanical, including photocopying, recording, taping or storage in an information retrieval system – without prior written permission of the copyright owner.

The trademarks, logos and service marks ("Marks") displayed herein are the property of Foundry or other third parties. You are not permitted to use these Marks without the prior written consent of Foundry or such appropriate third party.

*Foundry Networks, BigIron, FastIron, IronView, JetCore, NetIron, ServerIron, Turbolron, IronWare, EdgIron, IronPoint*, the Iron family of marks and the Foundry Logo are trademarks or registered trademarks of Foundry Networks, Inc. in the United States and other countries.

F-Secure is a trademark of F-Secure Corporation. All other trademarks mentioned in this document are the property of their respective owners.

## CHAPTER 1

<b>ABOUT THIS GUIDE.....</b>	<b>1-1</b>
INTRODUCTION .....	1-1
WHAT'S INCLUDED IN THIS EDITION? .....	1-1
AUDIENCE .....	1-1
NOMENCLATURE .....	1-1
RELATED PUBLICATIONS .....	1-2
HOW TO GET HELP .....	1-2
WEB ACCESS .....	1-2
EMAIL ACCESS .....	1-2
TELEPHONE ACCESS .....	1-2
WARRANTY COVERAGE .....	1-2

## CHAPTER 2

<b>PRODUCT OVERVIEW .....</b>	<b>2-1</b>
PRODUCT OVERVIEW .....	2-1
SOFTWARE FEATURES .....	2-2
HARDWARE FEATURES .....	2-2
FGS624P AND FGS624P-POE .....	2-2
FGS624XGP AND FGS624XGP-POE .....	2-3
FGS648P AND FGS648P-POE .....	2-3
CONTROL FEATURES .....	2-4
FIBER OPTIC MODULES .....	2-12
POWER SUPPLIES .....	2-12
COOLING SYSTEM AND FANS .....	2-13

## CHAPTER 3

<b>INSTALLING THE FASTIRON GS CHASSIS.....</b>	<b>3-1</b>
UNPACKING A SYSTEM .....	3-1
PACKAGE CONTENTS .....	3-1

GENERAL REQUIREMENTS .....	3-1
SUMMARY OF INSTALLATION TASKS .....	3-2
INSTALLATION PRECAUTIONS .....	3-3
GENERAL PRECAUTIONS .....	3-3
LIFTING PRECAUTIONS .....	3-3
POWER SUPPLY PRECAUTIONS .....	3-4
PREPARING THE INSTALLATION SITE .....	3-5
CABLING INFRASTRUCTURE .....	3-5
INSTALLATION LOCATION .....	3-5
INSTALLING AN ADDITIONAL POWER SUPPLY .....	3-5
INSTALLING AN AC POWER SUPPLY .....	3-6
INSTALLING A DC POWER SUPPLY .....	3-8
INSTALLING THE DEVICE .....	3-11
DESKTOP INSTALLATION .....	3-11
RACK MOUNT INSTALLATION .....	3-11
WALL MOUNT INSTALLATION .....	3-13
POWERING ON THE SYSTEM .....	3-14
POWERING OFF THE SYSTEM .....	3-15
VERIFYING PROPER OPERATION .....	3-15
OBSERVING THE POWER STATUS LEDs .....	3-16
ATTACHING A PC OR TERMINAL .....	3-16

## CHAPTER 4

### CONNECTING NETWORK DEVICES AND

### CHECKING CONNECTIVITY ..... 4-1

ASSIGNING PERMANENT PASSWORDS .....	4-1
RECOVERING FROM A LOST PASSWORD .....	4-2
CONFIGURING IP ADDRESSES .....	4-3
DEVICES RUNNING LAYER 2 SOFTWARE .....	4-3
CONNECTING NETWORK DEVICES .....	4-4
CABLE SPECIFICATIONS .....	4-4
CONNECTING TO ETHERNET OR FAST ETHERNET HUBS .....	4-4
CONNECTING TO WORKSTATIONS, SERVERS, OR ROUTERS .....	4-5
CONNECTING A NETWORK DEVICE TO A FIBER PORT .....	4-5
TESTING CONNECTIVITY .....	4-6
PINGING AN IP ADDRESS .....	4-6
OBSERVING LEDs .....	4-7
TRACING A ROUTE .....	4-8
TROUBLESHOOTING NETWORK CONNECTIONS .....	4-8
USING VIRTUAL CABLE TESTING TO DIAGNOSE A CABLE .....	4-8

## CHAPTER 5

### MANAGING THE FASTIRON GS CHASSIS ..... 5-1

MANAGING TEMPERATURE SETTINGS .....	5-1
USING THE TEMPERATURE SENSOR .....	5-1

DISPLAYING THE TEMPERATURE .....	5-1
DISPLAYING TEMPERATURE MESSAGES .....	5-2
CHANGING THE TEMPERATURE WARNING LEVEL .....	5-2
CHANGING THE CHASSIS TEMPERATURE POLLING INTERVAL .....	5-3
DISPLAYING MANAGEMENT MODULE CPU USAGE .....	5-3
REMOVING MAC ADDRESS ENTRIES .....	5-3

## CHAPTER 6

### **HARDWARE SPECIFICATIONS..... 6-1**

CHASSIS SPECIFICATIONS .....	6-2
PHYSICAL DIMENSIONS AND WEIGHT .....	6-2
ENVIRONMENTAL CONSIDERATIONS .....	6-2
COOLING .....	6-3
REGULATORY COMPLIANCE .....	6-3
POWER SOURCE INTERRUPTIONS .....	6-4
MEAN TIME BETWEEN FAILURE .....	6-4
POWER DRAW SPECIFICATIONS .....	6-5
PINOUTS AND SIGNALLING .....	6-6
CABLE SPECIFICATIONS .....	6-7
POWER CORDS .....	6-9
WARRANTY .....	6-9
POWER SUPPLY SPECIFICATIONS .....	6-9
OVERVIEW .....	6-9
KEY FEATURES .....	6-10
PHYSICAL DIMENSIONS AND WEIGHT .....	6-10
ENVIRONMENTAL CONSIDERATIONS .....	6-10
POWER SUPPLY CONSUMPTION .....	6-11
INPUT CONNECTOR AND PLUG .....	6-12
REGULATORY COMPLIANCE .....	6-13
SAFETY WARNINGS .....	6-13
ELECTRICAL SPECIFICATIONS .....	6-14

## CHAPTER 7

### **MAINTAINING THE FASTIRON GS HARDWARE ..... 7-1**

HARDWARE MAINTENANCE SCHEDULE .....	7-1
REPLACING A POWER SUPPLY .....	7-1
INSTALLATION PRECAUTIONS AND WARNINGS .....	7-2
DETERMINING WHICH POWER SUPPLY FAILED .....	7-2
AC POWER SUPPLIES .....	7-2
DC POWER SUPPLIES .....	7-5
INSTALLING OR REPLACING A 2-PORT 10-GbE MODULE .....	7-9
REMOVING A 2-PORT 10-GbE MODULE .....	7-9
INSTALLING A 2-PORT 10-GbE MODULE .....	7-9
INSTALLING OR REPLACING A POE DAUGHTER CARD .....	7-10
DISASSEMBLING THE CHASSIS .....	7-11
INSTALLING A POE DAUGHTER CARD .....	7-12

RE-ASSEMBLING THE CHASSIS .....	7-14
REPLACING A FIBER OPTIC MODULE .....	7-15
REMOVING A FIBER OPTIC MODULE .....	7-15
INSTALLING A NEW FIBER OPTIC MODULE .....	7-16
CABLING A FIBER OPTIC MODULE .....	7-16
CLEANING THE FIBER-OPTIC CONNECTORS .....	7-16
DIGITAL OPTICAL MONITORING .....	7-17

## **APPENDIX A**

### **REGULATORY STATEMENTS .....A-1**

U.S.A. ....	A-1
INDUSTRY CANADA STATEMENT .....	A-1
EUROPE AND AUSTRALIA .....	A-1
JAPAN .....	A-1

## **APPENDIX B**

### **CAUTIONS AND WARNINGS.....B-1**

CAUTIONS .....	B-1
WARNINGS .....	B-6

---

# Chapter 1

## About This Guide

### Introduction

This guide describes the following FastIron GS® (FGS) Compact Layer 2 POE (Power over Ethernet) and POE-upgradeable switches from Foundry Networks:

- FGS624P-POE – 24-port POE
- FGS624P – 24-port POE-upgradeable
- FGS624XGP – 24-port POE-upgradeable with 1-port 10-GbE (new in release 02.5.00)
- FGS624XGP-POE – 24-port POE with 1-port 10-GbE (new in release 02.5.00)
- FGS648P-POE – 48-port POE
- FGS648P – 48-port POE-upgradeable

This guide includes procedures for installing the hardware and configuring essential, basic parameters such as permanent passwords and IP addresses. The basic software configuration procedures show how to perform tasks using the CLI. This guide also includes instructions for managing and maintaining the hardware.

### What's Included in This Edition?

This edition includes the following FastIron GS releases:

- 02.5.00
- 02.4.00
- 03.0.00

### Audience

This guide is designed for network installers, system administrators, and resellers who will install the FGS hardware. This guide assumes a working knowledge of Layer 2 switching.

### Nomenclature

This guide uses the following typographical conventions to show information:

*Italic* highlights the title of another publication and occasionally emphasizes a word or phrase.

**Bold** highlights a CLI command.

***Bold Italic*** highlights a term that is being defined.

---

**NOTE:** A note emphasizes an important fact or calls your attention to a dependency.

---

---

**CAUTION:** A caution calls your attention to a possible hazard that can damage equipment.

---

---

**WARNING:** A warning calls your attention to a possible hazard that can cause injury or death.

---

## Related Publications

The following Foundry Networks documents supplement the information in this guide.

- *Foundry FastIron Configuration Guide* – for FastIron Edge Switch X Series (FESX), FastIron SuperX Switch (FSX), FastIron SX 800, FastIron SX 1600, FastIron Workgroup Switch X Series (FWSX), and FastIron GS (FGS), provides configuration procedures for system-level features, Layer 2 features, and configuration information for Layer 3 enterprise routing protocols including IP, RIP, IP multicast, OSPF, BGP4, VRRP and VRRPE. This guide also provides procedures for securing management access to Foundry devices and for protecting against Denial of Service (DoS) attacks.
- *Foundry Management Information Base Reference* – contains the Simple Network Management Protocol (SNMP) Management Information Base (MIB) objects supported on Foundry devices.
- Release Notes for the FastIron GS Switch (FGS) – describes features introduced in each software release, lists features that are supported on the FGS, and describes how configuration procedures or defaults differ from those on other Foundry devices, due to the FGS's hardware architecture.

To order additional copies of these manuals, do one of the following:

- Call 1.877.TURBOCALL (887.2622) in the United States or 1.408.207.1600 outside the United States.
- Send email to [info@foundrynet.com](mailto:info@foundrynet.com).

---

**NOTE:** For the latest edition of this document, which contains the most up-to-date information, see [kp.foundrynet.com](http://kp.foundrynet.com).

---

## How to Get Help

Foundry Networks technical support will ensure that the fast and easy access that you have come to expect from your Foundry Networks products will be maintained.

### Web Access

- [kp.foundrynet.com](http://kp.foundrynet.com)

### Email Access

Technical requests can also be sent to the following email address:

- [support@foundrynet.com](mailto:support@foundrynet.com)

### Telephone Access

- 1.877.TURBOCALL (887.2622) United States
- 1.408.207-1600 Outside the United States

## Warranty Coverage

Contact Foundry Networks using any of the methods listed above for information about the standard and extended warranties.



---

# Chapter 2

## Product Overview

This chapter contains the following information:

- “Product Overview” on page 2-1
- “Software Features” on page 2-2
- “Hardware Features” on page 2-2

### Product Overview

This chapter contains an overview of the following Foundry Networks FastIron GS® (FGS) products:

- FGS624P-POE – 24-port POE
- FGS624P – 24-port POE-upgradeable
- FGS624XGP – 24-port POE-upgradeable with 1-port 10-GbE (new in release 02.5.00)
- FGS624XGP-POE – 24-port POE with 1-port 10-GbE (new in release 02.5.00)
- FGS648P-POE – 48-port POE
- FGS648P – 48-port POE-upgradeable

The FGS provides high port density within a compact form factor. All devices provide 128 MB of SDRAM when shipped from the factory.

You can order the FGS with or without *Power over Ethernet* (POE) installed. If you order a POE-upgradeable device, you can later upgrade your device to a POE device.

The FGS delivers a full complement of standards-based, feature-rich Layer 2 switching and Base Layer 3 capability. The extensive feature set supports network requirements ranging from basic connectivity to multicast-enabled full streaming audio and video applications for converged services such as Voice over IP (VoIP).

The FGS, together with Foundry's FastIron X Series devices, provide an integral range of network connectivity within the entire enterprise network. The FGS provides high port density and Gigabit Ethernet (GbE) uplinks in a compact form factor. All models optionally support two 10-GbE uplink ports. The FGS624XGP and FGS624XGP-POE, introduced in release 02.5.00, come with one 10-GbE uplink port.

The POE devices provide electrical power over existing Ethernet cables, supporting the need for integrated data, voice, and video applications.

## Software Features

Software features differ depending on the software version that is loaded on the device. When first shipped, the FGS devices support full Layer 2 Switching and Base Layer 3 Switching.

For a complete list of software features supported on the FGS, see the release notes or the *Foundry FastIron Configuration Guide*.

## Hardware Features

This section describes the physical characteristics of Foundry's FGS models. For details about physical dimensions, power supply specifications, and pinouts, see the chapter "Hardware Specifications" on page 6-1.

### FGS624P and FGS624P-POE

The FGS624P is POE-upgradeable. You can upgrade it by installing a POE daughter card.

The FGS624P-POE already has the POE daughter card installed.

Figure 2.1 shows the FGS624P and FGS624P-POE.

**Figure 2.1 FGS624P and RGS624P-POE**

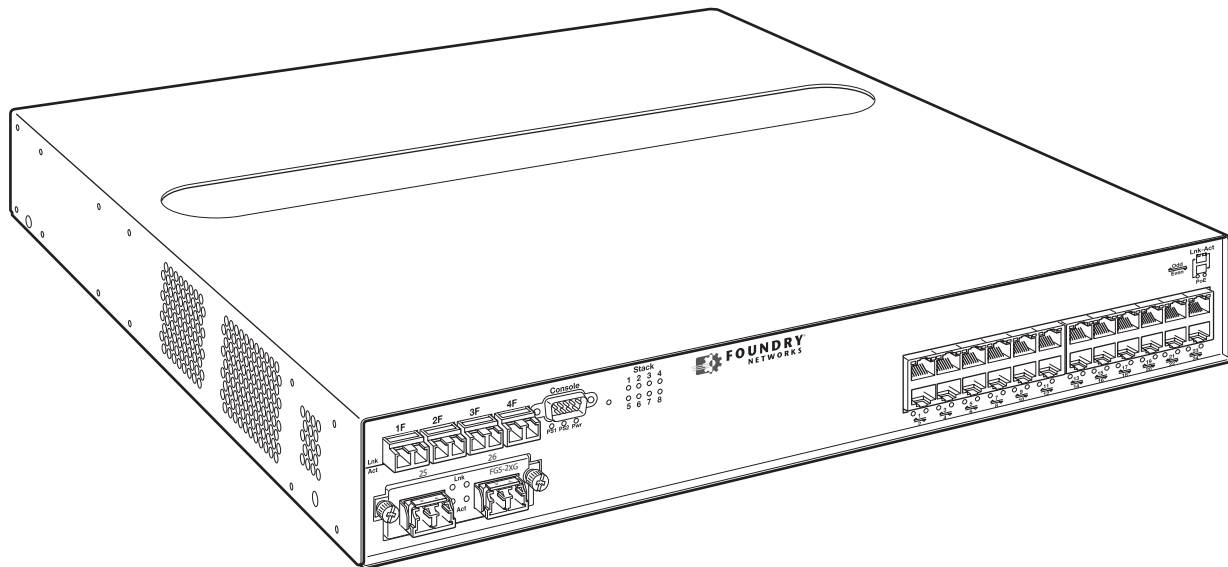

The FGS624P and FGS624P-POE have the following ports:

- 24 10/100/1000 Mbps Copper ports that support 100Base-TX and 1000Base-T RJ-45 connectors
- Four Gigabit Fiber ports for mini-GBIC optical transceivers (also called Small Form Factor Pluggable (SFP) MultiSource Agreement (MSA)-compliant optical transceivers)

Note that ports 1 – 4 of the copper ports and 1F – 4F of the fiber ports are combination ports, meaning either the copper port or its corresponding fiber port can be active at a time. For example, for copper port 1 and fiber port 1F, only one of these ports can be active at any given time. The same applies to copper port 2 and fiber port 2F, and so forth. You can use a combination of fiber and copper ports or all four copper or all four fiber ports, as needed. For more information, see "Combination Ports" on page 2-7.

- Optionally, two 10-GbE ports. See "10 Gbps Ports" on page 2-7.

## FGS624XGP and FGS624XGP-POE

The FGS624XGP is POE-upgradeable. You can upgrade it by installing a POE daughter card.

The FGS624XGP-POE already has the POE daughter cards installed.

Figure 2.2 shows the FGS624XGP and FGS624XGP-POE.

**Figure 2.2 FGS624XGP and FGS624XGP-POE**

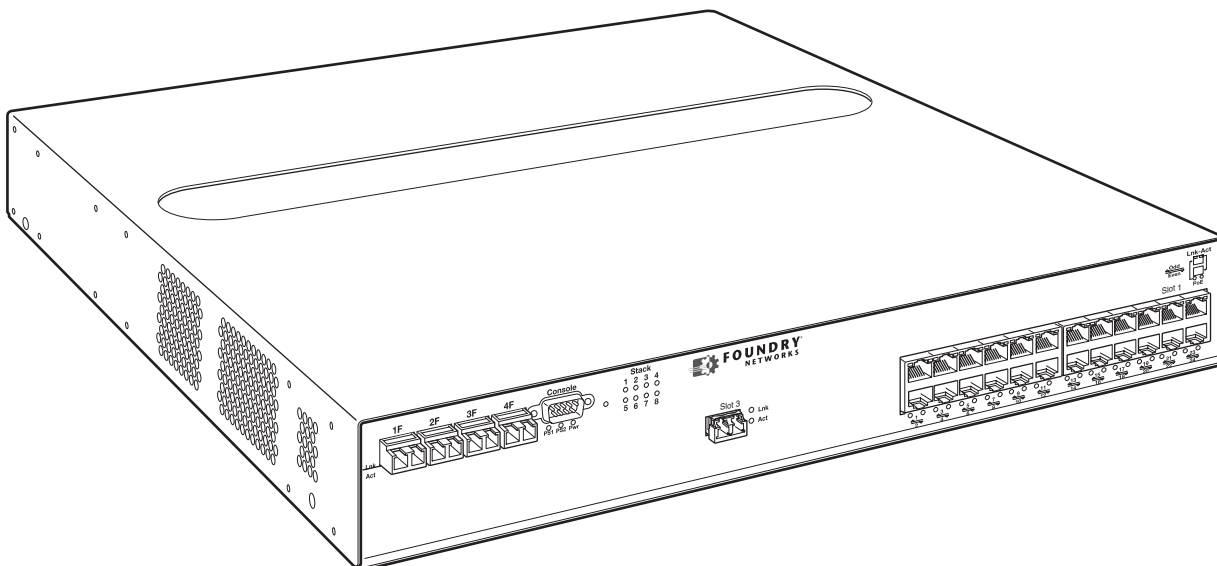

The FGS624XGP and FGS624XGP-POE have the following ports:

- 24 10/100/1000 Copper ports that support 100Base-TX and 1000Base-T RJ-45 connectors
- Four Gigabit Fiber uplink ports (1F – 4F) for mini-GBIC optical transceivers (also called Small Form Factor Pluggable (SFP) Multisource Agreement (MSA)-compliant optical transceivers)

Note that ports 1 – 4 of the copper ports and 1F – 4F of the fiber ports are combination ports, meaning either the copper port or its corresponding fiber port can be active at a time. For example, for copper port 1 and fiber port 1F, only one of these ports can be active at any given time. The same applies to copper port 2 and fiber port 2F, and so forth. You can use a combination of fiber and copper ports or all four copper or all four fiber ports, as needed. For more information, see “Combination Ports” on page 2-7.

- One built-in 10-GbE port. See “10 Gbps Ports” on page 2-7.
- Optionally, two additional 10-GbE ports. See “10 Gbps Ports” on page 2-7.

## FGS648P and FGS648P-POE

The FGS648P is POE-upgradeable. You can upgrade it to a POE device by installing one or two POE daughter cards. A single POE daughter card supports 24 POE ports. Two POE daughter cards support 48 POE ports.

The FGS648P-POE already has the POE daughter cards installed.

Figure 2.3 shows the FGS648P and FGS648P-POE.

**Figure 2.3 FGS648P and FGS648P-POE**

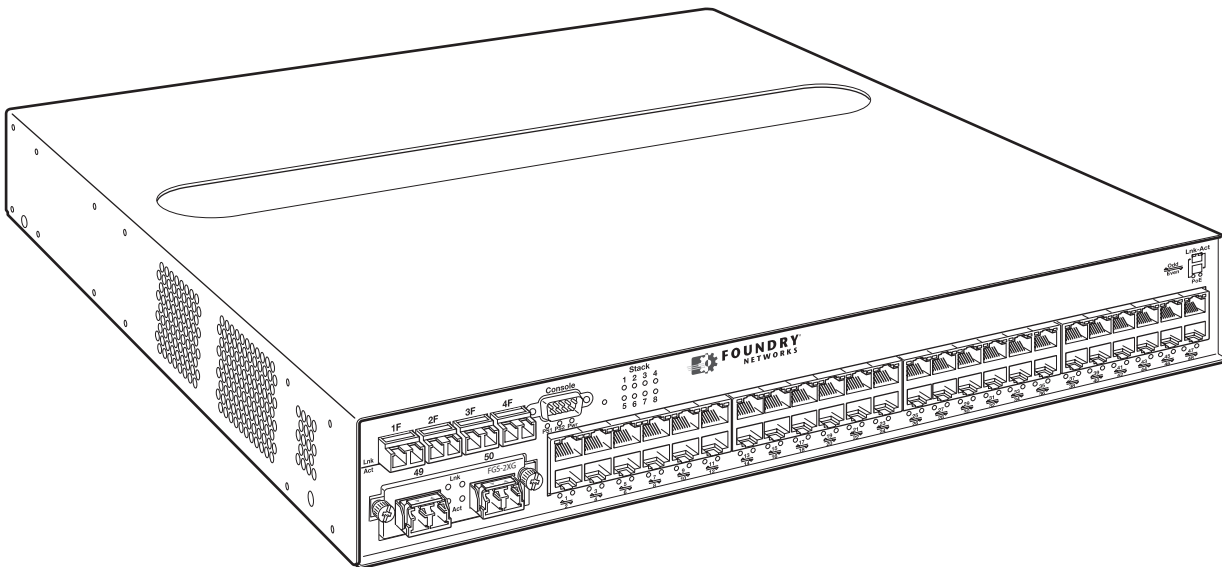

The FGS648P and FGS648P-POE have the following ports:

- 48 10/100/1000 Copper ports that support 100Base-TX and 1000Base-T RJ-45 connectors
- Four Gigabit Fiber uplink ports (1F – 4F) for mini-GBIC optical transceivers (also called Small Form Factor Pluggable (SFP) Multisource Agreement (MSA)-compliant optical transceivers)

Note that ports 1 – 4 of the copper ports and 1F – 4F of the fiber ports are combination ports, meaning either the copper port or its corresponding fiber port can be active at a time. For example, for copper port 1 and fiber port 1F, only one of these ports can be active at any given time. The same applies to copper port 2 and fiber port 2F, and so forth. You can use a combination of fiber and copper ports or all four copper or all four fiber ports, as needed. For more information, see “Combination Ports” on page 2-7.

- Optionally, two 10-GbE ports. See “10 Gbps Ports” on page 2-7.

## Control Features

Each device’s front panel has the following control features:

- Serial management interface (the port labeled **Console**)
- Reset button
- 10/100/1000 ports with RJ-45 copper connectors
- 100/1000 ports with mini-GBIC slots for SFP MSA-compliant fiber transceivers
- The FGS624XGP and FGS624XGP-POE have one 10-Gigabit Ethernet port for XFP MSA compliant fiber connector(s)
- Optionally, two 10 Gigabit Ethernet ports for XFP MSA-compliant fiber connectors
- LEDs for ports, power supplies, and stacking<sup>1</sup>

1.Reserved for possible use in the future.

Figure 2.4 shows the front panel of the FGS624P and FGS624P-POE.

**Figure 2.4 FGS624P and FGS624P-POE Front Panel**

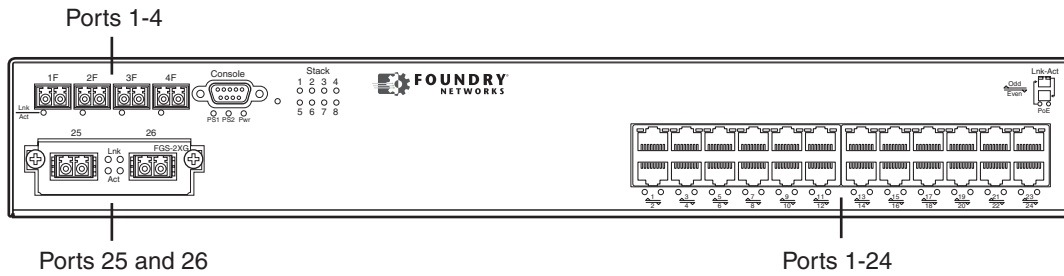

Figure 2.5 shows the front panel of the FGS648P and FGS648P-POE.

**Figure 2.5 FGS648P and FGS648P-POE Front Panel**

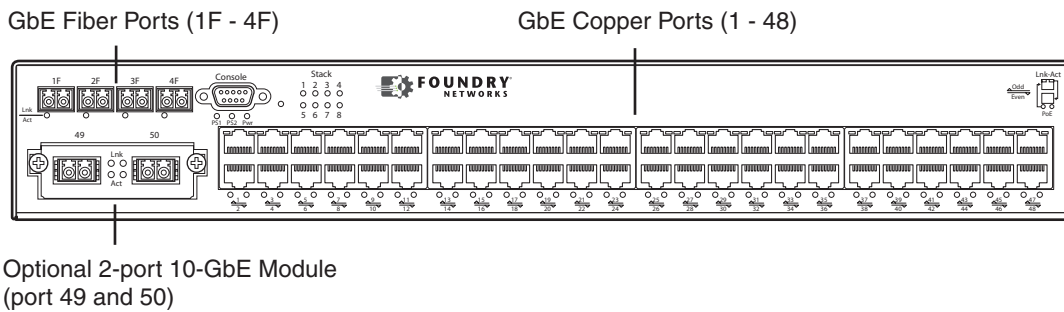
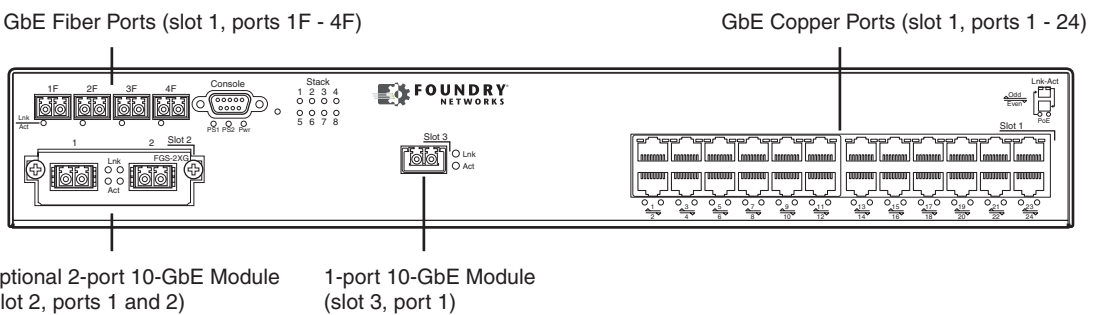

Figure 2.6 shows the front panel of the FGS624XGP and FGS624XGP-POE.

**Figure 2.6 FGS624XGP and FGS624XGP-POE Front Panel**



**Serial Management Interface (Console Port)**

The serial management interface (the port labelled **Console**) enables you to configure and manage the device using a third-party terminal emulation application on a directly connected PC. A straight-through EIA/TIA DB-9 serial cable (M/F) ships with the device. The serial management interface is located in the left corner of the front panel.

## Reset Button

The reset button allows you to restart the system without switching the power supplies off and on or using the CLI or Web management interface. The button is located to the right of the serial management interface and is recessed to prevent it from being pushed accidentally.

## Network Interfaces

Table 2.1 describes the network interfaces supported on the FGS devices. For network interface specifications, see Table 6.7 on page 6-7.

**Table 2.1: Network Interfaces**

Interface	Show Media Description
1000Base-BX-D	M-GBXD
1000Base-BX-U	M-GBXU
1000Base-LHA	M-LHA
1000Base-LHB	M-LHB
1000Base-LX	M-LX
1000Base-SX	M-SX
1000Base-SX2	M-SX2
1000Base-T	C
100Base-BX	M-FBX
100Base-FX	M-FX
10GBase-ER	XG-ER
10GBase-LR	XG-LR
10GBase-SR	XG-SR
10GBase-ZR	XG-ZR
10GBase-ZRD	XG-ZRD
CX4 10GbE module	CX4
10GbE XFP and CX4 module	CX4
1310-MMF 10GbE	1310-NM

### Viewing the Media Types Installed in the Ports

The output of the **show media** command displays the type of media (copper or fiber) installed in the ports. The output differs between devices running software release 02.4.00 and release 02.5.00 or later. Starting in software release 02.5.00, the software uses a stacking nomenclature.

The following shows an example of the **show media** output in pre-release 02.5.00.

```
FastIron(config)# show media
1:M-GBXD 2:M-LHB 3:M-FBX 4:M-SX2 5: C 6: C 7: C 8: C 9: C 10: C 11: C 12: C 13:
C 14: C 15: C 16: C 17: C 18: C 19: C 20: C 21: C 22: C 23: C 24: C 25:XG-ZR
1550.0 nm 26:XG-SR 27:
```

The following shows an example of the **show media** output in release 02.5.00 and later.

```
FastIron(config)# show media
0/1/1:M-SX 0/1/2: C 0/1/3: C 0/1/4: C 0/1/5: C 0/1/6: C 0/1/7: C 0/1/8: C 0/1/9:
C 0/1/10: C 0/1/11: C 0/1/12: C 0/1/13: C 0/1/14: C 0/1/15: C 0/1/16: C 0/1/17:
C 0/1/18: C 0/1/19: C 0/1/20: C 0/1/21: C 0/1/22: C 0/1/23: C 0/1/24: C
0/2/1: XG-LMR 0/2/2: 1310-NM
```

The "Show Media Description" column in Table 2.1 shows the text that displays in the output of the **show media** command for each connector type.

### 10/100/1000 Mbps Ports

The 10/100/1000 copper ports use auto-sensing and auto-negotiating to determine the speed (10 Mbps, 100 Mbps, or 1000 Mbps) and mode (full-duplex or half-duplex) of the port at the other end of the link and adjust port speed accordingly.

10/100/1000 ports on the FGS devices support RJ-45 copper connectors. The output of the **show media** command displays **C** next to the ports that have copper connectors installed.

Gigabit copper ports on the FGS models support auto MDI/MDIX detection. For more information about this feature, see "Configuring MDI/MDIX" in the *Foundry FastIron Configuration Guide*.

### 100/1000 Mbps Ports

The 100/1000 fiber ports (ports 1F – 4F) on the FGS devices support the SFP fiber connectors listed in Table 2.1.

### Combination Ports

Ports 1 – 4 of the copper ports and 1F – 4F of the fiber ports are combination ports, meaning either the copper port or its corresponding fiber port can be active at a time. For example, for copper port 1 and fiber port 1F, only one of these ports can be active at any given time. The same applies to copper port 2 and fiber port 2F, and so forth. You can use a combination of fiber and copper ports or all four copper or all four fiber ports, as needed.

If you attach both the copper and fiber connectors for a port to the network, the fiber connectors take precedence over the copper connectors. These ports support *true media automatic detection*, meaning the device will select the fiber or copper connector based on link availability. If a fiber link cannot be established, the device will select the copper media.

### 10 Gbps Ports

This section describes the 10-GbE modules

#### 1-Port 10-GbE Module

The 1-port 10-GbE module is installed in the FGS624XGP and FGS624XGP-POE (shown in Figure 2.4). This module is factory-installed only. It is not a field-upgradeable module. This module is a 10-GbE fiber uplink for 10-Gigabit Small Form Factor Pluggable (XFP) MSA-compliant optical transceiver.

Figure 2.7 shows the 1-port 10-GbE module. This port supports the 10-GbE connector types (10GBase) listed in Table 2.1.

**Figure 2.7** 1-port 10-GbE Module

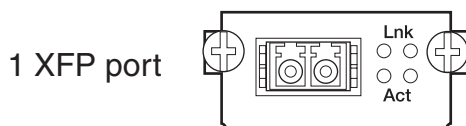

#### 2-port 10-GbE Module

The 2-port 10-GbE module on the FGS is optional. You can order the FGS with one of these 2-port 10-Gigabit module installed at the factory, or you can later upgrade your device.

The following 2-port 10-Gigabit Ethernet module is supported:

- 2-port 10-GbE fiber uplinks for 10-Gigabit Small Form Factor Pluggable (XFP) MSA-compliant optical

transceivers (part number FGS-2XG).

Figure 2.8 shows the 2-port 10-GbE module. These ports support the 10-GbE connector types (10GBase) listed in Table 2.1.

**Figure 2.8 2-port 10-GbE Module**

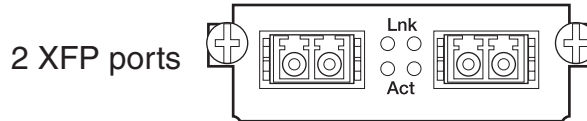

### 10 Gbps CX4 and XFP Ports

This section describes the 10-GbE CX4 modules.

#### 2-port CX4 Module (Release 02.6.00)

The 2-port CX4 module on the FGS is optional. You can order the FGS with a 2-port CX4 module installed at the factory, or you can later upgrade your device.

The following 2-port CX4 module is supported:

- 2-port CX4 uplinks for 10-Gigabit Small Form Factor Pluggable (XFP) MSA-compliant optical transceivers (part number FGS-2XGC).

When this module is installed, the **show media** command returns the following display:

```
FGS648 Switch#sh media
0/2/1: CX4 0/2/2: CX4
```

#### 2-port 10-GbE Hybrid Interface Module (Release 02.6.00)

The 2-port 10-GbE hybrid interface module contains a CX4 port and an XFP port. You can order the FGS with one a 2-port hybrid module installed at the factory, or you can later upgrade your device.

The following 2-port 10-GbE hybrid interface module is supported:

- 2-port 10-GbE hybrid uplinks; one for a 10-Gigabit Small Form Factor Pluggable (XFP) MSA-compliant optical transceiver and one for a 2-port CX4 10-Gigabit Small Form Factor Pluggable (XFP) MSA-compliant optical transceiver (part number FGS-1XG1XGC).

When this module is installed, the **show media** command returns the following display:

```
FGS648 Switch#sh media
0/2/1:<depends on transceiver installed> 0/2/2: CX4
```

#### 10GbE XFP Transceiver (FGS624XGP Models Only)

Release 02.6.00 introduced support for a 10GbE XFP transceiver specifically in port 1, slot 3..

The following 2-port CX4 module is supported:

- 2-port CX4 uplinks for 10-Gigabit Small Form Factor Pluggable (XFP) MSA-compliant optical transceivers (part number FGS-2XGC).

Link and Activity LEDs on the module faceplates indicate operational status:

- If the Lnk LED is on, the port is connected. If the Lnk LED is off, no connection exists, or the link is down.
- If the Act LED is on or blinking, traffic is being transmitted and received on the port. If the Act LED is off, no traffic is being transmitted or received on the port.

Figure 2.9 shows the faceplates of both modules:



Figure 2.9 2-port CX4 10GbE Module and 10GbE and CX4 Module

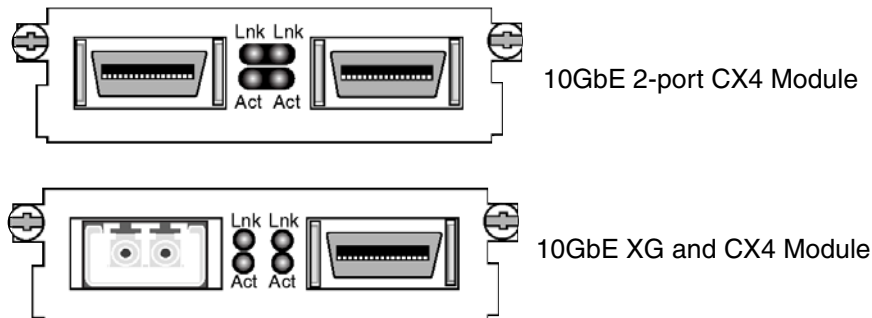

### Cable Specifications for New Optics Modules

The following cable specifications apply to the CX4 ports, which are included in the new 10GbE interface modules (FGS-2XGC and FGS-1XG1XGC):

- Support for 802.3ak or 10 Gigabit Ethernet CX4 standard
- Support of up to 15m in length
- Requires latch-style receptacle or SFF-8470 plug
- Recommended CX4 cable: Manufactured by WL Gore, part number IBN6600-15, CX4 Assembly - 26AWG SPC 15.0m

### CX4 10Gbps XFP Transceiver

This release introduces a twin-axial 10G copper CX4 XFP transceiver that can be installed in any 10G port. For a link to operate properly, both sides must use identical CX4 transceivers.

The **show media** command identifies the CX4 as XG-CX4 as shown here:

```
FGS624P Switch#sh media
0/1/1: C 0/1/2:M-SX 0/1/3: C 0/1/4: C 0/1/5: C 0/1/6: C 0/1/7: C 0/1/8: C 0/1/9:
C 0/1/10: C 0/1/11: C 0/1/12: C 0/1/13: C 0/1/14: C 0/1/15: C 0/1/16: C 0/1/17:
C 0/1/18: C 0/1/19: C 0/1/20: C 0/1/21: C 0/1/22: C 0/1/23: C 0/1/24: C
0/2/1:XG-SR 0/2/2:XG-SR 0/3/1:XG-CX4
```

The CX4 transceiver requires a 15 meter CX4-grade cable, which may be purchased from Foundry Networks. Refer to part number CAB-CX4-0050 when ordering.

Figure 2.10 shows the CX4 transceiver. Figure 2.11 shows the CX4-grade cable.

Figure 2.10 CX4 Transceiver

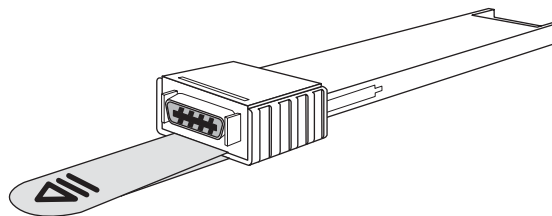
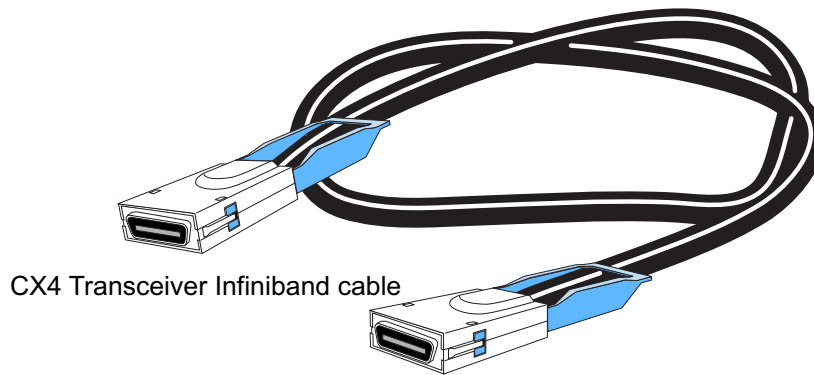

Figure 2.11 CX4 Transceiver Cable



### LEDs for Network Interfaces and Power Supplies

The fiber and copper ports on the FGS provide status information using the LEDs listed in Table 2.2.

- The 10/100/1000 copper ports (1 – 24 or 1 – 48) use the LEDs located on the top left and top right of the upper copper connectors. The LEDs are combined Link/Activity (Lnk/Act) LEDs. The LED on the left side is for the upper copper connector. The LED on the right side is for the lower copper connector.
- The 100/1000 fiber ports (1F – 4F) use the LEDs located beneath the fiber connectors. The LEDs are combined Link/Activity (Lnk/Act) LEDs.
- The POE ports (1 – 24) use the round LEDs located beneath the copper ports. The first (left-most) LED is for port 1, the second LED is for port 2, the third LED is for port 3, and so forth.
- The 10 Gbps fiber ports use the LEDs located beside them.
- The FastIron GS with stacking<sup>1</sup> use the Stack LEDs (1 – 8) located to the right of the console port.
- The power supplies use the Pwr, PS1, and PS2 LEDs on the left side of the front panel, beneath the console port.

**Table 2.2: LEDs**

LED	Position	State	Meaning
<b>10/100/1000 Copper Port LEDs</b>			
Lnk/Act	Located along the top of the copper ports  Left for upper copper connector  Right for lower copper connector	On	The link is up.
		Off	The link is down.
	Blinking	The port is transmitting and/or receiving traffic	
<b>100/1000 Fiber Port LEDs</b>			

1. Reserved for possible use in the future.

Table 2.2: LEDs (Continued)

LED	Position	State	Meaning
Lnk/Act	Bottom left	On	The link is up.
		Off	The link is down.
		Blinking	The port is transmitting and/or receiving traffic.
<b>10 Gbps Port LEDs</b>			
Lnk	Located beside the 10-GbE port. This is the top-most LED.	On	The port is connected.
		Off	No fiber port connection exists or the link is down.
Act	Located beside the 10-GbE port. This is the bottom-most LED.	On or Blinking	Traffic is being transmitted and/or received on the fiber port.
		Off	No traffic is being transmitted or received on the fiber port.
<b>POE Port LEDs</b>			
POE	Located along the bottom of the copper ports  Left for upper port  Right for lower port	On (Green)	The port is enabled, a power-consuming device has been detected, and the module is supplying power to the device.
		Off	The port is not providing in-line power.
<b>Power Supply LEDs</b>			
Power	Right-most LED beneath the console port	On	The device is powered on and has enough power to operate.
		Off	The device is not powered on, or has been powered on but does not have sufficient power to operate.
PS1	Left-most LED beneath the console port	On	Power supply 1 is installed and is functioning normally. Power supply 1 is located in the right-hand bay (when you are facing the rear of the device).
		Off	Power supply 1 is not installed or is not providing power.
PS2	Middle LED beneath the console port	On	Power supply 2 is installed and is functioning normally. Power supply 2 is located in the left-hand bay (when you are facing the rear of the device).
		Off	Power supply 2 is not installed or is not providing power.

Table 2.2: LEDs (Continued)

LED	Position	State	Meaning
<b>Stacking LEDs</b>			
Reserved for future use			

## Fiber Optic Modules

Table 6.7 in the chapter “Hardware Specifications” lists the types of fiber optic modules (SFPs and XFPs) supported on Foundry’s FGS devices.

Table 2.1 lists the description that displays in the output of the **show media** command for each media type.

## Power Supplies

Each FGS device comes with one alternating-current (AC) power supply (part number RPS-FGS) or direct-current (DC) power supply (part number RPSDC-FGS), depending on how it was ordered from the factory. All models have two power supply slots, enabling you to install a second power supply for redundancy (if applicable) or for additional POE power. You can use any combination of AC and DC supplies in the same device.

Figure 2.12 shows the AC power supply used with the FastIron GS.

Figure 2.12 RPS-FGS AC power supply

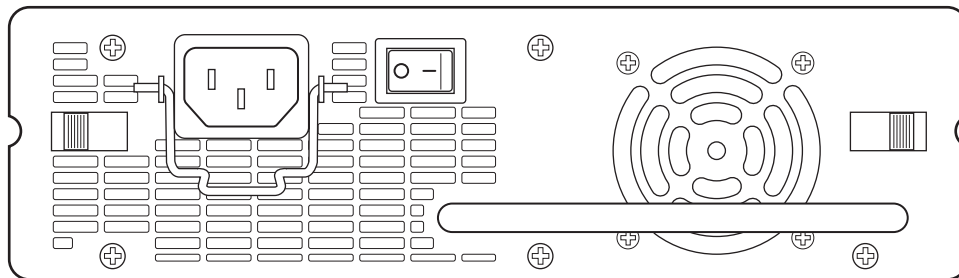
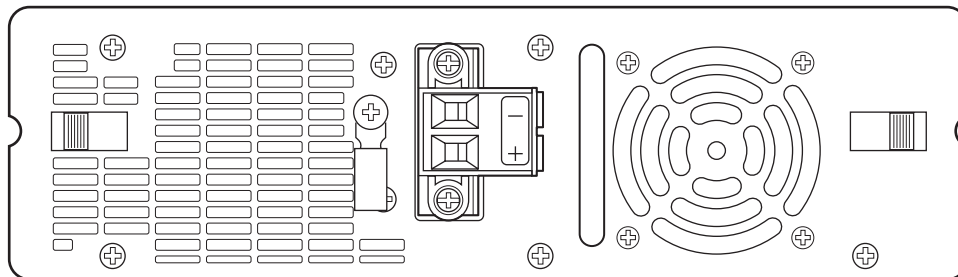

Figure 2.13 shows the DC power supply used with the FastIron GS.

Figure 2.13 RPSDC-FGS DC power supply



The power supplies are auto-sensing and auto-switching. The supplies provide 600 watts of total output power, including +12VDC @ 10A to the system and -48VDC @ 10A for Power over Ethernet applications. The supplies provide 100-240 VAC input, 50-60Hz @ 8A to 3.2A.

The power supplies can be swapped in or out of the device while the device is running. You can remove and insert a power supply without opening the chassis. If the device contains redundant power supplies, you can remove

one of the supplies without interrupting operation. The remaining redundant supply provides enough power for all the ports.

For power supply hardware specifications, see “Hardware Specifications” on page 6-1.

---

**NOTE:** A FastIron GS POE device with dual power supplies may not provide redundancy, depending on how much power the POE ports are consuming. See “Power Specifications for POE” on page 2-13.

---

---

**CAUTION:** Remove the power cord from a power supply before you install it in or remove it from the device. Otherwise, the power supply or the device could be damaged as a result. (The device can be running while a power supply is being installed or removed, but the power supply itself should not be connected to a power source.)

---

---

**CAUTION:** The FGS power supply is designed exclusively for use with the FGS devices. The power supply produces extensive power to support 802.3af applications. Installing the power supply in a device other than the FGS will cause extensive damage to your equipment.

---

### Power Specifications for POE

The actual implementation of the 802.3af standard limits power to 15.4W (44V to 57V) from the power sourcing device. This is in compliance with safety standards and existing wiring limitations. Though limited by the 802.3af standard, 15.4 watts of power is ample, as most powered devices consume an average of 5 to 12 watts of power. IP phones, wireless LAN access points, and network surveillance cameras each consume an average of 3.5 to 9 watts of power.

Foundry's 48-volt power supplies provide power to the POE daughter card, and ultimately to POE power-consuming devices. The number of POE power-consuming devices that one 48-volt power supply can support depends on the number of watts required by each power-consuming device. Each 48-volt power supply provides 480 watts of power for POE, and each POE port supports a maximum of 15.4 watts of power per POE power-consuming device. For example, if each POE power-consuming device attached to the FastIron GS consumes 12 watts of power, one 48-volt supply will power up to 40 POE ports. You can install a second 48-volt supply for additional POE power.

---

**NOTE:** If your FastIron GS POE chassis has 48 ports and only one power supply, and each POE-enabled port needs 15.4 watts, then a maximum of 31 ports can supply power to connected devices.

---

For power supply specifications, see “Hardware Specifications” on page 6-1. For POE configuration procedures, see the *Foundry FastIron Configuration Guide*.

### Precautions

The following precautions apply to the FastIron GS POE with 48 ports:

- If your FastIron GS POE chassis has 48 ports and two power supplies, and the POE ports are consuming more than 480 watts of power, a single power supply failure will cause both power supplies to shut down.
- If your FastIron GS POE chassis has 48 ports and only one power supply, and the power consuming devices connected to POE-enabled ports consume a total of more than 480 watts of power, the power supply may shut down.

### Cooling System and Fans

The FGS chassis has two single-speed fans that operate simultaneously. If one fan fails, it does not affect the operation of the other fan.



---

# Chapter 3

## Installing the FastIron GS Chassis

---

**WARNING:** The procedures in this manual are for qualified service personnel.

---

This chapter describes how to physically install the FastIron GS.

This chapter contains the following information:

- “Unpacking a System” on page 3-1
- “Summary of Installation Tasks” on page 3-2
- “Installation Precautions” on page 3-3
- “Installing an Additional Power Supply” on page 3-5
- “Installing the Device” on page 3-11
- “Powering On the System” on page 3-14
- “Verifying Proper Operation” on page 3-15
- “Attaching a PC or Terminal” on page 3-16

Information about configuring IP addresses and connecting network devices is in the chapter “Connecting Network Devices and Checking Connectivity” on page 4-1.

### Unpacking a System

Foundry systems ship with all of the following items. Please review the list below and verify the contents. If any items are missing, please contact the place of purchase.

#### Package Contents

- Foundry Networks FastIron GS POE or POE-upgradeable device with one AC or DC power supply installed
- 115V AC power cable (for AC sourced devices)
- Rack mount brackets and mounting screws
- CD-ROM containing software images and the user documentation (including this guide)
- Warranty card

#### General Requirements

To manage the system, you need the following items for serial connection to the switch or router:

- A management station, such as a PC running a terminal emulation application.
- A straight-through EIA/TIA DB-9 serial cable (F/F). This cable can be ordered separately from Foundry Networks. If you prefer to build your own cable, see the pinout information in “Attaching a PC or Terminal” on page 3-16.

You use the serial connection to perform basic configuration tasks such as assigning an IP address and network mask to the system. This information is required for managing the system using the Web management interface or IronView Network Manager, or using the CLI through Telnet.

## Summary of Installation Tasks

Follow the steps listed below to install your FGS device. Details for each of these steps are provided in this chapter and in the following chapter.

**Table 3.1: Summary of Installation Tasks**

Task No.	Task	Where to Find More Information
1	Ensure that the physical environment that will host the device has the proper cabling and ventilation.	“Preparing the Installation Site” on page 3-5
2	Optionally insert an additional power supply. If you need to install a power supply, it may be easier to install it before mounting the device, although power supplies are “hot swappable”, and can be installed or removed after the device is mounted and powered-on.  <b>CAUTION:</b> Remove the power cord from a power supply before you install or remove it from the device. Otherwise, the power supply or the device could be damaged. (The device can be running while a power supply is installed or removed, but the power supply itself must be disconnected from the power source.)	“Installing an Additional Power Supply” on page 3-5
4	Install the Foundry device on a desktop, in an equipment rack, or on the wall.	“Installing the Device” on page 3-11
5	When the device is installed, plug the power cord into a nearby power source that adheres to the regulatory requirements outlined in this manual.	“Powering On the System” on page 3-14
6	Verify that the system LEDs are registering the proper LED state after power-on of the system.	“Verifying Proper Operation” on page 3-15
7	Attach a terminal or PC to the Foundry device. This enables you to configure the device via the <i>Command Line Interface (CLI)</i> .	“Attaching a PC or Terminal” on page 3-16
8	No default password is assigned to the CLI. For additional access security, assign a password.	“Assigning Permanent Passwords” on page 4-1
9	Before attaching equipment to the device, you must configure an interface IP address to the subnet on which it will be located. Initial IP address configuration is performed using the CLI with a direct serial connection. Subsequent IP address configuration can be performed using the Web management interface.	“Configuring IP Addresses” on page 4-3



Table 3.1: Summary of Installation Tasks (Continued)

Task No.	Task	Where to Find More Information
10	Once you power on the device and assign IP addresses, the system is ready to accept network equipment.	"Connecting Network Devices" on page 4-4
11	Test IP connectivity by pinging other devices and tracing routes.	"Testing Connectivity" on page 4-6
12	Continue configuration using the CLI or the Web management interface. You also can use IronView Network Manager to manage the device. See the <i>Foundry IronView Network Management User's Guide</i> for information.	<i>Foundry FastIron Configuration Guide</i>
13	Secure access to the device.	<i>Foundry FastIron Configuration Guide.</i>

## Installation Precautions

Follow these precautions when installing a Foundry device.

### General Precautions

---

**WARNING:** All fiber-optic interfaces use Class 1 lasers.

---



---

**CAUTION:** Do not install the device in an environment where the operating ambient temperature might exceed 40° C (104° F).

---



---

**CAUTION:** Make sure the air flow around the front, sides, and back of the device is not restricted.

---



---

**CAUTION:** Never leave tools inside the chassis.

---

### Lifting Precautions

---

**WARNING:** Make sure the rack or cabinet housing the device is adequately secured to prevent it from becoming unstable or falling over.

---



---

**WARNING:** Do not use the handles on the power supply units to lift or carry a Foundry device.

---



---

**WARNING:** Mount the devices you install in a rack or cabinet as low as possible. Place the heaviest device at the bottom and progressively place lighter devices above.

---

## Power Supply Precautions

The following precautions apply to FastIron GS POE 48-port devices:

- If your FastIron GS POE chassis has 48 ports and only one power supply, and each POE-enabled port needs 15.4 watts, then a maximum of 31 ports can supply power to connected devices.
- If your FastIron GS POE chassis has 48 ports and two power supplies, and the POE ports are consuming more than 480 watts of power, a single power supply failure will cause both power supplies to shut down.
- If your FastIron GS POE chassis has 48 ports and only one power supply, and the power consuming devices connected to POE-enabled ports consume a total of more than 480 watts of power, the power supply may shut down.

---

**CAUTION:** Use a separate branch circuit for each AC power cord, which provides redundancy in case one of the circuits fails.

---

**CAUTION:** Ensure that the device does not overload the power circuits, wiring, and over-current protection. To determine the possibility of overloading the supply circuits, add the ampere (amp) ratings of all devices installed on the same circuit as the device. Compare this total with the rating limit for the circuit. The maximum ampere ratings are usually printed on the devices near the input power connectors.

---

**CAUTION:** All devices with DC power supplies are intended for installation in restricted access areas only. A restricted access area is where access can be gained only by service personnel through the use of a special tool, lock and key, or other means of security, and is controlled by the authority responsible for the location.

---

**CAUTION:** For a DC system (DC power supply part number RPSDC-FGS), use a grounding wire of at least 10 American Wire Gauge (AWG). The 10 AWG wire should be attached to an agency-approved crimp connector, crimped with the proper tool.

---

**CAUTION:** For the DC input circuit to the system (DC power supply part number RPSDC-FGS), make sure there is a Listed 30 amp circuit breaker, minimum -48Vdc, double pole, on the input to the terminal block. The input wiring for connection to the product should be Listed copper wire, 10 AWG, marked VW-1, and rated minimum 90 degrees celcius.

---

**CAUTION:** Make sure you insert the power supply right-side up. It is possible to insert the supply upside down, although the supply will not engage with the power backplane when upside down. The power supply is right-side up when the power connector is on the left and the fan vent is on the right.

---

**CAUTION:** Remove the power cord from a power supply before you install it in or remove it from the device. Otherwise, the power supply or the device could be damaged as a result. (The device can be running while a power supply is being installed or removed, but the power supply itself should not be connected to a power source.)

---

**CAUTION:** The FGS power supply is designed exclusively for use with the FGS devices. The power supply produces extensive power to support 802.3af applications. Installing the power supply in a device other than the FGS will cause extensive damage to your equipment.

---

**WARNING:** Disconnect the power cord from all power sources to completely remove power from the device.

---

**WARNING:** Make sure to choose the appropriate circuit device depending on the number of AC power supplies installed in the chassis. The minimum current draw for the system is one AC power supply.

---

---

**WARNING:** Power supplies are hot swappable. However, Foundry Networks recommends that you disconnect the power supply from AC power before installing or removing the supply. The device can be running while a power supply is being installed or removed, but the power supply itself should not be connected to a power source. Otherwise, you could be injured or the power supply or other parts of the device could be damaged.

---

**WARNING:** Make sure that the power source circuits are properly grounded, then use the power cord supplied with the device to connect it to the power source.

---

**WARNING:** If the installation requires a different power cord than the one supplied with the device, make sure you use a power cord displaying the mark of the safety agency that defines the regulations for power cords in your country. The mark is your assurance that the power cord can be used safely with the device.

---

## Preparing the Installation Site

### Cabling Infrastructure

Ensure that the proper cabling is installed in the site. See “Chassis Specifications” on page 6-2 or [www.foundrynetworks.com](http://www.foundrynetworks.com) for a summary of supported cabling types and their specifications.

### Installation Location

Before installing the device, plan its location and orientation relative to other devices and equipment. Allow at least 3" of space at the front of the device for the twisted-pair, fiber-optic, and power cabling. Also, allow a minimum of 3" of space between the sides and the back of the device and walls or other obstructions.

## Installing an Additional Power Supply

The FGS ships with one AC or DC power supply. If desired, you can install a second supply for added power or for redundancy (if applicable). The illustration below shows the rear panel of an AC power supply.

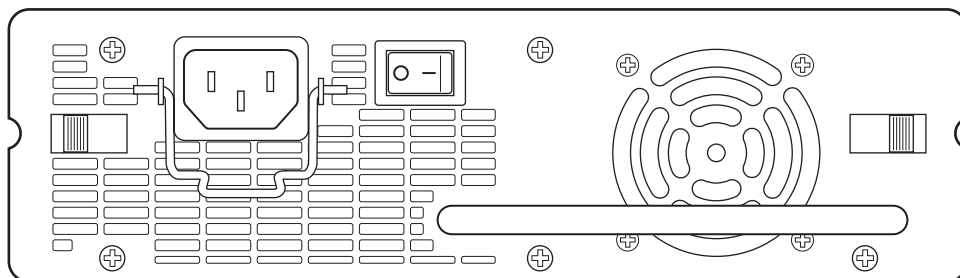

If you need to install a second power supply, it may be easier to install it before mounting the device, although the power supplies are “hot swappable” and can be installed or removed after the device is mounted and powered on.

---

**CAUTION:** Remove the power cord from a power supply before you install it in or remove it from the device. Otherwise, the power supply or the device could be damaged. The device can be running while a power supply is being installed or removed, but the power supply itself should be disconnected from the power source.

---

This section provides the following procedures:

- “Installing an AC Power Supply” on page 3-6
- “Installing a DC Power Supply” on page 3-8

You will need the following tools to perform these procedures:

- #2 Phillips-head screwdriver

## Installing an AC Power Supply

---

**WARNING:** Before beginning the installation, see the precautions in “Power Supply Precautions” on page 3-4.

---

Use the following procedures for installing AC power supplies in the FastIron GS.

To install an AC power supply, do the following:

1. If necessary, remove the power supply locking screw located in the center rear of the device (illustrated below).
2. If the empty power supply bay has a cover plate, press inward on the two latches near the left and right edges of the cover plate to unlock the plate (illustrated below), then remove the plate.

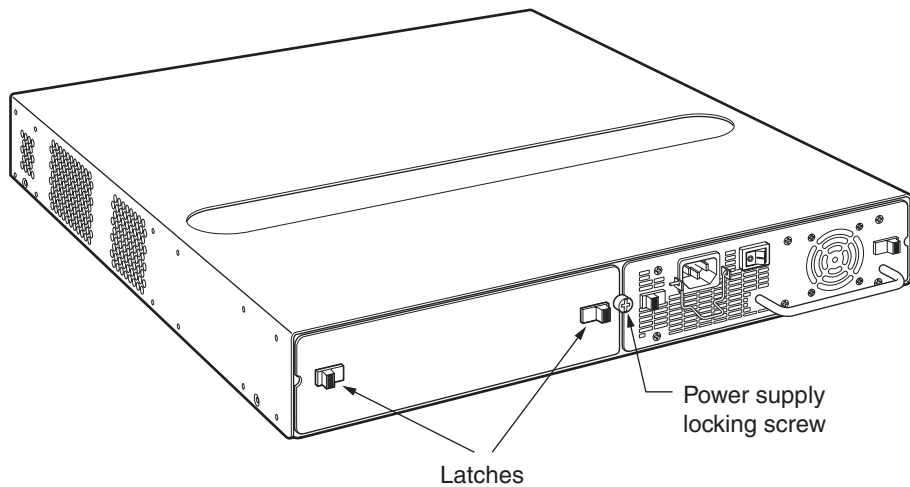

3. Remove the new power supply from its packaging.

4. With one hand, hold the bar on the front panel of the power supply. With the other hand, support the underside of the power supply, and insert the power supply into the empty power supply slot. Press until the supply is completely in the slot, so that the connectors on the back of the supply fully engage with the pins on the power backplane.

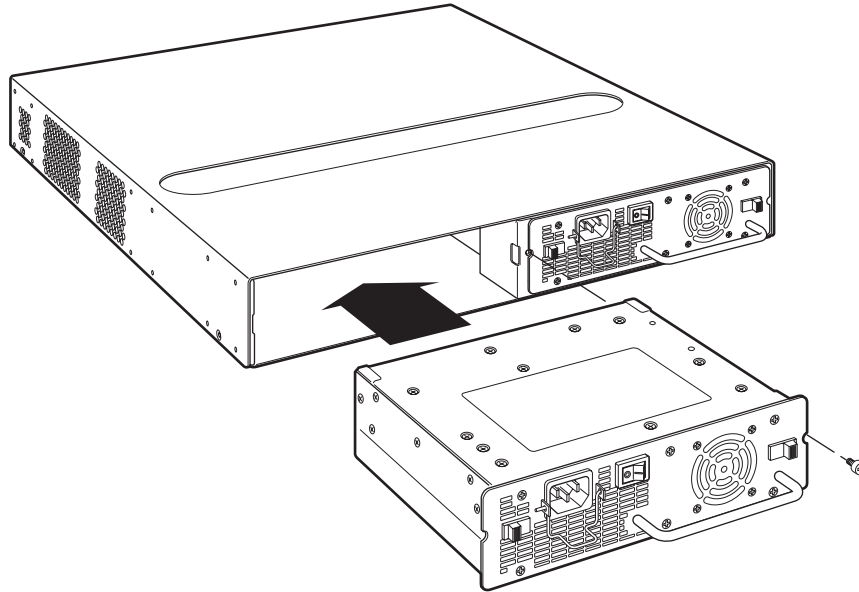

---

**CAUTION:** Make sure you insert the power supply right-side up. It is possible to insert the supply upside down, although the supply will not engage with the power backplane when upside down. The power supply is right-side up when the power connector is on the left and the fan vent is on the right.

---

5. Press the two latches near the edges of the supply outward to lock the supply in place.
6. Replace the power supply locking screw.
7. Install the power cord, as shown below.

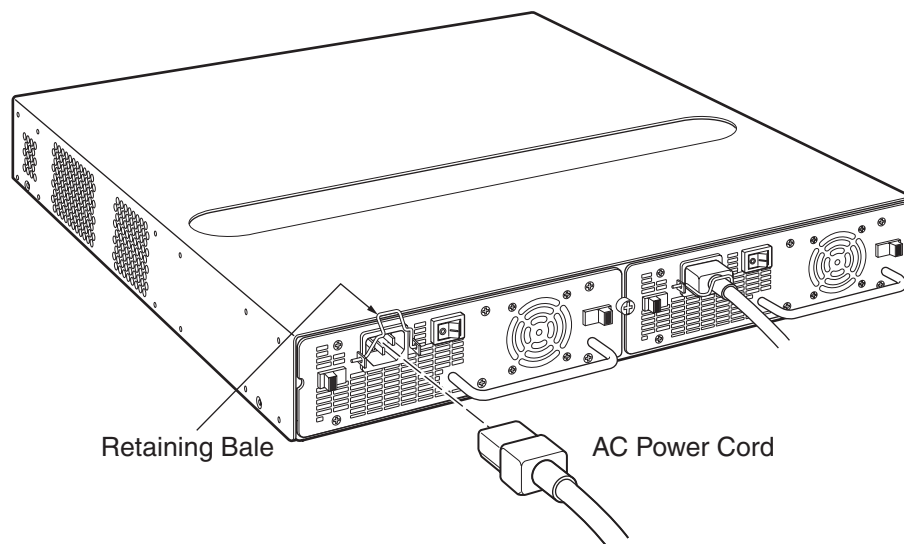

## Installing a DC Power Supply

Use the following procedures for installing DC power supplies in the FastIron GS. The following illustration shows the front panel of a DC power supply.

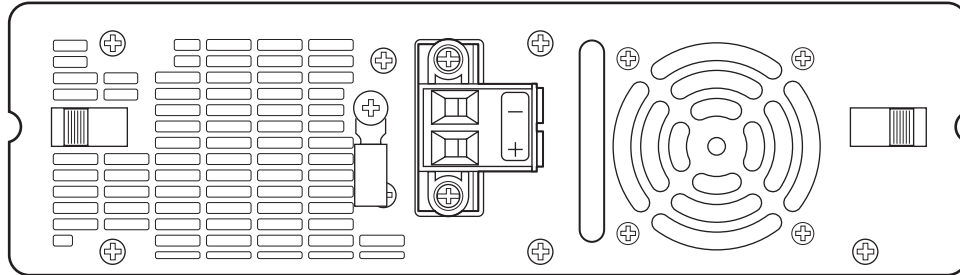

**WARNING:** Before beginning the installation, see the precautions in “Power Supply Precautions” on page 3-4.

1. If necessary, before installing a power supply, remove the power supply locking screw located in the center rear of the device (illustrated below on an AC chassis).

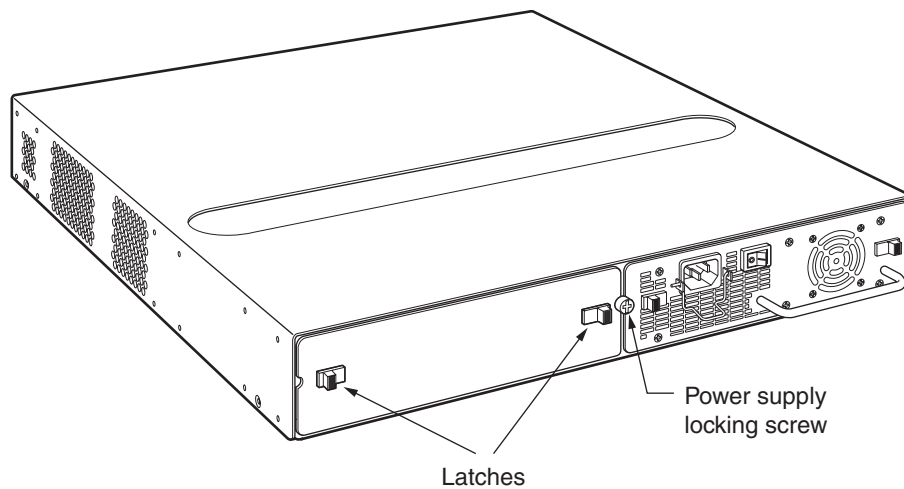

2. If the empty power supply bay has a cover plate, unlock it by pressing inward on the two latches near the left and right edges of the cover plate (illustrated above), then remove the plate.
3. Remove the new power supply from its packaging.
4. Prepare the positive, negative, and ground wires by stripping about 1/4" of insulation off the end of each one. (Use 10 AWG wire.)
5. Loosen the three screws used to hold the wires in the connectors. These are located under the following markings and shown in the illustration below:

— + ⊕

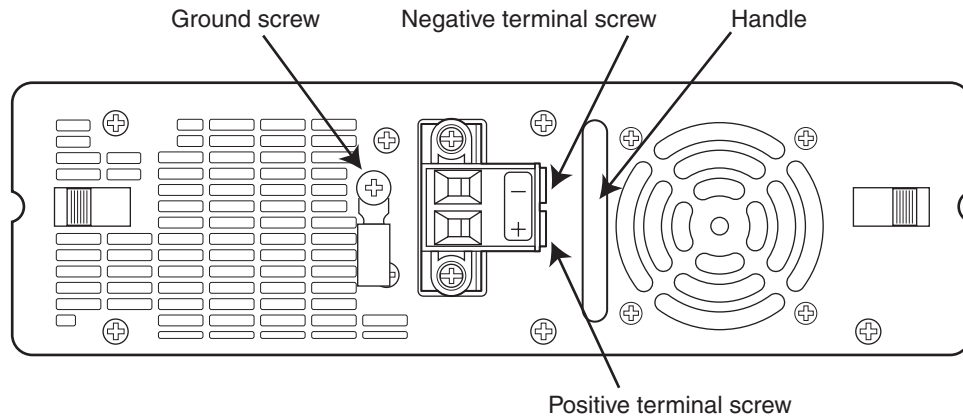

**NOTE:** The handle on the front panel of the power supply may block access to the negative and positive terminal screws. You may need to temporarily remove the receptacle for the positive and negative terminals if you can't access the screws used to hold the wires in the connectors. The figure below shows the screws that secure the receptacle to the power supply.

- With one hand, hold the handle on the front panel of the power supply. With the other hand, support the underside of the power supply, and insert the power supply into the empty power supply slot. Press until the supply is completely in the slot, so that the connectors on the back of the supply are fully engaged with the pins on the power backplane.

**CAUTION:** Make sure you insert the power supply right-side up. It is possible to insert the supply upside down, although the supply will not engage with the power backplane when upside down. The power supply is right-side up when the power connector is on the left and the fan vent is on the right.

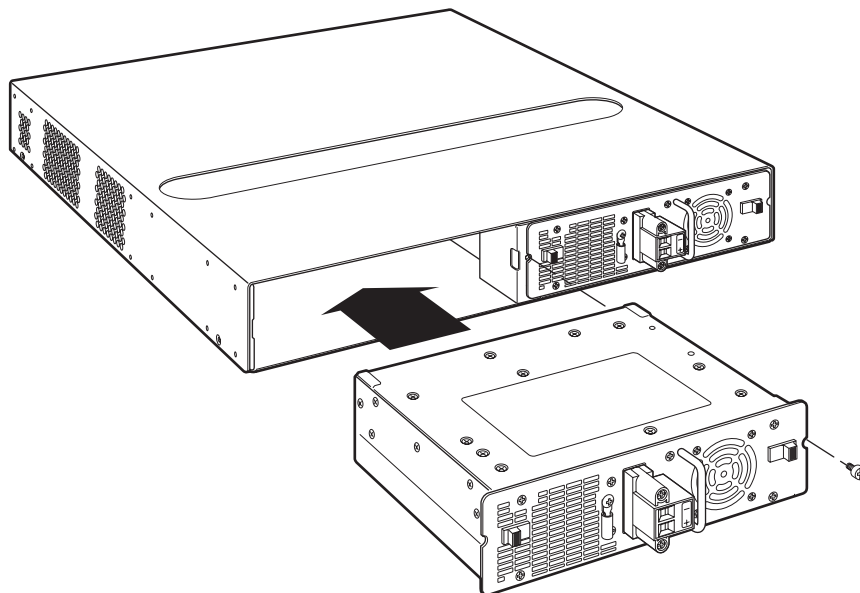

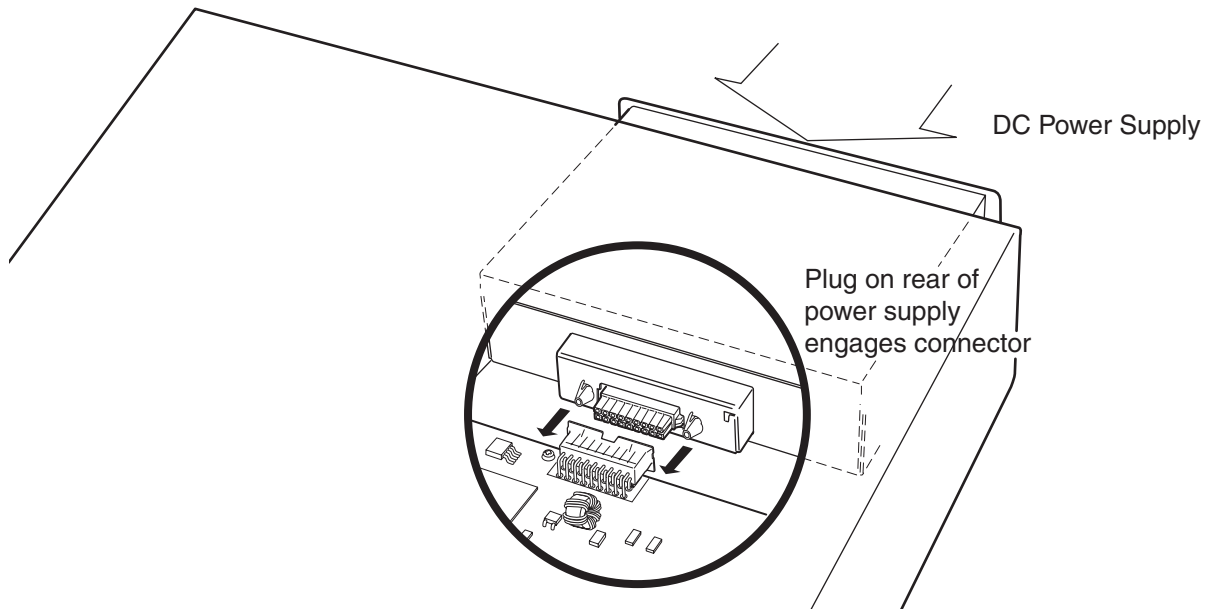

7. Press the two latches near the edges of the supply outward to lock the supply in place.
8. If you removed the receptacle for the positive and negative terminals, re-position it and secure the two screws.
9. Connect the ground, positive and negative wires as follows:
  - Slip the ground wire into the opening under the  $\ominus$  marking until the wire is fully in place, then use the crimper to crimp the lug snugly onto the wire. Gently pull the lug away from the wire to verify that the lug is securely fastened.
  - Connect the -48 VDC lead to the negative ( $-$ ) terminal and tighten the negative terminal screw.
  - Connect the 48 RTN lead to the positive ( $+$ ) terminal and tighten the positive terminal screw.

The following illustration shows how to connect the wires on a DC power supply.

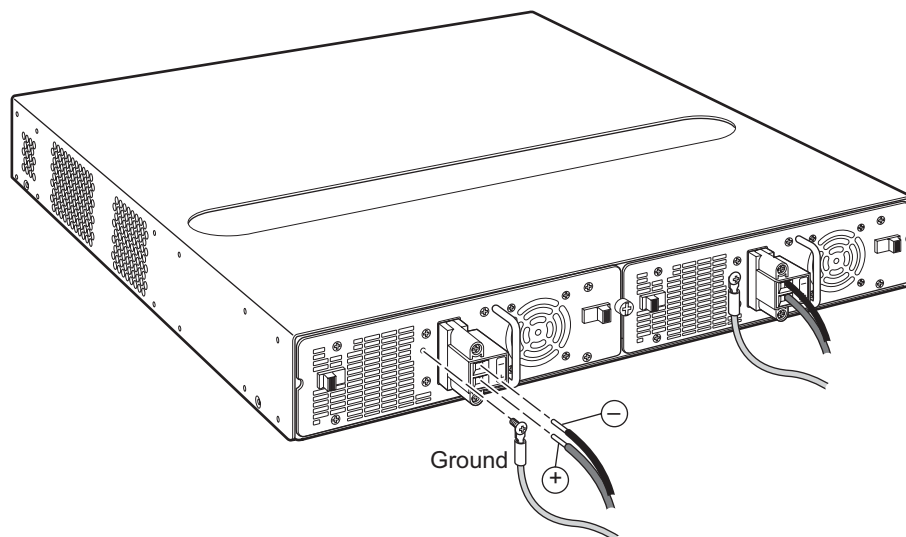

10. Pull gently on each wire to make sure it is securely fastened in the connector.



11. Replace the power supply locking screw.

## Installing the Device

You can install Foundry systems on a desktop, in an equipment rack, or on a wall.

---

**WARNING:** Make sure the rack or cabinet housing the device is adequately secured to prevent it from becoming unstable or falling over.

---

---

**WARNING:** Mount the devices you install in a rack or cabinet as low as possible. Place the heaviest device at the bottom and progressively place lighter devices above.

---

### Desktop Installation

1. Set the device on a flat desktop, table, or shelf. Make sure that adequate ventilation is provided for the system – a 3-inch clearance is recommended on each side.
2. Proceed to “Powering On the System” on page 3-14.

### Rack Mount Installation

For rack mount installation, Foundry recommends that you use a Telco equipment rack.

The Foundry FastIron device supports two different rack mount kits; a kit with *short mounting brackets* which ships with the device, and a kit with *long mounting brackets* (19 inches), which you can order separately from Foundry Networks (part number 70166-000). Use the long mounting brackets to prevent the Foundry device from sagging when installed in a non-compliant (non-Telco) equipment rack.

In addition to the rack mount kit, you will need the following tools for installation:

- #2 Phillips-head screwdriver
- Four 12-24 screws to mount the Foundry device to the rack.

---

**WARNING:** Make sure the rack or cabinet housing the device is adequately secured to prevent it from becoming unstable or falling over.

---

---

**WARNING:** Mount the devices you install in a rack or cabinet as low as possible. Place the heaviest device at the bottom and progressively place lighter devices above.

---

To install the rack mount brackets and mount the device in a rack, do the following:

1. Remove the rack mount kit from the shipping carton. The kit contains two mounting brackets and several mounting screws.
2. Align the brackets with the screw holes on the sides of the device, then use the screws to attach the mounting brackets. Refer to the appropriate illustration, depending on which brackets you are installing:
  - Figure 3.1 shows how to attach the short mounting brackets.
  - Figure 3.2 shows how to attach the long mounting brackets.

**Figure 3.1 Attaching the Short Mounting Brackets**

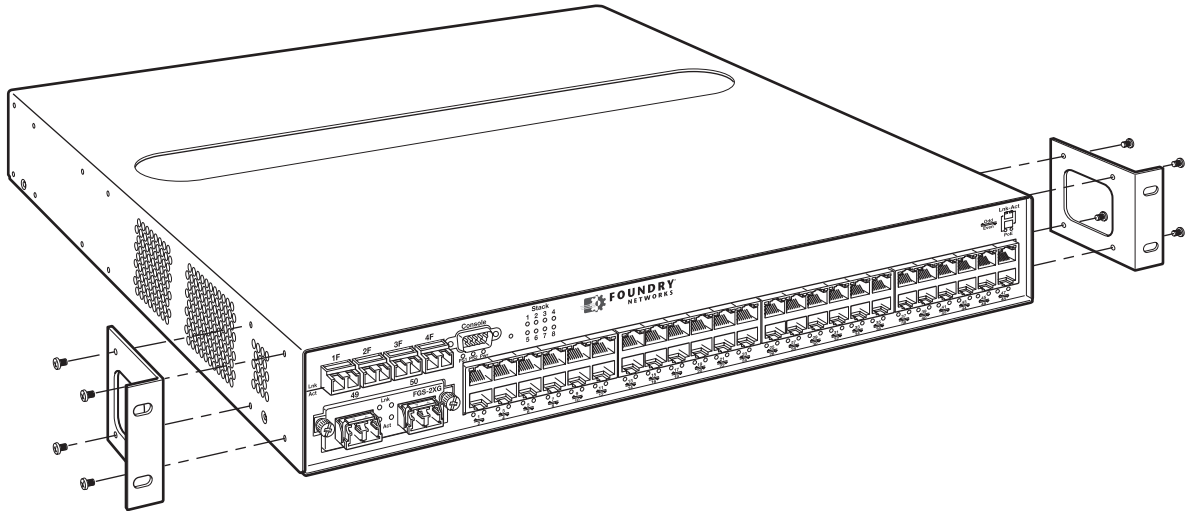

**Figure 3.2 Attaching the Long Mounting Brackets**

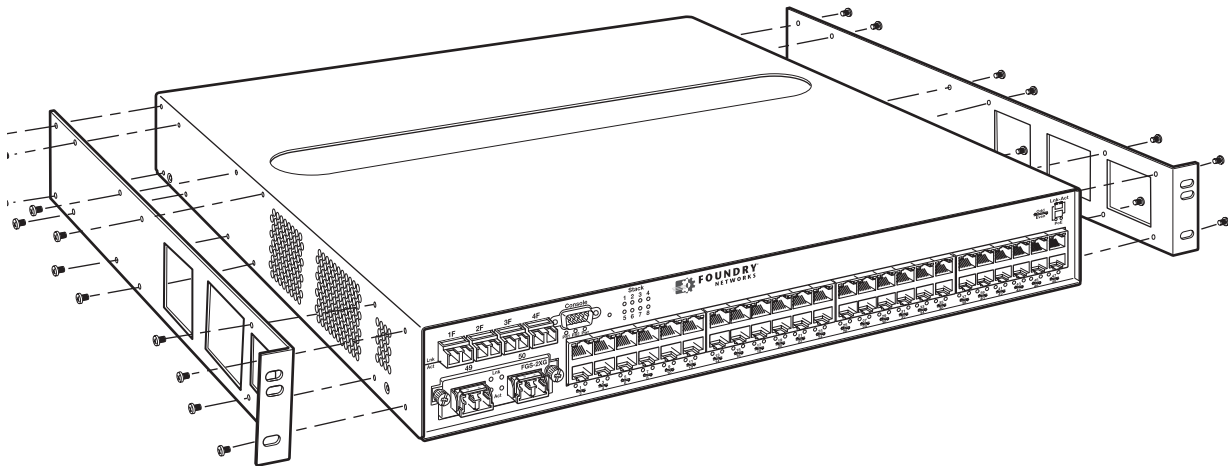

3. Mount the device in the rack as illustrated in Figure 3.3.

---

**NOTE:** Although Figure 3.3 shows a device with short mounting brackets, the procedure for securing a device with long mounting brackets is the same.

---

**Figure 3.3** Installing the device in a rack

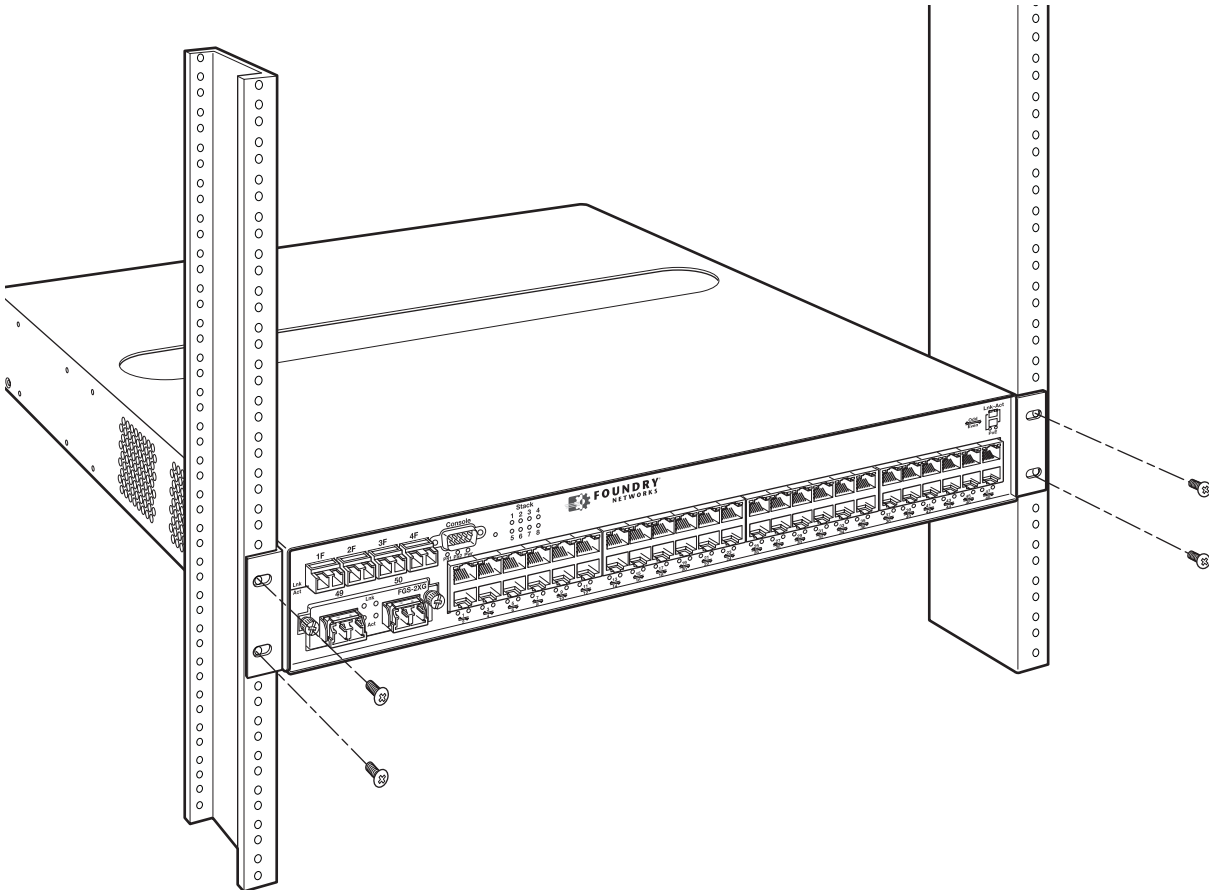

4. Proceed to "Powering On the System" on page 3-14.

## Wall Mount Installation

To mount the device on a wall, you must order and install the Wall Mount Bracket kit (part number 70076-000).

In addition to the Wall Mount Bracket kit, you will need the following tools for installation:

- #2 Phillips-head screwdriver
- 4 #10 screws (for mounting the Foundry device on a wall)
- 1/2" thick plywood sheet if you are mounting the device on a wallboard and there are no studs on which to mount the device.

## Installing the Brackets and Mounting the Device

Follow these instructions to install the brackets and mount the Foundry device on a wall.

1. Using the screws supplied in the kit, attach the mounting brackets to the sides of the device, as illustrated in Figure 3.4.

**Figure 3.4 Installing the Brackets**

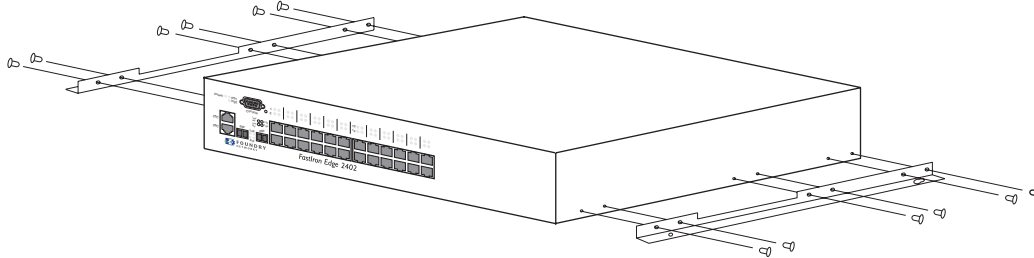

2. If there are no studs on which to mount the device, install 1/2" thick plywood to the wallboard or mounting surface.
3. Mount the device on the wall or plywood as illustrated in Figure 3.5.

---

**NOTE:** The kit does not come with screws for mounting the device to the wall. Use #10 screws to ensure proper fit with the wall mount brackets.

---

---

**NOTE:** First install the top two screws on the wall, then slide the brackets onto the screws using the keyholes located at the top of the brackets. After mounting the device, affix the bottom two screws.

---

**Figure 3.5 Mounting the Foundry device**

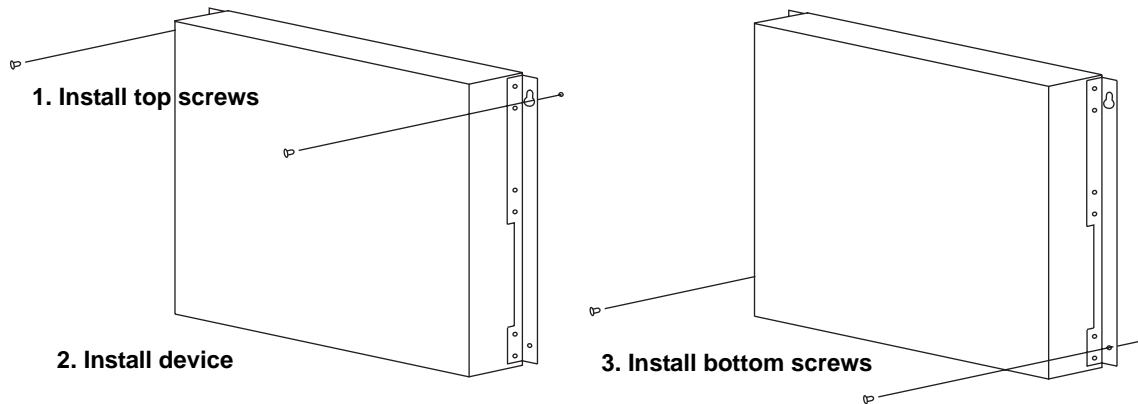

4. Proceed to "Powering On the System" .

## Powering On the System

Note the following before powering on the system:

- The socket should be installed near the equipment and should be easily accessible.
- If the outlet is not rated 115/120V, stop and get the appropriate cable for the outlet.
- If your installation requires a different power cord than that supplied with the device, make sure you obtain a power cord displaying the mark of the safety agency that defines the regulations for power cords in your country. The mark is your assurance that the power cord can be used safely with the device.

After you complete the physical installation of the system, you can power on the system.

1. Ensure that all power supplies are fully and properly inserted and no power supply slots are uncovered.

---

**CAUTION:** Never leave tools inside the device.

---

2. For DC supplies, connect the power source to the wires to activate the circuit.
3. For AC supplies:
  - Remove the power cord from the shipping package.
  - Attach the AC power cable to the AC connector on the rear panel as shown below.

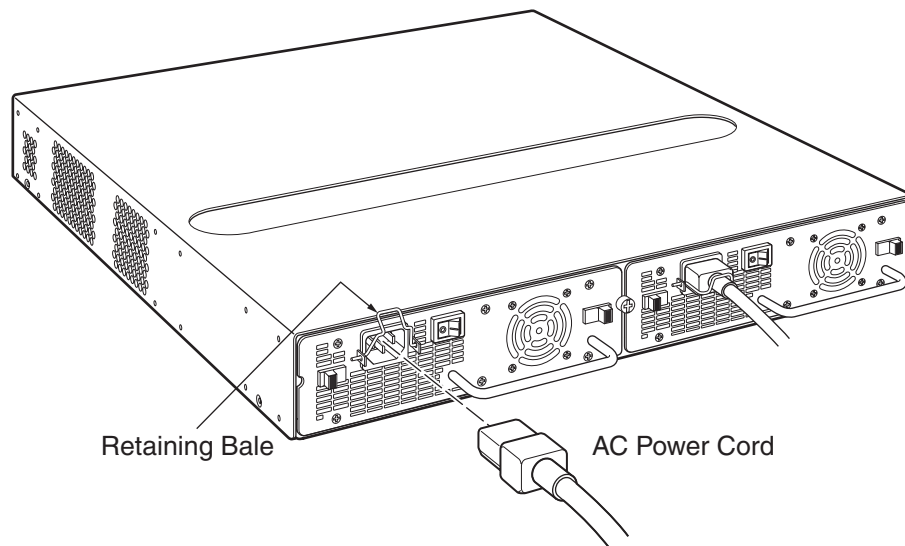

- Insert the power cable plug into a properly grounded 115V/120V electrical outlet.
  - Turn the power switch to the ON position.
4. If your device has more than one power supply installed, repeat this procedure for each power supply.
  5. Verify the device is working properly as instructed in “Verifying Proper Operation” on page 3-15.

## Powering Off the System

- To turn an AC system OFF, press the power supply switch to the OFF position or unplug the power cords.
- To turn a DC system OFF, disconnect the power source to the wires to de-activate the circuit.

## Verifying Proper Operation

After you have installed any additional power supplies and powered on the system, verify that the device is working properly:

1. Verify that the LED for each power supply is a solid green.
2. Verify proper operation by observing the LEDs:

All port LEDs should flash momentarily, usually in sequence, while the device performs diagnostics. After the diagnostics are complete, the LEDs will be dark except for those that are attached by cables to other devices. If the links on these cables are good and the connected device is powered on, the link LEDs will light.

Table 3.2 provides more details on specific LED conditions after system start-up.

## Observing the Power Status LEDs

Table 3.2 lists the LEDs on the front panel of the FastIron GS that show power status. The power supplies themselves do not have LEDs.

**Table 3.2: LEDs for Power**

LED	Position	State	Meaning
Pwr (Power)	Right-most LED beneath the Console port	On	The device is powered on and has enough power to operate.
		Off	The device is not powered on, or has been powered on but does not have sufficient power to operate.
PS1	Left-most LED beneath the Console port	On	Power supply 1 is installed and is functioning normally. Power supply 1 is located in the right-hand bay (when you are facing the rear of the device).
		Off	Power supply 1 is not installed or is not providing power.
PS2	Middle LED beneath the Console port	On	Power supply 2 is installed and is functioning normally. Power supply 2 is located in the left-hand bay (when you are facing the rear of the device).
		Off	Power supply 2 is not installed or is not providing power.

The software regularly polls the hardware for power status information. You can display the status information from any management session using the CLI command **show chassis**. In addition, the software automatically generates a Syslog message and SNMP trap if a status change occurs.

## Attaching a PC or Terminal

To assign an IP address, you must have access to the **Command Line Interface (CLI)**. The CLI is a text-based interface that can be accessed through a direct serial connection to the device and through Telnet connections.

You need to assign an IP address using the CLI. You can access the CLI by attaching a serial cable to the Console port. After you assign an IP address, you can access the system through Telnet, the Web management interface, or IronView Network Manager.

To attach a management station using the serial port:

1. Connect a PC or terminal to the serial port of the system using a straight-through cable. The serial port has a male DB-9 connector.

---

**NOTE:** You need to run a terminal emulation program on the PC.

---

2. Open the terminal emulation program and set the session parameters as follows:
  - Baud: 9600 bps
  - Data bits: 8
  - Parity: None
  - Stop bits: 1

- Flow control: None

When you establish the serial connection to the system, press Enter to display the CLI prompt in the terminal emulation window. For example:

- FastIron>
- FastIron-PREM>

If you see one of these prompts, you are now connected to the system and can proceed to “Assigning Permanent Passwords” on page 4-1.

You can customize the prompt by changing the system name. See the *Foundry FastIron Configuration Guide*.

If you do not see one of these prompts:

1. Make sure the cable is securely connected to your PC and to the Foundry system.
2. Check the settings in your terminal emulation program. In addition to the session settings listed above, make sure the terminal emulation session is running on the same serial port you attached to the Foundry system.

The EIA/TIA 232 serial communication port serves as a connection point for management by a PC or SNMP workstation. Foundry switches and Layer 3 Switches come with a standard male DB-9 connector, shown in Figure 3.6.

**Figure 3.6** Serial port pin and signalling details

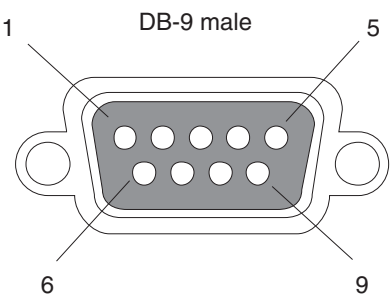
Pin Assignment	Pin Number	Switch Signal
	1	Reserved
	2	TXD (output)
	3	RXD (input)
	4	Reserved
	5	GND
	6	Reserved
	7	CTS (input)
	8	RTS (output)
	9	Reserved

Most PC serial ports also require a cable with a female DB-9 connector.

Terminal connections will vary, requiring either a DB-9 or DB-25 connector, male or female.

Serial cable options between a Foundry switch or router and a PC or terminal are shown in Figure 3.7.

**NOTE:** As indicated in Figure 3.6 and Figure 3.7, some of the wires should not be connected. If you do connect the wires that are labeled “Reserved”, you might get unexpected results with some terminals.

**Figure 3.7 Serial port pin assignments showing cable connection options to a terminal or PC**

DB-9 to DB-9 Female Switch			Terminal or PC	DB-9 to DB-25 Female Switch			Terminal or PC
1	Reserved	1		1	Reserved	8	
2	→	2	→	2	→	3	→
3	←	3	←	3	←	2	←
4	Reserved	4		4	Reserved	20	
5	→	5	→	5	→	7	→
6	Reserved	6		6	Reserved	6	
7	←	7	←	7	←	4	←
8	→	8	→	8	→	5	→
9	Reserved	9		9	Reserved	22	



---

# Chapter 4

## Connecting Network Devices and Checking Connectivity

---

**WARNING:** The procedures in this manual are for qualified service personnel.

---

This chapter provides the details for connecting network devices and checking network connectivity.

The following lists the tasks you must perform to connect your Foundry device, and shows where to get troubleshooting information for any problems that can arise.

**Table 4.1: Summary of Network Connectivity Tasks**

Task Number	Task	Where to Find More Information
1	Secure access to the CLI by assigning passwords.	“Assigning Permanent Passwords” on page 4-1
2	Configure IP addresses for the management, Ethernet, virtual, and loopback interfaces.	“Configuring IP Addresses” on page 4-3
3	Connect your device to another networking device.	“Connecting Network Devices” on page 4-4
4	Test a port for connectivity to other networking devices using the <b>ping</b> and <b>traceroute</b> commands.	“Testing Connectivity” on page 4-6
5	Troubleshoot any problems that can arise.	“Troubleshooting Network Connections” on page 4-8

### Assigning Permanent Passwords

By default, the CLI is not protected by passwords. To secure CLI access, Foundry strongly recommends assigning passwords.

---

**NOTE:** You cannot assign a password using the Web management interface. You can assign passwords using IronView Network Manager if an enable password for a Super User has been configured on the device.

---

The CLI contains the following access levels:

- User EXEC – The level you enter when you first start a CLI session. At this level, you can view some system information but you cannot configure system or port parameters.

- Privileged EXEC – This level is also called the Enable level and can be secured by a password. You can perform tasks such as manage files on the flash module, save the system configuration to flash, and clear caches at this level.
- CONFIG – The configuration level. This level lets you configure the system's IP address and configure switching and routing features. To access the CONFIG mode, you must already be logged into the Privileged level of the EXEC mode.

You can set the following levels of Enable passwords:

- Super User – Allows complete read-and-write access to the system. This is generally for system administrators and is the only password level that allows you to configure passwords.

---

**NOTE:** You must set a super user password before you can set other types of passwords.

---

- Port Configuration – Allows read-and-write access for specific ports but not for global (system-wide) parameters.
- Read Only – Allows access to the Privileged EXEC mode and CONFIG mode but only with read access.

To set passwords:

1. At the opening CLI prompt, enter the following command to change to the Privileged level of the EXEC mode:

```
FastIron> enable
```

2. Access the CONFIG level of the CLI by entering the following command:

```
FastIron# configure terminal
```

```
FastIron(config)#
```

3. Enter the following command to set the super-user password:

```
FastIron(config)# enable super-user-password <text>
```

---

**NOTE:** You must set the super-user password before you can set other types of passwords.

---

4. Enter the following commands to set the port configuration and read-only passwords:

```
FastIron(config)# enable port-config-password <text>
```

```
FastIron(config)# enable read-only-password <text>
```

---

**NOTE:** If you forget your super-user password, see "Recovering from a Lost Password" .

---

**Syntax:** enable super-user-password | read-only-password | port-config-password <text>

Passwords can be up to 32 characters long.

## Recovering from a Lost Password

By default, the CLI does not require passwords. However, if someone has configured a password for the device but the password has been lost, you can regain super-user access to the device using the following procedure.

---

**NOTE:** Recovery from a lost password requires direct access to the serial port and a system reset.

---

To recover from a lost password:

1. Start a CLI session over the serial interface to the Foundry device.
2. Reboot the device.
3. While the system is booting, before the initial system prompt appears, enter **b** to enter the boot monitor mode.
4. Enter **no password** at the prompt. (You cannot abbreviate this command.)

5. Enter **boot system flash primary** at the prompt. This command causes the device to bypass the system password check.
6. After the console prompt reappears, assign a new password.

## Configuring IP Addresses

You must configure at least one IP address using the serial connection to the CLI before you can manage the system using the other management interfaces. In addition, Foundry routers require an IP subnet address for the subnet in which you plan to place them in your network.

Foundry devices support both classical IP network masks (Class A, B, and C subnet masks, and so on) and Classless Interdomain Routing (CIDR) network prefix masks.

- To enter a classical network mask, enter the mask in IP address format. For example, enter "209.157.22.99 255.255.255.0" for an IP address with a Class-C subnet mask.
- To enter a prefix number for a network mask, enter a forward slash ( / ) and the number of bits in the mask immediately after the IP address. For example, enter "209.157.22.99/24" for an IP address that has a network mask with 24 significant ("mask") bits.

By default, the CLI displays network masks in classical IP address format (example: 255.255.255.0). You can change the display to the prefix format. See the *Foundry FastIron Configuration Guide*.

---

**NOTE:** If your network uses a Bootstrap Protocol (BootP) server or a Dynamic Host Configuration Protocol (DHCP) server, you can allow the Foundry device to obtain IP addresses for the hosts on the network.

---

## Devices Running Layer 2 Software

To configure an IP Address on a device running Layer 2 software:

1. At the opening CLI prompt, enter **enable**.  

```
FastIron> enable
```
2. Enter the following command at the Privileged EXEC level prompt (for example, FastIron Switch#), then press Enter. This command erases the factory test configuration if still present:

```
FastIron# erase startup-config
```

---

**CAUTION:** Use the **erase startup-config** command only for new systems. If you enter this command on a system you have already configured, the command erases the configuration. If you accidentally do erase the configuration on a configured system, enter the **write memory** command to save the running configuration to the startup-config file.

---

3. Access the configuration level of the CLI by entering the following command:

```
FastIron# configure terminal           Privileged EXEC Level
```

```
FastIron(config)#                   Global CONFIG Level
```

4. Configure the IP address and mask for the switch.

```
FastIron(config)# ip address 192.22.3.44 255.255.255.0
```

5. Set a default gateway address for the switch.

```
FastIron(config)# ip default-gateway 192.22.3.1
```

---

**NOTE:** You do not need to assign a default gateway address for single subnet networks.

---

**Syntax:** enable [<password>]

**Syntax:** configure terminal

**Syntax:** [no] ip address <ip-addr> <ip-mask>

or

**Syntax:** [no] ip address <ip-addr>/<mask-bits>

**Syntax:** ip default-gateway <ip-addr>

## Connecting Network Devices

Foundry devices support connections to other vendors' routers, switches, and hubs, as well other Foundry devices.

### Cable Specifications

See "Cable Specifications" on page 6-7 for cable lengths and types supported on the FGS devices.

### Connecting to Ethernet or Fast Ethernet Hubs

For copper connections to Ethernet hubs, a 10/100Base-TX or 1000Base-T switch, or another Foundry device, a crossover cable is required (Figure 4.1 and Figure 4.2). If the hub is equipped with an uplink port, it will require a straight-through cable instead of a crossover cable.

---

**NOTE:** The 802.3ab standard (automatic MDI/MDIX detection) calls for automatic negotiation of the connection between two 1000Base-T ports. Therefore, a crossover cable may not be required; a straight-through cable may work as well. For more information about this feature, see the *Foundry FastIron Configuration Guide*.

---

**Figure 4.1** UTP crossover cable

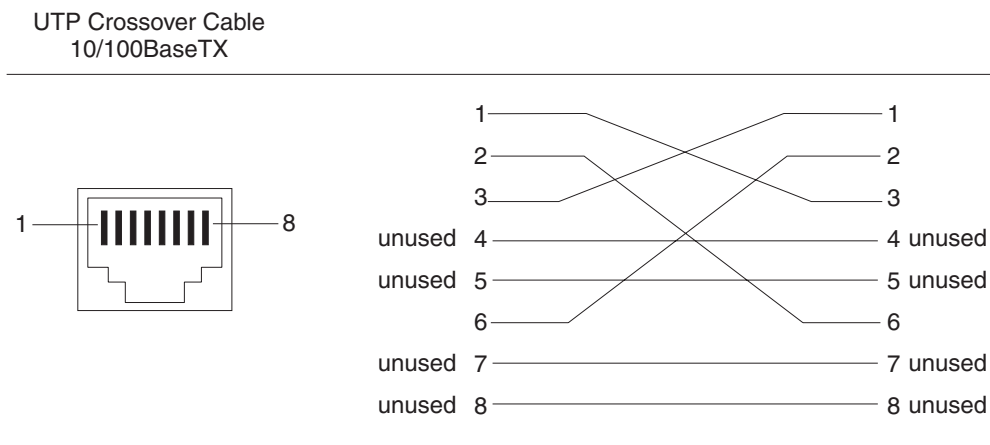

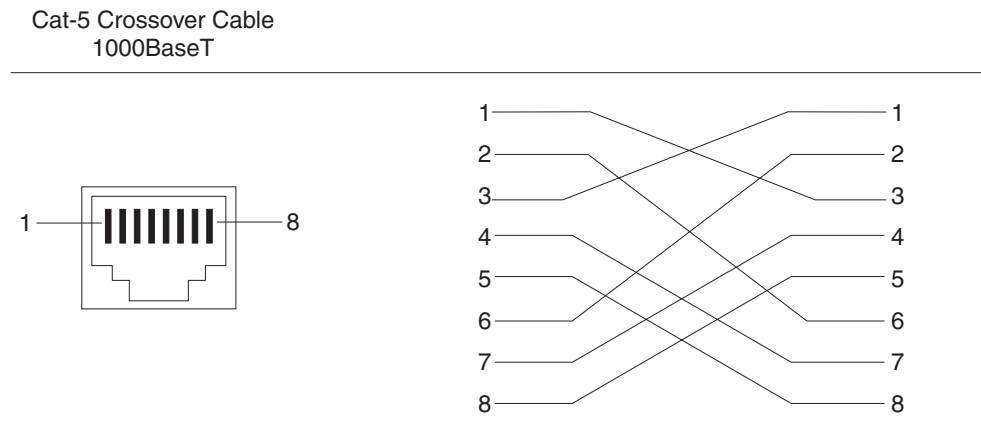
**Figure 4.2 Cat-5 crossover cable for 1000Base-T**

**NOTE:** The 802.3ab standard calls for automatic negotiation of the connection between two 1000Base-T ports. Consequently, a crossover cable may not be required; a straight-through cable may work as well.

## Connecting to Workstations, Servers, or Routers

Straight-through UTP cabling is required for direct UTP attachment to workstations, servers, or routers using network interface cards (NICs).

Fiber cabling is required for direct attachment to Gigabit NICs or switches and routers via fiber ports. See "Connecting a Network Device to a Fiber Port" on page 4-5.

### Automatic MDI/MDIX Detection

All 10/100 and Gigabit Ethernet Copper ports on the Foundry FGS devices support automatic Media Dependent Interface (MDI) and Media Dependent Interface Crossover (MDIX) detection. This feature is enabled on all 10/100 and Gigabit copper ports by default. For each port, you can disable auto MDI/MDIX, designate the port as an MDI port, or designate the port as an MDIX port.

For more information about this feature and how to configure it, see the *Foundry FastIron Configuration Guide*.

## Connecting a Network Device to a Fiber Port

For direct attachment from the Foundry device to a Gigabit NIC, switch, or router, fiber cabling with an LC connector is required.

To connect the Foundry device to another network device using a fiber port, you must do the following:

- Install a fiber optic module (SFP transceiver or mini-GBIC for Gigabit Ethernet ports, or XFP-MSA transceiver for 10-Gigabit Ethernet ports)
- Cable the fiber optic module

The following sections provide information about performing these tasks.

### Installing a Fiber Optic Module

You must install a fiber optic module (SFP or XFP transceiver) in each Gigabit Ethernet and 10-Gigabit Ethernet fiber port you want to use.

You can install a new fiber optic module in a port while the Foundry device is powered on and running.

To install a fiber optic module, you will need an ESD wrist strap with a plug for connection to a metal surface.

---

**WARNING:** For safety reasons, the ESD wrist strap should contain a series 1 meg ohm resistor.

---

To install a fiber optic module, do the following:

1. Put on the ESD wrist strap and ground yourself by attaching the clip end to a metal surface (such as an equipment rack) to act as ground.
2. Remove the new module from its protective packaging.
3. Gently insert the fiber optic module into the port until the module clicks into place. The module is keyed to prevent incorrect insertion.

### Cabling a Fiber Optic Module

To cable a fiber optic module, do the following:

1. Remove the protective covering from the fiber-optic port connectors and store the covering for future use.
2. Before cabling a fiber optic module, Foundry strongly recommends cleaning the cable connectors and the port connectors. For more information, see "Cleaning the Fiber-Optic Connectors" on page 4-6.
3. Gently insert the cable connector(s) (a tab on each connector should face upward) into the port connector(s) until the tabs lock into place.
4. Observe the link and active LEDs to determine if the network connections are functioning properly. See Table 4.2 on page 4-7.

### Cleaning the Fiber-Optic Connectors

To avoid problems with the connection between the fiber optic module (SFP (mini-GBIC) or XFP) and the fiber cable connectors, Foundry strongly recommends cleaning both connectors each time you disconnect and reconnect them. In particular, dust can accumulate in the connectors and cause problems such as reducing the optic launch power.

To clean the fiber cable connectors, Foundry recommends using the fiber-optic reel-type cleaner that shipped with your Foundry chassis. You can also purchase this type of cleaner from the following Website:

<http://www.fisfiber.com>

When not using an SFP or XFP connector, make sure to keep the protective covering on.

## Testing Connectivity

After you install the network cables, you can test network connectivity to other devices by pinging those devices. You also can observe the LEDs related to network connection and perform trace routes.

### Pinging an IP Address

To verify that a Foundry device can reach another device through the network, enter a command such as the following at any level of the CLI on the Foundry device:

```
FastIron>ping 192.33.4.7
```

**Syntax:** ping <ip addr> | <hostname> [source <ip addr>] [count <num>] [timeout <msec>] [ttl <num>] [size <byte>] [quiet] [numeric] [no-fragment] [verify] [data <1-to-4 byte hex>] [brief]

---

**NOTE:** If you address the ping to the IP broadcast address, the device lists the first four responses to the ping.

---

## Observing LEDs

After you install the network cables, you can observe certain LEDs to determine if the network connections are functioning properly. Table 4.2 outlines the LEDs related to the network connections, the desired state of each LED, possible abnormal states of each LED, and what to do if an LED indicates an abnormal state.

**Table 4.2: Network Connection-Related LED States**

LED	Desired State	Meaning	Abnormal State	Meaning/Action
Link (Lnk)	On (Green)	A link is established with the remote port.	Off	<p>A link is not established with the remote port. You can do the following:</p> <ul style="list-style-type: none"> <li>Verify that the connection to the other network device has been properly made. Also, make certain that the other network device is powered on and operating correctly.</li> <li>Verify that the transmit port on the Foundry device is connected to the receive port on the other network device, and that the receive port on the Foundry device is connected to the transmit port on the other network device. If you are not certain, remove the two cable connectors from the port connector and reinsert them in the port connector, reversing their order.</li> <li>Dust may have accumulated in the cable connector or port connector. For information about cleaning the connectors, see "Cleaning the Fiber-Optic Connectors" on page 4-6.</li> <li>If the other actions don't resolve the problem, try using a different port or a different cable.</li> </ul>
Active (Act)	On or blinking (Yellow)	The port is transmitting and receiving user packets.	Off for an extended period.	<p>The port is not transmitting or receiving user packets. You can do the following:</p> <ul style="list-style-type: none"> <li>Check the Link LED to make sure the link is still established with the remote port. If not, take the actions described in the Meaning/Action column for the Link LED.</li> <li>Verify that the port has not been disabled through a configuration change. You can use the CLI. If you have configured an IP address on the device, you also can use the Web management interface or IronView Network Manager.</li> </ul>

If a problem persists after taking these actions, contact Foundry's technical support.

## Tracing a Route

To determine the path through which a Foundry device can reach another device, enter a command such as the following at any level of the CLI on the Foundry device:

```
FastIron>traceroute 192.33.4.7
```

**Syntax:** traceroute <host-ip-addr> [maxttl <value>] [minttl <value>] [numeric] [timeout <value>]  
[source-ip <ip addr>]

The CLI displays trace route information for each hop as soon as the information is received. Traceroute requests display all responses to a given TTL. In addition, if there are multiple equal-cost routes to the destination, the Foundry device displays up to three responses by default.

## Troubleshooting Network Connections

- For the indicated port, verify that both ends of the cabling (at the Foundry device and the connected device) are snug.
- Verify that the Foundry device and the connected device are both powered on and operating correctly.
- Verify that you have used the correct cable type for the connection:
  - For twisted-pair connections to an end node, use straight-through cabling.
  - For fiber-optic connections, verify that the transmit port on the device is connected to the receive port on the connected device, and that the receive port on the device is connected to the transmit port on the connected device.
- Verify that the port has not been disabled through a configuration change. You can use the CLI. If you have configured an IP address on the device, you also can use the Web management interface or IronView Network Manager.
- For copper ports, you can test the cable using Virtual Cable Testing. See “Using Virtual Cable Testing to Diagnose a Cable” .
- If the other procedures don’t resolve the problem, try using a different port or a different cable.

## Using Virtual Cable Testing to Diagnose a Cable

FGS devices support **Virtual Cable Test** (VCT) technology. VCT technology enables you to diagnose a conductor (wire or cable) by sending a pulsed signal into the conductor, then examining the reflection of that pulse. This method of cable analysis is referred to as Time Domain Reflectometry (TDR). By examining the reflection, the Foundry device can detect and report cable statistics such as local and remote link pair, cable length, and link status.

### Configuration Notes

- This feature is supported on copper ports only. It is not supported on fiber ports.
- The port to which the cable is connected must be enabled when you issue the command to diagnose the cable. If the port is disabled, the command is rejected.
- If the port is operating at 100 Mbps half-duplex, the TDR test on one pair will fail.
- If the remote pair is set to forced 100 Mbps, any change in MDI/MDIX may cause the device to interpret the Multilevel Threshold-3 (MLT-3) as a reflected pulse, in which case, the device will report a faulty condition. In this case, Foundry recommends that you run the TDR test a few times for accurate results.

### Command Syntax

To diagnose a cable using TDR, enter a command such as the following at the Privileged EXEC level of the CLI:

```
FastIron#phy cable-diag tdr 1
```

The above command diagnoses the cable attached to port 1.

**Syntax:** phy cable-diag tdr <port-num>



## Viewing the Results of the Cable Analysis

To display the results of the cable analysis, enter a command such as the following at the Privileged EXEC level of the CLI:

```
FastIron#sh cable-diag tdr 1

Port      Speed Local pair Pair Length Remote pair Pair status
-----
01        1000M Pair A    <50M      Pair B    Terminated
          Pair B    <50M      Pair A    Terminated
          Pair C    <50M      Pair D    Terminated
          Pair D    <50M      Pair C    Terminated
```

**Syntax:** show cable-diag tdr <port-num>

Table 4.3 defines the fields shown in the command output.

**Table 4.3: Cable Statistics**

This Line...	Displays...
Port	The port that was tested.
Speed	The port's current line speed.
Local pair	The local link name.
Pair Length	The cable length when terminated, or the distance to the point of fault when the line is not up.
Remote pair	The remote link name.
Pair status	The status of the link. This field displays one of the following: <ul style="list-style-type: none"> <li>Terminated: The link is up.</li> <li>Shorted: A short is detected in the cable.</li> <li>Open: An opening is detected in the cable.</li> <li>ImpedMis: The impedance is mismatched.</li> <li>Failed: The TDR test failed.</li> </ul>



---

# Chapter 5

## Managing the FastIron GS Chassis

This chapter contains information about refining the configuration of, monitoring, and managing the following hardware components:

- “Managing Temperature Settings” on page 5-1
- “Displaying Management Module CPU Usage” on page 5-3
- “Removing MAC Address Entries” on page 5-3

### Managing Temperature Settings

This section describes how to display temperature settings on the FGS chassis and how to change the temperature warning levels.

#### Using the Temperature Sensor

The FastIron GS chassis comes with two built-in temperature sensors; one at the air intake, and the other at the exhaust. The temperature sensor at the air intake monitors the incoming air temperature. The temperature sensor at the air exhaust monitors the air temperature as it exits the device. The temperature sensors cause the device to generate a Syslog message and SNMP trap if the temperature exceeds a specified warning level.

The software reads the temperature sensors according to the chassis poll time, which is 60 seconds by default. If the temperature equals or exceeds the warning temperature, the software generates a Syslog message and SNMP trap.

You can use the CLI to do the following:

- Display the temperature of the device
- Change the warning temperature levels
- Change the chassis poll time

#### Displaying the Temperature

By default, the software polls the temperature sensor every 60 seconds to get the current temperature. This poll rate is controlled by the chassis poll time, which also controls how often the software polls other system components.

To display the temperature of a device, enter the **show chassis** command at any level of the CLI. The following shows an example output.

```
FastIron>show chassis
power supply 1 <NA - AC - Regular> present, status ok
power supply 2 not present

Fan 1 ok
Fan 2 ok
Exhaust Side Temperature Readings:
    Current temperature : 28.5 degrees Celsius
    Warning level.....: 45.0 degrees Celsius
    Shutdown level.....: 55.0 degrees Celsius
Intake Side Temperature Readings:
    Current temperature : 29.0 degrees Celsius
Boot Prom MAC: 00e0.5200.0100
```

**Syntax:** show chassis

## Displaying Temperature Messages

The software sends a Syslog message and an SNMP trap if the temperature crosses the warning threshold. The following methods describe how to view the system log on the device. If you have configured the device to use a Syslog server or SNMP trap receiver, see the documentation for the server or receiver.

To display the system log, enter the following command at any CLI level:

```
FastIron# show log

Syslog logging: enabled (0 messages dropped, 0 flushes, 0 overruns)
Buffer logging: level ACDMEINW, 8 messages logged
level code: A=alert C=critical D=debugging M=emergency E=error
I=informational N=notification W=warning

Static Log Buffer:

Dynamic Log Buffer (50 entries):

at 0 days 0 hours 2 minutes 0 seconds, level alert
Temperature 48.0 C degrees, warning level 45.0 C degrees
at 0 days 0 hours 1 minutes 0 seconds, level alert
Temperature 50.0 C degrees, warning level 45.0 C degrees
```

## Changing the Temperature Warning Level

The default warning temperature is 45.0 C degrees. You can change the warning temperature using the following command. The valid range is 0 – 125 C degrees.

With FGS software release 03.0.00, the FGS devices automatically reset and reload the software when the internal temperature reaches or exceeds the configured shutdown level for five minutes. This release also adds the capability for the system to register negative temperature settings.

To change the temperature at which the device sends a warning, enter a command such as the following at the Privileged EXEC level of the CLI:

```
FastIron#temperature warning 47
```

**Syntax:** temperature warning <value>

The <value> can be 0 – 125.

## Changing the Chassis Temperature Polling Interval

The software reads the temperature sensor and polls other hardware sensors according to the value set for the chassis poll time, which is 60 seconds by default. You can change the chassis poll time using the CLI.

To change the chassis poll time, enter a command such as the following at the global CONFIG level of the CLI:

```
FastIron(config)#chassis poll-time 200
```

**Syntax:** chassis poll-time <value>

The <value> can be 0 – 65535.

## Displaying Management Module CPU Usage

You can display the amount of the management module's CPU in use. To do so, enter the following command at any level of the CLI:

```
FastIron# show cpu

31 percent busy, from 3248 sec ago
1  sec avg:  31 percent busy
5  sec avg:  31 percent busy
60 sec avg:  31 percent busy
300 sec avg: 31 percent busy
```

**Syntax:** show cpu

## Removing MAC Address Entries

You can remove learned MAC address entries from the Foundry system's MAC address table. You can remove the following entries:

- All MAC address entries
- All MAC address entries for a specified Ethernet port
- All MAC address entries for a specified VLAN
- A specified MAC address entry in all VLANs

For example, to remove entries for the MAC address 000d.cb80.00d in all VLANs, enter the following command at the Privileged EXEC level of the CLI:

```
FastIron# clear mac-address 000d.cb80.00d0
```

**Syntax:** clear mac-address <mac-address> | ethernet <port-num> | vlan <number>

If you enter the **clear mac-address** command without any parameters, the software removes all MAC entries.

Use the <mac-address> parameter to remove a specified MAC address from all VLANs. Specify the MAC address in the following format: HHHH.HHHH.HHHH.

Use the **ethernet** <port-num> parameter to remove all MAC addresses for a specified Ethernet port.

Use the **vlan** <number> parameter to remove all MAC addresses for a specified VLAN.



---

# Chapter 6

## Hardware Specifications

This chapter contains the following hardware specifications for the Foundry Networks FastIron GS devices:

### **Chassis Specifications**

- “Physical Dimensions and Weight” on page 6-2
- “Environmental Considerations” on page 6-2
- “Cooling” on page 6-3
- “Regulatory Compliance” on page 6-3
- “Power Source Interruptions” on page 6-4
- “Mean Time Between Failure” on page 6-4
- “Pinouts and Signalling” on page 6-6
- “Cable Specifications” on page 6-7
- “Power Cords” on page 6-9
- “Warranty” on page 6-9

### **Power Supply Specifications**

- “Overview” on page 6-9
- “Key features” on page 6-10
- “Physical Dimensions and Weight” on page 6-10
- “Environmental Considerations” on page 6-10
- “Input Connector and Plug” on page 6-12
- Power Consumption
- “Regulatory Compliance” on page 6-13
- “Safety Warnings” on page 6-13
- “Electrical Specifications” on page 6-14

## Chassis Specifications

The following sections present the hardware specifications for the FastIron GS.

### Physical Dimensions and Weight

Table 6.1 lists the physical dimensions and weight of the FastIron GS models.

**Table 6.1: Physical Dimensions and Weight of the FGS Models**

Platform	Height	Width	Depth	Weight
FGS624P and FGS624P-POE	2.63 in 6.68 cm	17.5 in 44.45 cm	19.6 in 49.78 cm	<ul style="list-style-type: none"> <li>25 lbs (11.36 kg) fully loaded, including dual redundant power supplies</li> <li>17.5 lbs (7.94 kg) empty</li> </ul>
FGS648P and FGS648P-POE	2.63 in 6.68 cm	17.5 in 44.45 cm	19.6 in 49.78 cm	<ul style="list-style-type: none"> <li>29 lbs (13.15 kg) fully loaded, including dual redundant power supplies</li> <li>17.5 lbs (7.94 kg) empty</li> </ul>

### Environmental Considerations

For optimal performance, operate or store your Foundry device in compliance with the following environmental conditions.

**Table 6.2: Environmental Conditions for the Chassis**

Description	Range
<b>Operating Environment</b>	
Operating temperature	32° – 104° F (0° – 40° C)
Operating altitude	6,600 feet maximum
Relative humidity	5 to 95%, @ 104°F (40° C), non-condensing or 5 to 95% non-condensing for DC power supply
Operating noise	47 – 51 dB
Maximum heat dissipation	328 BTU/Hr with 2-port 10-Gigabit uplinks 280 BTU/Hr without 2-port 10-Gigabit uplinks
<b>Storage Environment</b>	
Storage temperature	-23° to 158° F, -25° to 70° C
Storage humidity	95% maximum, non-condensing
Storage altitude	15,000 feet (3,000 meter) maximum



## Cooling

The FGS chassis has two single-speed fans that operate simultaneously. If one fan fails, it does not affect the operation of the other fan. The cooling fans cool the CPU, main memory, and voltage regulators. The fans use either a push or pull configuration to move the air from the left side of the device to the right side of the device as shown in Figure 6.1.

- Total cooling capacity: 120 watts
- Total air flow: 80 LFM
- Fan operating noise: < 51 dB-A.

**NOTE:** Operating noise is based on the ISO 7779 standard.

**Figure 6.1** Internal airflow

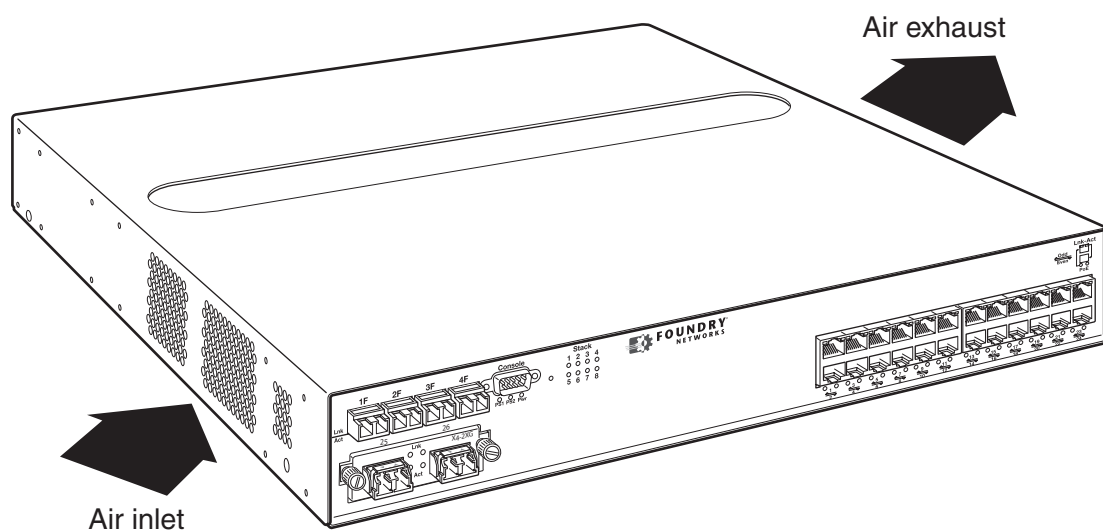

## Regulatory Compliance

Table 6.3 lists the Electromagnetic Compatibility (EMC), Immunity standards, and safety agency approvals for the FGS family of switches.

**Table 6.3: Chassis Regulatory Compliance**

Description	Certifications
Electromagnetic Emissions	CISPR-22 Class A EN 55022 FCC Class A (Part 15) VCCI Class A
Immunity	EN 50024:1998

**Table 6.3: Chassis Regulatory Compliance (Continued)**

Description	Certifications
Safety	EN 60950-1 CAN/CS-C22.2 No. 60950-1 EN 60825-1, Safety of Laser Products - Part 1 EN 60825-2, Safety of Laser Products - Part 2 IEC 60950-1 UL 60950-1

## Power Source Interruptions

Table 6.4 shows how the FastIron GS protects against power surges and power drops.

**Table 6.4: Chassis Power Surge and Drop Protection**

Property	Protection Mechanism
Power surge	MOV and Spark Gap protection
Power drop (<=1 second)	An AC loss of >15ms will cause the power supply to shut down due to input under-voltage
Maximum power draw	96 watts with 2-port 10-Gigabit uplinks 82 watts without 2-port 10-Gigabit uplinks

## Mean Time Between Failure

Table 6.5 lists the Mean Time Between Failure (MTBF) for the FastIron GS and the 10-GbE uplink modules. The MTBF is the average estimated time, in units of hours, before a hardware failure may occur.

**Table 6.5: MTBF for the FastIron GS and 10-GbE modules**

Configuration / Module	Temperature	MTBF (hours)	
		Without POE	With POE
24-port POE ready + 4 SFPs + 2-port 10-GbE module + 2 XFPs + 1 power supply	40° Celsius	150,879	142,217
24-port POE ready + 4 SFPs + 2-port 10-GbE module + 2 XFPs + 2 powers supplies	40° Celsius	267,411	241,356
48-port POE ready + 4 SFPs + 2-port 10-GbE module + 2 XFPs + 1 power supply	40° Celsius	133,825	120,775
48-port POE ready + 4 SFPs + 2-port 10-GbE module + 2 XFPs + 2 power supplies	40° Celsius	218,140	196,401
2-port 10-GbE XFP module	40° Celsius	1,597,580	N/A
2-port 10-GbE CX4 module <sup>a</sup>	40° Celsius		29,673,590

Table 6.5: MTBF for the FastIron GS and 10-GbE modules (Continued)

Configuration / Module	Temperature	MTBF (hours)	
		Without POE	With POE
1-port 10-GbE XFP + 1-port 10-GbE CX4 module <sup>a</sup>	40° Celsius		2,364,614
1-port 10-GbE XFP module	40° Celsius		2,501,219

a. This module will be available in a future release.

## Power Draw Specifications

Table 6.6 lists the typical and maximum power draw specifications for FGS models.

Table 6.6: Power Supply Draw Specifications

Model	Typical	Maximum
24-Port	<ul style="list-style-type: none"> <li>without uplink: 3.5A @ 12V = 42W</li> <li>with 2CX4+1XFP: 4.4A @ 12V = 53W</li> <li>with 2XFP+1XFP: 4.3A @ 12V = 53W</li> <li>with Combo+1XFP: 4.2A @ 12V = 53W</li> </ul>	<ul style="list-style-type: none"> <li>without uplink: 1.7A @ 12V/PS1 + 1.7A @ 12V/PS2 = 48W</li> <li>with 2CX4+1XFP: 2.2A @ 12V/PS1 + 2.2A @ 12V/PS2 = 63W</li> <li>with 2XFP+1XFP: 2.1A @ 12V/PS1 + 2.2A @ 12V/PS2 = 67W</li> <li>with Combo+1XFP: 2.0A @ 12V/PS1 + 2.1A @ 12V/PS2 = 65W</li> </ul>
48-Port	<ul style="list-style-type: none"> <li>without uplink: 6.8A @ 12V = 82W</li> <li>with 2CX4: 7.4A @ 12V = 89W</li> <li>with 2XFP: 7.3A @ 12V = 89W</li> <li>with Combo: 7.4A @ 12V = 89W</li> </ul>	<ul style="list-style-type: none"> <li>without uplink: 3.4A @ 12V/PS1 + 3.4A @ 12V/PS2 = 94W</li> <li>with 2CX4: 3.7A @ 12V/PS1 + 3.7A @ 12V/PS2 = 102W</li> <li>with 2XFP: 3.6A @ 12V/PS1 + 3.6A @ 12V/PS2 = 106W</li> <li>with Combo: 3.7A @ 12V/PS1 + 3.7A @ 12V/PS2 = 104W</li> </ul>

## Pinouts and Signalling

This section lists the pinouts for the DB-9 connector and RJ-45 port jacks.

### Serial (Console) Port Pinouts

The Console port is a standard male DB-9 connector, as shown in Figure 6.2.

**Figure 6.2** Serial port pin and signalling details

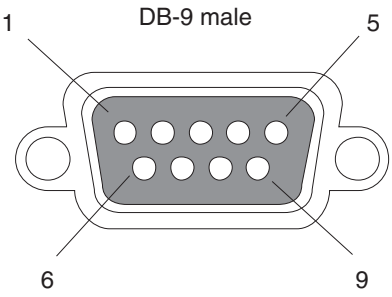
Pin Assignment	Pin Number	Switch Signal
	1	Reserved
	2	TXD (output)
	3	RXD (input)
	4	Reserved
	5	GND
	6	Reserved
	7	CTS (input)
	8	RTS (output)
	9	Reserved

Most PC serial ports require a cable with a female DB-9 connector. However, terminal connections will vary, requiring a cable with either a DB-9 or DB-25 connector, male or female.

Serial cable options between the FastIron GS and a PC or terminal are shown in Figure 6.3.

**NOTE:** As indicated in Figure 6.2 and Figure 6.3, some of the wires should not be connected. If you do connect the wires that are labeled "Reserved", you might get unexpected results with some terminals.

**Figure 6.3** Console port pin assignments showing cable connection options to a terminal or PC

DB-9 to DB-9 Female Switch		Terminal or PC	DB-9 to DB-25 Female Switch		Terminal or PC
1	Reserved	1	1	Reserved	8
2	→	2	2	→	3
3	←	3	3	←	2
4	Reserved	4	4	Reserved	20
5	—	5	5	—	7
6	Reserved	6	6	Reserved	6
7	←	7	7	←	4
8	→	8	8	→	5
9	Reserved	9	9	Reserved	22

## 10/100 and Gigabit Port Pinouts

Figure 6.4 lists the pin assignment and signalling for 10/100/100 ports.

**Figure 6.4 Pin assignment and signalling for 10/100/1000 ports**

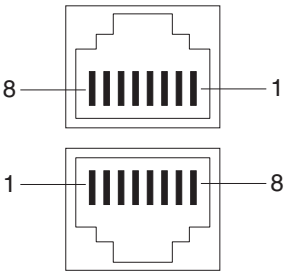
Pin Assignment	10BaseT		100BaseTX and 1000BaseT	
	Pin Number	MDI-X ports	Pin Number	MDI-X ports
	1	RD+	1	RD+
	2	RD-	2	RD-
	3	TD+	3	TD+
	4	Not used	4	CMT
	5	Not used	5	CMT
	6	TD-	6	TD-
	7	Not used	7	CMT
	8	Not used	8	CMT

## Cable Specifications

Table 6.7 lists the cable specifications for the cables used with the 10/100, Gigabit and 10-Gigabit Ethernet ports.

**NOTE:** Cable installation and network configuration will affect overall transmission capability. The numbers provided below represent the accepted recommendations of the various standards. For network-specific recommendations, consult your local Foundry reseller or system engineer.

**Table 6.7: Cable length summary table**

	Cable Type <sup>a</sup>	Connector Type	Core Diameter (microns)	Modal Bandwidth (MHz*km) or Wavelength (nm)	Range (meters)
1000Base-BX-D	Single-mode Fiber (SMF)	LC connector for SFP module	9	1490 nm	2 – 10000 (10km)
1000Base-BX-U	SMF	LC connector for SFP module	9	1310 nm	2 – 10000 (10km)
1000Base-LHA	SMF	LC connector for SFP module	9	1550 nm	2 – 70000 (70km)
1000Base-LHB	SMF	LC connector for SFP module	9	1550 nm	2 – 120000 (120km)
1000Base-LX	Multi-mode Fiber (MMF)	LC connector for SFP module	62.5	500	2 – 550
	MMF		50	400	2 – 550
	MMF		50	500	2 – 550
	SMF		9	1300 nm	2 – 10000

Table 6.7: Cable length summary table (Continued)

	Cable Type <sup>a</sup>	Connector Type	Core Diameter (microns)	Modal Bandwidth (MHz*km) or Wavelength (nm)	Range (meters)
1000Base-SX	MMF	LC connector for SFP module	62.5/125	200	.5 – 275
	MMF		62.5/125	500	.5 – 550
	MMF		50/125	900	.5 – 595
	MMF		50/125	1500	.5 – 740
	MMF		50/125	2000	.5 – 860
1000Base-SX 2	MMF	LC connector for SFP module	62.5	500	up to 2000 (2 km)
1000Base-T	Copper	RJ-45 jack for standard unshielded twisted pair (UTP/Category 5)	n/a	n/a	up to 100 meters
100Base-BX	SMF	LC connector for SFP module	9	1310/1490	10000 (10 km)
100Base-FX	MMF	LC connector for SFP module	62.5	500	up to 2000 (2 km)
100Base-TX	Copper	RJ-45 jack for standard unshielded twisted pair (UTP/Category 5)	n/a	n/a	up to 100 meters
10GBase-CX4	Infiniband 4x copper	XAUI connector	n/a	n/a	up to 15
10GBase-ER	SMF	LC connector for XFP module	9	1550 nm	up to 40000 (40 km)
10GBase-LR	SMF	LC connector for XFP module	9	1310 nm	2 – 10000 (10km)
10GBase-SR	MMF	LC connector for XFP module	62.5/125	160	2 – 26
	MMF		62.5/125	200	2 – 33
	MMF		50/125	400	2 – 66
	MMF		50/125	500	2 – 82
	MMF		50/125	2000	2 – 300
10GBase-ZR	SMF	LC connector for XFP module	9	1550 nm	up to 80000 (80 km)

Table 6.7: Cable length summary table (Continued)

	Cable Type <sup>a</sup>	Connector Type	Core Diameter (microns)	Modal Bandwidth (MHz*km) or Wavelength (nm)	Range (meters)
10GBase-ZRD	SMF	LC connector for XFP module	9	1530.33 – 1561.42 nm	up to 80000 (80 km)

a.SMF = Single Mode Fiber, MMF = Multi-Mode Fiber

## Power Cords

All of the Foundry devices ship with US-compatible power cords unless otherwise specified at the time of order. United Kingdom- and European-compatible power cords are also available.

For power cord specifications, see “Input Connector and Plug” on page 6-12

## Warranty

The FGS family of switches come with a 5-year limited lifetime warranty. The software comes with a 90-day warranty.

## Power Supply Specifications

This section contains the following information for the power supplies that ship with the FGS devices.

- “Overview” on page 6-9
- “Key features” on page 6-10
- “Physical Dimensions and Weight” on page 6-10
- “Input Connector and Plug” on page 6-12
- “Regulatory Compliance” on page 6-13
- “Environmental Considerations” on page 6-10
- “Electrical Specifications” on page 6-14

## Overview

Each FGS switch comes with one alternating-current (AC) or direct-current (DC) power supply, depending on how it was ordered from the factory. All models have two power supply slots, enabling you to install a second power supply for redundancy (if applicable) or for more POE power. DC supplies are available for some devices, in which you can use any combination of AC and DC supplies in the same device. The following power supplies may be installed in your FGS switch:

- RPS-FGS (AC power supply)
- RPSDC-FGS (DC power supply)

---

**WARNING:** The power supplies used with POE devices produce extensive power to support 802.3af applications. Installing the power supply in a device other than a POE device will cause extensive damage to your equipment.

---

The power supplies can be swapped in or out of the device while the device is running. You can remove and insert a power supply without opening the chassis. If the device contains two power supplies and the power supplies are redundant, you can remove one of the power supplies without interrupting operation. The remaining power supply

provides enough power for all the ports. For more information, see “Installing an Additional Power Supply” on page 3-5.

**NOTE:** A FastIron GS POE device with dual power supplies may not provide redundancy, depending on how much power the POE ports are consuming. See “Power Specifications for POE” on page 2-14.

**CAUTION:** Remove the power cord from a power supply before you install it in or remove it from the device. Otherwise, the power supply or the device could be damaged. The device can be running while a power supply is being installed or removed, but the power supply itself should not be connected to a power source.

All power supplies are auto-sensing and auto-switching.

## Key features

See “Power Supplies” on page 2-12 for the key features of the FGS power supplies.

## Physical Dimensions and Weight

**Table 6.8: Physical Dimensions and Weight of Power Supplies**

Power Supply	Dimensions	Weight
RPS-FGS	2.46 in (H) x 8.67 in (W) x 7.6 in (D)	6 lbs (2.72 kg)
RPSDC-FGS	6.25 cm (H) x 22.03 cm (W) x 19.30 cm (D)	

## Environmental Considerations

For optimal performance, operate or store the power supplies in compliance with the following environmental conditions.

**Table 6.9: Power Supply Operating and Storage Environment**

Description	Range
<b>Operating Environment</b>	
Operating temperature	32° – 104° F (0° – 40° C)
Relative humidity	0 – 95%, non-condensing
Operating altitude	Up to 6,600 feet above sea level
Operating noise	47 – 51 dBA
Cooling	<ul style="list-style-type: none"> <li>• AC: internal fans, 50mm</li> <li>• DC: internal fan, 60 mm</li> </ul>
<b>Storage Environment</b>	
Storage temperature	-40° to 185° F, -40° to 85° C
Storage humidity	95% maximum, non-condensing
Storage altitude	Up to 15,000 feet above sea level



## Power Supply Consumption

Table 6.10 describes the maximum power supply consumption for each FastIron GS model.

**Table 6.10: Maximum Power Supply Consumption for FGS Models**

<b>Model</b>	<b>Maximum Power Consumption</b>
<b>FGS624</b> without uplink with 2 CX4+1XFP with 2 XFP+1XFP with Combo+1XFP	48 W 63 W 67 W 65 W
<b>FGS648</b> without uplink with 2 CX4 with 2XFP with Combo	94 W 102 W 106 W 104 W
<b>FGS624</b> power drawn from outlet with 1 power supply without uplink with 2 CX4+1XFP with 2XFP+1XFP with Combo+1XFP	99 W 121 W 121 W 121 W
<b>FGS648</b> power drawn from outlet with 1 power supply without uplink with 2 CX4 with 2XFP with Combo	162 W 170 W 170 W 170 W
<b>FGS624</b> power drawn from outlet with 2 power supplies (PS efficiency goes down as load increases) without uplink with 2CX4+1XFP with 2XFP+1XFP with Combo+1XFP	127 W 161 W 161 W 161 W
<b>FGS648</b> power drawn from outlet with 2 power supplies (PS efficiency goes down as load decreases) without uplink with 2 CX4 with 2XFP with Combo	192 W 204 W 204 W 204 W

## Input Connector and Plug

Table 6.11 lists the input connectors for the power supplies.

**Table 6.11: Input Connector for Power Supplies**

Power Supply	Input Connector Properties
RPS-FGS	Standard IEC type (IEC 320) C14 type: UL/CSA 15A/250V, VDE 10A/250V Orientation: Ground pin down
RPSDC-FGS	3-position Phoenix Contact The power supply is connected to Earth Ground using wire attached to the ground stud on the power supply rear panel.

Figure 6.5 shows the power plug and connector for AC power supplies.

**Figure 6.5 AC power cable plug and input connector**

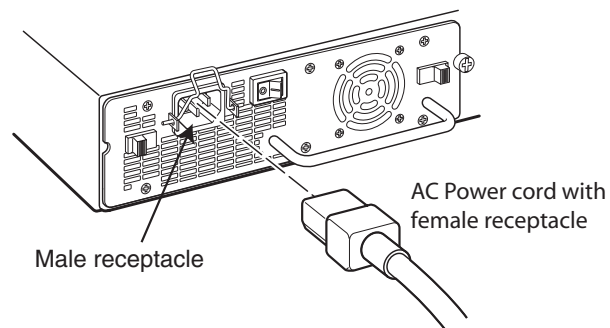
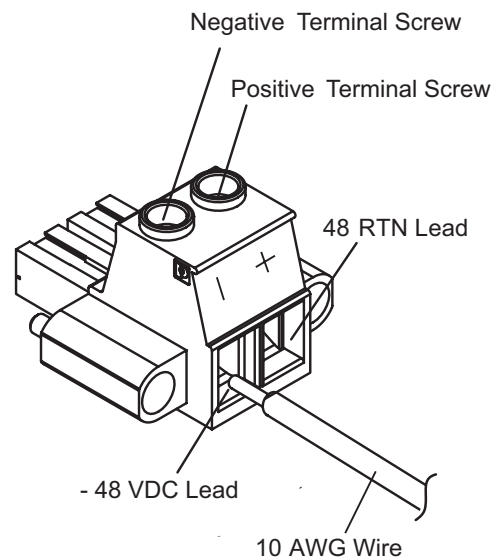

Figure 6.6 shows the power connector for DC power supplies.

**Figure 6.6 DC power connector**



## Regulatory Compliance

The power supplies comply with the conducted and radiated test, immunity, and safety standards as listed in Table 6.12. EMC standards are within a 6 dB minimum margin.

**Table 6.12: Power Supply Regulatory Compliance**

Description	Certifications
Electromagnetic Emissions	CISPR 22 Class A FCC Class A VCCI Class A EN55022 Class A Harmonic Current Emissions (Class A) - EN61000-3-2, with Amendment 14 (1999) Voltage Fluctuations and Flicker - EN61000-3-3
Immunity	EN 55024 EN 61000-4-5. The power supply is tested to level 2 (differential mode) and level 3 (common mode)
Safety	CSA/cUL UL CE TUV

## Safety Warnings

The power supplies are marked with an electrical hazard label and with the safety warnings shown in Table 6.13.

**Table 6.13: Safety Warning Labels on Power Supplies**

CAUTION: No operator serviceable parts inside. Refer servicing to qualified personnel.	
<b>ATTENZIONE</b>	Non aprire. Rivolgersi a personale qualificado.
<b>CUIDADO:</b>	Partes adentro no reparables por el operador. Refiera reparo a personal autorizado.
<b>ATTENTION:</b>	Entretien et réparations internes ne sont autorisés qu'au personnel technique qualifié.
<b>ACHTUNG:</b>	Zugang zur Bedienung nicht erforderlich. Wartung nur durch qualifiziertes Personal.

## Electrical Specifications

Table 6.14 lists the electrical specifications for the power supplies.

**Table 6.14: Power Supply Electrical Specifications**

Description	Ranges	
	AC	DC
<b>Input Specifications</b>		
Input voltage range	100 to 240 VAC	-48 to -60 VDC
Input current	8 Amps	10 Amps
Inrush current	< 11.25 Amps peak maximum	< 26 Amps peak maximum
<b>Output Specifications</b>		
Output power	600 watts of total output power, including +12VDC @ 10A to the system and -48VDC @ 10 A for Power over Ethernet applications	

---

**CAUTION:** The FGS power supply is designed exclusively for use with FGS devices. The power supply produces extensive power to support 802.3af applications. Installing the power supply in a device other than the FGS will cause extensive damage to your equipment.

---

---

# Chapter 7

## Maintaining the FastIron GS Hardware

This chapter provides instructions for maintaining the FGS hardware.

---

**WARNING:** The procedures in this manual are for qualified service personnel.

---

This chapter contains the following information:

- “Hardware Maintenance Schedule” on page 7-1
- “Replacing a Power Supply” on page 7-1
- “Installing or Replacing a 2-port 10-GbE Module” on page 7-9
- “Installing or Replacing a POE Daughter Card” on page 7-10
- “Replacing a Fiber Optic Module” on page 7-15
- “Cleaning the Fiber-Optic Connectors” on page 7-16
- “Digital Optical Monitoring” on page 7-17

### Hardware Maintenance Schedule

The FGS switch hardware components require minimal maintenance. Foundry recommends cleaning the fiber-optic connectors on fiber-optic ports and the connected fiber cable each time you disconnect the cable.

You can replace the following hardware components as needed:

- 2-port 10-Gigabit Ethernet module
- Copper and fiber optic modules (SFPs (mini-GBICs) and XFP transceivers)
- POE daughter card
- Power supplies

### Replacing a Power Supply

You can replace a power supply while the FGS chassis is powered on and running. The power supplies are located in slots at the rear of the FGS chassis.

This section provides information about the following topics:

- Installation precautions and warnings
- Determining which power supply has failed, if necessary

- Replacing a power supply

---

**WARNING:** Power supplies are hot swappable. However, Foundry Networks recommends that you disconnect the power supply from AC power before installing or removing the supply. The device can be running while a power supply is being installed or removed, but the power supply itself should not be connected to a power source. Otherwise, you could be injured or the power supply or other parts of the device could be damaged.

---

## Installation Precautions and Warnings

Follow these precautions when installing a power supply in the FGS chassis.

---

**WARNING:** Before beginning the installation, see the precautions in “Power Supply Precautions” on page 3-4.

---

---

**CAUTION:** Do not install the device in an environment where the operating ambient temperature might exceed 40° C (104° F).

---

---

**CAUTION:** Never leave tools inside the chassis.

---

## Determining Which Power Supply Failed

If you are replacing a power supply that has failed and you are not sure which supply has failed, enter the following command at any CLI command prompt:

```
FastIron>show chassis
power supply 1 <NA - AC - Regular> present, status ok
power supply 2 not present

Fan 1 ok
Fan 2 ok
Exhaust Side Temperature Readings:
    Current temperature : 28.5 degrees Celsius
    Warning level.....: 45.0 degrees Celsius
    Shutdown level.....: 55.0 degrees Celsius
Intake Side Temperature Readings:
    Current temperature : 29.0 degrees Celsius
Boot Prom MAC: 00e0.5200.0100
```

This command displays status information for the power supplies and the fans. The power supplies are numbered from left to right. These numbers assume you are facing the front of the device, not the rear.

If the display indicates “Installed (Failed)” for any of the slots, the power supply installed in that particular slot has failed.

## AC Power Supplies

Use the following procedures for AC power supplies in FGS devices.

---

**WARNING:** Before beginning the installation, see the precautions in “Power Supply Precautions” on page 3-4.

---

You will need a #2 Phillips-head screwdriver to perform these procedures.

Figure 7.1 shows a front view of the AC power supply.

**Figure 7.1 AC Power Supply**

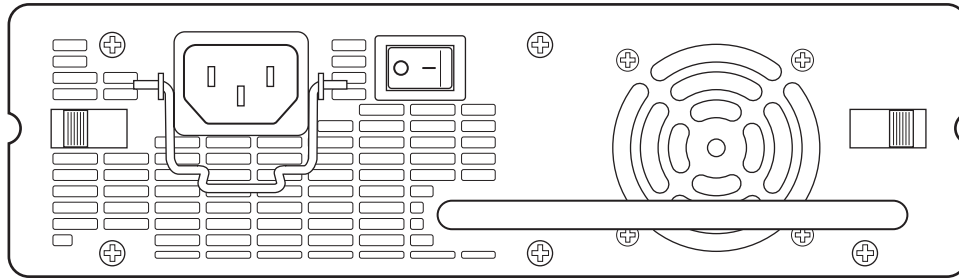

### Removing an AC Power Supply

1. Unplug the power supply from the power source.
2. Disconnect the power cord from the power supply.
3. If necessary, remove the power supply locking screw located in the center rear of the FGS chassis.

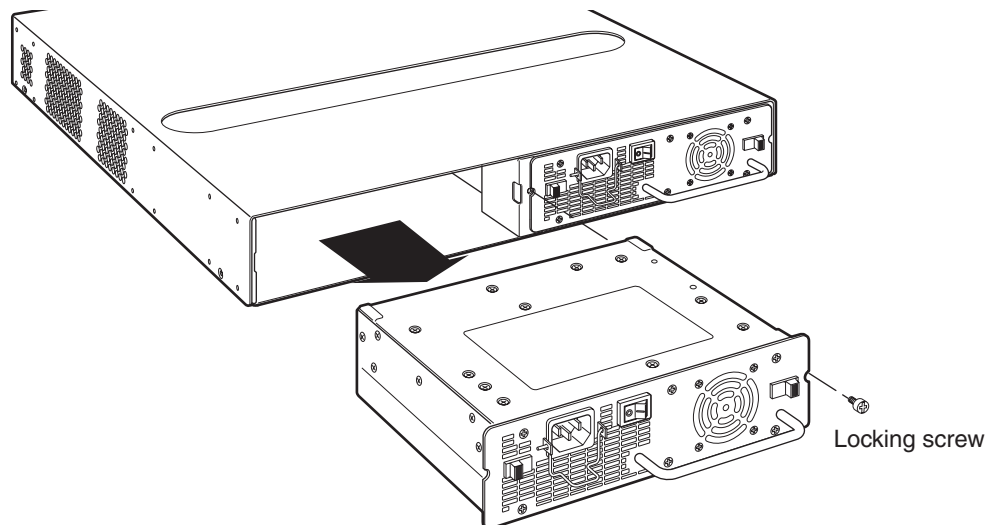

4. Press inward on the two latches near the edges of the power supply to unlock the supply.
5. Hold the handle on the front panel of the power supply and pull outward. This will disconnect the power supply from the backplane.
6. Continue to pull the power supply until it is removed from the device.
7. Place the power supply in an anti-static bag for storage.

## Installing an AC Power Supply

To install an AC power supply, do the following:

1. If necessary, remove the power supply locking screw located in the center rear of the device (illustrated below).

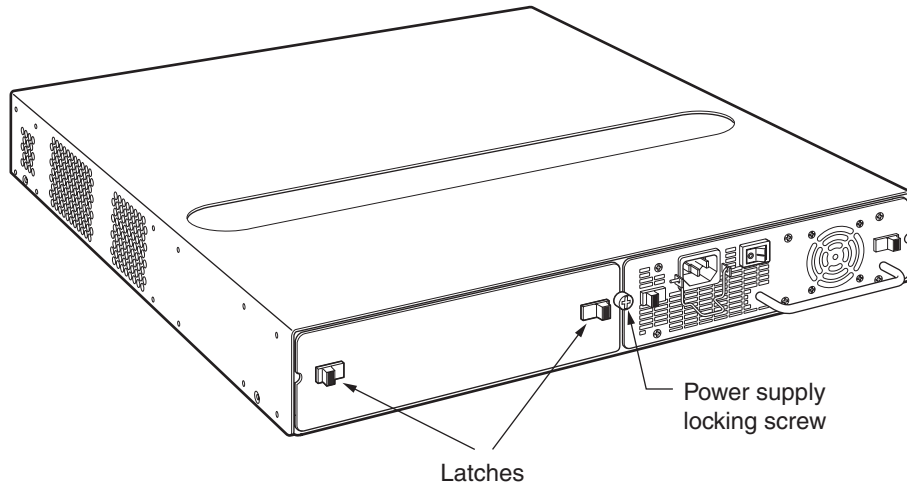

2. If the empty power supply bay has a cover plate, press inward on the two latches near the left and right edges of the cover plate to unlock the plate (illustrated above), then remove the plate.
3. Remove the new power supply from its packaging.
4. With one hand, hold the bar on the front panel of the power supply. With the other hand, support the underside of the power supply, and insert the power supply into the empty power supply slot. Press until the supply is completely in the slot, so that the connectors on the back of the supply fully engage with the pins on the power backplane.

---

**CAUTION:** Make sure you insert the power supply right-side up. It is possible to insert the supply upside down, although the supply will not engage with the power backplane when upside down. The power supply is right-side up when the power connector is on the left and the fan vent is on the right.

---

The following illustrations show how to install an AC power supply.



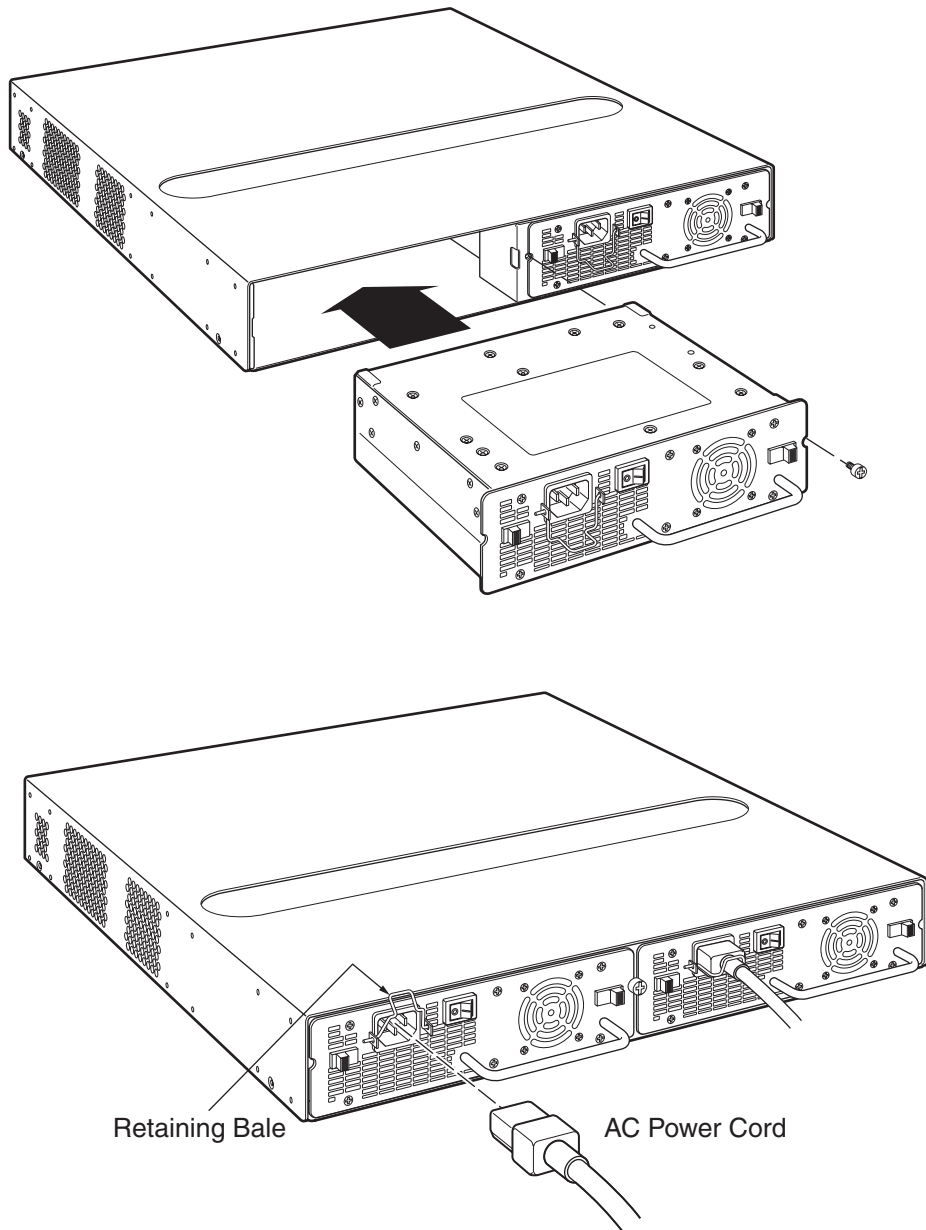

5. Press the two latches near the edges of the supply outward to lock the supply in place.
6. Replace the power supply locking screw.
7. Power on the supply and verify that it is working properly as instructed in "Powering On the System" on page 3-14 and "Verifying Proper Operation" on page 3-15.

## DC Power Supplies

Use the following procedures for DC power supplies in FGS devices.

---

**WARNING:** Before beginning the installation, see the precautions in "Power Supply Precautions" on page 3-4.

---

You will need the following tools to perform these procedures.

- #2 Phillips-head screwdriver
- #2 Flat-head screwdriver

Figure 7.2 shows a front view of the DC power supply.

**Figure 7.2 DC Power Supply**

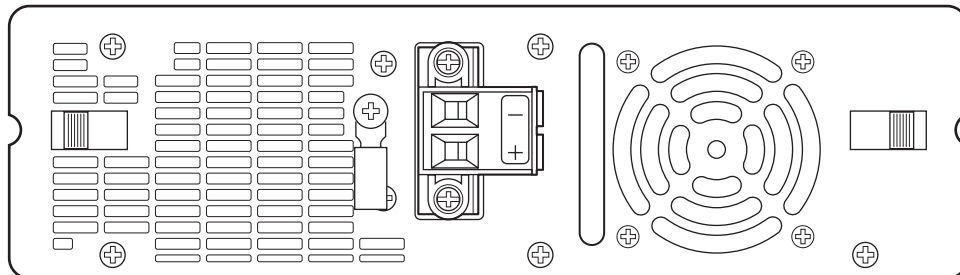

### Removing a DC Power Supply

1. Turn off the DC power source or disconnect it from the power supply.
2. Loosen the three screws used to hold the wires in the connectors, then pull out the wires.
3. If necessary, remove the power supply locking screw located in the center rear of the device (illustrated below).

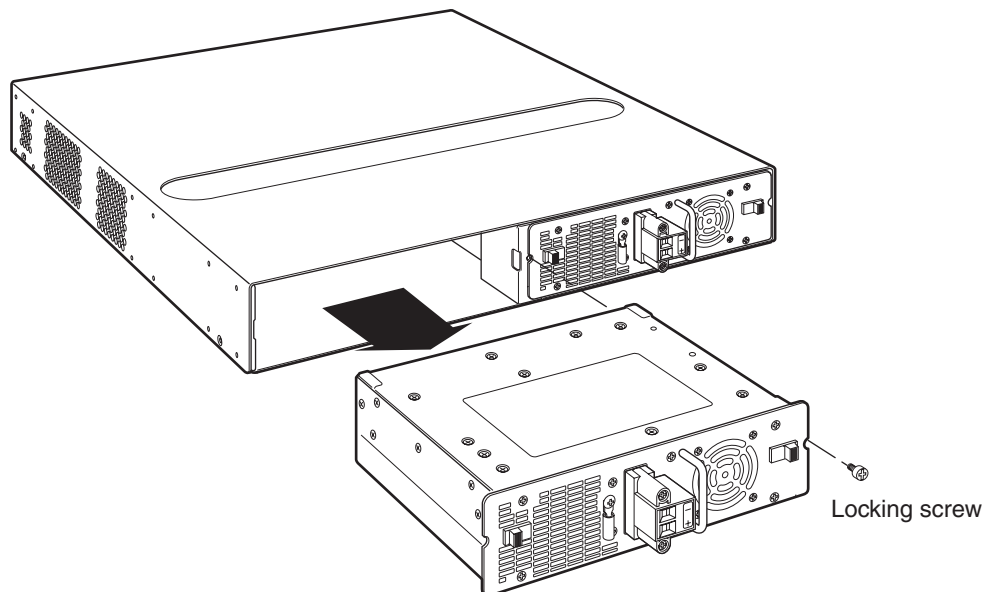

4. Press the two latches near the edges of the supply inward to unlock the supply.
5. Hold the handle on the front panel of the power supply and pull outward. This will disconnect the power supply from the backplane.
6. Continue to pull the power supply until it is removed from the device.
7. Place the power supply in an anti-static bag for storage.

## Installing a DC Power Supply

1. If necessary, before installing a power supply, remove the power supply locking screw located in the center rear of the device (illustrated below).

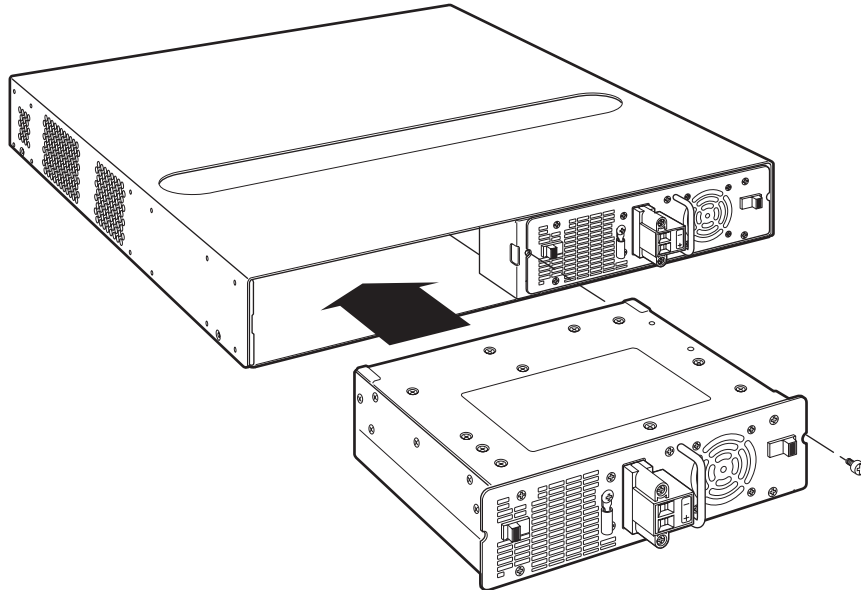

2. If the empty power supply bay has a cover plate, unlock it by pressing inward on the two latches near the left and right edges of the cover plate (illustrated above), then remove the plate.
3. Remove the new power supply from its packaging.
4. Prepare the positive, negative, and ground wires by stripping about 1/4" of insulation off the end of each one. (Use 10 AWG wire.)
5. Loosen the three screws used to hold the wires in the connectors. These are located under the following markings and shown in the illustration below:

— + ⊕

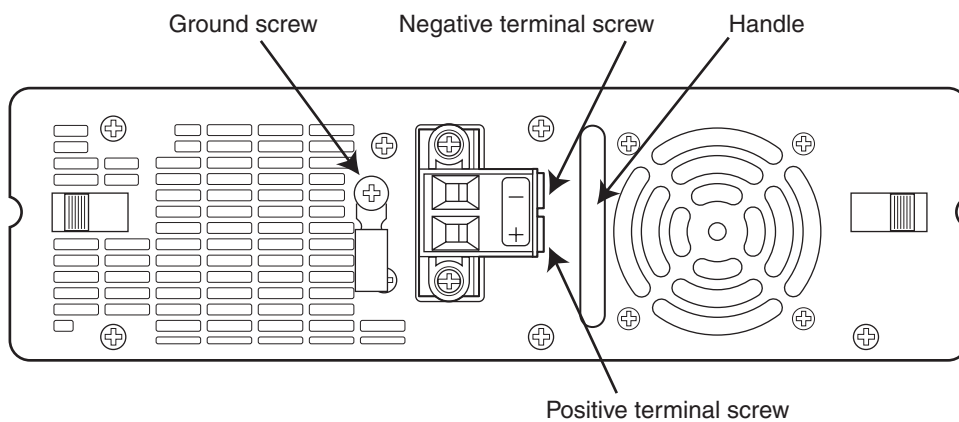

**NOTE:** The handle on the front panel of the power supply may block access to the negative and positive terminal screws. You may need to temporarily remove the receptacle for the positive and negative terminals if you can't access the screws used to hold the wires in the connectors. The figure below shows the screws that secure the receptacle to the power supply.

---

6. Connect the ground, positive and negative wires as follows:
  - Slip the ground wire into the opening under the  $\oplus$  marking until the wire is fully in place, then use the crimper to crimp the lug snugly onto the wire. Gently pull the lug away from the wire to verify that the lug is securely fastened.
  - Connect the -48 VDC lead to the negative (—) terminal and tighten the negative terminal screw.
  - Connect the 48 RTN lead to the positive (+) terminal and tighten the positive terminal screw.

The following illustration shows how to connect the wires on a DC power supply.

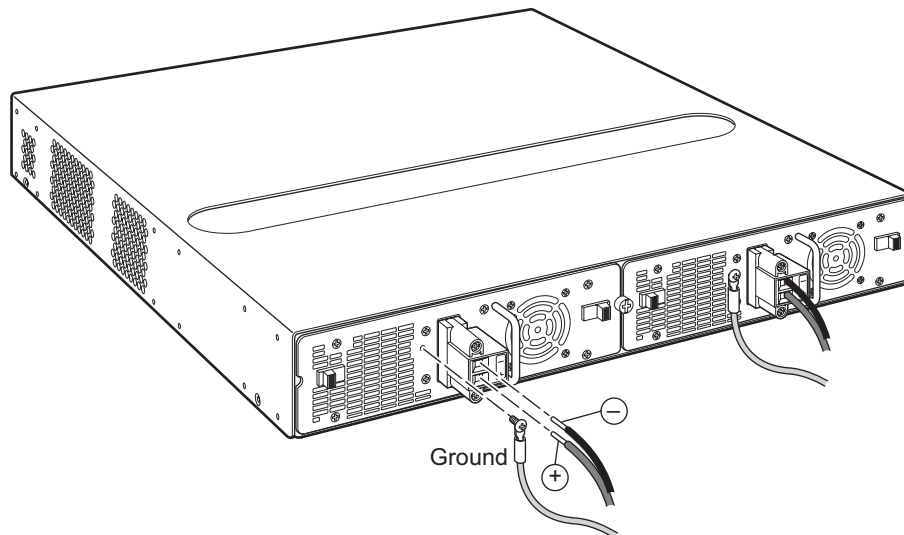

7. Pull gently on each wire to make sure they are securely fastened in the connector.
8. If you removed the receptacle for the positive and negative terminals, re-position it and secure the two screws.
9. With one hand, hold the handle on the front panel of the power supply. With the other hand, support the underside of the power supply, and insert the power supply into the empty power supply slot. Press until the supply is completely in the slot, so that the connectors on the back of the supply are fully engaged with the pins on the power backplane.

**CAUTION:** Make sure you insert the power supply right-side up. It is possible to insert the supply upside down, although the supply will not engage with the power backplane when upside down. The power supply is right-side up when the power connector is on the left and the fan vent is on the right.

---

10. Press the two latches near the edges of the supply outward to lock the supply in place.
11. Replace the power supply locking screw.
12. Power on the supply and verify that it is working properly as instructed in "Powering On the System" on page 3-14 and "Verifying Proper Operation" on page 3-15.

## Installing or Replacing a 2-port 10-GbE Module

The 2-port 10-Gigabit Ethernet module is optional. You can order the FGS with a 2-port 10-Gigabit module installed at the factory, or you can later upgrade your device.

**NOTE:** The 1-port 10-Gigabit module on the FGS624XGP and FGS624XGP-POE is not field replaceable or upgradeable.

This section provides the steps for installing, removing, and replacing the 2-port 10-Gigabit Ethernet module. You will need the following tools to perform these procedures:

- #2 Phillips-head screwdriver or flathead screwdriver for captive screws
- Electrostatic Discharge (ESD) kit

Figure 7.3 shows a 2-port 10-GbE module.

**Figure 7.3** 2-port 10-GbE Module

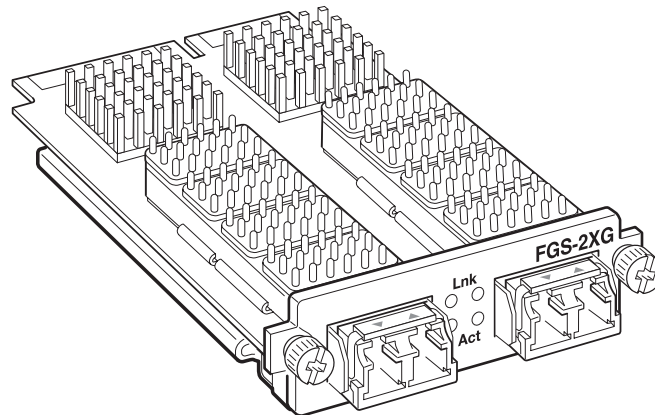

### Removing a 2-port 10-GbE Module

1. Remove power to the Foundry device. For AC power supplies, turn the switch to the OFF position. For DC power supplies, turn off the DC power source or disconnect it from the power supply.
2. Remove the 10-Gigabit module from the chassis:
  - Use a #2 Phillips-head screwdriver or flathead screwdriver to loosen and remove the two captive screws on the 10-Gigabit module.
  - Gently pull on the 10-GbE module to disconnect it from the backplane connector. Once disconnected, remove the 10-GbE module completely from the chassis.
3. Place the 10-Gigabit module in an anti-static bag for storage.
4. Do one of the following:
  - Insert a new 10-Gigabit module as instructed in the section “Installing a 2-port 10-GbE Module”.
  - If you are removing the module without replacing it, place the blank faceplate over the opening where the 10-GbE module was installed. Use the two captive screws to fasten the faceplate in place.

### Installing a 2-port 10-GbE Module

Follow these procedures and refer to Figure 7.4 when installing a 10-Gigabit Ethernet Module:

1. Remove power to the Foundry device. For AC power supplies, turn the switch to the OFF position. For DC power supplies, turn off the DC power source or disconnect it from the power supply.

2. If necessary, remove the faceplate for the 2-port 10-GbE module located in the lower left-hand corner of the front panel. Use a #2 Phillips-head screwdriver or flathead screwdriver to loosen the two captive screws that secure it in place. Place the blank faceplate in a safe place for future use.
3. Remove the new 10-Gigabit Ethernet module and faceplate from its protective packaging.
4. Install the 10-Gigabit module in the chassis as shown in Figure 7.4:
  - Properly place and align the 10-Gigabit Ethernet module inside the chassis.
  - When the module is fully inserted, push it firmly toward the back of the chassis until the front panel is flush with the rest of the chassis. This action causes the module's connector to lock into the backplane connector.
  - Use a #2 Phillips-head screwdriver or flathead screwdriver to fasten the two captive screws on the 10-Gigabit module. Affix the screws loosely at first, then tighten them once you are sure the module is properly positioned.

**Figure 7.4** Installing a 2-port 10-GbE Module

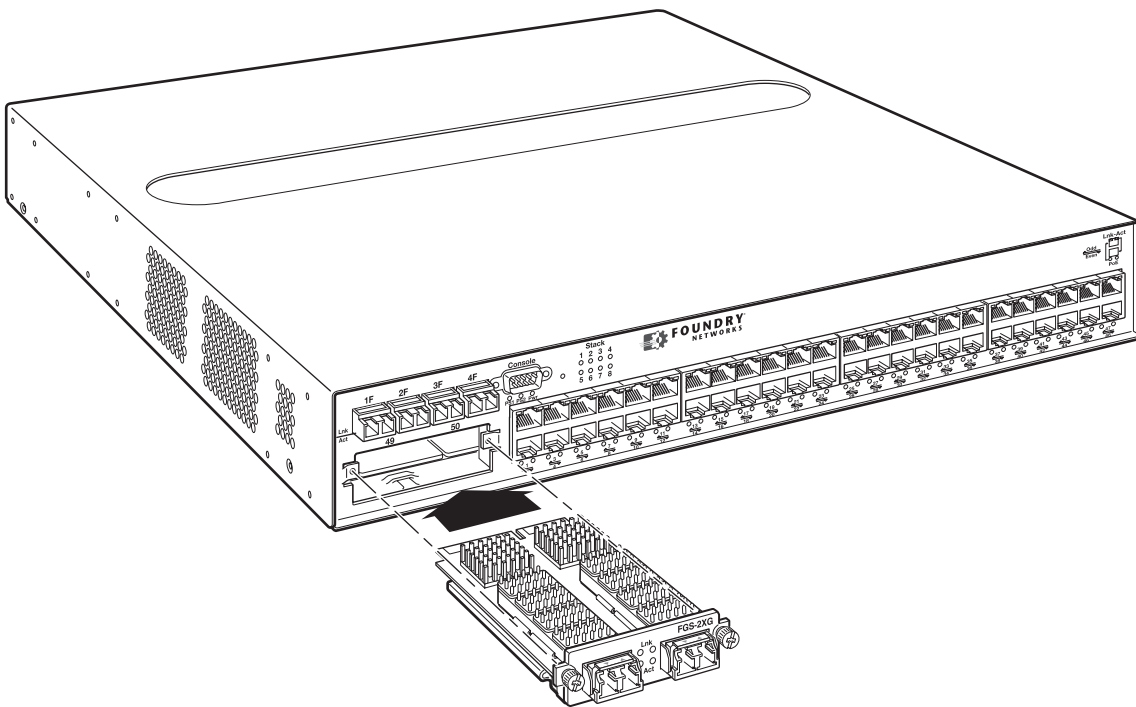

5. After installing the module, power on the system and verify that the 10-GbE module is working properly. Refer to the section “Observing LEDs” on page 4-7.

## Installing or Replacing a POE Daughter Card

This section provides instructions for installing or replacing a Power Over Ethernet (POE) daughter card in the FastIron GS chassis.

- The FGS624P and FGS624P-POE have one connector slot on the main board for a single POE daughter card, which provides support for POE power-consuming devices on all 24 10/100/1000 ports.
- The FGS648P and FGS648P-POE have two connector slots on the main board for two POE daughter cards. A single POE daughter card provides support for POE power-consuming devices on 24 10/100/1000 ports. A POE daughter card in the left-most connector slot provides POE for ports 1 – 24, and the right-most connector slot provides POE for ports 25 – 48. This assumes you are facing the front of the device, not the rear.

To install or replace a POE daughter card, you must have the following on hand:

- A POE daughter card (part number FGS-24GCPOE), which you can order from Foundry.
- An ESD wrist strap with a plug for connection to the FGS chassis.

---

**WARNING:** For safety reasons, the ESD wrist strap should contain a series 1 meg ohm resistor.

---

- A #2 Phillips-head screwdriver.

## Disassembling the Chassis

This section provides instructions for disassembling the FGS chassis so that you can install, remove, or replace a POE daughter card.

1. Remove power to the Foundry device. For AC power supplies, turn the switch to the OFF position. For DC power supplies, turn off the DC power source or disconnect it from the power supply.
2. Put on an Electrostatic Discharge (ESD) wrist strap and attach the clip end to a metal surface (such as an equipment rack) to act as ground.
3. Remove the device's cover and faceplate:
  - If the device was mounted on a rack, remove the two mounting brackets from the chassis. Figure 3.3 on page 3-13 shows the location of the mounting brackets and screws.
  - Use a #2 Phillips-head screwdriver to remove the two screws on each side of the cover. (There are four screws altogether as shown in Figure 7.5.)

**Figure 7.5** Removing the Screws for the Top Cover

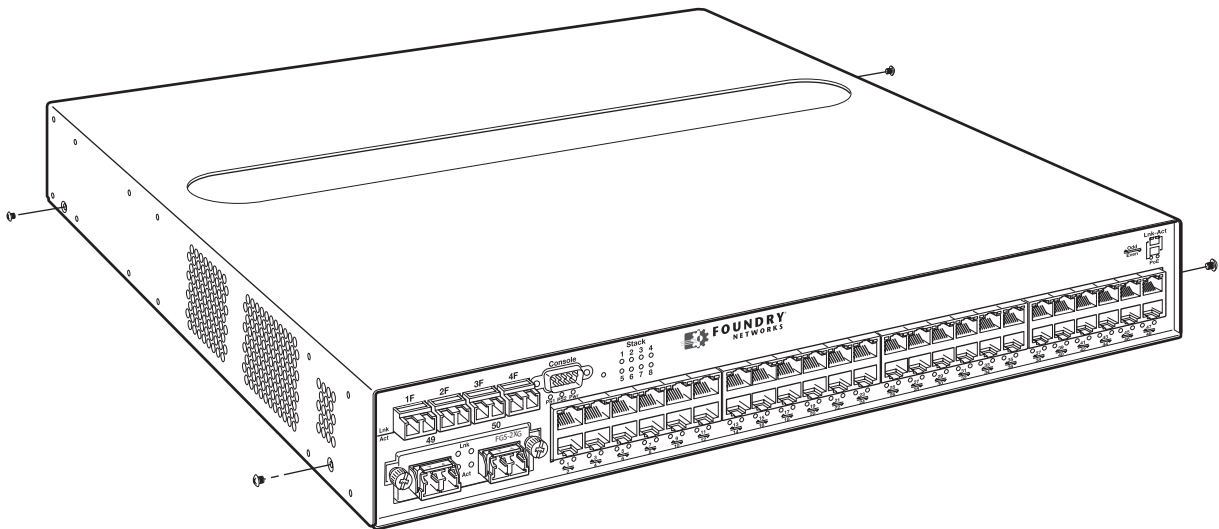

- Gently lift the cover off of the chassis as shown in Figure 7.6.

**Figure 7.6 Removing the Top Cover**

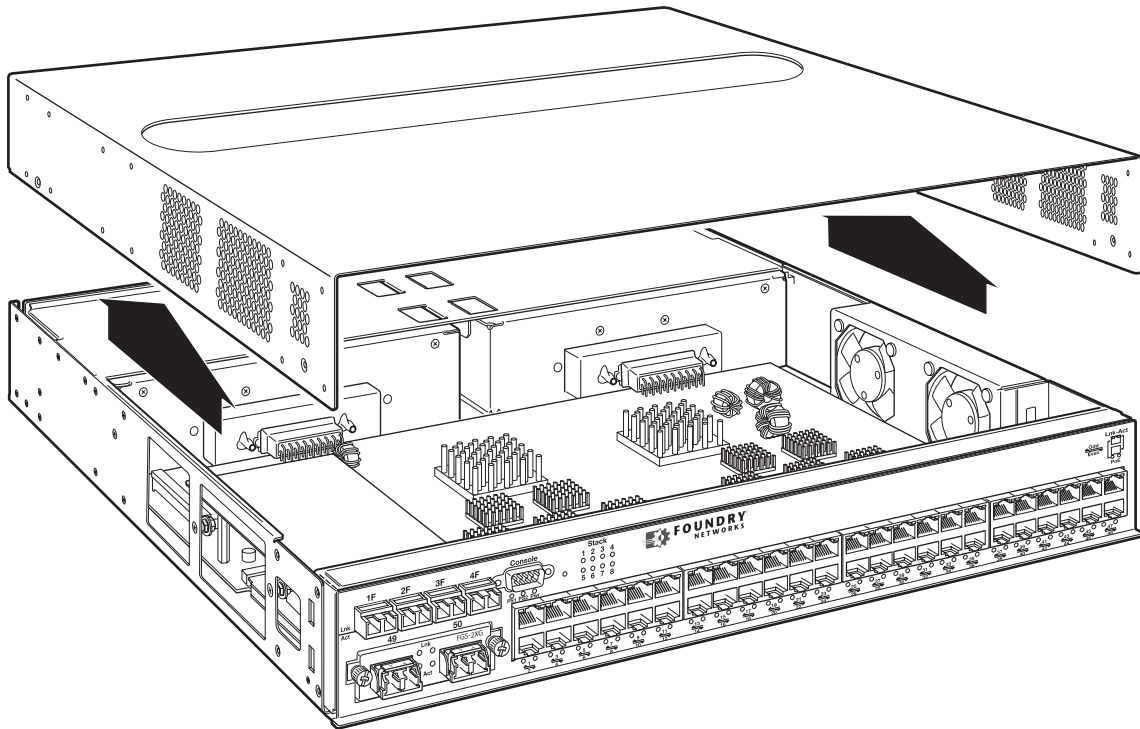

5. Proceed to “Installing a POE Daughter Card” .

### Installing a POE Daughter Card

To replace or install the POE daughter card, do the following:

1. Disassemble the FGS chassis as instructed in the section “Disassembling the Chassis” on page 7-11.
2. If you are replacing the POE daughter card, remove the existing card from the connector slot on the main board. Figure 7.8 and Figure 7.9 show the locations of the POE daughter cards on the main board of the FGS624P-POE and the FGS648P-POE.
3. Install the new POE daughter card:
  - Remove the POE daughter card from its packaging. The POE daughter card is keyed to prevent improper insertion, as shown in Figure 7.7.

**Figure 7.7 POE Daughter Card**

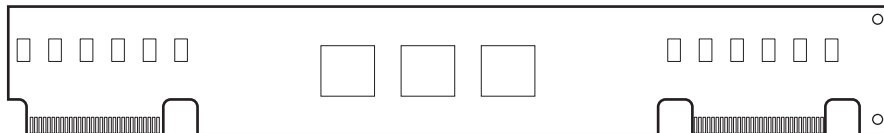

- Locate the connector slots for the POE daughter card on the main board (Figure 7.8 and Figure 7.9).



- Insert the POE daughter card into the connector slot on the main board as shown in Figure 7.8 for the FGS624P-POE and Figure 7.9 for the FGS648P-POE.

Figure 7.8 shows the location of the POE daughter card on the main board of the FGS624P-POE.

**Figure 7.8** Installing a POE Daughter Card in the FGS624P-POE

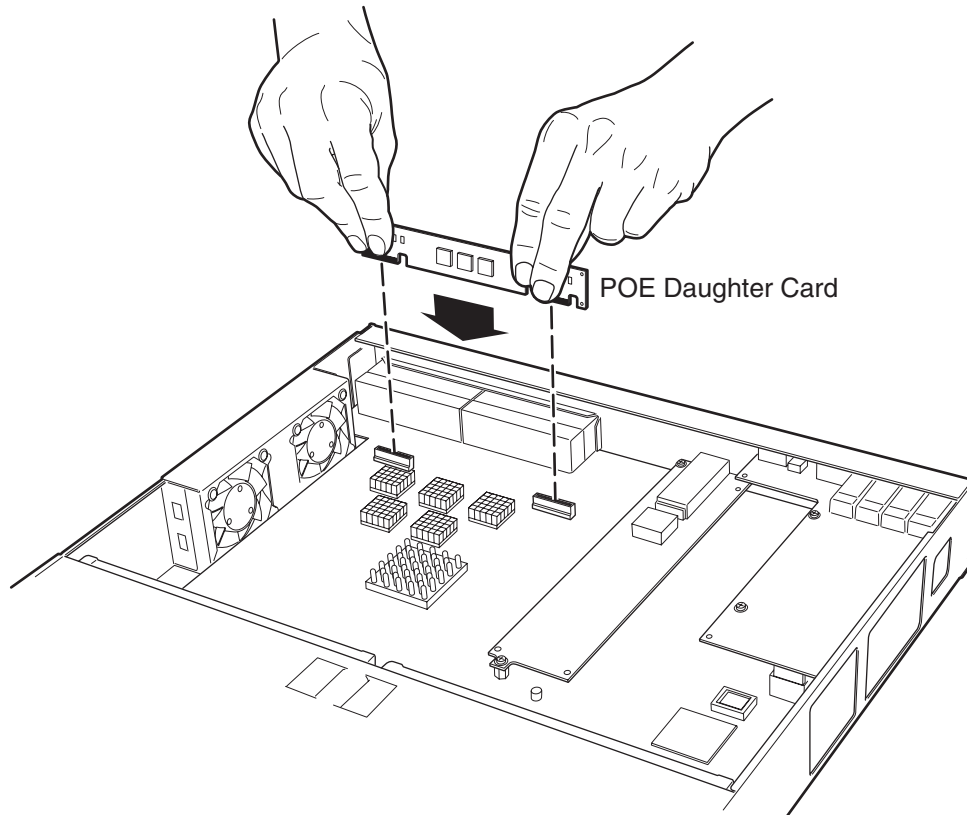
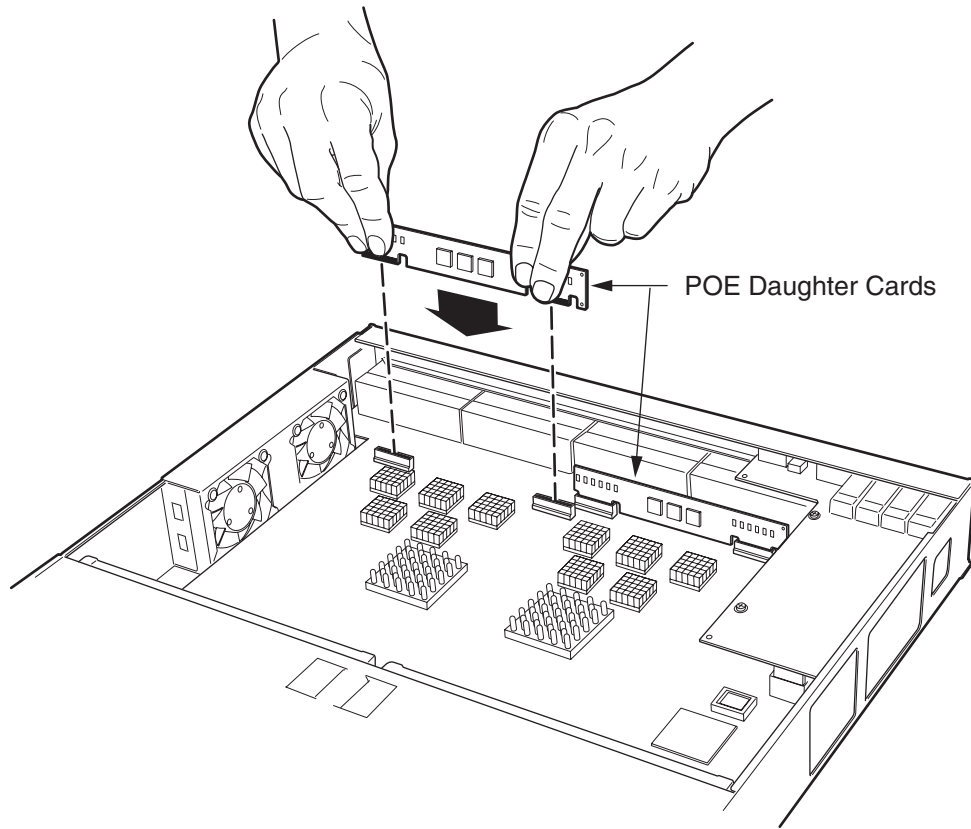

Figure 7.9 shows the location of the POE daughter cards on the main board of the FGS648P-POE.

**Figure 7.9** Installing a POE Daughter Card in the FGS648P-POE



4. Re-assemble the device as instructed in the section “Re-assembling the Chassis” .
5. Power ON the chassis and observe the console. The following message will appear:  

```
Info: PoE module detected in slot 1. Initializing....
```
6. Enable POE and configure POE parameters. See the *Foundry FastIron Configuration Guide* for information.

### Re-assembling the Chassis

This section provides instructions for re-assembling the FGS device after removing, installing, or replacing a 10-GbE module.

1. Replace the device’s cover by gently guiding the cover into place.
2. Once the cover is properly positioned, re-fasten the screws on each side of the cover.
3. If the device is rack-mounted, replace the mounting brackets.

## Replacing a Fiber Optic Module

You can remove an SFP or XFP from a port and replace it with a new one while the FGS is powered on and running.

This section provides information about the following tasks:

- Removing a fiber optic module
- Installing a new fiber optic module
- Cabling a fiber optic module

### Removing a Fiber Optic Module

You can remove a fiber SFP (also called a mini-GBIC) or an XFP from a port while the FGS is powered on and running.

Before removing a fiber optic module, have the following on hand:

- An ESD wrist strap with a plug for connection to the ESD connector on the FGS.

---

**WARNING:** For safety reasons, the ESD wrist strap should contain a series 1 meg ohm resistor.

---

- The protective covering that you removed from the fiber optic module when you initially installed the module.

To remove a fiber optic module from a Gigabit Ethernet or 10-Gigabit Ethernet port, do the following:

1. Put on the ESD wrist strap and ground yourself by attaching the clip end to a metal surface (such as an equipment rack).
2. Disconnect the fiber cable connector from the port connector.
3. Insert the protective covering into the port connectors.
4. Pull the fiber optic module out of the port by pulling the bail latch forward, away from the front panel of the module. This unlocks the module from the front panel.

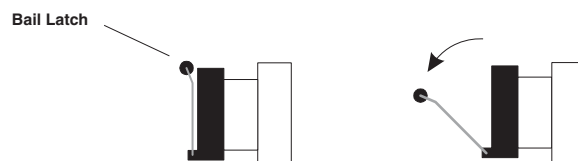



---

**NOTE:** The bail latch may be attached to either the top or the bottom of the mini-GBIC.

---

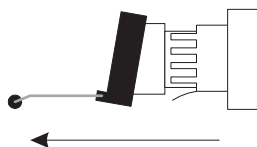
5. Grasping the bail latch, pull the fiber optic module out of the port.



6. Store the fiber optic module in a safe, static-free place or in an anti-static bag.
7. Install a new fiber optic module in the port. For information about performing this task, see "Installing a New Fiber Optic Module" .

## Installing a New Fiber Optic Module

You must install a fiber optic module (SFP or XFP transceiver) in each Gigabit Ethernet and 10-Gigabit Ethernet fiber port you want to use.

You can install a new fiber optic module in a port while the Foundry device is powered on and running.

To install a fiber optic module, you will need an ESD wrist strap with a plug for connection to a metal surface.

---

**WARNING:** For safety reasons, the ESD wrist strap should contain a series 1 meg ohm resistor.

---

To install a fiber optic module, do the following:

1. Put on the ESD wrist strap and ground yourself by attaching the clip end to a metal surface (such as an equipment rack) to act as ground.
2. Remove the new module from its protective packaging.
3. Gently insert the fiber optic module into the port until the module clicks into place. The module is keyed to prevent incorrect insertion.

## Cabling a Fiber Optic Module

To cable a fiber optic module, do the following:

1. Remove the protective covering from the fiber-optic port connectors and store the covering for future use.
2. Before cabling a fiber optic module, Foundry strongly recommends cleaning the cable connectors and the port connectors. See "Cleaning the Fiber-Optic Connectors" on page 7-16.
3. Gently insert the cable connector(s) (a tab on each connector should face upward) into the port connector(s) until the tabs lock into place.
4. Observe the link and active LEDs to determine if the network connections are functioning properly. For more information about the LED indicators, see Table 4.2 on page 4-7.

## Cleaning the Fiber-Optic Connectors

To avoid problems with the connection between the fiber optic module (SFP (mini-GBIC) or XFP) and the fiber cable connectors, Foundry strongly recommends cleaning both connectors each time you disconnect and reconnect them. In particular, dust can accumulate in the connectors and cause problems such as reducing the optic launch power.

To clean the fiber cable connectors, Foundry recommends using the fiber-optic reel-type cleaner that shipped with your Foundry chassis. You can also purchase this type of cleaner from the following Website:

<http://www.fisfiber.com>

When not using an SFP or XFP connector, make sure to keep the protective covering on.

## Digital Optical Monitoring

You can configure your Foundry device to monitor XFPs in the system either globally or by specified port. If monitoring is enabled, console messages, syslog messages, and SNMP traps are sent when XFP operating conditions warrant and a port is enabled.

To configure all XFP ports for optical monitoring, use the following command:

```
FastIron Router(config)#optical-monitor
```

To configure a specific XFP port for optical monitoring, use the following command:

```
FastIron Router(config)#interface ethernet 1/1
FastIron Router(config-if-e10000-1/1)#optical-monitor
```

To configure a range of XFP ports for optical monitoring, use the following command:

```
FastIron Router(config)#interface ethernet 1/1 to 1/2
FastIron Router(config-mif-e10000-1/1-1/2)#optical-monitor
```

**Syntax:** [no] optical-monitor <alarm-interval>

The optional <alarm-interval> variable sets the interval in minutes between which alarms or messages are sent. The default interval is 3 minutes.

You can view the XFP optical monitoring information using the **show optic** command as shown:

```
FastIron Router#show optic 4
Port  Temperature  Tx Power      Rx Power      Tx Bias Current
-----+-----+-----+-----+-----+
4/1   30.8242 C    -001.8822 dBm -002.5908 dBm  41.790 mA
      Normal      Normal          Normal          Normal
4/2   31.7070 C    -001.4116 dBm -006.4092 dBm  41.976 mA
      Normal      Normal          Normal          Normal
4/3   30.1835 C           -000.5794 dBm  0.000 mA
      Normal      Low-Alarm       Normal          Low-Alarm
4/4   0.0000 C           Normal          Normal          0.000 mA
      Normal      Normal          Normal          Normal
```

For Temperature, Tx Power, Rx Power, and Tx Bias Current, values are displayed along with one of the following status values: Low-Alarm, Low-Warn, Normal, High-Warn or High-Alarm. The thresholds that determine these status values are set by the manufacturer of the XFPs. Table 7.1 describes each of these status values.

**Table 7.1: Status Value Description**

Status Value	Description
Low-Alarm	Monitored level has dropped below the "low-alarm" threshold set by the XFP manufacturer.
Low-Warn	Monitored level has dropped below the "low-warn" threshold set by the XFP manufacturer.
Normal	Monitored level is within the "normal" range" set by the XFP manufacturer.
High-Warn	Monitored level has climbed above the "high-warn" threshold set by the XFP manufacturer.
High-Alarm	Monitored level has climbed above the "high-alarm" threshold set by the XFP manufacturer.

**NOTE:** This function takes advantage of information stored and supplied by the XFP device. This information is an optional feature of the Multi-Source Agreement standard defining the XFP interface. Not all component suppliers have implemented this feature set. In such cases where the XFP device does not supply the information, a "Not Available" message will be displayed for the specific port that the device is installed

---

### Supported Media

The following media are currently available and supported by FastIron GD and LS devices:

- CWDM80
- CWDM100
- LHA
- LHB
- 1GE BXD
- 1GE BXU
- 100Mbps BXD
- 100Mbps BXU
- SX2
- 100FX
- 100FX-1R
- 100FX-LR
- OC12-MM

### CLI Commands

The **show media** command displays module information including link length, vendor name, vendor part number, vendor revision, and laser wavelength.

#### [no] optical-monitor <alarm interval>

Use this command to configure monitoring for all ports (system-wide), a range of ports, or a single port. The <alarm-interval> variable sets the interval in minutes between the sending of alarms and messages. The default interval is three minutes. When monitoring is enabled, console messages, syslog messages, and SNMP traps are sent when warranted by optical operating conditions, and a port is enabled.

#### show optic port/slot\_number

This command displays optical monitoring information as a result of the **optical-monitor** configuration command. Information includes:

- temperature
- TX power
- RX power
- TX bias current

Status values are:

- low-alarm
- low-warn
- normal
- high-warn
- high-alarm

---

# Appendix A

## Regulatory Statements

### U.S.A.

This equipment has been tested and found to comply with the limits for a Class A digital device pursuant to Part 15 of the FCC Rules. These limits are designed to provide reasonable protection against harmful interference when the equipment is operated in a commercial environment. This equipment generates, uses, and can radiate radio frequency energy and, if not installed and used in accordance with the instruction manual, may cause harmful interference to radio communications. Operation of this equipment in a residential area is likely to cause harmful interference in which case the user will be required to correct the interference at his own expense.

**CAUTION:** Changes or modifications made to this device which are not expressly approved by Foundry Networks could void the user's authority to operate the equipment.

### Industry Canada Statement

Cet appareil numérique de la classe A est conforme à la norme NMB-003 du Canada.

#### *English Translation of above statement*

This Class A digital apparatus complies with Canadian ICES-003.

### Europe and Australia

This is a Class A product. In a domestic environment this product may cause radio interference in which case the user may be required to take adequate measures.

### Japan

この装置は、情報処理装置等電波障害自主規制協議会（VCCI）の基準に基づくクラス A 情報技術装置です。この装置を家庭環境で使用すると電波妨害を引き起こすことがあります。この場合には使用者が適切な対策を講ずるよう要求されることがあります。

***English Translation of above statement***

This is Class A product based on the standard of the Voluntary Control Council For Interference by Information Technology Equipment (VCCI). If this equipment is used in a domestic environment, radio disturbance may arise. When such trouble occurs, the user may be required to take corrective actions.



---

# Appendix B

## Cautions and Warnings

The cautions and warnings that appear in this manual are listed below in English, German, French, and Spanish.

### Cautions

A caution calls your attention to a possible hazard that can damage equipment.

“Vorsicht” weist auf die Gefahr einer möglichen Beschädigung des Gerätes in.

Une mise en garde attire votre attention sur un risque possible d'endommagement de l'équipement. Ci-dessous, vous trouverez les mises en garde utilisées dans ce manuel.

Un mensaje de precaución le advierte sobre un posible peligro que pueda dañar el equipo. Las siguientes son precauciones utilizadas en este manual.

---

<b>CAUTION:</b>	The FGS power supply is designed exclusively for use with the FGS devices. The power supply produces extensive power to support 802.3af applications. Installing the power supply in a device other than the FGS will cause extensive damage to your equipment.
<b>VORSICHT:</b>	Das Netzgerät FGS ist für den ausschließlichen Gebrauch in Model FGS konzipiert. Installation des Netzgerätes in anderen Geräten als FGS verursacht erheblichen Schaden an Ihrer Anlage.
<b>MISE EN GARDE:</b>	Le bloc d'alimentation FGS est conçu exclusivement pour être utilisé avec les dispositifs FGS. Le bloc d'alimentation produit une alimentation très importante pour prendre en charge les applications 802.3af. Si vous l'installez dans un dispositif autre que les FGS, il endommagera gravement votre équipement.
<b>PRECAUCIÓN</b>	El suministro de corriente alterna del FGS está diseñado exclusivamente para uso con los dispositivos FGS. El suministro de corriente produce suficiente energía para abastecer a las aplicaciones 802.3af. Si se instala el suministro de corriente en un dispositivo que no sea el FGS, se producirán daños de consideración al equipo.

---

**CAUTION:** Remove the power cord from a power supply before you install it in or remove it from the device. Otherwise, the power supply or the device could be damaged as a result. (The device can be running while a power supply is being installed or removed, but the power supply itself should not be connected to a power source.)

**VORSICHT:** Nehmen Sie vor dem Anschließen oder Abtrennen des Geräts das Stromkabel vom Netzteil ab. Ansonsten könnten das Netzteil oder das Gerät beschädigt werden. (Das Gerät kann

während des Anschließens oder Annehmens des Netzteils laufen. Nur das Netzteil sollte nicht an eine Stromquelle angeschlossen sein.)

**MISE EN GARDE:** Enlevez le cordon d'alimentation d'un bloc d'alimentation avant de l'installer ou de l'enlever du dispositif. Sinon, le bloc d'alimentation ou le dispositif risque d'être endommagé. (Le dispositif peut être en train de fonctionner lorsque vous installez ou enlevez un bloc d'alimentation, mais le bloc d'alimentation lui-même ne doit pas être connecté à une source d'alimentation.)

**PRECAUCIÓN:** Retire el cordón de corriente del suministro de corriente antes de instalarlo o retirarlo del instrumento. De no hacerse así, el suministro de corriente o el instrumento podrían resultar dañados. (El instrumento puede estar encendido mientras se instala o retira un suministro de corriente, pero el suministro de corriente en sí no deberá conectado a la corriente).

---

**CAUTION:** Do not install the device in an environment where the operating ambient temperature might exceed 40° C (104° F).

**VORSICHT:** Das Gerät darf nicht in einer Umgebung mit einer Umgebungsbetriebstemperatur von über 40° C (104° F) installiert werden.

**MISE EN GARDE:** N'installez pas le dispositif dans un environnement où la température d'exploitation ambiante risque de dépasser 40° C (104° F).

**PRECAUCIÓN:** No instale el instrumento en un entorno en el que la temperatura ambiente de operación pueda exceder los 40°C (104°F).

---

**CAUTION:** Make sure the air flow around the front, sides, and back of the device is not restricted.

**VORSICHT:** Stellen Sie sicher, dass an der Vorderseite, den Seiten und an der Rückseite der Luftstrom nicht behindert wird.

**MISE EN GARDE:** Vérifiez que rien ne restreint la circulation d'air devant, derrière et sur les côtés du dispositif et qu'elle peut se faire librement.

**PRECAUCIÓN:** Asegúrese de que el flujo de aire en las inmediaciones de las partes anterior, laterales y posterior del instrumento no esté restringido.

---

**CAUTION:** Use a separate branch circuit for each AC power cord, which provides redundancy in case one of the circuits fails.

**VORSICHT:** Es empfiehlt sich die Installation eines separaten Stromkreisweiges für jede Wechselstrom-Elektroschnur als Redundanz im Fall des Ausfalls eines Stromkreises.

**MISE EN GARDE:** Utilisez un circuit de dérivation différent pour chaque cordon d'alimentation C.A. Ainsi, il y aura un circuit redondant en cas de panne d'un des circuits.

**PRECAUCIÓN:** Use un circuito derivado separado para cada cordón de alimentación de CA, con lo que se proporcionará redundancia en caso de que uno de los circuitos falle.

---

**CAUTION:** Ensure that the device does not overload the power circuits, wiring, and over-current protection. To determine the possibility of overloading the supply circuits, add the ampere (amp) ratings of all devices installed on the same circuit as the device. Compare this total with the rating limit for the circuit. The maximum ampere ratings are usually printed on the devices near the input power connectors.

**VORSICHT:** Stromkreise, Verdrahtung und Überlastschutz dürfen nicht durch das Gerät überbelastet werden. Addieren Sie die Nennstromleistung (in Ampere) aller Geräte, die am selben Stromkreis wie das Gerät installiert sind. Somit können Sie feststellen, ob die Gefahr einer Überbelastung der Versorgungsstromkreise vorliegt. Vergleichen Sie diese Summe mit der

Nennstromgrenze des Stromkreises. Die Höchstnennströme (in Ampere) stehen normalerweise auf der Geräterückseite neben den Eingangsstromanschlüssen.

**MISE EN GARDE:** Assurez-vous que le dispositif ne risque pas de surcharger les circuits d'alimentation, le câblage et la protection de surintensité. Pour déterminer le risque de surcharge des circuits d'alimentation, additionnez l'intensité nominale (ampères) de tous les dispositifs installés sur le même circuit que le dispositif en question. Comparez alors ce total avec la limite de charge du circuit. L'intensité nominale maximum en ampères est généralement imprimée sur chaque dispositif près des connecteurs d'entrée d'alimentation.

**PRECAUCIÓN:** Verifique que el instrumento no sobrecargue los circuitos de corriente, el cableado y la protección para sobrecargas. Para determinar la posibilidad de sobrecarga en los circuitos de suministros, añada las capacidades nominales de corriente (amp) de todos los instrumentos instalados en el mismo circuito que el instrumento. Compare esta suma con el límite nominal para el circuito. Las capacidades nominales de corriente máximas están generalmente impresas en los instrumentos, cerca de los conectores de corriente de entrada.

**CAUTION:** All devices with DC power supplies are intended for installation in restricted access areas only. A restricted access area is where access can be gained only by service personnel through the use of a special tool, lock and key, or other means of security, and is controlled by the authority responsible for the location.

**VORSICHT:** Alle Geräte mit DC-Netzteil sind nur für die Installation in Bereichen mit beschränktem Zugang gedacht. Ein Bereich mit beschränktem Zugang ist ein Bereich, zu dem nur Wartungspersonal mit Spezialwerkzeug, Schlüssel oder anderen Sicherheitsvorrichtungen Zugang hat. Dieser Zugang wird von für den Bereich zuständigen Personen überwacht.

**MISE EN GARDE:** Tous les dispositifs avec bloc d'alimentation C.C. sont conçus pour l'installation dans des zones à accès réglementé uniquement. Une zone à accès réglementé est une zone dont l'accès n'est possible qu'au personnel de service utilisant un verrou, une clé ou un outil spécial, ou d'autres moyens de sécurité, et qui est contrôlée par les autorités responsables du site.

**PRECAUCIÓN:** Todos los instrumentos con suministros de corriente continua han sido diseñados únicamente para instalación en áreas restringidas. Se entiende como área de acceso restringido un lugar al que solo puede acceder personal de servicio mediante el uso de una herramienta especial, llave y cerrojo u otro medio de seguridad similar, y que esté controlado por la autoridad responsable de esa ubicación.

**CAUTION:** For a DC system (DC power supply part number RPSDC-FGS), use a grounding wire of at least 10 American Wire Gauge (AWG). The 10 AWG wire should be attached to an agency-approved crimp connector, crimped with the proper tool.

**VORSICHT:** Für ein Gleichstromsystem (Gleichstromnetzteile mit der Teilern RPSDC-FGS) ist ein Erdungsdraht (wenigstens 10 AWG) erforderlich. Der 10 AWG-Draht sollte an einen behördlich genehmigten Crimpverbinder angebracht werden, der mit einem ordnungsgemäßen Werkzeug gecrimpt wurde.

**MISE EN GARDE:** Pour les systèmes C.C. (références du bloc d'alimentation C.C. RPSDC-FGS), utilisez un fil de mise à la terre d'au moins 10 AWG (American Wire Gauge). Ce fil de 10 AWG doit être relié à un connecteur à sertissage homologué, serti avec l'outil approprié. Le connecteur à sertissage doit permettre la sécurisation aux deux vis de borne de terre sur le boîtier.

**PRECAUCIÓN:** Para un sistema de CC (suministro de corriente continua con No. de referencia RPSDC-FGS), utilice un cable de conexión a tierra de calibre de cable norteamericano (AWG) número 10. El cable 10 AWG deberá acoplarse a un conector engarzado aprobado, y engarzado con la herramienta apropiada.

- CAUTION:** For the DC input circuit to the system (DC power supply part number RPSDC-FGS), make sure there is a 30 amp circuit breaker, minimum -48Vdc, double pole, on the input to the terminal block. The input wiring for connection to the product should be copper wire, 10 AWG, marked VW-1, and rated minimum 90 degrees celcius.
- VORSICHT:** Für den Eingangs-Gleichstromkreis zum System (Gleichstromnetzteile mit der Teilernr. RPSDC-FGS) ist ein 30 A (Minimum), -48 V DC, doppelpolig, am Eingang zur Reihenklemme zu installieren. Bei der Eingangsverdrahtung zum Anschluss des Produkts sollte es sich um einen 10 AWG-Kupferdraht (VW-1) und einer Mindestnenntemperatur von 32° handeln.
- MISE EN GARDE:** Pour le circuit d'alimentation C.C du système (références du bloc d'alimentation C.C. RPSDC-FGS), assurez-vous de la présence d'un disjoncteur de 30 ampères, minimum -48 V C.C., double coupure, sur l'entrée vers le bloc d'alimentation. Les câbles d'alimentation pour le produit doivent être en fils de cuivre, 10 AWG (American Wire Gauge), marqués VW-1 et classés 90 degrés Celsius.
- PRECAUCIÓN:** Para el circuito de entrada de CC al sistema (suministro de corriente continua con No. de referencia RPSDC-FGS), verifique que existe un cortacircuitos catalogado de 30 amperios, como mínimo, -48 VCC, bipolar, en la entrada al bloque terminal. El cableado de entrada para la conexión al producto deberá ser de cable de cobre catalogado, 10 AWG, marcado con VW-1, y tener una capacidad nominal mínima para 90 grados centígrados.
- 

- CAUTION:** Make sure you insert the power supply right-side up. It is possible to insert the supply upside down, although the supply will not engage with the power backplane when upside down. The power supply is right-side up when the power connector is on the left and the fan vent is on the right.
- VORSICHT:** Sicher Sie sicher, dass Sie das Netzteil mit der richtigen Seite nach oben weisend einstecken. Man kann die Karte auch umgekehrt einstecken. Allerdings rastet das umgekehrte Netzteil nicht in die Netzstrom-Rückwandplatine ein. Die rechte Seite des Netzteils weist nach oben, wenn sich der Stromanschlusstecker links und der Ventilatorschlitz rechts befindet.
- MISE EN GARDE:** Assurez-vous d'insérer le bloc d'alimentation dans le bon sens. Il est possible de l'insérer " la tête en bas ", mais le bloc d'alimentation ne s'enclenchera pas dans la face arrière d'alimentation s'il est inséré à l'envers. Le bloc d'alimentation est dans le bon sens lorsque le connecteur se trouve sur le côté gauche et le ventilateur sur la droite.
- PRECAUCIÓN:** Verifique que inserta el suministro de corriente con la cara correcta hacia arriba. Es posible insertar el suministro hacia abajo, pese a que este no se conectará con el enchufe posterior de esta forma. El suministro de potencia estará con la cara correcta hacia arriba cuando el conector de corriente quede a la izquierda y la abertura del ventilador queda a la derecha.
- 

- CAUTION:** Use the erase startup-config command only for new systems. If you enter this command on a system you have already configured, the command erases the configuration. If you accidentally do erase the configuration on a configured system, enter the write memory command to save the running configuration to the startup-config file.
- VORSICHT:** Verwenden Sie den Befehl "Erase startup-config" (Löschen Startup-Konfig) nur für neue Systeme. Wenn Sie diesen Befehl in ein bereits konfiguriertes System eingeben, löscht der Befehl die Konfiguration. Falls Sie aus Versehen die Konfiguration eines bereits konfigurierten Systems löschen, geben Sie den Befehl "Write Memory" (Speicher schreiben) ein, um die laufende Konfiguration in der Startup-Konfig-Datei zu speichern.
- MISE EN GARDE:** N'utilisez la commande erase startup-config que pour les nouveaux systèmes. Si vous entrez cette commande sur un système que vous avez déjà configuré, elle efface la configuration. Si
-

---

vous effacez la configuration par accident sur un système configuré, entrez la commande write memory pour enregistrer la configuration actuelle dans le fichier startup-config.

**PRECAUCIÓN:** Use el comando erase startup-config (borrar configuración de inicio) para sistemas nuevos solamente. Si usted introduce este comando en un sistema que ya ha configurado, el comando borrará la configuración. Si usted borra accidentalmente la configuración en un sistema ya configurado, introduzca el comando write memory (escribir memoria) para guardar la configuración en ejecución en el archivo startup-config.

---

**CAUTION:** Never leave tools inside the chassis.

**VORSICHT:** Lassen Sie keine Werkzeuge im Chassis zurück.

**MISE EN GARDE:** Ne laissez jamais d'outils à l'intérieur du châssis.

**PRECAUCIÓN:** No deje nunca herramientas en el interior del chasis.

---

**CAUTION:** If you do not install a module in a slot, you must keep the slot panel in place. If you run the chassis with an uncovered slot, the system will overheat.

**VORSICHT:** Falls kein Modul im Steckplatz installiert wird, muss die Steckplatztafel angebracht werden. Wenn ein Steckplatz nicht abgedeckt wird, läuft das System heiß.

**MISE EN GARDE:** Si vous n'installez pas de module dans un slot, vous devez laisser le panneau du slot en place. Si vous faites fonctionner le châssis avec un slot découvert, le système surchauffera.

**PRECAUCIÓN:** Si no instala un módulo en la ranura, deberá mantener el panel de ranuras en su lugar. Si pone en funcionamiento el chasis con una ranura descubierta, el sistema sufrirá sobrecalentamiento.

---

**CAUTION:** Changes or modifications made to this device that are not expressly approved by the party responsible for compliance could void the user's authority to operate the equipment.

**VORSICHT:** Falls dieses Gerät verändert oder modifiziert wird, ohne die ausdrückliche Genehmigung der für die Einhaltung der Anforderungen verantwortlichen Partei einzuholen, kann dem Benutzer der weitere Betrieb des Gerätes untersagt werden.

**MISE EN GARDE:** Les éventuelles modifications apportées à cet équipement sans avoir été expressément approuvées par la partie responsable d'en évaluer la conformité sont susceptibles d'annuler le droit de l'utilisateur à utiliser cet équipement.

**MISE EN GARDE:** Si se realizan cambios o modificaciones en este dispositivo sin la autorización expresa de la parte responsable del cumplimiento de las normas, la licencia del usuario para operar este equipo puede quedar anulada.

---

## Warnings

A warning calls your attention to a possible hazard that can cause injury or death. The following are the warnings used in this manual.

"Achtung" weist auf eine mögliche Gefährdung hin, die zu Verletzungen oder Tod führen können. Sie finden die folgenden Warnhinweise in diesem Handbuch:

Un avertissement attire votre attention sur un risque possible de blessure ou de décès. Ci-dessous, vous trouverez les avertissements utilisés dans ce manuel.

Una advertencia le llama la atención sobre cualquier posible peligro que pueda ocasionar daños personales o la muerte. A continuación se dan las advertencias utilizadas en este manual.

---

<b>WARNING:</b>	The procedures in this manual are for qualified service personnel.
<b>ACHTUNG:</b>	Die Verfahren in diesem Handbuch sind nur für qualifiziertes Wartungspersonal gedacht.
<b>AVERTISSEMENT:</b>	Les procédures décrites dans ce manuel doivent être effectuées par le personnel de service qualifié uniquement.
<b>ADVERTENCIA:</b>	Los procedimientos de este manual se han hecho para personal de servicio cualificado.

---

---

<b>WARNING:</b>	All fiber optic interfaces use Class 1 lasers.
<b>ACHTUNG:</b>	Alle Glasfaser-Schnittstellen verwenden Laser der Klasse 1.
<b>AVERTISSEMENT:</b>	Toutes les interfaces en fibres optiques utilisent des lasers de classe 1.
<b>ADVERTENCIA:</b>	Todas las interfaces de fibra óptica utilizan láser de clase 1.

---

---

<b>WARNING:</b>	Make sure the rack or cabinet housing the device is adequately secured to prevent it from becoming unstable or falling over.
<b>ACHTUNG:</b>	Stellen Sie sicher, dass das Gestell oder der Schrank für die Unterbringung des Geräts auf angemessene Weise gesichert ist, so dass das Gestell oder der Schrank nicht wackeln oder umfallen kann.
<b>AVERTISSEMENT:</b>	Vérifiez que le bâti ou le support abritant le dispositif est bien fixé afin qu'il ne devienne pas instable ou qu'il ne risque pas de tomber.
<b>ADVERTENCIA:</b>	Verifique que el bastidor o armario que alberga el instrumento está asegurado correctamente para evitar que pueda hacerse inestable o que caiga.

---

---

<b>WARNING:</b>	Mount the devices you install in a rack or cabinet as low as possible. Place the heaviest device at the bottom and progressively place lighter devices above.
<b>ACHTUNG:</b>	Montieren Sie die Geräte im Gestell oder Schrank so tief wie möglich. Platzieren Sie das schwerste Gerät ganz unten, während leichtere Geräte je nach Gewicht (je schwerer desto tiefer) darüber untergebracht werden.
<b>AVERTISSEMENT:</b>	Montez les dispositifs que vous installez dans un bâti ou support aussi bas que possible. Placez le dispositif le plus lourd en bas et le plus léger en haut, en plaçant tous les dispositifs progressivement de bas en haut du plus lourd au plus léger.
<b>ADVERTENCIA:</b>	Monte los instrumentos que instale en un bastidor o armario lo más bajos posible. Ponga el instrumento más pesado en la parte inferior y los instrumentos progresivamente más livianos más arriba.

---

---

<b>WARNING:</b>	Disconnect the power cord from all power sources to completely remove power from the device.
<b>ACHTUNG:</b>	Ziehen Sie das Stromkabel aus allen Stromquellen, um sicherzustellen, dass dem Gerät kein Strom zugeführt wird.
<b>AVERTISSEMENT:</b>	Débranchez le cordon d'alimentation de toutes les sources d'alimentation pour couper complètement l'alimentation du dispositif.
<b>ADVERTENCIA:</b>	Para desconectar completamente la corriente del instrumento, desconecte el cordón de corriente de todas las fuentes de corriente.

---

<b>WARNING:</b>	Make sure that the power source circuits are properly grounded, then use the power cord supplied with the device to connect it to the power source.
<b>ACHTUNG:</b>	Stellen Sie sicher, dass die Stromkreise ordnungsgemäß geerdet sind. Benutzen Sie dann das mit dem Gerät gelieferte Stromkabel, um es an die Stromquelle anzuschließen.
<b>AVERTISSEMENT:</b>	Vérifiez que les circuits de sources d'alimentation sont bien mis à la terre, puis utilisez le cordon d'alimentation fourni avec le dispositif pour le connecter à la source d'alimentation.
<b>ADVERTENCIA:</b>	Verifique que circuitos de la fuente de corriente están conectados a tierra correctamente; luego use el cordón de potencia suministrado con el instrumento para conectarlo a la fuente de corriente.

---

<b>WARNING:</b>	Do not use the handles on the power supply units to lift or carry a Foundry device.
<b>ACHTUNG:</b>	Die Griffe an den Netzteilen dürfen nicht zum Anheben oder Tragen eines Foundrygeräte verwendet werden.
<b>AVERTISSEMENT:</b>	N'utilisez pas les poignées des unités de bloc d'alimentation pour soulever ou porter un dispositif en châssis.
<b>ADVERTENCIA:</b>	No use las asas de las unidades de suministro de corriente para alzar o transportar un instrumento de Foundry.

---

<b>WARNING:</b>	If the installation requires a different power cord than the one supplied with the device, make sure you use a power cord displaying the mark of the safety agency that defines the regulations for power cords in your country. The mark is your assurance that the power cord can be used safely with the device.
<b>ACHTUNG:</b>	Falls für die Installation ein anderes Stromkabel erforderlich ist (wenn das mit dem Gerät gelieferte Kabel nicht passt), müssen Sie sicherstellen, dass Sie ein Stromkabel mit dem Siegel einer Sicherheitsbehörde verwenden, die für die Zertifizierung von Stromkabeln in Ihrem Land zuständig ist. Das Siegel ist Ihre Garantie, dass das Stromkabel sicher mit Ihrem Gerät verwendet werden kann.
<b>AVERTISSEMENT:</b>	Si l'installation nécessite un cordon d'alimentation autre que celui fourni avec le dispositif, assurez-vous d'utiliser un cordon d'alimentation portant la marque de l'organisation responsable de la sécurité qui définit les normes et réglementations pour les cordons d'alimentation dans votre pays. Cette marque vous assure que vous pouvez utiliser le cordon d'alimentation avec le dispositif en toute sécurité.
<b>ADVERTENCIA:</b>	Si la instalación requiere un cordón de corriente distinto al que se ha suministrado con el instrumento, verifique que usa un cordón de corriente que venga con la marca de la agencia de seguridad que defina las regulaciones para cordones de corriente en su país. Esta marca será su garantía de que el cordón de corriente puede ser utilizado con seguridad con el instrumento.

---

- WARNING:** Power supplies are hot swappable. However, Foundry Networks recommends that you disconnect the power supply from AC power before installing or removing the supply. The device can be running while a power supply is being installed or removed, but the power supply itself should not be connected to a power source. Otherwise, you could be injured or the power supply or other parts of the device could be damaged.
- ACHTUNG:** Netzteile können unter Strom stehend ausgetauscht werden. Allerdings empfiehlt Foundry Networks, dass Sie das Netzteil vom Netzstrom abtrennen, bevor Sie das Netzteil anschließen oder abtrennen. Das Gerät kann während des Anschließens oder Abnehmens des Netzteils laufen. Nur das Netzteil sollte nicht an eine Stromquelle angeschlossen sein. Ansonsten können Sie verletzt oder das Netzteil bzw. andere Geräteteile beschädigt werden.
- AVERTISSEMENT:** Les blocs d'alimentation peuvent être changés à chaud. Cependant, Foundry Networks vous conseille de débrancher le bloc d'alimentation de l'alimentation C.A. avant d'installer ou d'enlever le bloc d'alimentation. Le dispositif peut être en cours de fonctionnement pendant que vous installez ou enlevez un bloc d'alimentation, mais le bloc d'alimentation lui-même ne doit pas être connecté à une source d'alimentation. Sinon, vous risquez d'être blessé ou le bloc d'alimentation ou d'autres pièces du dispositif risquent d'être endommagés.
- ADVERTENCIA:** Los suministros de corriente pueden intercambiarse sin necesidad de ajustes. No obstante, Foundry Networks recomienda que desconecte el suministro de corriente de la toma de corriente alterna antes de instalar o retirar el suministro. El instrumento puede estar activado cuando se esté instalando o retirando un suministro de corriente, pero el suministro de corriente en sí no deberá estar conectado a la fuente de corriente. De no hacerlo así, podría sufrir daños personales o el suministro de corriente u otras piezas podrían resultar dañadas.
- 

- WARNING:** Before beginning the installation, see the precautions in "Power Precautions" on page 2-4.
- ACHTUNG:** Vor der Installation siehe Vorsichtsmaßnahmen unter " Power Precautions " (Vorsichtsmaßnahmen in Bezug auf elektrische Ablagen) auf den Seiten 2 - 4.
- AVERTISSEMENT:** Avant de commencer l'installation, consultez les précautions décrites dans " Power Precautions " (Précautions quant à l'alimentation), pages 2-4.
- ADVERTENCIA:** Antes de comenzar la instalación, consulte las precauciones en la sección " Power Precautions" (Precauciones sobre corriente) que se encuentra en las páginas 2-4.
- 

- WARNING:** For safety reasons, the ESD wrist strap should contain a series 1 meg ohm resistor.
- ACHTUNG:** Aus Sicherheitsgründen sollte ein EGB-Armband zum Schutz von elektronischen gefährdeten Bauelementen mit einem 1 Megaohm-Reihenwiderstand ausgestattet sein.
- AVERTISSEMENT:** Pour des raisons de sécurité, la dragonne ESD doit contenir une résistance de série 1 méga ohm.
- ADVERTENCIA:** Por razones de seguridad, la correa de muñeca ESD deberá contener un resistor en serie de 1 mega ohmio.
- 

- WARNING:** A fully populated chassis is heavy.
- ACHTUNG:** Ein voll bestücktes Gehäuse ist schwer.
- AVERTISSEMENT:** Les châssis sont lourds quand ils sont entièrement remplis.
- ADVERTENCIA:** Un chasis muy concurrido es muy pesado.
-



## Free Manuals Download Website

<http://myh66.com>

<http://usermanuals.us>

<http://www.somanuals.com>

<http://www.4manuals.cc>

<http://www.manual-lib.com>

<http://www.404manual.com>

<http://www.luxmanual.com>

<http://aubethermostatmanual.com>

Golf course search by state

<http://golfingnear.com>

Email search by domain

<http://emailbydomain.com>

Auto manuals search

<http://auto.somanuals.com>

TV manuals search

<http://tv.somanuals.com>