

i.MX27 PDK 1.0 Windows Embedded CE 6.0

Quick Start Guide

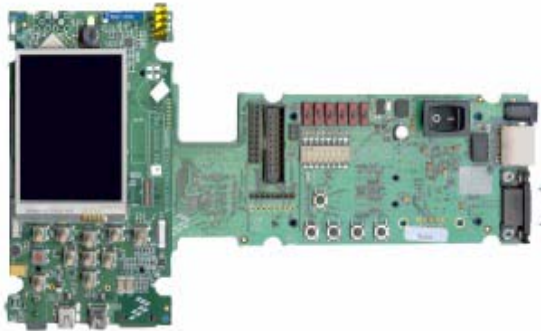

Information in this document is provided solely to enable system and software implementers to use Freescale Semiconductor products. There are no express or implied copyright licenses granted hereunder to design or fabricate any integrated circuits or integrated circuits based on the information in this document.

Freescale Semiconductor reserves the right to make changes without further notice to any products herein. Freescale Semiconductor makes no warranty, representation or guarantee regarding the suitability of its products for any particular purpose, nor does Freescale Semiconductor assume any liability arising out of the application or use of any product or circuit, and specifically disclaims any and all liability, including without limitation consequential or incidental damages. "Typical" parameters that may be provided in Freescale Semiconductor data sheets and/or specifications can and do vary in different applications and actual performance may vary over time. All operating parameters, including "Typicals", must be validated for each customer application by customer's technical experts. Freescale Semiconductor does not convey any license under its patent rights nor the rights of others. Freescale Semiconductor products are not designed, intended, or authorized for use as components in systems intended for surgical implant into the body, or other applications intended to support or sustain life, or for any other application in which the failure of the Freescale Semiconductor product could create a situation where personal injury or death may occur. Should Buyer purchase or use Freescale Semiconductor products for any such unintended or unauthorized application, Buyer shall indemnify and hold Freescale Semiconductor and its officers, employees, subsidiaries, affiliates, and distributors harmless against all claims, costs, damages, and expenses, and reasonable attorney fees arising out of, directly or indirectly, any claim of personal injury or death associated with such unintended or unauthorized use, even if such claim alleges that Freescale Semiconductor was negligent regarding the design or manufacture of the part.

Federal Communications Commission Radio Frequency Interference Statement

This device complies with Part 15 of the FCC rules. Operation is subject to the following two conditions:

- (1) This device may not cause harmful interference and
- (2) this device must accept any interference received, including interference that might cause undesired operation.

Changes or modifications to this equipment not expressly approved by Freescale could void the user's authority to operate the equipment.

Freescale™ and the Freescale logo are trademarks of Freescale Semiconductor, Inc. All other product or service names are the property of their respective owners. Microsoft and Windows are registered trademarks of Microsoft Corporation. RealView is a registered trademark of ARM Limited. ARM9 is the trademark of ARM Limited. The ARM logo is a registered trademark of ARM Ltd. Wi-Fi is a registered trademark of the Wi-Fi Alliance. Bluetooth is a registered trademark of the Bluetooth SIG, Inc., and is used under license. Wi-Fi CERTIFIED is a trademark of the Wi-Fi Alliance.

© Freescale Semiconductor, Inc. 2007 - 2008. All rights reserved.

How to Reach Us:

Home Page:

www.freescale.com

E-mail:

support@freescale.com

USA/Europe or Locations Not Listed:

Freescale Semiconductor
Technical Information Center, CH370
1300 N. Alma School Road
Chandler, Arizona 85224
+1-800-521-6274 or +1-480-768-2130
support@freescale.com

Europe, Middle East, and Africa:

Freescale Halbleiter Deutschland GmbH
Technical Information Center
Schatzbogen 7
81829 Muenchen, Germany
+44 1296 380 456 (English)
+46 8 52200080 (English)
+49 89 92103 559 (German)
+33 1 69 35 48 48 (French)
support@freescale.com

Japan:

Freescale Semiconductor Japan Ltd.
Headquarters
ARCO Tower 15F
1-8-1, Shimo-Meguro, Meguro-ku,
Tokyo 153-0064, Japan
0120 191014 or +81 3 5437 9125
support.japan@freescale.com

Asia/Pacific:

Freescale Semiconductor China Ltd.
Exchange Building 23F
No. 118 Jianguo Road
Chaoyang District
Beijing 100022
China
+86 010 5879 8000
support.asia@freescale.com

For Literature Requests Only:

Freescale Semiconductor Literature Distribution
Center
P.O. Box 5405
Denver, Colorado 80217
1-800-521-6274 or 303-675-2140
Fax: 303-675-2150
LDCForFreescaleSemiconductor@hibbertgroup.com

1	About the Boards	3
	About the 3-Stack Platform System	3
	CPU Board	7
	Debug Board	8
	Personality Board	11
2	Getting Started	13
	Unpack the Kit	13
	CD-ROM Contents	15
	Provide a Development PC	16
3	Build the Platform	17
	Build a Development Platform: Assemble Three Boards.	17
	Connect Personality Board to Debug Board	18
	Connect CPU Board to Debug Board	19
	Connect Development Platform to PC; Run Preloaded Image	20
	Build a Demo Platform: Assemble Two Boards.	21
	Connect CPU Board to Personality Board	21
	Connect Power Supply; Run Preloaded Demo	23
4	Using the Demo Image	25
	Touch Pad Calibration Tool	25
	Downloading Multimedia to the 3-Stack Board	27
	Using Active Sync.	27
	Using an SD Card	32
	Using a USB Memory Stick	33
	Running the Demo Applications.	33
	Running the TV-Out Application	34
	Changing the Windows Embedded CE 6.0 Demo Image Version	42
	Ready to Begin Your Development?	43



i.MX27 PDK 1.0 Quick Start Guide

About the Boards

This chapter provides detailed information about the three boards (CPU, Debug, Personality) and the locations of the connectors and switches for each.

CAUTION Your PDK arrives housed in a plastic device enclosure, which under normal circumstances you should not remove. However, the PDK documentation set includes information for board-level components, and also explains in some documents how to assemble the boards into the enclosure. Should you need to work directly with the boards, please use great caution in handling the components:

- To remove or work with the boards, use static precautions.
- To remove or add the enclosure, first read the enclosure assembly instructions carefully and note which areas are delicate, such as the speakers.

About the 3-Stack Platform System

Freescale introduces the 3-Stack Platform System, which you use to develop multimedia and connectivity applications using the i.MX27 Applications Processor and the MC13783 Audio and Power Management device.

The 3-Stack Platform System decreases the time between first development and final product release by providing you (as the system designer) with a near-to-final product design, which you can use as a development platform for software and hardware.

There are two Board Support Packages (BSP) for the 3-Stack Platform System, with one BSP for Windows Embedded CE™ 6.0, and one BSP for Linux operating systems. These BSPs contain drivers optimized for multimedia operations using the i.MX27 and MC13783 devices.

Freescale's 3-Stack Platform System consists of three small boards: CPU, Debug, and Personality.

- A CPU board contains the i.MX27 CPU, memories, and the MC13783 Power Management IC (PMIC).
- A Debug board provides the debug interfaces (such as JTAG), and also has a CPLD that implements an external Ethernet and serial controller for debug purposes.
- The Personality board implements the functionality of the 3-Stack board, and contains hardware for Wi-Fi connectivity, FM receiver, and so on. The Personality board can be modified to meet your specific requirements without the need to modify the other two boards (CPU, Debug). The Personality board was designed to support

About the Boards

About the 3-Stack Platform System

common multimedia applications, and has a 2.8-inch VGA display, image sensor camera, Wi-Fi CERTIFIED™ IEEE 802.11™ b/g standards, FM receiver, SD Card connector, USB OTG, USB Host, 2.4 QVGA smart display panel connector, ATA connector and TV-Out connector. As the 3-Stack platform continues to evolve, more Personality boards will be created to meet new multimedia requirements. [Table 1.1](#) lists 3-Stack platform features in more detail.

Table 1.1 3-Stack Platform Features

	Details
All boards	<ul style="list-style-type: none">• Near to final product form-factor demonstration modules and working platforms.• Solid reference schematics that closely resemble final products to aid customers' designs.
CPU board	<ul style="list-style-type: none">• i.MX27 ARM9™ Applications Processor• MC13783 Atlas power management chip• 256 MB of NAND Flash Memory• 128 MB of 32 bit DDR SDRAM memory• 37.914 mm x 67.517 mm
Personality board	<ul style="list-style-type: none">• Peripheral components• Interface connectors• 71.428 mm x 129.462 mm
Debug board	<ul style="list-style-type: none">• Two RS-232 interfaces• 10/100 Base-T Ethernet connector• Current measure connectors• 71.400 mm x 174.900 mm
Expansion Headers	<ul style="list-style-type: none">• Utilizing reliable high density connector to interface between boards, 3 board assembly for software development and 2-board assembly (without debug board) for demonstration
Battery Support	<ul style="list-style-type: none">• +4.2 V 2400mAh Battery power supply and Battery Charging Function
LCD Display	<ul style="list-style-type: none">• 2.8 inch TFTLCD display panel with touch panel and LED backlight
Smart LCD Connector	<ul style="list-style-type: none">• 2.4 inch QVGA smart display panel connector
Camera Interface	<ul style="list-style-type: none">• Image sensor camera connector
Selectable Clock Sources	<ul style="list-style-type: none">• Two selectable system clock sources: 32.768 KHz and 26 Mhz

Table 1.1 3-Stack Platform Features

	Details
Debug Port	<ul style="list-style-type: none"> • RealView®-ICE debug support
Video and Audio Stereo	<ul style="list-style-type: none"> • Stereo microphone jack, headphone and video jack, stereo and mono (ear piece) speaker terminals
GPS Connector	<ul style="list-style-type: none"> • One connector to outboard GPS module
FM Receiver	
TV Out	<ul style="list-style-type: none"> • TV decoder that supports 8-bit color, NTSC and PAL formats
PC Card Expansion	<ul style="list-style-type: none"> • SD card connectors, with card sense
Keypad	<ul style="list-style-type: none"> • Onboard keypad and keypad connector
Network Support	<ul style="list-style-type: none"> • Onboard Wi-Fi CERTIFIED™ IEEE 802.11 b/g standards and Bluetooth(r) Core Specification Version 2.0 + EDR (enhanced data rate) combination module • One Ethernet jack connector (for application/debug)
USB	<ul style="list-style-type: none"> • One USB OTG high-speed transceiver with mini-USB connector • One USB high-speed host transceiver, with standard USB host connector
ATA Support	ATA5 controller with <ul style="list-style-type: none"> • One 44-position dual row 2 mm header for small form-factor disk drivers • One 40-pin ZIF connector for Toshiba HDD
Accelerometer	<ul style="list-style-type: none"> • Onboard accelerometer with sensitivity in three separate axes (X, Y, Z)
Serial Port	Two RS-232 interfaces with DB-9 connectors <ul style="list-style-type: none"> • One RS-232 interface is driven by a UART channel internal to the MX27, and it supports DCE with optional full modem controls • The other RS-232 interface is DTE with optional full modem controls

About the Boards

About the 3-Stack Platform System

Table 1.1 3-Stack Platform Features

	Details
Cables	<ul style="list-style-type: none">• 5.0V/2.4A universal power supply kit• RS-232 standard serial cable• High Speed USB cables with mini-AB connectors for OTG• High speed cable with standard A-to-mini-B connectors• Mini-USB adaptor• Jack to RCA audio/video cable• Ethernet cables (2) with RJ45-8 connectors
Software	<ul style="list-style-type: none">• Sample Windows® embedded CE binary image from Freescale• Windows embedded CE BSP available from Freescale
Application Development Tools	<ul style="list-style-type: none">• ATK software• Platform Builder 6.0• Visual Studio 2005

CPU Board

CPU Board



Top



Bottom

J1 Board-to-Board Connector

Figure 1.1 CPU Board

You use the J1 board-to-board connector (500 pins) to connect the CPU board to either of the other two boards:

- Connect the CPU board to a Personality board, for running demos (no Debug board is needed).
- Connect the CPU board to a Debug board, (and connect the Personality board to the Debug board) for developing software. The Personality board plugs into the other side of the Debug board.

Debug Board

Debug Board

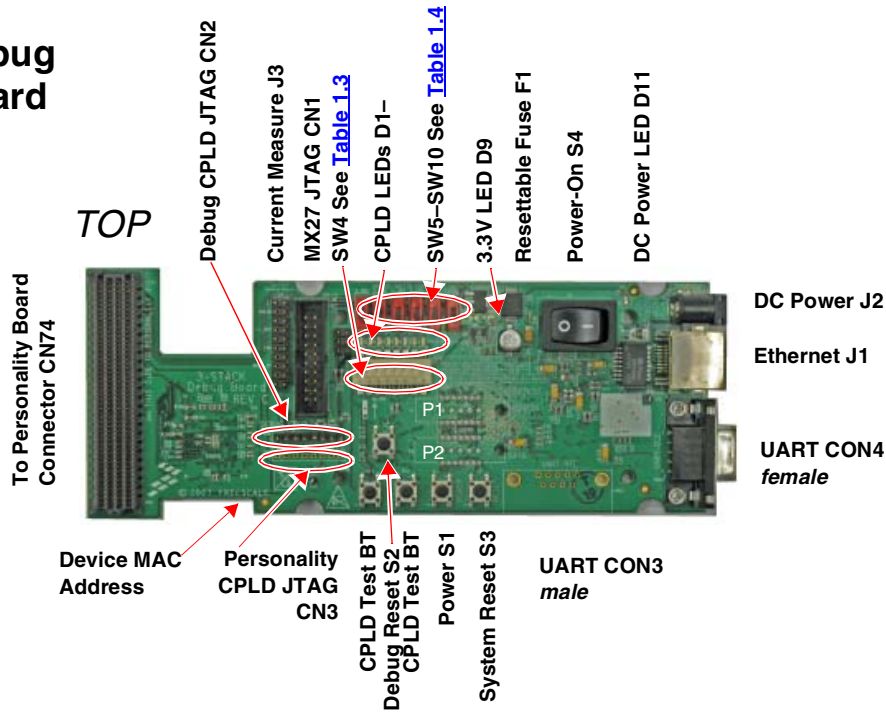

Bottom



Figure 1.2 Debug Board

Table 1.2 Debug Board Physical Features

Type	Physical Feature
Switches	<ul style="list-style-type: none">• S1: Power button• S2: Debug board reset button• S3: System reset switch• S4: Power-on switch• SW4: Enable switch
Connectors	<ul style="list-style-type: none">• J1:10/100 Base-T Ethernet RJ45 connector• J2: 5.0V DC power connector• J3: Current measure connector• J4: 500-pin connector to CPU board• P1: WEIM Address measure connector• P2: WEIM Data measure connector• CN1: i.MX27 JTAG connector• CN2: Debug board CPLD JTAG connector• CN3: Personality board CPLD JTAG connector (Reserved)• CN74: 500-pin connector to Personality board• CON4: UART (DCE) DB9 female connector
LEDs	<ul style="list-style-type: none">• D1–D8: LEDs for CPLD debug• D9: LED for Debug board 3.3V power• D11:LED for DC power supply
Buttons	<ul style="list-style-type: none">• BT1, BT2: Test buttons for CPLD
Fuse	<ul style="list-style-type: none">• F1: Resettable Fuse

About the Boards

Debug Board

Table 1.3 Debug Board SW4 Switch

Switch	Setting	Effect
SW4-1 UART Port Select	ON	Selects serial port UART (DCE) CON4
SW4-8 Power Enable	ON	Power is supplied to all three boards.
	OFF	Power is only supplied to the Debug board.

Table 1.4 Boot Mode Setting (SW5–SW10)

Boot Mode Device	SW5	Boot4 SW6	Boot3 SW7	SW8	SW9	SW10
UART/USB bootloader	X	0	0	0	0	0
8-bit NAND Flash (2KB page) Ext	X	0	0	0	1	0

Personality Board

Personality Board

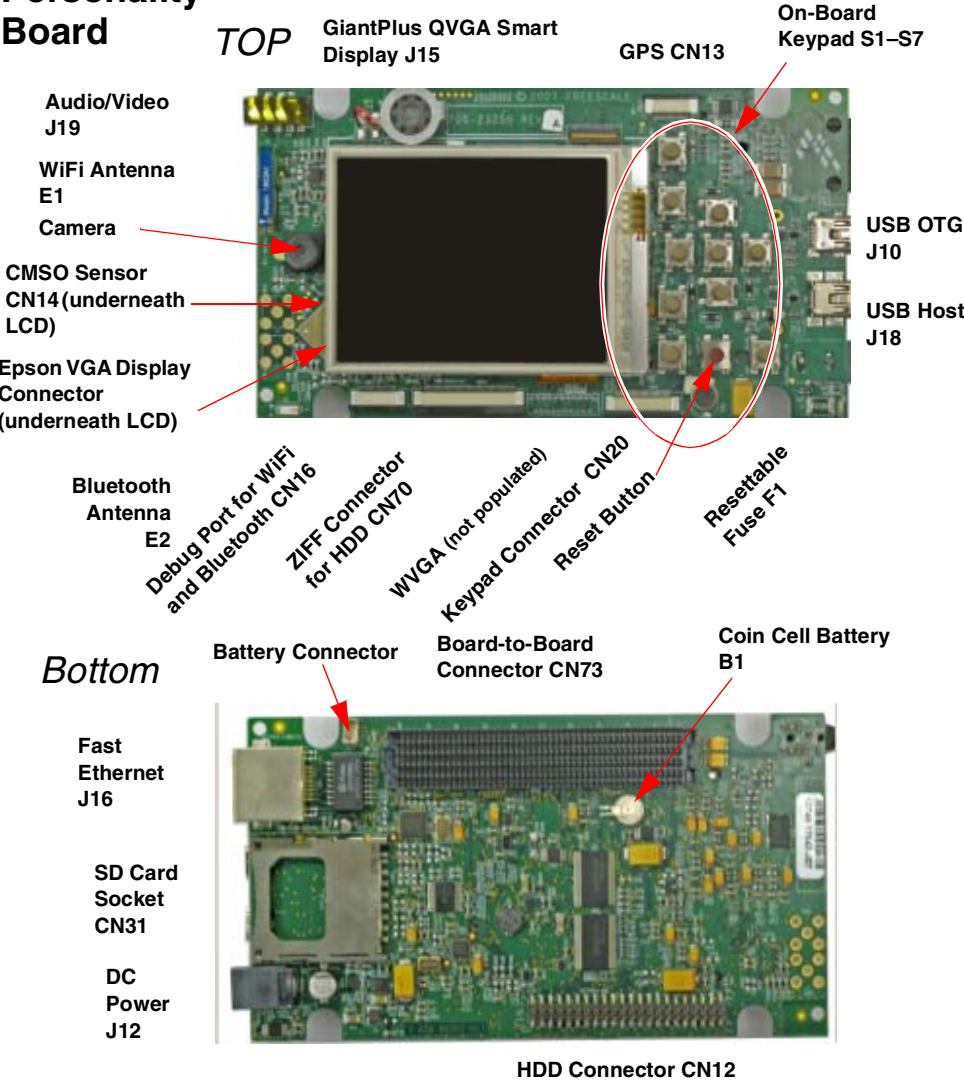

Figure 1.3 Personality Board

Table 1.5 Personality Board Physical Features

Type	Physical Feature
Connectors	<ul style="list-style-type: none">• CN12: 44-position dual row, 2 mm header for HDD• CN13: GPS module connector• CN14: 2.0 M pixel CMOS sensor connector• CN16: Debug port for WiFi and Bluetooth module• CN31: SD card socket• CN70: 40-pin ZIF connector for HDD• CN73: 500-pin connector to CPU Engine board (in demo configuration) or Debug board (in development configuration)• J10: Mini-USBOTG high speed connector• J12: 5.0 VDC power connector• J14: Epson VGA display connector• J15: Giantplus QVGA smart display connector• J16: 10/100 BT Fast Ethernet Connector• J18: Standard USB host high speed connector• J19: Audio and video connector
Battery	<ul style="list-style-type: none">• B1: Coin cell battery
Buttons	<ul style="list-style-type: none">• S7–S17: Onboard keypad
Fuse	<ul style="list-style-type: none">• F1: Resettable fuse
Antennas	<ul style="list-style-type: none">• E1: WiFi Antenna• E2: Bluetooth antenna

Getting Started

Unpack the Kit

The 3-Stack Platform System is shipped with the items listed in [Table 2.1](#).

Table 2.1 Contents

Type	Items
Boards	<ul style="list-style-type: none"> • CPU board • Debug board • Personality board
Cables	<ul style="list-style-type: none"> • RS-232 serial cable • Ethernet straight cable • High-speed USB cables with mini AB connectors for OTG • High-speed cable with standard A to mini B connectors • Mini-USB adaptor • Jack to RCA audio/video cable
Power Supply	<ul style="list-style-type: none"> • 5.0V/2.4A universal power supply kit
	<ul style="list-style-type: none"> • CD-ROMs: Content CD, Platform Builder Trail CD, and Visual Studio 2005 Trial CD • End-User License Agreement • Quick Start Guide (this document) • Warranty card • Freescale Support card

Verify that all the items are contained in the package. See .

Take out the three boards from their anti-static bags and check the boards for any visible damage.

Getting Started

Unpack the Kit

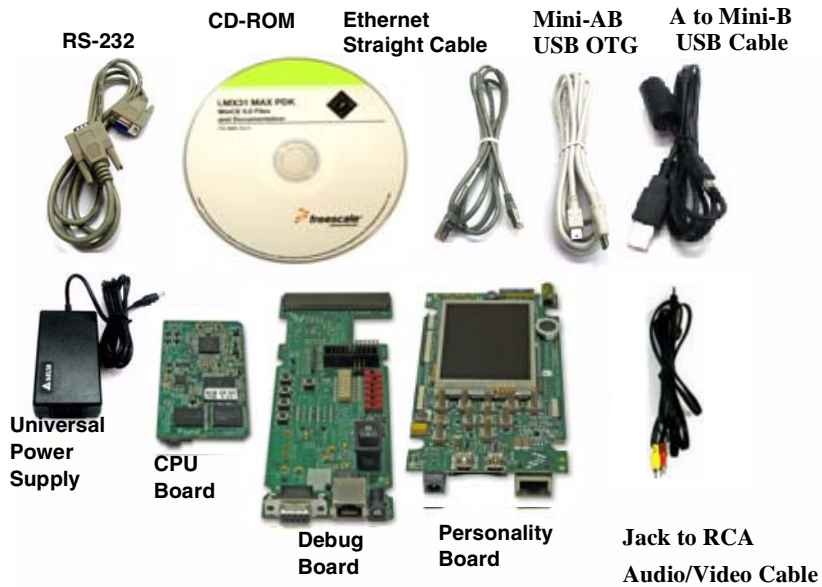

Figure 2.1 PDK Kit Contents

CD-ROM Contents

[Table 2.2](#) identifies the items on the CD-ROM set.

Table 2.2 Development PC Requirements

Type	Requirement
Product Documentation	<ul style="list-style-type: none"> • i.MX27 PDK Product Brief • Bill of Materials, Schematics, and Gerber files for CPU Board, Personality Board, and Debug Board • i.MX27 Demo Image Readme Windows Embedded CE 6.0 • i.MX Platform Hardware User's Guide • i.MX27 PDK Quick Start Guides for Windows Embedded CE 6.0 (this document) • i.MX27 PDK Release Notes for Windows Embedded CE 6.0 • i.MX27 PDK User's Guides for Windows Embedded CE 6.0 • i.MX27 PDK Reference Manuals for Windows Embedded CE 6.0 • i.MX27 PDK Hello World Application Notes for Windows Embedded CE 6.0 • i.MX Platform Advanced ToolKit (ATK) User's Guide
Software Development Tools	<ul style="list-style-type: none"> • Microsoft Platform Builder, versions 6.0 • Visual Studio 2005 • Windows CE 6.0/Windows Embedded CE 6.0 SDK installation file • Advanced ToolKit (ATK) software

Provide a Development PC

To develop applications using the 3-Stack development kit, get a PC with the requirements listed in [Table 2.3](#).

Table 2.3 Development PC Requirements

Type	Requirement
Operating System	<ul style="list-style-type: none">Windows XP Professional with Service Pack 1 or Windows 2000 Professional with Service Pack 4
Network	<ul style="list-style-type: none">Internet access
Software Tools	<ul style="list-style-type: none">Microsoft .NET Framework, version 1.1
PC HW	<ul style="list-style-type: none">933 MHz Pentium II or later processor; 2 GHz processor recommended512 MB of RAM; 1 GB recommended1 GB of available space required on system drive18 GB of available hard-disk spaceDVD ROM drive1024x768 or higher resolution display with 256 colors

Build the Platform

This chapter explains how to connect the three types of 3-Stack boards (Debug, Personality, CPU) together, to make either a development platform (Personality board + CPU board + Debug board), or a demonstration platform (Personality board + CPU board); and how to connect the 3-Stack platform to your PC. See [Figure 3.1](#).

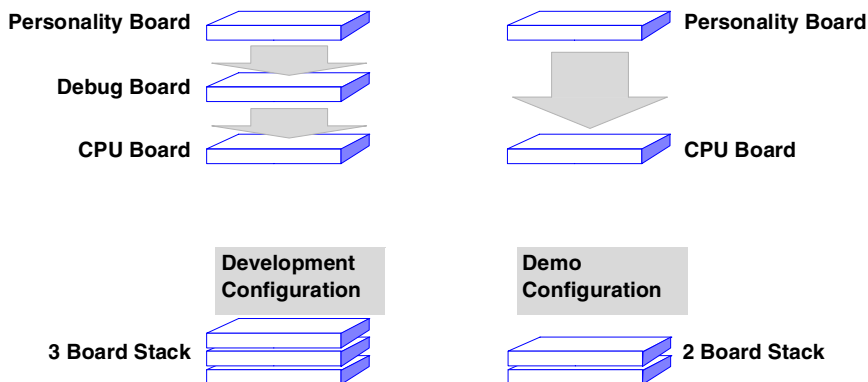

Figure 3.1 3-Stack Platform Configurations

The three 3-Stack boards in your development kit may already be assembled. If the three boards are already assembled, review the procedures in the following sections, and be sure to configure the Debug board appropriately.

- To build a development platform, follow the procedures in [“Build a Development Platform: Assemble Three Boards” on page 17](#).
- To build a demonstration platform, follow the procedures in [“Build a Demo Platform: Assemble Two Boards” on page 21](#).

Build a Development Platform: Assemble Three Boards

This section explains how to connect the Personality, Debug, and CPU boards.

Build the Platform

Build a Development Platform: Assemble Three Boards

Connect Personality Board to Debug Board

The Personality board connects to the Debug board using a 500-pin connector. The connector is keyed to avoid misconnection, so there is only one way to connect these boards. Connect the Personality board to the Debug board. The maximum allowable angle for mating and unmating boards is 10 degrees. See [Figure 3.2](#). For additional information, see: <http://samtec.com/ftppub/TESTRPT/tc076--1254reportrev3.pdf>.

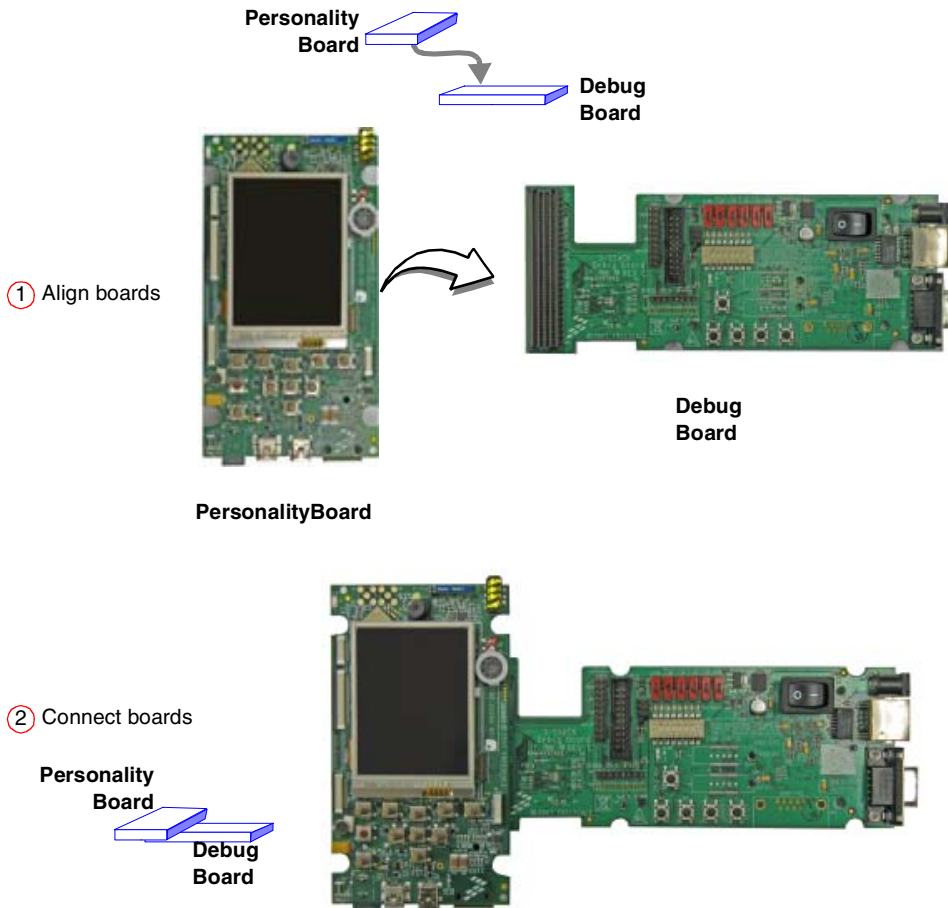

Figure 3.2 Install Personality Board onto Debug Board

Connect CPU Board to Debug Board

After connecting the Personality board to the Debug board, now connect the CPU board to the underside of the Debug board.

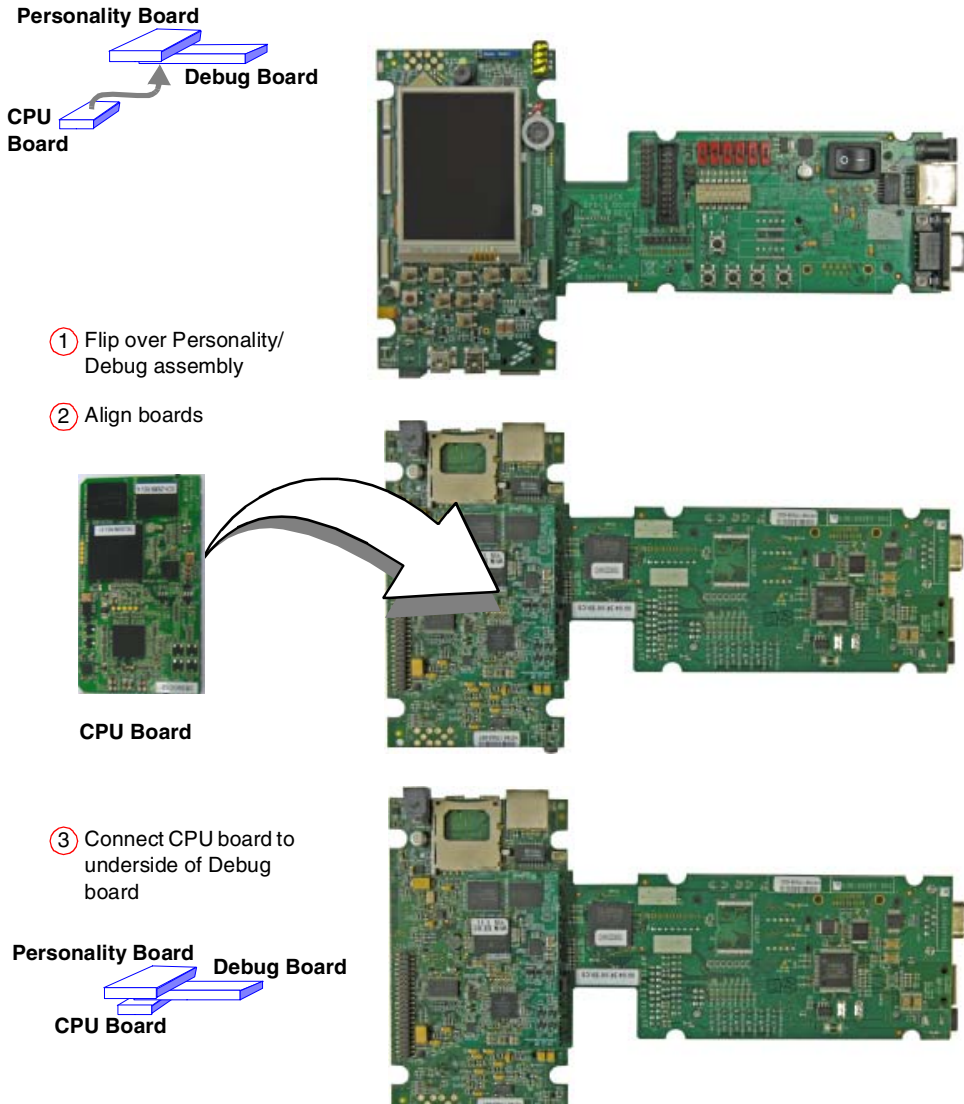

Figure 3.3 Align CPU board and Debug/Personality board

Build the Platform

Build a Development Platform: Assemble Three Boards

Connect Development Platform to PC; Run Preloaded Image

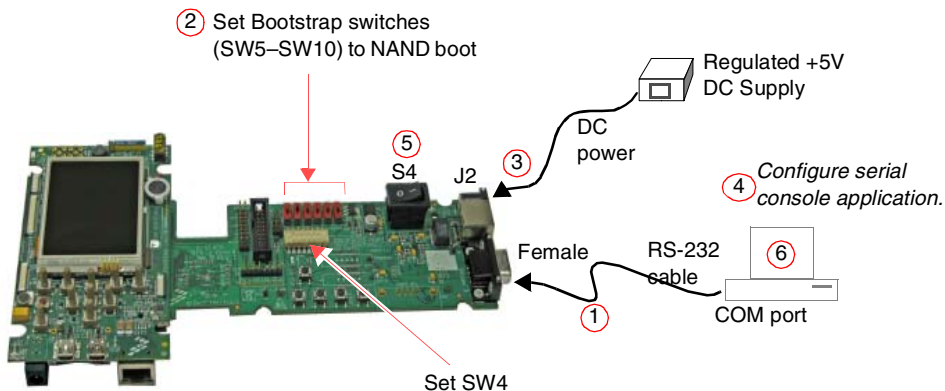

Figure 3.4 Connecting the Platform to your PC

To connect the 3-Stack platform to your host PC:

1. Connect one end of an RS-232 serial cable (included in the kit) to a serial port connector (CON4) on the Debug board and connect the other end to a COM port on the host PC.
 - Configure SW4-1 to ON.
 - Make sure that SW4-8 is ON, to supply power to all three boards.
 - Configure SW4-2 to OFF.
2. Confirm that the Bootstrap switches (SW5–SW10) are set for NAND boot. See [Table 3.1](#).

Table 3.1 Boot Mode Setting (SW5–SW10)

Boot Mode Device	SW5	SW6 (Boot4)	SW7 (Boot3)	SW8	SW9	SW10
UART/USB bootloader	X	0	0	0	0	0
8-bit NAND Flash (2KB page) Ext	X	0	0	0	1	0

3. Connect the regulated 5V power supply to the appropriate power adapter. Plug the power adapter into an electrical outlet and the 5V line connector into the J2 (5V POWER JACK) connector on the Debug board. See Figure 3-5.
4. Start a serial console application on your host PC with the following configuration

Table 3.2 Serial Console Configuration

Baud Rate	115200
Data Bits	8
Parity	None
Stop Bits	1
Flow Control	None

5. On the Debug board, switch the power switch (S4) to 1.
6. The OS image pre-loaded in the 3-Stack board will boot and the debug messages from the bootloader should now appear on the serial console application on your PC.

Build a Demo Platform: Assemble Two Boards

This section explains how to make a demonstration platform using the Personality and CPU boards.

To make a demonstration platform, the CPU board is directly connected to the Personality board using the 500-pin connector; the Debug board is not used.

NOTE If your system is already configured as a development platform (using all three boards), disconnect all boards from each other.

Connect CPU Board to Personality Board

Connect the CPU board to the Personality board. The connector is keyed to avoid misconnections, so that there is only one way to connect the CPU board to the Personality board.

Build the Platform

Build a Demo Platform: Assemble Two Boards

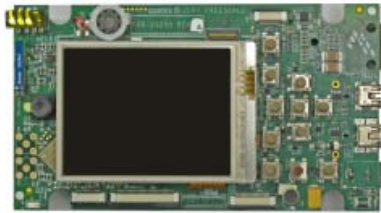
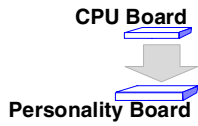

Personality Board

① Flip over Personality/

② Align boards



CPU Board



Personality Board

③ Install CPU board onto underside of Personality board

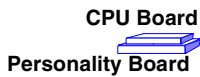

Personality/CPU Assembly

Figure 3.5 Install CPU Board onto Personality Board

Connect Power Supply; Run Preloaded Demo

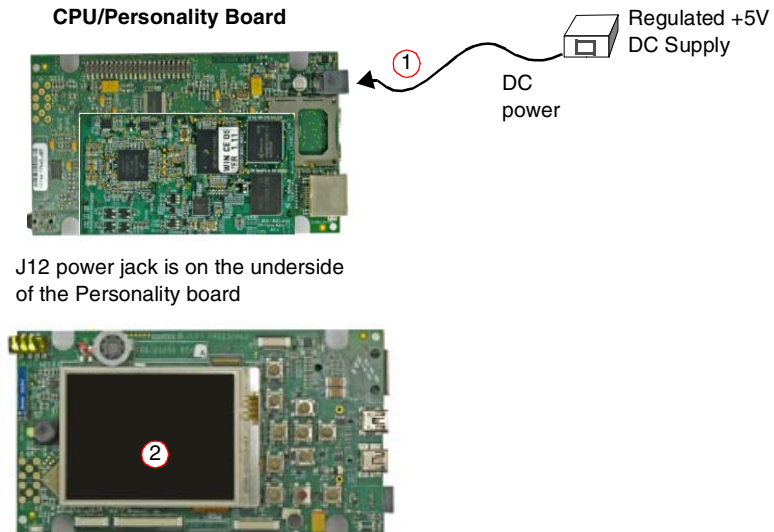

J12 power jack is on the underside of the Personality board

Figure 3.6 Connect Personality Board to Power Supply

1. Connect the regulated 5V power supply to the appropriate power adapter. Plug the 5V line into the J12 (5V POWER JACK) connector on the Personality board. See [Figure 3.6](#). Turn the 5V power supply ON.
2. The OS image pre-loaded in the 3-Stack should boot and the Windows Embedded CE 6.0 operating system should appear at the Personality board's LCD display.

Build the Platform

Build a Demo Platform: Assemble Two Boards

Using the Demo Image

This chapter explains how to use the touch panel and stylus to load the multimedia content to the 3-Stack board, using the provided demo image.

Touch Pad Calibration Tool

After you have assembled the 3-Stack board and powered it up, the Windows Embedded CE 6.0 image that was loaded to the board will boot up. The first image you will see is the touch pad calibration tool, which displays a cross in the center, as shown in the partial screen image in [Figure 4.1](#).

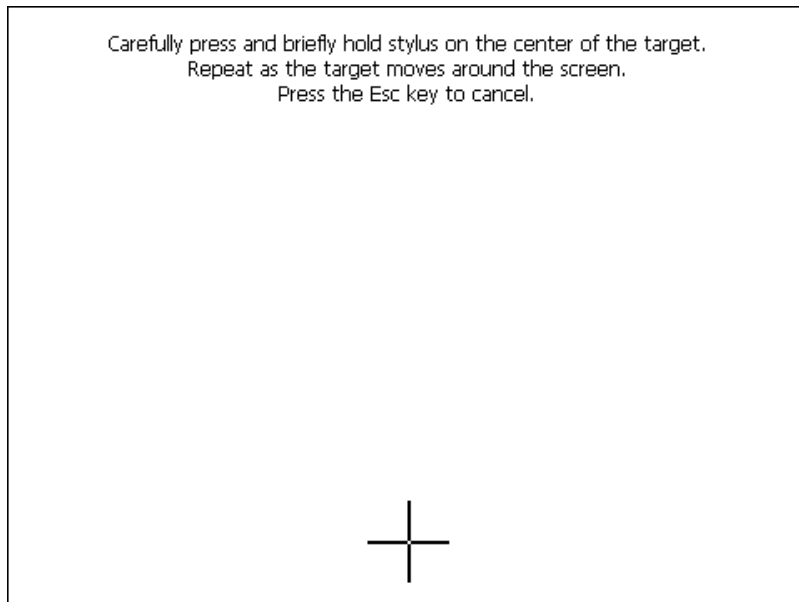

Figure 4.1 Touch Pad Calibration Tool

Using the Demo Image

Touch Pad Calibration Tool

To calibrate the Touch Panel, follow these steps:

1. Using the stylus pen, click on the cross.

The cross will move to the four corners of the screen. If the calibration error is too large, the program will reset and the process will have to be repeated. When the touch panel calibration is successful, the following message is displayed:

New calibration settings have been measured.
Press the Enter key to accept the new settings.
Press the Esc key to keep the old settings.

2. Tap with the stylus pen in any part of the screen.

The Windows CE desktop is displayed (see [Figure 4.2.](#))



Figure 4.2 Windows CE Desktop

Downloading Multimedia to the 3-Stack Board

There are three ways to load multimedia content to the 3-Stack board using the Windows Embedded CE 6.0 image provided:

- Using Active Sync
- Using an SD Card
- Using a USB Card

Using Active Sync

Active Sync is a very useful tool to use with a Windows Embedded CE 6.0 device. To obtain the Active Sync download and instructions, go to:

<http://www.microsoft.com/windowsmobile/activesync/activesync45.msp/>

Once Active Sync is installed, you can set up communication between your host PC and the 3-Stack board.

To establish a communication between the Host PC and the 3-Stack board, follow these steps:

1. Make sure that the 3-Stack board is ON and running the Windows Embedded CE 6.0 image.
2. Make sure that Active Sync is running on your host PC (the Active Sync icon should appear gray on the Windows task bar).
3. Use the A to mini AB USB cable provided in your i.MX27 MAX WPKD kit and connect the mini AB end to the J10 USB OTG connector on the Personality board, then connect the other end to the any available USB port on your Host PC.

Windows will recognize the 3-Stack board as a Windows Embedded CE 6.0 Device and the Active Sync wizard will appear on the Host PC ([Figure 4.3](#)).

Using the Demo Image

Downloading Multimedia to the 3-Stack Board

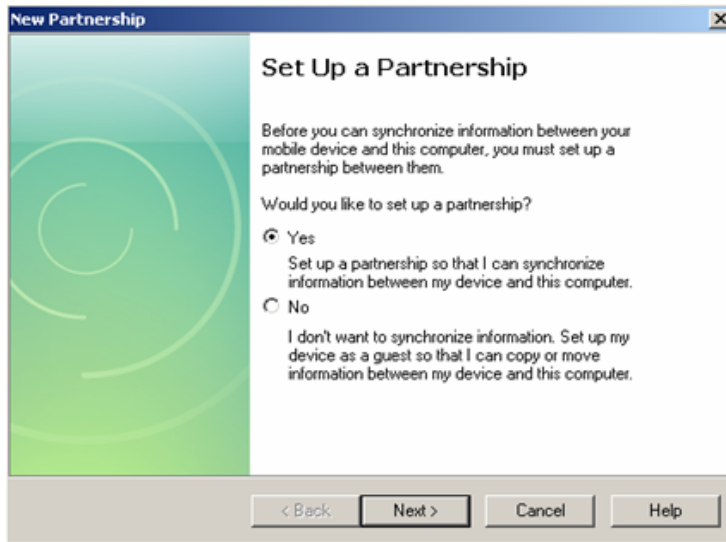

Figure 4.3 Setting up a Partnership

4. Select **Yes**, and then click **Next**.

The Select Synchronization Settings options are displayed (Figure 4.4).

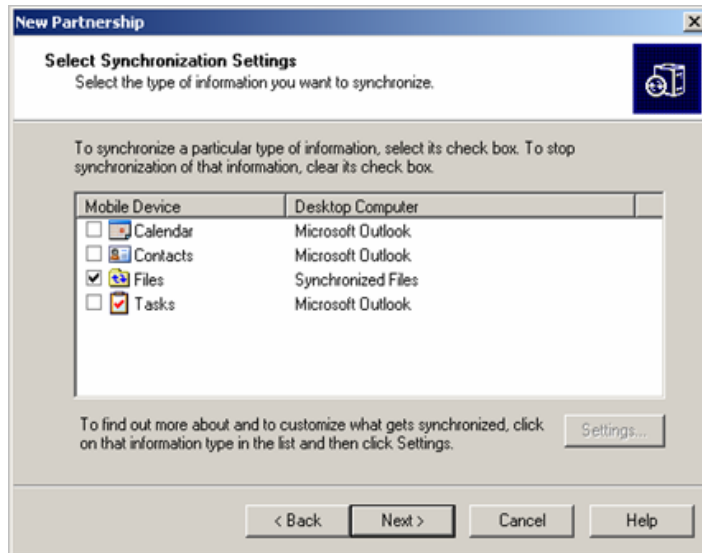

Figure 4.4 Selecting Synchronization Settings

Active Sync establishes communications with the 3-Stack board, and the Active Sync screen displays the connection status (Figure 4.5).

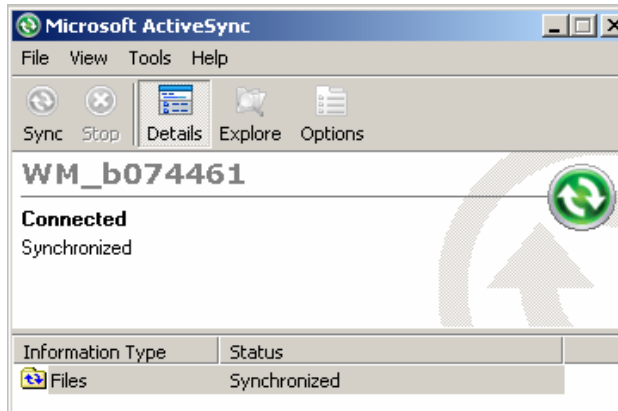

Figure 4.5 Viewing the Connection Status

Using the Demo Image

Downloading Multimedia to the 3-Stack Board

5. To browse the Mobile Device (3-Stack) folders, click on the Explore icon of the Active Sync window

A new Windows Explorer window for your Mobile Device opens on the Host PC (Figure 4.6).

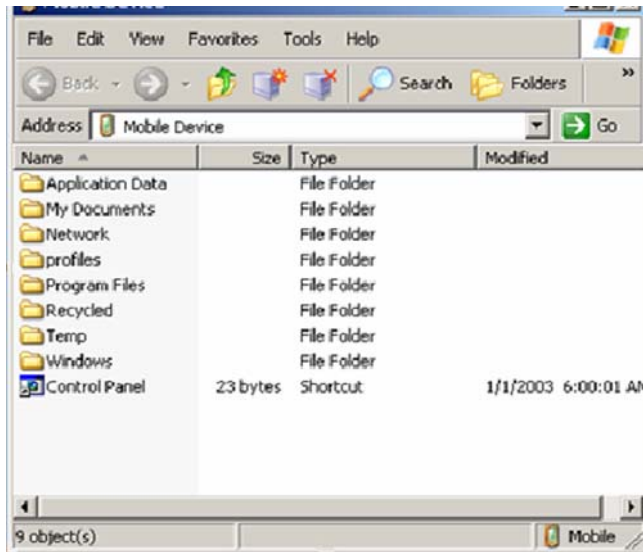

Figure 4.6 Windows Explorer for Mobile Device

6. To download a multimedia file, drag the file to the Mobile Device window.

The Active Sync will transfer the file to the board, display a message indicating that the file will be converted.

7. Click **OK**.
8. The download begins.

NOTE For more information about the multimedia files supported by the Windows Embedded CE 6.0 image pre-loaded in the board, see the Demo Image Readme file included in the PDK documentation.

Using the Demo Image

Downloading Multimedia to the 3-Stack Board

9. To access the files, double-click on the "My Device" icon in the Windows Embedded CE 6.0 desktop (on the 3-Stack board).

A Windows Explorer window will open, displaying the content you downloaded with Active Sync ([Figure 4.7](#)).

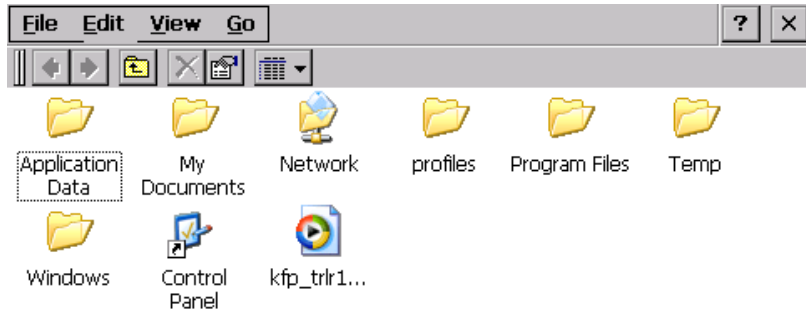

Figure 4.7 Downloaded Content

10. Plug the headphones to the J19 Audio/Video jack connector in the Personality board.
11. Double-click on your multimedia file.

The Media Player opens and plays the file.

Using the Demo Image

Downloading Multimedia to the 3-Stack Board

Using an SD Card

If you have an SD Card with pictures or other multimedia content, you can use the 3-Stack Board to view its content.

To use access the SD Card, follow these steps:

1. Make sure the 3-Stack is powered and running the Windows Embedded CE 6.0 demo image.
2. Insert the SD Card in the SD Card slot, which is located in the lower part of the personality board, just below the USB connectors.
3. Click on "My Device" icon located in the Windows Embedded CE 6.0 desktop.

A Windows Explorer window opens, displaying the SD Memory icon ([Figure 4.8](#)).

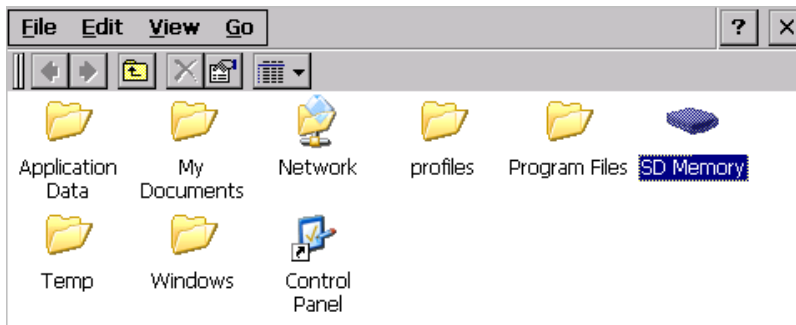

Figure 4.8 Viewing the SD Memory Icon

4. To access the SD Card content, double click-on the SD Memory icon.

Using a USB Memory Stick

You must have a USB mini AB-to-A female connector, for connecting the USB memory stick to the 3-Stack board.

To use the USB memory stick with the 3-Stack board, follow these steps:

1. Make sure the 3-Stack is powered and running the Windows Embedded CE 6.0 demo image.
2. Connect the adapter to J18 USB Host connector on the Personality board, and connect the USB memory stick to the adapter.
3. Click on the "My Device" icon in the Windows Embedded CE 6.0 desktop.

A Windows Explorer window opens, displaying the Hard Disk icon ([Figure 4.9](#)).

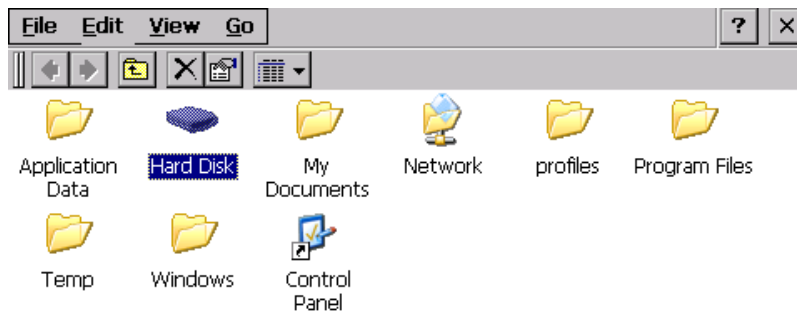

Figure 4.9 Viewing the Hard Disk Icon

4. Double-click the "Hard Disk" icon.

Running the Demo Applications

The applications included in the BSP are: AccTest, FMAApp, CamApp, ETCHA.

The Windows Embedded CE 6.0 image pre-loaded in the 3-Stack board has the following applications:

- The TV-Out application allows you to use a TV as a display

Running the TV-Out Application

The TV Out application has two output formats: PAL and NTSC. You will need a special cable.

To use the TV-Out application, follow these steps:

1. Plug the RCA Video/Audio cable jack to the J19 Video/Audio jack on the Personality board.
2. Connect the RCA end to the TV.
3. Before running the application, you must disable the power-saving features of the Windows Embedded CE 6.0 image, because the TV Out signal will be dropped if the power-saving state starts. To disable the backlight savings, tap and hold the stylus for one or two seconds at the center of the Windows Embedded CE 6.0 desktop.

Using the Demo Image

Running the Demo Applications

The Properties menu option is displayed ([Figure 4.10](#)).

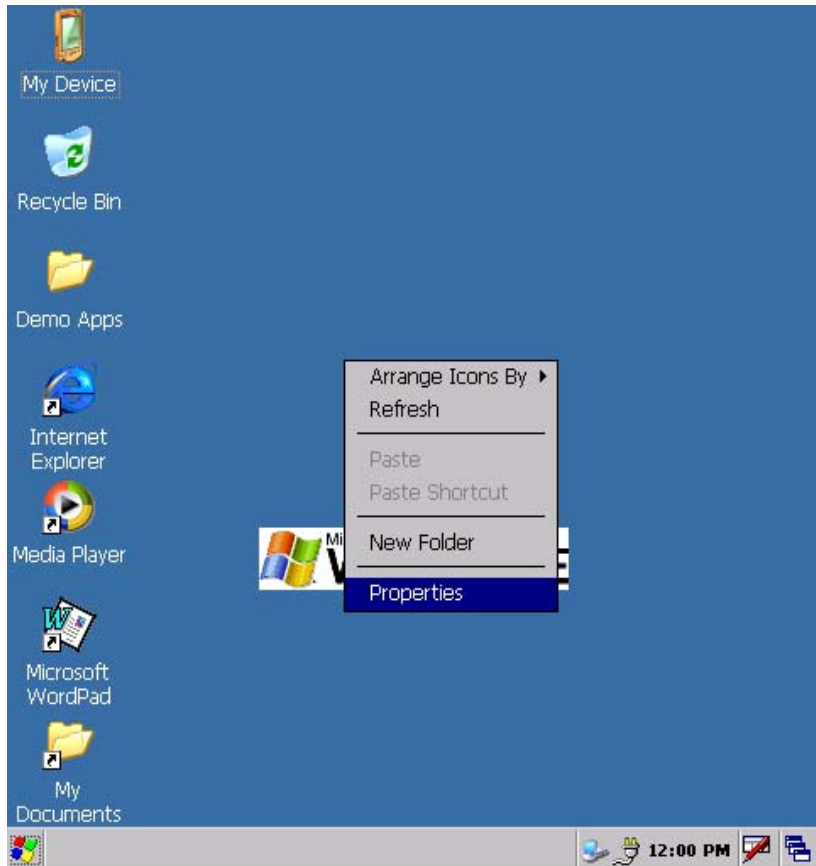

Figure 4.10 Properties Menu Option

Using the Demo Image

Running the Demo Applications

4. Select the Backlight tab, clear the two options on the tab, and then click **OK** at the top right corner of the window ([Figure 4.11](#)).

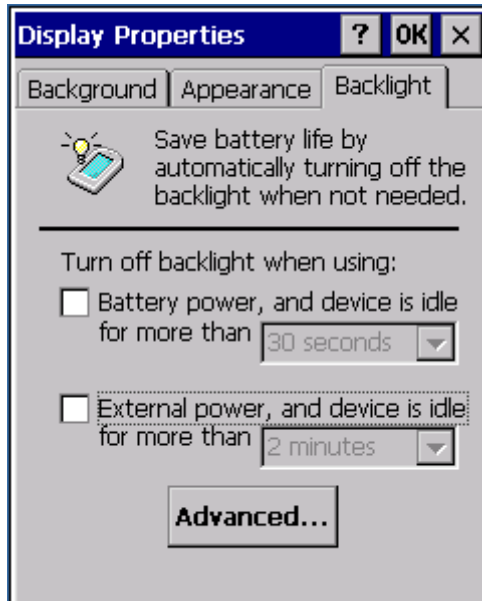

Figure 4.11 Selecting the Background Tab

Using the Demo Image

Running the Demo Applications

5. The power settings on the Control Panel must be modified. To access the Control Panel window, click the Windows logo at the lower left corner and go to Settings Control Panel ([Figure 4.12](#)).

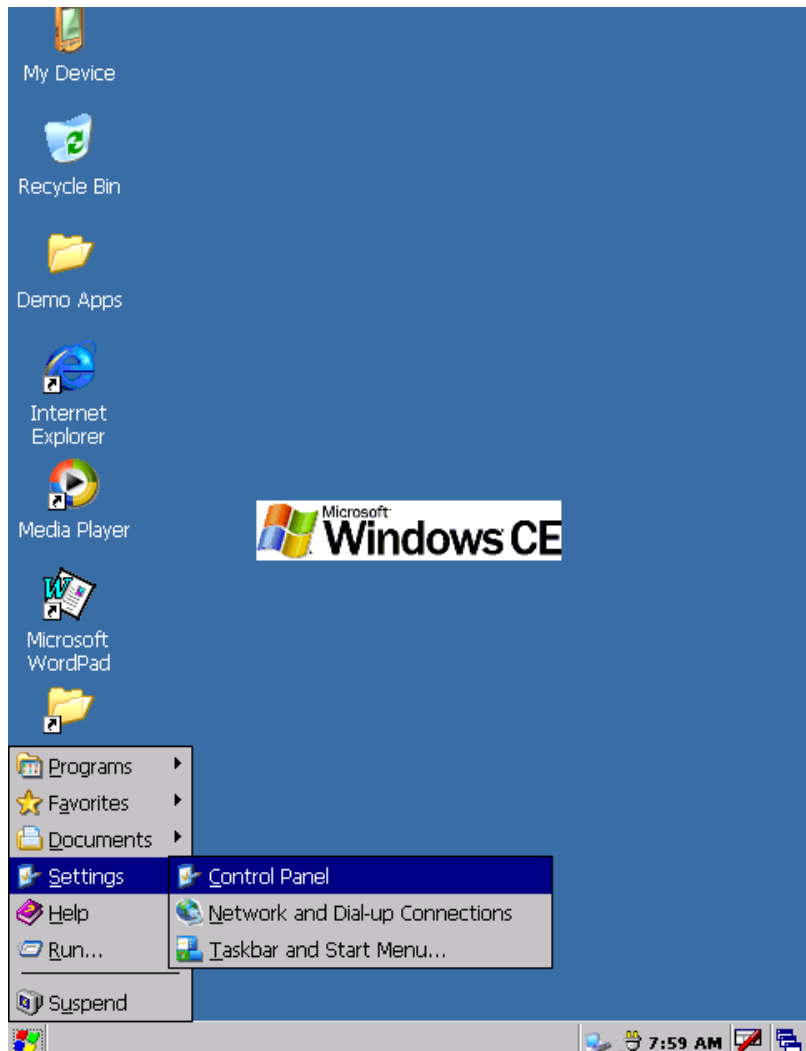

Figure 4.12 Selecting the Control Panel

Using the Demo Image

Running the Demo Applications

6. Double-click the Power icon ([Figure 4.13](#)).



Figure 4.13 Selecting the Power Settings Icon

7. Select the Schemes tab (Figure 4.14).

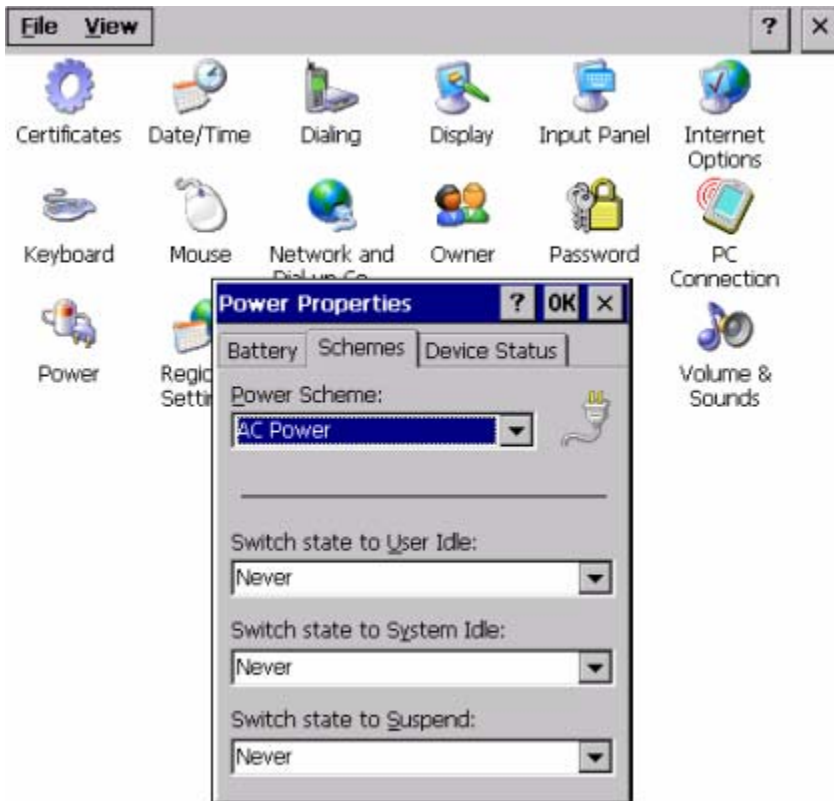

Figure 4.14 Selecting the Schemes Tab

8. Change all the drop-down menu options to **Never**.
9. Click **OK**.

Using the Demo Image

Running the Demo Applications

10. Now that the Power saving options are disabled, you may use the TV-Out program without a problem. To run the program, click on the Windows logo at the lower left corner of the display, and then click **Run** ([Figure 4.15](#)).

The Run field is displayed.



Figure 4.15 Selecting Run

Using the Demo Image

Running the Demo Applications

11. Type "DisplaySwitcher 0" for TVs using PAL format or "DisplaySwitcher 1" for TVs using NTSC format, and then click **OK**. [Figure 4.16](#) shows an example for a NTSC TV.

Once the program runs, the image should appear at the TV.

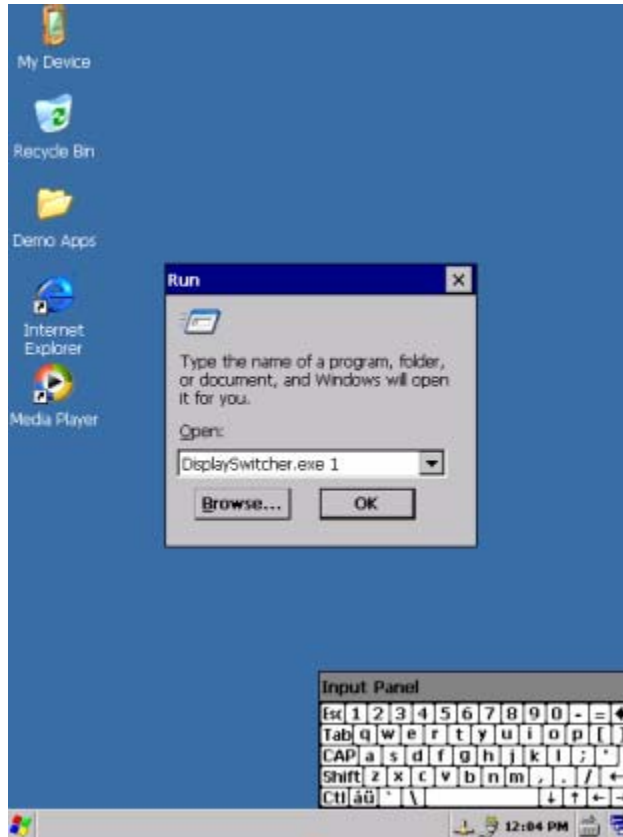

Figure 4.16 Example of an NTSC TV Usage

12. To navigate the desktop, use the keypad located below the display on the Personality board, or you can connect a USB mouse or keyboard to the Personality board using the J18 USB Host connector of the Personality board (a Mini AB to A female adaptor may be required for this option).

Changing the Windows Embedded CE 6.0 Demo Image Version

The PDK system provides one demo image for Windows Embedded CE 6.0.

To obtain instructions for switching images and running the selected version of the Windows Embedded CE 6.0 Demo Image on the PDK system, see your Windows Embedded CE 6.0 package, Chapter 5, Preparing for Download and Debugging.

Ready to Begin Your Development?

If you are ready to develop new applications using the i.MX27 PDK, use the following documents to locate the information required for your development:

- i.MX27 PDK 1.0 Hardware User's Guide provides all of the hardware information for the 3-Stack board, including the connectors, switches, options, and pins.
- i.MX27 PDK 1.0 Windows Embedded CE 6.0 Release Notes provides the tools needed to use the PDK, including the driver availability and known errors.
- i.MX27 PDK 1.0 Windows Embedded CE 6.0 User's Guide explains how to build and modify a Windows Embedded CE 6.0 image and deploy the image to the 3-Stack board.
- i.MX27 PDK 1.0 Windows Embedded CE 6.0 Reference Manual provides detailed information about the Windows BSP drivers, including functional information, dependencies, and building options for each driver.
- i.MX27 PDK 1.0 Windows Embedded CE 6.0 Hello World Application Note explains how to create a simple Hello World application using Microsoft Platform Builder.

For additional information, see the support information in your i.MX27 PDK 1.0 package.

i.MX27 PDK 1.0 Quick Start Guide

PN 926-78297 Rev. A

11/2008

Free Manuals Download Website

<http://myh66.com>

<http://usermanuals.us>

<http://www.somanuals.com>

<http://www.4manuals.cc>

<http://www.manual-lib.com>

<http://www.404manual.com>

<http://www.luxmanual.com>

<http://aubethermostatmanual.com>

Golf course search by state

<http://golfingnear.com>

Email search by domain

<http://emailbydomain.com>

Auto manuals search

<http://auto.somanuals.com>

TV manuals search

<http://tv.somanuals.com>