



FRIEDRICH

1883



ROOM AIR CONDITIONERS



WINDOW / THRU-THE-WALL / PORTABLE

Download from Www.Somanuals.com. All Manuals Search And Download.



F R I E D R I C H

1 8 8 3

SINCE 1883

Friedrich has been manufacturing products of uncompromising quality.

Over the years the products have changed but the devotion to quality has endured.

Friedrich only manufactures air conditioners, and our sole focus is to design and build the very best air conditioners.

You can be assured that your Friedrich air conditioner will provide energy efficient operation, ease of use and outstanding reliability.

Learn more about Friedrich products at friedrich.com

CONTENTS

WHICH PRODUCT IS BEST FOR YOUR NEEDS? _____ PAGE 3

Window Air Conditioners

FIND THE BEST MODEL FOR YOU _____ PAGE 4

PRODUCTS _____ PAGES 5-14

ACCESSORIES _____ PAGE 15

SPECIFICATIONS _____ PAGE 16

INSTALLATION _____ PAGE 17

Thru-the-Wall Air Conditioners

FIND THE BEST MODEL FOR YOU _____ PAGE 18

PRODUCTS _____ PAGES 19, 20

SPECIFICATIONS _____ PAGE 21

ACCESSORIES _____ PAGE 22

INSTALLATION _____ PAGE 22

Portable Air Conditioners

PRODUCTS _____ PAGES 23

SPECIFICATIONS _____ PAGE 24

INSTALLATION _____ PAGE 24

Hazardous Location Room Air Conditioners

PRODUCTS _____ PAGE 25,26

SPECIFICATIONS _____ PAGE 27

INSTALLATION _____ PAGE 27

Which Friedrich product is right for you?

	WINDOW AIR CONDITIONERS			THRU-THE-WALL		PORTABLE	HAZARDOUS LOCATION
	Kühl™	X Star®	CP	WallMaster®	Uni-Fit®	ZoneAire®	Hazardgard®
PERMANENT	Y	Y	Y	Y	Y	N	Y
SEASONAL	Y	Y	Y	—	—	Y	—
CAN BE INSTALLED THRU-THE-WALL	Y	Y	Y -except CP05	Y	Y	—	Y
ENERGY STAR	Y	Y	Y	Y	Y	NA	NA
POWER SUPPLY							
115V	Y	Y	Y	Y	Y	Y	—
230V	Y	—	Y	Y	Y	—	Y
COOLING W/ HEAT							
HEAT PUMP	Y	—	—	Y	—	—	—
ELECTRIC HEAT	Y	Y	—	Y	Y	—	—
EXTRA LARGE CAPACITY							
>17,000 Btu	Y	—	Y	—	—	—	Y
>25,000 Btu	Y	—	—	—	—	—	—
SPECIAL OPTIONS							
ROLLS FROM ROOM TO ROOM	—	—	—	—	—	Y	—
ENHANCED FILTRATION	Y	—	—	—	—	—	—
DECORATOR COLORS	Y	—	—	—	—	—	—

When should you install a solid side sleeve?

A solid side wall sleeve allows for installation in thick exterior walls where the installation of room air units with side vents would effect performance and may even void the warranty.

ROOM AIR CONDITIONER
BLOCKED SIDE VENTS RESTRICT AIR FLOW

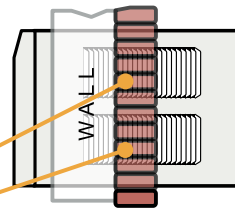

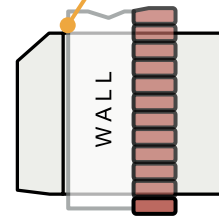
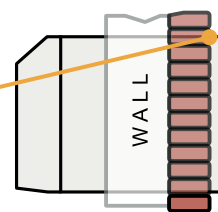

OR SLIMMER INSIDE

FRIEDRICH THRU-THE-WALL
SOLID-SIDE SLEEVE (NO SIDE VENTS) CAN BE INSTALLED IN THICKER WALLS AND CAN BE POSITIONED FLUSH WITH EXTERIOR WALL.



See the complete line of Friedrich products at friedrich.com, including ductless split systems, PTACs and other specialty cooling solutions.

Find the window air conditioner that's best for you.

		ULTRA PREMIUM LINE		PREMIUM LINE		DELUXE LINE
		Kühl™	Kühl+™	XStar®	XStar® + heat	CP
OVERVIEW	Description	Top shelf design and features. Programmability to rival central systems. Trusted Friedrich durability. Designer colors.	All the elegance, performance and durability of Kühl, plus heating. Choose efficient heat pump or toasty electric heat.	Small and powerful. Programmable controls. Easier to self-install and store.	Year 'round use. Heavy duty construction for serious durability. Simple knob controls.	Good value. Available in a large range of cooling capacities. Programmable timer.
	Room size (sq. ft.)	300-2700	350-2700	100-450	300-350	100-1500
	Functions	COOL 	HEAT/COOL  	COOL 	HEAT/COOL  	COOL 
	Applications	AT HOME OR COMMERCIAL USE	AT HOME OR COMMERCIAL USE	AT HOME OR COMMERCIAL USE	AT HOME OR COMMERCIAL USE	AT HOME OR LIGHT COMMERCIAL USE
COMFORT & CONVENIENCE	Electronic controls	Y	Y	Y	—	Y
	Programmable timer	7-day with up to 4 settings per day	7-day with up to 4 settings per day	24 hr	—	CP05, CP06, CP08, CP10 and CP12 have 12 hr. CP15, CP18, and CP24 have 24 hr.
	Remote control	LCD	LCD	Y	—	LCD except CP15, CP18, CP24
	Wall thermostat capability	Y	Y	—	—	—
	Auto restart w/setting retention	Y	Y	Y	NA	Y
	Auto temp/ fan speed adjustment	Y	Y	Y	—	—
	Comfortwatch technology	Y	Y	Y	—	—
	Air flow directions	8	8	8	8	4
	Auto swing louvers	—	—	—	—	All except CP05
Optional color fronts	Y	Y	—	—	—	
SOUND REDUCTION TECHNOLOGY	Steel inner wall and extra dense insulation	Y	Y	Y	Y	—
	Vibration isolating design and components	Y	Y	Y	Y	—
	Superior airflow design	Y	Y	—	—	—
EARTH FRIENDLY	Energy Star models	Y	Y	Y	—	Y
	Environmentally friendly R-410A	Y	Y	Y	Y	Y
	Energy saver switch	Y	Y	Y	—	Y
	RoHS compliant	Y	Y	—	—	—
HEALTH	Washable, antimicrobial air filter	Y	Y	Y	Y	Y
	Optional carbon filter	Y	Y	—	—	—
	Electronic maintenance indicator including check filter reminder	Y	Y	—	—	—
	Superior fresh air intake/stale air exhaust	Y	Y	—	—	Stale air exhaust only, all except CP05
SAFETY	EntryGard anti-intrusion protection	Y	Y	Y	Y	Y
	Insect barrier	Y	Y	Y	Y	—
INSTALLATION	Slide-out chassis	Y	Y	Y	Y	All except CP05
	Power cord direction	Left or right	Left or right	Left or right	Left or right	Left or right
	Thru-the-wall installation option	Y	Y	Y	Y	All except CP05
	Window installation hardware	Heavy duty	Heavy duty, available as accessory	Heavy duty	Heavy duty, available as accessory	Standard

ADVANCED ENGINEERING

Friedrich conducts rigorous performance tests to ensure customer satisfaction and safety in our own UL certified lab. Run tests are performed- for up to 120 continuous days- under extreme temperature conditions.

Air flow systems are tested for powerful and precise air distribution using state-of-the-art Computational Fluid Dynamics (CFD). Sound levels are measured and optimized in our Friedrich sound lab to ensure ultraquiet performance. Premium air filters are tested for adsorption capacities and efficiencies. The unit's control software is tested for constant and reliable operation. Packaging exceeds ISTA (International Safe Transit Association) standards in order to withstand transportation hazards.

Advanced design technology. Extensive product testing. It's what you can expect from Friedrich.

SUPERIOR COMPONENTS

What make's Friedrich Kühl ultra premium? Superior components like robust, commercial grade fan motors that run at a lower temperature than smaller fan motors prevent the unit from overheating and contribute to a longer life. Fan motors are also totally enclosed for maximum protection and longer life.

High efficiency, energy efficient compressors mounted on large, vibration-absorbing grommets create smooth, quiet power.



QUALITY CONSTRUCTION

The highest grade materials are used to build a product that will perform reliably season after season.

20 gauge steel is used in order to create a more robust air conditioner cabinet that will withstand years of hard use.

Solid sleeve top keeps out falling debris, which can obstruct the fan and prevent it from turning, thus damaging the unit.

Vibration and noise isolating technology.

Two resilient rings on motor mount prevent metal-to-metal contact, which eliminates extra vibration and noise.

Blower wheel housing made of solid steel for maximum sound reduction.

Scientific refrigeration design
Better design for quieter performance

Rifled copper tubing with greater surface area for heat exchange, increasing the efficiency of the coils, which improves overall efficiency of the unit.

Insulated plenum prevents outside air intrusion.

EntryGard kick-in intrusion protection
Steel retaining wire secures chassis to the sleeve to deter 'kick-in' intrusion.

Firm grip handles make grasping the chassis for installation and removal much easier.



ALUMINUM REAR GRILLE PROTECTS THE UNIT FROM DAMAGE AND VANDALISM. NO ONE ELSE OFFERS THIS FEATURE.



Kühl™ is about choice.

You'll find more options, features and ways to customize your cooling experience than you ever thought possible in a window air conditioning solution.



Satin Silver
(S T A N D A R D)

Kühl Control. Choose from 4 operating options:

1. SIMPLE OPERATION

Turn the unit on, select 'MODE' and make simple up/down temperature adjustments either at the control panel or with included remote. Unit operates until turned off.

2. 7 DAY DEFAULT PROGRAM

Turn the unit on and press 'SCHEDULE' to utilize default settings. (ENERGY STAR® recommended settings for optimum energy efficiency for a typical work week where the home is unoccupied during the day Monday through Friday).

3. 7 DAY CUSTOM PROGRAM

Turn the unit on and program for your preferred comfort levels to maximize energy savings according to your schedule. Up to 4 settings per day, 7 days a week.

4. REMOTE THERMOSTAT OPERATION

The unit can be wired to a wall thermostat and operated remotely. Wall thermostats are available from Friedrich and many retailers and are sold separately.

Innovative technology. Intuitive controls.

LCD PANEL AUTO DIMS WHEN NOT IN USE

NIGHTLIGHT MODE

TEMPERATURE AND FAN ADJUSTMENT MAINTAINS YOUR CHOSEN COMFORT LEVEL

BACK UP SYSTEM SAVES SETTINGS IF POWER IS INTERRUPTED

BUILT-IN, 7 DAY PROGRAMMABLE THERMOSTAT

24 HOUR TIMER

AUDIO FEEDBACK OPTION

AUTO RESTART RETURNS UNIT TO PRIOR SETTINGS AFTER POWER IS INTERRUPTED

ELECTRONIC MAINTENANCE INDICATOR

DISPLAYS SET TEMPERATURE, ROOM TEMPERATURE, OUTDOOR TEMPERATURE, OR DIGITAL CLOCK AS SELECTED

CHECK FILTER REMINDER

KEYPAD LOCKOUT OPTION PROTECTS SETTINGS

RUGGED REMOTE CONTROL WITH FULL LCD DISPLAY





COLOR CHOICES

OPTIONAL DESIGNER COLORS



Deep Red



Designer White



Black Onyx



Cobalt Blue



Classic Beige



Pink Diamond

Kühl Colors.

Kühl's streamlined modern design in Satin Silver can blend in with any décor. Or coordinate a look that complements your space by using any of the six colored front covers (sold separately at retailers or at friedrich.com).



Kühl™ Series



Kühl
7900-36000 Btu
Up to 11.7 EER

Kühl+
Electric Heat
COOLING
11700-36000 Btu
Up to 11.4 EER
ELECTRIC HEAT
10700-17300 Btu

Kühl+
Heat Pump
COOLING
9500-24000 Btu
Up to 11.7 EER
HEATING
7500-23500 Btu

Kühl is the first window air conditioner to provide the centralized control and convenience of a central air conditioning system.

HINGED FILTER ACCESS DOOR
FLIPS OPEN AND FILTER
SLIDES OUT

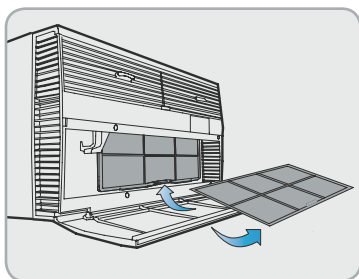

12
Energy Star®
Models

The most comfortable temperature is the one you never notice. Kühl uses five built-in environmental sensors to more accurately monitor indoor and outdoor temperatures so that it can maintain your ideal settings.

Kühl+ models have the ability to cool or heat as needed so units can operate as year-round central systems. And, like the most advanced central systems, Kühl+ has auto-changeover, which allows the unit to automatically switch between air conditioning and heating functions to maintain the desired comfort level. You won't have to lift a finger.



FULL LCD DISPLAY SHOWS
MODE, FAN SPEED, SET
TEMPERATURE AND
SCHEDULE.
ADJUST TEMPERATURE
AND FAN SPEEDS,
SET AUTO MODE AND
TURN THE SCHEDULE ON
OR OFF



WIRE KÜHL TO A REMOTE
THERMOSTAT FOR CENTRAL
AIR-LIKE CONTROL

Comfort & Convenience

- Built-in programmable 7 day thermostat
- 24 hour timer
- Optional wired wall thermostat
- 4 cooling and 4 fan-only speeds on select models
- Automatic fan speed adjustment
- Comfortwatch technology samples the air to more accurately maintain the set temperature
- 8-way air flow control
- Auto-changeover from cool to heat, or heat to cool, to maintain desired temperature (Kühl+ models)
- Temperature readout can alternately display set temperature, room temperature and outdoor temperature, or digital clock as selected
- Control panel lockout (ON/OFF)
- Scratch resistant cabinet
- LCD panel auto dims if not in use
- Nightlight mode
- 7 yr. battery provides back up system that saves settings if power is interrupted

Superior Sound Reduction Technology

- Steel inner wall and extra dense insulation materials block outdoor noise
- Vibration isolating design and components diminish traditional operating noise
- Precision engineering maximizes air flow while delivering ultraquiet operation



Superior Filtration

- Superior fresh air intake and stale air exhaust vent
- Washable, antimicrobial air filter
- Check filter reminder
- Optional premium filter when used in conjunction with standard filter provides superior air filtration with ratings as high as MERV 6, while also adsorbing odors and reducing ozone and VOCs
- Hinged door for easy filter access for easier maintenance
- Electronic maintenance indicators with error code storage

Installation Features

- Install in a window or thru-the-wall
- Slide-out chassis for more permanent installation and easier access for maintenance
- Includes heavy duty window installation hardware (optional accessory on Kühl+ models)
- Rugged hardboard side panels for a more permanent installation
- Power cord can run either left or right
- Firm grip handles for easier chassis installation and removal
- Front cover attaches easily and securely. Nut driver included.

Earth Friendly

- Auto Fan mode saves money by conserving energy
- 12 ENERGY STAR® qualified models, including four heat pumps
- Environmentally-friendly R-410A refrigerant used in all models
- Recyclable packaging
- RoHS compliant

Safety & Security Features

- EntryGard anti-intrusion protection- steel retaining wire secures the chassis to the sleeve to deter 'kick-in' intrusion
- Powercord leakage current protected
- Insect barrier
- Protective rear grille

Accessories (sold separately)

- Optional designer colored front covers
- 3 pack of premium carbon filters
- (Kühl +) window installation kits
- Wall thermostat



OPTIONAL CARBON FILTER REMOVES ODORS AND VOCs. ACHIEVES UP TO A MERV 6 RATING

XStar® Series



XQ
COOLING
5500-9500 Btu
Up to 12.0 EER



EQ
COOLING
7500 Btu
10.7 EER
ELECTRIC HEAT
4000 Btu

XQ. 50% smaller with programmable controls and commercial grade quality.

EQ. Heat/cool model with mechanical controls.

The XStar® Series is 50% smaller than our smallest Kühl model and fits in tighter installations. Slide-out chassis is perfect for either window or thru-the-wall installations

XQ Models are programmable, with features that include a 24-hour ON/OFF timer, auto adjusting Smart Fan, and a Money Saver® setting that reduces energy usage to save money.

EQ Model offers supplemental heating in addition to cooling performance.



SELECT MODE, FAN SPEED, ADJUST TEMPERATURE AND SET THE TIMER. (XQ MODEL ONLY)

3

Energy Star®
Models

XQ

Comfort & Convenience

- 24 hour timer lets you program on/off times
- 3 cooling speeds, plus fan-only setting
- Smart Fan adjusts fan speed to maintain desired temperature
- Comfortwatch technology samples the air to more accurately maintain the set temperature
- Money Saver® setting saves money by operating the fan only when cooling
- Ultraquiet operation
- 8-way air flow control
- Auto restart saves settings if power is interrupted

Health

- Washable antimicrobial filter for protection against fungal and bacterial growth

Installation

- Slide-out chassis
- Install in window or thru-the-wall
- Heavy duty installation hardware
- Heavy duty side curtains reduce exterior noise/light
- Power cord can run either left or right out of the side of the unit front
- The industry's smallest Btu slide-out chassis (model XQ05)

Safety Features

- EntryGard anti-intrusion protection
- Insect barrier



THE SMALLEST CAPACITY ROOM AIR CONDITIONER WITH SLIDE-OUT CHASSIS (MODEL XQ05, 5500 Btu)

EQ

Comfort & Convenience

- 2 cooling speeds, 2 heating speeds and fan-only setting
- Ultraquiet operation
- 8-way air flow control

Health

- Washable antimicrobial filter for protection against fungal and bacterial growth

Installation

- Slide-out chassis
- Install in window or thru-the-wall
- Heavy duty installation hardware
- Heavy duty side curtains reduce exterior noise/light
- Power cord can run either left or right out of the side of the unit front

Safety Features

- EntryGard anti-intrusion protection
- Insect barrier

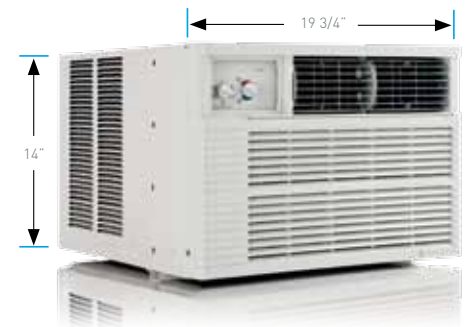

COMPACT SIZE UNITS ARE IDEAL FOR SMALL AREAS OR TIGHT SPACES. CAN BE INSTALLED THRU-THE-WALL OR IN A WINDOW.

CP Series



CP05
COOLING
5500 Btu
10.7 EER



CP06 CP08
COOLING COOLING
6000 Btu 7800 Btu
10.7 EER 10.8 EER



CP10 CP12
COOLING COOLING
10000 Btu 12000 Btu
10.8 EER 10.8 EER

CP05, CP06 AND CP08

Comfort & Convenience

- 12 hour timer lets you program on/off times
- Auto Air Sweep swing louvers* provide more even air distribution
- 3 cooling speeds, plus 3 fan-only settings
- Ultraquiet operation
- 4-way air flow control
- Auto restart saves settings if power is interrupted

Energy Management & Compliance

- ENERGY STAR® qualified
- Money Saver® setting saves money by operating the fan only when cooling

Health & IAQ

- Washable antimicrobial air filter
- Stale air exhaust

Installation Features

- Slide-out chassis**
- Install in window or thru-wall**
- Standard installation hardware
- Expandable side curtains
- Power cord can run either left or right out of the side of the unit front*

Safety & Security Features

- EntryGard anti-intrusion protection

*Feature not available on CP05. **CP05 has a fixed chassis and is for window installation only.

CP10 AND CP12

The CP line is our highly-rated, deluxe line of window air conditioners with programmable controls for convenient operation.

Comfort & Convenience

- 12 hour timer lets you program on/off times
- Auto Air Sweep swing louvers provide more even air distribution
- 3 cooling speeds, plus 3 fan-only settings
- Ultraquiet operation
- 4-way air flow control
- Auto restart saves settings if power is interrupted

Energy Management & Compliance

- ENERGY STAR® qualified
- Money Saver® setting saves money by operating the fan only when cooling

Health & IAQ

- Washable antimicrobial air filter
- Stale air exhaust

Installation Features

- Slide-out chassis
- Install in window or thru-the-wall
- Standard installation hardware
- Expandable side curtains
- Power cord can run either left or right out of the side of the unit front

Safety & Security Features

- EntryGard anti-intrusion protection



SELECT MODE, FAN SPEED, ADJUST TEMPERATURE AND SET THE TIMER.



Auto air sweep swing louvers for even cooling throughout the room

CP Series



CP15	CP18	CP24
COOLING	COOLING	COOLING
14700 Btu	18000 Btu	24000 Btu
10.7 EER	10.7 EER	9.4 EER

Up to two tons of cooling with Auto Air Sweep swing louvers for even cooling throughout the room.

CP15, CP18, CP24

Comfort & Convenience

- 24 hour timer lets you program on/off times
- Auto Air Sweep swing louvers provide even air distribution
- 3 cooling speeds, plus 3 fan-only settings
- Ultraquiet operation
- 4-way air flow control
- Auto restart saves settings if power is interrupted

Energy Management & Compliance

- ENERGY STAR® qualified
- Money Saver® setting saves money by operating the fan only when cooling

Health & IAQ

- Washable antimicrobial air filter
- Stale air exhaust

Installation Features

- Slide-out chassis
- Install in window or thru-the-wall
- Standard installation hardware
- Expandable side curtains
- Power cord can run either left or right out of the side of the unit front

Safety & Security Features

- EntryGard anti-intrusion protection



SELECT MODE, FAN SPEED, AUTO SWING, ADJUST TEMPERATURE AND SET THE TIMER.

3
Energy Star®
Models

OPTIONAL WINDOW AIR CONDITIONER ACCESSORIES

Decorative colored front covers for use with Kühl and Kühl+ models

Basic colors shown below. Additional colors may be available. Ask your sales person or visit www.friedrich.com for more information.



Deep Red



Cobalt Blue



Classic Beige



Designer White



Black Onyx



Pink Diamond

Color Front	Deep Red	Cobalt Blue	Classic Beige	Designer White	Black Onyx
Model	Kit No.				
All SS, ES and YS Models	KWREDS	KWBLUS	KWCBS	KWWHTS	KWBLKS
All SM, EM and YM Models	KWREDM	KWBLUM	KWCBM	KWWHTM	KWBLKM
All SL, EL and YL Models.	KWREDL	KWBLUL	KWCBL	KWWHTL	KWBLKL

Window installation kits (Kühl+ and EQ models)

Heavy duty kits required for installation of these models in a window.

Heat/Cool Models	Kit No.
EQ08M11	WIKQ
ES12M33, ES15M33, YS10M10 and YS12M33.	KWIKS
EM18M34, EM24M34 and YM18M34.	KWIKM
EL36M35 and YL24M35.	KWIKL

Drain kit for use with Kühl and Kühl + models

Drain tube field installed to the bottom of the base pan.

Model	Kit No.
All Kühl Series Models	DC2

Premium carbon filters for use with Kühl and Kühl + models

Two-stage premium carbon filters for superior air filtration including ozone and VOCs (volatile organic compounds). Up to Merv 6 rating. Sold in packs of 3.

Model	Kit No.
All SS, ES and YS Models	KWCFS
All SM, EM and YM Models	KWCFM
All SL, EL and YL Models.	KWCFL



Remote thermostat- RT5 for use with Kühl and Kühl + models

Digital thermostat for remote operation of Friedrich Kühl and Kühl + models.



Cooling Sizing Guide

The following guide is based on normal room insulation, average number of sun-exposed windows and two-person occupancy.

FT ²	Btu/h
100 - 150	5,000
150 - 250	6,000
250 - 300	7,000
300 - 350	8,000
350 - 400	9,000
400 - 450	10,000
450 - 550	12,000
550 - 700	14,000
700 - 1,000	18,000
1,000 - 1,200	21,000
1,200 - 1,400	23,000
1,400 - 1,600	25,000
1,600 - 1,900	28,000
1,900 - 2,700	36,000

Due to variations in room design, climate zone and occupancy, larger areas may require the use of multiple units to provide the optimal cooling solution. Please consult your retail sales person.

★ ENERGY STAR® qualified

Model	Cooling Capacity Btu	Heating Capacity Btu	Volts Rated	Cooling Amps	Cooling Watts	Heating Amps	Heating Watts	COP	Energy Efficiency Ratio EER	Estimated Yearly Operating Cost	Moisture Removal Pints/HR	Room Side Air Circulation CFM	Sleeve	Net Weight Lbs
Kühl														
★ SS08M10	7900	—	115	6.1	677	—	—	—	11.7	\$54	1.0	265	S	99
★ SS10M10	9500	—	115	7.7	848	—	—	—	11.2	\$68	2.0	260	S	106
★ SS12M10	12000	—	115	10.0	1071	—	—	—	11.2	\$86	3.0	300	S	112
SS14M10	14000	—	115	12.0	1444	—	—	—	9.7	\$115	3.5	325	S	116
★ SS12M30	11700/11200	—	230/208	4.8/4.9	1026/982	—	—	—	11.4/11.4	\$82	2.8	275	S	112
SS15M30	14500/14300	—	230/208	6.4/6.8	1405/1385	—	—	—	10.3/10.3	\$112	3.5	360	S	116
★ SM18M30	17500/17200	—	230/208	7.4/8.0	1635/1617	—	—	—	10.7/10.7	\$131	4.6	350	M	140
★ SM21M30	20800/20700	—	230/208	9.4/10.3	2080/2070	—	—	—	10.0/10.0	\$166	6.0	425	M	132
★ SM24M30	23500/23300	—	230/208	11.2/11.9	2500/2479	—	—	—	9.4/9.4	\$200	10.0	390	M	152
★ SL28M30	27800/27000	—	230/208	13.5/14.4	2865/2812	—	—	—	9.7/9.6	\$229	8.5	600	L	193
★ SL36M30	36000/35700	—	230/208	19.0/20.5	4235/4200	—	—	—	8.5/8.5	\$338	12.0	725	L	212
Kühl + Heat Pump														
★ YS10M10*	9500	7500	115	7.8	812	7.6	743	3.0	11.7	\$65	1.9	285	S	109
★ YS12M33	12100/12100	9400/9000	230/208	5.2/5.4	1120/1120	5.6/5.8	1132/1139	2.4	10.8/10.8	\$89	3.0	265	S	115
★ YM18M34	18200/17800	15500/15400	230/208	8.5/8.9	1838/1798	8.5/8.7	1833/1761	2.6	9.9/9.9	\$147	5.4	370	M	141
★ YL24M35	24000/23600	23500/23200	230/208	11.1/12.0	2474/2433	12.2/14.3	2610/2575	2.6	9.7/9.7	\$198	7.0	600	L	197
Kühl + Electric Heat														
ES12M33	11700/11200	10700/8900	230/208	4.8/4.9	1026/982	16.0/14.7	3500/2900	—	11.4/11.4	\$82	2.8	275	S	113
ES15M33	14500/14300	10700/8900	230/208	6.4/6.8	1405/1385	16.0/14.7	3500/2900	—	10.3/10.3	\$112	3.5	360	S	117
EM18M34	17500/17200	13000/10600	230/208	7.4/8.0	1635/1617	19.5/17.0	4200/3500	—	10.7/10.7	\$131	4.6	350	M	141
EM24M34	23500/23300	13000/10600	230/208	11.2/11.9	2500/2479	19.5/17.0	4200/3500	—	9.4/9.4	\$200	10.0	390	M	153
EL36M35	36000/35700	17300/14300	230/208	19.0/20.5	4235/4200	24.0/22.4	5500/4650	—	8.5/8.5	\$338	12.0	725	L	213
XStar®														
★ XQ05M10	5500	—	115	4.5	491	—	—	—	11.2	\$39	1.0	170	Q	72
★ XQ06M10	6000	—	115	4.9	500	—	—	—	12.0	\$40	1.0	175	Q	72
★ XQ08M10	7500	—	115	6.9	701	—	—	—	10.7	\$56	1.7	175	Q	71
XQ10M10	9500	—	115	9.0	970	—	—	—	9.8	\$77	2.5	180	Q	71
XStar® Electric Heat														
EQ08M11	7500	4000	115	6.9	701	11.2	1290	2.8	10.7	\$56	1.9	175	Q	72
CP														
★ CP05N10A	5500	—	115	4.8	510	—	—	—	10.7	\$41	1.3	135	P1	46
★ CP06F10	6000	—	115	5.1	560	—	—	—	10.7	\$45	1.8	210	P6	51
★ CP08F10	7800	—	115	6.8	720	—	—	—	10.8	\$58	2.3	250	P6	54
★ CP10F10	10000	—	115	8.5	920	—	—	—	10.8	\$74	3.0	270	P7	73
★ CP12F10	12000	—	115	10.2	1110	—	—	—	10.8	\$89	3.3	310	P7	73
★ CP15F10	14700	—	115	12.0	1370	—	—	—	10.7	\$110	3.5	470	P4	121
★ CP18F30	18000/17600	—	230/208	8.1/8.8	1680/1640	—	—	—	10.7	\$135	4.6	570	P5	141
★ CP24F30	24230/23540	—	230/208	10.9/11.8	2580/2500	—	—	—	9.4	\$206	7.0	590	P5	165

* Operates on 115 volt and is not equipped with supplemental heat. Will not provide heat at temperatures below 40°F. Friedrich room air conditioners are designed to operate in outdoor temperatures from 60° F to 115° F.

Due to continuing research in new energy-saving technology, specifications are subject to change without notice.

As an ENERGY STAR® partner, Friedrich Air Conditioning Co. has determined that the selected ENERGY STAR® (★) models meet the ENERGY STAR® guidelines for energy efficiency.

The consumer- through the AHAM Room Air Conditioner Certification Program- can be certain that the AHAM Certification Seal accurately states the unit's cooling and heating capacity rating, the amperes and the energy efficiency ratio.

Estimated yearly operating cost based on a 2007 national average electricity cost of 10.65 cents per kWh.

† The estimated yearly operating cost of this model was not available at the time the range was published.



INSTALLATION INFORMATION / SLEEVE DIMENSIONS

Sleeve	Height	Width	Depth with Front	Shell Depth to Louvers	Minimum Extension Into Room*	Minimum Extension Outside*	Window Width		Thru-the-wall Installation Finished Hole		
			A	B			Minimum**	Maximum	Height	Width	Max. Depth C
Q	14"	19 3/4"	21 3/8"	8 1/2"	5 1/2"	10 3/4"	22"	42"	14 1/4"	20"	8 1/2"
P1†	12"	18 1/2"	15"	5"	3 1/2"	10 3/4"	20 1/8"	36"	NOT FOR THRU-WALL		
P4	17 1/2"	26"	27 5/8"	8 7/8"	5 1/2"	16 5/8"	26 1/2"	42"	17 3/4"	26 1/4"	8 3/8"
P5	17 1/2"	26"	29 3/4"	8 7/8"	5 1/2"	19 1/2"	26 1/2"	42"	17 3/4"	26 1/4"	8 3/8"
P6	14"	18 3/8"	20 7/8"	8 1/8"	4 1/2"	11"	20 1/8"	36"	14 1/4"	18 3/4"	7 1/2"
P7	15"	23 5/8"	22 1/4"	8 3/4"	4 1/2"	12"	25 1/4"	39"	15 1/4"	23 7/8"	8"
S	15 15/16"	25 15/16"	29"	8 3/4"	5 3/4"	16 15/16"	27 3/8"	42"	16 3/16"	26 3/16"	7 3/8"
M	17 15/16"	25 15/16"	29"	8 3/4"	5 3/4"	16 15/16"	27 3/8"	42"	18 3/16"	26 3/16"	7 3/8"
L	20 3/16"	28"	35 1/2"	16 1/2"	5 3/8"	18 15/16"	29 7/8"	42"	20 3/8"	28 1/4"	15 1/8"





* Minimum extensions when mounted in a window.

** Minimum widths achieved using one side curtain assembly as opposed to both in a standard installation.

† Sleeve P1 does not have thru-the-wall hole dimensions, as these units are fixed chassis and should not be installed thru-the-wall.

NOTE: S,M and L sleeves may be installed in window with no side kits if properly installed.

Circuit Rating/ Breaker

Model	Circuit Rating Breaker or T-D Fuse	Plug Face (NEMA#)	Power Cord Length (ft.)	Wall Outlet Appearance
CP05			7	
CP06, CP08, CP10, CP12 and CP15. All XQ MODELS. SS08M10, SS10M10, SS12M10 and SS14M10. EQ08M11. YS10M10.	125V - 15A	5 - 15P	6	
CP18. SS12M30, SS15M30, SM18M30 and SM21M30.	250V - 15A	6 - 15P	4	
CP24. SM24M30 and SL28M30. ES12M33 and ES15M33. YS12M33.	250V - 20A	6 - 20P	4	
SL36M30. EM18M34, EM24M34 and EL36M35. YM18M34 and YL24M35.	250V - 30A	6 - 30P	4	

Sleeve Dimensions Drawing

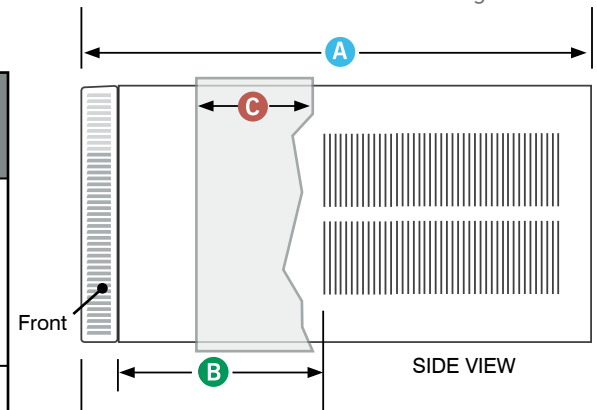

Room Air Conditioner Model Identification Guide

S L 28 M 3 0 A

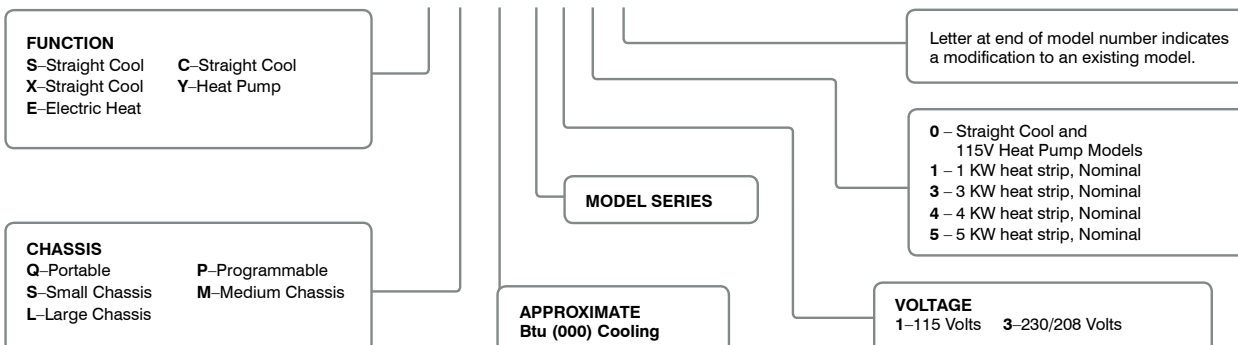

Find the thru-the-wall air conditioner that's best for you.

		THRU-THE-WALL MODELS	
		WallMaster®	Uni-Fit®
OVERVIEW	Sleeve size	Fits 27" sleeves	Fits 26" sleeves and sleeves as small as 24 1/2"
	Applications	RESIDENTIAL OR LIGHT COMMERCIAL	RESIDENTIAL OR LIGHT COMMERCIAL
COMFORT & CONVENIENCE	Perfect fit for Fedder's 27" sleeves	Y	—
	Top mounted controls	Y	—
	Electronic controls	Y	Y
	Programmable timer	24 hr.	12 hr.
	Remote control	Y	Y
	Auto restart when power is interrupted	Y	Y
	Smart Fan auto adjusting fan	Y	—
	Upward angled air discharge	Y	—
	Air flow direction control	4-way	6-way
Fan speeds	3	3	
SOUND REDUCTION TECHNOLOGY	Steel inner wall and extra dense insulation	Y	Steel inner wall
	Vibration isolating design and components	Y	Y
	Superior airflow design	Y	—
EARTH FRIENDLY	Energy Star models	Y	Y
	Environmentally friendly R-410A	Y	Y
	Energy saver switch	Y	Y
HEALTH	Washable, antimicrobial air filter	Y	Y
	Stale air exhaust	—	Y
SAFETY	EntryGard anti-intrusion protection	Y	—
	Insect barrier	Y	—
INSTALLATION	Slide-out chassis	Y	Y
	Power cord direction	Left	Right
	Concealed power cord option	Y	—
	Internal drain kit option	Y	—
	Baffle adapter kit	Y	Y
	Condensate drain kit	Y	—

WallMaster® and Uni-Fit® Series



WALLMASTER®

COOLING	HEATING
7,800-14,500 Btu	7,300-11,000 Btu
Up to 9.9 EER	



UNI-FIT®

COOLING	HEATING
8,000-13,000 Btu	3,850-11,200 Btu
Up to 9.6 EER	

WallMaster®
27" perfect fit with commercial grade quality.

Uni-Fit®
26" universal fit for sleeves as small as 24 1/2".



SLEEVE CAN BE MOUNTED FLUSH WITH THE EXTERIOR WALL FOR A NEAT APPEARANCE

(OPTIONAL ARCHITECTURAL GRILLE SHOWN)

12
Energy Star®
Models

When should you install a solid side sleeve?

A solid side wall sleeve allows for installation in thick exterior walls where the installation of room air units with side vents would effect performance and may even void the warranty.

ROOM AIR CONDITIONER
BLOCKED SIDE VENTS
RESTRICT AIR FLOW

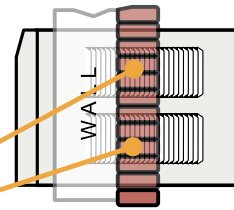

FRIEDRICH THRU-THE-WALL
SOLID-SIDE SLEEVE (NO SIDE
VENTS) CAN BE INSTALLED
IN THICKER WALLS AND CAN
BE POSITIONED FLUSH WITH
EXTERIOR WALL

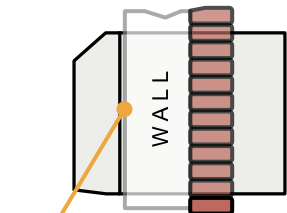
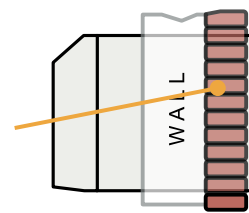

OR SLIMMER INSIDE

WallMaster® Thru-the-wall Air Conditioners fit 27" sleeves

Comfort & Convenience

- Easy-to-reach, top mount controls
- Remote control
- 24 hour programmable timer
- Smart Fan auto-adjusts fan speed to maintain desired temperature
- 3 speed fan
- Washable, antimicrobial filter
- Auto restart
- Electronic defrost control
- Insect barrier
- Reversible louver allows a second airflow option



Durability & Quality

- Rotary compressors provide quiet, dependable performance
- Premium stamped exterior grille
- Dense blower insulation
- Rifled copper tubing
- Impact resistant front cover
- High tech fins with sine wave lanced louvers increase energy efficiency by increasing surface area for heat exchange



Accessories

- WSD sleeve (sleeve is required for new installation and is sold and shipped separately)
- Architectural grille
- Drain kit
- Interior drain kit
- Subbase
- Baffle adapter kit

Installation Features

- Mounts flush with the exterior wall for a neat appearance
- Ideal for thicker wall installations, where side fins don't fit
- A high efficiency replacement for 27" sleeves including Fedders A and B*. Sleeve measures 27" W x 16 3/4" H

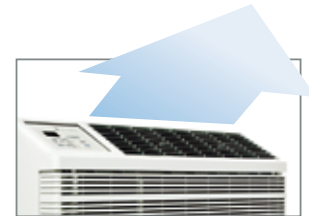

ANGLED AIR DISCHARGE FOR SUPERIOR AIR DISTRIBUTION WHEN THE UNIT IS INSTALLED LOW ON A WALL. REVERSIBLE LOUVER FOR A SECOND AIR FLOW OPTION.

Energy Savings

- Money Saver® setting saves money by operating the fan only when needed
- Six Energy Star models

Chassis requires WSD sleeve (sold and shipped separately)

*Installation in Fedders B sleeve requires a baffle kit. See BAK accessory under accessories.

Uni-Fit® Thru-the-wall Air Conditioners fit 26" wall sleeves

Comfort & Convenience

- Six-way air flow control
- Stale air exhaust
- Remote control
- 12 hour programmable timer
- 3 speed fan
- Auto restart
- Washable antimicrobial filter
- Defrost control



Durability & Quality

- Rotary compressors provide quiet, dependable performance
- Seacoast protection for corrosion resistance in harsh environments

Installation Features

- Universal fit trim ring
- Sleeve designed to fit a standard 26" opening and sleeves as small as 24.5"

Accessories

- USC sleeve (sleeve is required for new installation and is sold and shipped separately)
- Replacement exterior grille for use with existing sleeve



IMPORTANT:
1" gap on sides and 1/2" gap at top, which allows installation into varying sleeve sizes, can be covered by two-piece trim ring that fits over the chassis front. Trim ring comes standard with chassis.



Chassis requires USC sleeve (sold and shipped separately)



Model	Cooling Capacity Btu	Heating Capacity Btu	Volts Rated	Cooling Amps	Cooling Watts	Heating Amps	Heating Watts	Energy Efficiency Ratio EER	Estimated Yearly Operating Cost	Moisture Removal Pints/HR	Room Side Air Circulation CFM	Sleeve	Net Weight Lbs
WALLMASTER													
<i>Cool only</i>													
★ WS08C10	7800	NA	115	7.1	788	-	-	9.9	†	1.2	250	WSD	93
★ WS10C10	9700	NA	115	10.0	1032	-	-	9.4	\$82	2.4	257	WSD	103
★ WS12C10	11900	NA	115	11.8	1266	-	-	9.4	\$101	3.3	295	WSD	112
★ WS10C30	9500/9200	NA	230/208	4.5/4.7	989/958	-	-	9.6/9.6	\$79	1.5	300	WSD	101
★ WS13C30	12600/12300	NA	230/208	6.3/6.7	1340/1309	-	-	9.4/9.4	\$107	3.6	290	WSD	109
★ WS15C30	14500/14500	NA	230/208	8.3/8.2	1706/1706	-	-	8.5/8.5	\$136	4.2	290	WSD	119
<i>Heat Pump</i>													
★ WY09C33	9300/9000	7300/7300	230/208	4.4/4.7	989/957	3.8/4.0	839/793	9.4/9.4	\$79	2.1	250	WSD	103
★ WY12C33	12000/11800	9350/9200	230/208	6.1/6.4	1395/1372	4.8/5.1	1062/1010	8.6/8.6	\$111	2.6	275	WSD	111
<i>Cool with Electric Heat</i>													
★ WE10C33	9500/9200	11000/9100	230/208	4.5/4.7	989/958	16.0/14.7	3550/2950	9.6/9.6	\$79	1.5	300	WSD	121
★ WE13C33	12600/12300	11000/9100	230/208	6.3/6.7	1340/1309	16.0/14.7	3550/2950	9.4/9.4	\$107	3.6	290	WSD	107
★ WE15C33	14500/14500	11000/9100	230/208	8.3/8.8	1706/1706	16.0/14.7	3550/2950	8.5/8.5	\$136	4.2	290	WSD	116
UNI-FIT													
<i>Cool Only</i>													
★ US08C10	8000	-	115	7.5	830	-	-	9.6	\$66	2.2	260	USC	73
★ US10C10	9800	-	115	9.6	1040	-	-	9.4	\$83	3.2	285	USC	78
★ US12C10	11500	-	115	11.2	1220	-	-	9.4	\$97	3.8	290	USC	80
★ US10C30	10000/9800	-	230/208	4.7/5.2	1060/1040	-	-	9.4/9.4	\$85	3.2	285	USC	78
★ US12C30	11500/11200	-	230/208	5.6/6.0	1220/1190	-	-	9.4/9.4	\$97	3.8	290	USC	80
★ US14C30	13000/12600	-	230/208	7.0/7.5	1530/1480	-	-	9.4/9.4	\$122	4.0	310	USC	87
<i>Cool with Electric Heat</i>													
★ UE08C13	8000	3850	115	7.5	830	10.7	1230	9.6	\$66	2.2	260	USC	73
★ UE10C33	10000/9800	11200/9200	230/208	4.7/5.2	1060/1040	15.3/14.0	3500/2900	9.4/9.4	\$85	3.2	285	USC	78
★ UE12C33	11500/11200	11200/9200	230/208	5.6/6.0	1220/1190	15.3/14.0	3500/2900	9.4/9.4	\$97	3.8	290	USC	80

WallMaster Heat Pump heating information (shown in red) indicates heat pump heating performance. WallMaster Electric Heat heating information (shown in red) indicates electric heat strip performance. For WallMaster Heat Pump electric heating performance refer to corresponding WallMaster Electric Heat model.

WALLMASTER HEAT PUMP

HEATING PERFORMANCE: Change-over from heat pump operation to resistance operation on models indicated is automatic at a preset outside ambient temperature of approximately 35°F.

Calculate the heat loss of the space to be heated. As long as the heat loss does not exceed the resistance heating capacity rating of the unit, the heating performance will be satisfactory.

Note: all models will produce condensate. If condensate disposal is desired, an optional drain kit is available.

DEFROST CONTROL: Initiated at 30°F (outdoor coil temperature) and terminated at 43°F (outdoor coil temperature). During defrost, the compressor stops and the electric heat starts, then operates with the fan to maintain indoor comfort. Below 43°F, the unit remains in electric heat mode.

DEFROST DRAIN: Drain automatically opens at approximately 50°F to prevent condensate from freezing inside drain pan.

Plug Face/ Circuit Rating

WallMaster Model Number	Uni-Fit Model Number	Circuit Rating Breaker or T-D Fuse	Plug Face (NEMA#)	Power Cord Length (ft.)	Wall Outlet Appearance
WS08C10, WS10C10, WS12C10	US08C10, UE08C13 US10C10, US12C10	125V - 15A	5 - 15P	6	
WS10C30, WS13C30, WS15C30	US10C30, US12C30, US14C30	250V - 15A	6 - 15P	4	
WE10C33, WE13C33, WE15C33, WY09C33, WY12C33	UE10C33, UE12C33	250V - 20A	6 - 20P	4	

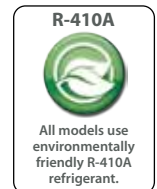

Power cords are located on front left of WallMaster models and on front right of Uni-Fit models.

Due to continuing research in new energy-saving technology, specifications are subject to change without notice. As an ENERGY STAR® partner, Friedrich Air Conditioning Co. has determined that the selected ENERGY STAR® models meet the ENERGY STAR® guidelines for energy efficiency.

Estimated yearly operating cost based on a 2007 national average electricity cost of 10.65 cents per kWh. † The estimated yearly operating cost of this model was not available at the time the range was published.



ACCESSORIES / INSTALLATION INFORMATION

WallMaster® 27" Sleeve Exterior Grilles



WSD Sleeve Standard Grille
Premium, stamped galvanized steel grille with powder coat paint. Ships with sleeve. Galvanized steel inner and outer weather panels also ship with sleeve.



WSD Sleeve Optional Architectural Grille- AG

IMPORTANT:
Operating the air conditioner with incorrect rear grille or without Baffle Adapter Kit (on 19 3/4" deep sleeve) will recirculate discharge air and cause compressor overload to trip. This will cause the unit to shut down temporarily and may lead to premature compressor failure.

CORRECT Vertical Louvers

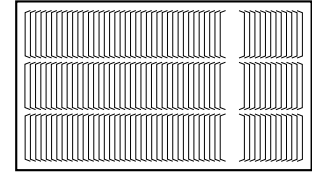

INCORRECT Horizontal Louvers

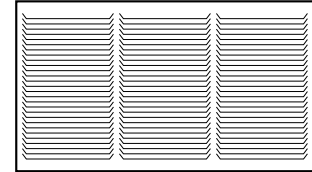

Installation Accessories (27" sleeve models only)

DK / Drain Kit

Installed at the back of the unit and allows for attachment to condensate disposal system, if necessary or desired.

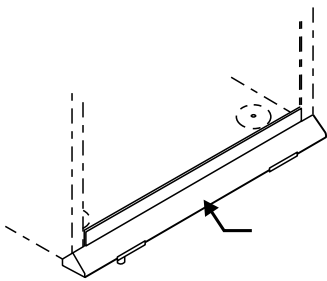

SB / Sub Base (Hides power cord)

Used as a base for the unit when it is desired to place the cord and receptacle within the installation, or simply as a base for the unit when mounted low in the wall or in walls less than 6 inches deep.

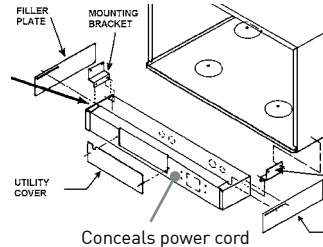

IDK / Internal Drain Kit

New construction applications where a condensate drain system has been built into the wall interior.

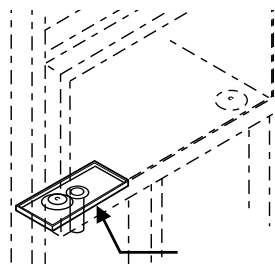

BAK / Baffle Adapter Kit

Necessary when installing in a sleeve deeper than 16 3/4" deep, such as Fedders B sleeve (19 3/4" deep).

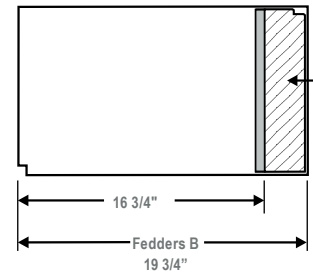

Uni-Fit® 26" Sleeve Exterior Grilles



USC Sleeve Standard Grille



Sleeve shown with Replacement Grille

STANDARD GRILLE - Ships with USC sleeve
Expanded aluminum grille designed for use with USC sleeve.

REPLACEMENT GRILLE - Ships with US/UE chassis
Black plastic for use on existing sleeves without any grille.

IMPORTANT:
When installing into an existing sleeve, consult Installation Section of your Installation/Operation Manual to determine whether or not the grille needs to be replaced and/or a baffle adapter should be used.

Sleeve/Chassis Dimensions

Model	Height	Width	Depth	Depth with Front	Minimum Extension Into Room	Minimum Extension Outside	Thru-the-wall Finished Hole		
							Height	Width	Max. Depth
WALLMASTER									
WSD Sleeve	16 3/4"	27"	16 3/4"	23"	7 1/2"	9/16"	17 1/4"	27 1/4"	15 5/16"
Chassis	15 3/4"	26 1/2"	21"	22"	-	-	-	-	-
UNI-FIT									
USC Sleeve	15 1/2"	25 7/8"	16 3/4"	20 1/2"	-	1/2"	15 3/4"	26 1/8"	16 1/4"
US Chassis	14 3/8"	24"	18 1/2"	20 1/8"	3 3/4"	-	-	-	-
UE Chassis	14 3/8"	24 5/8"	18"	19 5/8"	3 1/2"	-	-	-	-

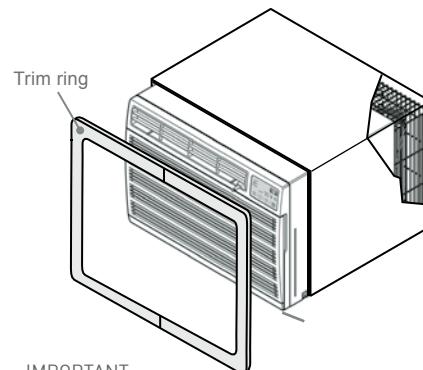

IMPORTANT:
US chassis w/front fully installed into USC sleeve extends into room 3 3/8". UE chassis w/front fully installed into USC sleeve extends into room 2 7/8". 1" gap on sides and 1/2" gap at top can be covered by two-piece trim ring that fits over the chassis front

ZoneAire®



Dual hose design provides up to 40% faster cooling and greater energy efficiency

COOLING
9300 and 11600 Btu
Up to 9.4 EER



Features

- 3-IN-1 SYSTEM: Air conditioner, dehumidifier and fan
- Dual hoses for closed loop cooling and exhaust functions for up to 40% faster, more efficient cooling
- Self evaporative condensate system means no bucket to empty
- Condensate overflow protection- if tank should become full, the unit will automatically shut off and unit can be drained through the water outlet drain
- 24 hour timer
- 3 fan speeds
- Plugs into standard 115 volt outlet
- Washable, antimicrobial air filter
- Auto restart after power outage
- Easy roll casters for portability
- Stores easily in most closets
- Window kit fits both vertical and horizontal window openings
- All installation accessories included

Ideal for these applications

- Workshops and garages
- Home offices
- Dorm rooms
- Bedrooms, attics and basements
- Sunrooms/ enclosed patios
- Supplemental or emergency cooling anywhere



SELECT MODE, FAN SPEED, ADJUST TEMPERATURE AND SET THE TIMER.



PORTABLE UNITS MUST BE VENTED TO THE OUTSIDE



EASY-TO-USE, TOP MOUNTED CONTROLS

DUAL HOSE DESIGN

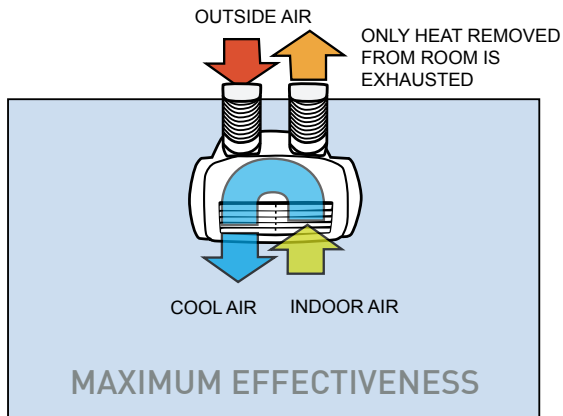

Only indoor air is conditioned and returned into the room. Indoor air is not vented outside and wasted. The room is cooled up to 40% faster with greater energy efficiency.

SINGLE HOSE DESIGN

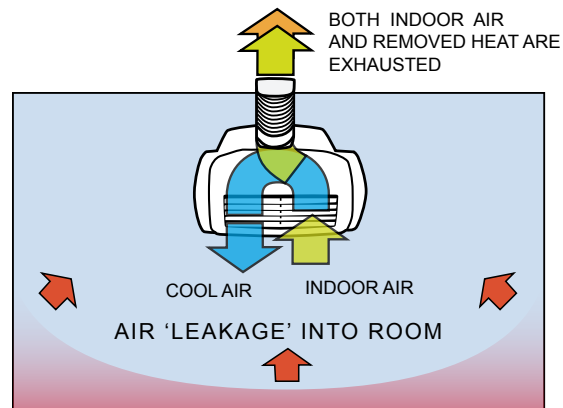

Single hose design relies on air 'leakage' from doors and windows to make up for air volume lost as indoor air is exhausted outside. The room takes longer to cool using more energy.

Portable Accessories

DUAL INTAKE/ EXHAUST HOSES (Included)

Flexible, heavy duty intake/ exhaust hoses extend from 24" to 60". The hoses can be vented through a window or through a wall opening to the outside.

WINDOW SLIDER KIT (Included)



Fits HORIZONTAL or VERTICAL WINDOWS
WINDOW OPENING:
Minimum: 26"* Maximum: 46"

* Window slider kit can be trimmed to fit a smaller opening.

Specifications

Model		P09B	P12B
PERFORMANCE			
Cooling Capacity	Btu	9300	11600
Energy Efficiency Rating	EER	9.4	8.8
Air Movement	CFM	212	235
Moisture Removal	Pts/hr.	5.0	6.0
SPECIFICATIONS			
Rated Current	Amps	10.8	11.5
Refrigerant Type		R410A	
Power Supply	Volts	115	
Dimensions- Inches	W	19 1/4"	
	H	33 1/2"	
	D	15 1/2"	
Net Weight	Lbs.	89	90

Model	Circuit Rating Breaker or T-D Fuse	Plug Face (NEMA#)	Wall Outlet Appearance	Power cord length
P09B, P12B	125V - 15A	5 - 15P		6 ft.

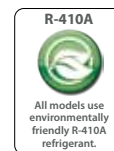

Due to continuing research in new energy-saving technology, specifications are subject to change without notice.



HAZARDGARD®
COOLING
14500 AND 19500 Btu
Up to 9.7 EER



Friedrich Hazardgard® room air conditioner is UL listed for use in Class I, Division 2, Groups A, B, C and D hazardous locations.

Hazardgard® is specifically designed to cool living quarters, storage areas and other enclosures situated in hazardous locations, where specific volatile flammable liquids or gases are handled or used within enclosed containers or systems.

For more than 30 years, the Friedrich Hazardgard® has endured some of the toughest and most unforgiving operating conditions imaginable. Time-tested in the field where it counts, Hazardgard is trusted by professionals who have to get the job done. Robust engineering with design details like 33% thicker fins extend the life of the coil. Diamonblue Technology, our anti-corrosive treatment, provides added endurance and protection in coastal or corrosive environments.



Durability Features

- Permanent split capacitor
- Hermetically sealed refrigeration system
- Environmentally sealed on/off switch and gold plated contacts in thermostat for corrosion resistance.
- Solid-state control relays for compressor and fan operation.
- Hot gas bypass allows the air conditioner to operate at low ambient conditions without freezing at outdoor ambient temperatures as low as 45° F.
- Hermetically sealed reciprocating compressor is cooled during the refrigeration cycle, which allows the unit to tolerate higher outdoor temperatures up to 130° F.
- Larger, commercial grade, enclosed fan motor with hermetically sealed overload for arc-free operation. Totally enclosed to assure efficient operation under adverse electrical conditions.
- UNIT Utilizes direct-wired, 15-amp circuit with time-delay fuse that will tolerate surge current without tripping the breaker.
- 20 gauge steel is used in order to create a more robust air conditioner cabinet that will withstand years of hard use.
- Diamonblue Technology Anti-corrosive treatment provides added endurance and protection in coastal or corrosive environments.



DIAMONBLUE ADVANCED CORROSION PROTECTION

Treatment protects the outdoor coil against deterioration and extends the life of the unit especially in harsh coastal environments.

Built to perform in the harshest environments

- Offshore oil rigs, on-shore oil company offices and refineries
- Petrochemical sites and propane fill-up stations
- Paint and varnish storage or processing plants
- Grain alcohol processors or storage sites
- Plant areas using strong solvents or chemicals
- Munitions plants or armories
- PVC or plastics plants and processing points
- Recycling plants
- Furniture refinishing/stripping workshops
- Fertilizer plants
- Office complexes where methane is a by-product
- Hazardous materials storage



Hazardgard also meets the U.S. National Electric Code, Article 500 requirements for Class 1, Division 2, Groups A, B, C and D Hazardous locations.

Built tough

Friedrich air conditioners can be found in some of the world's toughest locations. Oil companies rely on us to cool offshore oil rigs in the most extreme conditions, and military bases and government offices all over the world choose Friedrich. Industrial and high tech leaders also trust Friedrich commercial grade products for their applications.



SPECIFICATIONS / INSTALLATION

Specifications

Model	Cooling Capacity (Btu/Hr. - AHAM)	Electrical Characteristics (60 Hertz)			Energy Efficiency Ratio AHAM	Moisture Removal (Pints/ Hr.)	Air Direction Controls	Room Side Air Circulation CFM
		Volts Rated	Amps AHAM	Watts	EER			
SH15M30	14500/14000	230/208	6.9/7.5	1495/1443	9.7/9.7	6.0	8-way	375
SH20M30	19500/19000	230/208	8.7/9.6	2074/2021	9.4/9.4	4.0	8-way	375

Installation Information

Model	Dimensions (Inches)						Window Width (Inches)		Thru-The-Wall Finished Hole (Inches)			Circuit Rating Breaker or T - D Fuse	Weight (Lbs.)	
	Height	Width	Depth Overall A	Depth J Box to Louvers B	Minimum Extension Into Room	Minimum Extension Outside	Min.	Max.	Height	Width	Max. Depth C	Volts - Amps	Net	Shipping
SH15M30	15 15/16"	25 15/16"	27 3/8"	6"	3 1/16"	16 15/16"	27 7/8"	42"	16 3/16"	26 3/16"	6"	250V - 15A	140	167
SH20M30	17 15/16"	25 15/16"	27 3/8"	6"	3 1/16"	16 15/16"	27 7/8"	42"	18 3/16"	26 3/16"	6"	250V - 15A	166	170

Due to continuing engineering research and technology, specifications are subject to change without notice. Manufactured under U.S. Design Patent DES 368, 306 decorative front; Utility Patent 5, 622, 058. MAXIMUM outdoor ambient operating temperature is 130°F. MAXIMUM TEMPERATURE RATING FOR CLASS I, DIVISION 2, GROUPS A,B,C,D.

OPERATING TEMPERATURE CODE T3B

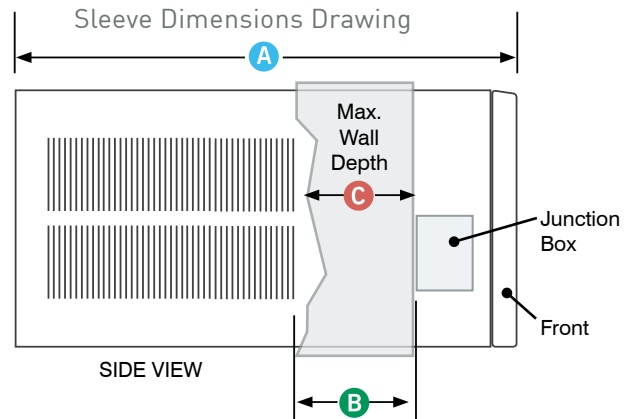

friedrich.com



Friedrich is a partner in the ENERGY STAR® program which promotes the conservation of energy and the protection of the environment through the purchase of high efficiency appliances.



F R I E D R I C H

Friedrich Air Conditioning Co. | 10001 Reunion Place, Suite 500 | San Antonio, TX 78216 | 800.541.6645 | fax 210.357.4480
www.friedrich.com

Free Manuals Download Website

<http://myh66.com>

<http://usermanuals.us>

<http://www.somanuals.com>

<http://www.4manuals.cc>

<http://www.manual-lib.com>

<http://www.404manual.com>

<http://www.luxmanual.com>

<http://aubethermostatmanual.com>

Golf course search by state

<http://golfingnear.com>

Email search by domain

<http://emailbydomain.com>

Auto manuals search

<http://auto.somanuals.com>

TV manuals search

<http://tv.somanuals.com>