

FRIGIDAIRE

All about the

Use & Care

of your

Room Air Conditioner



TABLE OF CONTENTS

Important Safety Instructions	2-3	Care and Cleaning	10
Product Registration	4	Energy Saving Ideas	10
Normal Sounds	4	Before You Call	11
Air Conditioner Features	5	Major Appliance Limited Warranty	12
Operating Instructions	5-10		

Important Safety Instructions

NOTE:

This USE & CARE MANUAL provides specific operating instructions for your model. Use the room air conditioner only as instructed in this USE & CARE MANUAL. These instructions are not meant to cover every possible condition and situation that may occur. Common sense and caution must be practiced when installing, operating, and maintaining any appliance.

NOTE:

The power supply cord with this air conditioner contains a current detection device designed to reduce the risk of fire.

Please refer to the section 'Operation of Current Device' for details.

In the event that the power supply cord is damaged, it cannot be repaired. It must be replaced with a cord from the product manufacturer.

WARNING

Avoid fire hazard or electric shock. Do not use an extension cord or an adaptor plug. Do not remove any prong from the power cord.

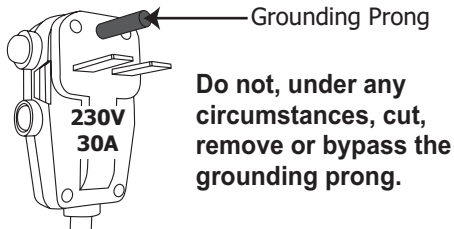
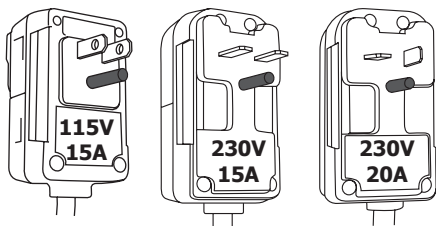

WARNING

For Your Safety

Do not store or use gasoline or other flammable vapors and liquids in the vicinity of this or any other appliance. Read product labels for flammability and other warnings.

WARNING

Prevent Accidents

To reduce the risk of fire, electrical shock, or injury to persons when using your air conditioner, follow basic precautions, including the following:

- Be sure the electrical service is adequate for the model you have chosen. This information can be found on the serial plate, which is located on the side of the cabinet and behind the grille.
- If the air conditioner is to be installed in a window, you will probably want to clean both sides of the glass first. If the window is a triple-track type with a screen panel included, remove the screen completely before installation.
- Be sure the air conditioner has been securely and correctly installed according to the separate installation instructions provided with this manual. Save this manual and the installation instructions for possible future use in removing or reinstalling this unit.
- When handling the air conditioner, be careful to avoid cuts from sharp metal fins on front and rear coils.

WARNING

Electrical Information

The complete electrical rating of your new room air conditioner is stated on the serial plate. Refer to the rating when checking the electrical requirements.

- Be sure the air conditioner is properly grounded. To minimize shock and fire hazards, proper grounding is important. The power cord is equipped with a three-prong grounding plug for protection against shock hazards.
- Your air conditioner must be used in a properly grounded wall receptacle. If the wall receptacle you intend to use is not adequately grounded or protected by a time delay fuse or circuit breaker, have a qualified electrician install the proper receptacle.
- Do not run air conditioner without outside protective cover in place. This could result in mechanical damage within the air conditioner.
- **Do not use an extension cord or an adapter plug.**

SAFETY PRECAUTIONS

DANGER! Avoid Serious Injury or Death

- This air conditioner contains no user-serviceable parts. Always call an authorized Electrolux servicer for repairs.
- Do not insert or place fingers or objects into the air discharge area in the front of the unit.
- Do not start or stop the air conditioner by unplugging the power cord or turning off the power at the electrical box.
- Do not cut or damage the power cord.
- If the power cord is damaged, it should only be replaced by an authorized Electrolux servicer.
- In the event of a malfunction (sparks, burning smell, etc.), immediately stop the operation, disconnect the power cord, and call an authorized Electrolux servicer.
- Do not operate the air conditioner with wet hands.
- Do not pull on the power cord.
- Do not drink any water that is drained from the air conditioner.

Important Safety Instructions

SAFETY PRECAUTIONS

CAUTION! Avoid Injury or damage to the unit or other property

- Provide occasional ventilation during use. Do not direct airflow at fireplaces or other heat related sources as this could cause flare ups or make units run excessively.
- Do not climb on or place objects on outdoor part of the unit.
- Do not hang objects off the unit.
- Do not place containers with liquids on the unit.
- Turn off the air conditioner at the power source when it will not be used for an extended period of time.
- Periodically check the condition of the unit's installation accessories for any damage.
- Do not apply heavy pressure to the radiator fins of the unit.
- Operate the unit with air filter in place.
- Do not block or cover the intake grille, discharge area and outlet ports.
- Ensure that any electrical/electronic equipment is one yard away from the unit.
- Do not use or store flammable gases near the unit.

READ THIS SECTION BEFORE ATTEMPTING TO OPERATE AIR CONDITIONER.
Unit must be upright for one hour prior to operating.

Operation of Current Device

Plug in &
press RESET

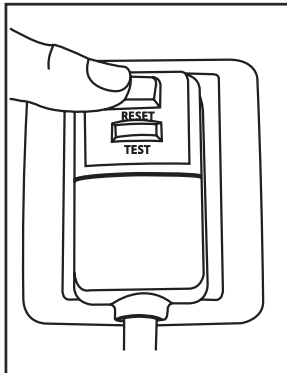

The power supply cord contains a current device that senses damage to the power cord. To test your power supply cord do the following:

1. Plug in the Air Conditioner.
2. The power supply cord will have TWO buttons on the plug head. Press the TEST button. You will notice a click as the RESET button pops out.
3. Press the RESET button. Again you will notice a click as the button engages.
4. The power supply cord is now supplying electricity to the unit.

NOTE:

- Do not use this device to turn the unit on or off.
- Always make sure the RESET button is pushed in for correct operation.
- The power supply cord must be replaced if it fails to reset when either the TEST button is pushed, or it cannot be reset. A new one can be obtained from the product manufacturer.
- If power supply cord is damaged, it CANNOT be repaired. It MUST be replaced by one obtained from the product manufacturer.

Product Registration & Normal Sounds

Product Registration

Record Your Model and Serial Numbers

Record in the space provided below the model and serial numbers. On all models, the serial plate is located on the outside of the cabinet.

Model No. _____

Serial No. _____

Register Your Product

The self-addressed PRODUCT REGISTRATION CARD should be filled in completely, signed and returned to the Frigidaire Company.

Normal Sounds

High pitched Chatter

Today's high efficiency compressors may have a high pitched chatter during the cooling cycle.

Vibration

Unit may vibrate and make noise because of poor wall or window construction or incorrect installation.

Sound of Rushing Air

At the front of the unit, you may hear the sound of rushing air being moved by the fan.

Pinging or Swishing

Droplets of water hitting condenser during normal operation may cause "pinging or swishing" sounds.

Gurgle/Hiss

"Gurgling or hissing" noise may be heard due to refrigerant passing through evaporator during normal operation.

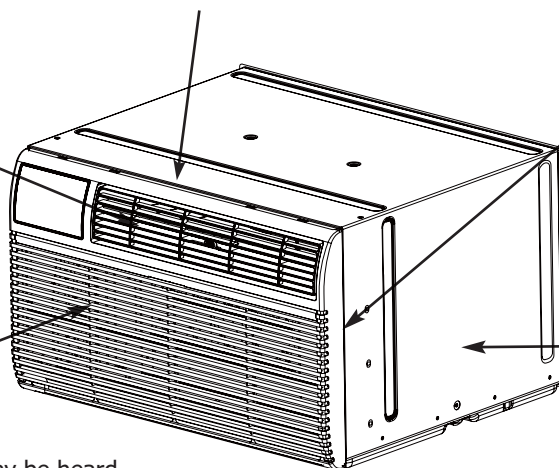

Air Conditioner Features & Operating Instructions

Air Conditioner Features

ELECTRONIC CONTROL

Before you begin, thoroughly familiarize yourself with the control panel and remote as shown below and all its functions, then follow the symbol for the functions you desire. The unit can be controlled by the touch pad alone or with the remote.

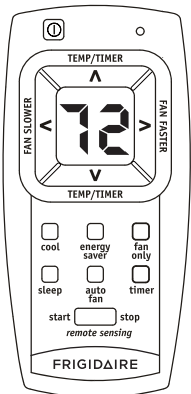
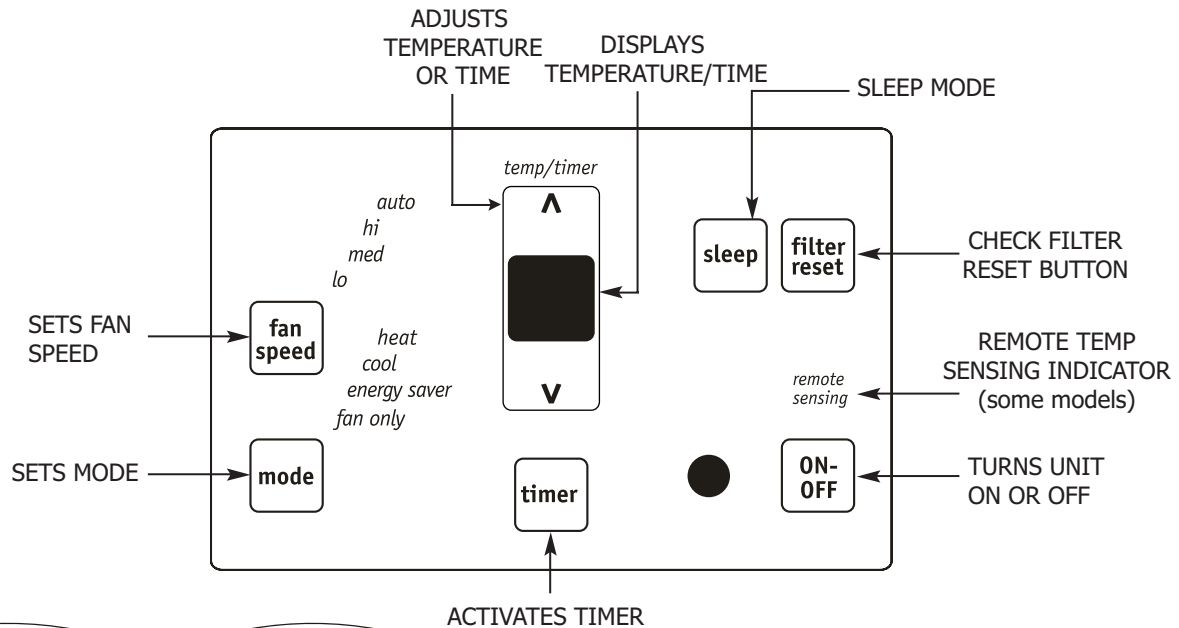

w/DISPLAY & REMOTE SENSING BUTTON

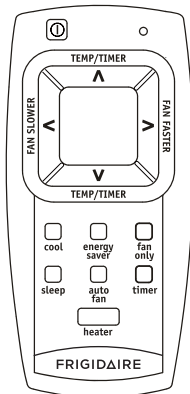

FOR HEAT MODELS

Battery Size: AAA

Warning: Do not mix old and new batteries. Do not mix alkaline, standard (carbon-zinc), or rechargeable (nickel-cadmium) batteries.

Operating Instructions

NOTE

The following instructions represent the Touch Pad, the same instructions can be used for the Remote Control.

TO TURN UNIT ON:

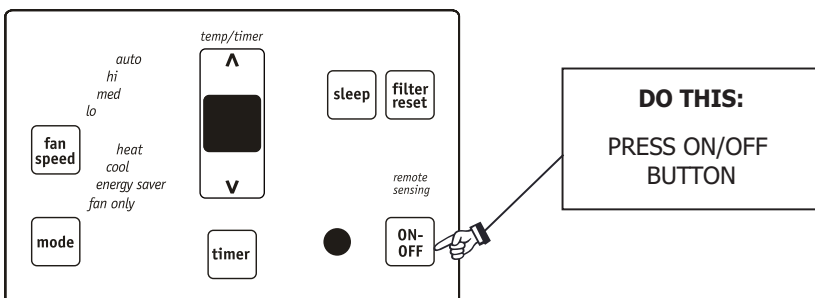

YOU WILL SEE:

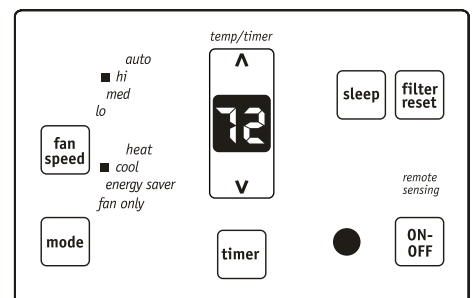

Operating Instructions

Operating Instructions

TO CHANGE TEMPERATURE SETTING:

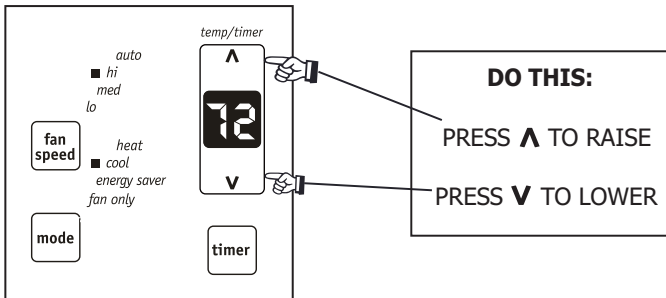

YOU WILL SEE:

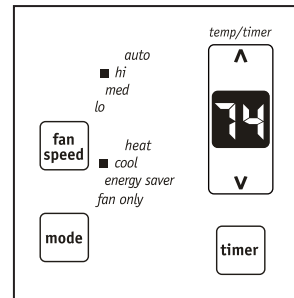

Note: Tap or hold either up (▲) or down (▼) button until the desired temperature is seen on the display. This temperature will be automatically maintained anywhere between 60 °F (16 °C) and 90 °F (32 °C) for cooling mode. The temperature will be automatically maintained anywhere between 55 °F (13 °C) and 80 °F (27 °C) for heating mode. If you want the display to read the actual room temperature. See "To Operate on Fan Only" section on this page.

TO ADJUST FAN SPEEDS:

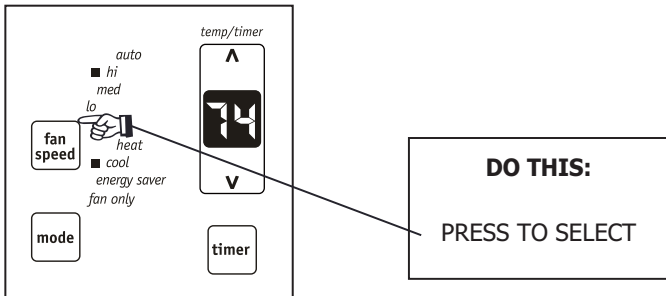

YOU WILL SEE:

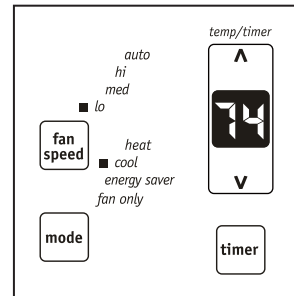

TO USE AUTO FAN FEATURE:

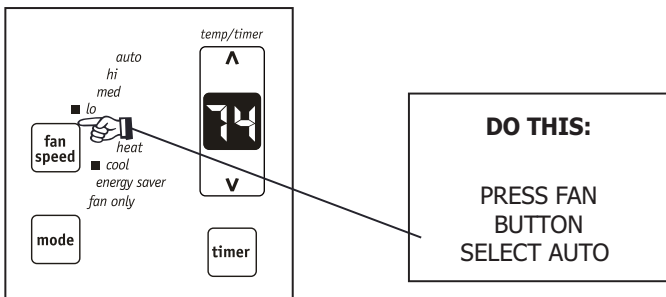

YOU WILL SEE:

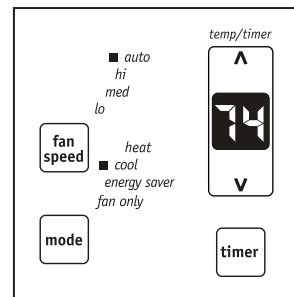

Note: Fan starts at High Speed and adjusts to a slower speed as the room temperature dictates. For example, if the room doesn't get too warm, it will stay at the slowest speed. If the room temperature rises quickly, such as a door being opened, it will automatically go to the highest speed. The fan speeds will re-adjust back to the slowest speed as the room returns to the original set temperature. Press either the fan slower or fan faster button to adjust the fan speed manually. This function is deactivated in the heating mode on 115V models.

TO OPERATE ON FAN ONLY:

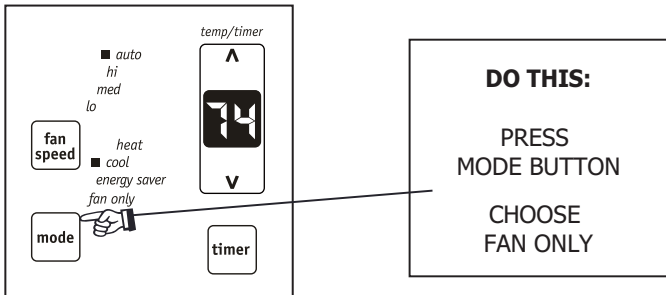

YOU WILL SEE:

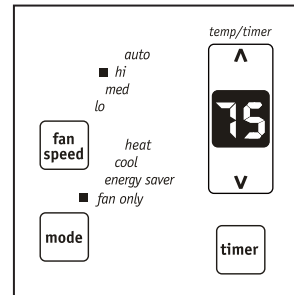

Note: Use this function only when cooling is not desired, such as for room air circulation or to exhaust stale air on some models. (Remember to open the vent during this function, but keep it closed during cooling for maximum cooling efficiency.) You can choose any fan speed you prefer. (Except "Auto Fan"). During this function, the display will show the actual room temperature, not the set temperature as in the cooling mode. Fan Only cannot be selected when the unit is in the "Remote Sensing" mode. (on those units with that feature).

Operating Instructions (continued)

TO USE THE ENERGY SAVER FEATURE:

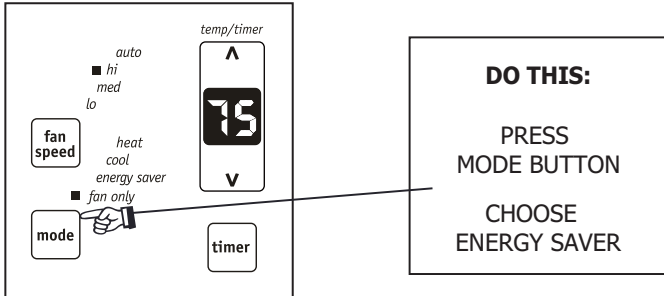

YOU WILL SEE:

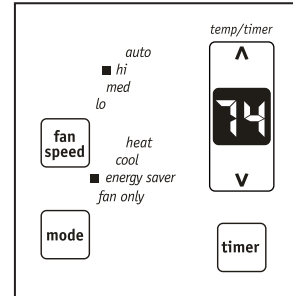

Note: In this mode, the fan will continue to run for 1 minute after the compressor shuts off. The fan then cycles on for 20 seconds at 10 minute intervals until the room temperature is above the set temperature, at which time the compressor turns back on.

TIMER: DELAY STOP / START FEATURE

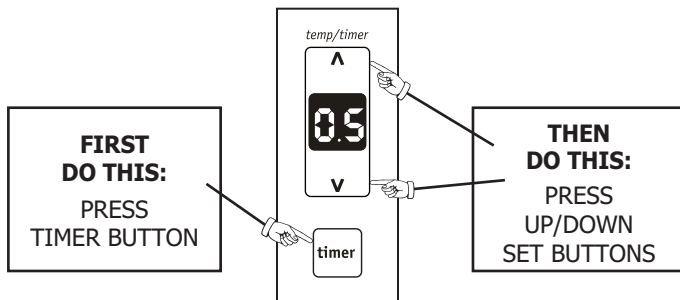

YOU WILL SEE HOW MUCH TIME IS CHOSEN:

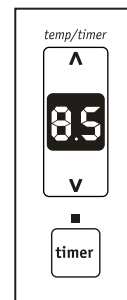

Note: For Delay Stop, the unit must be in the On position.

Note: For Delay Start, the unit must be in the Off position.

First, Press TIMER button, then adjust timer setting, tap or hold the UP arrow (**▲**) or the DOWN arrow (**▼**) to change delay timer at 0.5 hour increments, up to 10 hours, then at 1 hour increments up to 24 hours. The control will count down the time remaining until start (8, 7.5, 7, etc.). The Delay Start Operation automatically selects cooling with maximum Fan speed (if Cool, Energy Saver, or Fan Only was the last mode selected) or heating with maximum Fan speed (if Heat was the last mode selected). Note: On 115V models only low speed can be selected.) The temperature maintained will be the same as previously set. To change the set temperature, press "COOL" then Up or Down arrows until the desired temperature is indicated on the display. After 5 seconds, the control will automatically change the display back to the hours remaining until the unit will start/stop. Pressing the unit On/Off button at any time will cancel the Delay Start/Stop function. The Delay Start/Stop Feature will work until the unit either starts or stops. Once that happens the above steps have to be repeated again.

SLEEP FEATURE:

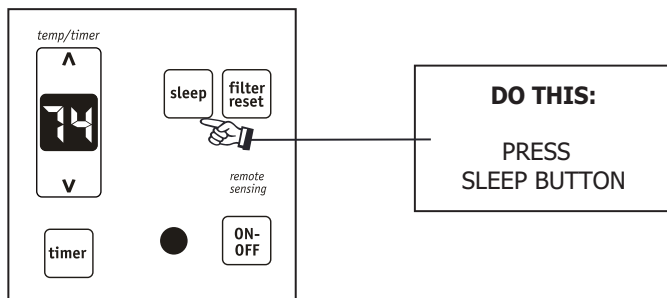

YOU WILL SEE:

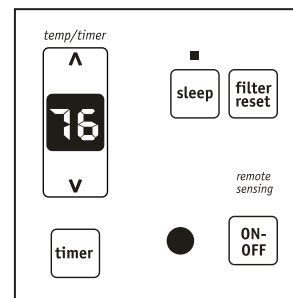

Note: In this mode the selected temperature will increase by 2 °F 30 minutes after the mode is selected. The temperature will then increase by another 2 °F after an additional 30 minutes. This new temperature will be maintained for 7 hours before it returns to the originally selected temperature. This ends the "Sleep" mode and the unit will continue to operate as originally programmed. The "Sleep" mode program can be cancelled at any time during operation by again pressing the "Sleep" button.

Operating Instructions

Operating Instructions (continued)

CHECK FILTER FEATURE:

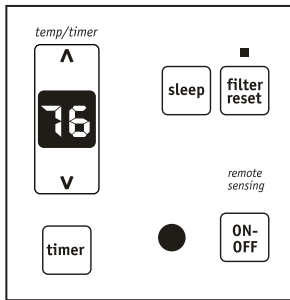

YOU WILL SEE:

DO THIS:
PRESS FILTER
RESET
BUTTON

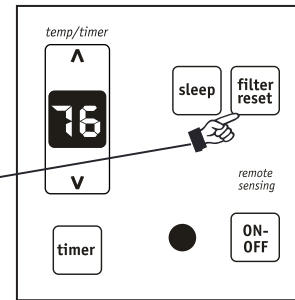

Note: This feature is a reminder to clean the Air Filter (See Care and Cleaning) for more efficient operation. The LED (light) Will illuminate after 250 hours of operation. To reset after cleaning the filter, press the "Filter Reset" button and the light will go off.

REMOTE SENSING FEATURE (on some models) :

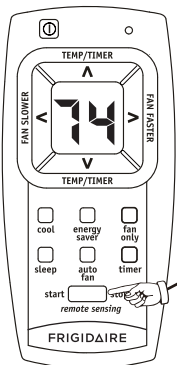

DO THIS:
PRESS REMOTE
SENSING
START
BUTTON

LIGHT pulsing (On & Off intermittently).

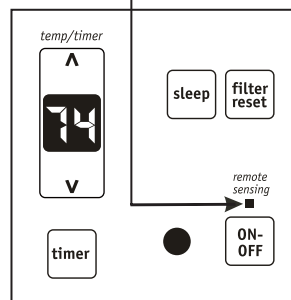

NOTE: Unit display shows the set temperature

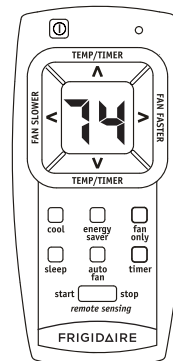

NOTE: Remote display is actual temperature at remote control only

Note: This feature can be activated from the remote control ONLY, the unit must be in a cooling mode. To activate the remote sensing feature, point the remote control towards the unit and press the remote sensing Start button. Next, use the "▲▼" buttons to set the desired temperature at the remote. (Note that the set temperature will only be displayed on the unit itself). The LIGHT on the unit control will pulse to indicate it received the signal. The LIGHT on the remote control will pulse each time it sends a signal. It will periodically send this signal until the feature is deactivated by pressing the remote sensing Stop button. If the unit does not receive the remote sensing signal during any 3 minute interval, the unit will beep to indicate the remote sensing mode has ended. The display on the remote control indicates the temperature at the remote ONLY.

NOTE: The Remote Sensing function is terminated either by using the Remote Sensing Stop button or the main ON/OFF button on the unit.

HEATING FEATURE(on some models) :

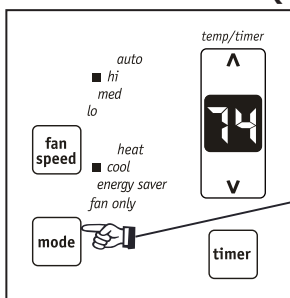

DO THIS:
PRESS
MODE
BUTTON
SELECT HEAT

YOU WILL SEE:

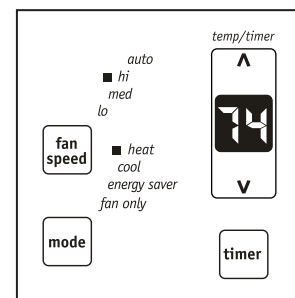

Note: This feature can be used with any combination of FAN Speeds (Low speed only on 115V models), Timer, or Sleep Modes. When in the "Heat" mode, the fan will run continuously while heat is needed. The temperature will automatically be maintained anywhere between 55 °F(13 °C) and 80 °F(27 °C). When the room set temperature is satisfied, the fan will cycle off and on to circulate and sample the room air.

Operating Instructions (continued)

FAULT CODES:

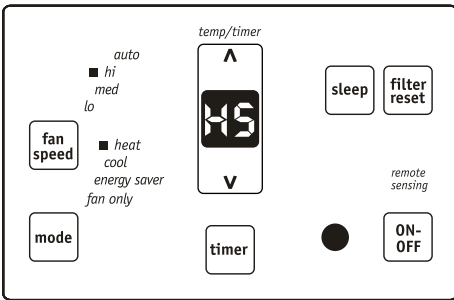

If the display reads "HS", a sensor has failed. Contact your Authorized Frigidaire Service Center.

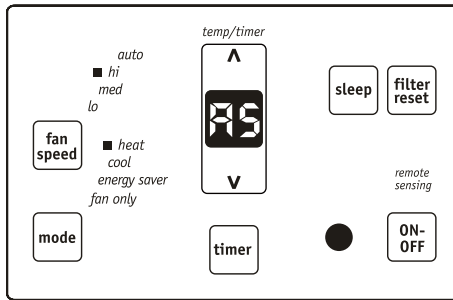

If the display reads "AS", a sensor has failed. Contact your Authorized Frigidaire Service Center.

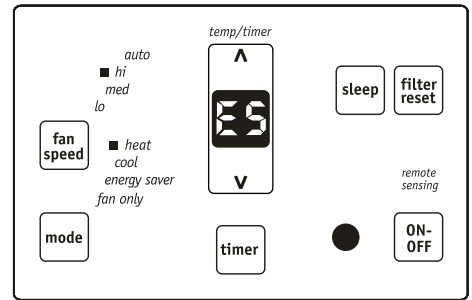

If the display reads "ES", a sensor has failed. Contact your Authorized Frigidaire Service Center.

TO CHANGE TEMPERATURE DISPLAY:

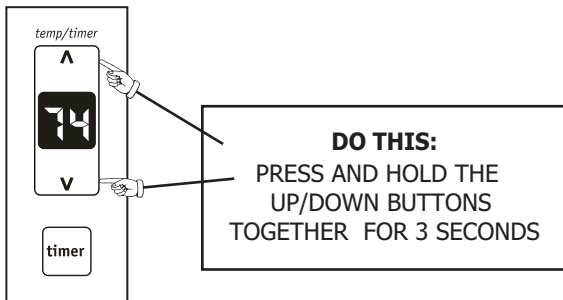

YOU WILL SEE:

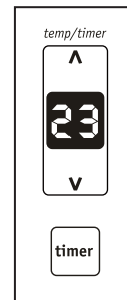

Note: The control is capable of displaying temperature in degrees Fahrenheit or degrees Celsius.

TO TURN UNIT OFF:

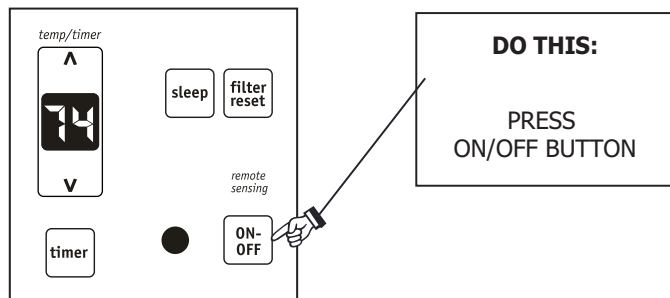

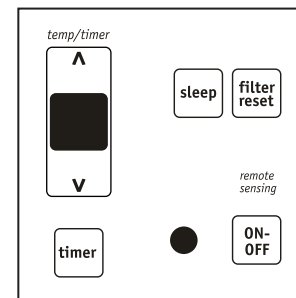

YOU WILL SEE:



Note: When unit is shut off in the Heat Mode, the fan will continue to run for a few seconds to dissipate residual heat within the unit.

ADDITIONAL THINGS YOU SHOULD KNOW

Now that you have mastered the operating procedure, here are more features in your control that you should become familiar with.

- 
 • The "Cool" circuit has an automatic 3 minute time delayed start if the unit is turned off and on quickly. This prevents overheating of the compressor and possible circuit breaker tripping. The fan will continue to run during this time.
 
- There is a 2-Second delay for the compressor shutting down when selecting FAN ONLY/HEAT. This is to cover the possibility of having to roll through to select another mode.
- The control will maintain the set temperature within 2 degrees Fahrenheit, between 60F and 90F degrees (in cool mode), 55F and 80F degrees (in heat mode).
- After a power outage, the unit will memorize the last setting and return the unit to the same setting once power is restored.

Operating Instructions (continued)



(4-WAY)

4-Way Air Directional Louvers

The 4-Way air directional louvers allow you to direct the air flow Up or Down and Left or Right throughout the room as needed. To adjust the air directional louvers side-to-side, use the center handle as you move it side-to-side.

Care and Cleaning

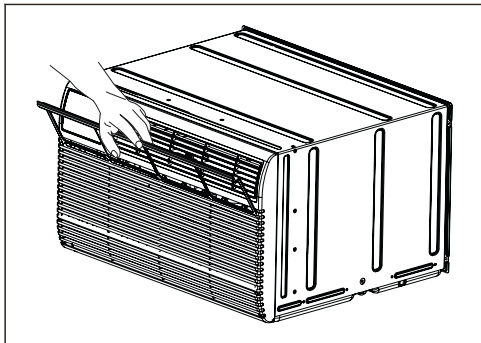

Clean your air conditioner occasionally to keep it looking new. **Be sure to unplug the unit before cleaning to prevent shock or fire hazards.**

Air Filter Cleaning

The air filter should be checked at least once a month to see if cleaning is necessary. Trapped particles in the filter can build up and cause an accumulation of frost on the cooling coils.

- Grasp the filter by the center and pull up and out.
- Wash the filter using liquid dishwashing detergent and warm water. Rinse filter thoroughly. Gently shake excess water from the filter. Be sure filter is thoroughly dry before replacing.
- Or instead of washing, you may vacuum the filter clean.

Cabinet Cleaning

- Be sure to unplug the air conditioner to prevent shock or fire hazard. The cabinet and front may be dusted with an oil-free cloth or washed with a cloth dampened in a solution of warm water and mild liquid dishwashing detergent. Rinse thoroughly and wipe dry.
- Never use harsh cleaners, wax or polish on the cabinet front.
- Be sure to wring excess water from the cloth before wiping around the controls. Excess water in or around the controls may cause damage to the air conditioner.
- Plug in air conditioner.

Winter Storage

If you plan to store the air conditioner during the winter, remove it carefully from the window according to the installation instructions. Cover it with plastic or return it to the original carton.

NOTE: To prevent rust or electrical connections from being damaged, store air conditioner in an upright position and a dry place.

Energy Saving Ideas



- **Do not block air flow inside with blinds, curtains or furniture; or outside with shrubs, enclosures, or other buildings.**
- The capacity of the room air conditioner must fit the room size for efficient and satisfactory operation.
- Install the room air conditioner on the shady side of your home. A window that faces north is best because it is shaded most of the day.
- Close the fireplace damper, floor and wall registers so cool air does not escape up the chimney and into the duct work.
- Keep blinds and drapes in other windows closed during the sunniest part of the day.
- Clean the air filter as recommended in the section "Care and Cleaning".
- Proper insulation and weather stripping in your home will help keep warm air out and cool air in.
- External house shading with trees, plants or awnings will help reduce the air conditioner's work load.
- Operate heat producing appliances such as ranges, washers, dryers and dishwashers during the coolest part of the day.

Before calling for service, review this list. It may save you time and expense. This list includes common occurrences that are not the result of defective workmanship or materials in this appliance.

OCCURRENCE	SOLUTION
Air conditioner will not operate.	<p>Wall plug disconnected. Push plug firmly into wall outlet.</p> <p>Plug Current Device Tripped. Press the RESET button.</p> <p>House fuse blown or circuit breaker tripped. Replace fuse with time delay type or reset circuit breaker.</p> <p>Control is OFF. Turn Control ON and set to desired setting.</p>
Air from unit does not feel cold enough.	<p>Room temperature below 60°F (16°C). Cooling may not occur until room temperature rises above 60°F (16°C).</p> <p>Temperature sensing element touching cold coil, located behind air filter. Straighten away from coil.</p> <p>Reset to a lower temperature.</p> <p>Compressor shut-off by changing modes. Wait approximately 3 minutes and listen for compressor to restart when set in the COOL mode.</p>
Air conditioner cooling, but room is too warm - ice forming on cooling coil behind decorative front	<p>Outdoor temperature below 60 °F (16 °C). To defrost the coil, set FAN ONLY mode.</p> <p>Air filter may be dirty. Clean filter. Refer to Care and Cleaning section. To defrost, set to FAN ONLY mode.</p> <p>Temperature is set too low for night-time cooling. To defrost the coil, set to FAN ONLY mode. Then, set temperature to a higher setting.</p>
Air conditioner cooling, but room is too warm - NO ice forming on cooling coil behind decorative front.	<p>Dirty air filter - air restricted. Clean air filter. Refer to Care and Cleaning section.</p> <p>Temperature is set too high. Set temperature to a lower setting.</p> <p>Air directional louvers positioned improperly. Position louvers for better air distribution.</p> <p>Front of unit is blocked by drapes, blinds, furniture, etc. - restricts air distribution. Clear blockage in front of unit.</p> <p>Doors, windows, registers, etc. open - cool air escapes. Close doors, windows, registers, etc.</p> <p>Unit recently turned on in hot room. Allow additional time to remove "stored heat" from walls, ceiling, floor and furniture.</p>
Air conditioner turns on and off rapidly.	<p>Dirty air filter - air restricted. Clean air filter.</p> <p>Outside temperature extremely hot. Set FAN speed to a faster setting to bring air through cooling coils more frequently.</p>
Noise when unit is cooling.	<p>Air movement sound. This is normal. If too loud, set to lower FAN setting.</p> <p>Sound of fan hitting water-moisture removal system. This is normal when humidity is high. Close doors, windows and registers.</p> <p>Window vibration - poor installation. Refer to installation instructions or check with installer.</p>
Water dripping INSIDE when unit is cooling.	<p>Improper installation. Tilt air conditioner slightly to the outside to allow water drainage. Refer to installation instructions or check with installer.</p>
Water dripping OUTSIDE when unit is cooling.	<p>Unit removing large quantity of moisture from humid room. This is normal during excessively humid days.</p>
Remote Sensing Deactivating Prematurely (some models).	<p>Remote control not located within range. Place remote control within 20 feet & 120° radius of the front of the unit .</p> <p>Remote control signal obstructed. Remove obstruction.</p>
Room too cold.	<p>Set temperature too low. Increase set temperature.</p> <p>Remote Sensing activated (on some models) and remote control located in Hot Spot - Relocate remote control or deactivate remote sensing.</p>

If These Solutions Fail, Call 1-800-944-9044 For Frigidaire Service.

Major Appliance Limited Warranty

Your appliance is covered by a limited two-year warranty and a limited 3-5 year warranty on the sealed system (the compressor, condenser, evaporator and tubing). For two years from your original date of purchase, Electrolux will pay all costs for repairing or replacing any parts of this appliance that prove to be defective in materials or workmanship when such appliance is installed, used and maintained in accordance with the provided instructions. From the third to the fifth year from your original purchase date, Electrolux will repair or replace any parts in the Sealed Refrigeration System (compressor, condenser, evaporator and tubing) that prove to be defective in materials or workmanship. In years 3-5, the consumer will be responsible for diagnostic, labor and parts costs as well as any removal, transportation and reinstallation expenses which are incurred during service on components other than those covered under the Sealed Refrigeration System 5-year warranty.

Exclusions **This warranty does not cover the following:**

1. Products with original serial numbers that have been removed, altered or cannot be readily determined.
2. Product that has been transferred from its original owner to another party or removed outside the USA or Canada.
3. Rust on the interior or exterior of the unit.
4. Products purchased "as-is" are not covered by this warranty.
5. Food loss due to any refrigerator or freezer failures.
6. Products used in a commercial setting.
7. Service calls which do not involve malfunction or defects in materials or workmanship, or for appliances not in ordinary household use or used other than in accordance with the provided instructions.
8. Service calls to correct the installation of your appliance or to instruct you how to use your appliance.
9. Expenses for making the appliance accessible for servicing, such as removal of trim, cupboards, shelves, etc., which are not a part of the appliance when it is shipped from the factory.
10. Service calls to repair or replace appliance light bulbs, air filters, water filters, other consumables, or knobs, handles, or other cosmetic parts.
11. Surcharges including, but not limited to, any after hour, weekend, or holiday service calls, tolls, ferry trip charges, or mileage expense for service calls to remote areas, including the state of Alaska.
12. Damages to the finish of appliance or home incurred during installation, including but not limited to floors, cabinets, walls, etc.
13. Damages caused by: services performed by unauthorized service companies; use of parts other than genuine Electrolux parts or parts obtained from persons other than authorized service companies; or external causes such as abuse, misuse, inadequate power supply, accidents, fires, or acts of God.

DISCLAIMER OF IMPLIED WARRANTIES; LIMITATION OF REMEDIES

CUSTOMER'S SOLE AND EXCLUSIVE REMEDY UNDER THIS LIMITED WARRANTY SHALL BE PRODUCT REPAIR OR REPLACEMENT AS PROVIDED HEREIN. CLAIMS BASED ON IMPLIED WARRANTIES, INCLUDING WARRANTIES OF MERCHANTABILITY OR FITNESS FOR A PARTICULAR PURPOSE, ARE LIMITED TO ONE YEAR OR THE SHORTEST PERIOD ALLOWED BY LAW, BUT NOT LESS THAN ONE YEAR. ELECTROLUX SHALL NOT BE LIABLE FOR CONSEQUENTIAL OR INCIDENTAL DAMAGES SUCH AS PROPERTY DAMAGE AND INCIDENTAL EXPENSES RESULTING FROM ANY BREACH OF THIS WRITTEN LIMITED WARRANTY OR ANY IMPLIED WARRANTY. SOME STATES AND PROVINCES DO NOT ALLOW THE EXCLUSION OR LIMITATION OF INCIDENTAL OR CONSEQUENTIAL DAMAGES, OR LIMITATIONS ON THE DURATION OF IMPLIED WARRANTIES, SO THESE LIMITATIONS OR EXCLUSIONS MAY NOT APPLY TO YOU. THIS WRITTEN WARRANTY GIVES YOU SPECIFIC LEGAL RIGHTS. YOU MAY ALSO HAVE OTHER RIGHTS THAT VARY FROM STATE TO STATE.

If You Need Service Keep your receipt, delivery slip, or some other appropriate payment record to establish the warranty period should service be required. If service is performed, it is in your best interest to obtain and keep all receipts. Service under this warranty must be obtained by contacting Electrolux at the addresses or phone numbers below.

This limited warranty only applies in the USA and Canada. In the USA, your appliance is warranted by Electrolux Major Appliances North America, a division of Electrolux Home Products, Inc. In Canada, your appliance is warranted by Electrolux Canada Corp. Electrolux authorizes no person to change or add to any obligations under this warranty. Obligations for service and parts under this warranty must be performed by Electrolux or an authorized service company. Product features or specifications as described or illustrated are subject to change without notice.

USA
1.800.944.9044
Electrolux Major Appliances
North America
P.O. Box 212378
Augusta, GA 30907



Canada
1.800.265.8352
Electrolux Canada Corp.
5855 Terry Fox Way
Mississauga, Ontario, Canada
L5V 3E4

Free Manuals Download Website

<http://myh66.com>

<http://usermanuals.us>

<http://www.somanuals.com>

<http://www.4manuals.cc>

<http://www.manual-lib.com>

<http://www.404manual.com>

<http://www.luxmanual.com>

<http://aubethermostatmanual.com>

Golf course search by state

<http://golfingnear.com>

Email search by domain

<http://emailbydomain.com>

Auto manuals search

<http://auto.somanuals.com>

TV manuals search

<http://tv.somanuals.com>