

# Frontier ULV

Lite / Pro

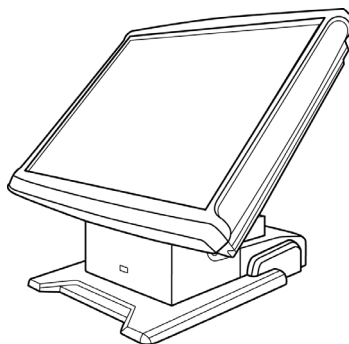
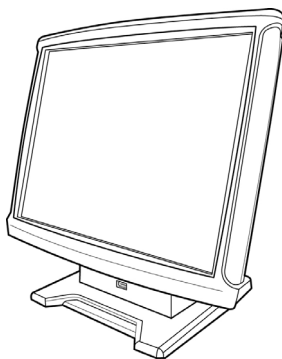

## User's Manual

## About this Manual

Thank you for purchasing our Frontier Touch Terminal. This terminal offers highly enhanced features, with easy connection to various optional devices for optimal performance. This user manual describes how to setup and connect your terminal.

## Copyright

© Copyright 2006

All rights reserved. This product and related documentation are protected by copyright and are distributed under licenses restricting their use, copying, and distribution. No part of this documentation may be reproduced in any form by any means without prior written authorization of the manufacturer and its licensors, if any.

## Safety notices



### Before You Proceed

- Read the safety notices and the User Manual carefully before using the product.
- Keep the box and packaging in case the product needs to be shipped in the future.
- Follow the product and warning label instructions.
- Any changes or modifications that do not follow the instructions in this manual will void this product's warranty.



### Power Supply Safety Notes

- To avoid electric shocks, disconnect the power cord from the electrical outlet before relocating the system.
- Make sure the voltage of the power outlet conforms within voltage range of the terminal. Failure to comply may cause the electric shock or damage to the terminal. If you are not sure of the electricity voltage that you are using, contact your local electricity company.
- To avoid fire or electric shocks, do not overload electric power outlets.
- Protect the power cord from being walked on or pinched particularly at plug, convenience receptacles, and the point where they exit from the apparatus.

### Operating Instructions

- Keep this manual for future reference.
- Keep this equipment from moisture and dust.
- Place the equipment on a stable surface before setting it up.
- If there is any of the following situation arise, notify a qualified service technician immediately:
  - The power cord or plug is damaged.
  - Liquid has been spilt on to the equipment.
  - The equipment has been dropped and damaged.
  - The equipment does not function normally.
- Do not block any ventilation openings to prevent the equipment from overheat.
- Do not leave the equipment in a non air-conditioned environment where the storage temperature may go above 60°C (140°F), as this can cause damage to the equipment.

### Maintenance

- Gently wipe screen with a clean soft hair lens brush, or a lint-free cloth.
- Do not apply pressure to the screen while cleaning.
- Do not spray any liquid directly onto the screen or the casing of the Frontier ULV Terminal.
- Chemical cleaners have been reported to cause damage on the screen of the Frontier Terminal.

### Warning and Attention

- The technical descriptions and specifications of the equipment are subject to change without notice.
- For safety reasons, wear gloves when assembling the product.

**Federal Communications (FCC Statement)**

This device complies with FCC Rules Part 15. Operation is subject to the following two conditions:

- This device may not cause harmful interference.
- This device must accept any interference received including interference that may cause undesirable operation.

This equipment has been tested and found to comply within the limit of a Class A digital device, pursuant to Part 15 of the FCC Rules. These limits are designed to provide reasonable protection against harmful interference in a residential installation. This equipment generates, uses and can radiate radio frequency energy and, if not installed and used in accordance with the manufacturer's instructions, may cause harmful interference to radio communications. However, there is no guarantee that interference will not occur in a particular installation. If this equipment does cause harmful interference to radio or television reception, which can be determined by switching the equipment on and off, the user is encouraged to try to correct the interference by one or more of the following measures:

- Reorient or relocate the interference receiving antenna.
- Increase the distance of separation between the equipment and interference receiver.
- Connect the equipment to a power outlet on a circuit different from that to which the interference receiver is connected.
- Consult the dealer or an experienced radio/TV technician for help.

**WARNING:**

The use of shielded cables for connection of the monitor to the graphics card is required to assure compliance with FCC regulations. Changes or modifications to this unit not expressly approved by the party responsible for compliance could void the user's authority to operate this equipment.

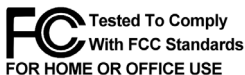
**RoHS**

<b>Chapter 1</b> .....	<b>1</b>
<b>Welcome</b> .....	<b>1</b>
Overview of Frontier ULV.....	1
Rear View .....	2
OSD Control Buttons .....	3
Features .....	4
Unpacking .....	5
<b>Chapter 2</b> .....	<b>6</b>
<b>Getting Started</b> .....	<b>6</b>
Pre-installation Notice.....	6
Default Setting .....	6
Limitations .....	7
Hardware Installation.....	8
Installing the Adapter and Internet for Lite type .....	8
Installing the Adapter and Internet for Pro type.....	9
Installing the Customer Display for Lite type .....	10
Installing the Customer Display for Pro type.....	10
Installing the 2nd display (for Pro type only).....	11
Installing the MSR.....	12
LCD Operating Angle.....	12
<b>Appendix</b> .....	<b>13</b>
<b>Technical Information</b> .....	<b>13</b>
Specifications.....	13
Frequently Asked Questions (FAQ).....	15

## Welcome

Congratulations on your purchase of this POS terminal. Your easy-to-use POS terminal is designed to help you enhance your business flexibility by offering a superior customer experience.

### Overview of Frontier ULV

**ULV Lite**

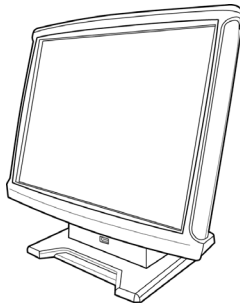

- Counter space-saver

**ULV Pro**

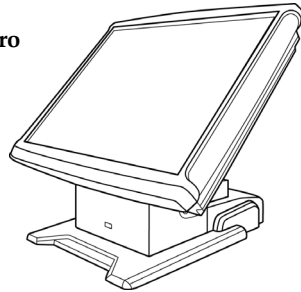

- Powerful expansion capability
- Dual display for advertising

Model	Frontier ULV 1.0		Frontier ULV 1.5 ~ 2.0	
	Lite	Pro	Lite	Pro
<b>CPU</b>	VIA Eden 1GHz (Fan-less)		VIA C7 1.5 GHz ~ 2.0 GHz	
<b>Chipset</b>	VIA CN700 + 8237R+			
<b>HDD</b>	2.5" x 1	2.5" / 3.5" x 1	2.5" x 1	2.5" / 3.5" x 1
<b>Storage devices</b>	CF memory card			
	DOM (Disk On Module)			
<b>Serial Port</b>	3 (Touch & MSR I/F included)	6 (Touch & MSR I/F included)	3 (Touch & MSR I/F included)	6 (Touch & MSR I/F included)
<b>USB port</b>	5 (USB Ver. 2.0)			
<b>Powered USB</b>	None	2 (1 x 12V/ 1 x 24V)	None	2 (1 x 12V/ 1 x 24V)
<b>DC Output for peripherals</b>	None	DC 12V & DC 24V plug	None	DC 12V & DC 24V plug

## Rear View

The rear panel view, with the input and output ports, is shown in the illustration.

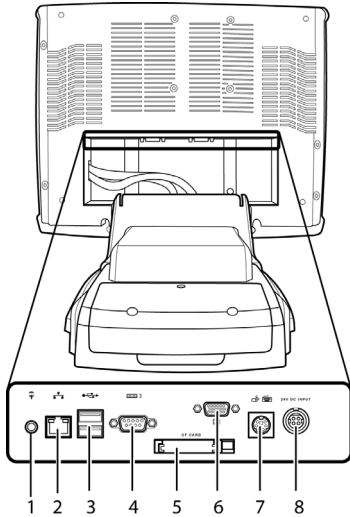

### Upper I/O Ports (ULV Lite/ Pro)

	DESCRIPTION
1	Line Out
2	LAN port
3	USB port x 2
4	COM 3
5	CF Card slot
6	2 <sup>nd</sup> VGA port (ULV Pro only)
7	K/B, M/S Combo port
8	24V DC input

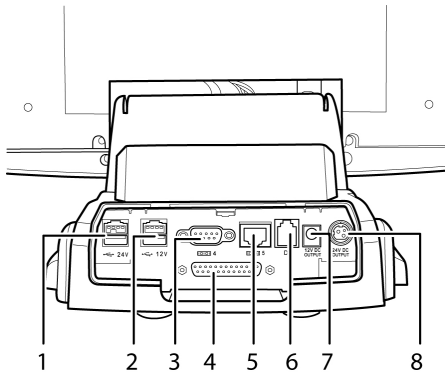

### Lower I/O Ports (ULV Pro only)

	DESCRIPTION
1	Powered USB 24V
2	Powered USB 12V
3	COM 4
4	LPT Port
5	COM 5 (RJ45 for customer display)
6	Cash Drawer Port (COM 6)
7	12V DC output
8	24V DC output

**OSD Control Buttons**

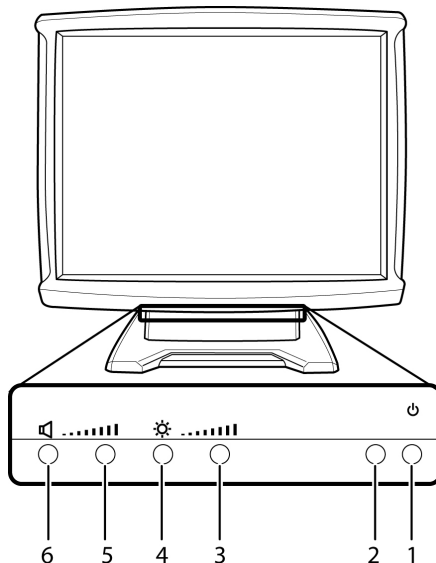

	ICON	FUNCTION
1		Press the Power button to start up the system. Press the Power button for 4 seconds to shut down the system from hardware. Press the Power button and "Brightness +" button for 4-6 seconds to reset the system from the hardware.
2	Power LED	Red: Standby mode. Green: System start up.
3	Brightness +	Press the "Brightness +" and "Brightness -" button to active the adjustment mode, then press Brightness "+" and "Brightness -" button for brightness adjustment. The setting will be saved after releasing the button for 6 seconds.
4	Brightness -	
5	Speaker +	Press the "Speaker +" and "Speaker -" button to active the adjustment mode, then press "Speaker +" and "Speaker -" button for brightness adjustment. The setting will be saved after releasing the button for 6 seconds.
6	Speaker -	

**Note:**

Press the "Brightness -" and "Speaker +" to restore the factory default setting.





### Features

This POS terminal comes equipped with the following features:

- Noise-free
  - The fan-less, noise free design of the Frontier ULV is ideal for noise-intolerant environment such as hospitals, museum, and SPA resorts, etc.
- Low power consumption
  - ULV (Ultra Low Voltage) design of the device is embedded with a unique chip set and CPU renders power saving function.
- Saving cost of ownership
  - Modular design provides the owner with the following benefits: (a) cost effectiveness, (b) customization flexibility, and (c) easy maintenance.
- Compact size/  
Aesthetic design
  - Slimmest in the POS industry standard (24 mm). This elegant, economic POS system features a sleek, compact design base that saves counter space and adds appeal to the service environment.
- Dust/water-proof
  - Frontier ULV series features a highly durable, rigorously tested design that is reliable and dependable in rugged environments.
- WEPOS/XPE solution
  - Solution is recommended to be bundled with embedded solution for high performance and other added values.
- Environment protection
  - Environmental friendly, RoHS compliant product.
- Higher stability
  - The Frontier ULV has a longer overall system MTBF to provide a higher stability during operation.

## Unpacking

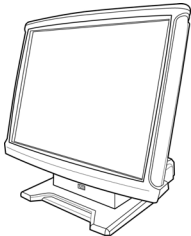
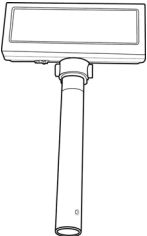
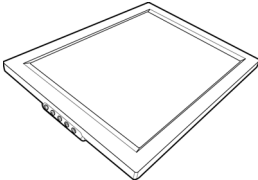
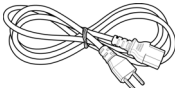
Before setting up your Frontier ULV, check that the package contains the following items. If any of the items are missing or damaged, contact your vendor immediately.

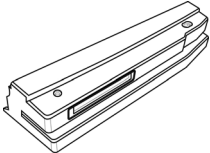
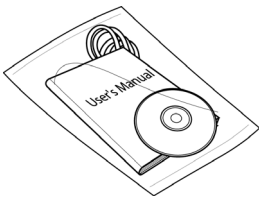
Frontier Touch Terminal	Customer Display (optional)	2nd Customer Display (optional)
		
AC Power Cord	Power Adapter	Magnetic Stripe Reader (optional)
		
Accessory Package		
	<ol style="list-style-type: none"> <li>1. Screws (black) for MSR x 1</li> <li>2. Driver CD disc</li> <li>3. User's Manual</li> <li>4. DC24V power cable (Pro only)</li> <li>5. PS/2 COMBO Y cable</li> <li>6. USB rubber cove</li> <li>7. Cable clamp</li> <li>8. P.E. sheet</li> </ol>	

## Getting Started

This chapter describes how to install the optional accessories on your Frontier Touch Terminal for optimal serviceability.

### Pre-installation Notice

Before you start installing your Frontier ULV, please read the following notices carefully.

1. The Frontier ULV does not support PCI slot.
2. Do not plug in or unplug any interior devices, such as memory module or any function card, when the ATX PSU is powered on.
3. The LAN chipset uses RTL 8139/810x family network adapter. The Terminal has be built-in the PXE Boot ROM function within the BIOS to execute Boot ROM already.
4. For installation and compatibility, using the DDR RAM Module from the original manufacturer is recommended.
5. The USB device connector is Hot Swap. Do not plug in or unplug any connectors other than USB devices when the power is on.
6. The spill proof design of Frontier ULV conforms to IP-43 standard.
7. Do not insert or remove any devices or components from the Frontier ULV while the power is on.

### Default Setting

#### Default settings for Frontier Touch Terminal serial ports

COM1	COM2	COM3	COM4	COM 5	COM 6
IRQ 4	IRQ 3	IRQ 5	IRQ 10	IRQ 5	IRQ 10

### Preset voltage setting for MSR

1. The MSR default setting is ISO Track 1 & 2. (For customized track settings, advise the manufacturer before production.)
2. In event of any requirement to change the setting of the MSR, run Setting utility in the driver CD provided in the accessory package.
3. The normal swiping card speed of the MSR is 10 to 100 cm/sec. (based on the ISO 7812 standard).

### Limitations

Connector with Voltage Output	Location	Average current	Pack current
COM 1 for External input device interface	LCD Panel Side	DC 5V / 0.5A, DC 12V / 0.5A	DC 5V / 1A, DC 12V / 0.5A
COM 2 for Touch Panel interface	LCD Panel Side	DC 5V / 0.3A	DC 5V / 0.5A
COM 3 for extension interface (9 <sup>th</sup> PIN of DB-9)	LCD Panel Side (On Mother Card)	DC 5V / 0.3A, DC 12V / 0.5A	DC 5V / 0.5A, DC 12V / 1A
COM 4 for extension interface (9 <sup>th</sup> PIN of DB-9)	Bottom side (On Interface Board)	DC 5V / 0.3A, DC 12V / 0.5A	DC 5V / 0.5A, DC 12V / 1A
COM 5 for Pole Display (RJ-45)	Bottom side (On Interface Board)	DC 5V / 1A DC 12V / 1A	DC 5V / 1A, DC 12V / 1A
COM 6 for Cash Drawer driving (Pulse)	Internal connector	DC 12V / 1A DC 24V / 1A	DC 12V / 1A, DC 24V / 1A
DC 12V Powered USB for peripherals	Bottom side (On Interface Board)	DC 12V / 1.5A	DC 12V / 2.5A
DC 24V Powered USB for peripherals	Bottom side (On Interface Board)	DC 24V / 1.5A	DC 24V / 2A
*2 <sup>nd</sup> LCD Monitor Power Connector (DC Plug)	Bottom side (On Interface Board)	DC 12V / 1.5A	DC 12V / 2.5A
*DC 24V Printer Power Connector (Hosiden 3PIN)	Bottom side (On Interface Board)	DC 24V / 1.5A	DC 24V / 2A

---

#### Note:

- None of the COM Port current loading should exceed DC 5V/3A+ DC 12V/2A.
  - DC 12V /24V powered USB should not be used with 12V DC plug and 24V Hosiden at the same time.
  - When 2nd Display uses 12V DC plug, the thermal printer can **NOT** use the 24V Hosiden simultaneously.
-

### Hardware Installation

#### Installing the Adapter and Internet for Lite type

To install the adapter and Internet cable for Lite type, do the following:

1. Connect the Internet RJ 45 cable and the power cable to the connectors and arrange the cables in the clamps as shown.

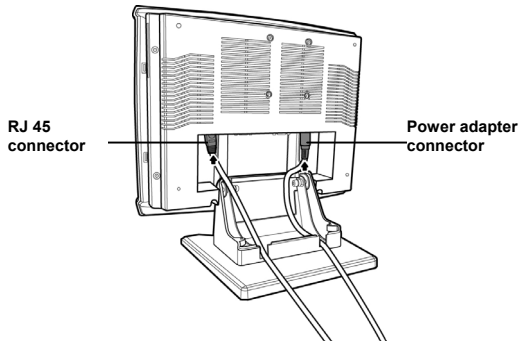

2. Replace the extension base cover and affix it to the base with two M3 back screws.

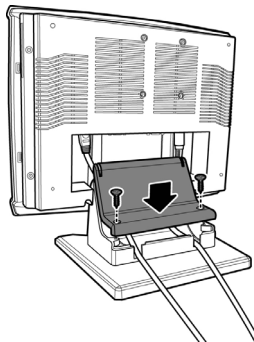

### Installing the Adapter and Internet for Pro type

To install the adapter and Internet cable for Pro type, do the following:

1. Take out the cable clamps from the accessory package and attach them to the position as shown. Connect the Internet RJ 45 cable and the power cable to the connectors and arrange the cables in the clamps.

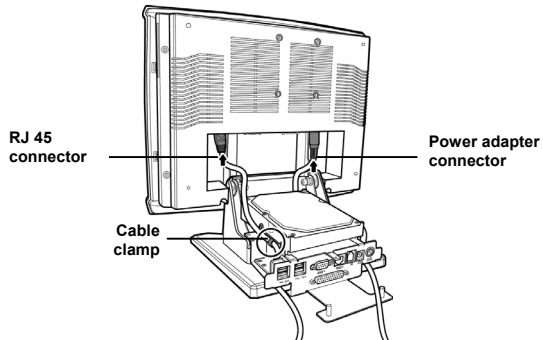

2. Replace the extension base cover with two M3 screws and then affix the stand cover to the base with three M3 screws.

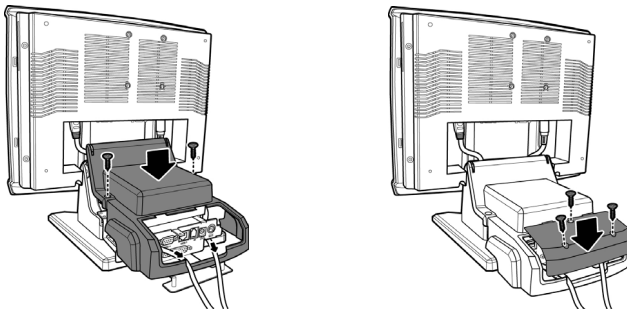

### Installing the Customer Display for Lite type

Follow the procedures below to install the Customer Display.

1. Connect the VFD DB 9 cable to the connector as shown.
2. Replace the base cover and affix it with two M3 screws.
3. Attach the Customer Display to the base of the Frontier ULV Terminal with two M3 screws.
4. Lock the Customer Display to the customer display pole bracket with two M3 screws.

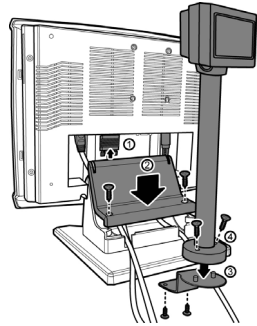

### Installing the Customer Display for Pro type

Follow the procedures below to install the Customer Display.

1. Plug the VFD RJ-45 connector of the Customer Display into the COM5 port.

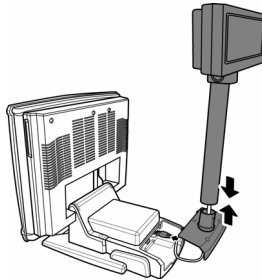

2. Install the Customer Display and the cover stand in place with three M3 screws.

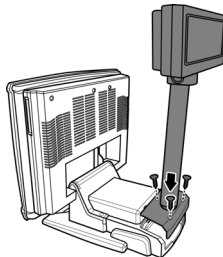

### Installing the 2nd display (for Pro type only)

To install the 2<sup>nd</sup> display onto the Frontier ULV Terminal, do the following:

1. Connect the DB 15 cable to the connector on the back of the Frontier ULV Terminal LCD screen and arrange the cable in the clamp as shown.

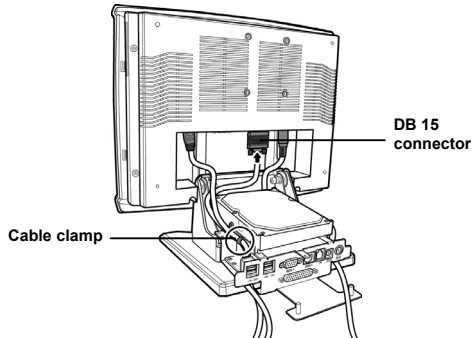

2. Replace the base cover. Connect one end of the DC 12V adapter cable to the base and allow the other end of the cable pass through the hole on the 2<sup>nd</sup> Display cover stand.

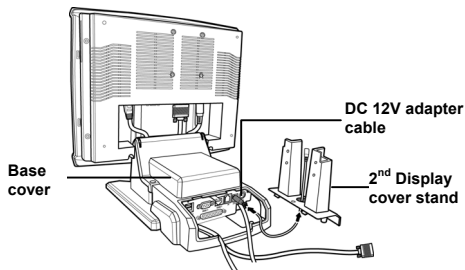

3. Affix the 2<sup>nd</sup> Display cover stand to the base with three M3 screws. Next, connect the other end of the DC 12V adapter cable and the DB 15 cable to the 2<sup>nd</sup> Display.

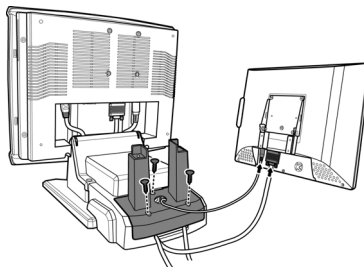



## Chapter 2 — Getting Started

4. Install the 2<sup>nd</sup> Display and lock it to the stand with four M3 screws.

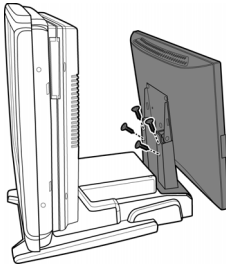

### Installing the MSR

To install the MSR onto the LCD display, do the following:

1. Attach the MSR device jack to the MSR socket on the side of the LCD display.
2. Affix the upper and lower MSR wires firmly to the slots on the side of the LCD.
3. Lock the MSR securely on the LCD display with two M3 screws.

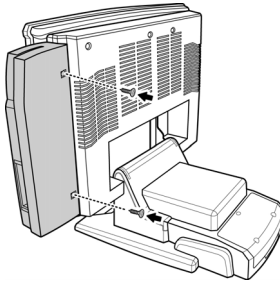

### LCD Operating Angle

The LCD display is equipped with an adjustable hinge of 0° to 90°.

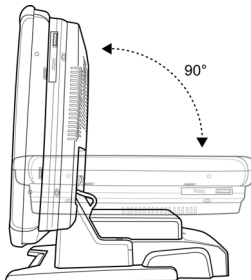

## Technical Information

### Specifications

ITEM	SPECIFICATION
Model Name	Frontier ULV All in One Touch POS System
Processor	Supports VIA Eden CPU 1.0 GHz or C7 CPU up to 2.0GHz
Memory	200-pin DDR RAM *1, up to 2GB (DDR333/400)
System Core Chipset	North Bridge: VIA CN-700 South Bridge: VIA 8237R+
BIOS	Award BIOS with enhanced ACPI 1.0 PnP/APM/DMI/ESCD/PCI bus 2.1/ On Now/ DRAM ECC
AGP 3D Graphics	VIA AGP4X graphics core, share memory from 8MB up to 64 MB Dual VGA output (Dual-view on North Bridge Chips) Supports 3D/2D graphics accelerator NT 4.0/5.0, Windows 95/98/2000/XP utility APM/ACPI 1.0 Direct 9.0, VPE, MPEG2
Parallel Port	One LPT port (SPP/EPP/ECP), IRQ and address selectable by BIOS setup
Serial Port	Total 6 COM port on board, IRQ selectable by BIOS setup Output on 9th pin by jumper selector. Each voltage output with poly switch protector.
USB	Total 5 USB port (USB 2.0) support One USB port (V 2.0) located on the front panel Two USB port (V 2.0) located on the rear panel Two USB port (V 2.0) on extended base (optional)
Enhance PCI IDE	On board PCI bus master IDE1/2, support Ultra DMA/66/100/133
Serial ATA Port	One Serial ATA HDD ports

## Appendix — Technical Information

ITEM	SPECIFICATION
Thermal Solution	One heat-sink (Fan-less) or heat-sink with Fan (Base on Fan Speed Control technology) for CPU and North Bridge Chip
Compact Flash Card	One bootable compact flash card socket (Type I/II)
Cash Drawer Port	One cash drawer port with status sensor. (EPSON ESC Pin define)
System Power	DC 24V/ 5A /120W external power adapter with internal DC to DC power inverter.
AC Power Source	AC 90 to 264V Full Range.
System Trigger Control	System front side tact switch (ATX Trigger) below the LCD display with bottom.
Ethernet Port (10/100 Mbps Auto)	Realtek RTL8100C Ethernet chip on board Intel Ethernet chips on board (10/100 base- T, Gigabyte extendible) ACPI/NT 4.0/5.0 (NDIS5) Remote boot ROM for NT 4.0 Enable or disable by BIOS setup
Audio	VIA VT 1612A AC97 CODEC on board
Keyboard	PS/2
Mouse	PS/2
Wall Mount	VESA standard 100mm
System Size	350mm (L) x 350mm (W) x 350mm (H), min. height when folded: 160mm
S/W Compatibility	DOS/OS2 V2.1/SCO XENIX: V2.3.2/SCO UNIX V3.2/NOVELL/WIN 3.1/95/98/2000/XP/NT4.0
Operation Temp.	0°C to 40°C (without HDD up to 50°C)
Storage Temp.	-25°C to 70°C
Optional Device	ISO Trick 1/2/3 Magnetic Stripe Reader Smart Card Reader 20 column * 2 lines VFD Customer Display Optical Finger Print Sensor 10.4" or 12.1" LCD Customer Display

ITEM	SPECIFICATION
	32 Keys Programmable POS Keyboard

**Note:**

Specifications are subject to change without notice.

### Frequently Asked Questions (FAQ)

**Question 1: Why does the system appear unstable after updating BIOS?**

Answer: Load optimized defaults (or load SETUP Default) after flashing BIOS. If the system remains unstable, clear CMOS to solve the problem.

**Question 2: How do I clear CMOS?**

Answer: To clear CMOS, do the following:

1. Turn off power and switch off the power adapter.
2. Remove the jumper from clear CMOS 2-3 PIN and insert the jumper to clear COMS 1-2 PIN.
3. Remove the jumper from clear CMOS 1-2 PIN and re-insert the jumper to clear CMOS 2-3 PIN.
4. Switch on the power again.
5. Press **Delete** to enter COMS setting and load optimized defaults.
6. Save changes and reboot the system.

**Question 3: How to use Boot Menu?**

Answer: To use the Boot Menu, do the following:

1. Press **F9** to enter the Boot Menu.
2. Select the Boot device from the Boot Menu.

## Free Manuals Download Website

<http://myh66.com>

<http://usermanuals.us>

<http://www.somanuals.com>

<http://www.4manuals.cc>

<http://www.manual-lib.com>

<http://www.404manual.com>

<http://www.luxmanual.com>

<http://aubethermostatmanual.com>

Golf course search by state

<http://golfingnear.com>

Email search by domain

<http://emailbydomain.com>

Auto manuals search

<http://auto.somanuals.com>

TV manuals search

<http://tv.somanuals.com>