

**FUJI UG230 SERIES PROGRAMMABLE OPERATION DISPLAY**

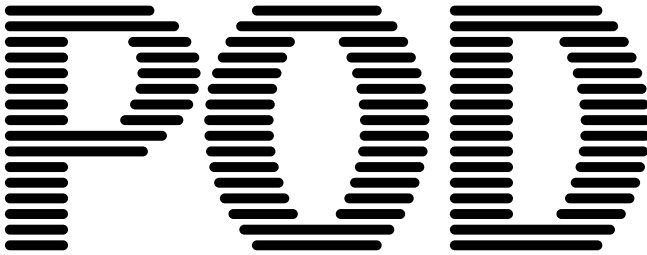

**USER'S MANUAL <Hardware>**

TYPE: UG230H-LS4x  
UG230H-SS4x  
UG230H-TS4x

---

# Preface

---

Thank you for selecting the Fuji Programmable Operation Display, POD UG230 Series (called as the UG230 or POD hereafter).

This User's Manual <UG230 Hardware> explains system configuration, specifications and handling of the UG230 Series. To enable you to fully utilize the display, carefully read this User's Manual.

For more information on the UG230 Series, refer to the following manuals as well.

Name	Manual No.	Contents
UG Series <Operation>	FEH375	Describes operating procedures of the screen editor (UG00S-CW) for the UG Series.
UG Series <Function>	FEH376	Describes the functions available with the UG30/20 Series.
UG Series <PLC Connection>	FEH380	Describes connections with PLCs, universal serial communications, etc.
UG Series <Supplementary Manual>	FEH376-1	Supplementary information for the UG Series <Function>
UG Series <Tutorial>	FEH350	Tutorial manual for novices in the UG Series

For further details about PLCs (programmable logic controllers), see the manual attached to each PLC.

**Notes:**

1. This manual may not, in whole or in part, be printed or reproduced without the prior written consent of Fuji Electric FA Components & Systems Co., Ltd.
2. The information in this manual is subject to change without prior notice.
3. Windows and Excel are registered trademarks of Microsoft Corporation in the United States and other countries.
4. All other company names or product names are trademarks or registered trademarks of their respective holders.
5. This manual is intended to give accurate information about POD hardware. If you have any questions, please contact your local distributor.

## Record of Revisions

Reference numbers are shown at the bottom left corner on the back cover of each manual.

Printing Date	Reference No.	Revised Contents
February, 2004	FEH381	First edition

---

## Notes on Safe Use of POD

---

In this manual, you will find various notes categorized under the following levels with the signal words "DANGER," and "CAUTION."



**DANGER**

Indicates an imminently hazardous situation which, if not avoided, will result in death or serious injury.



**CAUTION**

Indicates a potentially hazardous situation which, if not avoided, may result in minor or moderate injury and could cause property damage.

Note that there is a possibility that the item listed with  CAUTION may have serious ramifications.



**DANGER**

- Never use the input function of POD for operations that may threaten human life or to damage the system, such as switches to be used in case of emergency. Please design the system so that it can cope with malfunction of a touch switch. A malfunction of the touch switch will result in machine accident or damage.
- Turn off the power supply when you set up the unit, connect cables or perform maintenance and inspection. Otherwise, electrical shock or damage may occur.
- Never touch any terminals while the power is on. Otherwise, electric shock may occur.
- You must put a cover on the terminals on the unit when you turn the power on and operate the unit. Without the terminal cover in place, an electric shock may occur.
- The liquid crystal in the LCD panel is a hazardous substance. If the LCD panel is damaged, never swallow the leaked liquid crystal. If the liquid crystal spills on your skin or clothing, use soap and wash off thoroughly.
- For POD using a lithium battery, never disassemble, recharge, deform by pressure, short-circuit, nor reverse the polarity of the battery, and never dispose of the battery in fire. Failure to follow these conditions will lead to explosion or ignition.
- For POD using a lithium battery, never use a battery that is deformed, leaks, or shows any other signs of abnormality. Failure to follow these conditions will lead to explosion or ignition.

## CAUTION

- Check the appearance of the unit when it is unpacked. Do not use the unit if any damage or deformation is found. Failure to do so may lead to fire, damage or malfunction.
- For use in a facility or for a system related to nuclear energy, aerospace, medical, traffic equipment, or mobile installations, please consult your local distributor.
- Operate (or store) POD under the conditions indicated in this manual and related manuals. Failure to do so could cause fire, malfunction, physical damage or deterioration.
- Understand the following environmental limits for use and storage of POD. Otherwise, fire or damage to the unit may result.
  - Avoid locations where there is a possibility that water, corrosive gas, flammable gas, solvents, grinding fluids or cutting oil can come into contact with the unit.
  - Avoid high temperature, high humidity, and outside weather conditions, such as wind, rain or direct sunlight.
  - Avoid locations where excessive dust, salt, and metallic particles are present.
  - Avoid installing the unit in a location where vibration or physical shock may be transmitted.
- Equipment must be correctly mounted so that the main terminal of POD will not be touched inadvertently. Otherwise, an accident or electric shock may occur.
- Tighten the fixtures of the POD with a torque in the specified range. Excessive tightening may distort the panel surface. Loose tightening may cause POD to come off, malfunction or be short-circuited.
- Check periodically that terminal screws on the power supply terminal block and fixtures are firmly tightened. Loosened screws may result in fire or malfunction.
- Tighten terminal screws on the power supply terminal block equally to a torque of 0.5 N•m. Improper tightening of screws may result in fire, malfunction, or trouble.
- POD has a glass screen. Do not drop or give physical shock to the unit. Otherwise, the screen may be damaged.
- Connect the cables correctly to the terminals of POD in accordance with the specified voltage and wattage. Over-voltage, over-wattage or incorrect cable connection could cause fire, malfunction or damage to the unit.
- Be sure to establish a ground of POD. Ground FG terminal which must be used for the unit. Otherwise, electric shock or a fire may occur.
- Prevent any conductive particles from entering into POD. Failure to do so may lead to fire, damage or malfunction.
- After wiring is finished, remove the paper used as a dust cover before starting to operate POD. Operation with the cover attached may result in accident, fire, malfunction, or trouble.
- Do not attempt to repair POD at your site. Ask us or the designated contractor for repair.
- Do not disassemble or modify POD. Otherwise, it may cause a malfunction.
- Fuji Electric FA Components & Systems Co., Ltd. is not responsible for any damages resulting from repair, overhaul or modification of POD that was performed by an unauthorized person.
- Do not use a sharp-pointed tool when pressing a touch switch. Doing so may damage the screen.
- Only experts are authorized to set up the unit, connect the cables or perform maintenance and inspection.
- For POD using a lithium battery, handle the battery with care. The combustible materials such as lithium or organic solvent contained in the battery may generate heat, explode, or catch fire, resulting in personal injury or fire. Read related manuals carefully and handle the lithium battery correctly as instructed.
- When using a POD that has analog switch resolution with resistance film, do not press two or more points on the screen at the same time. If there is a switch between the two pressed points, it may be activated.
- Take safety precautions during such operations as setting change during running, forced output, start, and stop. Any misoperation may cause unexpected machine motions, resulting in machine accident or damage.
- In facilities where a failure of POD could lead to accident threatening human life or other serious damage, be sure that the facilities are equipped with adequate safeguards.
- At the time of disposal, POD must be treated as industrial waste.
- Before touching POD, discharge static electricity from your body by touching grounded metal. Excessive static electricity may cause malfunction or trouble.

---

[General Notes]

- Never bundle control cables and input/output cables with high-voltage and large-current carrying cables such as power supply cables. Keep these cables at least 200 mm away from the high-voltage and large-current carrying cables. Otherwise, malfunction may occur due to noise.
- Plug connectors or sockets of POD in the correct orientation. Otherwise, it may cause a malfunction.
- Do not use thinners for cleaning because they may discolor the POD surface. Use alcohol or benzine commercially available.
- If a data receive error occurs when POD and the counterpart (PLC, temperature controller, etc.) are started at the same time, read the manual for the counterpart unit and handle the error correctly.
- Avoid discharging static electricity on the mounting panel of the POD. Static charges can damage the unit and cause malfunctions. Otherwise, malfunction may occur due to noise.
- Avoid prolonged display of any fixed pattern. Due to the characteristics of the liquid crystal display, an afterimage may occur. If a prolonged display of a fixed pattern is expected, use the auto OFF function of the backlight.

---

# Contents

---

Preface

Notes on Safe Use of POD

## Chapter 1 Overview

1. Features .....	1-1
2. Models and Peripheral Equipment .....	1-2
POD Models .....	1-2
Peripheral Equipment .....	1-3
3. System Composition .....	1-6
System Composition of UG230 .....	1-6
System Composition of UG230 + UG230A-DCL .....	1-7

## Chapter 2 Specifications

1. Specifications .....	2-1
General Specifications .....	2-1
Display Specifications .....	2-2
Touch Switch Specifications .....	2-2
Function Switch Specifications .....	2-2
Interface Specifications .....	2-3
Clock and Backup Memory Specifications .....	2-3
Drawing Environment .....	2-3
Display Function Specifications .....	2-4
Function Performance Specifications .....	2-5
2. Dimensions and Panel Cut-out .....	2-6
UG230 External View and Dimensions .....	2-6
UG230 + UG230A-DCL External View and Dimensions .....	2-7
3. Names and Functions of Components .....	2-8
4. Modular Jack (MJ1/MJ2) .....	2-10
Modular Jack 1 (MJ1) .....	2-10
Modular Jack 2 (MJ2: Exclusive to the UG230) .....	2-11
Notes on Wiring .....	2-14
Transferring Screen Data .....	2-17
Barcode Reader Connection .....	2-17
Printer Connection (Serial Printer) .....	2-18
5. USB Connectors .....	2-19
USB-A (Master Port) .....	2-19
USB-B (Slave Port) .....	2-20
6. D-sub 25-Pin Connector (CN1) (Optional) .....	2-25
Serial Connector (CN1) .....	2-25
7. 10BASE-T (LAN) (Optional) .....	2-26
10BASE-T Connector .....	2-26
Notes on Wiring .....	2-27
8. CF Card .....	2-28
Recommended CF Cards .....	2-28
CF Card Insertion Position .....	2-28
Mounting and Dismounting the CF Card .....	2-29
Notes on Handling the CF Card .....	2-30

<b>Chapter 3</b>		<b>Installation</b>	
1.	Mounting Procedure.....		3-1
	Mounting Procedure.....		3-1
	Mounting Angle.....		3-1
2.	Power Supply Cable Connection.....		3-2
	Power Supply Cable Connection.....		3-2
	Grounding.....		3-3
<b>Chapter 4</b>		<b>Instructions</b>	
1.	Coin-type Lithium Battery.....		4-1
	Battery Mounting Procedure.....		4-1
	Battery Replacement.....		4-2
2.	DIP Switch Setting.....		4-4
	DIP Switch (DIPSW) Setting.....		4-4
3.	Function Switches.....		4-5
	Types.....		4-5
	[SYSTEM] Switch.....		4-5
<b>Chapter 5</b>		<b>Connections</b>	
1.	1 : 1 Connection.....		5-1
2.	1 : n Connection (Multi-drop).....		5-2
3.	n : 1 Connection (Multi-link 2).....		5-3
4.	n : 1 Connection (Multi-link).....		5-4
5.	Universal Serial Communications.....		5-5
6.	UG-Link.....		5-6
7.	PLC2Way.....		5-7
8.	Temperature Control Network.....		5-8
9.	Ethernet.....		5-9
<b>Chapter 6</b>		<b>POD Operations</b>	
1.	Operational Procedures.....		6-1
	POD Operation.....		6-1
2.	Main Menu Screen.....		6-4
	Displaying the Main Menu Screen.....		6-4
	Moving Back to the Screen in the RUN Mode.....		6-4
	Main Menu Screen.....		6-5
1.	I/O Test.....		6-5
1-1.	USB Test.....		6-6
1-2.	Serial Connection Test.....		6-7
1-3.	SYSTEM & Function Switch Test.....		6-13
1-4.	Touch Switch Test.....		6-13
2.	Card Menu Screen.....		6-15
2-1.	Card Recorder Menu Screen.....		6-16
2-2.	Transferring Screen Data from a CF Card.....		6-18
2-3.	Saving Backup Copies of SRAM.....		6-24
2-4.	Messages during Data Transfer.....		6-26
3.	Communication Parameter Screen.....		6-27



---

4.	Extension Program Information .....	6-28
5.	Ethernet (Optional).....	6-29
5-1.	Ethernet Information Screen.....	6-29
5-2.	IP Address Setting .....	6-30
6.	SRAM/Clock.....	6-36
7.	Extended Function Setting.....	6-38

## Chapter 7 Error Correction

1.	Error Messages.....	7-1
1.	Communication Error .....	7-1
2.	Check .....	7-3
3.	Warning.....	7-3
4.	SYSTEM ERROR .....	7-4
5.	Touch Switch is Active .....	7-4
2.	Troubleshooting .....	7-5
	In the Event of an Error .....	7-5
	Probable Symptoms.....	7-5

## Chapter 8 Inspection and Maintenance

1.	Inspection and Maintenance .....	8-1
	Daily Inspection .....	8-1
	Periodical Inspection .....	8-1
2.	Warranty Policy .....	8-2
	Inquiries about Failure.....	8-2
	Warranty Period .....	8-2
	Free-of-charge Repair .....	8-2
	Chargeable Repair .....	8-2

# 1

## Overview

---

1. Features
2. Models and Peripheral Equipment
3. System Composition

---

# 1. Features

---

The UG230 series inherits and heightens the features of the UG20 series as described below.

1. **32k-color Display (except for UG230H-LS4x)**  
32,768-color display makes colorful expression possible.  
JPEG files and bitmap files are clearly displayed in brilliant colors.
  
2. **USB Master/Slave Port as Standard**  
Two ports are provided as standard for diverse applications.  
At the master port, a USB-compatible EPSON STYLUS PHOTO series printer or CF card reader/writer can be used.  
On-site versatility is extended further.  
At the slave port, large quantities screen data can be transferred from the computer at a high speed.
  
3. **SRAM and Clock Function as Standard**  
A 128 kbyte SRAM is standard, allowing backup copies of recipe data or sampling data to be saved with ease.
  
4. **CF Card Interface Supported (USB master port/optional)**  
The CF card can be used for saving multiple screen data, sampling data, recipe data, hard copy images, and other various usages.  
JPEG files and font files can also be saved.
  
5. **10BASE-T Connector Supported (optional)**  
This connector enables Ethernet connection with a host computer or PLC.  
High-speed communications are possible via Ethernet for transferring screen data and reading/writing data from/to the server.
  
6. **Analog Switch/Matrix Switch Supported**  
The switch type can be selected from the lineup according to your application.  
A variety of switch types is available to suit your requirements.

## 2. Models and Peripheral Equipment

### POD Models

The model name consists of the following information.

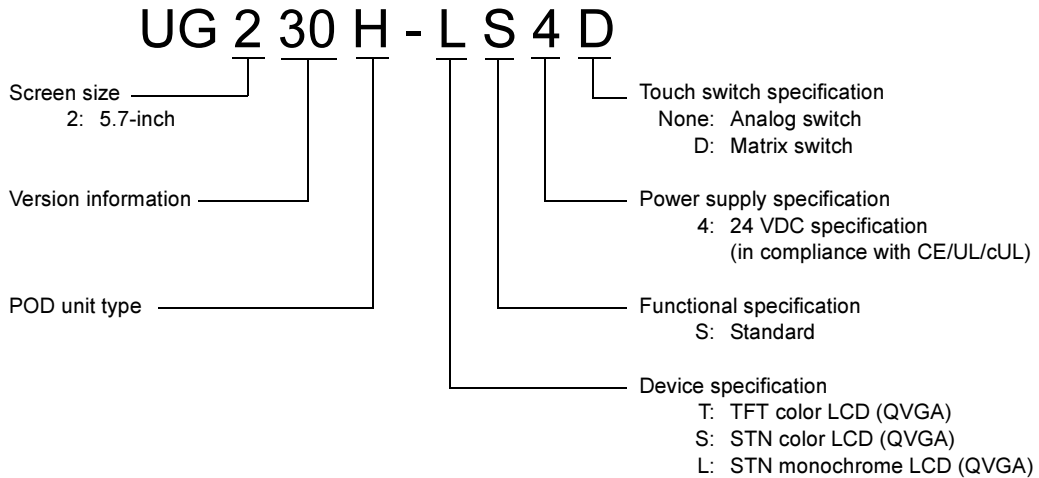

The following models are available.

Series and Size	Model Name	Specifications	Remarks
UG230 series 5.7-inch	UG230H-TS4	TFT color, 320 × 240 dots, analog switch DC power supply	Compliant with CE/UL/cUL
	UG230H-TS4D	TFT color, 320 × 240 dots, matrix switch DC power supply	Compliant with CE/UL/cUL
	UG230H-SS4	STN color, 320 × 240 dots, analog switch DC power supply	Compliant with CE/UL/cUL
	UG230H-SS4D	STN color, 320 × 240 dots, matrix switch DC power supply	Compliant with CE/UL/cUL
	UG230H-LS4	STN monochrome, 320 × 240 dots, analog switch DC power supply	Compliant with CE/UL/cUL
	UG230H-LS4D	STN monochrome, 320 × 240 dots, matrix switch DC power supply	Compliant with CE/UL/cUL

## Peripheral Equipment

The following options are available for using the UG230 series more effectively.

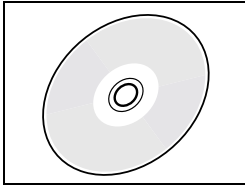

### UG00S-CWV3 (configuration software: English/Japanese)

Application software for editing display data for the POD.  
(Windows98/NT4.0/Me/2000/XP compatible)  
The UG230 series is supported with ver. 3.2.0.0 and later.

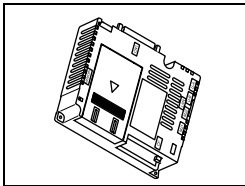

### UG230A-DCL (option unit)

Optional unit to be used for D-sub 25-pin connector, CF card and Ethernet.

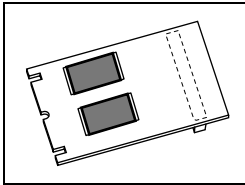

### UG230P-D4 (FLASH memory cassette)

Extension print circuit board to extend the memory for screen data.  
The capacity of FLASH memory is 4 Mbyte.

\* Only when the UG230A-DCL (option unit) is provided

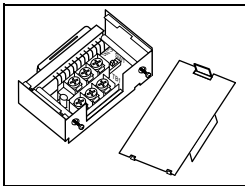

### UG00P-TC (terminal converter)

Used for connection between the UG30 series and a PLC at the RS-422/485 terminal block.

\* Only when the UG230A-DCL (option unit) is provided

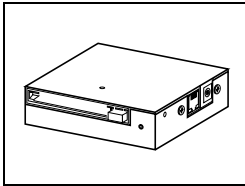

### UG00P-MR (card recorder)

The card recorder creates a backup copy of screen data or works as an external memory storage system for memory manager and data logging functions.

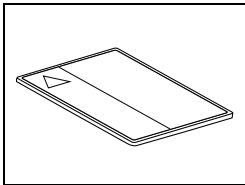

### UG00K-xx (memory card) compliant with JEIDA ver. 4.0

Used with the card recorder when having a backup copy of screen data or saving data on an external medium for memory manager and data logging functions.

SRAM	256 K, 512 K, 1 M, 2 M, 4 Mbyte
FLASH ROM	256 K, 512 K, 1 Mbyte

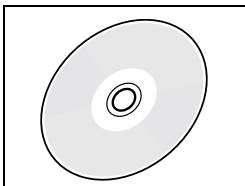

### UG00P-MS (memory card editor: English/Japanese)

Application software for editing data stored on a memory card, SRAM or CF card.  
(Windows98/NT4.0/Me/2000/XP compatible)

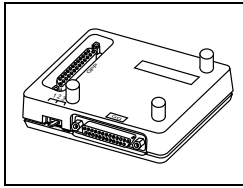

**UG00P-DI (ACPU/QnACPU/FXCPU dual port interface)**

Add-on connector with two ports, specifically designed for the connector on the MITSUBISHI's ACPU/QnACPU/FXCPU programmer. Operability can be improved when directly connecting the POD to the ACPU/QnACPU/FXCPU programmer.

\* Only when the UG230A-DCL (option unit) is provided

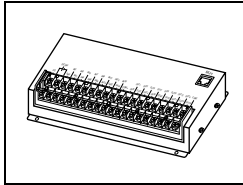

**UG00P-U2 (serial extension I/O)**

Used as an external I/O unit for PLC. It has 16 inputs and 16 outputs.

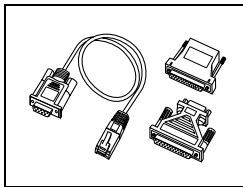

**UG00C-T (screen data transfer cable) 3 m**

Used for connection between the POD and a personal computer, or a personal computer and the card recorder (UG00P-MR).

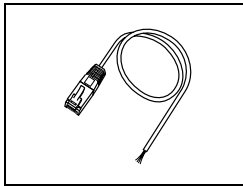

**UG00C-B (barcode reader connection cable) 3 m**

Used for connection between the POD and a barcode reader.

This is also used for connection between the POD and a temperature controller via RS-232C.

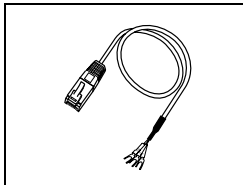

**UG00C-H (multi-link 2 master cable/temperature controller connection cable) 3 m**

Used for Multi-Link 2 connection between the POD master station and the POD slave station.

This is also used for connection between the POD and a temperature controller via RS-422 (485).

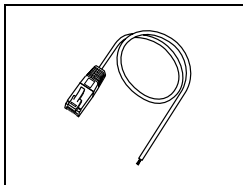

**UG00C-P (temperature controller connection cable) 3 m**

Used for connection between the POD and a temperature controller or a PLC using the PLC2Way function via RS-422 (4-wire connection).

This is also used for connection with a PLC at the MJ2 port on the UG230.

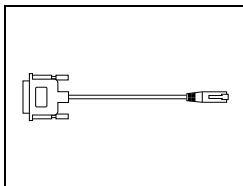

**UG30C-J (MJ2-to-D-sub conversion cable) 0.3 m**

Used for connection between the UG230 and a PLC at MJ2.

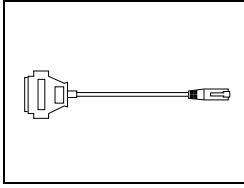

**UG30C-M (MJ-to-D-sub conversion cable) 0.3 m**  
Used for connection of the POD via PLC2Way.

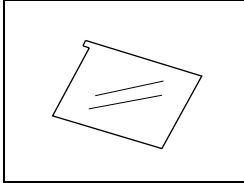

**UGxxP-PS (protective sheet)**  
This sheet protects the operation panel surface. (5 sheets/set)

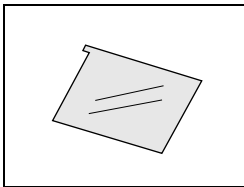

**UGxxP-PT (protective sheet)**  
This anti-glare sheet protects the operation panel surface. (5 sheets/set)

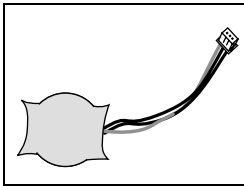

**UG30P-BT (battery for replacement)**  
Replacement lithium battery for the UG30 series.

## 3. System Composition

### System Composition of UG230

The following illustration shows possible system configurations using the UG230.

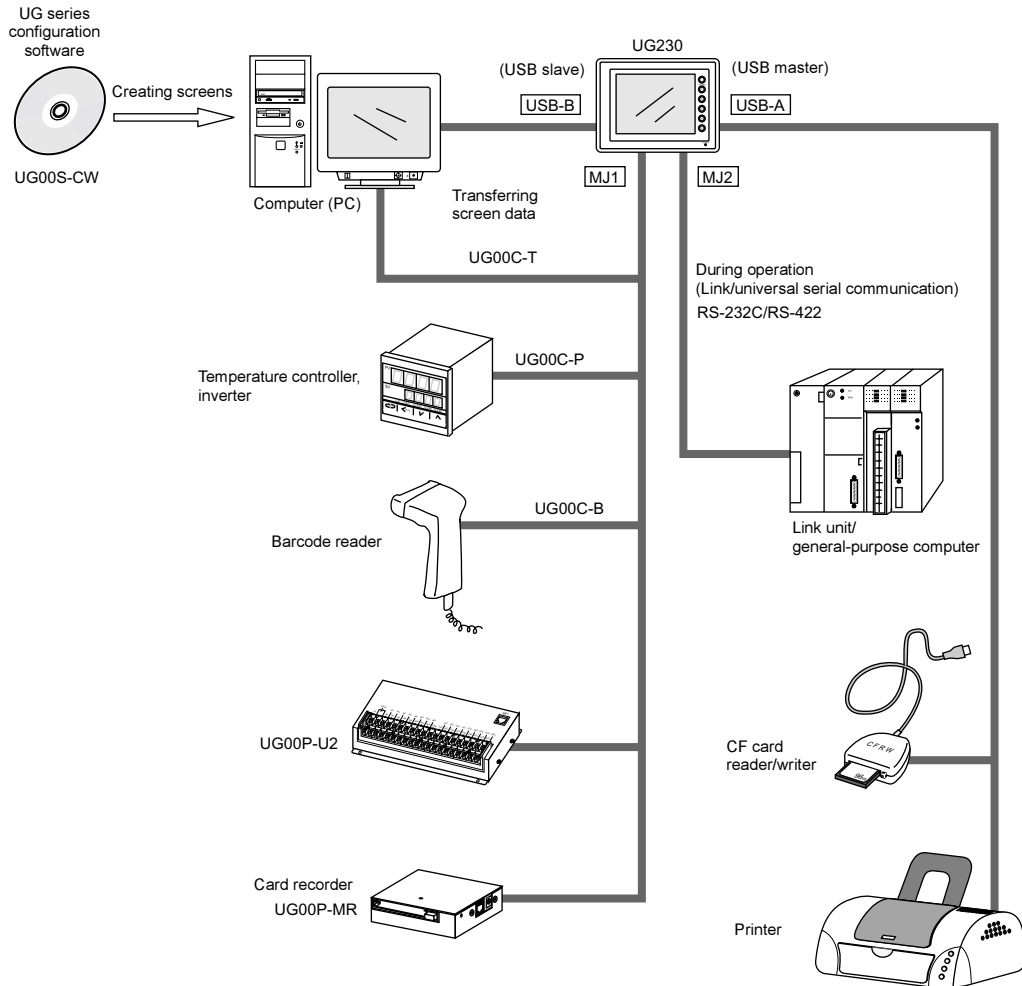



## System Composition of UG230 + UG230A-DCL

The following illustration shows possible system configurations using the UG230 and the UG230A-DCL.

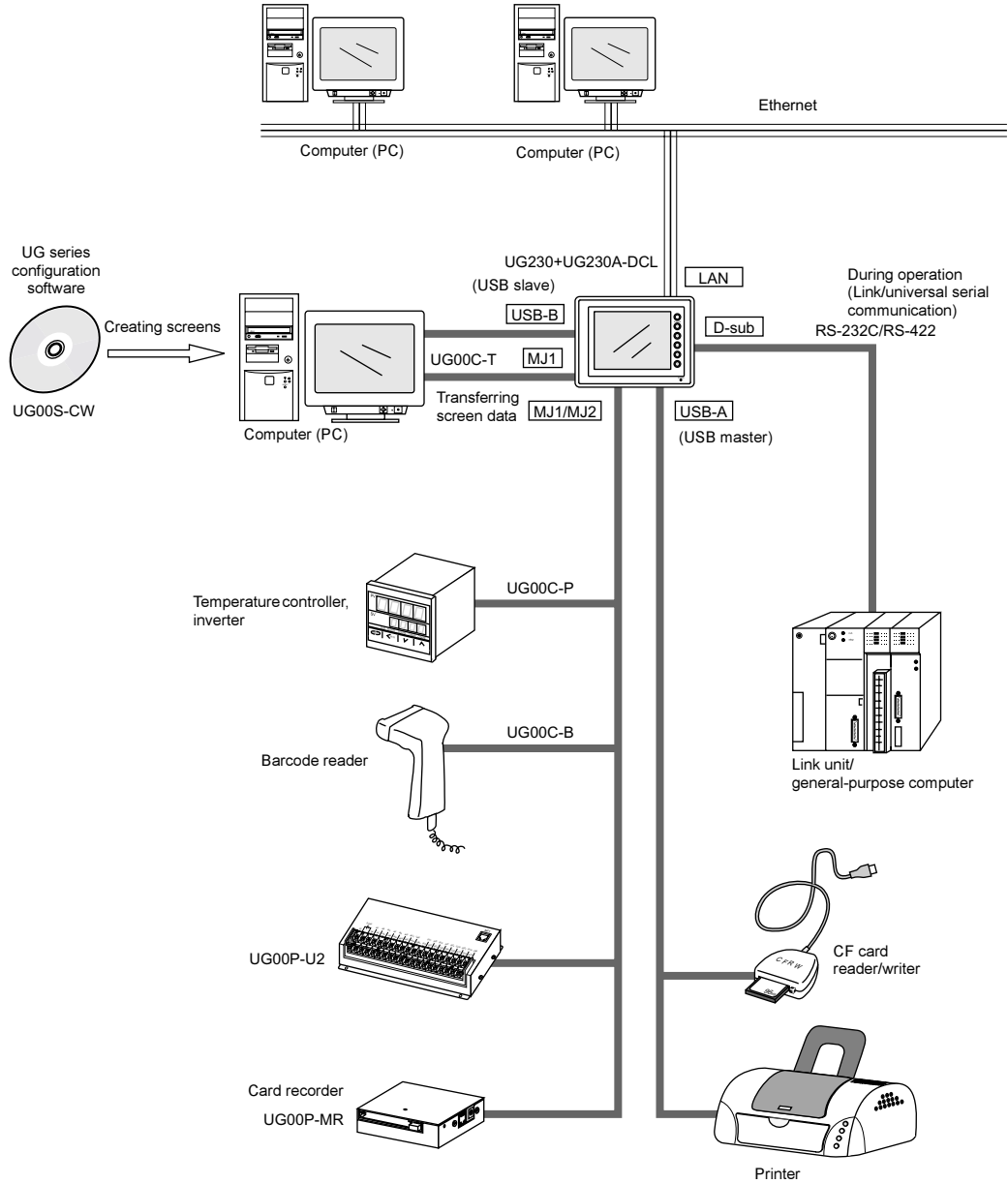

# MEMO

Please use this page freely.

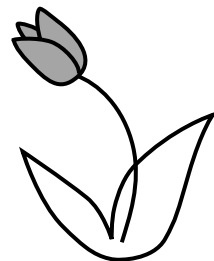

# 2 Specifications

---

1. Specifications
2. Dimensions and Panel Cut-out
3. Names and Functions of Components
4. Modular Jack (MJ1/MJ2)
5. USB Connectors
6. D-sub 25-Pin Connector (CN1) (Optional)
7. 10BASE-T (LAN) (Optional)
8. CF Card

# 1. Specifications

## General Specifications

	Item	Specifications
Power Supply	Rated Voltage	24 VDC
	Permissible Range of Voltage	24 VDC $\pm$ 10%
	Permissible Momentary Power Failure	Within 1 ms
	Power Consumption (Maximum Rating)	16 W or less
	Rush Current	20 A or less (with a rise time 0.1 ms)
	Withstand Voltage	DC external terminals to FG: 500 VAC, 1 minute
Insulation Resistance		500 VDC, 10 M $\Omega$ or above
Physical Environment	Ambient Temperature	0°C to +50°C *
	Storage Ambient Temperature	-10°C to +60°C
	Ambient Humidity	85% RH or less (without dew condensation)
	Solvent Resistance	No cutting oil or organic solvent attached to the unit
	Atmosphere	No corrosive gas or conductive dust
Mechanical Working Conditions	Vibration Resistance	Vibration frequency: 10 to 150 Hz, Acceleration: 9.8 m/s <sup>2</sup> Single amplitude: 0.075 mm, X, Y, Z: 3 directions for one hour
	Shock Resistance	Pulse shape: Sine half wave Peak acceleration: 147 m/s <sup>2</sup> , X, Y, Z: 3 directions six times each
Electrical Working Conditions	Noise Resistance	1000 Vp-p (pulse width 1 $\mu$ s, rise time: 1 ns)
	Static Electricity Discharge Resistance	Compliant with IEC61000-4-2, contact: 6 kV, air: 8 kV
Mounting Conditions	Grounding	Grounding resistance: less than 100 $\Omega$
	Structure	Protection structure: Front panel: compliant with IP65 (when using waterproof gasket) Rear case: compliant with IP20 Form: In a single body Mounting procedure: Inserted in a mounting panel
	Cooling System	Cooling naturally
	Weight	Unit only: approx. 680 g, with UG230A-DCL installed: approx. 820 g
	External Dimensions W $\times$ H $\times$ D (mm)	Unit only: 182.5 $\times$ 138.8 $\times$ 42.5, with UG230A-DCL installed: 182.5 $\times$ 138.8 $\times$ 64.0
	Panel Cut-out Dimensions (mm)	174 <sup>+0.5</sup> $\times$ 131 <sup>+0.5</sup>
	Case Color	Black (Munsell N2.0)
Material	PC/PS resin (Tarflon)	

\* As for UG230H-SS4x and UG230H-LS4x, operation for long hours at ambient temperatures of 40 to 50°C may degrade the display quality, such as lowering contrast.

## Display Specifications

Item	Model		
	UG230H-TS4x	UG230H-SS4x	UG230H-LS4x
Display Device	TFT color LCD	STN color LCD	STN monochrome LCD
Display Size	5.7-inch		
Colors	32,768 colors +16-color blinks		Monochrome 8-grade + blink
Resolution	W × H (dots)	320 × 240	
Dot Pitch	W × H (mm)	0.36 × 0.36	0.36 × 0.36
Brightness (cd/m <sup>2</sup> )		350	160
Contrast Ratio		60 : 1	30 : 1
Angle of Vertical Visibility (°)		+65, -40	+20, -35
Angle of Horizontal Visibility (°)		±65	±50
Backlight	Cold cathode rectifier (cannot be replaced by users)		
Average Backlight Life <sup>*1</sup>	Approx. 50,000 h	Approx. 54,000 h	Approx. 58,000 h
Backlight Auto OFF Function	Always ON, random setting		
Contrast Adjustment	Not provided	Provided <sup>*2</sup>	
Brightness Adjustment	128 levels <sup>*3</sup>	Not provided	
Surface Sheet	Material: Polycarbonate, 0.3 mm thick		
POWER Lamp	Illuminated in green when the power is on; illuminated in orange when the voltage of the battery (with its cable connected) has become low.		
MJ2 Function Selection	Slide switch Down: RS-422 (4-wire) Up: RS-232C		

\*1 When the normal temperature is 25°C, and the surface luminance of the display is 50% of the initial setting

\*2 Adjustable with function switches

\*3 By using the macro command

## Touch Switch Specifications

Item	Specifications
Method	Analog resistance film type, matrix resistance film type
Switch Resolution	Analog: 1024 (W) × 1024 (H) Matrix: 20 (W) × 12 (H)
Mechanical Life	One million activations or more
Surface Treatment	Hard-coated, anti-glare treatment 5%

## Function Switch Specifications

Item	Specifications
Number of Switches	6
Method	Digital resistance film
Mechanical Life	One million activations or more

## Interface Specifications

Item	Specifications
Screen Data Transfer/External Connection Serial Interface (Modular jack, 8-pin: MJ1)	RS-232C, RS-422/485 (2-wire connection) UG00P-MR, Barcode, UG00P-U2, Multi-link 2, Temperature control network/PLC2Way, UG-link, etc.
PLC Connection Serial Interface (Modular jack, 8-pin: MJ2)	RS-232C, RS-422 (4-wire connection) Asynchronous type Data length: 7, 8 bits Parity: Even, odd, none Stop bit: 1, 2 bits Baud Rate: 4800, 9600, 19200, 38400, 57600, 76800, 115200 bps
Printer/CF Card Reader Connection USB Master Port (USB-A)	Type A, USB Ver. 1.1
Screen Data Transfer USB Slave Port (USB-B)	Type B, USB Ver. 1.1

## Clock and Backup Memory Specifications

Item	Specifications
Battery Specification	Coin-type lithium primary cell
Backup Memory	SRAM 128 kbyte
Backup Time Period	5 years (ambient temperature at 25°C)
Battery Voltage Drop Detection	Provided (internal memory allocated)
Calendar Accuracy	Monthly deviation $\pm 90$ sec (ambient temperature at 25°C)

## Drawing Environment

Item	Specifications
Drawing Method	Exclusive drawing software
Drawing Tool	Name of exclusive configuration software: UG00S-CW (Ver. 3.2.0.0 and later) Personal computer: Pentium II 450 MHz or above recommended OS: Windows98/Me/NT Ver.4.0/2000/XP Capacity of hard disk required: Free space of approx. 460 Mbyte or more (For minimum installation: approx. 105 Mbyte) Display: Resolution 800 × 600 or above recommended

## Display Function Specifications

Item		Specifications				
Display Language*		USEnglish	English/Western Europe	Chinese (traditional)	Chinese (simplified)	Korean
Characters	1/4-size, 1-byte	ANK code	Latin1	ASCII code	ASCII code	ASCII code
	2-byte 16-dot	JIS #1, 2 levels	–	Chinese (traditional)	Chinese (simplified)	Hangul (without Kanji)
	2-byte 32-dot	JIS #1 level	–	–	–	–
Character Size		1/4-size: 8 × 8 dots 1-byte: 8 × 16 dots 2-byte: 16 × 16 dots or 32 × 32 dots Enlarge: W: 1 to 8 times, H: 1 to 8 times				
Number of Displayable Characters		Resolution	320 × 240			
		1/4-size	40 characters × 30 lines			
		1-byte	40 characters × 15 lines			
		2-byte	20 characters × 15 lines			
Characters Properties		Display properties:	Normal, reverse, blink, bold, shadow			
		Colors:	32,768 colors + blink 16 colors / monochrome 8-grade + blink			
Graphics		Lines:	Line, continuous line, box, parallelogram, polygon			
		Circles:	Circle, arc, sector, ellipse, elliptical arc			
		Others:	Tile patterns			
Graphic Properties		Line types:	6 (thin, thick, dot, chain, broken, two-dot chain)			
		Tile patterns:	16 (incl. user-definable 8 patterns)			
		Display properties:	Normal, reverse, blink			
		Colors:	32,768 colors + blink 16 colors / monochrome 8-grade + blink			
		Color selection:	Foreground, background, boundary (line)			

\* In addition, the following fonts are available. For more information, refer to the User's Manual <Operation> (FEH375) and the User's Manual <Supplementary Manual> (FEH376-1).  
 Gothic, English/Western Europe (HK Gothic), English/Western Europe (HK Times), Central Europe, Cyrillic, Greek, Turkish

## Function Performance Specifications

Item		Specifications
Screens		Max. 1024
Screen Memory		Flash memory: Approx. 1,472 kbyte (varies depending on the font)
Switches		192 per screen
Switch Actions		Set, reset, momentary, alternate, to light (Possible to press a function switch and a switch on the display at the same time) (Matrix type: Possible to press two switches on the display at the same time)
Lamps		Reverse, blink, exchange of graphics 192 per screen
Graphs		Pie, bar, panel meter and closed area graph: No limitation within 256 kbyte per screen <sup>*1</sup> Statistics and trend graphs: Max. 256 per layer <sup>*2</sup>
Data Setting	Numerical Data Display	No limitation within 256 kbyte per screen <sup>*1</sup>
	Character Display	No limitation within 256 kbyte per screen <sup>*1</sup>
	Message Display	Resolution: Max. 40 1-byte characters No limitation within 256 kbyte per screen <sup>*1</sup>
Sampling		Sampling display of buffer data (Constant sample, bit synchronize, bit sample, relay sample, alarm function)
Graphic Library		Max. 2560
Multi-Overlaps		Max. 1024
Data Blocks		Max. 1024
Messages		Max. 6144 lines
Patterns		Max. 1024
Macro Blocks		Max. 1024
Page Blocks		Max. 1024
Direct Blocks		Max. 1024
Screen Blocks		Max. 1024
Data Sheets		Max. 1024
Screen Library		Max. 1024
Temperature Control Network/ PLC2Way Table		Max. 32
Time Display		Time display function: provided
Hard Copy		Screen hard copy function: provided
Buzzer		Buzzer: provided, 2 sounds (short beep, long beep)
Auto OFF Function		Always ON, random setting
Self-diagnostic Function		Switch self-test function Communication parameter setting check function Communication check function

\*1 The number of setting memory locations is limited to 256 per screen.

\*2 Layer: 4 per screen (base + 3 overlaps)



## 2. Dimensions and Panel Cut-out

### UG230 External View and Dimensions

(Unit: mm)

- Front View

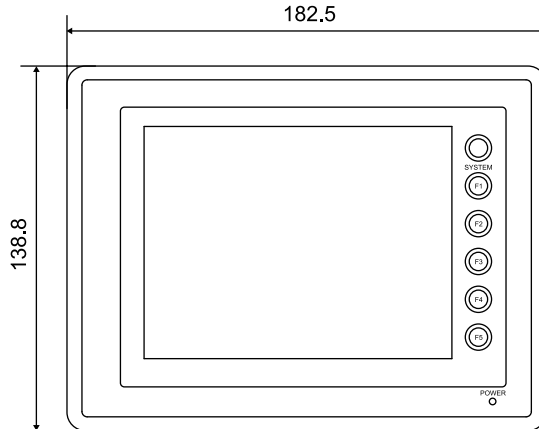

- Side View

- Rear View

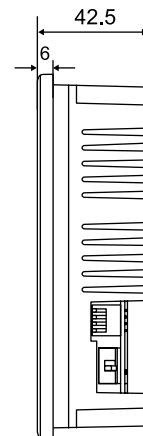
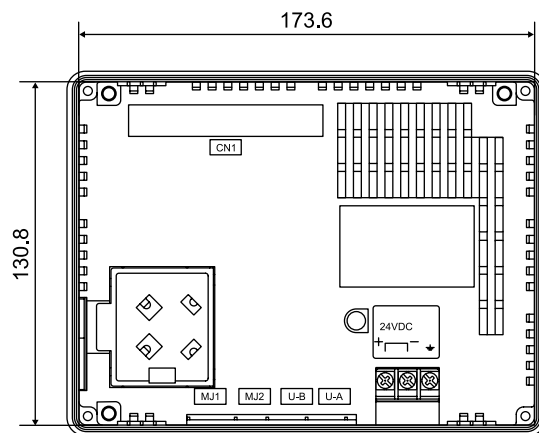

- Bottom View

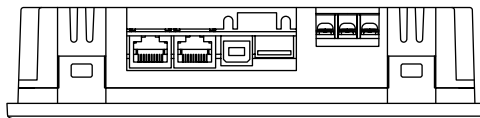

- Panel Cut-out Dimensions

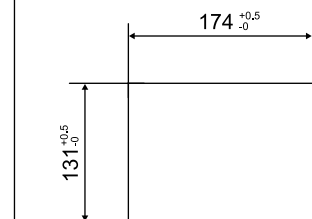

## UG230 + UG230A-DCL External View and Dimensions

(Unit: mm)

- Front View

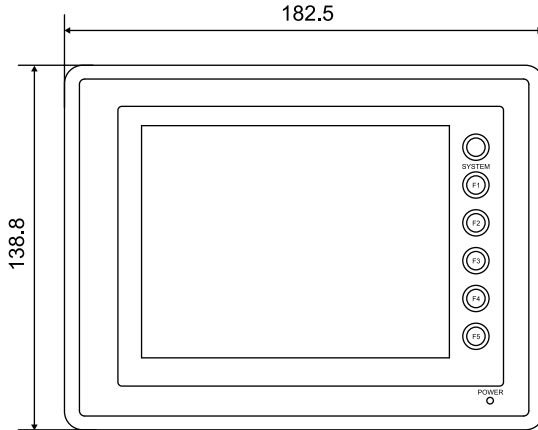

- Side View

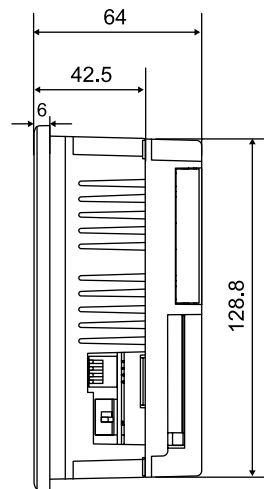

- Rear View

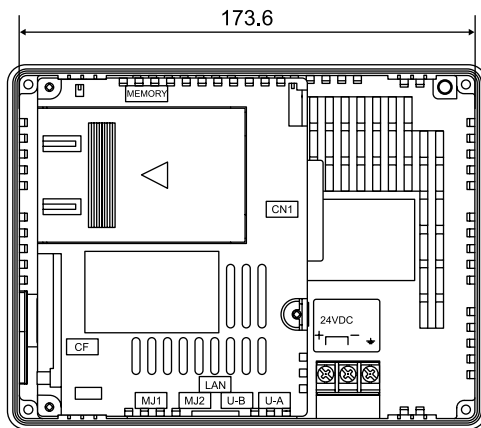

- Bottom View

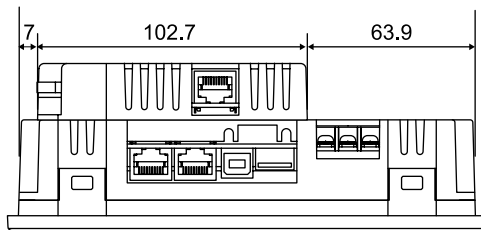

- Panel Cut-out Dimensions

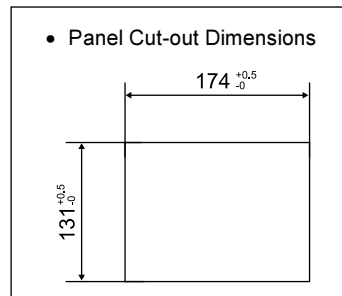

## 3. Names and Functions of Components

### UG230

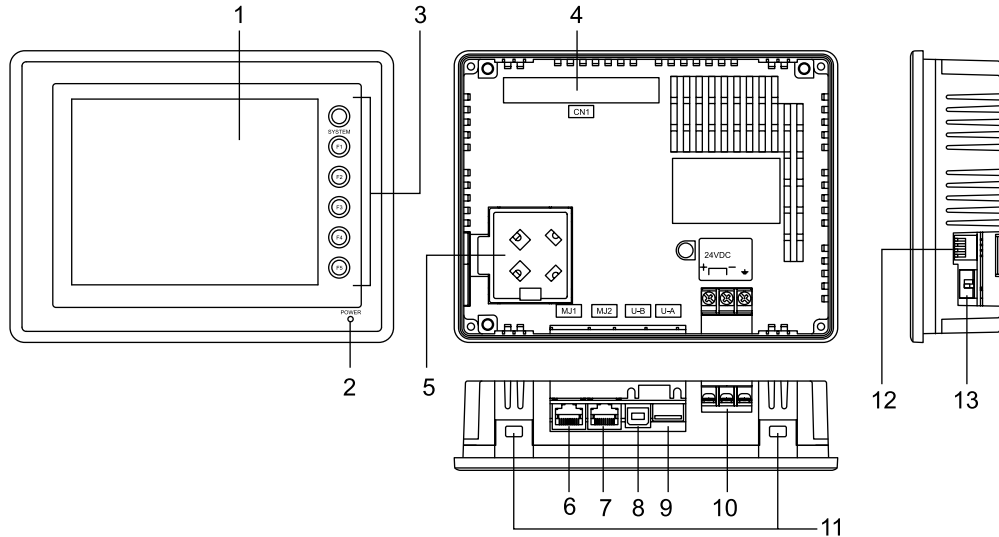

### UG230+UG230A-DCL

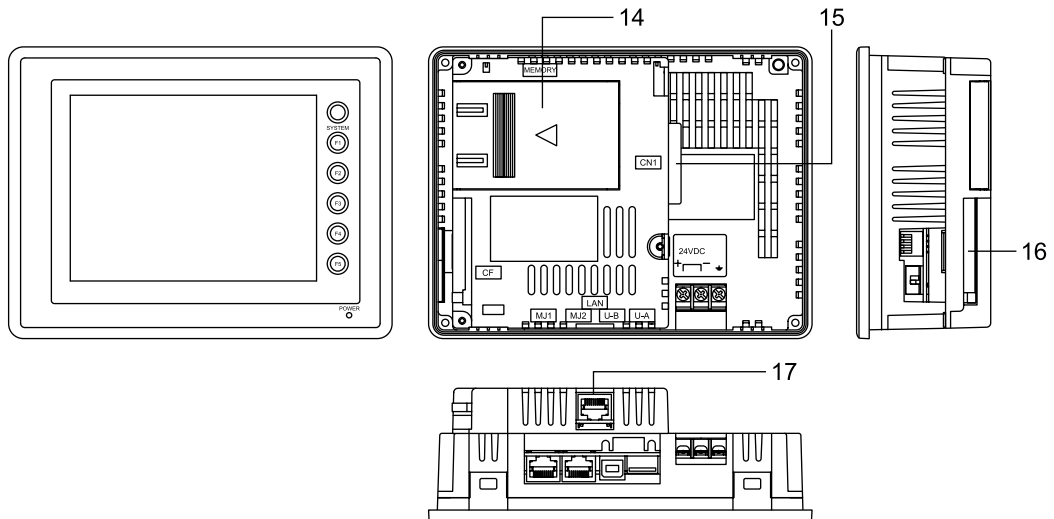

1. Display  
This is the display unit.
2. Power lamp (POWER)  
Illuminates (green) when the power is supplied. The lamp illuminates (orange) when the voltage of the battery set in the POD has become low.
3. Function switches  
Used for RUN /STOP selection, contrast adjustment, brightness adjustment and backlight ON/OFF (according to the setting). These switches can be used as user switches in the RUN mode.

4. Option unit connector (CN1)  
This is the connector where the option unit UG230A-DCL is mounted.
5. Battery holder  
Contains a backup battery for SRAM and clock.  
When the battery voltage drops, replace the battery with a new one (UG30P-BT).
6. Modular jack connector (MJ1)  
This is used for screen data transfer and connection with temperature controller, barcode reader, UG00P-MR, etc.
7. Modular jack connectors (MJ2)  
This is used for connection with the PLC.  
With the option unit UG230A-DCL mounted, the modular jack allows you to connect a barcode reader, serial printer, etc.
8. USB-B (slave port)  
This is the connector for screen data transfer.
9. USB-A (master port)  
This is the connector where a printer or a CF card reader/writer is connected.
10. Power supply terminal block  
Supplies the power (24 VDC) to the UG230.
11. Mounting holes  
Used for inserting fixtures when securing the POD to the mounting panel.
12. DIP switch  
This is used for setting the terminating resistors of the MJ1/MJ2 RS-422/485 signal line.
13. Slide switch  
This is used for switching between the RS-232C and RS-422 ports for the MJ2.
14. Add-on memory connector (MEMORY) (optional)  
With the option unit UG230A-DCL mounted, this is used for mounting an optional FLASH memory cassette (UG230P-D4).
15. PLC communication connector (CN1) (optional)  
With the option unit UG230A-DCL mounted, this is used for connecting the UG230 and a PLC or an external control unit (computer, custom controller, etc.).
16. CF card connector (CF) (optional)  
This is the connector where the CF card is inserted when the option unit UG230A-DCL is installed.
17. 10BASE-T connector (LAN) (optional)  
With the option unit UG230A-DCL mounted, this is used for Ethernet connection.

## 4. Modular Jack (MJ1/MJ2)

### Modular Jack 1 (MJ1)

This is a modular connector used for connection for screen data transfer, temperature controller, barcode reader, card recorder (UG00P-MR) or serial extension I/O (UG00P-U2).

Bottom View

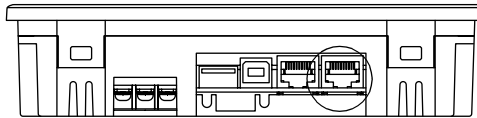

The pins of modular jack 1 correspond to signals as given below.

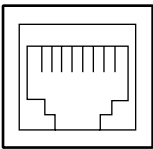
MJ1	Pin No.	Signal Name	Contents
	1	+SD/RD	RS-485 +data
	2	-SD/RD	RS-485 - data
	3	+5V	Externally supplied +5 V Max. 150 mA*
	4	+5V	
	5	SG	Signal ground
	6	SG	
	7	RD	RS-232C receive data
	8	SD	RS-232C send data

\* The maximum current for external supply (+5V) is 150 mA when the MJ1 or MJ2 is used.

### Editor (UG00S-CW) Setting

- The use of modular jack 1 can be set on the editor.
- Select [Modular] from the [System Setting] menu. The [Modular Jack] dialog is displayed. Select the use of modular jack 1 from the following options.

Modular Jack 1  
 [Editor Port]<sup>\*1</sup>  
 [Card Recorder]<sup>\*2</sup>  
 [Barcode]<sup>\*3</sup>  
 [UG00P-U2]  
 [Multi-Link]<sup>\*4</sup>  
 [Temp. /PLC2Way]  
 [UG-Link]  
 [Ladder Tool]<sup>\*5</sup>  
 [Modbus Slave]<sup>\*6</sup>  
 [Printer (Serial Port)]<sup>\*7</sup>

\*1 Refer to "Transferring Screen Data" (page 2-17).

\*2 Select this option when connecting the card recorder (UG00P-MR).

\*3 Refer to "Barcode Reader Connection" (page 2-17).

\*4 Select this open when "Multi-link 2" is selected for [Connection] and "1" is set for [Local Port] on the [Comm. Parameter] dialog.

\*5 Select this option when using the ladder transfer function.

\*6 Select this option for Modbus slave connection.

\*7 Select this option when connecting the printer with serial interface.  
 Refer to page 2-18.

## Modular Jack 2 (MJ2: Exclusive to the UG230)



Before using the MJ2, select whether it is used as an RS-232C or RS-422 port using the slide switch.  
The switch is factory-set to RS-422.

This is a modular jack connector used for connection with the PLC.  
Unlike the MJ1, the connector is available as an RS-422 (4-wire) port.

Bottom View

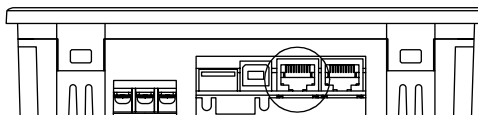

The pins of modular jack 2 correspond to signals as given below.

MJ2	Pin No.	Signal Name	Contents
	1 *1	Not used	Not used
		+SD	RS-422 + send data
	2 *1	Not used	Not used
		-SD	RS-422 -send data
	3	+5V	Externally supplied +5 V Max. 150 mA <sup>2</sup>
	4		
	5	SG	Signal ground
	6		
7 *1	RD	RS-232C receive data	
	+RD	RS-422 + receive data	
8 *1	SD	RS-232C send data	
	-RD	RS-422 - receive data	

\*1 Switch between RS-232C and RS-422 for pin Nos. 1, 2, 7, and 8 with the slide switch on the POD.

\*2 The maximum current for the output power supply (+5 V) is 150 mA when MJ1 or MJ2 is used.

### Without the Option Unit UG230A-DCL

The MJ2 is usable as a port for PLC connection.

#### Slide switch

- Use the switch to set the signal level for the MJ2.

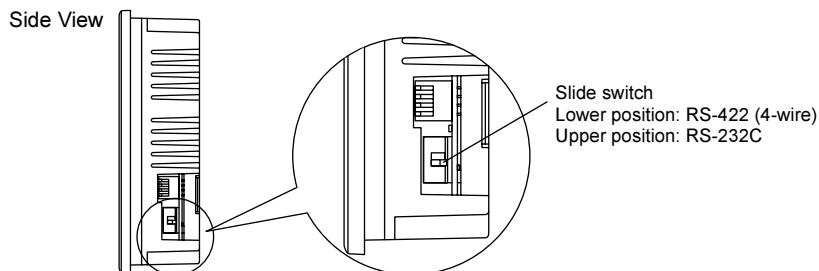

#### Wiring

For more information, refer to page 2-14.

### Unusable PLC models

The following PLC models cannot be connected to the MJ2.

Manufacturer	PLC
Mitsubishi	A Series CPU
	FX Series CPU (however, can be used with FX0N tool port)
Hitachi	HIDIC H-series RS-232C
Siemens	S7-300MPI (HMI ADP)
	S7-300MPI (PC ADP)
	S7-300MPI (Helmholz SSW7 ADP)

When connecting any of the above PLCs, be sure to mount the option unit UG230A-DCL and connect the PLC to the D-sub 25-pin connector of the unit.

### Editor (UG00S-CW) Setting

When "None" is chosen for [Option Unit] on the editor, modular jack 2 is automatically used as a PLC port.

- \* When "None" is chosen for [Option Unit] and "Not connect PLC" is chosen for [PLC Type], MJ2 becomes usable as when a type is chosen for [Option Unit].

### Combination of MJ1 and MJ2 functions

When "Not connect PLC" is chosen for [PLC Type], both MJ1 and MJ2 become usable as when a type is chosen for [Option Unit]. Page 2-13 shows usable combination of functions.

### With the Option Unit UG230A-DCL

MJ2 is used to connect a temperature controller or a barcode reader. Since MJ2 is also available as an RS-422 (4-wire) port, it differs from MJ1 in some respects.

### Slide switch

- Use the switch to set the signal level for the MJ2.

Side View

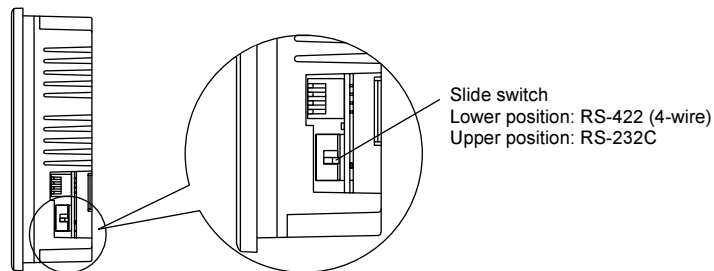

- Functions used with RS-232C  
Barcode reader, ladder tool (ladder transfer), printer (serial port)
- Functions used with RS-422  
Multi-link 2
- Functions used with either RS-232C or RS-422 depending on the devices to be connected or connecting methods  
Temperature controller/PLC2Way, UG-Link, Modbus slave communication

### Wiring

For more information, refer to page 2-16.

### Editor (UG00S-CW) Setting

- The use of modular jack 2 can be set on the editor.
- Select [Modular] from the [System Setting] menu. The [Modular Jack] dialog is displayed. Select the use of modular jack 2 from the following options.

Modular Jack 2  
 [Not Used]  
 [Barcode]  
 [Multi-Link]  
 [Temp. /PLC2Way]  
 [UG-Link]  
 [Ladder Tool]  
 [Modbus Slave]  
 [Printer (Serial Port)]

### Combination of MJ1 and MJ2 functions

○: Usable at the same time. ×: Not usable at the same time

MJ2 \ MJ1	Multi-Link 2	Card Recorder	Barcode	UG00P-U2	Temp./ PLC2Way	UG-Link	Ladder Tool	Modbus Slave	Printer (Serial Port)
Multi-Link 2	○	○	○	○	○	○	×	○	○
Barcode	○	○	○	○	○	○	○	○	○
Temp./ PLC2Way	○	○	○	○	○	○	○	○	○
UG-Link	○	○	○	○	○	○	○	×	○
Ladder Tool	×	○	○	○	○	○	○	○	○
Modbus Slave	○	○	○	○	○	×	○	○	○
Printer (Serial Port)	○	○	○	○	○	○	○	○	○



## Notes on Wiring

### Notes on the Use of MJ1/MJ2



#### CAUTION

The metal shell of the UG230 modular jack is used as SG (signal ground). Fuji's communication cable for modular jack, shielded cable, is connected to the SG inside the UG230.

### Notes on the Use of MJ2

Either the RS-232C or RS-422 port can be selected for MJ2 with the slide switch.

When the slide switch is set to RS-232C, MJ2 is connected in the same manner as MJ1.

When the slide switch is set to RS-422, extra care should be taken if connecting a device adapted to RS-485 (2-wire).

### PLC connection

There are two connecting methods.

One method uses an adaptor UG30C-J for connection between MJ2 and the D-sub 25-pin connector plus a PLC communication cable (as shown in the User's Manual <PLC Connection> (FEH380)).

The other method uses a UG00C-P cable for connection between MJ2 and a PLC interface cable.

For information on the PLC wiring diagram, refer to the separate User's Manual <PLC Connection> (FEH380).

- Connecting to an RS-232C port (example: Mitsubishi A1SJ71UC24-R2):

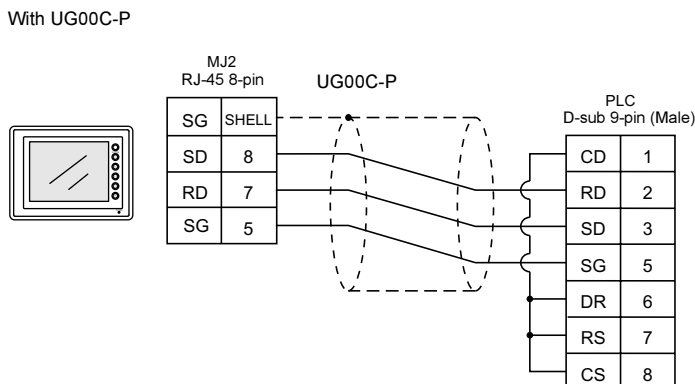
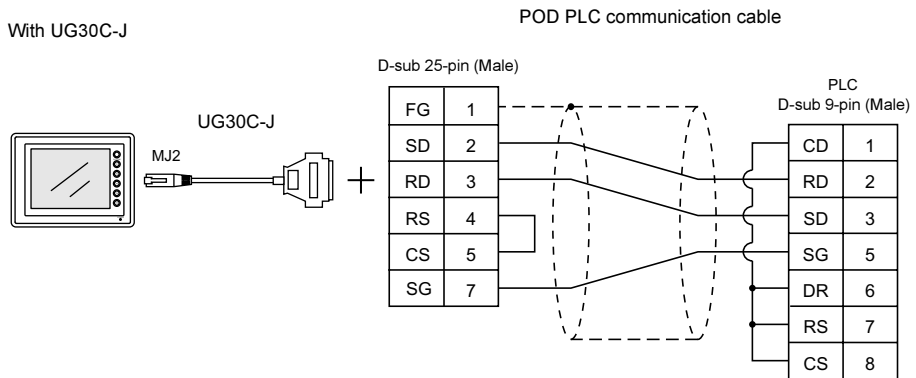

- Connecting to an RS-422 port (example: Mitsubishi QJ71C24):

POD PLC communication cable

With UG30C-J

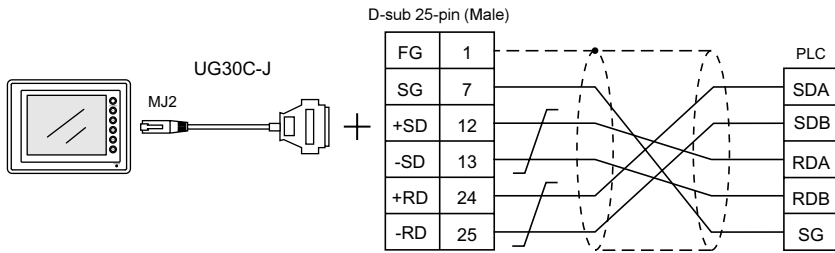

With UG00C-P

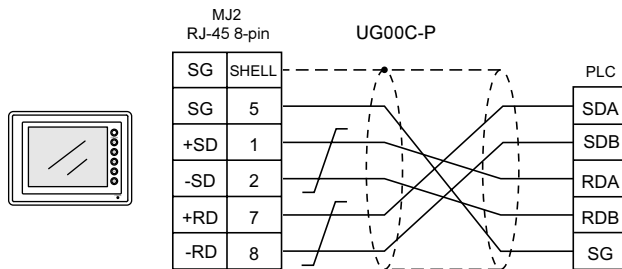

\* When connecting to a Mitsubishi QnA CPU port, a connection between MJ2 and the PLC can be established by changing the PLC-side connecting method.

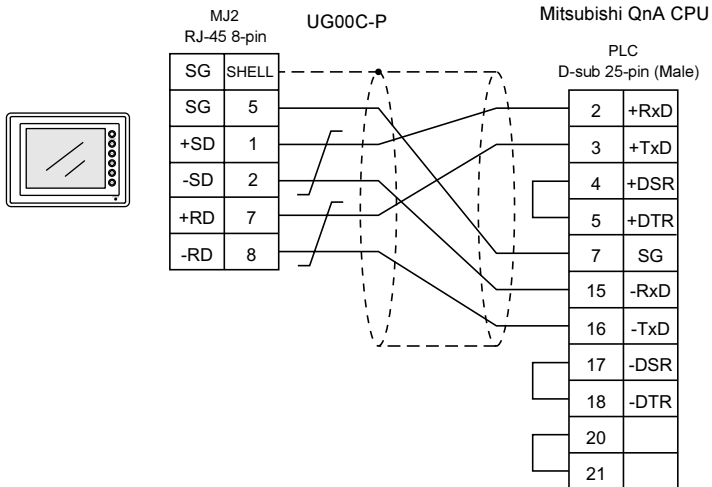

- Connecting to an RS-485 port (example: Siemens S7-300 MPI port):

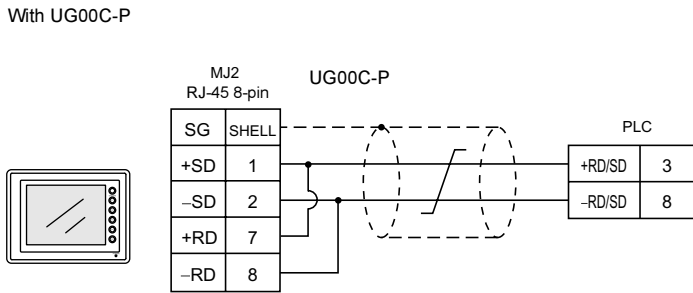
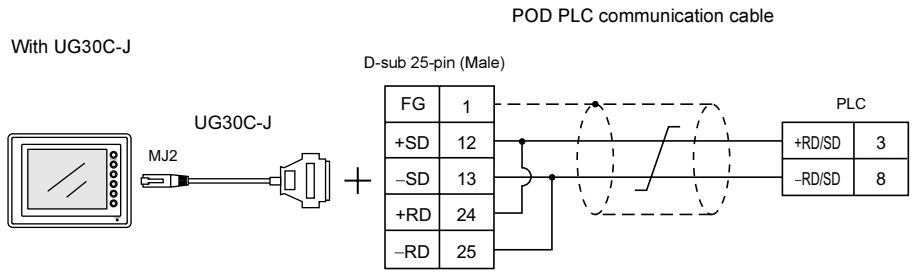

**Temperature controller/PLC2Way/UG-Link/Modbus slave communication**

For information on the wiring diagram, contact your local distributor.

## Transferring Screen Data

- Use modular jack 1 (MJ1) when transferring screen data.
- When [Editor Port] is selected for [Modular Jack 1] on the editor, it is possible to transfer data in the RUN mode because the RUN/STOP mode (on the Main Menu screen) can be automatically selected.  
Also RUN/STOP mode is automatically selected for on-line editing and simulation.
- When an option other than [Editor Port] is selected for [Modular Jack 1], select the STOP mode (on the Main Menu screen) and transfer screen data. Simulation or on-line editing is not available.
- When transferring screen data, use Fuji's data transfer cable (UG00C-T) 3 m to connect the UG230 to a personal computer.

## Barcode Reader Connection

- It is possible to receive the signal from a barcode reader by connecting the barcode reader at the modular jack (MJ1/2) of the UG230.
- To connect a barcode reader to the modular jack (MJ1/2), use Fuji's optional cable (UG00C-B).  
Length: 3 m  
with modular plug
- Notes on connection
  - In the case of barcode readers with CTS and RTS control, it may be necessary to install a jumper to RTS and CTS. Otherwise the barcode reader may not work correctly.
  - The external power supply (+5 V) is max. 150 mA.  
(Refer to page 2-10.)
- When using the barcode reader that was connected to UG400 (POD's old version), connect it to the D-sub 9-pin female connector using the UG00C-B cable as shown below.

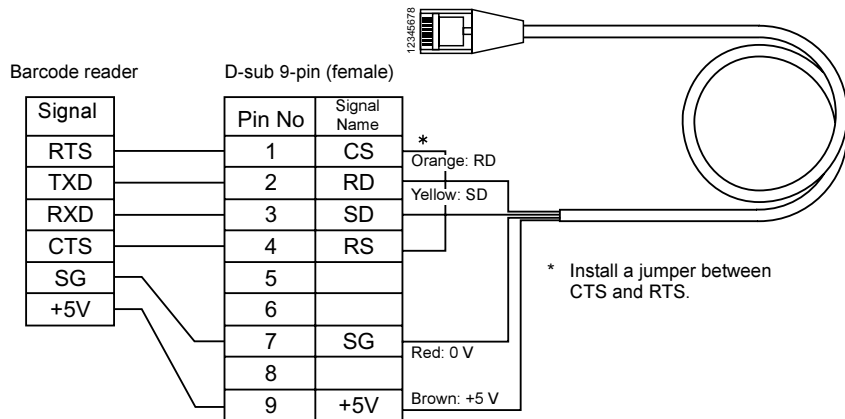
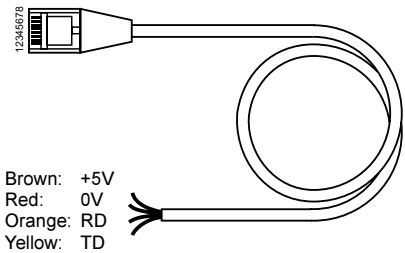

## Printer Connection (Serial Printer)

- To connect a printer through serial interface, connect the cable to a modular jack (MJ1/MJ2).
- Refer to the specification sheet of the printer to be used for the connecting cable for serial interface. For information on MJ1/MJ2 signals, refer to page 2-10.
- To connect to a printer equipped with a parallel interface, use a commercially available parallel-serial converter.  
When the serial connector of the converter is a D-sub 9-pin male connector, use Fuji's UG00C-T connection cable.

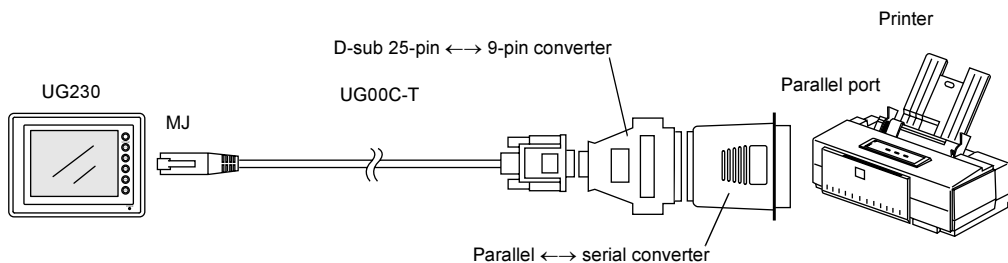

### Compatible Printer Models

Control code system:

- PR201
- ESC-P

PC-PR201 series compatible with MS-DOS computer  
ESC/P24-J84, ESC/P-J84, ESC/P super function compatible with MS-DOS computer

Others

- CBM292/293
- MR400
- EPSON STYLUS PHOTO series

CBM's line thermal printer  
(Screen hard copying is not possible.)  
Sato's barcode printer "MR400 series"  
(It is not possible to print a screen hard copy, data sheet or sampling data.)  
EPSON color ink jet printer STYLUS PHOTO series  
(For printer models, refer to the User's Manual <Supplementary Manual> (FEH376-1).)

### Screen Data Setting

From the [System Setting] menu, select [Printer Setting] and open the [Main] tab window.

- Type: (as desired)
- Port: Serial Port (MJ Port) → Go to the [Serial Port] tab window for communication setting.  
↓  
[Refer to Modular] button  
↓
- Modular Jack 1 (or 2)  
Printer (Serial Port)

Set the above options.

## 5. USB Connectors

### USB-A (Master Port)

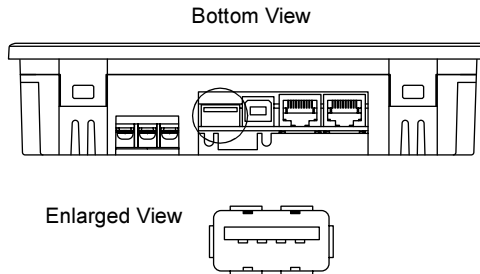

#### Available Devices

##### Printer

- EPSON color ink jet printer STYLUS PHOTO for USB port
  - \* For more information, refer to User's Manual <Supplementary Manual> (FEH376-1).
- Printer with parallel interface
  - Printer models and available print functions are the same as those for a serial printer (page 2-18).

##### CF card reader/writer

Recommended models are:

Manufacturer	Type
I-O Data Device	USB-CFRW
TDK	U2RW03CF
ELECOM	MR-UCF1SV

#### Connecting Cable

- Use the cable included with the device to be connected (printer or CF card reader/writer).

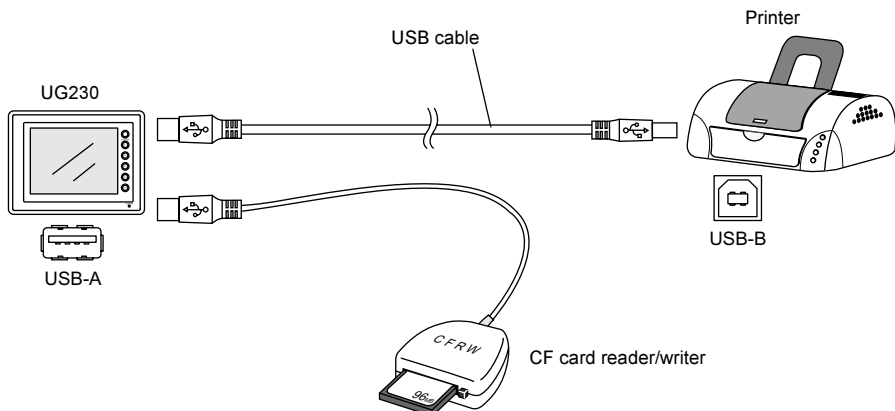

- To connect to a printer equipped with a parallel interface, use a commercially available parallel ↔ USB cable (ELECOM UC-PGT recommended).

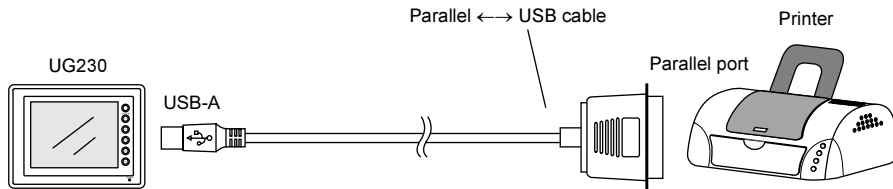

## Screen Data Setting

### For a printer

From the [System Setting] menu, select [Printer Setting] and open the [Main] tab window.

- Type: (as desired)
- Port: USB Port

### For CF card reader/writer

From the [System Setting] menu, select [Unit Setting], and open the [Option Unit] tab window.

- Use USB CF Card Reader: checked

## USB-B (Slave Port)

This is a connector for screen data transfer via USB.

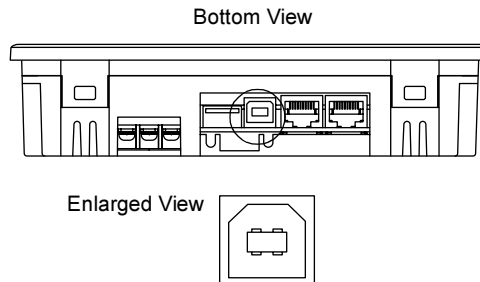

- \* When transferring screen data via the USB-B (USB slave port), be sure to install the USB driver for POD on the computer. The steps are described in the following section "Installing the USB Slave Driver."

Screen data transfer via the USB port is available with Windows 98 Second Edition and later.

### Connecting cable

Use a commercially available USB cable.

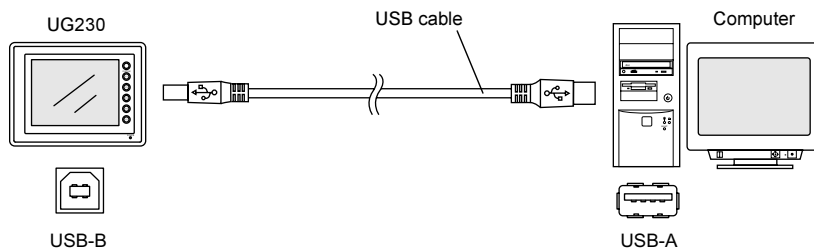

## Installing the USB Slave Driver

The installation procedure on Windows 2000 is described as an example below.

1. Connect the USB-B port of the UG230 (with power on) to the computer (with power on) using a USB cable.
2. The message "Found New Hardware" and then the driver installation wizard appear on the computer. Click the [Next] button.

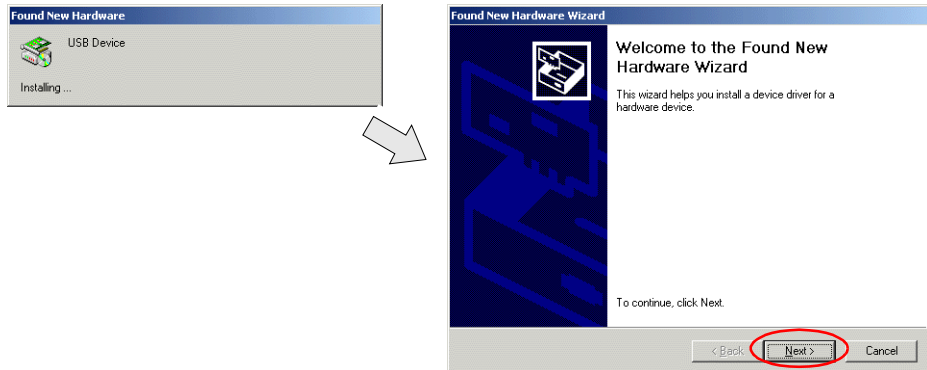

3. When the dialog box below is displayed, select [Display a list of the known drivers for this device so that I can choose a specific driver] and click the [Next] button.

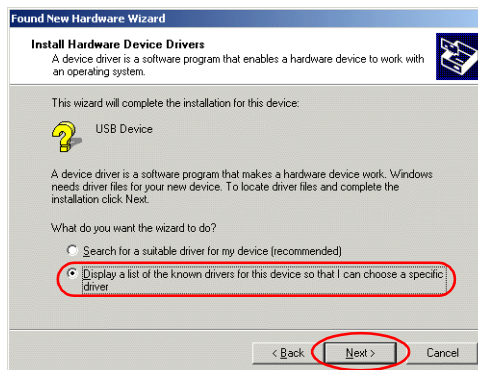

4. The dialog box below is displayed. Select [Other Devices] and click the [Next] button.

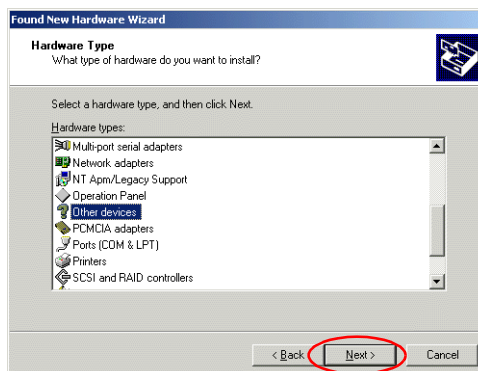



5. The dialog box below is displayed. Click [Have Disk].

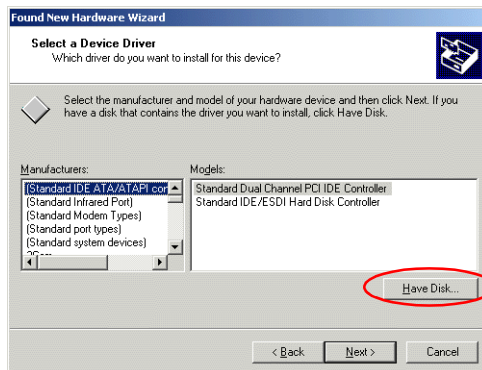

6. The [Install From Disk] dialog box is displayed. Click the [Browse] button.



7. The UG230 USB driver "OP-U.inf" is automatically stored in the "inf" folder within the UG00S-CW editor installation folder ("UGW" for example). Select the "OP-U.inf" file and click the [Open] button.

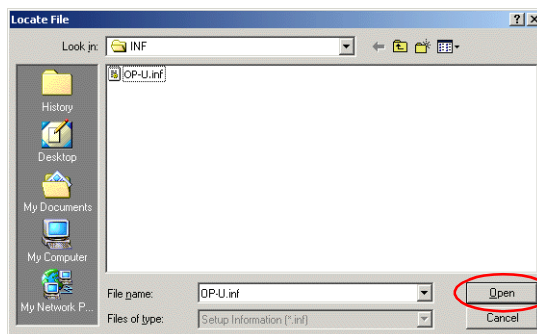

8. The previous dialog box is displayed again. Check the path shown under [Copy Manufacturer's Files From:] and click the [OK] button.

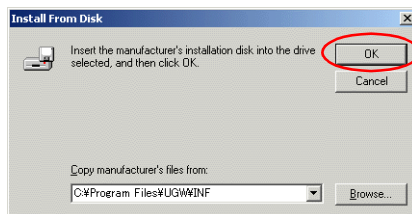

9. The dialog box below is displayed. Check that [Operation Panel USB Driver] is shown under [Models:]. Click the [Next] button.

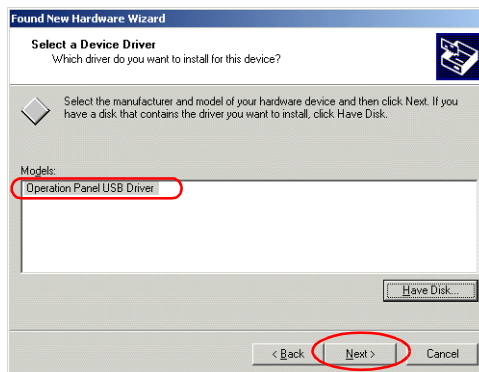

10. The driver installation starts.

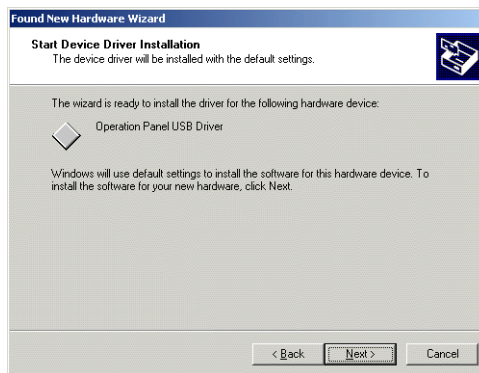

11. The dialog box below is displayed on completion of installation. Click the [Finish] button.



## Recognition of USB Driver

When the driver has been installed successfully and the UG230 and the computer are connected with a USB cable, the [Device Manager] window shows "Operation Panel - Operation Panel USB Driver."

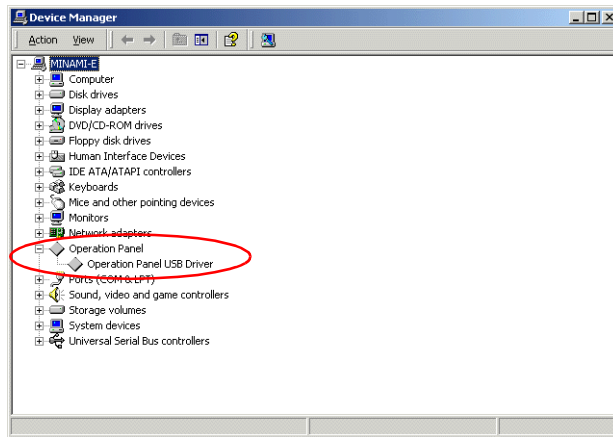

This will disappear when the UG230 and the computer are disconnected.

If [Other Device] or [?] is shown even while their connection via USB is maintained, the USB driver may not be recognized. If this happens, uninstall the USB driver once and reinstall it.

## 6. D-sub 25-Pin Connector (CN1) (Optional)

When the option unit UG230A-DCL is mounted, the CN1 connector is usable.

### Serial Connector (CN1)

To communicate with the PLC (RS-232C, RS-422/485), connect the cable to the serial connector (CN1).

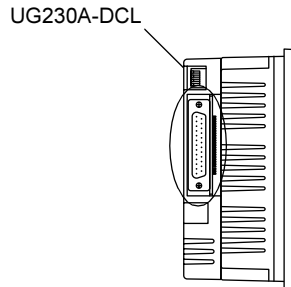

The correspondence between the serial connector pins and signals is shown below. The interface is the same as that for the UG30-series CN1.

CN1 (D-sub 25-pin, female)	Pin No.	Signal Name	Contents
	1	FG	Frame ground
	2	SD	RS-232C send data
	3	RD	RS-232C receive data
	4	RS	RS-232C RS request to send
	5	CS	RS-232C CS clear to send
	6		Not used
	7	SG	Signal ground
	8		Not used
	9	+5V	Use prohibited
	10	0V	Use prohibited
	11		Not used
	12	+SD	RS-422 send data (+)
	13	-SD	RS-422 send data (-)
	14	+RS	RS-422 RS send data (+)
	15		Not used
	16		Not used
	17	-RS	RS-422 RS send data (-)
	18	-CS	RS-422 CS receive data (-)
	19	+CS	RS-422 CS receive data (+)
	20		Not used
	21	-	Use prohibited
	22	-	Use prohibited
	23		Not used
	24	+RD	RS-422 receive data (+)
	25	-RD	RS-422 receive data (-)

The following connector is recommended.

Recommended connector	DDK-make 17JE23250-02 (D8A)	D-sub 25-pin, male, metric thread, with hood
-----------------------	-----------------------------	--

## 7. 10BASE-T (LAN) (Optional)

When the option unit UG230A-DCL is mounted, the 10BASE-T (LAN) connector is usable.

### 10BASE-T Connector

Use this connector for Ethernet connection.

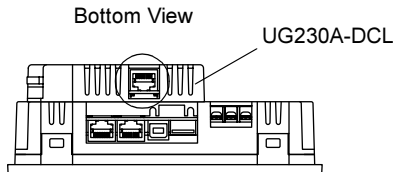

#### CAUTION

MJ1/2 and LAN connector are 8-pin modular jacks.  
Check the name plate and insert the connector in the correct position.

The LAN (10BASE-T) pins correspond to signals as given below.

LAN	Pin No.	Signal Name	Contents
<p>12345678</p>	1	TX+	Ethernet send signal (+)
	2	TX-	Ethernet send signal (-)
	3	RX+	Ethernet receive signal (+)
	4	NC	Not used
	5	NC	Not used
	6	RX-	Ethernet receive signal (-)
	7	NC	Not used
	8	NC	Not used

## Notes on Wiring



**CAUTION** When using the LAN port, keep the LAN cable away from the power supply cable as much as possible.

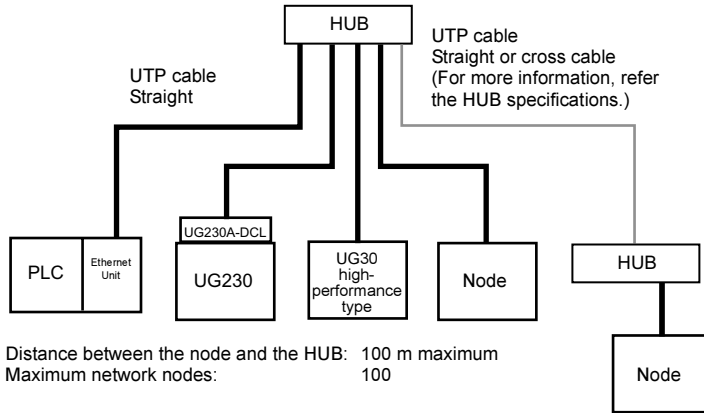

## Cable Connection Diagram

Straight  
(with HUB)

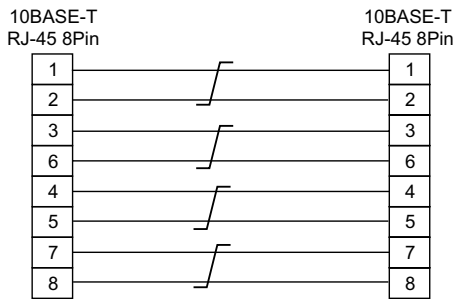

\* Unshielded twist-pair cable

Cross  
(without HUB)

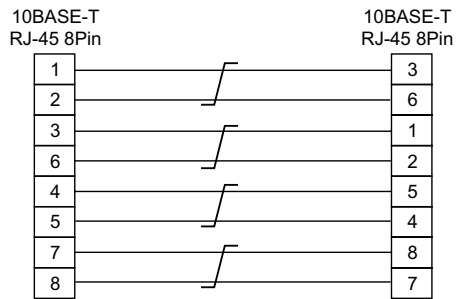

\* Unshielded twist-pair cable

## Notes on Cables

Use the following recommended cable.

Recommended cable	10BASE-T	Type: Twist-pair cable, category 5
-------------------	----------	------------------------------------

## 8. CF Card

### Recommended CF Cards

CF cards in compliance with CompactFlash™ can be used.  
The operation of the following cards has been verified by us.

Manufacturer	Type	Capacity
Kodak	KPCN-32	32 MB
	SDCFB-64-505	64 MB
SanDisk	SDCFB-xxxx-801	32 MB 64 MB 96 MB 128 MB 192 MB 256 MB 384 MB 512 MB 1 GB
	CFS-32MA	32 MB
I-O Data Device	CFS-xxM(HI)	32 MB 64 MB 128 MB 256 MB 512 MB
	CFS-iVxxx	32 MB 64 MB 128 MB 256 MB 512 MB
Hagiwara Sys-Com	HPC-CFxxZX	32 MB
Melco	RCF-XX	64 MB 128 MB 256 MB 512 MB

### CF Card Insertion Position

#### With the USB port:

The following items are recommended.

Manufacturer	Type
I-O Data Device	USB-CFRW
TDK	U2RW03CF
ELECOM	MR-UCF1SV
DAZZLE	DM-8000

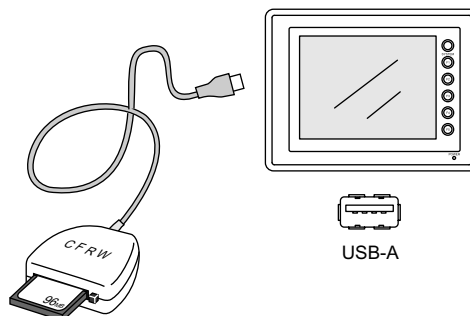

**With the option unit:**

Insert a CF card into the CF connector of the option unit UG230A-DCL.

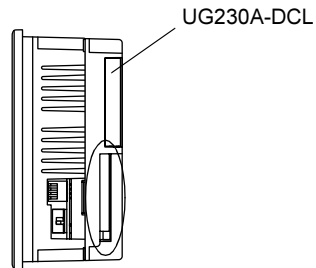

## Mounting and Dismounting the CF Card

**With the USB port:**

Follow the instructions provided in the CF card reader/writer manual.

**With the option unit:**

1. Insert the card securely into the interface with the card backside outwards viewed from the rear of the unit as shown below.

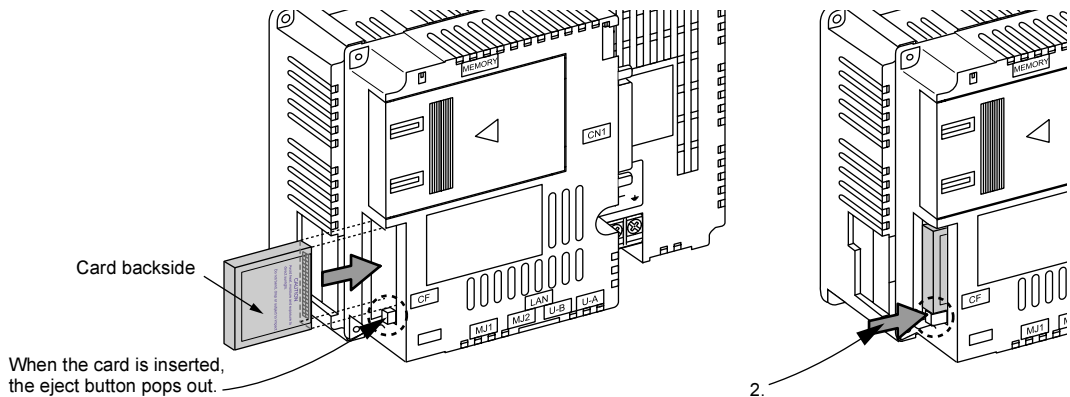

2. To remove the card, press the eject button. The card pops out.





## Notes on Handling the CF Card

---

1. POD can recognize a CF card in the FAT file system. It cannot recognize a FAT32-formatted CF card.
2. Do not insert or remove the CF card during access. Doing so may destroy data on the CF card. The CF card can be inserted or removed safely when the Main Menu screen is displayed. Before mounting or removing the CF card, be sure to check that the CF card is not being accessed. Doing so may destroy data on the CF card or cause CF card failure. However, if the [Card Menu] switch is pressed on the Main Menu screen and the CF card operation screen is displayed, it is not possible to insert or remove the CF card.
3. Do not turn the power off or on during access to the CF card.
4. Make a backup copy of the CF card at regular intervals.
5. If there should be a disk error and you cannot read/write data, you can scan the disk in Windows to restore the disk data. If not restored, initialize the CF card. Note that the data in the CF card will be completely deleted by initialization. (For more information on scanning the disk or operating Windows, refer to the Windows manual.)
6. The number of writing times per CF card is limited (approx. 300,000 times). Consequently, frequent writing at short intervals may shorten service life of the CF card. When using a CF card to save sampling data, be aware of the sampling time. Be sure to always avoid writing to a CF card with the CYCLE macro command.

# 3 Installation

---

1. Mounting Procedure
2. Power Supply Cable Connection

# 1. Mounting Procedure

## Mounting Procedure

1. Insert the UG230 into the mounting panel (max. thick: 5 mm).

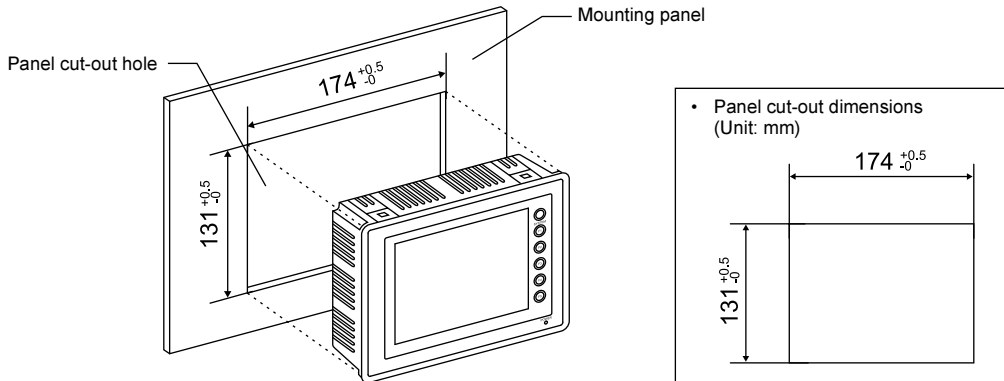

2. Insert four fixtures attached to the UG230 into the mounting holes, and tighten them with the locking screws.  
Tightening Torque: 0.3 to 0.5 N•m

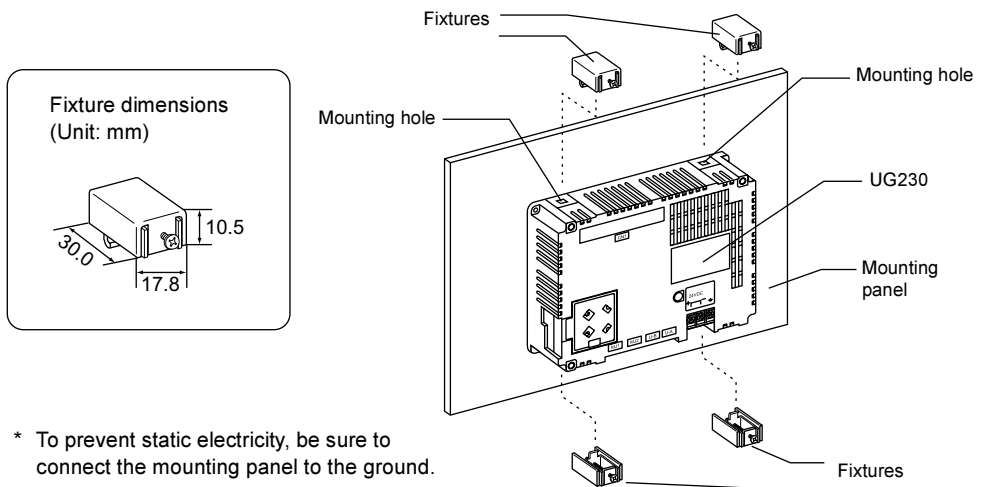

\* To prevent static electricity, be sure to connect the mounting panel to the ground.

3. Mount the gasket so that it will be sandwiched securely between the unit and the mounting panel.

## Mounting Angle

Install the unit within the angle of 0° to 135° as shown on the right.

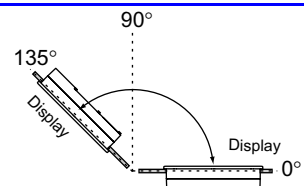

## 2. Power Supply Cable Connection



**DANGER**

Electric shock hazard  
Shut the power off before connecting the power supply cable.

### Power Supply Cable Connection

- Connect the power supply cable to the terminal on the backside of the unit.

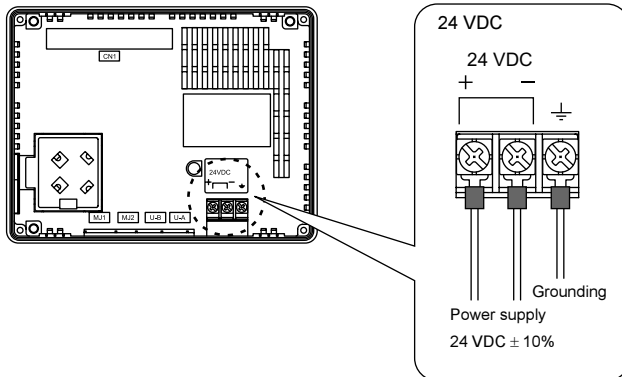

- Tighten terminal screws on the power supply terminal block with the following torque.

Terminal Screw		
Screw Size	Tightening Torque	Crimp-style Terminal (Unit: mm)
M3.5	0.5 N·m	7.1 MAX  7.1 MAX

- The power source must be within the allowable voltage fluctuation.
- Use a power source with low noise between the cables or between the ground and the cable.
- Use as thick a power supply cable as possible to minimize drop in voltage.
- Keep power supply cables away from high-voltage, large-current carrying cables.
- Be sure to attach the terminal cover to the terminal block.

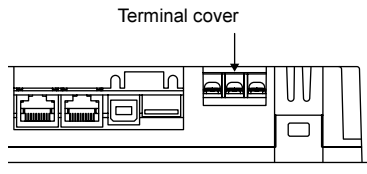

## Grounding

### CAUTION

Be sure to establish a ground of POD.  
(The level of grounding resistance should be less than  $100\ \Omega$ .)

- An independent earth pole must be used for POD.
- Use a cable which has a nominal cross section of more than  $2\ \text{mm}^2$  for grounding.
- Set the grounding point near the POD to shorten the distance of grounding cables.

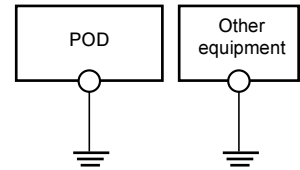

# MEMO

Please use this page freely.

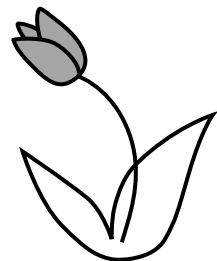

# 4 Instructions

---

1. Coin-type Lithium Battery
2. DIP Switch Setting
3. Function Switches

# 1. Coin-type Lithium Battery

## CAUTION

The POD is delivered without inserting the battery connector in the battery holder on the back of the unit.

Be sure to set the battery when using the calendar function or SRAM.  
Without battery, the contents in the SRAM or calendar will not be retained.

## Battery Mounting Procedure

## DANGER

Electric shock hazard

Steps 2 to 5 must be performed when the power to the POD is turned off.

1. Turn the unit off.
2. Slide the battery holder cover in the direction of the arrow ("→" shown below) to open it.

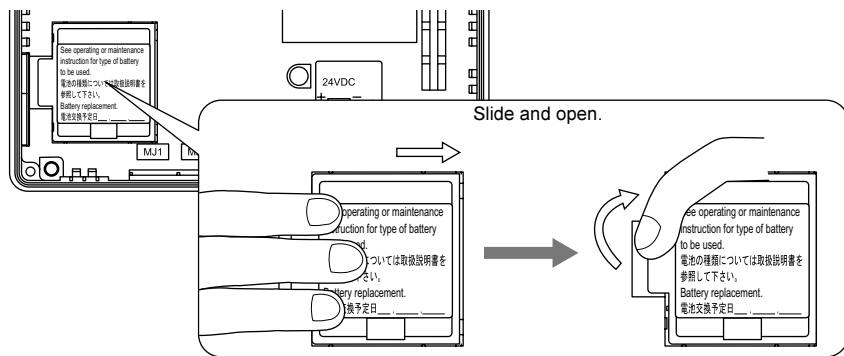

3. Check that the battery is securely attached to the backside of the cover, and connect the battery connector.

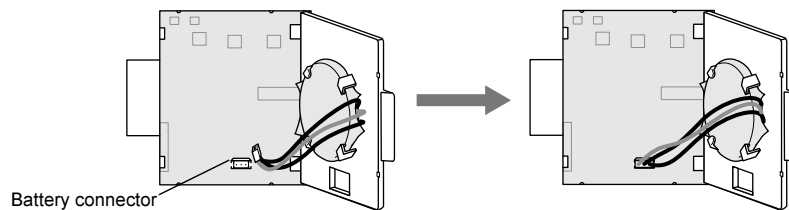

4. Close the battery holder cover. When closing the cover, slide it in the direction of the arrow ("←" shown below) to lock it.

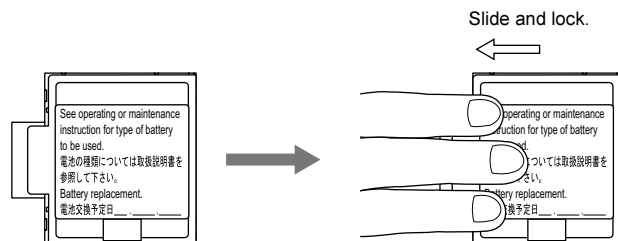



5. Enter a date five years from now for “Battery Replacement” on the sticker on the battery holder.

\* The battery status is output to the internal memory \$s167 of the UG230.  
If the battery voltage drops before five years has elapsed, replace the battery immediately.

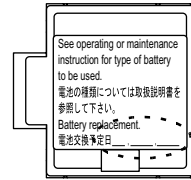

Enter a date five years from now

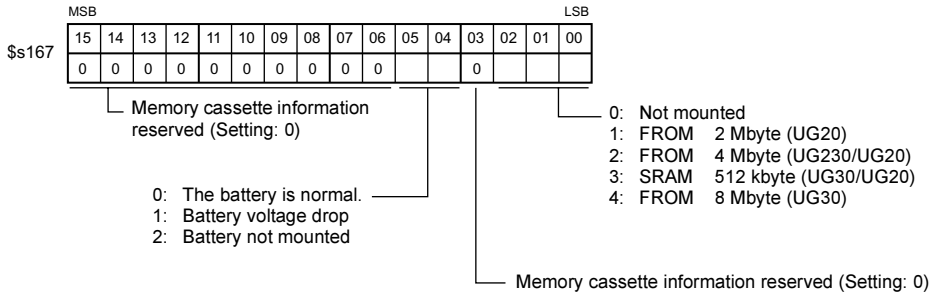

6. Turn on the power to the UG230 and check that the battery is correctly mounted on the Main Menu screen.

When the battery is not connected, the [SRAM/Clock] switch blinks and the message “Battery not set” is displayed at the bottom left corner. When the battery is correctly connected, the [SRAM/Clock] switch goes out and the message is cleared. When the battery voltage has dropped, the message “Brownout Battery” is displayed.

Main Menu screen

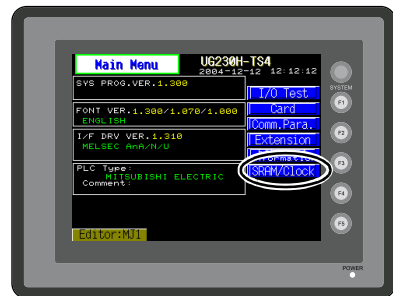

## Battery Replacement

### Safety Instructions on Handling the Battery

Lithium batteries contain combustible material such as lithium or organic solvent. Mishandling may cause heat, explosion or ignition resulting in fire or injury. To prevent accidents, pay attention to the following cautions when handling the lithium battery.

#### CAUTION

- Be sure to discharge static electricity from your body before battery replacement.
- Use the battery “UG30P-BT” (replacement battery for the UG30) for replacement.
- Rough handling of the battery may cause a fire or chemical burn hazard.
- Do not disassemble, incinerate or heat the battery.
- Observe the local and governmental regulations when disposing of waste batteries.
- Keep batteries out of reach of children (If swallowed, immediately consult a doctor.)
- Never re-charge the battery.
- When the battery leaks or smells, the leaking battery electrolyte may catch a fire. Keep from heat or flame.

## Battery Replacement Procedure

Replacement batteries are available from us.

Name	Type	Contents
Replacement battery for the UG30	UG30P-BT	<ul style="list-style-type: none"> <li>• Coin-type lithium primary cell 1 pce</li> <li>• Cautions sticker 1 pce</li> </ul>

1. Replace the battery "UG30P-BT" within three minutes after the unit is turned off. If it is not possible to replace within three minutes, use the UG00S-CW editor (cable: UG00C-T) or a CF card and make a backup copy of data in the SRAM.
  - When using the UG00S-CW editor:
    - 1) Start the UG00S-CW editor.
    - 2) Click the [Transfer] icon. The [Transfer] dialog is displayed.
    - 3) Select [Display] for [Transfer Device] and [SRAM Data] for [Transfer Data].  
To save a backup copy from the UG00S-CW editor on the server via Ethernet, check  Transfer through Ethernet/IP Address of the UG30 Equipped with SRAM]. Keep  Use Simulator] and  Read Comments in Data Transfer] unchecked.
    - 4) Click the [PC <-] under [Transfer Mode].
    - 5) Save the read data in the "\*.RAM" file.
  - When using a CF card:  
For the backup procedure with a CF card, refer to "Chapter 6 POD Operations."
2. Turn the unit off. Slide and open the battery holder. The battery in the socket will come into view.
3. Unplug the battery connector, and remove the battery from the socket. Take out the battery while pressing the center of the battery holder cover as shown in the figure.

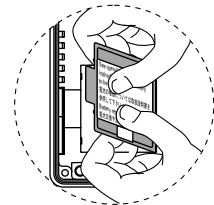

4. Set a new battery. Fit the battery into the socket in such a manner that the red cable side of the battery faces the board and the cable faces out. Insert the battery in the "a" side first, and push it down to "a" while inserted in the "b" side.
5. Plug in the battery connector and slide and lock the battery holder cover.
6. Remove the existing caution sticker. Enter a date five years from now for "Battery Replacement" on the new caution sticker, and attach it to the backside of the unit.
7. When the backup copy of the SRAM data has been saved in step 1, turn on the unit and load the data to the unit.

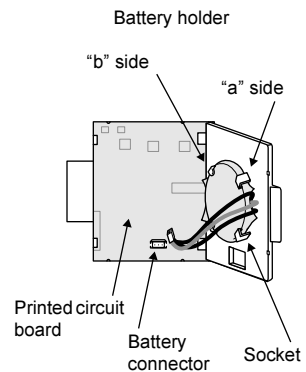

## 2. DIP Switch Setting

### DIP Switch (DIPSW) Setting

When setting the DIP switch, turn the power off.

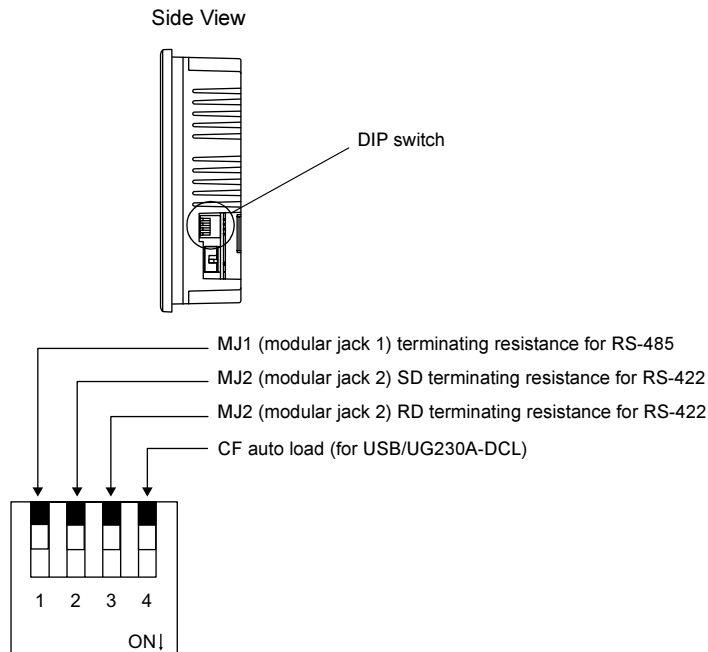

### Terminating Resistance Setting (DIPSW1, 2, 3)

Set the terminating resistance for RS-422/485 connection.

- MJ1 can be used for RS-232C or RS-485 (2-wire) connection.  
 For the following connections, set DIPSW 1 to the ON position.
  - Master station for multi-link 2 connection
  - Temperature controller network/PLC2Way connection via RS-485
  - Card Recorder: Connection with the UG00P-MR (optional)
  - Serial extension I/O: Connection with the UG00P-U2 (optional)
  - Connection to the UG230 at the termination of UG-link connection via RS-485
- MJ2 can be used for RS-232C or RS-422 (4-wire) connection.
  - For connection to the PLC through the RS-422 interface (4-wire connection) at MJ2, set DIPSW2 and 3 to the ON position.
  - For connection to the PLC through the RS-422 interface (2-wire connection) at MJ2, set DIPSW3 to the ON position.

### CF Auto Load (DIPSW4)

A screen data file saved on a CF card can be auto-loaded as described below.

1. Transfer screen data from the computer to a CF card. (Refer to the User's Manual <Function> (FEH376) for more information.)
2. Set DIPSW4 in the ON position, and insert the CF card that contains the screen data file.
3. Turn the unit on. The screen data is automatically loaded into the FLASH memory of the unit.

## 3. Function Switches

### Types

- There are six function switches provided.  
[SYSTEM], [F1], [F2], [F3], [F4], [F5]

### [SYSTEM] Switch

The [SYSTEM] switch works in “alternate” operations. When this switch is pressed once, the switch menu is displayed at the side of the function switches [F1] to [F5], and each function switch corresponds to the menu item displayed in the switch menu. When the [SYSTEM] switch is pressed again, the switch menu disappears, and the function switches [F1] to [F5] work as defined by the user (page 4-6).

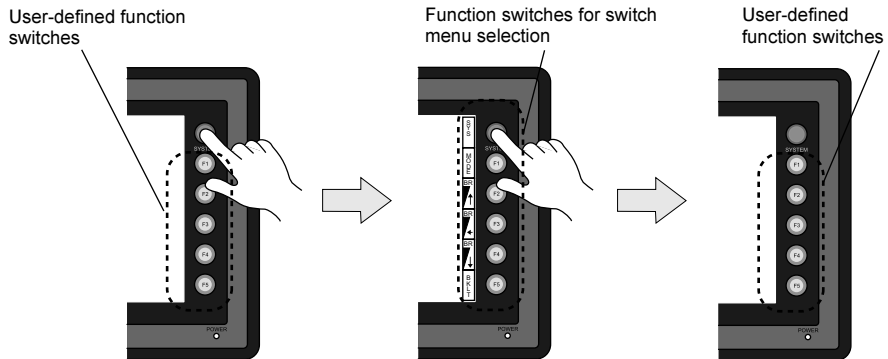

For UG230H-TS4:

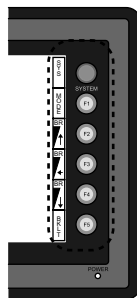

For UG230H-SS/LS:

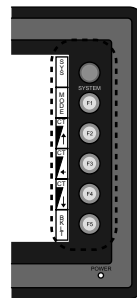

## User-defined Function Switches [F1] to [F5]

- When the UG230 is in the STOP mode, the function switches do not work.
- When the UG230 is in the RUN mode and the switch menu by the [SYSTEM] switch is not displayed, the function switches can be defined by the user.
- User-defined function switches should be set in the following dialogs of the UG00S-CW editor.
  - Settings for each screen  
[Edit] → [Local Function Switch Setting] → [Function Switch Setting] dialog
  - Setting for all screens  
[System Setting] → [Function Switch Setting] → [Function Switch Setting] dialog

## [F1] to [F5] Switch Functions with Switch Menu

Functions		Contents				
F1	Mode	Selects the operation mode between STOP ↔ RUN.				
F2 F3 F4	Contrast Brightness	Item	Contrast Adjustment		Brightness Adjustment	
			Adjust the contrast. Holding down the switch for one second or more changes the contrast rapidly.		Adjusts the screen brightness in three levels.	
		Applicable models	UG230H-SS/LS		UG230H-TS	
		Adjustment	F2          F3          F4 ←—————→ Dark      Medium      Pale		F2	F3 <sup>*1</sup>
			1 Bright	2 Medium	3 Dark	
F5	Backlight	Turn the backlight on and off. Backlight control should be set on the UG00S-CW editor. ([System Setting] → [Unit Setting] → [Unit Setting] dialog, [Backlight] tab window)				
		Always ON	Auto 1/Auto 2/Auto 3		Manual/Manual 2	
		Ignored	<ul style="list-style-type: none"> <li>• The [F5] switch turns the backlight off.</li> <li>• This is valid when the backlight control bit (bit 11) in the read area "n + 1" in the system memory is reset (OFF: 0).</li> </ul>		<ul style="list-style-type: none"> <li>• Manual The [F5] switch turns the backlight off. To turn it on, press somewhere on the screen or a function switch.</li> <li>• Manual 2 The [F5] switch turns the backlight on and off.</li> <li>• [Backlight Power ON Time Control] that determines the backlight status at power-up becomes valid. When the power is turned on: ON → Backlight ON OFF → Backlight OFF</li> </ul>	

\*1 When a medium or dark brightness is set, the backlight service life may become shorter.

# 5 Connections

---

1. 1 : 1 Connection
2. 1 : n Connection (Multi-drop)
3. n : 1 Connection (Multi-link 2)
4. n : 1 Connection (Multi-link)
5. Universal Serial Communications
6. UG-Link
7. PLC2Way
8. Temperature Control Network
9. Ethernet

# 1. 1 : 1 Connection

- One set of the UG230 is connected to one PLC (1 : 1 connection).

[UG230 only]

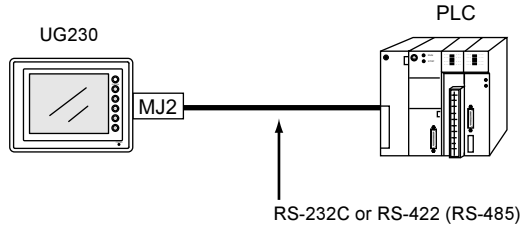

[UG230 + UG230A-DCL]

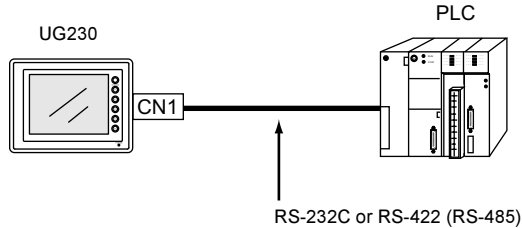

- The host link unit of the PLC or the CPU port is used and the UG230 (master station) establishes communications according to the protocol of the PLC. Consequently, it is not necessary to have the dedicated communication program on the PLC (slave station). The UG230 reads the PLC memory for screen display. It is also possible to write switch data or numerical data entered through the keypad directly to the PLC memory.

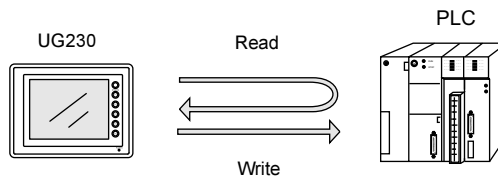

- For more information on wiring and communication settings, refer to the User's Manual <PLC Connection> (FEH380).

## 2. 1 : n Connection (Multi-drop)

One UG230 is connected to multiple PLCs. (Maximum connectable PLCs: 32)

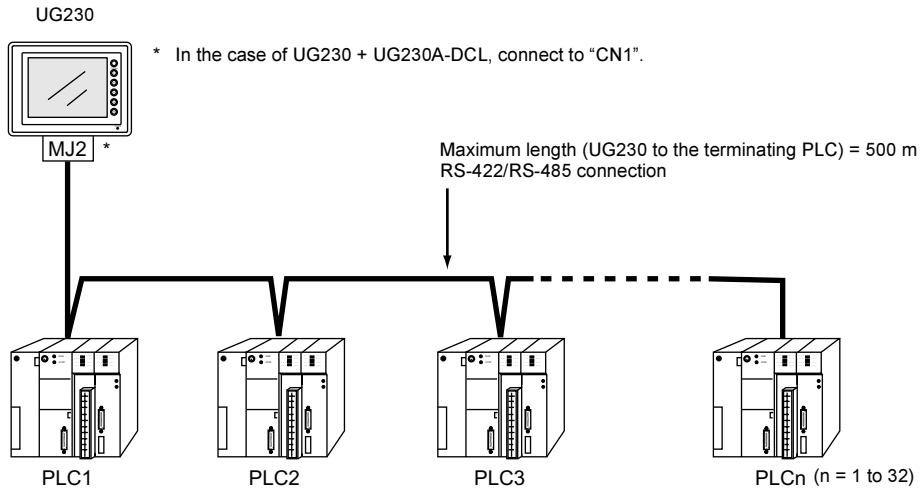

- For more information on wiring and communication settings, refer to the User's Manual <PLC Connection> (FEH380).



### 3. n : 1 Connection (Multi-link 2)

- One PLC is connected to a maximum of four UG230 units.
- An original network is created where the UG230 (Local Port 1) that is directly connected to the PLC is the master station, and other three UG230 are slave stations. Only the master station makes communications directly with the PLC, and the slave stations make communications with the PLC via the master station.

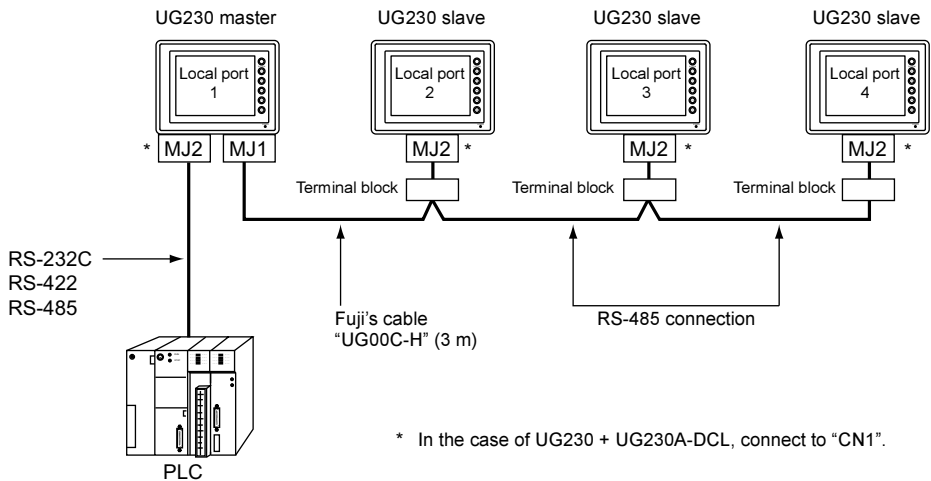

- Communications between the UG230 master station and the PLC depend on the communication speed set on the PLC. The maximum available speed for the UG230 is 115 kbps, which is higher than the one available with multi-link connection described in "4. n : 1 Connection (Multi-link)."
- This multi-link connection is available with almost all the PLC models that support 1 : 1 connection. (The connection between the master station and the PLC is the same as the one for 1 : 1 connection.)
- Use the RS-485 2-wire connection between stations of the UG230. Please use Fuji's multi-link 2 master cable (UG00C-H) for connection between the master station (local port 1) and the slave station (local port 2).
- The UG230, UG30 series and UG20 series can be used together. The UG20 series can be the master station. (However, when UG220/UG221 is the master station, the slave station must be UG220/UG221. Also, depending on the hardware version of the UG20 series, multi-link 2 connection may not be supported. Refer to the User's Manual <UG20 series Hardware> (FEH352).
- For more information on wiring and communication settings, refer to the User's Manual <PLC Connection> (FEH380).

## 4. n : 1 Connection (Multi-link)

- One PLC is connected to multiple UG230 units. (Maximum connectable units: 32)

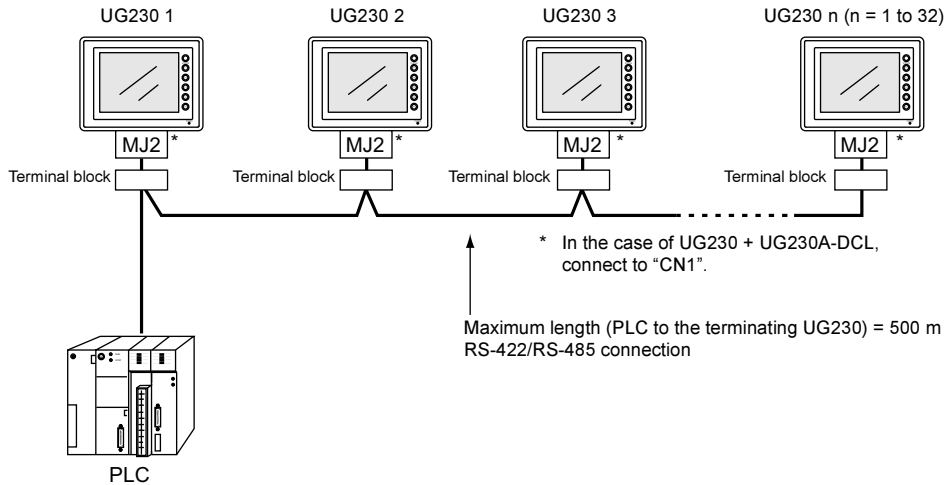

- The PLC must be of the type of signal level RS422/RS485 with port numbers. RS422 connection between the UG230 ↔ PLC must be in 2-wire connection.
- The UG230, UG30 series and UG20 series can be used together.
- For more information on wiring and communication settings, refer to the User's Manual <PLC Connection> (FEH380).

## 5. Universal Serial Communications

- A general purpose computer or an ASCII unit of the PLC (master station) controls the POD (slave station) using dedicated commands.

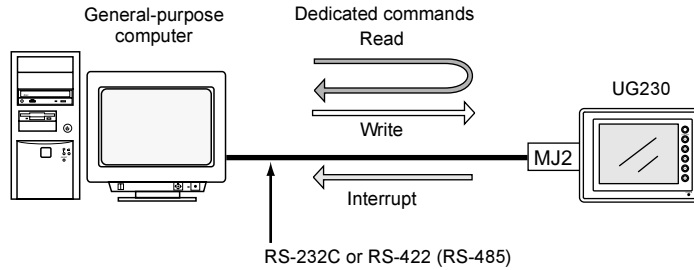

- The UG230 internal user memory addresses (\$u) must be used for memory allocation for switch, lamp or data display parts. When the master station specifies a screen number, data is written to the internal memory address (\$u) allocated for the screen. If the screen is switched internally, the new screen number is read and is written to the internal memory address (\$u) allocated for the screen.
- For 1 : 1 connection, the UG230 can send an interrupt to the master station through switch activation, write command from the keypad, and screen change.
- Use MJ2 (or CN1 when the UG230A-DCL is provided) of the UG230 for connection with a general-purpose computer. Either signal level RS-232C or RS-422 (RS-485) can be selected.
- In addition to 1 : 1 connection, 1 : n connection is available between the general-purpose computer and the UG230 via RS-422. (A maximum of 32 UG230 units can be connected.) For 1 : n connection, interrupts cannot be used.

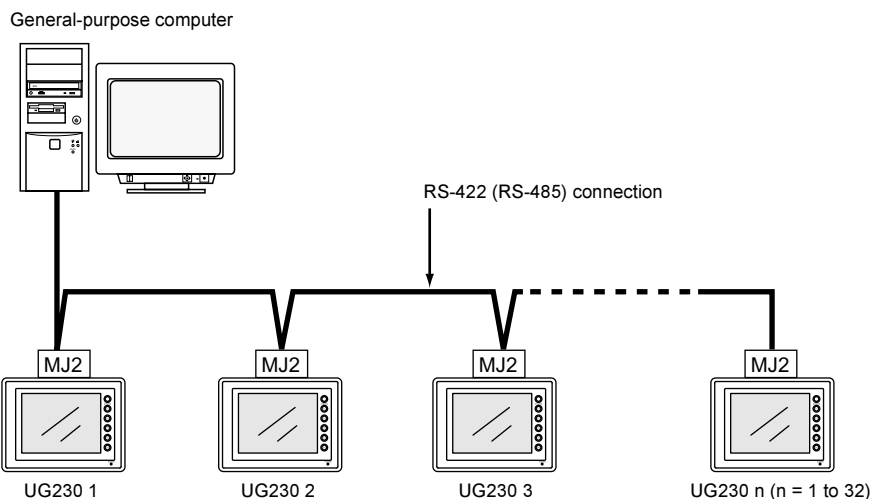

- For more information, refer to the User's Manual <PLC Connection> (FEH380).

## 6. UG-Link

- "UG-Link" is the network where the computer reads from and writes to the internal memory of the UG230, memory card, PLC memory or temperature control/PLC2 memory using a dedicated protocol.

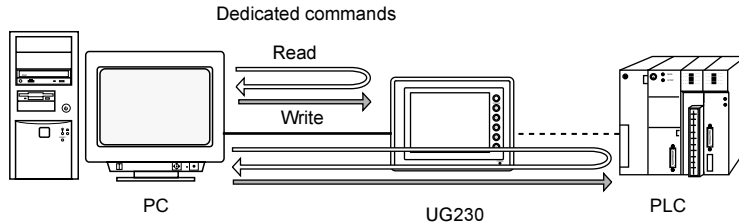

- Use MJ1 of the UG230 for connection with a general-purpose computer. Use MJ2 for communications with the PLC.  
When the option unit UG230A-DCL is installed, it is possible to use CN1 for communications with the PLC, MJ2 for connection to the PLC using the temperature controller or PLC2Way, and MJ2 for communications with a computer. Data of the PLC or temperature controller can be collected through communications with the UG230. Data collection is available even between the products of different manufacturers.
- Either signal level RS-232C or RS-485 can be selected.  
With RS-232C, one UG230 unit can be connected; with RS-485, a maximum of 31 UG230 units can be connected.

<RS-485 connection>

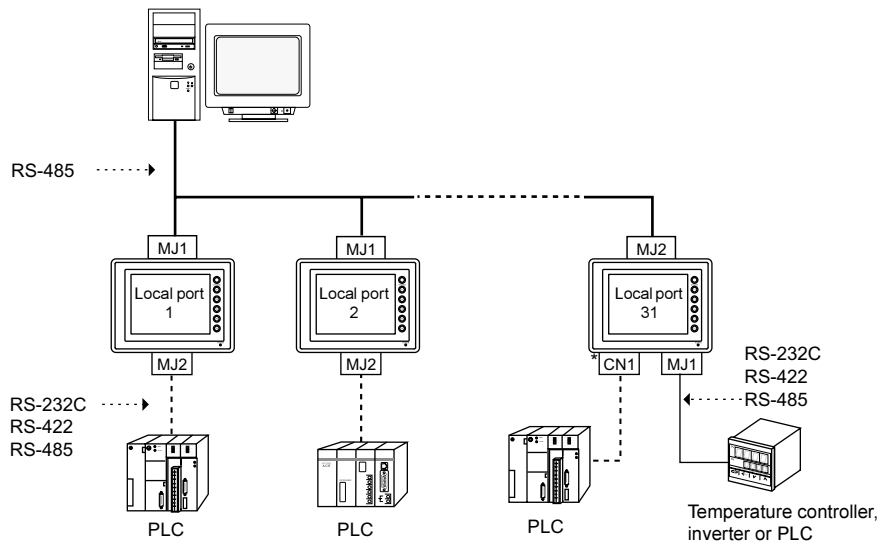

\* [UG230 + UG230A-DCL]

- For more information, refer to the User's Manual <PLC Connection> (FEH380).

## 7. PLC2Way

- The "PLC2Way" function is an original network function where one UG230 can be connected to two PLCs. Even if the manufacturers of these PLCs are not the same, they can be connected to one UG230.

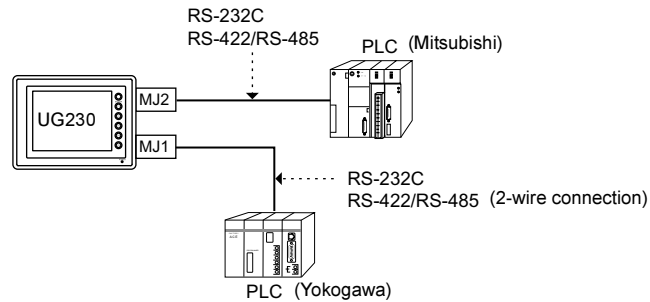

- Connect the first PLC to MJ2 (or CN1 when the UG230A-DCL is provided), and the second PLC (PLC2Way) to MJ1.
- With the PLC2Way function, it is possible to communicate with PLCs without special program in the same way as 1 : 1 connection.  
Two PLCs that are connected to the UG230 are controlled at the same time, and memory read/write operations are available with these two PLCs.
- Connection at MJ1 (PLC2Way) can be performed via RS-232C or RS-485 (2-wire).  
With RS-232C, one PLC can be connected; with RS-485, a maximum of 31 PLCs can be connected.

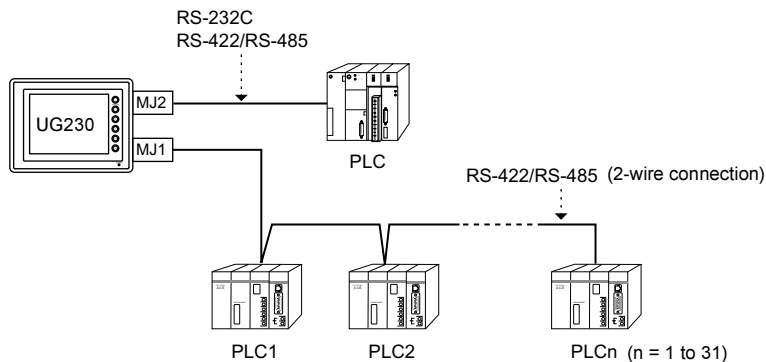

- Periodical reading/sampling of PLC data on the PLC2Way side  
When read/write memory addresses are preset on the temperature control network/PLC2Way table, background data reading is performed at regular intervals. It is also possible to save the read data in the UG230 internal buffer, SRAM or CF card.
- Data transfer between PLCs  
The PLC memory data can be transferred to another PLC in blocks using a macro command.
- For more information, refer to the User's Manual <PLC Connection> (FEH380).

## 8. Temperature Control Network

- Using the temperature control network, the UG230 can be connected to the temperature controller or inverter.  
With RS-232C, one PLC can be connected; with RS-485, a maximum of 31 temperature controllers can be connected.

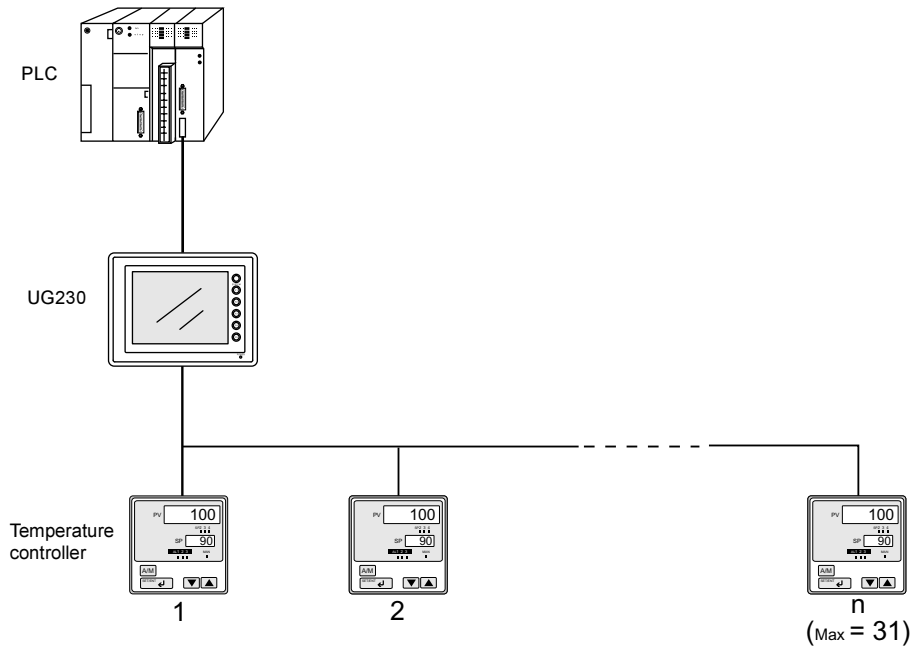

- Data of temperature controllers connected to the UG230 can be set or monitored.
- Periodical reading/sampling of temperature controller data  
When read/write memory addresses are preset on the temperature control network/PLC2Way table, background data reading is performed at regular intervals. It is also possible to save the read data in the UG230 internal buffer, SRAM or CF card.
- Data transfer  
It is also possible to transfer data in the PLC memory, UG230 internal memory or a memory card to the temperature controller at one time using a macro command. Conversely, data in the temperature controller can be transferred to the PLC memory, UG230 internal memory or a memory card at one time.
- For more information, refer to the User's Manual <Temperature Control Network> (FEH365).

## 9. Ethernet



To perform Ethernet communications on the UG230, the option unit UG230A-DCL must be installed.

- Transferring data in memory  
Data in memory can be transferred to the UG230 on the Ethernet or to the PLCs linked to the UG230 as a host by using macro commands (EREAD/EWRITE).

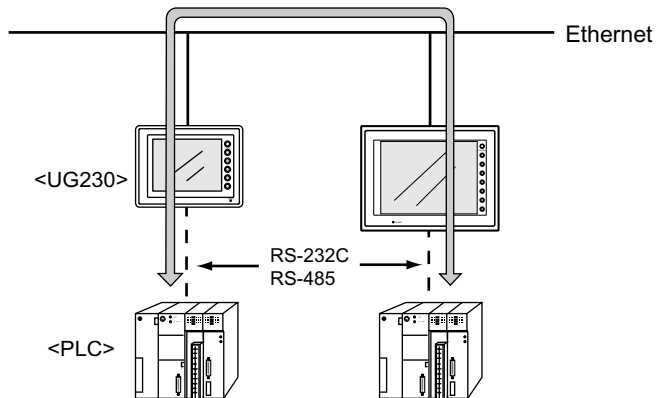

- Communications between the server and the UG230
  - "HKEtn10.dll" (for UDP/IP protocol) is provided so that the user can create an original application by using Visual C++ or Visual Basic, etc. to allow the server to access the memory device, such as UG230 internal memory, memory card or the PLC memory linked with the UG230 as a host..... (a)
  - The macro command (SEND) enables the UG230 to access the server..... (b)

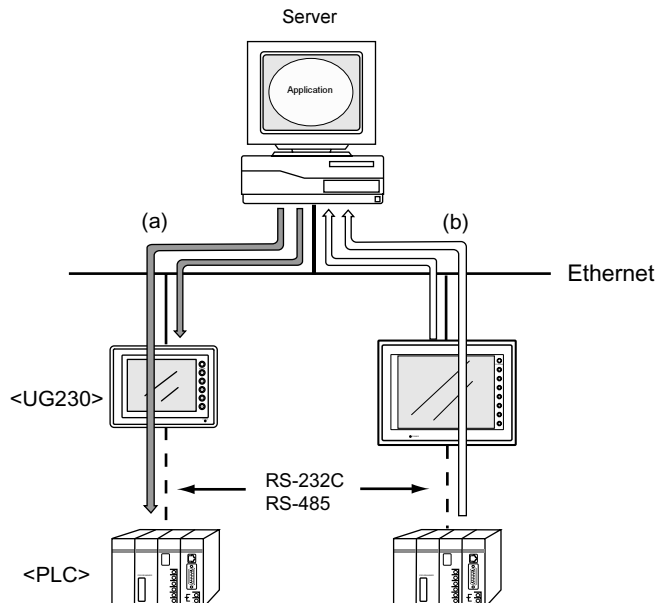

- Screen data can be transferred from the UG00S-CW editor on the server to the UG230.

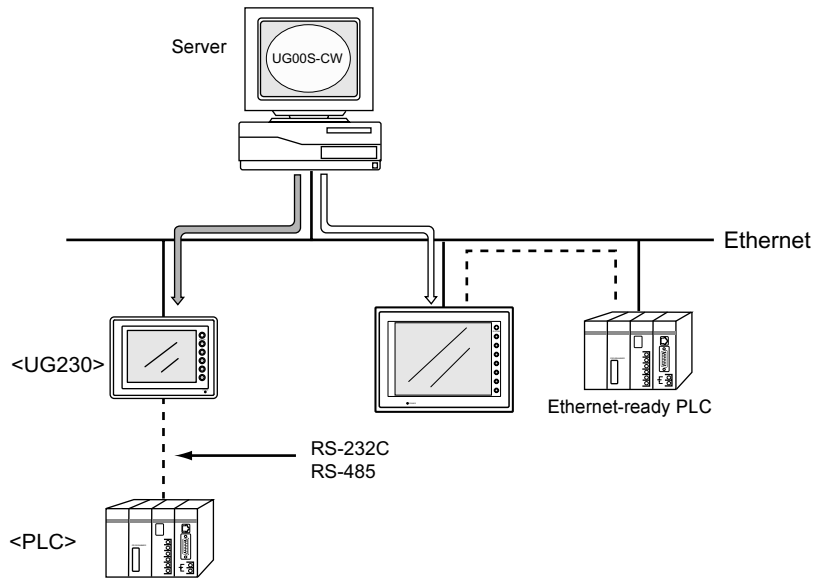

- Communications between the Ethernet-ready PLC and the UG230
  - The UG230 can communicate with the PLC on the Ethernet.

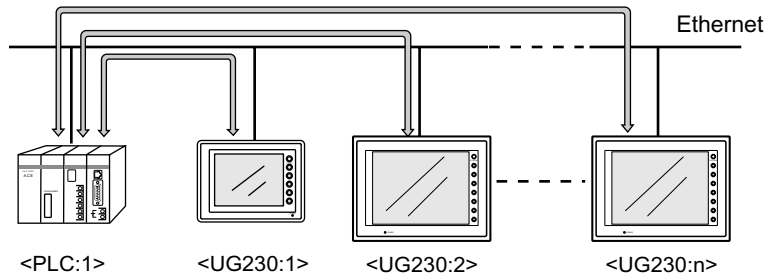

\* Ethernet-ready PLC only

- The UG230 can communicate with multiple PLCs on the Ethernet.

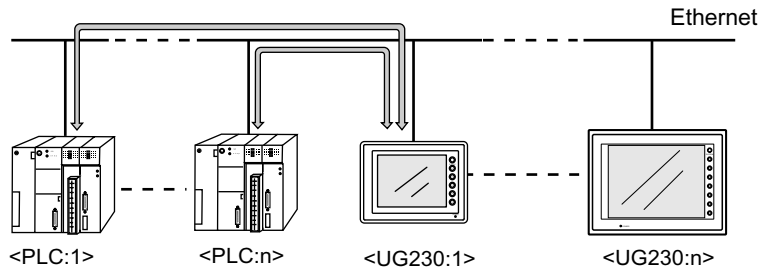

\* Ethernet-ready PLC only

- For more information, refer to the User's Manual <PLC Connection> (FEH380).



# 6 POD Operations

---

1. Operational Procedures
2. Main Menu Screen

# 1. Operational Procedures

## POD Operation

Follow the procedure below to operate the POD.

1. Installation and wiring  
For details, refer to Chapter 3.
2. Connection with devices including a PLC and a temperature controller  
For instructions and precautions on wiring between the POD and other devices, refer to the separate User's Manual <PLC Connection> (FEH380).
3. POD power-on
  - New POD

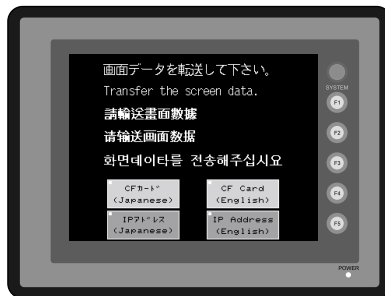

- Other than the above  
When the check screen below and then the next user screen are displayed correctly, go to step 5.

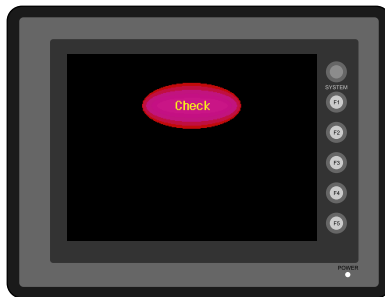

4. Screen data creation and transfer
  - New POD  
Refer to "Initial Screen" (page 6-2).
  - Other than the above  
Refer to Chapter 5, "Data Transference" in User's Manual <Operation> (FEH375).
5. Operation start  
The POD becomes operable with a PLC or a computer connected to it.
  - \* If the POD does not operate normally and shows an error message, eliminate the cause by referring to Chapter 7.

## Initial Screen

When the power of POD is turned on for the first time, the Main Menu screen shown below on the left is displayed.

Initial screen displayed when power is turned on for the first time



Main Menu screen after transferring screen data

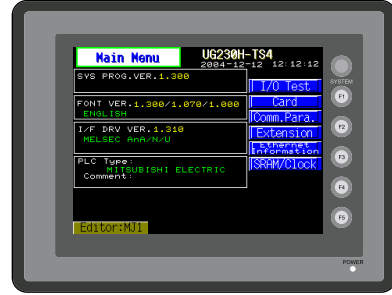

## Transferring Screen Data for the First Time

There are some methods for transferring screen data for the first time.

- UG230 only
  1. Transferring screen data via the UG00C-T or USB cable  
Transfer screen data from the computer while the initial screen is displayed.
  2. Transfer screen data from a CF card (USB CF card reader/writer) or a memory card (UG00P-MR).
    - 1) Transfer screen data from the computer to the desired card.
    - 2) Connect a USB CF card reader/writer or a UG00P-MR to the UG230, and insert the card.
    - 3) Press the [CF Card (English)] switch. The "Card Menu" screen is displayed.
    - 4) Follow the instructions as described in "Card Menu Screen" (page 6-15) and transfer screen data.



- UG230 + UG230A-DCL (option unit)

1. Transferring screen data via the UG00C-T or USB cable  
Transfer screen data from the computer while the initial screen is displayed.

2. Transfer screen data from a CF card.

- 1) Transfer screen data from the computer to a CF card.
- 2) Insert the CF card into the option unit.
- 3) Press the [CF Card (English)] switch. The “Card Menu” screen is displayed.
- 4) Follow the instructions as described in “Card Menu Screen” (page 6-15) and transfer screen data.



3. Transferring screen data via Ethernet

- 1) Press the [IP Address (English)] switch.
- 2) The “Ethernet” screen is displayed.  
Follow the instructions as described in “Ethernet (Optional)” (page 6-29) and set the IP address.  
Press the [Setting Finished] switch. The initial screen is displayed again.
- 3) Transfer screen data from the computer via Ethernet.

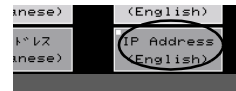

- Auto-uploading screen data from the CF card to the UG230

- 1) Transfer screen data from the computer to a CF card.
- 2) Turn the UG230 off. Set the DIPSW1 on the UG230 to the ON position, and insert the CF card into the USB CF card reader/writer or the option unit.
- 3) Turn the UG230 on. The screen data is automatically uploaded from the CF card to the UG230.

## 2. Main Menu Screen

The Main Menu screen is displayed when the POD is in the STOP mode. In this state, the POD is disconnected from the PLC and other external devices.

### Displaying the Main Menu Screen

#### In the RUN Mode

To bring up the Main Menu screen in the RUN mode, press the [SYSTEM] switch and then the [F1] switch while the vertical menu is displayed.

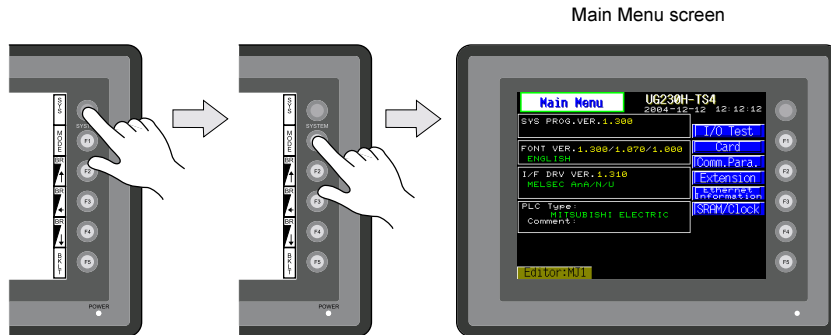

#### When the [SYSTEM] switch is disabled:

Pressing the [SYSTEM] switch does not bring up the vertical menu.

In this case, press the [SYSTEM] and [F5] switches at the same time. (If the time for simultaneous pressing of these switches is preset, hold down the switches for the required time.)

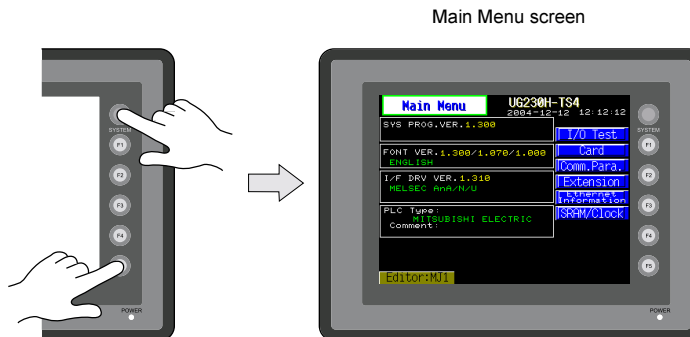

#### When the [MODE] (F1) switch is disabled:

When the vertical menu is displayed by the [SYSTEM] switch, the [MODE] (F1) switch does not work.

In this case, press the [MODE] (F1) and [F5] switches at the same time. (If the time for simultaneous pressing of these switches is preset, hold down the switches for the required time.)

### Moving Back to the Screen in the RUN Mode

Press the [SYSTEM] switch and the [F1] switch.

## Main Menu Screen

- The Main Menu screen indicates the UG230 model, system information, and screen data information.
- The Main Menu screen is the system menu screen for transferring screen data between a personal computer and the UG230.

When transferring screen data from a personal computer to the UG230, this Main Menu screen must be displayed. (However, if [Editor Port] is selected for [Modular Jack 1] or on-line editing is used, it is not necessary to bring up this screen.)

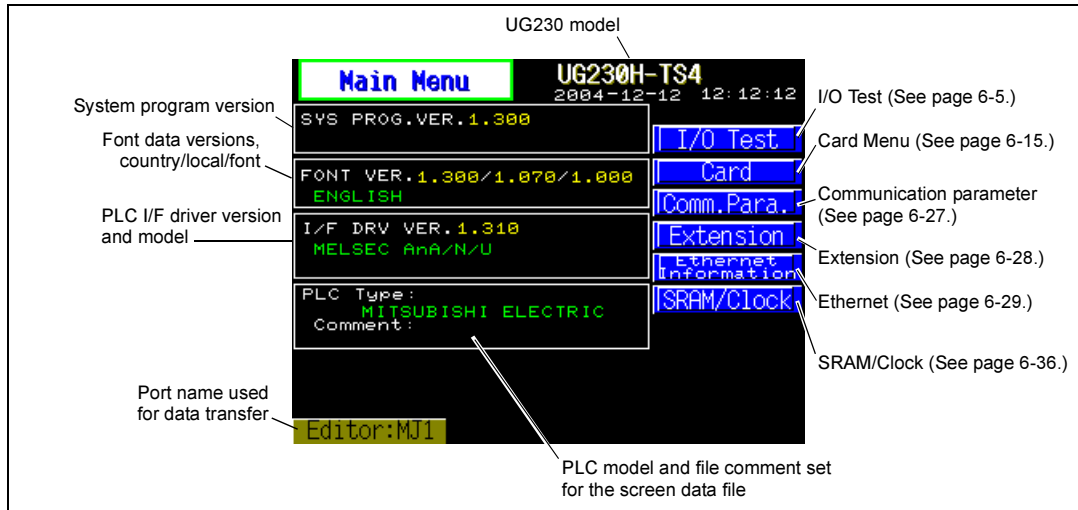

### 1. I/O Test

When the [I/O Test] switch on the Main Menu screen is pressed, the following "I/O Test" screen appears. This screen is used to check that there is no problem with the UG230 interfaces and touch switch operation.

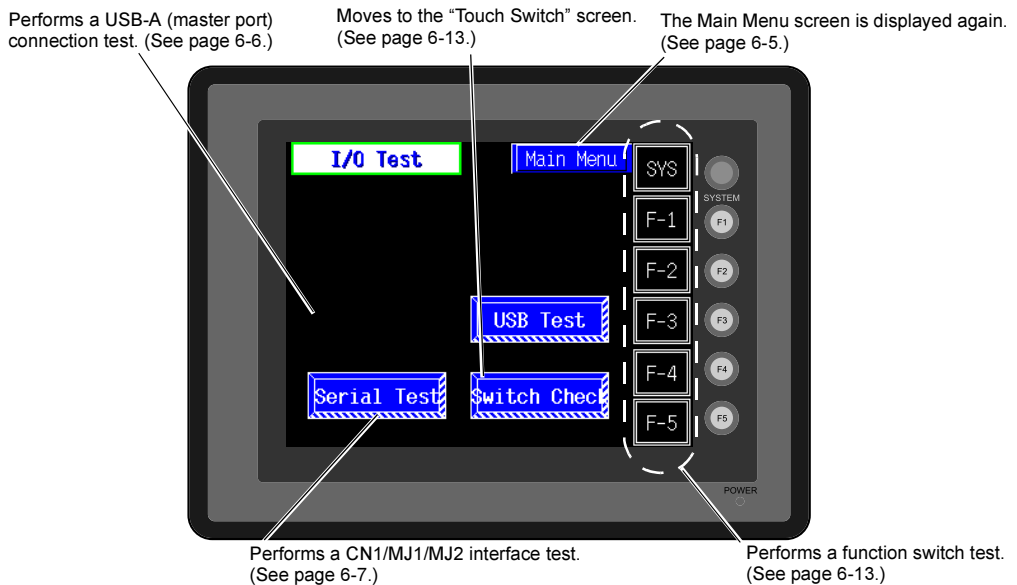

## 1-1. USB Test

When the [USB Test] switch is pressed, the following screen is displayed.

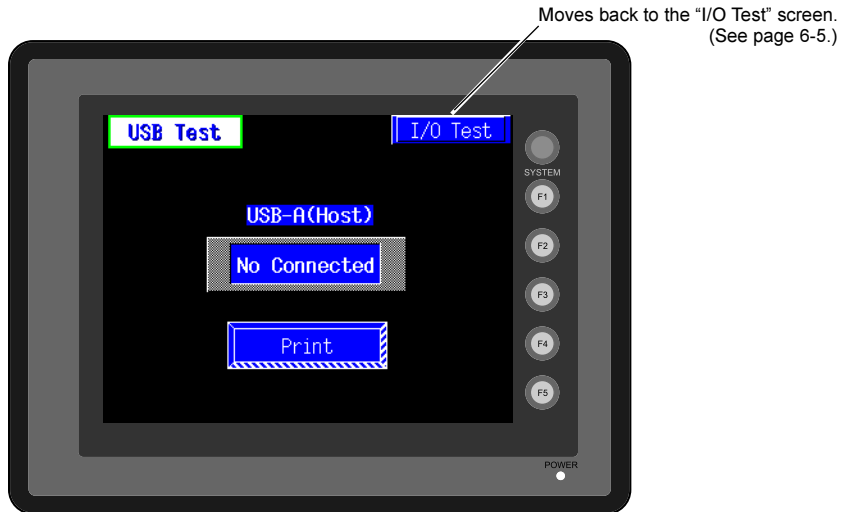

This screen is used to check the status of USB-A (master port) connection.

### Checking the Connection Status

If the lamp on the screen shows [No Connected] in blue, the device has not been connected to the USB port correctly.

When the lamp shows [Connected] in red, the device is connected to the USB port correctly.

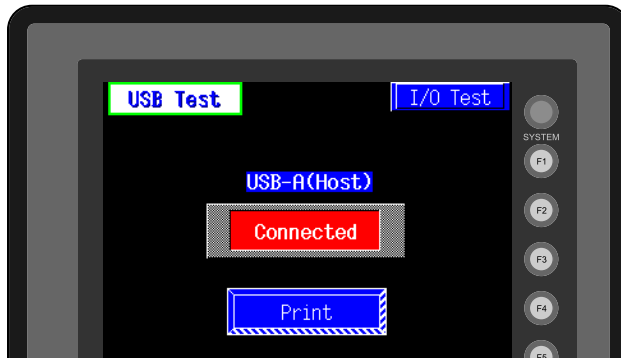

### Printer Test

When a printer is connected to the USB-A port, a print test can be done. Check if the UG230 sends signals normally to the printer using the [Print] switch. The test is successful if a test page is printed without problems.

Example:

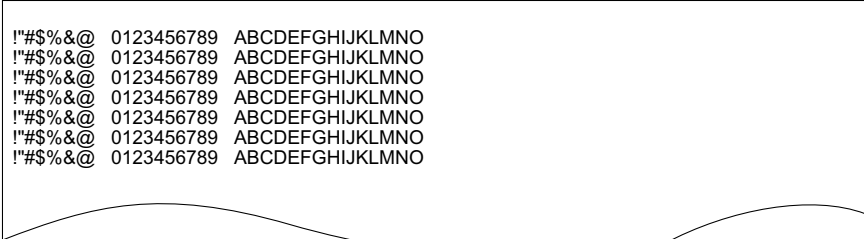

### 1-2. Serial Connection Test

When the [Serial Test] switch is pressed, the following screen is displayed.

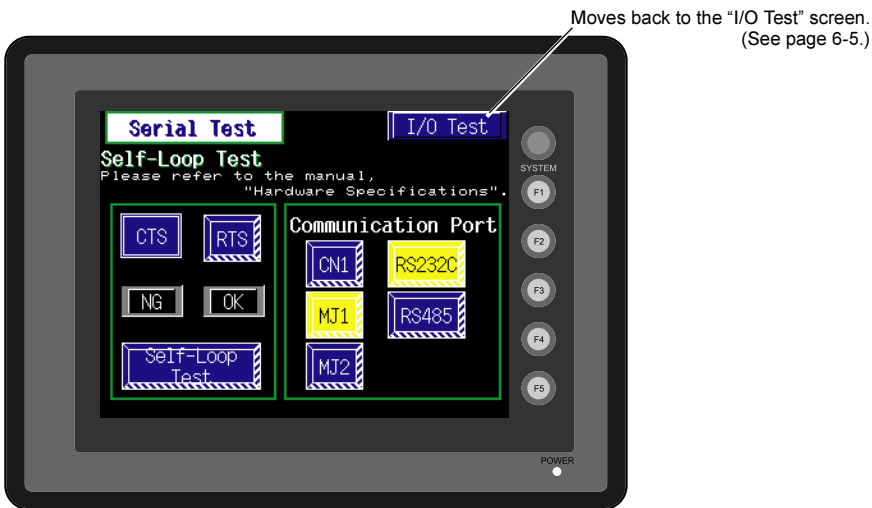

This is a signal test for communications through the MJ1, MJ2 or CN1 connector. Perform this test if the communication is not successful when transferring screen data through MJ1, connecting the PLC using MJ2 or CN1, or selecting multi-link 2, temperature controller/PLC2Way or PLC for MJ1, or connecting the card recorder or serial extension I/O.



## MJ2 Test

### RS-232C signal test

1. Slide the slide switch on the POD to the upper position for RS-232C.
2. Turn on the [MJ2] and [RS232C] switches under [Communication Port].

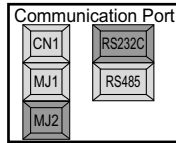

3. Check the signals [RD] and [SD]. Wire inside MJ2 as shown below.

MJ2

Signal Name	Pin No.
RD	7
SD	8

4. Press the [Self-Loop Test] switch. When the [OK] lamp lights up, the test is successfully completed.

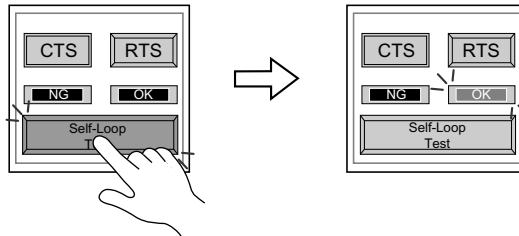

\* If the [NG] lamp lights up, consult your local distributor.

### RS-422 signal test

1. Slide the slide switch on the POD to the lower position for RS-422.
2. Turn on the [MJ2] and [RS485] switches under [Communication Port].

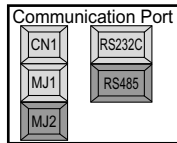

3. Check the signals [+RD], [-RD], [+SD] and [-SD]. Wire inside MJ2 as shown below.

MJ2

Signal Name	Pin No.
+SD	1
-SD	2
+RD	7
-RD	8

The wiring diagram shows a single wire connecting pin 1 to pin 7, and another wire connecting pin 2 to pin 8.

4. Press the [Self-Loop Test] switch. When the [OK] lamp lights up, the test is successfully completed.

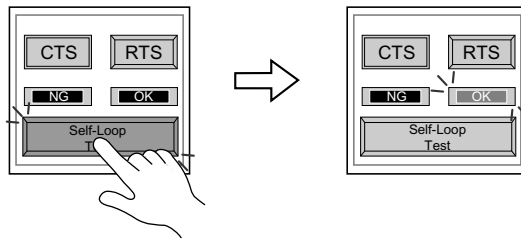

\* If the [NG] lamp lights up, consult your local distributor.

### MJ1 Test

#### RS-232C signal test

1. Turn on the [MJ1] and [RS232C] switches under [Communication Port].

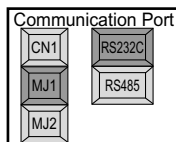

2. Check the signals [RD] and [SD]. Wire inside MJ1 as shown below.

MJ1

Signal Name	Pin No.
RD	7
SD	8

The wiring diagram shows a single wire connecting pin 7 to pin 8.

- Press the [Self-Loop Test] switch. When the [OK] lamp lights up, the test is successfully completed.

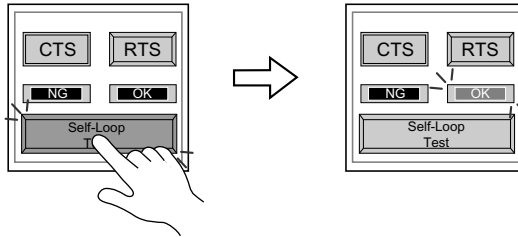

\* If the [NG] lamp lights up, consult your local distributor.

### RS-485 signal test

MJ1 must be connected to MJ2 for an RS-485 signal test through MJ1. Therefore, perform a serial connection test to check that there is no problem with MJ2 before conducting an MJ1 test.

- Slide the slide switch on the POD to the lower position for RS-422.
- Turn on the [MJ1] and [RS485] switches under [Communication Port].

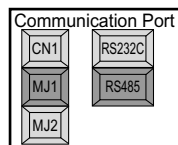

- Check the signals [+RD], [-RD], [+SD] and [-SD]. Connect MJ1 and MJ2 as illustrated below.

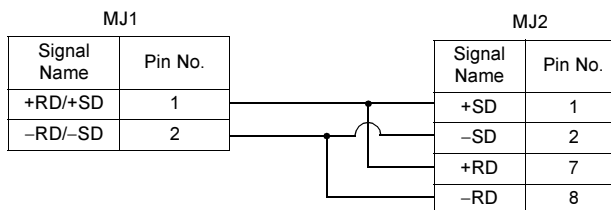

- Press the [Self-Loop Test] switch. When the [OK] lamp lights up, the test is successfully completed.

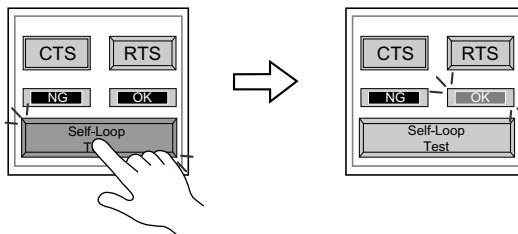

\* If the [NG] lamp lights up, consult your local distributor.

## CN1 Test (with the option unit)

### RS-232C signal test

Turn the [CN1] and [RS232C] switches on.

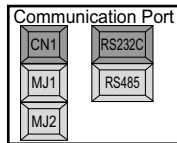

- SD/RD Test

Check the signals [SD] and [RD].

1. Install a jumper between pins 2 and 3 of CN1 on the backside of the UG230.
2. Press the [Self-Loop Test] switch. When the [OK] lamp lights up, the test is successfully completed.

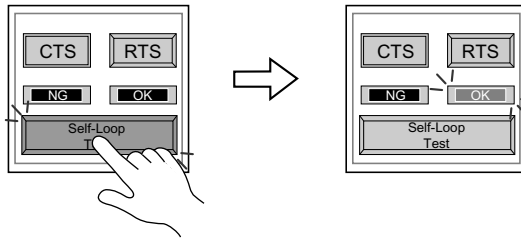

\* If the [NG] lamp lights up, consult your local distributor.

- CTS/RTS Test

Check the signals [CTS] and [RTS].

1. Install a jumper between pins 4 (RTS) and 5 (CTS) of CN1 on the backside of the UG230.
2. Press the [RTS] switch and check that both [RTS] and [CTS] lamps light up at the same time. Press the [RTS] switch again and check that both [RTS] and [CTS] lamps go off at the same time.

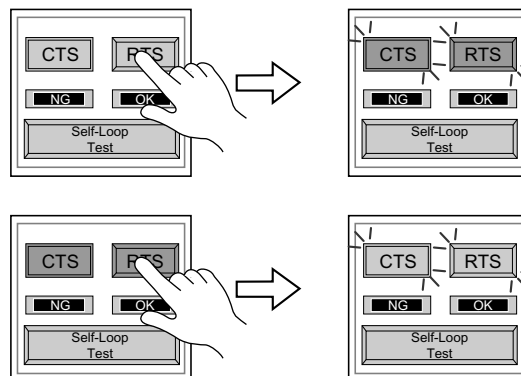

## RS-485 signal test

Turn the [CN1] and [RS485] switches on.

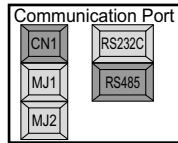

- SD/RD Test

Check the signals [SD] and [RD].

1. Install a jumper between pins 12 and 24 and between pins 13 and 25 of CN1 on the backside of the UG230.
2. Press the [Self-Loop Test] switch. When the [OK] lamp lights up, the test is successfully completed.

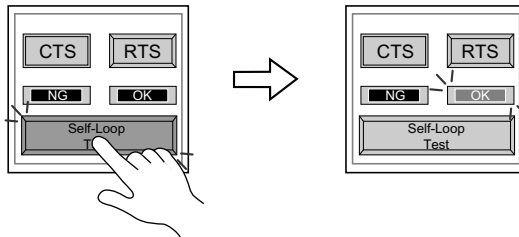

\* If the [NG] lamp lights up, consult your local distributor.

- CTS/RTS Test

Check the signals [CTS] and [RTS].

1. Install a jumper between pins 14 (+RTS) and 19 (+CTS) of CN1 and between pins 17 (-RTS) and 18 (-CTS) on the backside of the UG230.
2. Press the [RTS] switch and check that both [RTS] and [CTS] lamps light up at the same time. Press the [RTS] switch again and check that both [RTS] and [CTS] lamps go off at the same time.

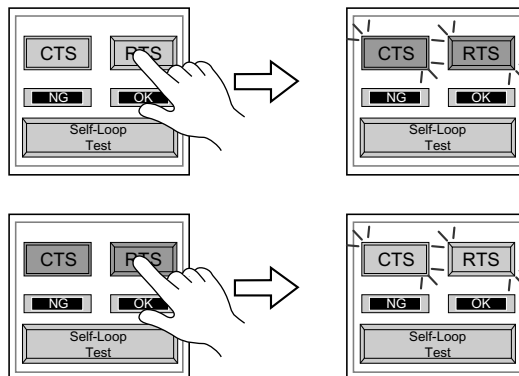

### 1-3. SYSTEM & Function Switch Test

Check operations of six switches provided vertically on the right side of the panel. Press the switch, and check that the lamp on the screen lights up while the switch is held down.

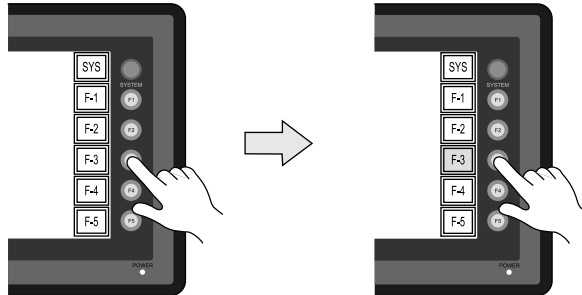

### 1-4. Touch Switch Test

If a touch switch does not activate at all or if an operation is performed without pressing any touch switch, check that the touch switches on the UG230 panel are working properly.

1. Press the [Switch Check] switch. Grids appear on the screen as shown below.

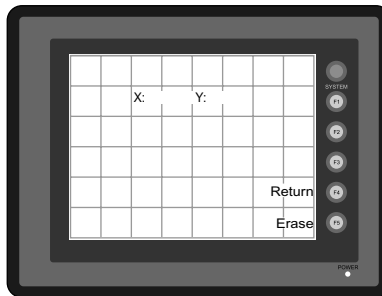

2. Press a position on the panel, and check that the pressed position turns white. The switch is activated normally when the pressed position turns white. To move back to the "I/O Test" screen, press the [F4] switch. To delete white dots press the [F5] switch.

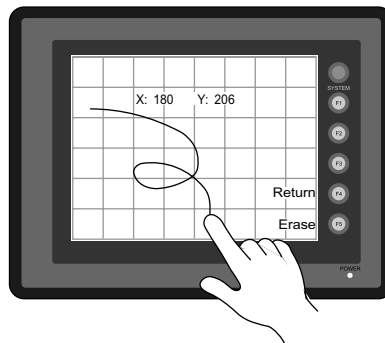

3. If a position different from the pressed position turns white, refer to "Touch Switch Adjustment" on the next page and adjust the touch switch position.

## Touch Switch Adjustment

If a position different from the pressed position turns white on the touch switch test screen, follow the steps described below to adjust the touch switch position.

1. Hold down the [SYSTEM] switch and press the [F2] switch on the touch switch test screen.

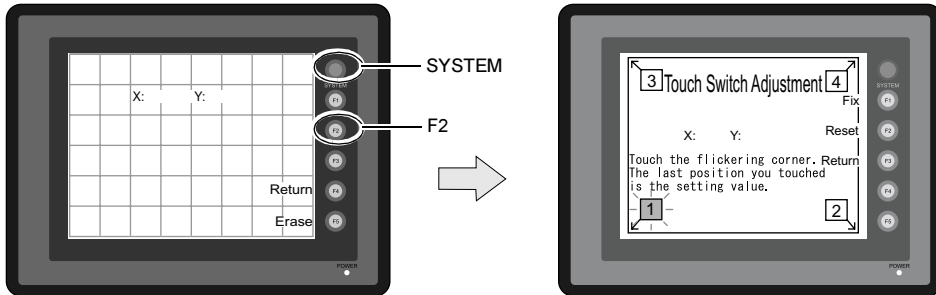

2. Press on "1" that is flashing at the corner on the touch switch adjustment screen. When the finger is released, a beep sounds and the position is set. "2" flashes.

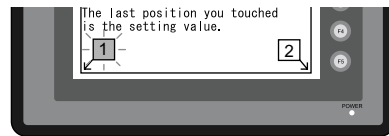

3. Press on "2" that is flashing at the corner. When the finger is released, a beep sounds and the position is set. "3" flashes.

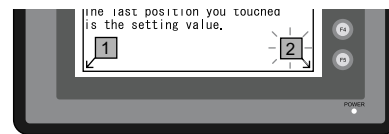

4. Press on "3" that is flashing at the corner. When the finger is released, a beep sounds and the position is set. "4" flashes.

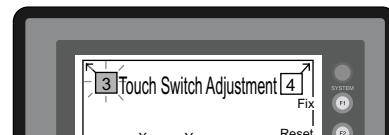

5. Press on "4" that is flashing at the corner. When the finger is released, a beep sounds and the position is set.

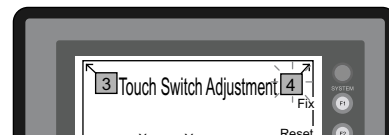

6. To re-set the positions, press the [F2] switch and follow step 2 and later.

7. Press the [F1] switch. A long beep sounds and the positions are determined. The touch switch test screen is displayed again.

8. To cancel the setting, press the [F3] switch. The touch switch test screen is displayed again.

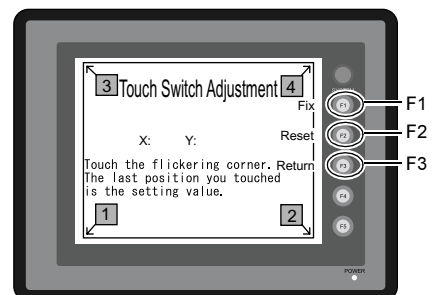

## 2. Card Menu Screen

When the [Card Menu] switch on the Main Menu screen is pressed, the following "Card Menu" screen appears.

This screen is used to transfer screen data between the UG230 and a CF card or a memory card.

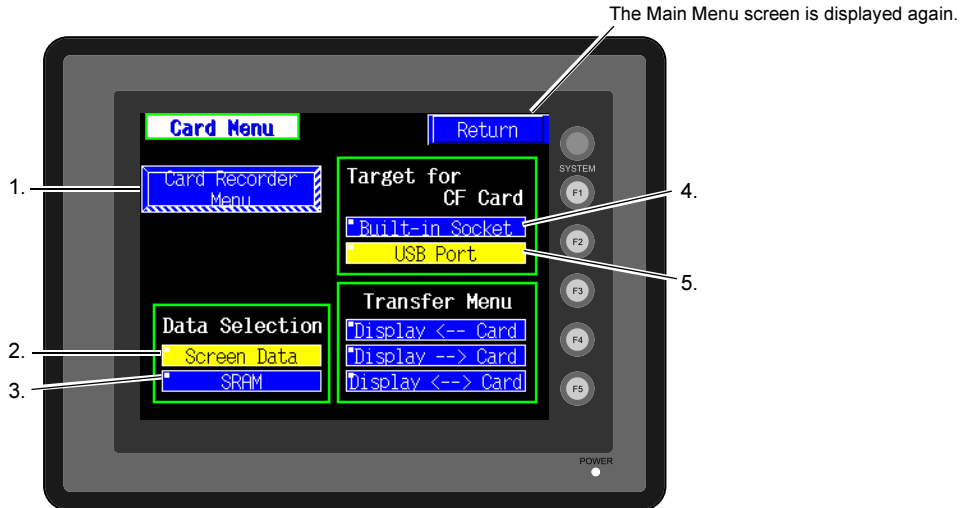

1. [Card Recorder Menu] switch  
Press this switch when connecting the card recorder to the MJ port of the UG230 and transferring screen data between the UG230 and a memory card.
2. [Screen Data] switch  
Press this switch when transferring screen data between the UG230 and a CF card.
3. [SRAM] switch  
Press this switch when saving backup copies of the SRAM memory or when uploading the backup data from the CF card to the UG230.
4. [Built-in Socket] switch  
The CF card insertion position can be selected. If using a CF card while the option unit is mounted, press this switch.
5. [USB Port] switch  
The CF card insertion position can be selected. If using a CF card while a CF card reader/writer (commercially available) is connected to the USB-A (master port), press this switch.



## 2-1. Card Recorder Menu Screen

When the [Card Recorder Menu] switch on the “Card Menu” screen is pressed, the following “Card Recorder Menu” screen appears.

This screen is used to transfer screen data between the UG230 and a memory card. The procedure for transferring data is described below.

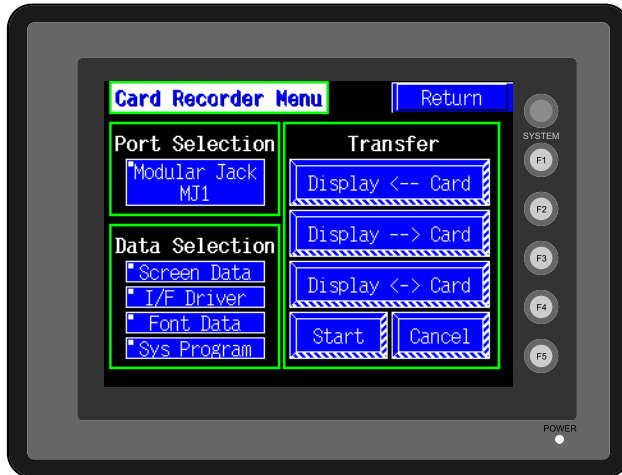

1. Connecting the UG00P-MR  
Connect the UG00P-MR using the attached cable to the MJ port that is displayed in the “Port Selection” field.

- MJ1: Connect the UG00P-MR to the MJ1 port. Normally MJ1 is selected.
- MJ2: Connect the UG00P-MR to the MJ2 port. Only when [Memory Card] is selected for [Modular Jack 2], “MJ2” is indicated in the “Port Selection” field.

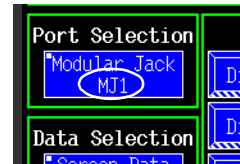

2. Mounting the Memory Card  
Insert a memory card in to the card recorder.

3. Memory Card Information  
Press the [Modular Jack MJ1] switch.

The memory card information contained in the inserted memory card is indicated.

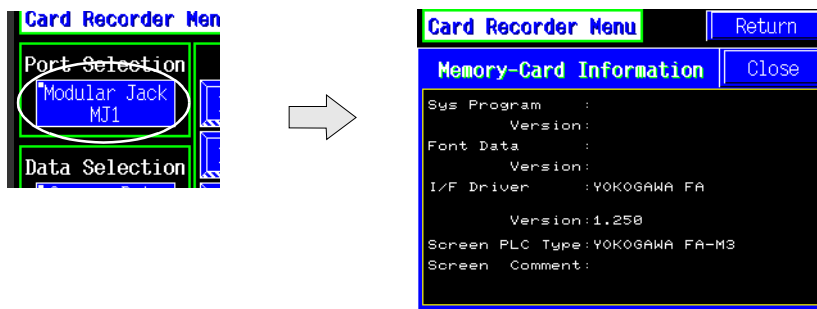

To move back to the previous screen, press the [Close] button.

## 4. Data Selection and Transfer Selection

In the "Transfer" field, select [Display <-- Card], [Display --> Card] or [Display <--> Card]. Press the desired switch to turn the switch on. Multiple switches can be pressed in the "Data Selection" field.

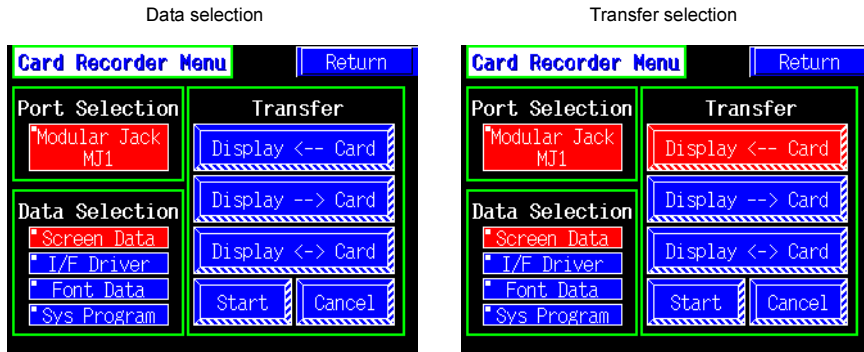

## 5. Starting Data Transfer

Press the [Start] switch. Data transfer is started. During data transfer, the [Start] switch changes into [Busy] and flashes. When data is transferred, the following message is displayed.

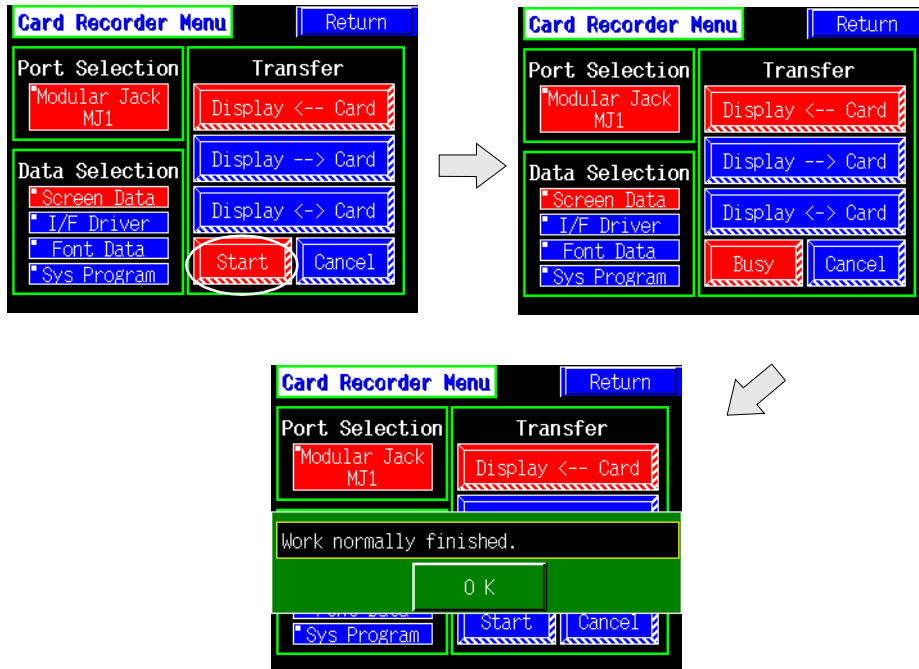

Press the [OK] switch.

## 6. Press the [Return] switch. The "Card Menu" screen is displayed again.

## 2-2. Transferring Screen Data from a CF Card

### CF Card Folder Configuration

Folders in the CF card are configured as shown below.

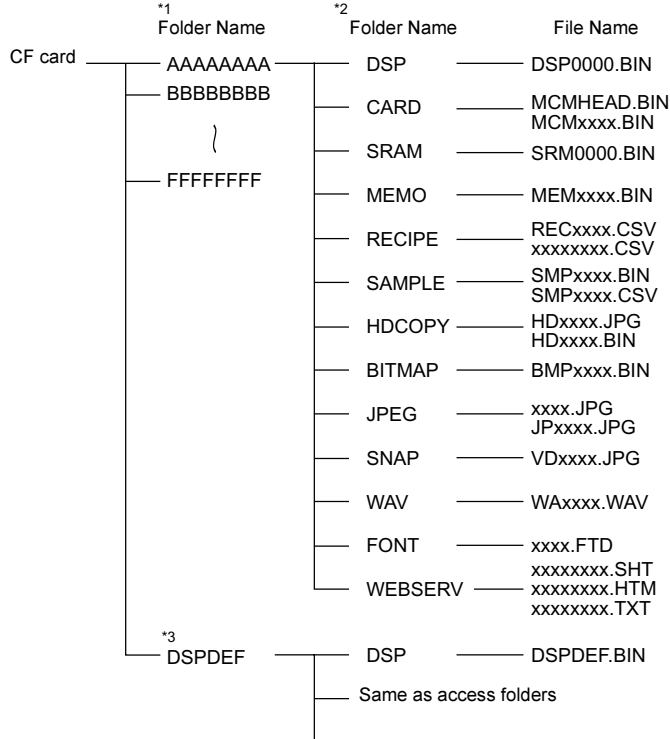

- \*1 These are access folders set by the UG00S-CW editor. Any folder name within eight 1-byte characters can be given.
- \*2 These folders are automatically created when access folders are created. The folder names are fixed.
- \*3 The folder name for screen data auto uploading cannot be changed.

#### DAT0000 (access folder)

Folder Name	Contents	Folder Name	Contents
BITMAP	Saves pattern data (bitmap data) to reduce the screen data capacity.	RECIPE	Reads and writes recipe data.
CARD	Writes recipe data from the UG30 using the UG20-compatible memory manager function.	SAMPLE	Saves history data of the data logging function.
DSP	Reads and writes screen data.	SNAP	Saves video snap images.
FONT	Saves Gothic fonts or language data to reduce the screen data capacity.	SRAM	Saves backup data of SRAM.
HDCOPY	Writes hard copy images in the JPEG file format from the UG30 (UG330H-SS only: BIN file).	WAV	Saves WAV files for sound output to reduce the screen data capacity.
JPEG	Saves JPEG files for display on the screen (except for UG330H-SS).	WEBSERV	Saves files to be accessed from the Web browser.
MEMO	Saves memo pad data drawn with the UG30.		

#### DSPDEF (screen data auto upload folder)

Folder Name	Contents
DSP	When setting the dipswitch on the POD and inserting a CF card, it automatically reads the screen data in this folder.

(Other folders are the same as access folders.)

### Transferring Screen Data from a CF Card

The procedure of transferring data between the UG230 and a CF card is described below.

1. Mounting the CF Card  
 Insert the CF card into the CF card connector at the side of the UG230.  
 \* Do not remove or insert the CF card in the later steps.
2. Data selection  
 Select [Screen Data]. When the lamp is red, it is selected.
3. Transfer selection  
 Select [Display <-- Card], [Display --> Card] or [Display <--> Card].

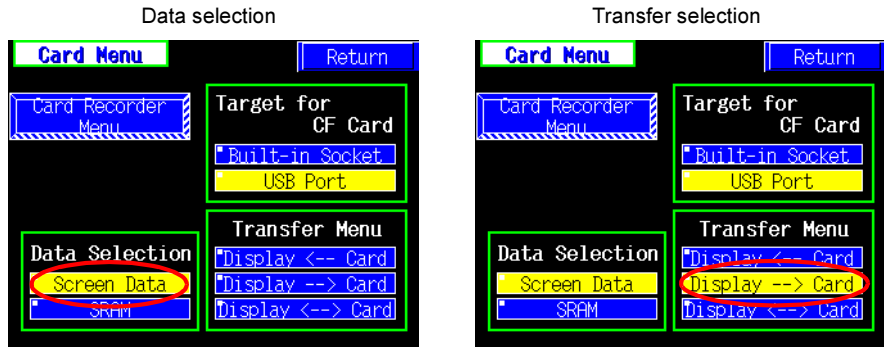

### When [Display <-- Card] is Selected:

Transfer screen data from the computer to the CF card.

1. When [Display <-- Card] is selected, the following screen is displayed.

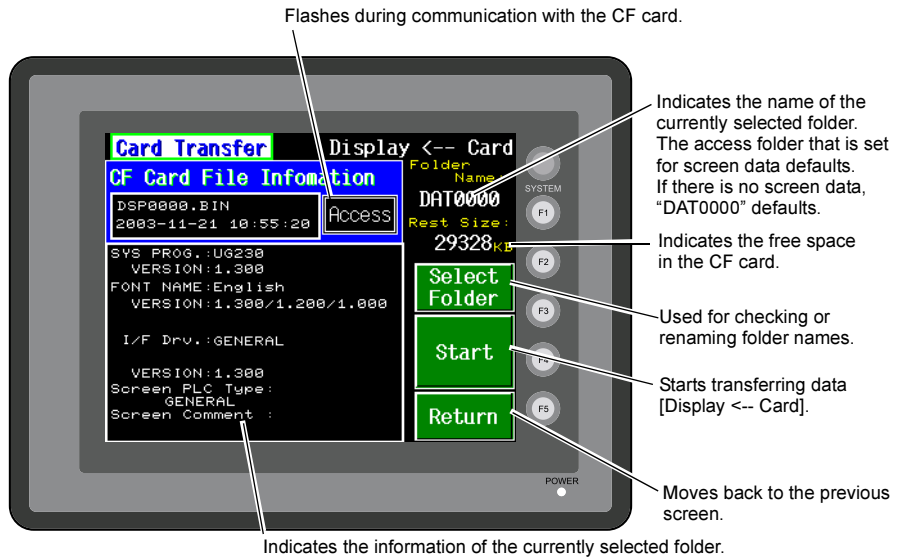

2. Check the folder name, free space, and CF card file information. If the correct folder is selected, move to step 4.
  - Folder Name  
Indicates the name of the currently selected folder.  
The access folder that is set for screen data defaults.  
If there is no screen data, "DAT0000" defaults.
  - Rest Size  
Indicates the free space in the CF card.
  - CF Card File Information  
Indicates the information of the currently selected folder.
3. To change to another folder, press the [Select Folder] switch.  
The "Select Folder" screen is displayed.

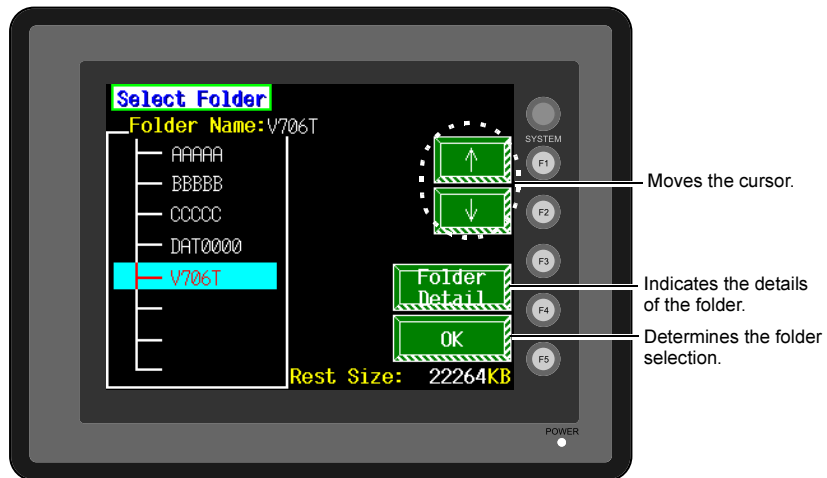

- To see the details of the folder, press the [Folder Detail] switch.  
The "Folder Detail" screen is displayed.



- Select the desired folder using the [↑]/[↓] switch, and press the [OK] switch.  
The Card Transfer screen is displayed again and the CF card file information of the selected file is indicated.

- Press the [Select Data] switch.  
The [Data Selection] window is displayed and the [Select Data] switch changes to [Start].

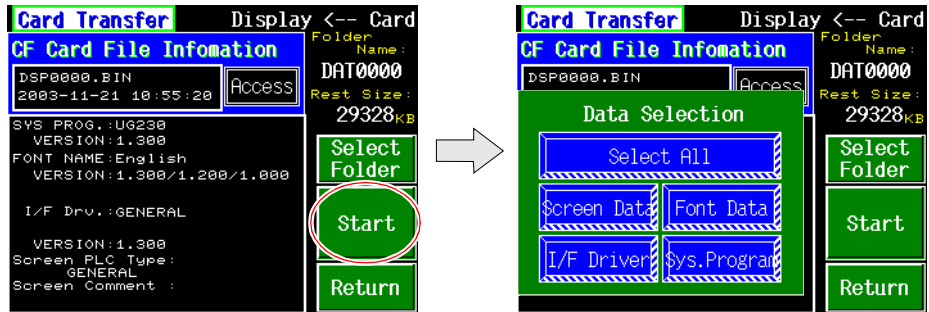

Select the desired data, and press the [Start] switch.

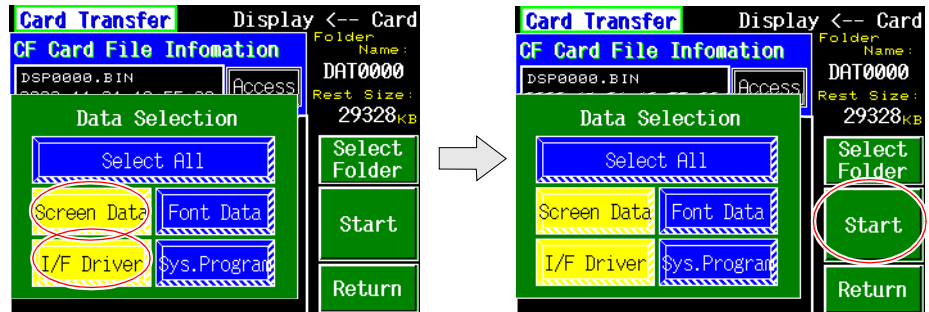

To cancel the [Data Selection] window, press the [Return] switch.

- During data transfer, the [Start] switch changes into [Busy] and flashes. When data has been transferred successfully, the following window is displayed. However, when [Sys. Program] or [Select All] is selected, the Main Menu screen is displayed without this message window on completion of data transfer.



Press the [OK] switch.

The "Card Menu" screen is displayed.

If any other message is displayed, refer to page 6-26.

### When [Display --> Card] is Selected:

1. When [Display --> Card] is selected, the "Card Transfer" screen is displayed.

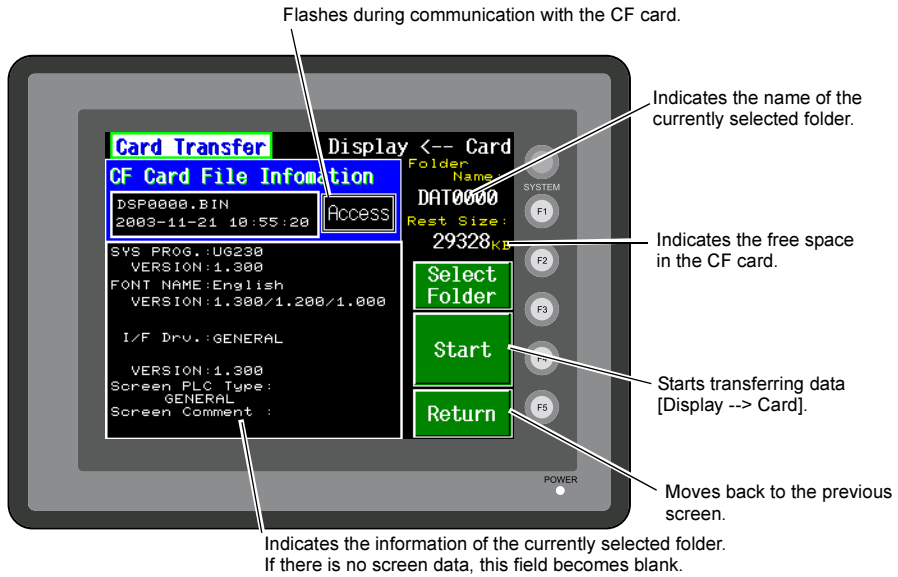

2. Check the folder name and CF card file information, and press the [Start] switch.
  - \* When the access folder name of screen data is the same as that in the CF card, the CF card file information is indicated on the screen, and data in the unit overwrites the CF card data. Note that the CF card data is lost when data in the unit overwrites. When the CF card file information is blank, a new file "DSP0000.BIN" is created in the DSP folder.
3. During data transfer, the [Start] switch changes into [Busy] and flashes. When data has been transferred successfully, the following window is displayed.



Press the [OK] switch. The CF card file information shows data that has been transferred. If any other message is displayed, refer to page 6-26.

4. Press the [Return] switch. The "Card Menu" screen is displayed again.

### When [Display <--> Card] is Selected:

- When [Display <--> Card] is selected, the "Card Transfer" screen is displayed. Screen data used for comparison is that in the DSP folder under the folder having the same name as the access folder that is set by the UG00S-CW editor.

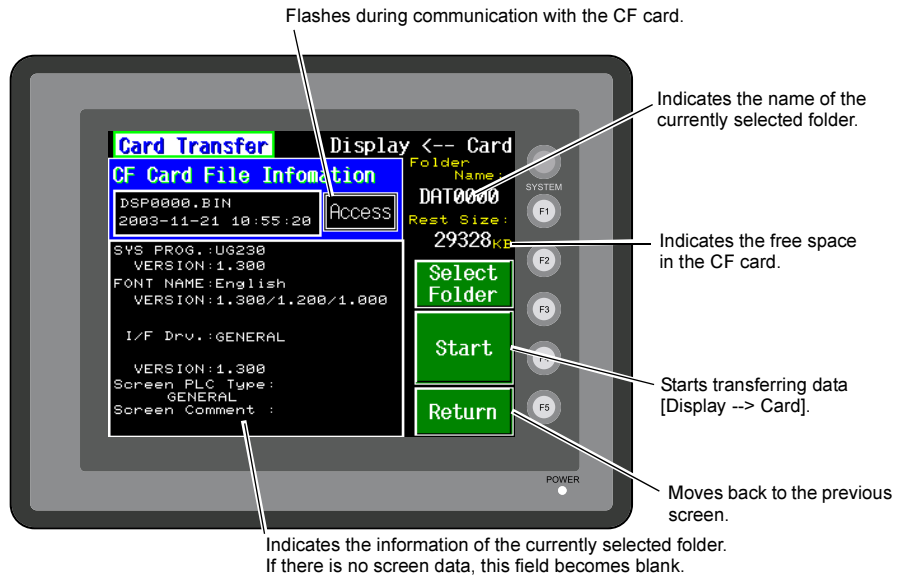

- Press the [Start] switch.
- During data transfer, the [Start] switch changes into [Busy] and flashes. When data has been transferred successfully, the following window is displayed.



Press the [OK] switch.

If any other message is displayed, refer to page 6-26.

- Press the [Return] switch. The "Card Menu" screen is displayed again.



## 2-3. Saving Backup Copies of SRAM

In this section, the procedure for saving backup copies of the SRAM memory for battery replacement is explained.

1. Press the [SRAM] switch on the "Card Menu" screen. When the lamp is red, it is selected.
2. Select [Display <-- Card], [Display --> Card] or [Display <--> Card].

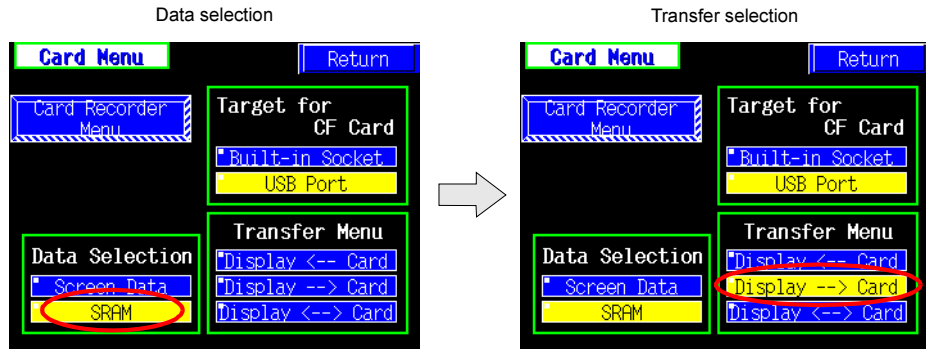

3. The "SRAM Transfer" screen is displayed.
  - When [Display --> Card] or [Display <--> Card] is selected, the following screen is displayed. Select the CF card folder having the same name as the access folder for screen data in the unit. The name is shown on the screen. The transferred file is named "SRM0000.BIN".

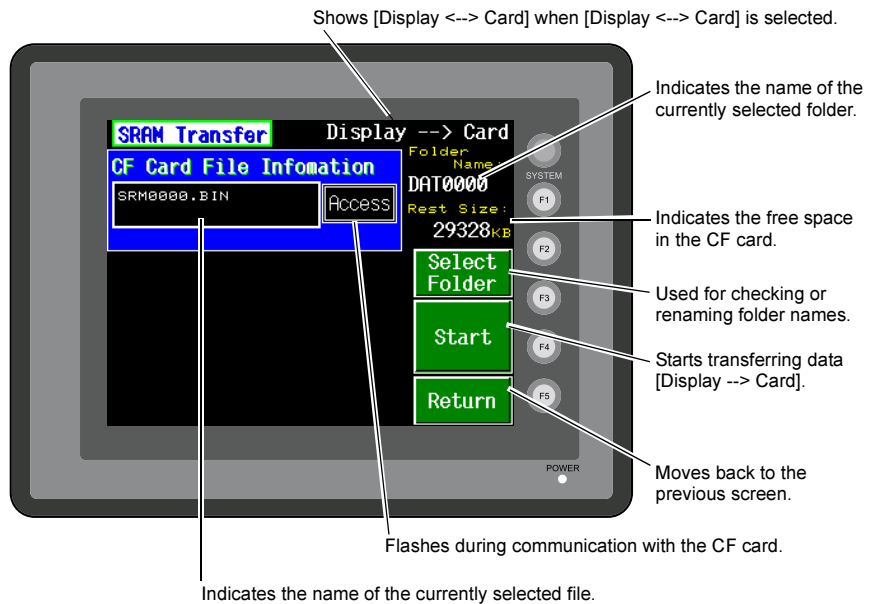

- When [Display <-- Card] is selected, the following screen is displayed.

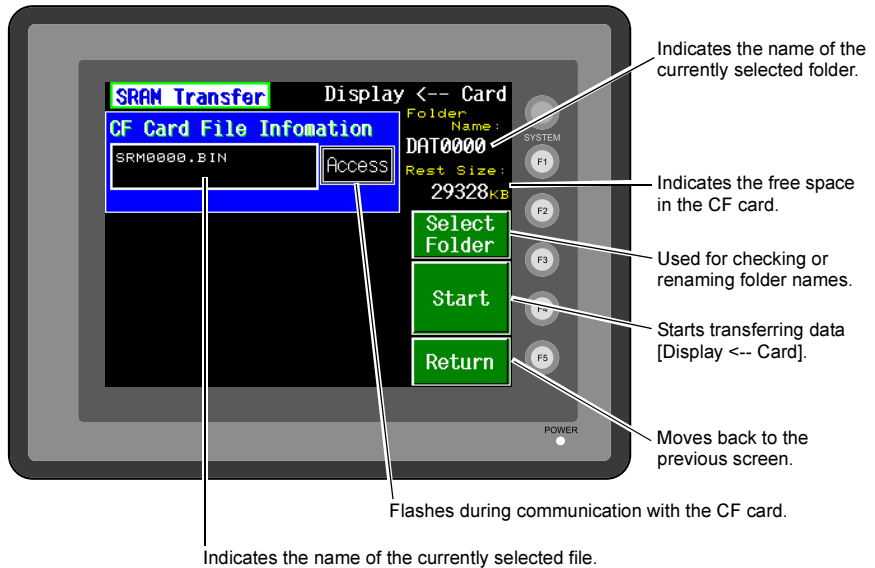

- 1) To change to another folder, press the [Select Folder] switch. (The folder name must be "SRM0000.BIN".)
- 2) The "Select Folder" screen is displayed as shown on page 6-20. Select the desired folder (refer to page 6-20), and press the [OK] switch.
- 3) Moves back to the "SRAM Transfer" screen.
4. Starting Data Transfer  
Check the folder name, free space and transfer selection, press the [Start] switch. Data transfer is started.
5. Ending Data Transfer  
When data has been transferred successfully, the following window is displayed.



Press the [OK] switch.  
If any other message is displayed, refer to the next page.

6. Pressing the [Return] switch moves back to the "Card Menu" screen.

## 2-4. Messages during Data Transfer

If an error occurs during data transfer, the message window shown on the right is displayed.

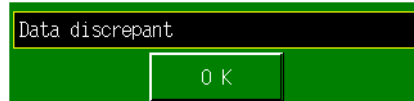

The kinds and the contents of the messages are shown below. The same messages are used for the memory card and CF card. When using the CF card, the "memory card" in the explanation should read as the "CF card".

Message	Contents
Work normally finished.	The specified operation has been concluded normally.
Card recorder not connecting	No card recorder is connected when selecting a modular jack.
UG00P-MR Communication Error	A communication error occurred between POD and UG00P-MR when selecting a modular jack.
Card not setting	Memory-Card not setting
Memory-Card Capacity over	Cannot write the data into a memory card because the data size in POD is larger than the capacity of a memory card.
Write Protect: ON	Cannot write data into a memory card because the write protect switch in a memory card is ON.
Writing Error occurred.	The error occurred while writing data into a memory card.
Selected data does not exist.	The data in the reading target does not exist.
UG type is different.	The specified type of the data in POD is different from the type of the memory card data.
Selected data can not be read.	The data in a memory card cannot be read.
Reading Error occurred.	The error occurred during writing data into a flash ROM of POD.
Data discrepant	There is some discrepancy in data, when comparing data between a memory card and POD.
Screen data on UG will be broken.	Warning about data destruction in POD that may occur when transferring the font data larger than the present data from a memory card to POD. (The [OK] switch continues transferring; the [Cancel] switch stops transferring.)
Undefined Error occurred.	The error occurred due to some cause other than mentioned above.

### 3. Communication Parameter Screen

When the [Comm. Para.] switch on the Main Menu screen is pressed, the "Comm. Param." screen, shown below, is displayed.

This screen is used to check the UG230 communication parameter settings.

The Main Menu screen is displayed again.

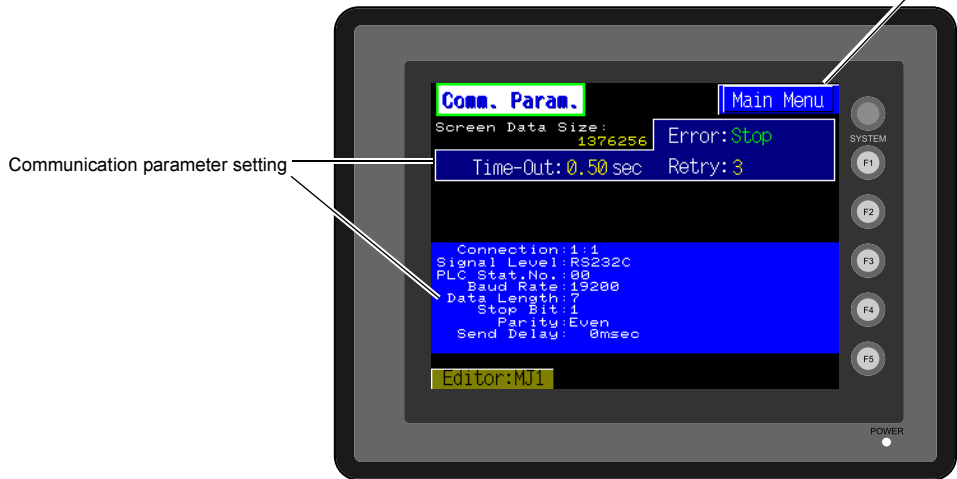

Communication parameter setting

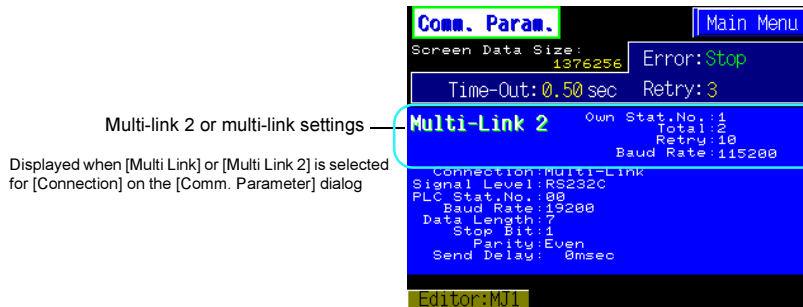

Multi-link 2 or multi-link settings

Displayed when [Multi Link] or [Multi Link 2] is selected for [Connection] on the [Comm. Parameter] dialog

## 4. Extension Program Information

When the [Extension] switch on the Main Menu screen is pressed, the following "Extension Prog. Info." screen appears.

The driver setting and parameter setting for temperature controller/PLC2Way communication, ladder transfer function, Modbus slave communication, etc. are displayed.



## 5. Ethernet (Optional)



**CAUTION** When performing Ethernet communication on the UG230, the option unit UG230A-DCL must be installed.

The "Ethernet Information" screen is displayed by pressing the [IP Address (English)] switch on the initial screen when transferring screen data via Ethernet for the first time, or by pressing the [Ethernet Information] switch on the Main Menu screen when transferring screen data to a UG230 equipped with the option unit UG230A-DCL.

### 5-1. Ethernet Information Screen

This screen is used to check the current IP address, port number, or error.

Moves to the "Ethernet" screen for IP Address Setting. (See "IP Address Setting" (page 6-30))

The Main Menu screen is displayed again.

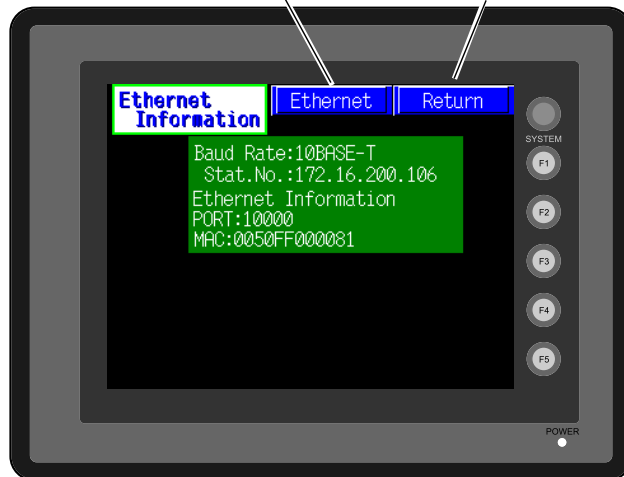

Pressing the [Ethernet] switch brings up the "Ethernet" screen for IP address setting.

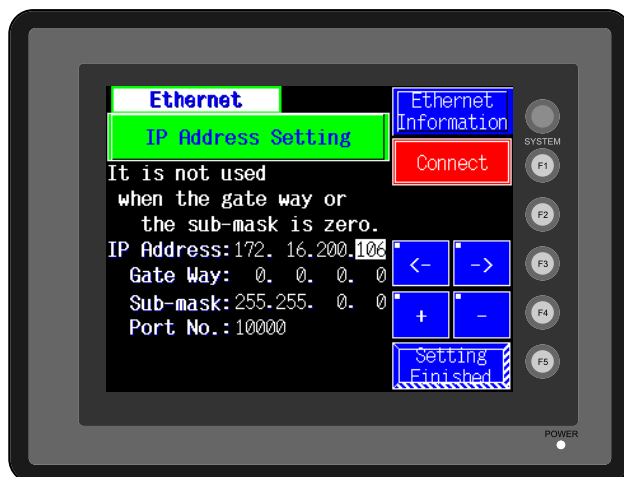

To move back to the previous "Ethernet Information" screen, press the [Ethernet Information] switch.

## 5-2. IP Address Setting

IP address (number for identifying UG230 on the network) setting is required before conducting communications via Ethernet. The setting procedure varies depending on the screen data conditions.

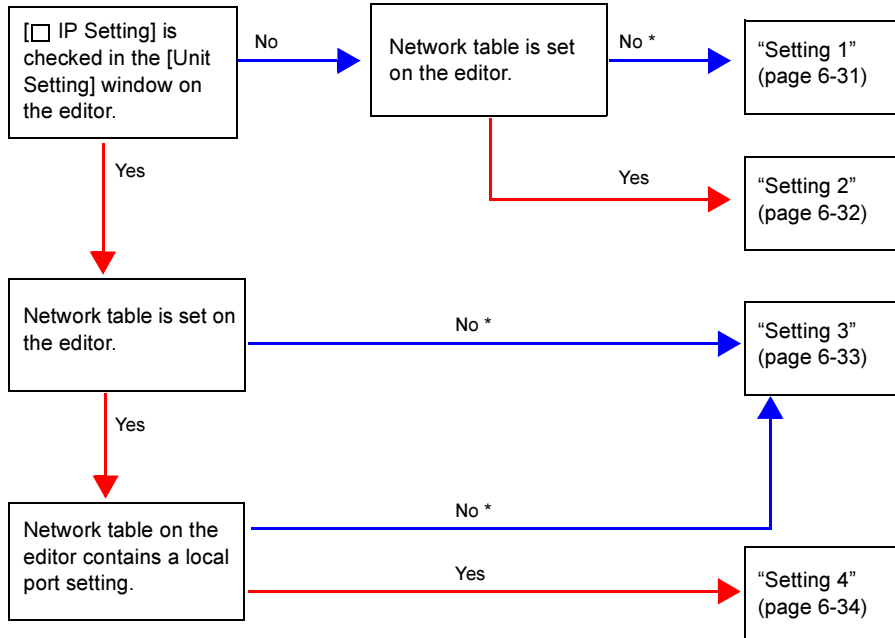

- \* When no network table is set on the editor:
- Ethernet macro commands (EREAD, EWRITE, and SEND) disabled
  - Communication with PLC via Ethernet disabled
- For more information, refer to page 6-32.

## Setting 1

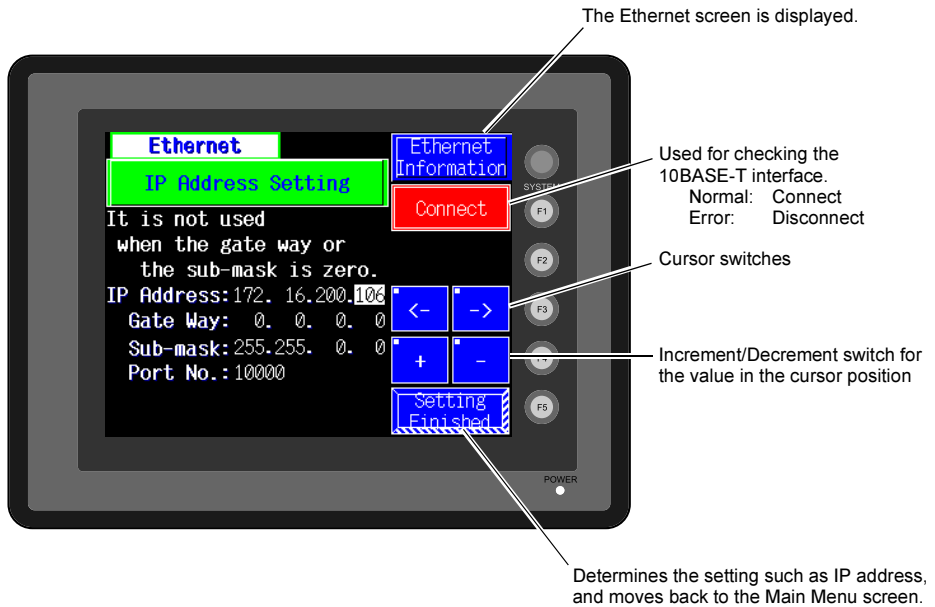

Set the IP address on the POD screen.

1. Open the "Ethernet" screen from the "Ethernet Information" screen using the [Ethernet] switch.
2. Set the IP address and other necessary options.
3. Press the [Setting Finished] switch to move back to the Main Menu screen.



Setting 2

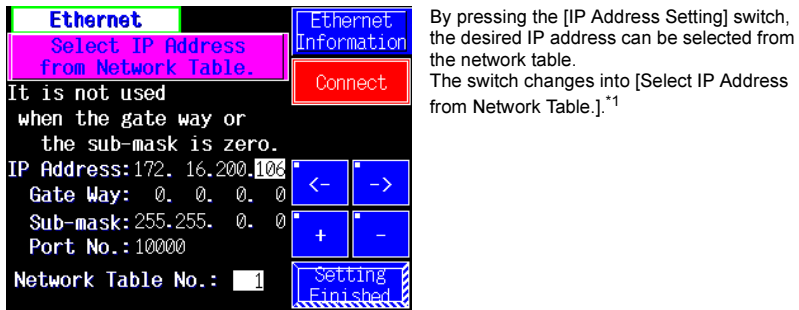
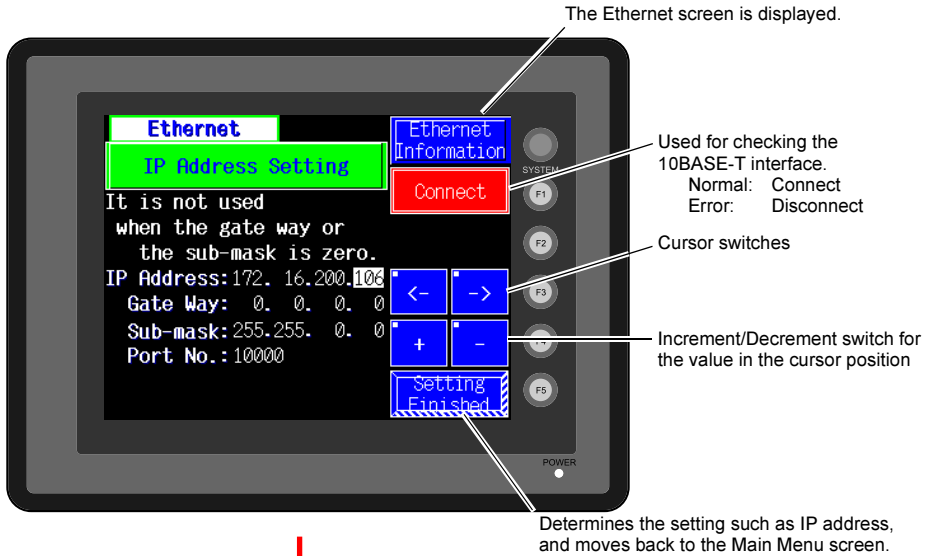

\*1 Network Table  
 Register IP addresses and other information for the UG230, PLCs or computers that should be included for Ethernet communications on the UG00S-CW editor.  
 ([System Setting] → [Network Table Setting] → [Ethernet] → Edit Network Table)  
 If you would like to use the IP address of the registered network table, select [IP Address from Network Table].

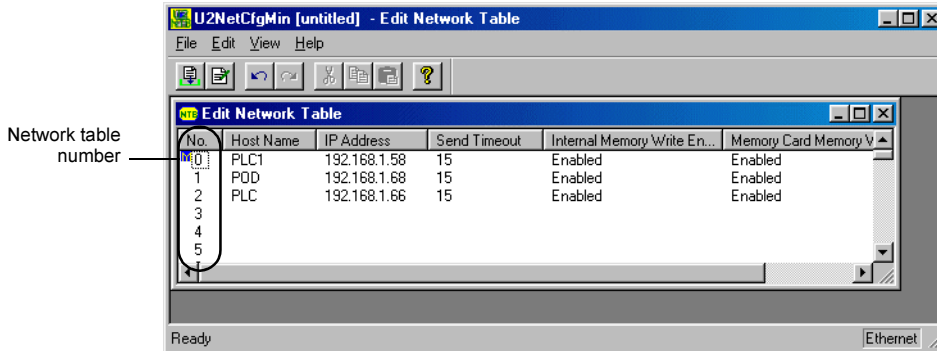

Set the IP address on the Main Menu screen.

1. Press the [Ethernet] switch on the Main Menu screen to bring up the Ethernet screen.
2. Change the switch on the screen into [Select IP Address from Network Table.].
3. Select the desired IP address by changing the network table number.
4. Press the [Setting Finished] switch to move back to the Ethernet screen.

### Setting 3

Set the IP address on the editor.

1. On the editor, click [System Setting], [Unit Setting] and [IP Address Setting]. The [IP Address Setting] dialog is displayed.
2. Check  IP Setting.

The screenshot shows the 'Unit Setting' dialog box with the 'IP Address Setting' tab selected. The 'IP Setting' checkbox is checked. The 'IP Address' field is set to 0.0.0.0. The 'Default Gateway' field is set to 0.0.0.0. The 'Sub Net Mask' field is set to 0.0.0.0. The 'Port No.' field is set to 10000. The 'Send Time Out' field is set to 15 \*sec. There are also checkboxes for 'Memory Protect' (Internal Memory and Memory Card Memory). The dialog has 'OK' and 'Cancel' buttons at the bottom.

3. Set the following options.
  - IP Address
  - Default Gateway
  - Sub Net Mask
  - Port No.
  - Send Timeout
  - Memory Protect
4. Click the [OK] button and transfer the screen data. The IP address set above can be checked on the "Ethernet Information" screen to be displayed from the Main Menu screen.

## Setting 4

Set the IP address on the editor.

1. On the editor, click [System Setting], [Unit Setting] and [IP Address Setting]. The [IP Address Setting] dialog is displayed.
2. Check  IP Setting.
3. Check  Select IP Address from Network Table. Enter the network table number with which POD's IP address is registered.

The screenshot shows the 'Unit Setting' dialog box with the 'IP Address Setting' tab selected. The 'IP Setting' checkbox is checked. The 'Select IP Address from Network Table' checkbox is also checked, and the network table number is set to 'No 1'. The IP Address field is set to '0 . 0 . 0 . 0'. The Default Gateway and Sub Net Mask fields are also set to '0 . 0 . 0 . 0'. The Port No. field is set to '10000' and the Send Time Out field is set to '15 \*sec'. The Memory Protect section has 'Internal Memory' and 'Memory Card Memory' checkboxes, both of which are unchecked. The 'OK' and 'Cancel' buttons are visible at the bottom right.

4. Click the [OK] button and transfer the screen data. The IP address set above can be checked on the "Ethernet Information" screen to be displayed from the Main Menu screen.

### Changing the IP Address Temporarily

The IP address can be changed temporarily on the POD screen. The screen to be used varies depending on the method of IP address setting (page 6-30).

#### Setting 1/2

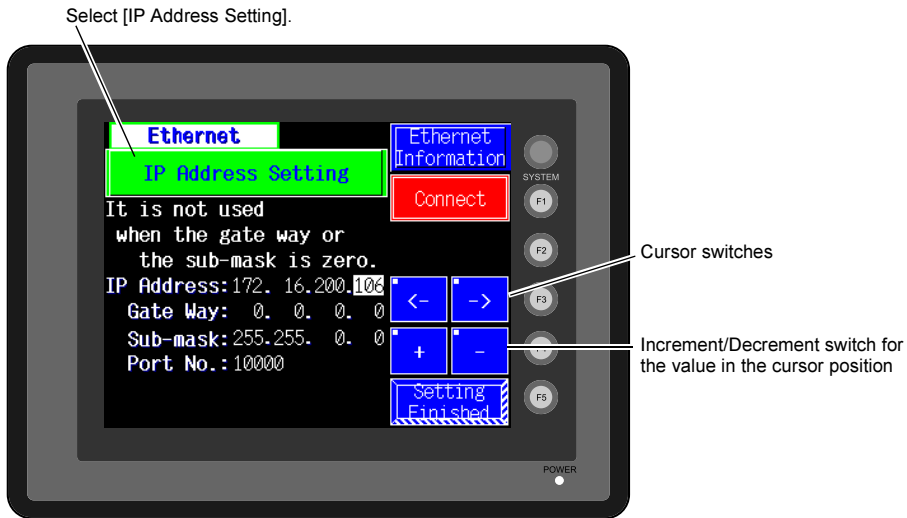

#### Setting 3/4

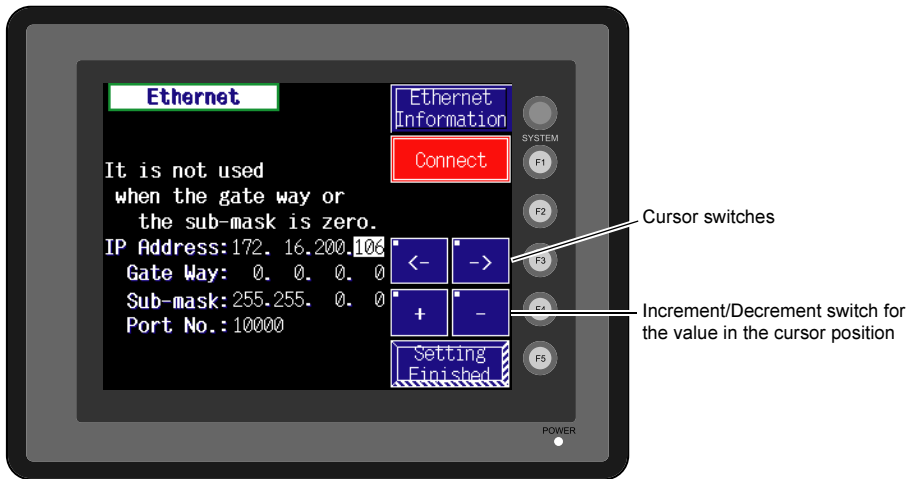

## 6. SRAM/Clock

- To use the built-in clock of the UG230, it is necessary to select [SRAM/Clock Setting] from the [System Setting] menu and make the SRAM/clock setting.  
For the setting procedure, refer to the User's Manual <Function> (FEH376).
- Be sure to set the battery when using the built-in clock of the UG230. Without battery, the contents in the SRAM or clock data will not be retained.  
When the battery is not connected, the message "Battery not set" is displayed and the [SRAM/Clock] switch flashes on the Main Menu screen. Connect the battery immediately.  
When the battery is to be replaced, the message "Brownout Battery" is displayed.

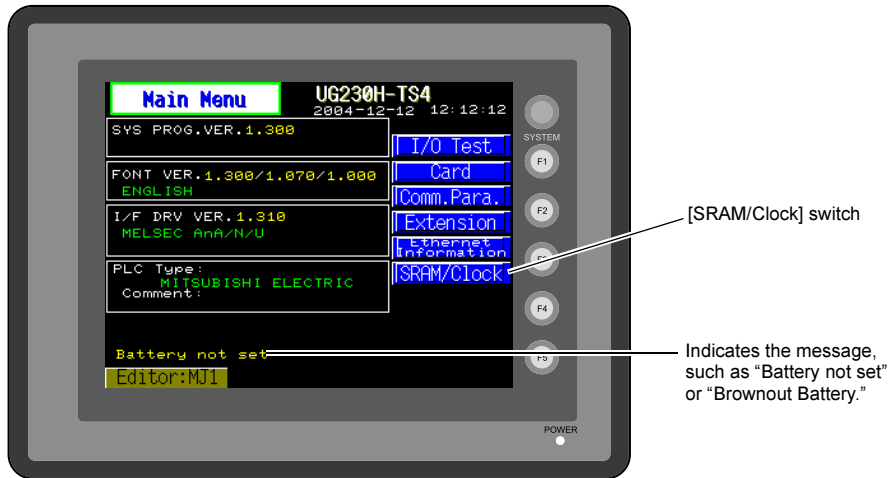

- When the [SRAM/Clock] switch on the Main Menu screen is pressed, the following "SRAM/Clock Adjustment" screen appears.  
This screen is used for adjusting the built-in calendar and for initializing the SRAM area.

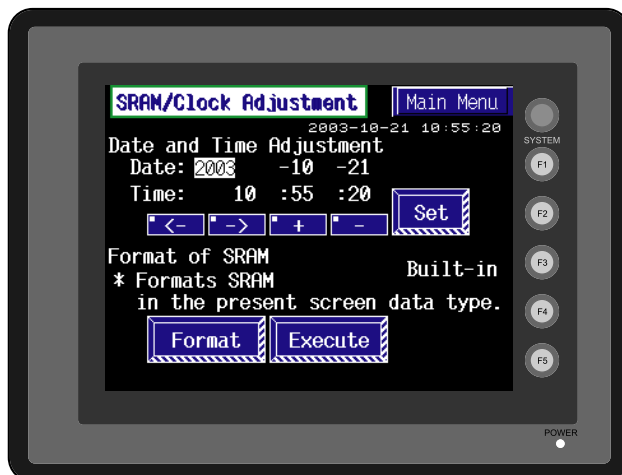

## Date and Time Setting

1. Move the cursor using the [←] / [→] switch, and change the value by pressing the [+] / [-] switch.
2. When the desired date and time are set, press the [Set] switch to determine the setting.
3. The calendar data is updated as set.

## Initializing SRAM

When the SRAM memory or cassette is initialized, the data contained is cleared. Double-check before initializing the SRAM memory or cassette.

1. Press the [Format] switch and the [Execute] switch.
2. The SRAM area is initialized in the current screen data format. When initialization has been completed, the message "\*\*Format Completed\*\*" is displayed.

## 7. Extended Function Setting

When the [Editor: MJ1] switch on the Main Menu screen is pressed, the following "Extended Function Setting" screen appears.

Set the baud rate to be used when transferring screen data between the UG230 and a modem.

1. Select the desired baud rate using the [↑] / [↓] switch, and press the [Setting Finished] switch. (Setting range: 4800, 9600, 19200, 38400, 57600, 115200)
  - \* The function switches and switches on the Main Menu screen are not valid for 15 seconds after the [Setting Finished] switch is pressed.
  - \* When the [Setting Finished] switch is pressed, an AT command is automatically sent to the modem and the baud rate used between the UG230 and the modem is set.
2. The Main Menu screen is displayed automatically. [Modem Connect Mode] automatically appears under [Editor: MJ1].
3. To transfer screen data without a modem, select "Not used" for [Modem Comm. Baud Rate]. For screen data transfer while a computer is connected with UG00C-T, specify [Not Used] for [Modem Comm. Baud Rate].

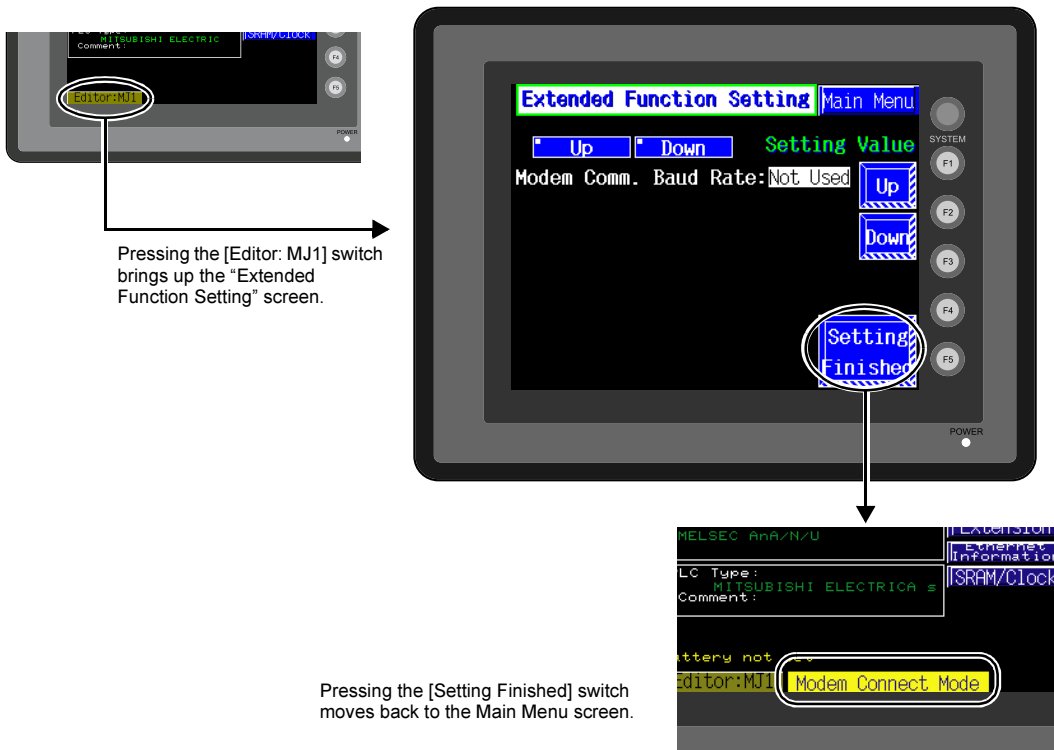

# 7 Error Correction

---

1. Error Messages
2. Troubleshooting



# 1. Error Messages

There are five kinds of error messages displayed on the UG30 series:

1. Communication error
2. Check
3. Warning
4. SYSTEM ERROR
5. Touch switch is active

## 1. Communication Error

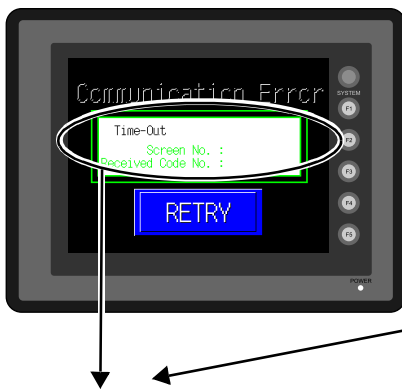

\* When you go to [Comm. Parameter], bring up the [Detail] tab window and set [Continue] for [Comm. Error Handling], a screen like the one shown below is displayed.

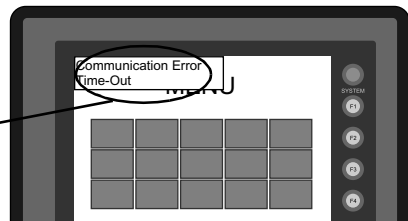

Error Message	Contents	Solution	Remarks
Timeout	Although a request to send is given to the PLC, no answer is returned within the specified time.	1. Check the communication parameters. 2. Check the cables and wiring.	1
		3. Data may be disrupted because of noise. Fix noise.	2
Parity	An error occurred in parity check.	1. Check the cables and wiring.	1
		2. Data may be disrupted because of noise. Fix noise.	2
Framing	Although the stop bit must be [1], it is detected as [0].	1. Check the communication parameters. 2. Check the cables and wiring.	1
		3. Data may be disrupted because of noise. Fix noise.	2
Overrun	After one character is received, the next character is received before internal processing is completed.	1. Check the communication parameters.	1
		2. Data may be disrupted because of noise. Fix noise.	2
Check code error	The check code in the PLC response was not correct.	1. Check the communication parameters.	1
		2. Data may be disrupted because of noise. Fix noise.	2

\* If the above error messages are displayed on the POD without establishing communication between POD and PLC, test the solution of remark "1."  
If the error occurs suddenly in communication, test the solution of remark "2."

Error Message	Contents	Solution
Error code received	The PLC sent an error code (NAK).	Examine the PLC error code and solve the problem.
Break	The PLC's SD (TXD) remains at the low level.	Examine the connection between the PLC's SD (TXD) and the UG series RD (RXD).
Invalid memory (applicable to Mitsubishi CPU)	You specified an address that exceeds the memory range of the PLC that you are linked to.	Check the type and range of memory that you set.
Invalid CPU model (applicable to Mitsubishi CPU)	The PLC currently being supported does not have a corresponding CPU.	Confirm whether or not the CPU that you are using can be used with the UG series.
Format	The code of the received data is invalid.	Check 1, 2, 3 described below.
Compare (applicable to HIDIC S10)	Transmission data and received data are different.	Check 1, 2, 3 described below.
NAK (applicable to Allen-Bradley PLC)	A NAK code is received.	Check 1, 2, 3 described below.
TNS discrepant (applicable to Allen-Bradley PLC)	Transmitted TNS data and received TNS data are not in agreement.	Check 1, 2, 3 described below.
Communication Error	An unclear communication error is detected.	Check 1, 2, 3 described below.
Count error (applicable to Mitsubishi CPU and Q link unit)	The expected data amount is different from the count value.	Check 1, 2, 3 described below.
Command error (applicable to Mitsubishi CPU and Q link unit)	The response code differs from the expected code.	Check 1, 2, 3 described below.
Invalid cassette (applicable to Mitsubishi ACPU)	This cassette is not included in the memory cassettes currently being supported.	Contact your local distributor.
Password error (applicable to Mitsubishi QCPU)	The password is incorrect.	Contact your local distributor.

#### Solution

1. Confirm link unit settings. (After making settings, cut power to the PLC.)
2. Go to the editor and confirm the settings in the [Comm. Parameter] dialog in the [System Setting] menu.
3. If errors only occur from time to time, it is possible that there is a noise-based communication error.
  - \* If you still cannot solve the error even after following the suggestions above, contact your local distributor.

## Error Messages for Network Communication

- Ethernet

Error Message	Contents	Solution
Ethernet Error: XXXX	The Ethernet status is saved at system memory address \$s518 and a code other than "0" (normal) is received. XXXX: Error No.	For the contents and solution to each error number, refer to Appendix 5 of the User's Manual <Function> (FEH376) separately provided.

## 2. Check

Error Message	Contents	Solution
Screen No. Error	There is no setting for the received screen.	At the start of communications, the UG30 series regards the value in the read area "n + 2" as the screen number. Check that the value in the read area "n + 2" is an existing screen number on the PLC.
Data has some error. Error : XX (XX : XXX)	There is an error in the created screen data.	"Error : XX (XX : XXX)" indicates the edited screen and the contents of the error. For the error details and solutions, refer to the User's Manual <Function> (FEH376) and correct screen data.

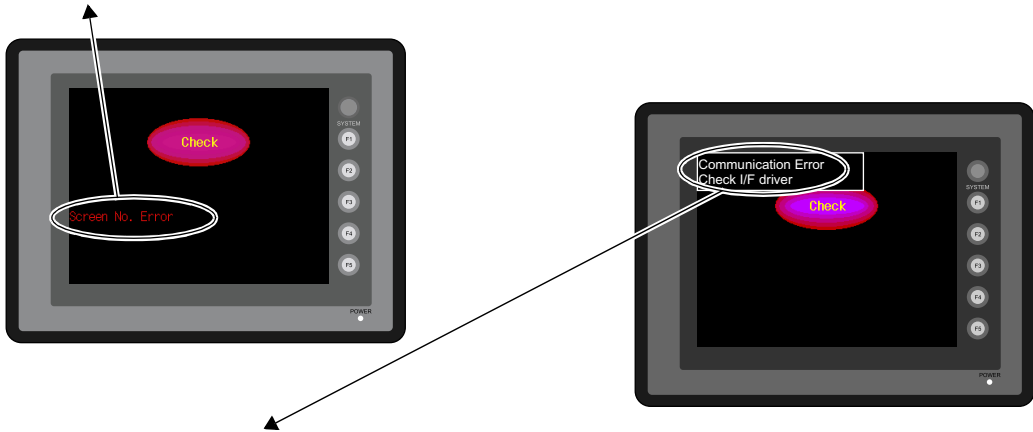

Error Message	Contents	Solution
Communication Error Check I/F driver	Although a request to send is given to the computer, no answer is returned within the specified time.	The I/F driver for simulator is transferred. If you do not use the simulator, uncheck [Use Simulator] before transferring data.

## 3. Warning

An error may be displayed on the Main Menu screen during data transfer.

This is a warning message.

For the warning details and solutions, refer to the User's Manual <Function> (FEH376) and correct screen data.

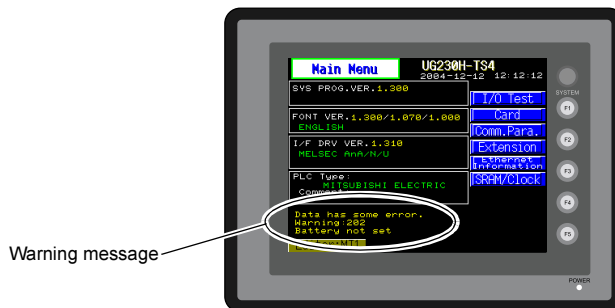

## 4. SYSTEM ERROR

When a system error is detected, the following error screen is displayed.

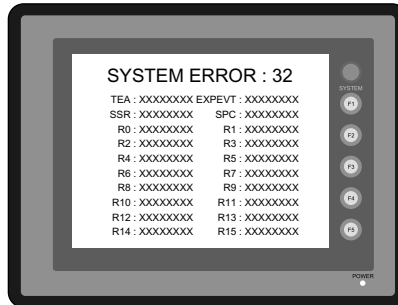

ERROR: XX

- 1: Watch dog timer error
- 11: Switch table error
- 30: Request for displaying full error
- 31: Memory allocation system error
- 32: General exceptions/MMU address system error
- 33: RTOS system error
- 34: Memory error
- 35: Inaccurate memory error

The source of the error could be one of the following three problems.

- 1) Program crash due to noise
- 2) Hardware problem
- 3) Bad program

Solve relevant problems by following the directions in "Troubleshooting" (page 7-5).

If the problem persists, contact your local distributor.

## 5. Touch Switch is Active

If the power is turned off while a touch switch is activated, the following error screen is displayed. Remove your finger from the screen.

If the error screen remains displayed, contact your local distributor.

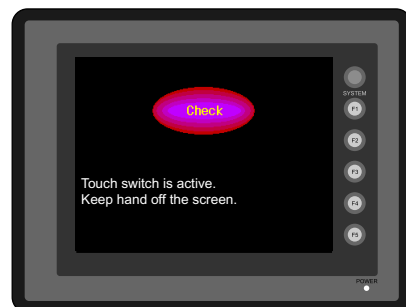



## 2. Troubleshooting

### In the Event of an Error

Perform the steps below:

1. If the current error matches a symptom in the following table, correct it by following the instructions provided.
2. If the error does not match the symptoms in the table, contact your local distributor. Please provide the distributor with the information on the POD model, serial number, symptom of the error, error message (if shown), etc.

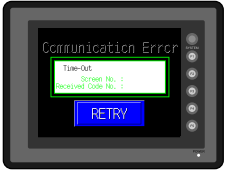
### Probable Symptoms

Symptom	Cause	Solution
<p>POD is connected to the PLC; however, communication fails. "Communication Error: Time-Out" appears on the screen.</p> 	<p>Probable causes are:</p> <ol style="list-style-type: none"> <li>1) Cables are not connected correctly or any cable is disconnected.</li> <li>2) PLC parameter settings are not correct or disagree with the POD settings.</li> <li>3) The POD is faulty.</li> </ol>	<p>Solutions are:</p> <ol style="list-style-type: none"> <li>1) Check the cable connection.</li> <li>2) Recheck the PLC parameter settings.</li> <li>3) Perform a self-loop test on the "I/O Test" screen (page 6-7). If the test is not successful, please return the POD to your local distributor immediately.</li> </ol>
<p>Communications have been successful. However, opening a certain page always causes a "Communication Error: Error code received" error.</p> 	<p>The error code denotes a PLC error (NAK).</p> <ol style="list-style-type: none"> <li>1) When the error code appears only on a certain screen, a memory address that does not exist on the PLC may be set on the POD screen.</li> <li>2) When the error code appears at power-on, a memory address that does not exist on the PLC may be set for communication parameters, buffering area, initial macro, etc.</li> </ol>	<ol style="list-style-type: none"> <li>1) Check if any address outside the allowable range for PLC memory is set on the screen.</li> <li>2) Check if any address outside the allowable range for PLC memory is set for communication parameters, buffering area, initial macro, etc.</li> </ol>
<p>Communications have been successful. However, "Communication Error: Parity" or "Communication Error: Framing" suddenly occurs.</p> 	<p>Noise may cause the error.</p>	<p>Check if appropriate measures are taken against noise.</p> <p>Example: Check if communication and power cables are bundled together. Try to attach a ferrite core to the communication cable. Try to attach a noise filter to the power supply, etc.</p>

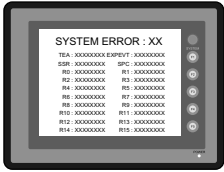
Symptom	Cause	Solution
<p>"SYSTEM ERROR: xx" occurs.</p> 	<p>The following causes are probable, depending on the symptoms.</p> <ol style="list-style-type: none"> <li>1) Turning the power off and back on corrects the error. ↓ Communication failed because of improper timing.</li> <li>2) Turning the power off and back on does not correct the error. ↓ A certain condition always causes the error. Or the POD is faulty.</li> <li>3) A CF card is inserted. ↓ The CF card (front and back) may be reversed.</li> </ol> <p>If none of the above matches your error, contact your local distributor.</p>	<ol style="list-style-type: none"> <li>1) If communication is stable after turning the power on again, continue and observe operation.</li> <li>2) Make a note of the information on error number, etc. displayed on the screen and contact your local distributor.</li> <li>3) Check that the inserted CF card faces the correct side.</li> </ol>
Switches do not work.	<ol style="list-style-type: none"> <li>1) Switches do not work in the RUN mode. A beep sounds. ↓ Is the switch interlock enabled?</li> <li>2) Switch activation position is wrong. On the "I/O Test" screen displayed from the Main Menu screen, press the [Switch Check] switch. On the touch switch test screen, a position different from the pressed position is activated. ↓ The switch activation position may be misaligned.</li> <li>3) Switches do not work even in the STOP mode. On the "I/O Test" screen displayed from the Main Menu screen, press the [Switch Check] switch. When the touch switch test screen is pressed, nowhere is activated. ↓ POD switches may be faulty.</li> </ol>	<ol style="list-style-type: none"> <li>1) Check the settings of switch functions, etc. on the editor.</li> <li>2) Perform a touch switch adjustment (page 6-14).</li> <li>3) Return the POD to your local distributor.</li> </ol>
The screen becomes dark or black.	<ol style="list-style-type: none"> <li>1) Touching the screen restores it to the previous illuminated state. ↓ The backlight operates automatically as preset.</li> <li>2) Touching the screen does not restore it. However, the POWER lamp is lit. ↓ The backlight may be at the end of its life. Or the POD may be faulty.</li> </ol>	<ol style="list-style-type: none"> <li>1) The time for turning off the backlight can be changed on the editor.</li> <li>2) Return the POD to your local distributor.</li> </ol>

Symptom	Cause	Solution
Screen data cannot be transferred.	<p>1) Screen data transfer has never succeeded. ↓ There may be some errors in the settings on the computer.</p> <p>2) Screen data transfer was possible, but is disabled now. ↓ The POD may be faulty. Or, there may be some errors in settings.</p> <p>3) Only serial transfer is successful. ↓ There may be some errors in the Ethernet or USB settings.</p>	<p>1) In the [Transfer] dialog box on the editor, decrease the baud rate by one level. Also check that the correct COM port is selected.</p> <p>2) Check if the modem connection mode is selected ("Modem Connect Mode" displayed at the bottom of the Main Menu screen denotes the mode). Also perform an RS-232C self-loop test (page 6-7).</p> <p>3) Transfer via Ethernet Check that the IP addresses set on the editor and the POD are the same. Also check if any error due to Ethernet connection occurs on the POD.</p> <p>Transfer via USB Is the USB driver recognized? Has the driver been installed successfully (page 2-21)?</p> <p>If the problem persists, contact your local distributor.</p>

# MEMO

Please use this page freely.

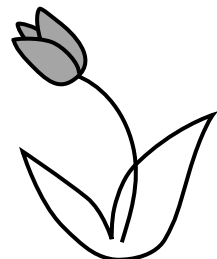



# 8

## Inspection and Maintenance

---

1. Inspection and Maintenance
2. Warranty Policy

# 1. Inspection and Maintenance

**DANGER**

Be sure to turn off the power before conducting inspection or maintenance. Failure to do so could cause an electric shock or damage to the unit.

## Daily Inspection

- Check that the screws on the POD are tightened firmly.
- Check that the connectors and terminal screws used for connection with other devices are tightened firmly.
- If the display surface or frame is dirty, wipe it with a soft cloth soaked in alcohol (commercially available).
- Conduct periodical inspection once or twice a year. The number of inspections may be increased as necessary if facilities are relocated or modified, or the environment is hot, humid, or dusty.

## Periodical Inspection

Inspect the following points periodically.

- Are the ambient temperature and humidity appropriate?  
0 to +50°C, 85%RH or less
- Are the environmental conditions appropriate?
- Does the atmosphere contain no corrosive gas?
- Is the source voltage in the allowable range?  
With AC power supply: 100 - 240 VAC  
With DC power supply: 24 VDC  $\pm$  10%
- Are the POD mounting screws tightened firmly?
- Are the connectors and terminal screws used for connection with other devices tightened firmly?
- Is the lithium primary battery within the expiry date?

## 2. Warranty Policy

---

### Inquiries about Failure

---

Please direct inquiries about failure or repair to your local distributor. Your information on the POD model, serial number, symptom of the failure, error message (if shown), etc. will be appreciated.

### Warranty Period

---

The product is under warranty for one year after the date of purchase or delivery to the specified place. On the assumption that the maximum stock period of the product after manufacture is 6 months, the warranty period is limited to 18 months (checked by the serial number) after manufacture. When a warranty period is specified in the contract, however, the period in the contract takes precedence.

### Free-of-charge Repair

---

If the product fails before the expiry of the warranty, it will be repaired free of charge. However, repair of any failure resulting from the causes below will be chargeable even within the warranty period.

- Breakage of or damage to the appearance (case or surface sheet), touch switches, LCD, or other components due to dropping, impact, or mishandling
- LCD or backlight at the end of life
- Fusion of a printed circuit board pattern associated with connection to external devices, or fusion of a pattern in the terminal block or connector section of a printed circuit board caused by short-circuiting of external load circuit
- Overvoltage or different voltage applied due to wiring mistake (power supply terminal, external communication terminal, or other terminal blocks)
- Failure caused by lightning surge
- Failure due to the entry of conductive substances, water, solvent, particles, etc. under inappropriate environmental conditions
- Failure due to inappropriate environmental conditions (e.g. corrosive gas or high humidity)
- Failure due to vibration or impact exceeding the specified level
- Disassembly and modification by the customer or failure obviously resulting from improper handling by the customer

### Chargeable Repair

---

Any failure that occurs after the expiry of the warranty or does not satisfy the requirements for the free-of-charge repair will be repaired on a chargeable basis.

---

## **Fuji Electric FA Components & Systems Co., Ltd.**

Gate City Ohsaki, East Tower,  
11-2, Osaki 1-chome, Shinagawa-ku, Tokyo 141-0032, Japan  
Phone: +81-3-5435-7135 ~ 8  
Fax: +81-3-5435-7456 ~ 9  
URL: [http : // www.fujielectric.co.jp / fcs / eng](http://www.fujielectric.co.jp/fcs/eng)

## Free Manuals Download Website

<http://myh66.com>

<http://usermanuals.us>

<http://www.somanuals.com>

<http://www.4manuals.cc>

<http://www.manual-lib.com>

<http://www.404manual.com>

<http://www.luxmanual.com>

<http://aubethermostatmanual.com>

Golf course search by state

<http://golfingnear.com>

Email search by domain

<http://emailbydomain.com>

Auto manuals search

<http://auto.somanuals.com>

TV manuals search

<http://tv.somanuals.com>