

DIGITAL CAMERA

FINEPIX XP10 series

Owner's Manual

Thank you for your purchase of this product. This manual describes how to use your FUJIFILM FinePix XP10 series digital camera and the supplied software. Be sure that you have read and understood its contents before using the camera.

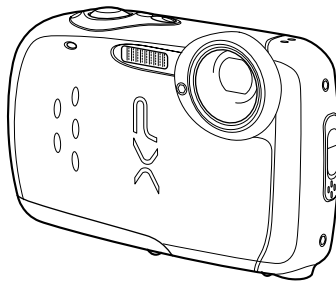

For information on related products, visit our website at
http://www.fujifilm.com/products/digital_cameras/index.html

Before You Begin

First Steps

Basic Photography and Playback

More on Photography

More on Playback

Movies

Connections

Menus

Technical Notes

Troubleshooting

Appendix



About This Manual

Before using the camera, read this Owner's Manual and the other supplied documents. For information on specific topics, consult the sources below.

✓ **Camera Q & A pg. iii**

Know what you want to do but don't know the name for it? Find the answer in "Camera Q & A."

✓ **Table of Contentspg. viii**

The "Table of Contents" gives an overview of the entire manual. The principal camera operations are listed here.

✓ **Troubleshootingpg. 93**

Having a specific problem with the camera? Find the answer here.

✓ **Warning Messages and Displayspg. 100**

Find out what's behind that flashing icon or error message in the monitor.

✓ **Glossarypg. 104**

The meanings of some technical terms may be found here.

 **Memory Cards**

Pictures can be stored in the camera's internal memory or on optional SD and SDHC memory cards. In this manual, SD memory cards are referred to as "memory cards." For more information, see page 8.

Camera Q & A

Find items by task.



Camera Setup

Question	Key phrase	See page
How do I set the camera clock?	Date and time	14
Can I set the clock to local time when I travel?	Time difference	86
How do I keep the monitor from turning off automatically?	Auto power off	89
How do I make the monitor brighter or darker?	LCD brightness	89
How do I stop the camera beeping and clicking?	Silent mode	36
	Operation volume, shutter volume	84
What are the parts of the camera called?	Parts of the camera	2
What do the icons in the monitor mean?	Monitor	3
How do I use the menus?	Menus	61
What's behind that flashing icon or error message in the monitor?	Messages and displays	100
How much charge is left in the battery?	Battery level	16

Sharing Pictures

Question	Key phrase	See page
Can I print pictures on my home printer?	Printing pictures	50
Can I copy my pictures to my computer?	Viewing pictures on a computer	55

Taking Pictures

Question	Key phrase	See page
How many pictures can I take?	Memory capacity	105
Is there a quick and easy way to take snapshots?	 mode	23
How can I make good portraits?	Intelligent Face Detection	27
Can the camera automatically select the most suitable mode?	 mode	16
Is there a simple way to adjust settings for different scenes?	Shooting mode	22
How do I shoot close-ups?	Macro mode (Close-ups)	34
How do I keep the flash from firing?	Flash mode	35
How do I stop my subjects' eyes glowing red when I use the flash?		
How do I "fill-in" shadows on back-lit subjects?		
How do I take a group portrait that includes the photographer?	Self-timer mode	37
How do I frame pictures with the subject off to one side?	Focus lock	30
How do I shoot movies?	Recording movies	45
Can I join short clips into a longer movie?	Successive movie	46

Viewing Pictures

Question	Key phrase	See page
How do I view my pictures?	Single-frame playback	40
Is there a simple way to delete one image?	Deleting pictures	21
How do I delete one or all images at once?	Erase	43
Can I zoom in on pictures during playback?	Playback zoom	41
How do I view a lot of pictures at once?	Multi-frame playback	42
Can I protect my pictures from accidental deletion?	Protect	75
Can I hide the icons in the monitor when viewing my pictures?	Choosing a display format	40
Can I view my pictures in a slide show?	Slide show	74
Can I add a short voice memo to my pictures?	Voice memo	80
Can I crop unwanted elements out of my pictures?	Crop	76
Can I make small copies of pictures?	Resize	77
How do I search for pictures?	Image search	68
How do I upload pictures or videos to my blog?	Mark for upload to	72
Can I copy pictures from internal memory to a memory card?	Copy	79
How can I process images for posting to my blog?	Edit for blog	69
Can I add effects to my movies?	Adding effects to pictures	72
How do I view my pictures on TV?	Viewing pictures on TV	49

Special Features and Important Information

Waterproof, Dustproof, Shock Resistant Performance

- The camera's waterproof and dustproof performance is equivalent to IP68.
- This camera has passed our in-house drop test (1 m [3 ft. 3 in.] fall onto a 5 cm [1.5 in.] thick plywood surface) in accordance with MIL-Standard 810F Method 516.5-Shock.

* Test conditions determined in-house. Does not guarantee the product to be free of the risks of damage, malfunction, or water damage in all conditions.

* The supplied accessories are not waterproof.

What You Should Remember Before Using the Camera

- A sheet of protective glass is located at the front of the lens. Clear photos will not be possible if this glass is dirty; always keep the protective glass clean.
- Make sure to close the battery-chamber cover securely. If water, dirt or sand gets inside the camera, malfunction may result.
- Do not open or close the battery-chamber cover on/by the sea, a lake or similar locations. Similarly, do not open or close the cover with wet hands.

- Before changing your battery or memory card, make sure that the camera and your hands are completely dry.
- The camera sinks in water. Attach the supplied strap, and keep the strap around your wrist while using the camera.

What You Should Remember When Using the Camera

- Do not use the camera in water 3 meters (9.8 feet) or deeper.
- Do not use the camera in water for more than 2 hours consecutively.
- Do not open or close the battery-chamber cover in water.
- Do not use the camera in hot water, for example in a hot spring bath.
- Do not apply excessive force to the camera. The camera may be damaged if you dive into water with it, for example.
- Do not leave the camera on sand. Not only can sand get into the speaker and microphone, but it can become extremely hot if it is exposed to direct sunlight, exceeding the camera's approved operating temperature.

- Wash sunscreen or suntan oil off the camera immediately with warm water if you accidentally spill or apply any. The oils may discolor the camera.
- Should you subject the camera to substantial vibration, shock or pressure, it may be less resistant to water. Contact the store where you purchased the camera, or our Repair Service.

What You Should Remember After Using the Camera

- Be sure to wipe any dirt or sand off the waterproof sealing material or its contacting surface. Dirt or sand may scratch the material or the surface, making the camera less resistant to water.
- To wash sand, dirt or dust off the camera, rinse it under running tap water or soak it in a bowl of fresh water for 2 or 3 minutes.
- Do not use any soapy water, mild detergents, alcohol or similar liquids to clean the camera. They may make the camera less resistant to water.
- After using the camera, wipe any water or dirt off the camera with a dry cloth, close the battery-chamber cover securely, and then soak the camera in fresh water for 10 minutes. Next, dry the camera completely.

Storage and Care

- Do not leave the camera in a location where the temperature is 40°C (104°F) or higher, or 0°C (32°F) or lower.
- The waterproof sealing material is replaceable at cost. The material should be replaced once a year to maintain the camera's water resistance. For details, contact the store where you purchased the camera, or our Repair Service.

Using the Camera in Cold Climates







When the camera is used in cold climates, battery performance and the number of pictures that can be taken are temporarily reduced. We recommend keeping the camera in a thermal case or inside clothing when using it in cold climates.

- Use the included NP-45A battery.
- The speed with which the monitor displays information is reduced in low temperatures. This is a characteristic of liquid crystal displays, and is not a malfunction.

Table of Contents

About This Manual.....	ii
Camera Q & A.....	iii
Camera Setup.....	iii
Sharing Pictures.....	iii
Taking Pictures.....	iv
Viewing Pictures.....	v
Special Features and Important Information	vi
Before You Begin	
Introduction.....	1
Symbols and Conventions.....	1
Supplied Accessories.....	1
Parts of the Camera.....	2
The Monitor.....	3
First Steps	
Charging the Battery	4
Inserting the Battery.....	6
Inserting a Memory Card	8
Turning the Camera on and Off.....	13
Shooting Mode.....	13
Playback Mode.....	13
Basic Setup	14
Basic Photography and Playback	
Taking Pictures in  (SCENE RECOGNITION) Mode	16
Viewing Pictures	21

More on Photography

 Shooting Mode.....	22
Selecting a Shooting Mode.....	22
Shooting Modes.....	23
 Intelligent Face Detection and Red-Eye Removal.....	27
Focus Lock	30
 Exposure Compensation.....	32
 Macro mode (Close-ups)	34
 Using the Flash (Intelligent Flash).....	35
 Using the Self-Timer.....	37
Setting the Self-Timer	37
COUPLE TIMER.....	37
GROUP TIMER	38
10 SEC/ 2 SEC.....	38

More on Playback

Single-Frame Playback	40
Playback Zoom.....	41
Multi-Frame Playback	42
 Deleting Pictures.....	43





Movies

























 Recording Movies.....	45
 Successive Movie	46
 Viewing Movies	48

Connections

Viewing Pictures on TV	49
Printing Pictures via USB	50
Connecting the Camera	50
Printing Selected Pictures	50
Printing the DPOF Print Order	51
Creating a DPOF Print Order	53
Viewing Pictures on a Computer	55
Installing the Software	55
Windows: Installing My FinePix Studio	55
Macintosh: Installing FinePixViewer	57
Connecting the Camera	59

Menus

The Shooting Menu	61
Using the Shooting Menu	61
Shooting Menu Options	62
ISO	63
 IMAGE SIZE	63
 IMAGE QUALITY	64
 FINEPIX COLOR	64
WB WHITE BALANCE	65
 CONTINUOUS (Continuous shooting)	65
 AF MODE	66

The Playback Menu	67
Using the Playback Menu	67
Playback Menu Options	67
 IMAGE SEARCH	68
 EDIT FOR BLOG	69
 MOVIE EDIT	72
 MARK FOR UPLOAD TO	72
 SLIDE SHOW	74
 RED EYE REMOVAL	74
 PROTECT	75
 CROP	76
 RESIZE	77
 IMAGE ROTATE	78
 COPY	79
 VOICE MEMO	80
 TRANSITION	82
 MOVIE TRIMMING	82
The Setup Menu	83
Using the Setup Menu	83
Setup Menu Options	84
 TIME DIFFERENCE	86
 FORMAT	87
 IMAGE DISP	87
 FRAME NO.	88
 ILLUMINATION	88
 SOUND	89
 PLAYBACK VOLUME	89
 LCD BRIGHTNESS	89
 LCD MODE	89
 AUTO POWER OFF	89
 DIGITAL ZOOM	90

Technical Notes

Optional Accessories	91
Accessories from Fujifilm	92

Troubleshooting

Troubleshooting	93
Warning Messages and Displays	100

Appendix

Glossary	104
Internal Memory/Memory Card Capacity	105
Specifications	106
Caring for the Camera	110
Storage and Use	110
Cleaning	110
Travelling	110
Notes and Cautions	111

Introduction

Symbols and Conventions

The following symbols are used in this manual:

 **Caution:** This information should be read before use to ensure correct operation.

 **Note:** Points to note when using the camera.

 **Tip:** Additional information that may be helpful when using the camera.

Menus and other text in the camera monitor are shown in bold. In the illustrations in this manual, the monitor display may be simplified for explanatory purposes.

Supplied Accessories

The following items are included with the camera:

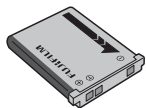

*NP-45A rechargeable
battery*

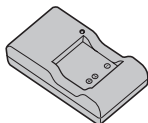

*BC-45B battery
charger*

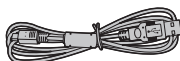

USB cable

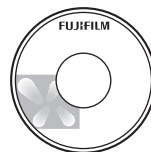

CD-ROM

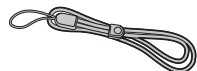

Strap

 **Attaching the Strap**
Attach the strap as shown.

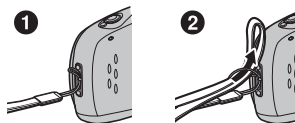

Documentation

Parts of the Camera

For more information, refer to the page listed to the right of each item.

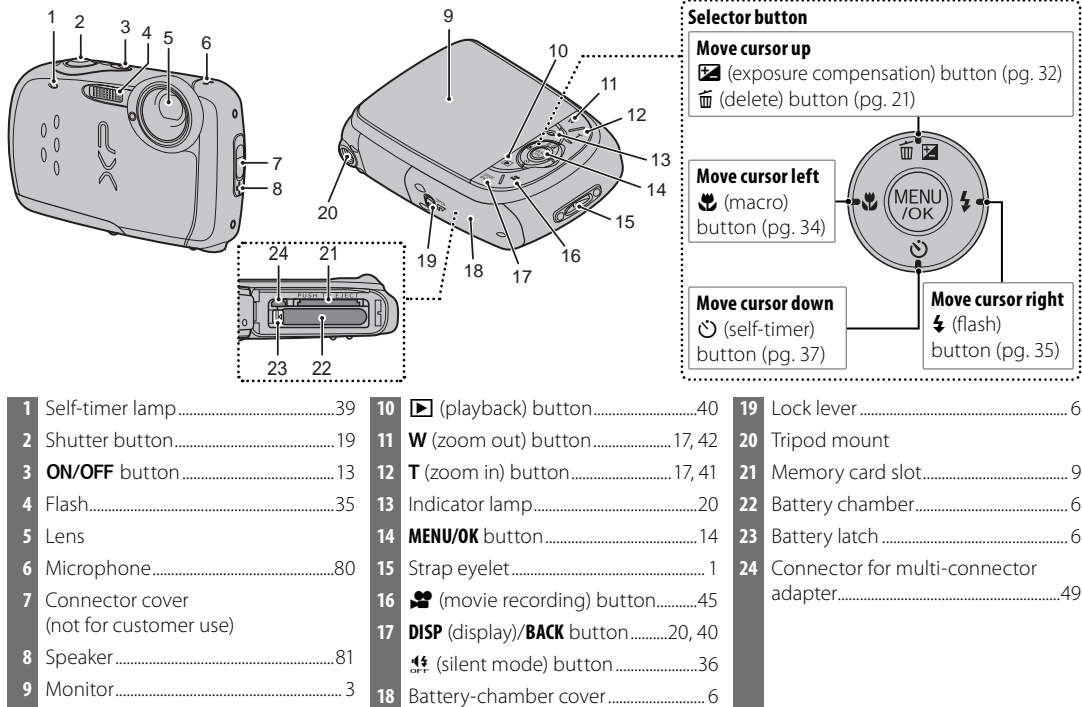

The Monitor

The following indicators may appear in the monitor during shooting and playback:

Shooting

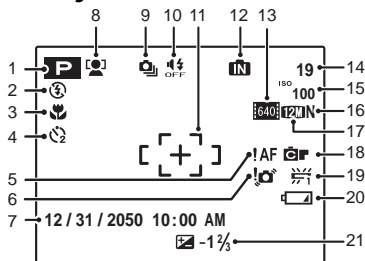

1	Shooting mode.....	22	12	Internal memory indicator*.....	8
2	Flash mode.....	35	13	Movie quality.....	45
3	Macro (close-up) mode.....	34	14	Number of available frames	105
4	Self timer indicator.....	37	15	Sensitivity.....	63
5	Focus warning.....	19	16	Image quality.....	64
6	Blur warning.....	35	17	Image size.....	63
7	Date and time.....	14	18	FINEPIX COLOR.....	64
8	Intelligent Face Detection indicator.....	27	19	White balance.....	65
9	Continuous mode.....	65	20	Battery level.....	16
10	Silent mode.....	36	21	Exposure compensation.....	32
11	Focus frame.....	19			

* Indicates that no memory card is inserted and that pictures will be stored in the camera's internal memory (pg. 8).

Playback

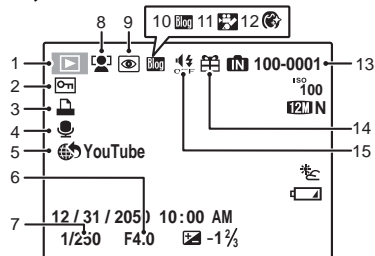

1	Playback mode indicator.....	40	9	Red-eye removal indicator.....	74
2	Protected image.....	75	10	Blog image.....	69
3	DPOF print indicator.....	51	11	Blog movie.....	72
4	Voice memo indicator.....	80	12	Portrait enhancer.....	24
5	Upload setting.....	72	13	Frame number.....	88
6	Aperture		14	Gift image.....	40
7	Shutter speed		15	Silent mode indicator.....	36
8	Intelligent Face Detection indicator.....	41			

Charging the Battery

The battery is not charged at shipment. Charge the battery before use.

Batteries

The camera uses an NP-45A rechargeable battery.

1 Place the battery in the charger.

Insert the battery into the supplied battery charger as shown, making sure that the battery is in the orientation indicated by the ⊕ ⊥ ⊖ labels.

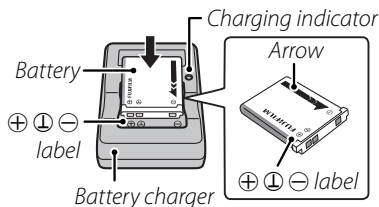

2 Plug the charger in.

Plug the charger into a power outlet. The charging indicator will light.

⚠ Cautions

- Unplug the charger when it is not in use.

- Remove dirt from the battery terminals with a clean, dry cloth. Failure to observe this precaution could prevent the battery from charging.
- Charging times increase at low temperatures.

The Charging Indicator

The charging indicator shows battery charge status as follows:

Charging indicator	Battery status	Action
Off	Battery not inserted.	Insert the battery.
On (yellow)	Battery charging.	—
On (green)	Battery fully charged.	Remove the battery.
Blinks (yellow)	Battery fault.	Unplug the charger and remove the battery.

3 Charge the battery.

Remove the battery when charging is complete.

Charging time

See specifications of the battery charger (pg. 108).

⚠ Caution: Caring for the Battery

- Do not affix stickers or other objects to the battery. Failure to observe this precaution could make it impossible to remove the battery from the camera.
- Do not short the battery terminals. The battery could overheat.
- Only use batteries designed for use with this product. Failure to observe this precaution could result in product malfunction.
- Do not remove the labels from the battery or attempt to split or peel the outer casing.
- The battery gradually loses its charge when not in use. Charge the battery one or two days before use.
- Read the supplied documentation for additional cautions concerning battery use.

⚠ Caution: Battery Life

A noticeable decrease in the length of time the battery will hold a charge indicates that it has reached the end of its service life and should be replaced.

⚠ Caution: Using the Battery Charger

- Unplug the charger when it is not in use.
- Remove dirt from the battery terminals with a clean, dry cloth. Failure to observe this precaution could prevent the battery from charging.
- Charging times increase at low temperatures.

Inserting the Battery

After charging the battery, insert it in the camera as described below.

1 Open the battery-chamber cover.

Open the battery-chamber cover as shown, sliding the lock lever in the direction of the arrow.

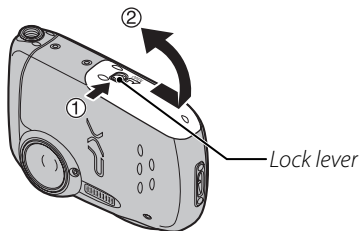

Cautions

- Do not turn the camera on or off while the battery-chamber cover is open. Failure to observe this precaution could result in damage to image files or memory cards.
- Do not use excessive force when handling the battery-chamber cover.

2 Insert the battery.

Face the gold terminals downward and align the orange stripe on the battery with the orange battery latch and slide the battery into the camera, keeping the battery latch pressed to the side. Confirm that the battery is securely latched.

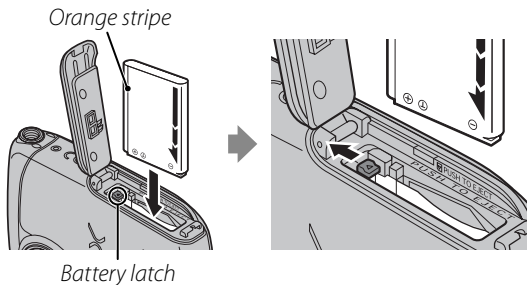
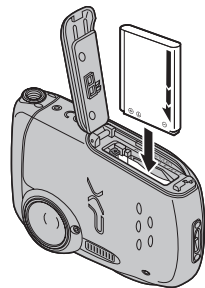

Caution

Insert the battery in the correct orientation. *Do NOT use force or attempt to insert the battery upside down or backwards.* The battery will slide in easily in the correct orientation.

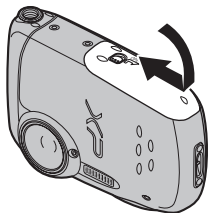
3 Close the battery-chamber cover.**Cautions**

- Water or sand may get into the camera if you fail to close the battery-chamber cover firmly.
- Do not close the battery-chamber cover with excessive force back and forth on the camera. It may scratch the waterproof sealing material, making the camera less resistant to water.

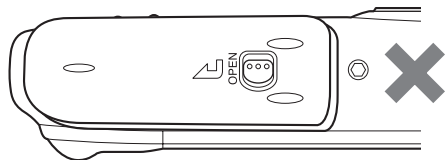
Confirmation

Is the lock lever firmly locked?

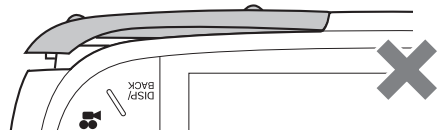

Is there no space between the cover and the body?

Removing the Battery

After turning the camera off, open the battery-chamber cover, press the battery latch to the side, and slide the battery out of the camera as shown.

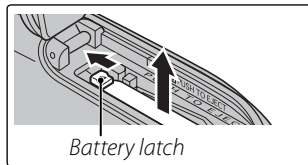

Inserting a Memory Card

Although the camera can store pictures in internal memory, SD memory cards (sold separately) can be used to store additional pictures.

When no memory card is inserted,  appears in the monitor and internal memory is used for recording and playback. Note that because camera malfunction could cause internal memory to become corrupted, the pictures in internal memory should periodically be transferred to a computer and saved on the computer hard disk or on removable media such as CDs or DVDs. The pictures in internal memory can also be copied to a memory card (see page 79). To prevent internal memory from becoming full, be sure to delete pictures when they are no longer needed.

When a memory card is inserted as described below, the card will be used for recording and playback.

■ **Compatible Memory Cards**

SanDisk SD and SDHC memory cards have been tested and approved for use in the camera. A complete list of approved memory cards is available at http://www.fujifilm.com/products/digital_cameras/index.html. Operation is not guaranteed with other cards. The camera can not be used with MultiMediaCard (MMC) or *xD-Picture* Cards.

When recording high-definition movies, use a memory card rated at Class 4 (write speed of 4 MB per second) or higher.

Caution

SD memory cards can be locked, making it impossible to format the card or to record or delete images. Before inserting an SD memory card, slide the write-protect switch to the unlocked position.

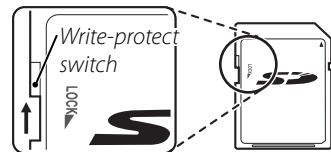

■ Inserting a Memory Card

- 1 **Open the battery-chamber cover.**
Open the battery-chamber cover as shown, sliding the lock lever in the direction of the arrow.

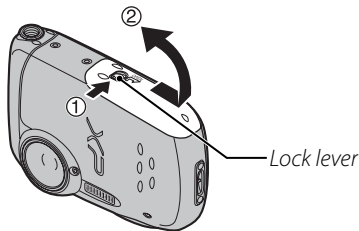

⚡ Note

Be sure the camera is off before opening the battery-chamber cover.

⚠ Cautions

- Do not turn the camera on or off while the battery-chamber cover is open. Failure to observe this precaution could result in damage to image files or memory cards.
- Do not use excessive force when handling the battery-chamber cover.

- 2 **Insert the memory card.**
Holding the memory card in the orientation shown below, slide it all the way in. Press firmly until it clicks into place.

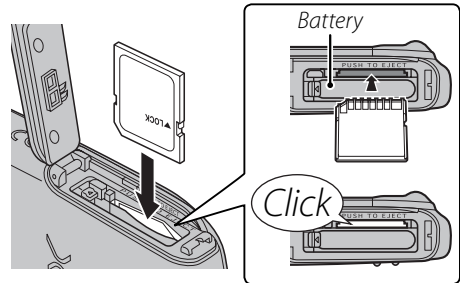

- Be sure card is at correct orientation; do not insert at an angle or use force. If the memory card is not inserted correctly, images

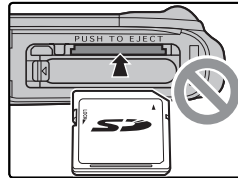

- will be saved in the internal memory (📷 will be displayed) instead of on the memory card.
- If the battery-chamber cover cannot be closed, do not attempt to close it with excessive force, check that the card is correctly orientated.

3 Close the battery-chamber cover.

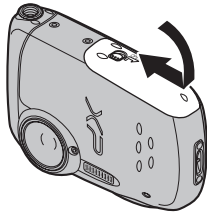

⚠ Cautions

- Water or sand may get into the camera if you fail to close the battery-chamber cover firmly.
- Do not close the battery-chamber cover with excessive force back and forth on the camera. It may scratch the waterproof sealing material, making the camera less resistant to water.

● Confirmation

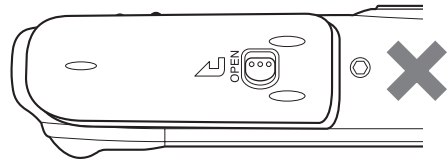

Is the lock lever firmly locked?

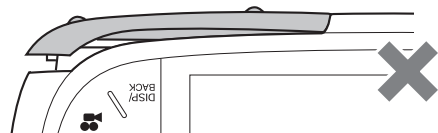

Is there no space between the cover and the body?

Removing Memory Cards

Be sure the camera is off before opening the battery-chamber cover. Press the card in and then release it slowly. The card can now be removed by hand.

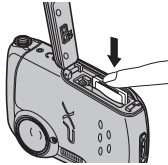

Cautions

- The memory card may spring out if you remove your finger immediately after pushing the card in.
- Memory cards may be warm to the touch after being removed from the camera. This is normal and does not indicate a malfunction.

Cautions

- Format SD memory cards before first use, and be sure to reformat all memory cards after using them in a computer or other device. For more information on formatting memory cards, see page 87.
- Memory cards are small and can be swallowed; keep out of reach of children. If a child swallows a memory card, seek medical assistance immediately.
- Do not use miniSD or microSD adapters that expose the back of the card. Failure to observe this precaution may cause damage or malfunction. Adapters that are larger or smaller than the standard dimensions of an SD card may not eject normally; if the card does not eject, take the camera to an authorized service representative. Do not forcibly remove the card.
- Do not turn the camera off or remove the memory card while the memory card is being formatted or data are being recorded to or deleted from the card. Failure to observe this precaution could damage the card.
- Do not affix labels to memory cards. Peeling labels can cause camera malfunction.
- Movie recording may be interrupted with some types of SD memory card.

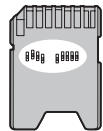

- The data in internal memory may be erased or corrupted when the camera is repaired. Please note that the repairer will be able to view pictures in internal memory.
- Formatting a memory card or internal memory in the camera creates a folder in which pictures are stored. Do not rename or delete this folder or use a computer or other device to edit, delete, or rename image files. Always use the camera to delete pictures from memory cards and internal memory; before editing or renaming files, copy them to a computer and edit or rename the copies, not the originals.

Turning the Camera on and Off

Shooting Mode

Press the **ON/OFF** button to turn the camera on.
Press **ON/OFF** again to turn the camera off.

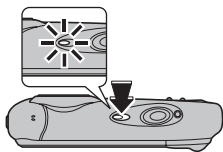

Tip: Switching to Playback Mode

Press the  button to start playback. Press the shutter button halfway to return to shooting mode.

Cautions

- Pictures can be affected by fingerprints and other marks on the lens. Keep the lens clean.
- The **ON/OFF** button does not completely disconnect the camera from its power supply.

Tip: Auto Power Off

The camera will turn off automatically if no operations are performed for the length of time selected in the **AUTO POWER OFF** menu (see page 89).

Playback Mode

To turn the camera on and begin playback, press the  button for about a second.

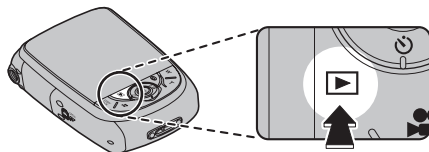

Press the  button again to turn the camera off.

Tip: Switching to Shooting Mode

To exit to shooting mode, press the shutter button halfway. Press the  button to return to playback.

Basic Setup

A language-selection dialog is displayed the first time the camera is turned on. Set up the camera as described below (for information on resetting the clock or changing languages, see page 83).

1 Choose a language.

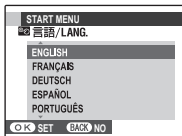

1.1 Press the selector up, down, left, or right to highlight a language.



1.2 Press **MENU/OK**.



2 Set the date and time.

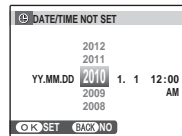

2.1 Press the selector left or right to highlight the year, month, day, hour, or minute and press up or down to change.



To change the order in which the year, month, and day are displayed, highlight the date format and press the selector up or down.

2.2 Press **MENU/OK**.



← Note

You can change the language or date and time setting later in the setup menu (pg. 83).

📖 Tips: The Camera Clock

- If the battery is removed for an extended period, the camera clock will be reset and the language-selection dialog will be displayed when the camera is turned on.
- If the battery is left in the camera for about 24 hours, the battery can be removed for about 24 hours without resetting the clock, language selection, or power management options.

Taking Pictures in ^{SR}_{AUTO} (SCENE RECOGNITION) Mode

This section describes how to take pictures in **SCENE RECOGNITION** mode.

- 1 Turn the camera on.**
Press the **ON/OFF** button to turn the camera on.

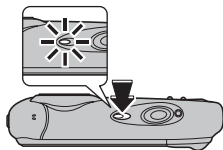

SCENE RECOGNITION Mode

By simply aiming the camera at the subject, the camera determines the shooting conditions and selects the optimal settings.

- 2 Check the battery level.**
Check the battery level in the monitor.

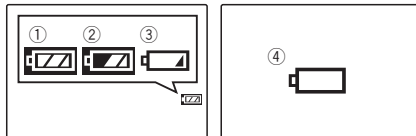

Indicator	Description
① (white)	Battery partially discharged.
② (white)	Battery more than half discharged.
③ (red)	Low battery. Charge as soon as possible.
④ (blinks red)	Battery exhausted. Turn camera off and charge battery.

3 Frame the picture.

Position the main subject in the focus area and use the zoom buttons to frame the picture in the monitor.

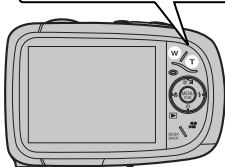
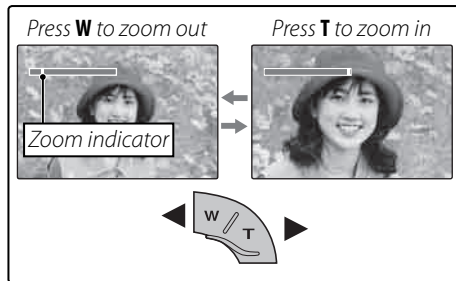

Holding the Camera

Hold the camera steady with both hands and brace your elbows against your sides. Shaking or unsteady hands can blur your shots.

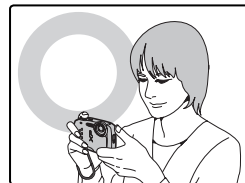

To prevent pictures that are out of focus or too dark (underexposed), keep your fingers and other objects away from the lens and flash.

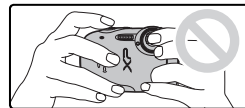







Tip: Focus Lock

Use focus lock (pg. 30) to focus on subjects that are not in the focus frame.

Simply by pointing the camera at the subject, the camera automatically analyzes and selects the most appropriate setting using scene recognition.



The camera analyzes a subject based on scene recognition, then an icon appears in the bottom left of the monitor. (The illustration shows camera analysis of a portrait subject.)

Subject	Icon	Description
PORTRAIT		For soft-toned portraits with natural skin tones.
LANDSCAPE		For crisp, clear daylight shots of buildings and landscapes.
NIGHT		For night and twilight scenes, using a high sensitivity setting to minimize blurring.
MACRO		For clear close-ups of flowers, etc.
BACKLIT PORTRAIT		For a subject backlit against the sun, preventing the background from becoming dim.
NIGHT PORTRAIT		For a subject in a dim place, reducing blur.

Tip

When a subject can not be analyzed by the camera,  **AUTO** mode will be set.

Notes

-  Intelligent Face Detection is turned on automatically.
- The camera continuously adjusts focus on a face, or the center area of the monitor.
- Continuous auto focus will be audible and battery drain will increase.

4 Focus.

Press the shutter button halfway to focus on the subject.

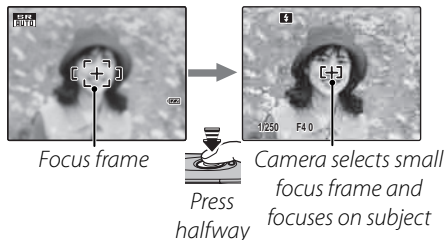

If the camera is able to focus, it will beep twice and the indicator lamp (pg. 20) will glow green.

If the camera is unable to focus, the focus frame will turn red, **!AF** will be displayed, and the indicator lamp will blink green. Change the composition or use focus lock (pg. 30).

← Note

The lens may make a noise when the camera focuses. This is normal.

5 Shoot.

Smoothly press the shutter button the rest of the way down to take the picture.

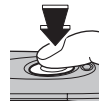

Tip: The Shutter Button

The shutter button has two positions. Pressing the shutter button halfway sets focus and exposure; to shoot, press the shutter button the rest of the way down.

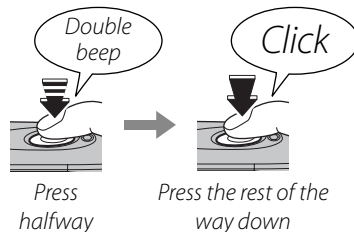

← Note

If the subject is poorly lit, the flash may fire when the picture is taken. To take pictures without the flash, choose another flash mode (pg. 35).

The Indicator Lamp

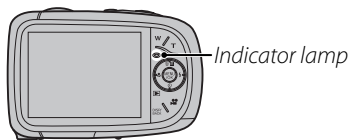

The indicator lamp shows camera status as follows:

Indicator lamp	Camera status
Glowes green	Focus locked.
Blinks green	Blur, focus, or exposure warning. Picture can be taken.
Blinks green and orange	Recording pictures. Additional pictures can be taken.
Glowes orange	Recording pictures. No additional pictures can be taken at this time.
Blinks orange	Flash charging; flash will not fire when picture is taken.
Blinks red	Lens or memory error (internal memory or memory card full or not formatted, format error, or other memory error).

Tip: Warnings

Detailed warnings appear in the display. See pg. 100 for more information.

The Framing Grid

To display best framing (the framing grid) or to view or hide other indicators in the monitor, press the **DISP/BACK** button.

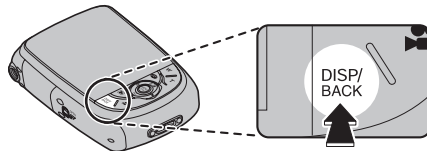

Indicators displayed



Indicators hidden



Best framing

To use best framing, position the main subject at the intersection of two lines or align one of the horizontal lines with the horizon. Use focus lock (pg. 30) to focus on subjects that will not be in the center of the frame in the final photograph.

Viewing Pictures

Pictures can be viewed in the monitor. When taking important photographs, take a test shot and check the results.

- 1 Press the  button.

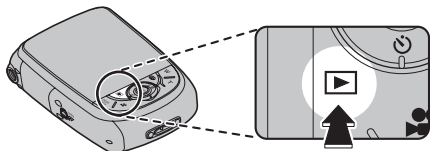

The most recent picture will be displayed in the monitor.



- 2 View additional pictures.

Press the selector right to view pictures in the order recorded, left to view pictures in reverse order.

Press the shutter button to exit to shooting mode.



Deleting Pictures

To delete the picture currently displayed in the monitor, press the selector up (). The following dialog will be displayed.

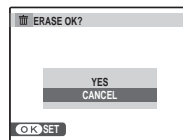
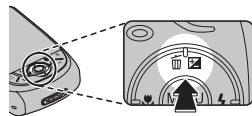

To delete the picture, press the selector up to highlight **YES** and press **MENU/OK**. To exit without deleting the picture, highlight **CANCEL** and press **MENU/OK**.



Tip: The Playback Menu

Pictures can also be deleted from the playback menu (pg. 43).

Shooting Mode

Choose a shooting mode according to the scene or type of subject.

Selecting a Shooting Mode

- 1 Press **MENU/OK** to display the shooting menu.

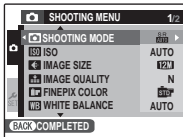

- 2 Press the selector up or down to highlight  **SHOOTING MODE**.



- 3 Press the selector right to display shooting mode options.

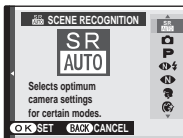

- 4 Press the selector up or down to highlight the desired mode.



- 5 Press **MENU/OK** to select the highlighted option.



Digital IS

If the subject is poorly lit, blurring caused by camera shake can be reduced by activating the  **DIGITAL IS** (pg. 84). Note that blurring may still occur depending on the scene or shooting conditions.

Shooting Modes

SCENE RECOGNITION

Simply by pointing the camera at the subject, the camera automatically analyzes and selects the most appropriate setting using scene recognition.

For more information, see “Taking Pictures in  (SCENE RECOGNITION) Mode” (pg. 16).

AUTO

Choose for crisp, clear snapshot. This mode is recommended in most situations.

P PROGRAM AE

Choose this mode for complete control of shooting settings, including exposure compensation (pg. 32), white balance (pg. 65), and AF mode (pg. 66).

NATURAL & (Dual Shot Mode)

This mode helps ensure good results with backlit subjects and in other situations with difficult lighting. Each time the shutter button is pressed, the camera takes two shots: one shot without the flash to preserve natural lighting, followed immediately by a second shot with the flash. Do not move the camera until shooting is complete.

Notes

- Do not use where flash photography is prohibited. The flash fires even in silent mode (pg. 36).
- Only available if memory remains for two pictures.
- Continuous shooting is not available.

NATURAL LIGHT

Capture natural light indoors, under low light, or where the flash can not be used. The flash turns off and sensitivity is raised to reduce blur.

PORTRAIT

Choose this mode for soft-toned portraits with natural skin tones.

PORTRAIT ENHANCER

Choose for a smooth skin effect in soft-focus portraits.

LANDSCAPE

Choose this mode for crisp, clear daylight shots of buildings and landscapes.

SPORT

Choose this mode when photographing moving subjects. Priority is given to faster shutter speeds.

NIGHT

A high sensitivity setting is selected automatically to minimize blurring for recording night and twilight scenes.

NIGHT (TRIPOD)

Slow shutter speeds are used to record night scenes. Use of a tripod is recommended to prevent camera shake.

SUNSET

Choose this mode to record the vivid colors in sunrises and sunsets.

 SNOW

Choose for crisp, clear shots that capture the brightness of scenes dominated by shining white snow.

 BEACH

Choose for crisp, clear shots that capture the brightness of sunlit beaches.

 UNDERWATER

Choose when shooting underwater or at an aquarium. Can be used when recording movies.

 PARTY

Capture indoor background lighting under low-light conditions.

*** FLOWER**

Choose for vivid close-ups of flowers. The camera focuses in the macro range and the flash turns off automatically.

 TEXT

Take clear pictures of text or drawings in print. The camera focuses in the macro range.

AUCTION MODE

Choose this mode to combine up to four consecutive shots in a single image 640×480 pixels in size (**03M**). This can be used to record an object from different angles when posting pictures to a web auction. To take pictures in auction mode:

1 Select  **AUCTION MODE**.

2 Press the selector up to display the following layout options:



3 Press the selector left or right to highlight an option.



4 Press **MENU/OK** to select the highlighted option.



5 Take a picture. The picture will appear in the first frame in layout.



6 Press **MENU/OK** to proceed to the next picture. Repeat steps 5 and 6 until all the frames are filled.



SUCCESSIVE MOVIE

Join a series of movie clips into a single movie (pp. 46–47).

Intelligent Face Detection and Red-Eye Removal

Intelligent Face Detection allows the camera to automatically detect human faces and set focus and exposure for a face anywhere in the frame for shots that emphasize portrait subjects. Choose for group portraits to prevent the camera from focusing on the background. Intelligent Face Detection also offers a red-eye removal option for removing “red-eye” effects caused by the flash.

1 Turn Intelligent Face Detection on.

- 1.1 Press **MENU/OK** to display the shooting menu.

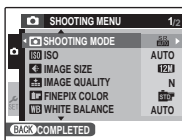

- 1.2 Press the selector up or down to highlight  **FACE DETECTION**.



- 1.3 Press the selector right to display Intelligent Face Detection options.



- 1.4 Press the selector up or down to highlight the desired option.



Option	Description
OFF	Intelligent Face Detection off.
ON	Intelligent Face Detection on.

- 1.5 Press **MENU/OK** to select the highlighted option and return to shooting mode.



A  icon appears in the monitor when Intelligent Face Detection is on.



Note

When removing red-eye effect, select **ON** for  **RED EYE REMOVAL** in the setup menu (pg. 84).

2 Frame the picture.

If a face is detected, it will be indicated by a green border. If there is more than one face in the frame, the camera will select the face closest to the center; other faces are indicated by white borders.



Green border

3 Focus.

Press the shutter button halfway to set focus and exposure for the subject in the green border.



4 Shoot.

Press the shutter button all the way down to shoot.



Intelligent Face Detection

Intelligent Face Detection is recommended when using the self-timer for group portraits or self-portraits (pg. 37).



When a picture taken with Intelligent Face Detection is displayed, the camera can automatically select faces for image search (pg. 68), slide shows (pg. 74), cropping (pg. 76), red-eye removal (pg. 74), printing (pg. 51), and zoom (continuous) (pg. 87).

Cautions

- If no face is detected when the shutter-release button is pressed halfway (pg. 95), the camera will focus on the subject at the center of the monitor and red-eye will not be removed. If the camera is unable to detect a face, turn Intelligent Face Detection off and use focus lock (pg. 30).
- If the subject moves as the shutter button is pressed, their face may not be in the area indicated by the green border when the picture is taken.
- In each shooting mode, the camera will detect and focus on faces but exposure will be optimized for the entire scene rather than the selected portrait subject.

Tip: Red-Eye Removal

Select **ON** for the  **SAVE ORG IMAGE** option in the setup menu (pg. 85) to save unprocessed copies of pictures created with red-eye removal.

Focus Lock

To compose photographs with off-center subjects:

1 Position the subject in the focus frame.



2 Focus.

Press the shutter button halfway to set focus and exposure. Focus and exposure will remain locked while the shutter button is pressed halfway (AF/AE lock).



*Press
halfway*



Repeat steps 1 and 2 as desired to refocus before taking the picture.

3 Recompose the picture.

Keeping the shutter button pressed halfway, recompose the picture.



4 Shoot.

Press the shutter-release button the rest of the way down to take the picture.



*Press the rest of
the way down*

Autofocus

Although the camera boasts a high-precision autofocus system, it may be unable to focus on the subjects listed below. If the camera is unable to focus using autofocus, use focus lock (pg. 30) to focus on another subject at the same distance and then recompose the photograph.

- Very shiny subjects such as mirrors or car bodies.
- Fast-moving subjects.
- Subjects photographed through a window or other reflective object.
- Dark subjects and subjects that absorb rather than reflect light, such as hair or fur.
- Insubstantial subjects, such as smoke or flame.
- Subjects that show little contrast with the background (for example, subjects in clothing that is the same color as the background).
- Subjects positioned in front of or behind a high-contrast object that is also in the focus frame (for example, a subject photographed against a backdrop of highly contrasting elements).

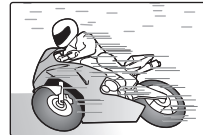

Exposure Compensation

Use exposure compensation when photographing very bright, very dark, or high-contrast subjects.

- 1 Press  (exposure compensation).
The exposure indicator will be displayed.

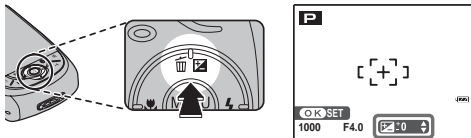

- 2 Choose a value.
Press the selector button. The effect is visible in the display.

*Choose positive (+) values
to increase exposure*



*Choose negative (-) values
to reduce exposure*



- 3 Return to shooting mode.
Press **MENU/OK** to return to shooting mode.



- 4 Take pictures.

Note

A  icon and exposure indicator are displayed at settings other than ± 0 . Exposure compensation is not reset when the camera is turned off; to restore normal exposure control, choose a value of ± 0 .

Choosing an Exposure Compensation Value

- **Backlit subjects:** choose values from $+2/3$ EV to $+12/3$ EV (for an explanation of the term “EV”, see the Glossary on page 104)
- **Highly reflective subjects or very bright scenes** (e.g., snowfields): +1 EV
- **Scenes that are mostly sky:** +1 EV
- **Spotlit subjects** (particularly if photographed against dark backgrounds): $-2/3$ EV
- **Subjects with low reflectivity** (pine trees or dark-colored foliage): $-2/3$ EV



Macro mode (Close-ups)

To select macro mode, press the selector left ()

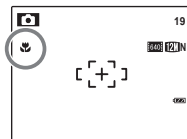
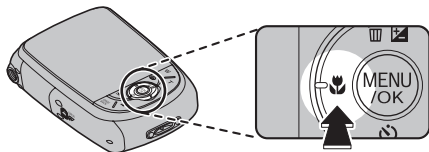

 icon appears in monitor when camera is in macro mode

When macro mode is in effect, the camera focuses on subjects near the center of the monitor. Use the zoom buttons to frame pictures.

Note

Use of a tripod is recommended to prevent blur caused by camera shake.

⚡ Using the Flash (Intelligent Flash)

When the flash is used, the camera's *Intelligent Flash* system instantly analyzes the scene based on such factors as the brightness of the subject, its position in the frame, and its distance from the camera. Flash output and sensitivity are adjusted to ensure that the main subject is correctly exposed while preserving the effects of ambient background lighting, even in dimly-lit indoor scenes. Use the flash when lighting is poor, for example when shooting at night or indoors under low light.

To choose a flash mode, press the selector right (⚡). In modes other than AUTO, the current mode is indicated by an icon in the monitor. Choose from the following options (some options are not available in all shooting modes):

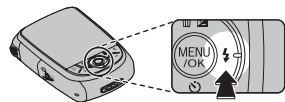

Mode	Description
AUTO (no icon)	The flash fires when required. Recommended in most situations.
⚡ (fill flash)	The flash fires whenever a picture is taken. Use for backlit subjects or for natural coloration when shooting in bright light.
Ⓜ (suppressed flash)	The flash does not fire even when the subject is poorly lit. will appear in the monitor at slow shutter speeds to warn that pictures may be blurred. Use of a tripod is recommended.
Ⓜ⚡ (slow sync)	Capture both the main subject and the background when shooting at night (note that brightly lit scenes may be overexposed). If * is selected for SHOOTING MODE , shutter speed may be slow. Use a tripod.

Caution

The flash may fire several times with each shot. Do not move the camera until shooting is complete.

●● Red-Eye Removal

If intelligent face detection is selected in the shooting menu (pg. 27) while  **RED EYE REMOVAL** is set to **ON** in the setup menu (pg. 84), red-eye removal is used for pictures taken when the flash fires. Red-eye removal minimizes “red-eye” caused when light from the flash is reflected from the subject’s retinas as shown in the illustration at right.



●● Silent Mode

Silent mode is useful in situations in which camera sounds or the light of the flash may be unwelcome. To turn silent mode on, press and hold the **DISP/BACK** button until  is displayed, or change the setting in the setup menu (pg. 84).

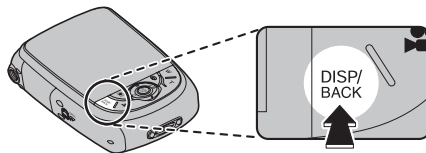

While silent mode is turned on, the flash does not fire (except when using  mode), operation sounds and the shutter sound are not heard, the sound is muted when playing back movies or voice memos, and the self-timer lamp and shooting indicator do not light.

-  is displayed while silent mode is turned on.
- Press and hold the **DISP/BACK** button to turn silent mode off.
- Flash, operation sounds (pg. 84), shutter sound (pg. 84), and playback volume (pg. 89) settings cannot be changed while silent mode is turned on.
- Silent mode cannot be turned on or off while playing back movies or voice memos.

🕒 Using the Self-Timer

The camera offers four types of self-timer mode, which enable group portraits, self-portraits and reduction of camera shake.

Setting the Self-Timer

To change the self-timer mode, press 🕒.

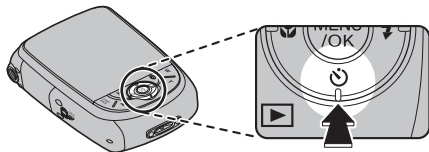

COUPLE TIMER

The picture is taken automatically when 2 faces come close together.

Set the self-timer mode to 🕒 **COUPLE TIMER**.

Press ▲. Each time ▲ is pressed, the setting for ❤️ **DISTANCE** changes.



❤️ : **NEAR**
❤️❤️ : **CLOSE UP**
❤️❤️❤️ : **SUPER CLOSE**

The more ❤️ icons, the closer the 2 faces must be when taking a picture.





As the 2 faces come closer and the ❤️ indicator(s) becomes full, countdown starts. Then the picture is automatically taken.

📖 **Tips**

- Pressing **DISP/BACK** cancels 🕒 **COUPLE TIMER**.
- Set Macro mode (close-up) when taking a self portrait by holding the camera.

GROUP TIMER

The picture is taken automatically when all members get together.

Set the self-timer mode to  **GROUP TIMER**. Press . Each time  is pressed, the setting for  **NUMBERS** changes.

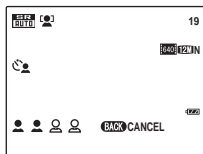



Available setting for Group timer is 1 to 4 persons.

When the camera recognizes the set number of persons and the  indicator(s) becomes full, countdown starts. Then the picture is automatically taken.

Tips

- Pressing **DISP/BACK** cancels  **GROUP TIMER**.
- Set Macro mode (close-up) when taking a self portrait by holding the camera.

10 SEC/2 SEC

Set the self-timer mode to  **10 SEC** or  **2 SEC**.

1 Focus.

Press the shutter button halfway to focus.



Caution

Stand behind the camera when using the shutter button. Standing in front of the lens can interfere with focus and exposure.

2 Start the timer.

Press the shutter button the rest of the way down to start the timer. The display in the monitor shows the number of seconds remaining until the shutter is released. To stop the timer before the picture is taken, press **DISP/BACK**.

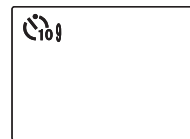

The self-timer lamp on the front of the camera will blink immediately before the picture is taken. If the two-second timer is selected, the self-timer lamp will blink as the timer counts down.

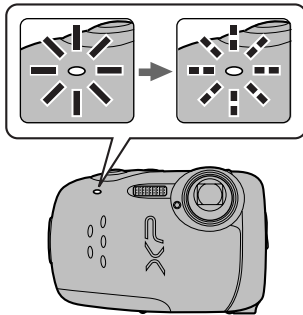

Intelligent Face Detection

Because it ensures that the faces of portrait subjects will be in focus, Intelligent Face Detection (pg. 27) is recommended when using the self-timer for group portraits or self-portraits. To use the self-timer with Intelligent Face Detection, set the timer as described in Step 1 and then press the shutter button all the way down to start the timer. The camera will detect faces while the timer is counting down and adjust focus and exposure immediately before the shutter is released. Be careful not to move until the picture has been recorded.

Single-Frame Playback

To view the most recent picture in the monitor, press the  button.

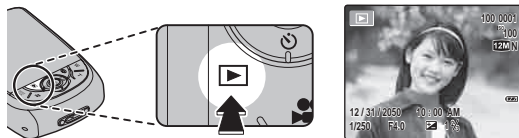

Press the selector right to view pictures in the order recorded, left to view pictures in reverse order. Keep the selector pressed to scroll rapidly to the desired frame.



Choosing a Display Format

Press the **DISP/BACK** button to turn playback indicators on and off.

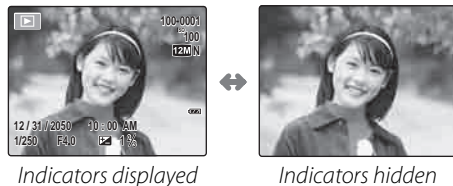
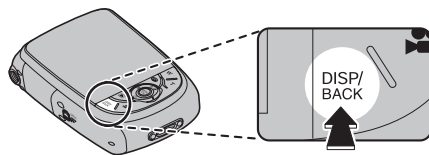

Image search

You can use the image search feature to search for pictures based on a variety of search criteria. See **IMAGE SEARCH** (pg. 68) for more information.

Note

Pictures taken using other cameras are indicated by a  ("gift image") icon during playback.

Playback Zoom

Press **T** to zoom in on images displayed in single-frame playback; press **W** to zoom out.

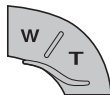

Press **W** to zoom out

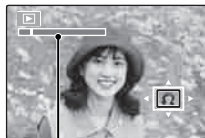

Zoom indicator

Press **T** to zoom in



When the picture is zoomed in, the selector can be used to view areas of the image not currently visible in the display.



Navigation window shows portion of image currently displayed in monitor

Press **DISP/BACK** to exit zoom.

Note

The maximum zoom ratio varies with image size. Playback zoom is not available with pictures taken in mode or at an image size of **03M**, or **Blog** blog images.

Intelligent Face Detection

If the current picture was taken using Intelligent Face Detection (pg. 27), will appear in the monitor. Press the button to cycle through the subjects detected by Intelligent Face Detection, or use the **W** and **T** buttons to zoom the current subject in and out as described above.



Multi-Frame Playback

To change the number of images displayed, press **W** when a picture is shown full-frame in the monitor.

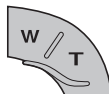

Press the **W** button to increase the number of pictures displayed to two, nine, or a hundred.

Press **T** to reduce the number of images displayed.

Use the selector to highlight images and press **MENU/OK** to view the highlighted image full frame. In the nine- and hundred-frame displays, press the selector up or down to view more pictures.

Tip: Two-Frame Display

Two-frame display can be used to compare pictures taken in **NATURAL &** (dual shot) mode.

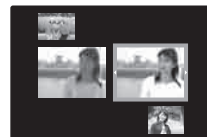

Deleting Pictures

The **ERASE** option in the playback menu can be used to delete still pictures and movies, increasing the amount of space available on the memory card or in internal memory (for information on deleting pictures in single-frame playback, see page 21). *Note that deleted pictures can not be recovered. Copy important pictures to a computer or other storage device before proceeding.*

- 1 Press **MENU/OK** to display the playback menu.

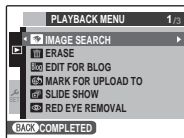

- 2 Press the selector up or down to highlight  **ERASE**.

- 3 Press the selector right to display delete options.



- 4 Press the selector up or down to highlight **FRAME** or **ALL FRAMES**.



- 5 Press **MENU/OK** to display options for the selected item (see pg. 44).



Tips: Deleting Pictures

- When a memory card is inserted, pictures will be deleted from the memory card; otherwise, pictures will be deleted from internal memory.
- Protected pictures can not be deleted. Remove protection from any pictures you wish to delete (pg. 75).
- If a message appears stating that the selected images are part of a DPOF print order, press **MENU/OK** to delete the pictures.



■ FRAME: *Deleting Selected Images*

Selecting **FRAME** displays the dialog shown at right.

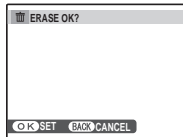

Press the selector left or right to scroll through pictures and press **MENU/OK** to delete the current picture (the picture is deleted immediately; be careful not to delete the wrong picture).



Press **DISP/BACK** to exit when all the desired pictures have been deleted.

■ ALL FRAMES: *Deleting All Images*

Selecting **ALL FRAMES** displays the confirmation shown at right.

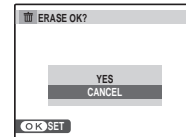

Press **MENU/OK** to delete all unprotected pictures.



The dialog shown at right is displayed during deletion. Press **DISP/BACK** to cancel before all pictures have been deleted (any pictures deleted before the button was pressed can not be recovered).

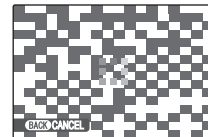

Recording Movies

The  button can be used to shoot short movies in all shooting modes except . Sound is recorded via the built-in microphone; do not cover the microphone during recording.

- 1 Frame the scene using the zoom buttons.

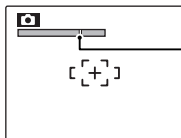
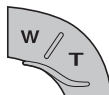

Zoom indicator

Optical zoom can not be adjusted once recording begins.

Choosing the Frame Size

To choose the frame size, press **MENU/OK** and select

MOVIE QUALITY.

Choose **HD: 1280** (1280×720 pixels) for high-definition movies, **640** (640×480 pixels) for standard quality, **320** (320×240 pixels) for longer movies. Press **MENU/OK** to return to movie recording mode.

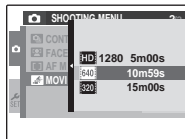

- 2 Press the  button to start recording.

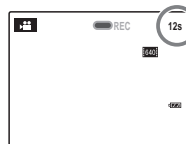

REC
and time
remaining are
displayed in
monitor

- 3 Press the  button again to end recording. Recording ends automatically when the movie reaches maximum length or memory is full.



← Notes

- See below for information on recording movies in  mode.
- Focus is set when recording begins; exposure and white balance are adjusted automatically throughout recording. The color and brightness of the image may vary from that displayed before recording begins.
- Any sound that the camera makes while recording a movie may be heard when playing back the movie.
- If the subject is too bright, horizontal or vertical lines may be seen when playing back the movie. This is not a malfunction.

Successive Movie

Join a series of movies into one movie (up to 60 seconds long).

- 1 While using shooting mode (pg. 22), select  **SUCCESSIVE MOVIE** and press **MENU/OK**.
- 2 Press **DISP/BACK** to turn successive movie mode on and off.

- 3 Press the  button to begin recording a clip.

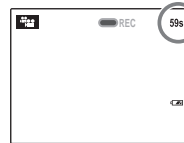

REC and time remaining are displayed in monitor. Time remaining displayed in yellow if less than 5s remain.

← Note

If a clip reaches maximum length, shooting will end and the clips recorded to that point will be joined together into a single movie.

- 4 Press the  button again to end the clip. Repeat steps 3 and 4 to record additional clips. To pause, press **MENU/OK**.



Do not insert or remove memory cards while recording is paused. While recording is paused, the camera can be turned off or other modes selected. Recording can be resumed as described below.

Tip: Previewing the Most Recent Clip

When a clip is completed, the first frame appears in the monitor. To preview the clip, press the selector up. Press **DISP/BACK** to re-record the last clip.

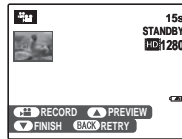

- 5 Press **▼** to display the confirmation message, select **OK**, then press **MENU/OK** to end recording and join the clips together.



Resuming Recording

To resume a paused successive movie, select **SUCCESSIVE MOVIE** for **SHOOTING MODE** and highlight **CONTINUE**. Press **MENU/OK** and continue recording as described in steps 2–5.

Tip: During Recording

When recording is resumed, the three most recent clips are shown in the monitor, with the most recent clip at the top.

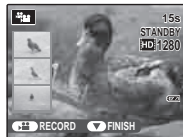

▶ Viewing Movies

During playback (pg. 40), movies are displayed in the monitor as shown at right. The following operations can be performed while a movie is displayed:

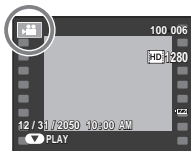

Operation	Description
Start/pause playback	Press the selector down to start playback. Press again to pause.
End playback/delete	Press the selector up to end playback. If playback is not in progress, pressing the selector up will delete the current movie.
Advance/rewind	Press the selector right to advance, left to rewind. If playback is paused, the movie will advance or rewind one frame each time the selector is pressed.
Adjust volume	Press MENU/OK to pause playback and display volume controls. Press the selector up or down to adjust the volume; press MENU/OK again to set the volume.

Progress is shown in the monitor during playback.

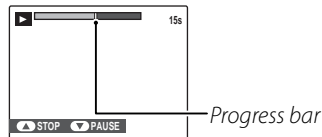

Tip: Viewing Movies on a Computer

Copy movies to the computer before viewing.

Note

Fast forward and rewind are not available.

Cautions

Do not cover the speaker during playback.

Viewing Pictures on TV

Connect the camera to a TV and tune the television to the video channel to show pictures and slide shows (pg. 74) to a group.

- 1 Press the  for about a second to turn the camera on.
- 2 Open the battery-chamber cover.
- 3 Connect an A/V cable (optional), as shown below.

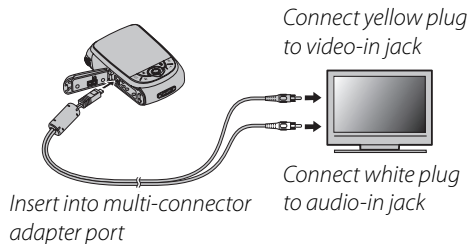

- 4 Tune the television to the video channel. The camera monitor turns off and pictures, voice memos, and movies are played back on the TV. Note that the camera volume controls have no effect on sounds through the TV; use the television volume controls to adjust the volume.

Note

Image quality deteriorates slightly during movie playback.

Cautions

- When making the A/V cable connection, be sure the connectors are fully inserted.
- If the optional A/V cable is used to connect the camera to the TV, high-definition movies will be displayed in standard definition.
- An optional video cable is required to view high-definition movies on a high-definition TV. For more information, refer to: http://www.fujifilm.com/products/digital_cameras/index.html.

Printing Pictures via USB

If the printer supports PictBridge, the camera can be connected directly to a printer and pictures can be printed without first being copied to a computer. Note that depending on the printer, not all the functions described below may be supported.



Connecting the Camera

- 1 Press the for about a second to turn the camera on.
- 2 Open the battery-chamber cover.
- 3 Connect the supplied USB cable as shown and turn the printer on.

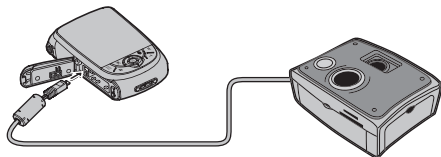

USB will be displayed in the monitor, followed by the PictBridge display shown below at right.

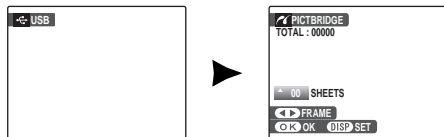

Printing Selected Pictures

- 1 Press the selector left or right to display a picture you wish to print.
- 2 Press the selector up or down to choose the number of copies (up to 99).
- 3 Repeat steps 1–2 to select additional pictures. Press **MENU/OK** to display a confirmation dialog when settings are complete.

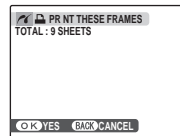

- 4 Press **MENU/OK** to start printing.



Tip: Printing the Date of Recording

To print the date of recording on pictures, press **DISP/BACK** in steps 1–2 to display the PictBridge menu (see “Printing the DPOF Print Order,” below). Press the selector up or down to highlight **PRINT WITH DATE**  and press **MENU/OK** to return to the PictBridge display (to print pictures without the date of recording, select **PRINT WITHOUT DATE**). The date will not be printed if the camera clock was not set when the picture was taken.

Note

If no pictures are selected when the **MENU/OK** button is pressed, the camera will print one copy of the current picture.

Printing the DPOF Print Order

To print the print order created with  **PRINT ORDER (DPOF)** in the playback menu (pg. 53):

- 1 In the PictBridge display, press **DISP/BACK** to open the PictBridge menu. 

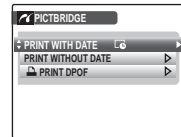

- 2 Press the selector up or down to highlight  **PRINT DPOF**.



- 3 Press **MENU/OK** to display a confirmation dialog.

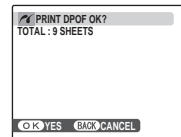

- 4 Press **MENU/OK** to start printing.



During Printing

The message shown at right is displayed during printing. Press **DISP/BACK** to cancel before all pictures are printed (depending on the printer, printing may end before the current picture has printed).

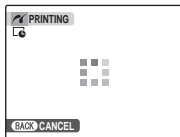

If Printing is interrupted, disconnect the USB cable from the camera, turn off the camera, and then repeat the steps on page 50.

Disconnecting the Camera

Confirm that "PRINTING" is not displayed in the monitor and disconnect the USB cable.

Notes

- Print pictures from internal memory or a memory card that has been formatted in the camera.
- If the printer does not support date printing, the **PRINT WITH DATE**  option will not be available in the PictBridge menu and the date will not be printed on the pictures in the DPOF print order.
- Default border/borderless setting, printer page size and print quality settings are used when printing via direct USB connection.

Creating a DPOF Print Order

The **PRINT ORDER (DPOF)** option in the playback menu can be used to create a digital “print order” for PictBridge-compatible printers (pg. 50) or devices that support DPOF.

DPOF

DPOF (Digital Print Order Format) is standard that allows pictures to be printed from “print orders” stored in internal memory or on a memory card. The information in the order includes the pictures to be printed and the number of copies of each picture.



WITH DATE / WITHOUT DATE

To modify the DPOF print order, select **PRINT ORDER (DPOF)** in the playback menu and press the multi selector up or down to highlight **WITH DATE** or **WITHOUT DATE**.

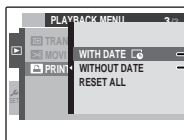

WITH DATE : Print date of recording on pictures.

WITHOUT DATE: Print pictures without date.

Press **MENU/OK** and follow the steps below.

1 Press the selector left or right to display a picture you wish to include in or remove from the print order.



2 Press the selector up or down to choose the number of copies (up to 99). To remove a picture from the order, press the selector down until the number of copies is 0.

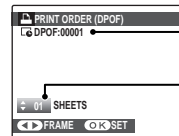

Total number of prints

Number of copies

Tip: Intelligent Face Detection

If the current picture was created with Intelligent Face Detection, pressing **▼** sets the number of copies to the number of faces detected.

3 Repeat steps 1–2 to complete the print order. Press **MENU/OK** to save the print order when settings are complete, or **DISP/BACK** to exit without changing the print order.



4 The total number of prints is displayed in the monitor. Press **MENU/OK** to exit.



The pictures in the current print order are indicated by a  icon during playback.

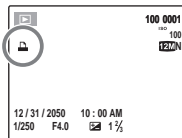

■ RESET ALL

To cancel the current print order, select **RESET ALL** in the

PRINT ORDER (DPOF)

menu. The confirmation shown at right will be displayed; press **MENU/OK** to remove all pictures from the order.

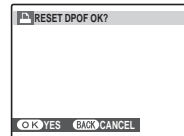

← Notes

- Remove the memory card to create or modify a print order for the pictures in internal memory.
- Print orders can contain a maximum of 999 pictures.
- If a memory card is inserted containing a print order created by another camera, the message shown at right will be displayed. Pressing **MENU/OK** cancels the print order; a new print order must be created as described above.
- The printer's settings may determine whether shooting dates are printed or not printed. Check the printer's settings if necessary.

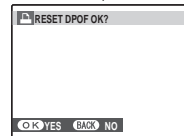

Viewing Pictures on a Computer

The supplied software can be used to copy pictures to a computer, where they can be stored, viewed, organized, and printed. Before proceeding, install the software as described below. *Do NOT connect the camera to the computer until installation is complete.*

Installing the Software

Two applications are supplied: MyFinePix Studio for Windows and FinePixViewer for the Macintosh. Installation instructions for Windows are on pages 55–56, those for the Macintosh on pages 57–58.

Windows: Installing My FinePix Studio

1 Confirm that the computer meets the following system requirements:

	Windows 7*	Windows Vista*	Windows XP*
CPU	3 GHz Pentium 4 or better		2 GHz Pentium 4 or better
RAM	1 GB or more		512 MB or more
Free disk space	15 GB or more		2 GB or more
Video	<ul style="list-style-type: none">• 1024×768 pixels or more with 24-bit color or better• A graphics processing unit (GPU) that supports DirectX 7 or later		
Other	<ul style="list-style-type: none">• Built-in USB port recommended. Operation is not guaranteed other USB ports.• Internet connection (56 kbps or faster recommended) required to use FinePix Internet Service; Internet connection and e-mail software required to use e-mail option		

* Other versions of Windows are not supported. Only pre-installed operating systems are supported; operation is not guaranteed on home-built computers or computers that have been upgraded from earlier versions of Windows.

- 2 Start the computer. Log in to an account with administrator privileges before proceeding.
- 3 Exit any applications that may be running and insert the installer CD in a CD-ROM drive.

Windows 7/Windows Vista

If an AutoPlay dialog is displayed, click **SETUP.exe**. A “User Account Control” dialog will then be displayed; click **Yes** (Windows 7) or **Allow** (Windows Vista).

The installer will start automatically; click **Install MyFinePix Studio** and follow the on-screen instructions to install MyFinePix Studio.

If the Installer Does Not Start Automatically

If the installer does not start automatically, select **Computer** or **My Computer** from the Start menu, then double-click the **FINEPIX** CD icon to open the FINEPIX CD window and double-click **SETUP** or **SETUP.exe**.

- 4 If prompted to install Windows Media Player or DirectX, follow the on-screen instructions to complete installation.
- 5 Remove the installer CD from the CD-ROM drive when installation is complete. Store the installer CD in a dry location out of direct sunlight in case you need to re-install the software. The version number is printed at the top of the CD label for reference when updating the software or contacting customer support.

Installation is now complete. Proceed to “Connecting the Camera” on page 59.

Macintosh: Installing FinePixViewer

1 Confirm that the computer meets the following system requirements:

CPU	PowerPC or Intel
OS	Pre-installed versions of Mac OS X version 10.3.9–10.6 (for the latest information, visit http://www.fujifilm.com/)
RAM	256 MB or more
Free disk space	A minimum of 200 MB required for installation with 400 MB available when FinePixViewer is running
Video	800 × 600 pixels or more with thousands of colors or better
Other	<ul style="list-style-type: none"> • Built-in USB port recommended. Operation is not guaranteed other USB ports. • Internet connection (56 kbps or faster recommended) required to use FinePix Internet Service; Internet connection and e-mail software required to use e-mail option

- 2** After starting the computer and quitting any applications that may be running, insert the installer CD in a CD-ROM drive and double-click **Installer for Mac OS X**.
- 3** An installer dialog will be displayed; click **Installing FinePixViewer** to start installation. Enter an administrator name and password when prompted and click **OK**, then follow the on-screen instructions to install FinePixViewer. Click **Exit** to quit the installer when installation is complete.

- 4** Remove the installer CD from the CD-ROM drive. Note that you may be unable to remove the CD if Safari is running; if necessary, quit Safari before removing the CD. Store the installer CD in a dry location out of direct sunlight in case you need to re-install the software. The version number is printed at the top of the CD label for reference when updating the software or contacting customer support.
- 5** **Mac OS X 10.5 or earlier:** Open the “Applications” folder, start Image Capture, and select **Preferences...** from the Image Capture application menu. The Image Capture preferences dialog will be displayed; choose **Other...** in the **When a camera is connected, open** menu, then select **FPVBridge** in the “Applications/FinePixViewer” folder and click **Open**. Quit Image Capture.
Mac OS X 10.6: Connect the camera and turn it on. Open the “Applications” folder and start Image Capture. The camera will be listed under **DEVICES**; select the camera and choose **FPVBridge** from the **Connecting this camera opens** menu and click **Open**. Quit Image Capture.

Installation is now complete. Proceed to “Connecting the Camera” on page 59.

Connecting the Camera

- 1 If the pictures you wish to copy are stored on a memory card, insert the card into the camera (pg. 9). If no card is inserted, pictures will be copied from internal memory.

← Note

Windows users may require the Windows CD when starting the software for the first time.

⚠ Caution

Loss of power during transfer could result in loss of data or damage to internal memory or the memory card. Check the battery level.

- 2 Press the **▶** for about a second to turn the camera on.
- 3 Open the battery-chamber cover.
- 4 Connect the supplied USB cable as shown, making sure the connectors are fully inserted. Connect the camera directly to the computer; do not use a USB hub or keyboard.

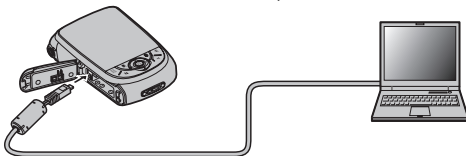

- 5 MyFinePix Studio or FinePixViewer will start automatically; follow the on-screen instructions to copy pictures to the computer. To exit without copying pictures, click **Cancel**.

⚠ Caution

If the software does not start automatically, it may not be correctly installed. Disconnect the camera and reinstall the software.

For more information on using the supplied software, start the application and select the appropriate option from the **Help** menu.

 **Cautions**

- If a memory card containing a large number of images is inserted, there may be a delay before the software starts and you may be unable to import or save images.
Use a memory card reader to transfer pictures.
- Make sure that the computer does not display a message stating that copying is in progress and that the indicator lamp is out before turning the camera off or disconnecting the USB cable (if the number of images copied is very large, the indicator lamp may remain lit after the message has cleared from the computer display). Failure to observe this precaution could result in loss of data or damage to internal memory or the memory card.
- Disconnect the camera before inserting or removing memory cards.
- In some cases, it may not be possible to access pictures saved to a network server using the supplied software in the same way as on a standalone computer.
- The user bears all applicable fees charged by the phone company or Internet service provider when using services that require an Internet connection.

 **Disconnecting the Camera**

After confirming that the indicator lamp is out, follow the on-screen instructions to turn the camera off and disconnect the USB cable.

 **Uninstalling the Supplied Software**

Only uninstall the supplied software when it is no longer required or before beginning reinstallation. After quitting the software and disconnecting the camera, drag the “FinePixViewer” folder from “Applications” into the Trash and select **Empty Trash** in the **Finder** menu (Macintosh), or open the control panel and use “Programs and Features” (Windows 7/ Windows Vista) or “Add or Remove Programs” (Windows XP) to uninstall MyFinePix Studio. Under Windows, one or more confirmation dialogs may be displayed; read the contents carefully before clicking **OK**.

The Shooting Menu

The shooting menu is used to adjust settings for a wide range of shooting conditions.

Using the Shooting Menu

- 1 Press **MENU/OK** to display the shooting menu.

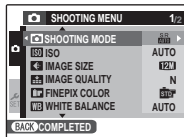

← Note

The options displayed in the shooting menu vary depending on the shooting mode.

- 2 Press the selector up or down to highlight the desired menu item.



- 3 Press the selector right to display options for the highlighted item.

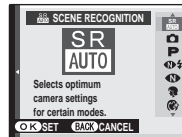















































- 4 Press the selector up or down to highlight the desired option.

- 5 Press **MENU/OK** to select the highlighted option.



Shooting Menu Options

Menu item	Description	Options	Default
 SHOOTING MODE	Choose a shooting mode according to the type of subject (pg. 22).	  /  /  /  /  /  /  /  /  /  /  /   /  /  /  /  /  /  /  /  /   /  /  /  /  /  /  /  /  / 	
 ISO	Adjust ISO sensitivity (pg. 63). Choose higher values when the subject is poorly lit.	AUTO/1600/800/ 400/200/100	AUTO
 IMAGE SIZE	Choose image size (pg. 63).	12M/10M 3:2/9M 16:9/6M/3M/ 2M 16:9/2M/03M	12M
 IMAGE QUALITY	Choose image quality (pg. 64).	FINE/NORMAL	NORMAL
 FINEPIX COLOR	Shoot pictures in standard color, saturated color, black-and-white, or sepia (pg. 64).	STD/C/BI/SEPIA	STD
 WHITE BALANCE	Adjust color for different light sources (pg. 65).	AUTO/☀/☁/☔/☕/☖/☗	AUTO
 CONTINUOUS	Shoot a series of pictures (pg. 65).	ON/OFF	OFF
 FACE DETECTION	Turn Intelligent Face Detection and red-eye removal on or off (pg. 27).	ON/OFF	—
 AF MODE	Choose how the camera selects a focus area (pg. 66).	 / 	
 MOVIE QUALITY	Choose the frame size for movies (pg. 45).	HD 1280/640/320	640

ISO ISO

Control the camera's sensitivity to light with **P**. Higher values can be used to reduce blur when lighting is poor; note, however, that mottling may appear in pictures taken at high sensitivities. If **AUTO** is selected, the camera will adjust sensitivity automatically in response to shooting conditions.

Settings other than **AUTO** are shown by an icon in the monitor if you use **P**.

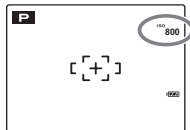
**IMAGE SIZE**

Choose the size at which still pictures are recorded. Large pictures can be printed at large sizes with no drop in quality; small pictures require less memory, allowing more pictures to be recorded.

Option	Prints at sizes up to
12M	31 × 23 cm/12.2 × 9 in. (12M) or 31 × 21 cm/12.2 × 8.2 in. (10M 3:2). Choose 12M for high-quality prints, 10M 3:2 for an aspect ratio of 3:2, 9M 16:9 for an aspect ratio of 16:9.
10M 3:2	
9M 16:9	
6M	
3M	22 × 16 cm (8.7 × 6 in.)
2M 16:9	17 × 13 cm (7 × 5.1 in.)
2M	14 × 10 cm (5.5 × 3.9 in.)
03M	5 × 4 cm (1.9 × 1.5 in.). Suited to e-mail or the web.

The number of pictures that can be taken at current settings (pg. 105) is displayed to the right of the image quality icon in the monitor.

Note

Image size is not reset when the camera is turned off or another shooting mode is selected.

Aspect Ratio

Pictures taken at an image size setting of **10M 3:2** have an aspect ratio of 3:2, the same as a frame of 35-mm film. Pictures taken at an image size setting of **9M 16:9** or **2M 16:9** have an aspect ratio of 16:9. Pictures taken at other settings have an aspect ratio of 4:3.

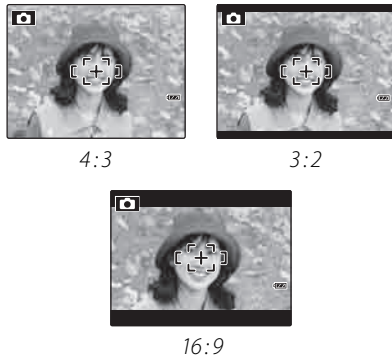

IMAGE QUALITY

Choose how much image files are compressed. Select **FINE** (low compression) for higher image quality, **NORMAL** (high compression) to increase the number of pictures that can be stored.

FINEPIX COLOR

Enhance contrast and color saturation or take pictures in black and white or sepia.

Option	Displayed in
F-STANDARD	Standard contrast and saturation. Recommended in most situations.
F-CHROME	Vivid contrast and color. Choose for vivid shots of flowers or enhanced greens and blues in landscapes. Available only in C , P , N , S , and M modes.
F-B&W	Take pictures in black and white.
F-SEPIA	Take pictures in sepia.







Settings other than **F-STANDARD** are shown by an icon in the monitor.

Notes

- FINEPIX COLOR** is not reset when the camera is turned off or another shooting mode is selected.
- Depending on the subject, the effects of **F-CHROME** may not be visible in the monitor.

WB WHITE BALANCE

For natural colors, choose a setting that matches the light source (for an explanation of “white balance,” see the Glossary on page 104).

Option	Displayed in
AUTO	White balance adjusted automatically.
	For subjects in direct sunlight.
	For subjects in the shade.
	Use under “daylight” fluorescent lights.
	Use under “warm white” fluorescent lights.
	Use under “cool white” fluorescent lights.
	Use under incandescent lighting.

If **AUTO** does not produce the desired results (for example, when taking close-ups), choose the option that matches the light source.

← Note

Results vary with shooting conditions. Play pictures back after shooting to check colors in the monitor.

📷 CONTINUOUS (Continuous shooting)

While the shutter button is pressed, the camera takes up to three pictures.

← Notes

- Focus and exposure are determined by the first frame in each series.
- The number of pictures that can be recorded depends on the memory available. Additional time may be required to record pictures when shooting ends. The pictures are displayed in the monitor while recording is in progress.



AF MODE

In shooting mode **P** or , this option controls how the camera focuses when Intelligent Face Detection is off (pg. 27). Regardless of the option selected, the camera will focus on the subject in the center of the monitor when macro mode is on (pg. 34).



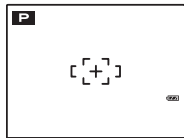

AF MODE: CENTER

The camera focuses on the subject in the center of the monitor. This option can be used with focus lock.



AF MODE: TRACKING

Position the subject in the center focus area and press  to lock on to the subject. Once the subject is locked, the camera will track the subject as it moves through the frame. Press  again to cancel tracking.

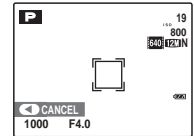
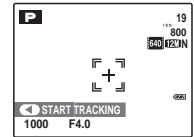

Caution

Tracking is not possible in some situations.

The Playback Menu

The playback menu is used to manage the pictures in internal memory or on the memory card.

Using the Playback Menu

1 Press  to enter playback mode (pg. 40).

2 Press **MENU/OK** to display the playback menu.

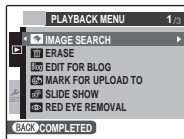

3 Press the selector up or down to highlight the desired menu item.

4 Press the selector right to display options for the highlighted item.

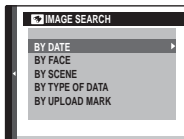

5 Press the selector up or down to highlight the desired option.











6 Press **MENU/OK** to select the highlighted option.



Playback Menu Options

The following options are available:

Option	Description
 IMAGE SEARCH	Search for images based on certain criteria (pg. 68).
 ERASE	Delete all or selected pictures (pg. 43).
 EDIT FOR BLOG	Edit images and reduce file size. Ideal for images that will be uploaded or sent as e-mail attachments (pg. 69).
 MOVIE EDIT	Adjust the color balance and brightness of movies (pg. 72).
 MARK FOR UPLOAD TO	Specify the destination for uploading to YouTube™ and FACEBOOK (pg. 72).
 SLIDE SHOW	View pictures in a slide show (pg. 74).
 RED-EYE REMOVAL	Create copies with reduced red eye (pg. 74).
 PROTECT	Protect pictures from accidental deletion (pg. 75).
 CROP	Create cropped copies of pictures (pg. 76).









Option	Description
 RESIZE	Reduce the size of images (pg. 77).
 IMAGE ROTATE	Rotate pictures (pg. 78).
 COPY	Copy pictures between internal memory and a memory card (pg. 79).
 VOICE MEMO	Add voice memos to pictures (pg. 80).
 TRANSITION	Choose the transition between pictures during playback (pg. 82).
 MOVIE TRIMMING	Create an edited copy of a movie (pg. 82).
 PRINT ORDER (DPOF)	Select pictures for printing on DPOF- and PictBridge-compatible devices (pg. 51).

IMAGE SEARCH

You can search for images based on a variety of criteria. Begin by selecting  **IMAGE SEARCH** in the playback menu.



- 1 Press **MENU/OK** and select the search criteria.

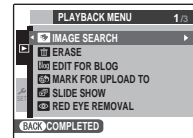

Criteria	Description
BY DATE	Find all pictures taken on a specified date.
BY FACE	Find pictures based on face information.
BY SCENE	Find all pictures that match a specified scene.
BY TYPE OF DATA	Find all still images, movies, or images edited for use with a blog.
BY UPLOAD MARK	Find all images uploaded to either YouTube or FACEBOOK.

- 2 Narrow down the criteria.



- 3 Press **MENU/OK** to begin searching. The results of the search are displayed.



Searching for images

Images found when using the image search feature can be deleted (pg. 43), protected (pg. 75), or viewed in a slide show (pg. 74) by pressing **MENU/OK**.

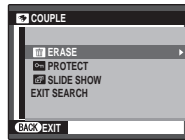

Blog EDIT FOR BLOG

You can process still images for posting to a blog.

1 Select the frame (file) to process.



2 Press **MENU/OK** to display the playback menu.



3 Select **Blog EDIT FOR BLOG** and press **MENU/OK** to display the processing menu.

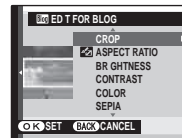

4 Select the menu.



5 Press **MENU/OK** to open the setting screen. The screen type varies, depending on the selected menu.



6 Change the setting.
This step is unnecessary in some menus.



7 Press **MENU/OK** to process the image.
The original image remains unaltered.



← Notes

- Press the **W** and **T** buttons to zoom the picture in or out and use the selector to display the portion of the picture you wish to save before processing it. Press **MENU/OK** to crop the picture and return to the image selection display.
- Processed images are saved at **03M** (640×480).
- Small copies are saved using filenames that begin with "BLOG." During playback, small copies are indicated by a **Blog** icon and a black border. Small copies can not be further cropped or rotated.

■ List of Processing menu options

menu	Functions	Settings	Factory default
CROP	The image is trimmed so that only the desired area of the image is viewable.	—	—
ASPECT RATIO*	Crops an image to change the aspect ratio.	Wide image: 4:1, 8:3, 16:9, 3:2, 4:3, 1:1, 3:4, 1:3 Tall image: 3:1, 4:3, 1:1, 3:4, 2:3, 9:16, 3:8, 1:4	Wide image:4:3 Tall image:3:4
BRIGHTNESS	Changes the brightness of an image.	-5 to +5	0
CONTRAST	Changes the contrast of an image.	-5 to +5	0
COLOR	Emphasizes red and blue hues of an image. + increases red hues; - increases blue hues.	-5 to +5	0
SEPIA	Converts an image to black and white, or sepia.	0 to 5	0
FACE MOSAIC	Applies a mosaic effect to faces in an image. If the image is taken with Intelligent Face Detection set to ON, the effect can be applied on up to 4 faces. If the image is taken with Intelligent Face Detection set to OFF, the effect will be applied at the center of the image.	—	—

* When a  menu is used, other menus cannot be used for that image.

MOVIE EDIT

You can process movies for posting to a blog, using the same procedure used for processing still images (pg. 69).

■ List of Processing menu options

Menu	Functions
SEPIA	Converts the movie to sepia.
B&W	Converts the image to black and white.
BACKLIGHT CORRECTION	Brightens the image to compensate for backlight.

Note

Processed files are saved using file names that begin with "EDIT". During playback, these files are indicated by a  icon and a black border.

MARK FOR UPLOAD TO

You can select still images and movies to be uploaded later to YouTube or FACEBOOK. Begin by selecting  **MARK FOR UPLOAD TO** in the playback menu.

- 1 Press **MENU/OK** and select the upload destination.
- 2 Select the still image or movie that you will upload later, then press **MENU/OK**. Repeat this step if you want to upload more items.
- 3 When settings are complete, press **DISP/BACK**.



Notes

- The upload destination (YouTube or FACEBOOK) is displayed (pg. 3) when playing back images that have been selected for upload.
- Still images cannot be uploaded to YouTube.

■ Canceling Upload Selections

You can cancel still images and movies that were selected to be uploaded. Begin by selecting  **MARK FOR UPLOAD TO**.

1 Press **MENU/OK**.



2 Display a still image or movie that was selected to be uploaded.



3 Press **MENU/OK**.
Select **RESET ALL** to cancel all still images and movies that were selected to be uploaded.



■ Uploading Images

YouTube/FACEBOOK Uploader

Once you have selected images to be uploaded to YouTube or FACEBOOK, you can upload them using the included MyFinePix Studio software (pg. 55).

Use camera to select images

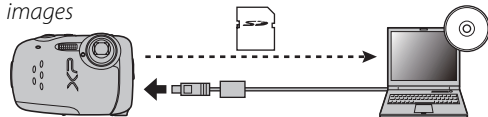



Use computer to upload images

* This feature is not available for Macintosh computers.



SLIDE SHOW

View pictures in an automated slide show. After choosing the background music, choose the type of show and press **MENU/OK** to start. Press **DISP/BACK** at any time during the show to view on-screen help. When a movie is displayed, movie playback will begin automatically, and the slide show will continue when the movie ends. The show can be ended at any time by pressing **MENU/OK**.

Option	Displayed in
NORMAL	Press selector left or right to go back or skip ahead one frame. Select FADE-IN for fade transitions between frames.
FADE-IN	
NORMAL 	As above, except that camera automatically zooms in on faces selected with Intelligent Face detection.
FADE-IN 	
MULTIPLE	Display several pictures at once.
SCRAP BOOK VIEW	As for MULTIPLE , except that the pictures are chosen randomly.
SELECT BGM	Choose background music.

RED EYE REMOVAL

This option is used with pictures taken using Intelligent Face Detection to create copies that have been processed to remove red eye.

- 1 Play the picture back in the monitor (pictures taken with Intelligent Face Detection are indicated by a  icon) and select  **RED EYE REMOVAL** in the playback menu (pg. 41).

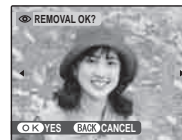

- 2 Press **MENU/OK**. The message shown below at left will be displayed while the camera analyses the image; if red-eye is detected, the message shown below at right will be displayed while the camera processes the image to create a copy with reduced red-eye.

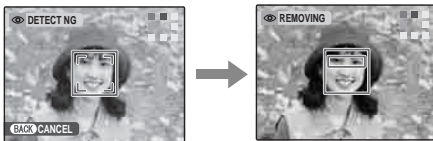

← Notes

- Red eye may not be removed if the camera is unable to detect a face or the face is in profile. Results may differ depending on the scene. Red eye can not be removed from pictures that have already been processed using red-eye removal or pictures created with other devices.
- The amount of time needed to process the image varies with the number of faces detected.
- Copies created with **RED EYE REMOVAL** are indicated by a icon during playback.

PROTECT

Protect pictures from accidental deletion. The following options are available.

■ **FRAME**

Protect selected pictures.

- 1 Press the selector left or right to display the desired picture.

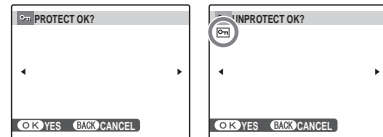

Picture not protected *Protected picture*

- 2 Press **MENU/OK** to protect the picture. If the picture is already protected, pressing **MENU/OK** will remove protection from the image.



- 3 Repeat steps 1–2 to protect additional images. Press **DISP/BACK** to exit when the operation is complete.



■ SET ALL

Press **MENU/OK** to protect all pictures, or press **DISP/BACK** to exit without changing picture status.

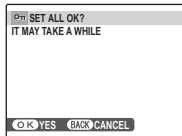

■ RESET ALL

Press **MENU/OK** to remove protection from all pictures, or press **DISP/BACK** to exit without changing picture status.

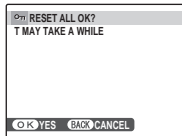

If the number of pictures affected is very large, the display at right will appear in the monitor while the operation is in progress.

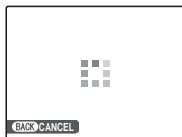

Press **DISP/BACK** to exit before the operation is complete.

⚠ Caution

Protected pictures will be deleted when the memory card or internal memory is formatted (pg. 87).

📐 CROP

To create a cropped copy of a picture, play the picture back and select **📐 CROP** in the playback menu (pg. 67).

- 1 Press the zoom buttons to zoom in and out and use the selector to scroll the picture until the desired portion is displayed (to exit to single-frame playback without creating a cropped copy, press **DISP/BACK**).

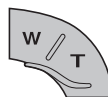

Zoom indicator

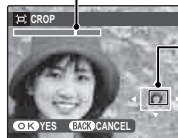

Navigation window shows portion of image currently displayed in monitor

💡 Tip: Intelligent Face Detection

If the picture was shot with Intelligent Face Detection (pg. 27), **👤** will be displayed in the monitor. Press the **▼** button to zoom in on the selected face.

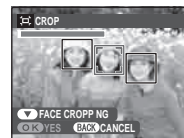

- 2** Press **MENU/OK**. A confirmation dialog will be displayed.

Copy size is shown at the top; if the size is **03M**, **OK** is displayed in yellow.

Larger crops produce larger copies; all copies have an aspect ratio of 4:3.

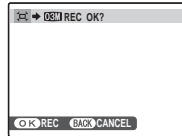

- 3** Press **MENU/OK** to save the cropped copy to a separate file.



← Note

Pictures taken with other cameras cannot be trimmed.

RESIZE

You can create a small copy of a picture. Begin by selecting  **RESIZE** in the playback menu.



- 1** Press the selector up or down to highlight **640 STANDARD** or **320 SMALL**.
- 2** Press **MENU/OK** to select the highlighted option.
- 3** Press **MENU/OK** to copy the picture at the selected size.



IMAGE ROTATE

By default, pictures taken in tall orientation are displayed in wide orientation. Use this option to display pictures in the correct orientation in the monitor. It has no effect on pictures displayed on a computer or other device.

Notes

- Protected pictures can not be rotated. Remove protection before rotating pictures (pg. 75).
- The camera may not be able to rotate pictures created with other devices.

- 1 Press the selector left or right to display the desired picture in the monitor.

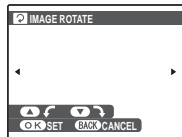

- 2 Press the selector down to rotate the picture 90° clockwise, up to rotate the picture 90° counterclockwise.



- 3 Press **MENU/OK** to confirm the operation (to exit without rotating the picture, press **DISP/BACK**).



The next time the picture is played back, it will automatically be rotated.

COPY COPY

Copy pictures between internal memory and a memory card.

- 1 Press the selector up or down to highlight **INTERNAL MEMORY** → **SD CARD** (copy pictures from internal memory to the memory card) or **SD CARD** → **INTERNAL MEMORY** (copy pictures from a memory card to internal memory).



- 2 Press the selector right to display options for the highlighted item.

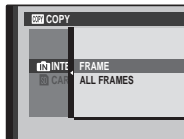

- 3 Press the selector up or down to highlight **FRAME** or **ALL FRAMES**.



- 4 Press **MENU/OK**.

**FRAME**

Copy selected frames.

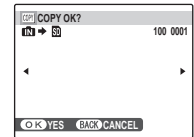

- 1 Press the selector left or right to display the desired picture.
- 2 Press **MENU/OK** to copy the picture.
- 3 Repeat steps 1–2 to copy additional images. Press **DISP/BACK** to exit when the operation is complete.

**ALL FRAMES**

Press **MENU/OK** to copy all pictures, or press **DISP/BACK** to exit without copying pictures.

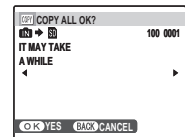
**⚠ Cautions**

- Copying ends when the destination is full.
- DPOF print information is not copied (pg. 51).

VOICE MEMO

To add a voice memo to a still picture, select  **VOICE MEMO** after displaying the picture in playback mode.

Note

Voice memos can not be added to movies or protected pictures. Remove protection from pictures before recording voice memos (pg. 75).

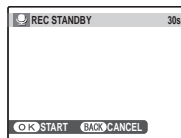
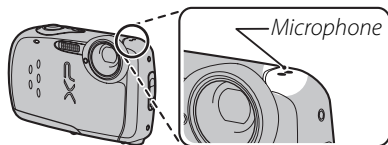

- 1 Press **MENU/OK** to start recording. Hold the camera at a distance of about 20 cm (8 in.) and face the microphone.

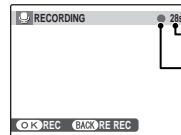

- 2 Press **MENU/OK** again to end recording. Recording ends automatically after 30 seconds.

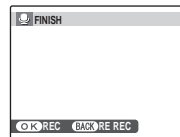

Notes

- If a voice memo already exists for the current picture, the options at right will be displayed. Select **RE-REC** to replace the existing memo.
- Voice memos are recorded as PCM-format WAV files (pg. 104) with a maximum size of about 480 KB.



Playing Voice Memos

When a picture that has a voice memo recorded for it (as indicated by the  icon displayed during playback) is selected, you can play the voice memo by selecting **PLAY**, then pressing **MENU/OK**.

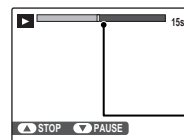

Progress is shown in the monitor.

Progress bar

Note

The camera may not play voice memos recorded with other devices.

Caution

Do not cover the speaker during playback.

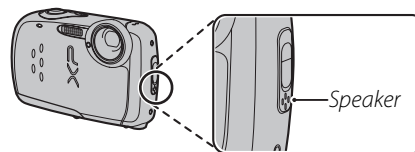

TRANSITION

Choose the transition between images during playback.

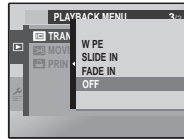

MOVIE TRIMMING

To create a shorter copy of the movie currently displayed in playback mode, select

MOVIE TRIMMING from the playback menu.

- Pressing the selector down to start or pause playback, play the movie until the first frame you wish to include in the new movie is displayed.

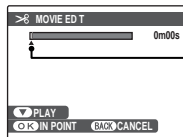

Indicator shows the position of the starting frame.

- Press **MENU/OK**.



- Pressing the selector down to resume or pause playback, play the movie until the last frame you wish to include in the new movie is displayed.

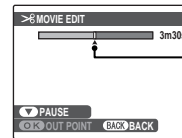

Indicator shows the position of the final frame.

- To return to step 1 and choose a new starting point, press **DISP/BACK**.

- Press **MENU/OK** to save the edited movie to a new file and return to playback with the new movie displayed. The original image is left as it was.



The Setup Menu

Using the Setup Menu

1 Display the setup menu.

1.1 Press **MENU/OK** to display the menu for the current mode.

1.2 Highlight the left tab.

1.3 Select  **SET**.

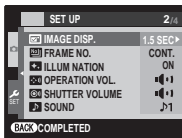

2 Choose an item.

2.1 Press the selector up or down to choose an item.



3 Adjust settings.

3.1 Press the selector right to display options for the highlighted item.

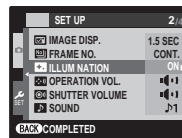

3.2 Press the selector up or down to highlight an option.





3.3 Press **MENU/OK** to select the highlighted option.

3.4 Press **DISP/BACK** when finished to return to the shooting mode screen or playback screen.



Setup Menu Options

	Menu item	Description	Options	Default
1	DATE/TIME	Set the camera clock (pg. 14).	—	—
	TIME DIFFERENCE	Set the clock to local time (pg. 86).	/	
	言語/LANG.	Choose a language (pg. 14).	See page 107	ENGLISH
	SILENT MODE	When silent mode is on, the flash does not fire (except when using mode), operation sounds and the shutter sound are not heard, the sound is muted when playing back movies or voice memos, and the self-timer lamp and shooting indicator do not light (pg. 36).	ON / OFF	OFF
	RESET	Reset all settings except Frame number, DATE/TIME , TIME DIFFERENCE , BACKGROUND COLOR , and VIDEO SYSTEM to default values. A confirmation dialog will be displayed, press the selector left or right to highlight OK and press MENU/OK .	—	—
2	FORMAT	Format internal memory or memory cards (pg. 87).	—	—
	IMAGE DISP.	Choose how long pictures are displayed after shooting (pg. 87).	3 SEC / 1.5 SEC / ZOOM (CONTINUOUS) / OFF	1.5 SEC
	FRAME NO.	Choose how files are named (pg. 88).	CONT. / RENEW	CONT.
	ILLUMINATION	Turn the shooting indicator on or off (pg. 88).	ON / OFF	ON
	OPERATION VOL.	Adjust the volume of camera controls.	/ / / / OFF	
	SHUTTER VOLUME	Adjust the volume of the shutter sound.	/ / / OFF	
	SOUND	Choose shutter, start-up, and control sounds (pg. 89).	—	—
3	PLAYBACK VOLUME	Adjust the volume for movie and voice memo playback (pg. 89).	—	—
	LCD BRIGHTNESS	Control the brightness of the monitor (pg. 89).	-5 - +5	0
	LCD MODE	Turn display power saving mode on or off.	ON / OFF	ON
	AUTO POWER OFF	Choose the auto power off delay (pg. 89).	5 MIN / 2 MIN / OFF	2 MIN
	DIGITAL IS	Reduces camera shake and moving-subject blur.	AUTO / OFF	OFF
	RED EYE REMOVAL	Remove “red-eye” effects caused by the flash.	ON / OFF	ON

	Menu item	Description	Options	Default
4	 DIGITAL ZOOM	Enable or disable digital zoom (pg. 90).	ON / OFF	OFF
	 SAVE ORG IMAGE	Choose whether to save unprocessed copies of pictures taken using red-eye removal.	ON / OFF	OFF
	 BACKGROUND COLOR	Choose the design of the menu screen.	Color 1 / Color 2 / Color 3	Color 1
	 GUIDANCE DISPLAY	Choose whether to display tool tips.	ON / OFF	ON
	 VIDEO SYSTEM	Choose a video mode for connection to a TV (pg. 49).	NTSC / PAL	—

TIME DIFFERENCE

When travelling, use this option to switch the camera clock instantly from your home time zone to the local time at your destination.

1 Specify the difference between local time and your home time zone.

1.1 Press the selector up or down to highlight  **LOCAL**.



1.2 Press the selector right to display the time difference.

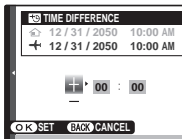

1.3 Press the selector left or right to highlight **+**, **-**, hours, or minutes; press up or down to edit. The minimum increment is 15 minutes.





1.4 Press **MENU/OK** when settings are complete.



2 Switch between local time and your home time zone.

To set the camera clock to local time, highlight  **LOCAL** and press **MENU/OK**.

To set the clock to the time in your home time zone, select  **HOME**. If  **LOCAL** is selected,  will be displayed in the monitor for three seconds after the camera enters shooting mode, and the date will be displayed in yellow.

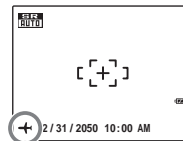

After changing time zones, check that the date and time are correct.

FORMAT

Format internal memory or a memory card. If a memory card is inserted in the camera, **SD** will be displayed in the dialog shown at right and this option will format the memory card. If no memory card is inserted, **IN** will be displayed and this option will format internal memory. Press the selector left to highlight **OK** and press **MENU/OK** to begin formatting.

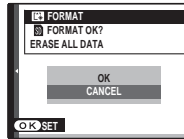



Cautions

- All data—including protected pictures—will be deleted. Be sure important files have been copied to a computer or other storage device.
- Do not open the battery cover during formatting.

IMAGE DISP.

Choose how long pictures are displayed in the monitor after shooting.

- **3 SEC**: Pictures are displayed for about 3 s before being recorded to the memory card.
- **1.5 SEC**: Pictures are displayed for about 1.5 s before being recorded to the memory card.
- **ZOOM (CONTINUOUS)**: Pictures are displayed until the **MENU/OK** button is pressed. Pictures taken at image sizes larger than **03M** can be zoomed in to check fine details (see page 41). Note that this option is disabled in continuous mode (pg. 65) and when  or  is selected for  **SHOOTING MODE**.
- **OFF**: Pictures are not displayed automatically after shooting.

Note

The colors displayed at settings of **3 SEC** and **1.5 SEC** may differ from those in the final picture.

FRAME NO.

New pictures are stored in image files named using a four-digit file number assigned by adding one to the last file number used. The file number is displayed during playback as shown at right. **FRAME NO.** controls whether file numbering is reset to 0001 when a new memory card is inserted or the current memory card or internal memory is formatted.

- **CONT.:** Numbering continues from the last file number used or the first available file number, whichever is higher. Choose this option to reduce the number of pictures with duplicate file names.
- **RENEW:** Numbering is reset to 0001 after formatting or when a new memory card is inserted.

Notes

- If the frame number reaches 999-9999, the shutter release will be disabled (pg. 101).
- Selecting  **RESET** (pg. 84) does not reset frame numbering.
- Frame numbers for pictures taken with other cameras may differ.

ILLUMINATION

If **ON** is selected, the shooting indicator will light when the camera is turned on.

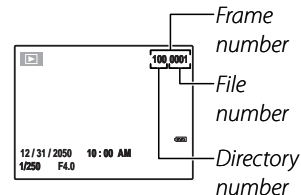

SOUND

Choose the sounds used for the shutter, at start up, and for camera controls. Press the selector up or down to highlight an option and press left or right to select a sound. Press **MENU/OK** to select.

PLAYBACK VOLUME

Adjust the volume for movie and voice memo playback and slide show music. Press the selector up or down to adjust the volume, then press **MENU/OK**.

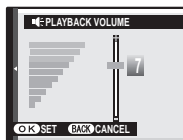

LCD BRIGHTNESS

Adjust the LCD brightness. Press the selector up or down to adjust the brightness, then press **MENU/OK**.

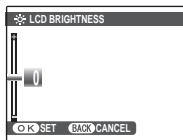

LCD MODE

If **ON** is selected, the monitor will automatically dim after a few seconds on inactivity to conserve power. Monitor brightness will return to normal when the shutter button is pressed. The monitor will not dim when viewing pictures or movies.

AUTO POWER OFF

Choose the length of time before the camera turns off automatically when no operations are performed. Shorter times increase battery life; if **OFF** is selected, the camera must be turned off manually. Note that regardless of the option selected, the camera will not turn off automatically when connected to a printer (pg. 50) or computer (pg. 55), while recording or viewing a movie or when a slide show is in progress (pg. 74).

Tip: Turning the camera on again

To enter shooting mode, press **ON/OFF**. To enter playback mode, press .

DIGITAL ZOOM

If **ON** is selected, pressing **T** at the maximum optical zoom position will trigger digital zoom, further magnifying the image. To cancel digital zoom, zoom out to the minimum digital zoom position and press **W**.

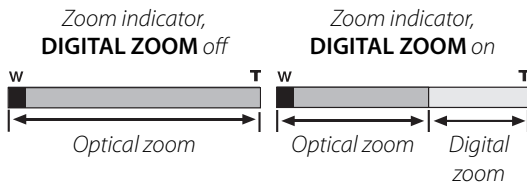
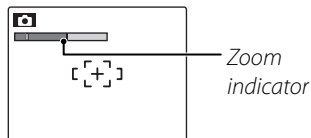

Caution

Digital zoom produces lower quality images than optical zoom.

Optional Accessories

The camera supports a wide range of accessories from FUJIFILM and other manufacturers.

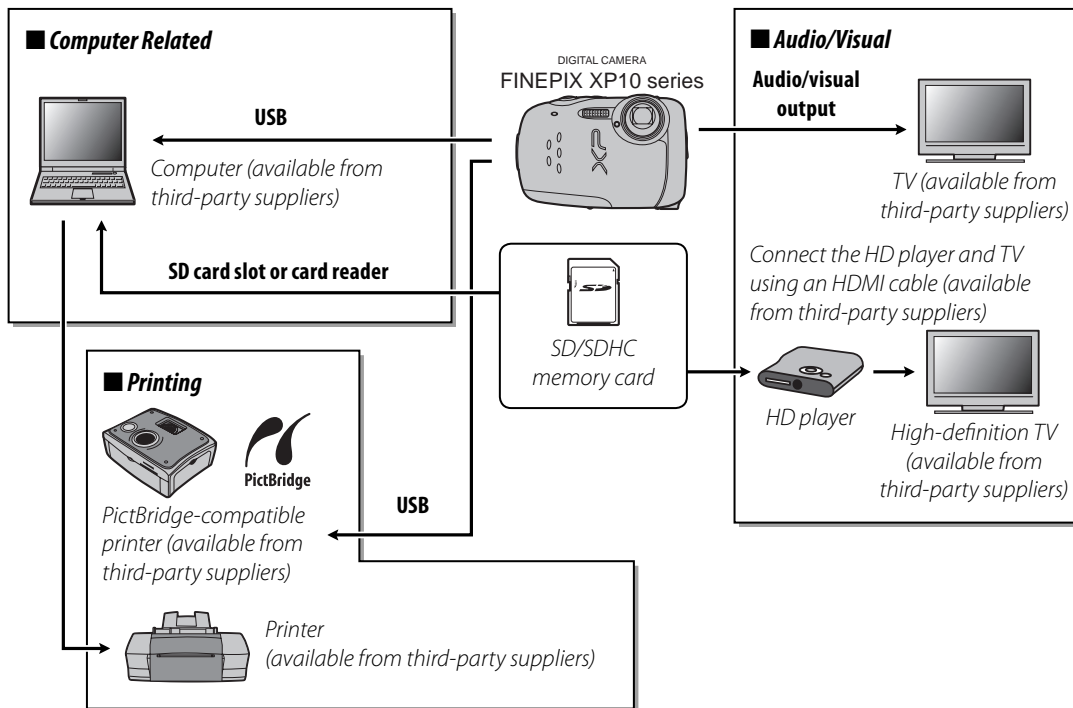

Accessories from Fujifilm

The following optional accessories were available from FUJIFILM. Check with your local Fujifilm representative for information on the accessories available in your region.

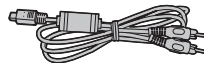

- **AV-C1 A/V cable:** Connects the camera and a TV.
- **FS-FXZ33 Float Strap:** Prevents the camera from sinking in water.
- **HDP-L1 HD Player:** Connects to an HD television and allows you to view still images and movies stored on the memory card. Also requires the purchase of an HDMI cable.



For the latest information on accessories available from FUJIFILM, visit http://www.fujifilm.com/products/digital_cameras/index.html.

Troubleshooting

Power and Battery

Problem		Possible cause	Solution	Page
Water immersion		The battery-chamber cover has been accidentally opened underwater.	Do not turn on the camera. Ask our Repair service to repair the camera.	—
		The camera has been put in water with the battery-chamber cover insecurely closed.		
Power supply	The camera does not turn on.	The battery is exhausted.	Charge the battery or insert a fully-charged spare battery.	4, 6
		The battery is not in the correct orientation.	Re-insert the battery in the correct orientation.	6
	The battery runs down quickly.	The battery is cold.	Warm the battery by placing it in a pocket or other warm place and re-insert it in the camera immediately before taking a picture.	6
		There is dirt on the battery terminals.	Clean the terminals with a soft, dry cloth.	—
		The camera is in  mode.	Use  mode if you want to conserve power when shooting.	23
		The battery has been charged many times.	The battery has reached the end of its charging life. Purchase a new battery.	—
	The camera turns off suddenly.	The battery is exhausted.	Charge the battery or insert a fully-charged spare battery.	4, 6

Problem		Possible cause	Solution	Page
Battery charger	Charging does not start.	The battery is not correctly inserted.	Re-insert the battery in the charger.	4
		The battery is not in the correct orientation.	Re-insert the battery in the correct orientation.	4
	Charging is slow.	The temperature is low.	Charge the battery at room temperature.	5
	The charging lamp lights, but the battery does not charge.	There is dirt on the battery terminals.	Clean the terminals with a soft, dry cloth.	—
		The battery has been charged many times.	The battery has reached the end of its charging life. Purchase a new battery. If the battery still fails to charge, contact your FUJIFILM dealer.	—

Menus and Displays

Problem		Possible cause	Solution	Page
Menus and displays are not in English.		English is not selected for the 言語/LANG. option in the setup menu.	Select ENGLISH .	14



Shooting

Problem		Possible cause	Solution	Page
Taking pictures	No picture is taken when the shutter button is pressed.	Memory is full.	Insert a new memory card or delete pictures.	8, 43
		Memory is not formatted.	Format the memory card or internal memory.	87
		There is dirt on the memory card contacts.	Clean the contacts with a soft, dry cloth.	9
		The memory card is damaged.	Insert a new memory card.	8
		The battery is exhausted.	Charge the battery or insert a fully-charged spare battery.	4, 6
		The camera has turned off automatically.	Turn the camera on.	13, 89
	The monitor goes dark after shooting.	The flash has fired.	The monitor may darken while the flash charges. Wait for the flash to charge.	35
Focus	The camera does not focus.	The subject is close to the camera.	Select macro mode.	34
		The subject is far away from the camera.	Cancel macro mode.	
		The subject is not suited to autofocus.	Use focus lock.	30



	Problem	Possible cause	Solution	Page
Close-ups	Macro mode is not available.	The camera is in a shooting mode which makes macro (close-up) mode unavailable.	Choose a different shooting mode.	22
	Face detection not available.	The camera is in a shooting mode which makes Intelligent Face Detection unavailable.	Choose a different shooting mode.	22
Intelligent Face Detection	No face is detected.	The subject's face is obscured sunglasses, a hat, long hair, or other objects.	Remove the obstructions.	27
		The subject's face occupies only a small area of the frame.	Change the composition so that the subject's face occupies a larger area of the frame.	
		The subject's head is tilted or horizontal.	Ask the subject to hold their head straight.	
		The camera is tilted.	Hold the camera straight.	17
	The subject's face is poorly lit.	Shoot in bright light.	—	
Wrong subject selected.	The selected subject is closer to the center of the frame than the main subject.	Recompose the picture or turn face detection off and frame the picture using focus lock.	27, 30	
Flash	The flash does not fire.	The camera is in a shooting mode in which the flash does not fire.	Choose a different shooting mode.	22
		The battery is exhausted.	Charge the battery or insert a fully-charged spare battery.	4, 6
		The camera is in continuous mode.	Select OFF for  CONTINUOUS .	65
		The camera is in silent mode.	Turn silent mode off.	36
	The flash is off (🔴).	Choose a different flash mode.	35	
	Some flash modes are not available.	The camera is in a shooting mode which makes some flash modes unavailable.	Choose a different shooting mode.	22
		The camera is in silent mode.	Turn silent mode off.	36
The flash does not fully light the subject.	The subject is not in range of the flash.	Position the subject in range of the flash.	107	
	The flash window is obstructed.	Hold the camera correctly.	17	

	Problem	Possible cause	Solution	Page
	📷 mode Can not take pictures.	The battery is low.	Charge the battery or insert a fully-charged spare battery.	4, 6
	Movies Can not record movies.	The camera is in 📷 mode.	Choose a different shooting mode.	22
Problem images	Pictures are blurred.	The lens is dirty.	Clean the lens.	110
		The lens is blocked.	Keep objects away from the lens.	17
		!AF is displayed during shooting and the focus frame is displayed in red.	Check focus before shooting.	19, 30, 100
		!of is displayed during shooting.	Use the flash or a tripod.	35
	Pictures are mottled.	The ambient temperature is high and the subject is poorly lit.	This is normal and does not indicate a malfunction. Choose a lower sensitivity.	63
Smear appears in pictures.	The sun or another bright object was in the frame.	White or purple vertical lines may appear when a very bright object is framed in the display. This is normal and does not indicate a malfunction. Smear is not recorded in photographs but may appear in movies. If possible, avoid shooting movies with bright objects in or close to the frame.	104	

Playback

Problem		Possible cause	Solution	Page
Pictures	Pictures are grainy.	The pictures were taken with a different make or model of camera.	—	—
	Playback zoom unavailable.	The pictures were taken in  modes, at an image size of  , saved as  Blog Images, or with a different make or model of camera.	—	—
Audio	No sound in voice memo and movie playback.	Playback volume is too low.	Adjust playback volume.	89
		The microphone was obstructed.	Hold the camera correctly during recording.	45, 80
		The speaker is obstructed.	Hold the camera correctly during playback.	48, 81
Deletion	Selected pictures are not deleted.	Some of the pictures selected for deletion are protected.	Remove protection using the device with which it was originally applied.	75
Frame no.	File numbering is unexpectedly reset.	The battery-chamber cover was opened while the camera was on.	Turn the camera off before opening the battery-chamber cover to replace the battery or insert a memory card.	88

Connections



	Problem	Possible cause	Solution	Page
TV	Nothing displayed on camera monitor.	Camera is connected to TV.	Nothing is displayed on the camera monitor while the camera is connected to a TV.	49
	No picture or sound.	The camera is not properly connected.	Connect the camera correctly.	49
		The supplied A/V cable was connected during movie playback.	Connect the camera once movie playback has ended.	48, 49
		Input on the television is set to "TV".	Set input to "VIDEO".	—
		The camera is not set to the correct video standard.	Match the camera  VIDEO SYSTEM setting to the TV.	48, 83
	The volume on the television is too low.	Adjust the volume.	—	
No color.	The camera is not set to the correct video standard.	Match the camera  VIDEO SYSTEM setting to the TV.	48, 83	
Computer	The computer does not recognize the camera.	The camera is not properly connected.	Connect the camera correctly.	59
PictBridge	Pictures can not be printed.	The camera is not properly connected.	Connect the camera correctly.	50
		The printer is off.	Turn the printer on.	—
	Only one copy is printed. The date is not printed.	The printer is not PictBridge-compatible.	—	—





Miscellaneous











Problem	Possible cause	Solution	Page
Nothing happens when the shutter button is pressed.	Temporary camera malfunction.	Remove and reinsert the battery.	6
	The battery is exhausted.	Charge the battery or insert a fully-charged spare battery.	4, 6
The camera does not function as expected.	Temporary camera malfunction.	Remove and reinsert the battery. If the problem persists, contact your FUJIFILM dealer.	6
The camera accidentally turns off.	The memory card has been inserted or pulled out.	Insert the memory card, close the battery-chamber cover, and then turn on the camera.	9
No sound.	The camera is in silent mode.	Turn silent mode off.	36
I want to charge the battery while overseas.	Check the label on the battery charger.	The battery charger can be used with voltages of 100–240 V. Consult your travel agent for information on plug adapters.	92



Warning Messages and Displays

The following warnings are displayed in the monitor:

Warning	Description	Solution
 (red)	Low battery.	Charge the battery or insert a fully-charged spare battery.
 (blinks red)	Battery exhausted.	
	Slow shutter speed. Picture may be blurred.	Use the flash or mount the camera on a tripod.
!AF (displayed in red with red focus frame)	The camera can not focus.	<ul style="list-style-type: none">• Use focus lock to focus on another subject at the same distance, then recompose the picture (pg. 30).• If the subject is poorly lit, try focusing at a distance of about 2 m (6ft. 7 in.).• Use macro mode to focus when taking close-ups.
Aperture or shutter speed displayed in red	The subject is too bright or too dark. The picture will be over- or under-exposed.	If the subject is dark, use the flash.
FOCUS ERROR	Camera malfunction.	Turn the camera off and then on again, taking care not to touch the lens. If the message persists, contact a FUJIFILM dealer.
TURN OFF THE CAMERA AND TURN ON AGAIN		
NO CARD	No memory card inserted when COPY is selected in the playback menu.	Insert a memory card.
CARD NOT INITIALIZED	The memory card or internal memory is not formatted.	Format the memory card or internal memory (pg. 87).
	The memory card contacts require cleaning.	Clean the contacts with a soft, dry cloth. If the message is repeated, format the memory card (pg. 87). If the message persists, replace the memory card.
	Camera malfunction.	Contact a FUJIFILM dealer.

Warning	Description	Solution
CARD ERROR	The memory card is not formatted for use in the camera.	Format the memory card (pg. 87).
	The memory card contacts require cleaning or the memory card is damaged.	Clean the contacts with a soft, dry cloth. If the message is repeated, format the memory card (pg. 87). If the message persists, replace the memory card.
	Camera malfunction.	Contact a FUJIFILM dealer.
 MEMORY FULL	The memory card or internal memory is full; pictures can not be recorded or copied.	Delete pictures or insert a memory card with more free space.
 MEMORY FULL		
INTERNAL MEMORY IS FULL INSERT A NEW CARD		
WRITE ERROR	Memory card error or connection error.	Re-insert the memory card or turn the camera off and then on again. If the message persists, contact a FUJIFILM dealer.
	Not enough memory remaining to record additional pictures.	Delete pictures or insert a memory card with more free space.
	The memory card or internal memory is not formatted.	Format the memory card or internal memory (pg. 87).
PROTECTED CARD	The memory card is locked.	Unlock the memory card (pg. 8).
BUSY	The memory card is incorrectly formatted.	Use the camera to format the memory card (pg. 87).
FRAME NO. FULL	The camera has run out of frame numbers (current frame number is 999-9999).	Format the memory card (pg. 87) and select RENEW for the  FRAME NO. option in the setup menu. Take a picture to reset frame numbering to 100-0001, then return to the  FRAME NO. menu and select CONT.

Warning	Description	Solution
READ ERROR	The file is corrupt or was not created with the camera.	The file can not be played back.
	The memory card contacts require cleaning.	Clean the contacts with a soft, dry cloth. If the message is repeated, format the memory card (pg. 87). If the message persists, replace the memory card.
	Camera malfunction.	Contact a FUJIFILM dealer.
PROTECTED FRAME	An attempt was made to delete, rotate, or add a voice memo to a protected picture.	Remove protection before deleting, rotating, or adding voice memos to pictures.
 ERROR	Voice memo file is corrupt.	The voice memo can not be played back.
	Camera malfunction.	Contact a FUJIFILM dealer.
 NO IMAGE	The source device selected in the playback COPY menu contains no pictures.	Select a different source.
 NO IMAGE		
 CAN NOT CROP	An attempt was made to crop a OSM picture.	These pictures can not be cropped.
CAN NOT CROP	The picture selected for cropping is damaged or was not created with the camera.	
 CAN NOT CROP	An attempt was made to crop a blog image.	
DPOF FILE ERROR	The DPOF print order on the current memory card contains more than 999 images.	Copy the pictures to internal memory and create a new print order.
CAN NOT SET DPOF	The picture can not be printed using DPOF.	—
 CAN NOT SET DPOF	Movies can not be printed using DPOF.	—
CAN NOT ROTATE	The picture can not be rotated.	—
 CAN NOT ROTATE	Movies can not be rotated.	—
 CAN NOT EXECUTE	EDIT FOR BLOG and RED EYE REMOVAL can not be used with movies, pictures created with other devices, pictures that can not be viewed, or pictures created using EDIT FOR BLOG .	—
 CAN NOT EXECUTE		
 CAN NOT EXECUTE		
 CAN NOT EXECUTE		

Warning	Description	Solution
 CAN NOT EXECUTE	The shutter button was pressed in  mode when the battery was low.	Charge the battery or insert a fully-charged spare battery.
 CAN NOT EXECUTE	The successive movie file has been overwritten or renamed by computer or other make of camera.	Clips can not be added to files that have been overwritten or renamed by a computer or other make of camera.
PRESS AND HOLD THE DISP BUTTON TO DEACTIVATE SILENT MODE	An attempt was made to choose a flash mode or adjust the volume with the camera in silent mode.	Exit silent mode before choosing a flash mode or adjusting the volume.
COMMUNICATION ERROR	A connection error occurred while pictures were being printed or copied to a computer or other device.	Confirm that the device is turned on. If the device is connected via USB, check that the cable is connected.
PRINTER ERROR	Printer out of paper or ink, or other printer error.	Check printer (see printer manual for details). To resume printing, turn the printer off and then turn it back on.
PRINTER ERROR RESUME?		Check printer (see printer manual for details). If printing does not resume automatically, press MENU/OK to resume.
CAN NOT BE PRINTED	An attempt was made to print a movie, a picture not created with the camera, or a picture in a format not supported by the printer.	Movies and some pictures created with other devices can not be printed. If the picture was created with the camera, check the printer manual to confirm that the printer supports the JFIF-JPEG or Exif-JPEG format. If it does not, the pictures can not be printed.

Glossary

Digital zoom: Unlike optical zoom, digital zoom does not increase the amount of visible detail. Instead, details visible using optical zoom are simply enlarged, producing a slightly “grainy” image.

DPOF (Digital Print Order Format): A standard that allows pictures to be printed from “print orders” stored in internal memory or on a memory card. The information in the order includes the pictures to be printed and the number of copies of each picture.



EV (Exposure Value): The exposure value is determined by the sensitivity of the image sensor and the amount of light that enters the camera while the image sensor is exposed. Each time the amount of light doubles, EV increases by one; each time the amount of light is halved, EV decreases by one. The amount of light entering the camera can be controlled by adjusting aperture and shutter speed.

Exif Print: A standard that allows information stored with pictures to be used for optimal color reproduction during printing.

JPEG (Joint Photographic Experts Group): A compressed file format for color images. The higher the compression rate, the greater the loss of information and more noticeable drop in quality when the picture is displayed.

Smear: A phenomenon specific to CCDs which causes white streaks to appear when very bright light sources, such as the sun or reflected sunlight, appear in the frame.

WAV (Waveform Audio Format): A standard Windows audio file format. WAV files have the extension “*.WAV” and may be compressed or uncompressed. The camera uses uncompressed WAV. WAV files can be played using Windows Media Player or QuickTime 3.0 or later.

White balance: The human brain automatically adapts to changes in the color of light, with the result that objects that appear white under one light source still appear white when the color of the light source changes. Digital cameras can mimic this adjustment by processing images according to the color of the light source. This process is known as “white balance.”





















Internal Memory/Memory Card Capacity

The following table shows the recording time or number of pictures available at different image qualities. All figures are approximate; file size varies with the scene recorded, producing wide variations in the number of files that can be stored. The number of exposures or length remaining may not diminish at an even rate.

Image Size	Image Quality (still images)								Movie Quality		
	12M	10M 3:2	9M 16:9	6M	3M	2M 16:9	2M	03M	iHD 1280	640	320
Internal memory (approx. 13 MB)	1	1	2	3	7	11	12	43	2 sec.	10 sec.	20 sec.
1 GB	160	180	220	320	590	890	960	3,250	6 min.	10 min.	30 min.
2 GB	310	360	430	620	1,170	1,720	1,830	6,020	10 min.	20 min.	50 min.
4 GB	650	750	880	1,310	2,430	3,540	3,770	12,410	20 min.*	50 min.*	120 min.*
8 GB	1,270	1,480	1,730	2,550	4,750	6,920	7,510	24,210	40 min.*	110 min.*	240 min.*
16 GB	2,560	2,990	3,520	5,120	9,570	13,850	15,080	48,650	90 min.*	230 min.*	480 min.*

* A movie recording will stop automatically when a movie file becomes approx. 2GB or 15 min. If you want to continue recording, press the shutter button again. The available recording time is displayed based on approx. 2GB.

Specifications

System	
Model	FinePix XP10 series digital camera
Effective pixels	12.0 million
CCD	½.33-in., square-pixel CCD with primary color filter
Storage media	<ul style="list-style-type: none"> • Internal memory (approx. 13 MB) • SD/SDHC memory cards (see page 8)
File system	Compliant with Design Rule for Camera File System (DCF), Exif 2.2, and Digital Print Order Format (DPOF)
File format	<ul style="list-style-type: none"> • Still pictures: Exif 2.2 JPEG (compressed) • Movies: Motion JPEG AVI • Audio: Monaural WAV
Image size (pixels)	<ul style="list-style-type: none"> • 12M: 4,000 × 3,000 • 10M 3:2: 3,984 × 2,656 • 9M 16:9: 4,000 × 2,248 • 6M: 2,816 × 2,112 • 3M: 2,048 × 1,536 • 2M 16:9: 1,920 × 1,080 • 2M: 1,600 × 1,200 • 03M: 640 × 480
Lens	Fujinon 5 × optical zoom lens, f/4.0 (wide angle) – 4.8 (telephoto)
Focal length	F = 6.4 mm – 32.0 mm (35-mm format equivalent: 36 mm – 180 mm)
Digital zoom	Still images: approx. 6.3 × (up to 31.5 × when combined with optical zoom)
Aperture	[Wide angle] F4.0 to F6.7 (two steps) / [Telephoto] F4.8 to F8.0 (two steps)
Focus range (distance from front of lens)	Approx. 60 cm (2 ft.) – infinity (wide angle) / Approx. 1.0 m (3.2 ft.) – infinity (telephoto) Macro mode: approx. 9 cm – 80 cm / 3.5 in. – 2 ft. 7 in. (wide angle); 1 m – 3 m / 3.2 ft. – 9 ft. 11 in. (telephoto)
Sensitivity	Equivalent to ISO 100, 200, 400, 800, 1600; AUTO (Standard Output Sensitivity)
Metering	256-segment through-the-lens (TTL) metering using CCD image sensor
Exposure control	Programmed autoexposure
Exposure compensation	–2 EV – +2 EV in increments of ⅓ EV (P and  modes)
Scene modes	 (SCENE RECOGNITION),  (AUTO), P (PROGRAM AE),  (NATURAL &  (Dual Shot Mode)),  (NATURAL LIGHT),  (PORTRAIT),  (PORTRAIT ENHANCER),  (LANDSCAPE),  (SPORT),  (NIGHT),  (NIGHT (TRIPOD)),  (SUNSET),  (SNOW),  (BEACH),  (UNDERWATER),  (PARTY),  (FLOWER),  (TEXT),  (AUCTION MODE),  (SUCCESSIVE MOVIE)
Image Stabilization	Available
Intelligent Face Detection	Available

System	
Shutter speed	4 s– $\frac{1}{2,000}$ s; combined mechanical and electronic shutter
Continuous	• TOP 3: Up to 1 fps; max. 3 frames
Focus	• Mode: Single AF • Autofocus system: Contrast-detect TTL AF • Focus-area selection: AF CENTER and TRACKING
White balance	Automatic scene detection; six manual preset modes for direct sunlight, shade, daylight fluorescent, warm white fluorescent, cool white fluorescent, and incandescent lighting
Self-timer	Couple timer/Group timer/Approx. 2 sec./10 sec.
Flash	Auto flash; effective range when sensitivity is set to AUTO is approx. 70 cm–3.1 m/2 ft. 4 in.–10 ft. 1 in. (wide angle), 70 cm–2.7 m/2 ft. 4 in.–8 ft. 9 in. (telephoto), or 30 cm–80 cm/1 ft.–2 ft. 7 in. (macro mode)
Flash modes	Auto, fill flash, off, slow sync (red-eye removal off); auto with red-eye removal, fill flash with red-eye removal, off, slow sync with red-eye removal (red-eye removal on)
Monitor	2.7-in., 230k-dot color LCD monitor; frame coverage approx. 96%
Movies	Camera can record movies with monaural sound and a frame size of 1280×720, 640×480 or 320×240 at a frame rate of 30 fps
Shooting options	Scene recognition, Intelligent Face Detection with red-eye removal, high-speed shooting, best framing, and frame number memory
Playback options	Intelligent Face Detection, red-eye removal, micro thumbnail, edit for blog, movie edit, crop (still pictures), resize, slide show, transition, multi-frame playback, image rotation, voice memo, and image search
Other options	PictBridge, Exif Print, FinePix COLOR, language selection (Arabic, Simplified Chinese, Traditional Chinese, Czech, Danish, Dutch, English, Finnish, French, German, Greek, Hungarian, Italian, Japanese, Korean, Lithuanian, Norwegian, Persian, Polish, Portuguese, Russian, Slovak, Spanish, Swedish, Thai, Turkish and Ukrainian), time difference, silent mode
Input/output terminals	
A/V OUT (audio/video output)	NTSC or PAL with monaural sound
Digital input/output	USB 2.0 High Speed with MTP/PTP connection

Power supply/other	
Power sources	NP-45A rechargeable battery
Battery life (NP-45A)	Approx. 165 frames, based on CIPA standard. Based on included battery, measured when using SD memory card. Note that the number of shots that can be taken cannot be guaranteed and will be reduced in lower temperatures.
Camera dimensions	95.6 mm × 63.8 mm × 23.2 mm/3.7 in. × 2.5 in. × 0.9 in., excluding projecting parts, measured at the thinnest part
Camera weight	Approx. 135 g/4.7 oz., excluding battery, accessories, and memory cards
Shooting weight	Approx. 152 g/5.3 oz., including battery and memory card
Operating conditions	• Temperature: -10°C – +40°C/+14°F – +104°F • Humidity: 10%–85% (no condensation)
Standards of waterproof and dustproof	Equivalent to IP68
Pressure resistance	Up to 3 m (9.8 ft.) deep in water
Shock resistance	Passed in-house drop test (1 m [3 ft. 3 in.] fall onto a 5 cm [1.5 in.] thick plywood surface) in accordance with MIL-Standard 810F Method 516.5-Shock

NP-45A rechargeable battery		BC-45B battery charger	
Nominal voltage	DC 3.7V	Rated input	100–240V AC, 50/60Hz
Nominal capacity	720mAh	Input capacity	6 VA (100V/240V)
Dimensions (W × H × D)	31.0 mm × 39.6 mm × 6.0 mm/ 1.2 in. × 1.6 in. × 0.2 in.	Rated output	4.2V DC, 550 mA
Weight	Approx. 15 g/1.0 oz.	Supported batteries	NP-45 rechargeable battery
		Charging time	Approx. 110 +/- 20% minutes (measured at +25°C (+77°F))
		Dimensions (W × H × D)	91 mm × 46 mm × 23 mm/ 3.6 in. × 1.8 in. × 0.9 in., excluding projections
		Weight	Approx. 65 g/2.2 oz., excluding battery
		Operating temperature	0°C – +42°C/+32°F – +107°F

* The weight and dimensions vary depending on the country or region of sale.

Notes on the Battery and Battery Charger

- The battery and charger may become warm to the touch during charging. This is normal and does not indicate a malfunction. If possible, charge the battery in a well-ventilated location.
- The battery charger may vibrate when in use. This is normal and does not indicate a malfunction.
- If the charger causes radio interference, increase the distance between the charger and the radio receiver.
- Do not leave the charger in locations that are very dusty or exposed to strong vibration, extreme humidity, or high temperatures (for example, in direct sunlight or next to a heater).
- The battery charger can be used with input voltages of 100–240V AC and 50 or 60Hz. The shape of the plug varies with the country of sale; consult your travel agent to determine whether the charger can be used abroad.

Color Television Systems

NTSC (National Television System Committee) is a color television telecasting specification adopted mainly in the U.S.A., Canada, and Japan. PAL (Phase Alternation by Line) is a color television system adopted mainly in European countries and China.

Notices

- Specifications subject to change without notice. FUJIFILM shall not be held liable for damages resulting from errors in this manual.
- Although the monitor is manufactured using advanced high-precision technology, small bright points and anomalous colors (particularly in the vicinity of text) may appear. This is normal for this type of monitor and does not indicate a malfunction; images recorded with the camera are unaffected.
- Digital cameras may malfunction when exposed to strong radio interference (e.g., electric fields, static electricity, or line noise).
- Due to the type of lens used, some distortion may occur at the periphery of images. This is normal.

Caring for the Camera

To ensure continued enjoyment of the product, observe the following precautions.

Storage and Use

If the camera will not be used for an extended period, remove the battery and memory card. Do not store or use the camera in locations that are:

- exposed to rain, steam, or smoke
- very humid or extremely dusty
- exposed to direct sunlight or very high temperatures, such as in a closed vehicle on a sunny day
- extremely cold
- subject to strong vibration
- exposed to strong magnetic fields, such as near a broadcasting antenna, power line, radar emitter, motor, transformer, or magnet
- in contact with volatile chemicals such as pesticides
- next to rubber or vinyl products

■ Condensation

Sudden increases in temperature, such as occur when entering a heated building on a cold day, can cause condensation inside the camera. If this occurs, turn the camera off and wait an hour before turning it on again. If condensation forms on the memory card, remove the card and wait for the condensation to dissipate.

Cleaning

Use a blower to remove dust from the lens and monitor, then gently wipe with a soft, dry cloth. Any remaining stains can be removed by wiping gently with a piece of FUJIFILM lens-cleaning paper to which a small amount of lens-cleaning fluid has been applied. Care should be taken to avoid scratching the lens or monitor. The camera body can be cleaned with a soft, dry cloth. Do not use alcohol, thinner, or other volatile chemicals.

Travelling

Keep the camera in your carry-on baggage. Checked baggage may suffer violent shocks that could damage the camera.

IMPORTANT SAFETY INSTRUCTIONS

- **Read Instructions:** All the safety and operating instructions should be read before the appliance is operated.
- **Retain Instructions:** The safety and operating instructions should be retained for future reference.
- **Heed Warnings:** All warnings on the appliance and in the operating instructions should be adhered to.
- **Follow Instructions:** All operating and use instructions should be followed.

Installation

Power Sources: This video product should be operated only from the type of power source indicated on the marking label. If you are not sure of the type of power supply to your home, consult your appliance dealer or local power company. For video products intended to operate from battery power, or other sources, refer to the operating instructions.

Grounding or Polarization: This video product is equipped with a polarized alternating-current line plug (a plug having one blade wider than the other). This plug will fit into the power outlet only one way. This is a safety feature. If you are unable to insert the plug fully into the outlet, try reversing the plug. If the plug should still fail to fit, contact your electrician to replace

your obsolete outlet. Do not defeat the safety purpose of the polarized plug.

Alternate Warnings: This video product is equipped with a 3-wire grounding-type plug, a plug having a third (grounding) pin. This plug will only fit into a grounding-type power outlet. This is a safety feature. If you are unable to insert the plug into the outlet, contact your electrician to replace your obsolete outlet. Do not defeat the safety purpose of the grounding-type plug.

Overloading: Do not overload wall outlets and extension cords as this can result in a risk of fire or electric shock.

Ventilation: Slots and openings in the cabinet are provided for ventilation and to ensure reliable operation of the video product and to protect it from overheating, and these openings must not be blocked or covered. The openings should never be blocked by placing the video product on a bed, sofa, rug, or other similar surface. This video product should not be placed in a built-in installation such as a bookcase or rack unless proper ventilation is provided or the

manufacturer's instructions have been adhered to. This video product should never be placed near or over a radiator or heat register.

Attachments: Do not use attachments not recommended by the video product manufacturer as they may cause hazards.

Water and Moisture: Do not use this video product near water – for example, near a bath tub, wash bowl, kitchen sink, or laundry tub, in a wet basement, or near a swimming pool, and the like.

Power-Cord Protection: Power-Supply cords should be routed so that they are not likely to be walked on or pinched by items placed upon or against them, paying particular attention to cords at plugs, convenience receptacles, and the point where they exit from the appliance.

Accessories: Do not place this video product on an unstable cart, stand, tripod, bracket, or table. The video product may fall, causing serious injury to a child or adult, and serious damage to the appliance. Use only with a cart, stand, tripod, bracket, or table recommended by the manufacturer, or sold with the video product. Any mounting

of the appliance should follow the manufacturer's instructions, and should use a mounting accessory recommended by the manufacturer.

An appliance and cart combination should be moved with care. Quick stops, excessive force, and uneven surfaces may cause the appliance and cart combination to overturn.



Antennas

Outdoor Antenna Grounding: If an outside antenna or cable system is connected to the video product, be sure the antenna or cable system is grounded so as to provide some protection against voltage surges and built-up static charges. Section 810 of the National Electrical Code, ANSI/NFPA No. 70, provides information with respect to proper grounding of the mast and supporting structure, grounding of the lead-in wire to an antennadischarge unit, size of grounding conductors, location of antenna-discharge unit, connection to grounding electrodes, and requirements for the grounding electrode.

Power Lines: An outside antenna system should not be located in the vicinity of overhead power lines or other electric light or power circuits, or where it can fall into such power lines or circuits. When installing an outside antenna system, extreme care should be taken to keep from touching such power lines or circuits as contact with them might be fatal.

EXAMPLE OF ANTENNA GROUNDING AS PER NATIONAL ELECTRICAL CODE

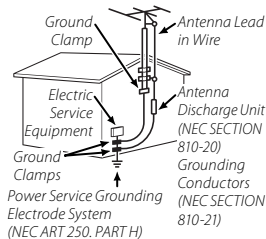

Use

Cleaning: Unplug this video product from the wall outlet before cleaning. Do not use liquid cleaners or aerosol cleaners. Use a damp cloth for cleaning.

Object and Liquid Entry: Never push objects of any kind into this video product through openings as they may touch dangerous voltage points or shortout parts that could result in a fire or electric shock.

Never spill liquid of any kind on the video product.

Lightning: For added protection for this video product receiver during a lightning storm, or when it is left unattended and unused for long periods of time, unplug it from the wall outlet and disconnect the antenna or cable system. This will prevent damage to the video product due to lightning and power-line surges.

Service

Service: Do not attempt to service this video product yourself as opening or removing covers may expose you to dangerous voltage or other hazards. Refer all servicing to qualified service personnel.

Damage Requiring Service: Unplug this video product from the wall outlet and refer servicing to qualified service personnel under the following conditions:

- When the power-supply cord or plug is damaged.
- If liquid has been spilled, or objects have fallen into the video product.
- If the video product has been exposed to rain or water.
- If the video product has been dropped or the cabinet has been damaged.
- If the video product does not operate normally by following the operating instructions. Adjust only

those controls that are covered by the operating instructions as an improper adjustment of other controls may result in damage and will often require extensive work by a qualified technician to restore the video product to its normal operation.

When the video product exhibits a distinct change in performance - this indicates a need for service.

Replacement Parts:

When replacement parts are required, be sure the service technician has used replacement parts specified by the manufacturer or have the same characteristics as the original part. Unauthorized substitutions may result in fire, electric shock or other hazards.

Safety Check: Upon completion of any service or repairs to this video product, ask the service technician to perform safety checks to determine that the video product is in proper operating condition.

Be sure to read this notes before using

Safety Notes

- Make sure that you use your camera correctly. Read these Safety Notes and your Owner's Manual carefully before use.
- After reading these Safety Notes, store them in a safe place.

About the Icons

- The icons shown below are used in this document to indicate the severity of the injury or damage that can result if the information indicated by the icon is ignored and the product is used incorrectly as a result.



WARNING

This icon indicates that death or serious injury can result if the information is ignored.



CAUTION

This icon indicates that personal injury or material damage can result if the information is ignored.

The icons shown below are used to indicate the nature of the information which is to be observed.



Triangular icons tell you that this information requires attention ("important").



Circular icons with a diagonal bar tell you that the action indicated is prohibited ("Prohibited").



Filled circles with an exclamation mark tell you an action that must be performed ("Required").

WARNING



Unplug
from power
socket

If a problem arises, turn the camera off, remove the battery, disconnect and unplug the AC power adapter.

Continued use of the camera when it is emitting smoke, is emitting any unusual odor, or is in any other abnormal state can cause a fire or electric shock.

- Contact your FUJIFILM dealer.



Do not allow water or foreign objects to enter the camera.

If water or foreign objects get inside the camera, turn the camera off, remove the battery and disconnect and unplug the AC power adapter. Continued use of the camera can cause a fire or electric shock.

- Contact your FUJIFILM dealer.



Do not use in
the bathroom
or shower

Do not use the camera in the bathroom or shower.

This can cause a fire or electric shock.



Do not
disassemble

Never attempt to change or take apart the camera. (Never open the casing.) Do not use the camera when it has been dropped or the casing is damaged.

This can cause a fire or electric shock.

- Contact your FUJIFILM dealer.



Do not change, heat or unduly twist or pull the connection cord and do not place heavy objects on the connection cord.

These actions could damage the cord and cause a fire or electric shock.

- If the cord is damaged, contact your FUJIFILM dealer.



Do not place the camera on an unstable surface.

This can cause the camera to fall or tip over and cause injury.



Never attempt to take pictures while in motion.

Do not use the camera while you are walking or driving a vehicle. This can result in you falling down or being involved in a traffic accident.



Do not touch any metal parts of the camera during a thunderstorm.

This can cause an electric shock due to induced current from the lightning discharge.



Do not use the battery except as specified.

Load the battery as aligned with the indicator.

! WARNING

Do not heat, change or take apart the battery. Do not drop or subject the battery to impacts. Do not store the battery with metallic products. Do not use chargers other than the specified model to charge the battery.

Any of these actions can cause the battery to burst or leak and cause fire or injury as a result.



Use only the battery or AC power adapters specified for use with this camera. Do not use voltages other than the power supply voltage shown.

The use of other power sources can cause a fire.



If the battery leaks and fluid gets in contact with your eyes, skin or clothing. Flush the affected area with clean water and seek medical attention or call an emergency number right away.



Do not use the charger to charge batteries other than those specified here.

The Ni-MH battery charger is designed for Fujifilm HR-AA Ni-MH batteries. Using the charger to charge conventional batteries or other types of rechargeable batteries can cause the battery to leak fluid, overheat or burst.



When carrying the battery, install it in a digital camera or keep it in the hard case. When storing the battery, keep it in the hard case. When discarding, cover the battery terminals with insulation tape.

Contact with other metallic objects or battery could cause the battery to ignite or burst.



Keep Memory Cards out of the reach of small children.

Because Memory Cards are small, they can be swallowed by children. Be sure to store Memory Cards out of the reach of small children. If a child swallows a Memory Card, seek medical attention or call an emergency number.

! CAUTION

Do not use this camera in locations affected by oil fumes, steam, humidity or dust.

This can cause a fire or electric shock.



Do not leave this camera in places subject to extremely high temperatures.

Do not leave the camera in locations such as a sealed vehicle or in direct sunlight. This can cause a fire.

! CAUTION

Keep out of the reach of small children.

This product could cause injury in the hands of a child.



Do not place heavy objects on the camera.

This can cause the heavy object to tip over or fall and cause injury.



Do not move the camera while the AC power adapter is still connected. Do not pull on the connection cord to disconnect the AC power adapter.

This can damage the power cord or cables and cause a fire or electric shock.



Do not use the AC power adapter when the plug is damaged or the plug socket connection is loose.

This could cause a fire or electric shock.



Do not cover or wrap the camera or the AC power adapter in a cloth or blanket.

This can cause heat to build up and distort the casing or cause a fire.



When you are cleaning the camera or you do not plan to use the camera for an extended period, remove the battery and disconnect and unplug the AC power adapter.

Failure to do so can cause a fire or electric shock.



When charging ends, unplug the charger from the power socket.

Leaving the charger plugged into the power socket can cause a fire.



Using a flash too close to a person's eyes may temporarily affect the eyesight.

Take particular care when photographing infants and young children.



When an xD-Picture Card is removed, the card could come out of the slot too quickly. Use your finger to hold it and gently release the card.



Request regular internal testing and cleaning for your camera.

Build-up of dust in your camera can cause a fire or electric shock.

- Contact your FUJIFILM dealer to request internal cleaning every 2 years.
- Please note this is not a free of charge service.

Power Supply and Battery

* Confirm your battery type before reading the following descriptions.

The following explains proper use of batteries and how to prolong their life. Incorrect use of batteries can cause shorter battery life, as well as leakage, excessive heat, fire or explosion.

1 Camera uses the Rechargeable Lithium-ion Battery

- * When shipped, the battery is not fully charged. Always charge the battery before using it.
- * When carrying the battery, install it in a digital camera or keep it in the soft case.

Battery Features

- The battery gradually loses its charge even when not used. Use a battery that has been charged recently (in the last day or two) to take pictures.
- To maximize the life of the battery, turn the camera off as quickly as possible when it is not being used.
- The number of available frames will be lower in cold locations or at low temperatures. Take along a spare fully charged battery. You can also increase the amount of power produced by putting the battery in your pocket or another warm place to heat it and then loading it into the camera just before you take a picture. If you are using a heating pad,

take care not to place the battery directly against the pad. The camera may not operate if you use a depleted battery in cold conditions.

Charging the Battery

- You can charge the battery using the battery charger (included).
- The battery can be charged at ambient temperatures between 0°C and +40°C (+32°F and +104°F). Refer to the OWNER'S MANUAL for the time of charging battery.
- You should charge the battery at an ambient temperature between +10°C and +35°C (+50°F and +95°F). If you charge the battery at a temperature outside this range, charging takes longer because the performance of the battery is impaired.
- You cannot charge the battery at temperatures of 0°C (+32°F) or below.
- The Rechargeable Lithium-ion Battery does not need to be fully discharged or exhausted flat before being charged.
- The battery may feel warm after it has been charged or immediately after being used. This is perfectly normal.
- Do not recharge a fully charged battery.

Battery Life

At normal temperatures, the battery can be used at least 300 times. If the time for which the battery provides power shortens markedly, this indicates that the battery has reached the end of its effective life and should be replaced.

Notes on storage

- If a battery is stored for long periods while charged, the performance of the battery can be impaired. If the battery will not be used for some time, run the battery out before storing it.
- If you do not intend to use the camera for a long period of time, remove the battery from the camera.
- Store the battery in a cool place.
 - The battery should be stored in a dry location with an ambient temperature between +15°C and +25°C (+59°F and +77°F).
 - Do not leave the battery in hot or extremely cold places.
- **Handling the Battery Cautions for Your Safety:**
 - Do not carry or store battery with metal objects such as necklaces or hairpins.
 - Do not heat the battery or throw it into a fire.
 - Do not attempt to take apart or change the battery.
 - Do not recharge the battery with chargers other than those specified.

- Dispose of used battery promptly.
- Do not drop the battery or otherwise subject it to strong impacts.
- Do not expose the battery to water.
- Always keep the battery terminals clean.
- Do not store batteries in hot places. Also, if you use the battery for a long period, the camera body and the battery itself will become warm. This is normal. Use the AC power adapter if you are taking pictures or viewing images for a long period of time.

2 Camera uses AA-size alkaline or Ni-MH (nickelmetal hydride) rechargeable batteries

- * For details on the batteries that you can use, refer to the OWNER'S MANUAL of your camera.
- **Cautions for Using Battery**
 - Do not heat the batteries or throw them into a fire.
 - Do not carry or store batteries with metal objects such as necklaces or hairpins.
 - Do not expose the batteries to water, and keep batteries from getting wet or stored in moist locations.
 - Do not attempt to take apart or change the batteries, including battery casings.
 - Do not subject the batteries to strong impacts.

- Do not use batteries that are leaking, deformed, discolored.
- Do not store batteries in warm or humid places.
- Keep the batteries out of reach of babies and small children.
- Make sure that the battery polarity (⊕ and ⊖) is correct.
- Do not use new with used batteries. Do not use charged and discharged batteries together.
- Do not use different types or brands of batteries at the same time.
- If you do not intend to use the camera for a long period of time, remove the batteries from the camera. Note if the camera is left with the batteries removed, the time and date settings are cleared.
- The batteries feel warm right after being used. Before removing the batteries, turn the camera off and wait for the batteries to cool down.
- Since batteries do not work well in cold weather or locations, warm the batteries by placing them inside your garments before use. Batteries do not work well when cold. They will work again when the temperature returns to normal.
- Soil (such as fingerprints) on the battery terminals makes the batteries charge less reducing the number of images. Carefully wipe the battery terminals with a soft dry cloth before loading.



If any liquid at all leaks from the batteries, wipe the battery compartment thoroughly and then load new batteries.



If any battery fluid comes into contact with your hands or clothing, flush the area thoroughly with water. Note that battery fluid can cause loss of eyesight if it gets into your eyes. If this occurs, do not rub your eyes. Flush the fluid out with clean water and contact your physician for treatment.

■ Using the AA-size Ni-MH batteries correctly

- Ni-MH batteries left unused in storage for long periods can become "deactivated". Also, repeatedly charging Ni-MH batteries that are only partially discharged can cause them to suffer from the "memory effect". Ni-MH batteries that are "deactivated" or affected by "memory" suffer from the problem of only providing power for a short time after being charged. To prevent this problem, discharge and recharge them several times using the camera's "Discharging rechargeable batteries" function. Deactivation and memory are specific to Ni-MH batteries and are not in fact battery faults. See OWNER'S MANUAL for the

procedure for "Discharging rechargeable batteries".

⚠ CAUTION

Do not use the "Discharging rechargeable batteries" function when alkaline batteries being used.

- To charge Ni-MH batteries, use the quick battery charger (sold separately). Refer to the instructions supplied with the charger to make sure that the charger is used correctly.
- Do not use the battery charger to charge other batteries.
- Note that the batteries feel warm after being charged.
- Due to the way the camera is constructed, a small amount of current is used even when the camera is turned off. Note in particular that leaving Ni-MH batteries in the camera for a long period will overdischarge the batteries and may render them unusable even after recharging.
- Ni-MH batteries will self-discharge even when not used, and the time for which they can be used may be shortened as a result.
- Ni-MH batteries will deteriorate rapidly if overdischarged (e.g. by discharging the batteries in a flashlight). Use the "Discharging rechargeable batteries" function provided in the camera to discharge the batteries.
- Ni-MH batteries have a limited service life. If a battery can only be

used for a short time even after repeated discharge-charge cycles, it may have reached the end of its service life.

■ Disposing of Batteries

- When disposing of batteries, do so in accordance with your local waste disposal regulations.

3 Notes on both models (1, 2)

■ AC Power Adapter

Always use the AC Power Adapter with the camera. The use of an AC Power adapter other than FUJIFILM AC Power Adapter can be damaged to your digital camera.

For details on the AC power adapter, refer to the OWNER'S MANUAL of your camera.

- Use the AC power adapter for indoor use only.
- Plug the connection cord plug securely into the DC input terminal.
- Turn off the FUJIFILM Digital camera before disconnecting the cord from the DC input terminal. To disconnect, pull out the plug gently. Do not pull on the cord.
- Do not use the AC power adapter with any device other than your camera.
- During use, the AC power adapter will become hot to the touch. This is normal.

- Do not take apart the AC power adapter. Doing so could be dangerous.
- Do not use the AC power adapter in a hot and humid place.
- Do not subject the AC power adapter to strong shocks.
- The AC power adapter may emit a humming. This is normal.
- If used near a radio, the AC power adapter may cause static. If this happens, move the camera away from the radio.

Before Using the Camera

■ Test Shots Prior to Photography

For important photographs (such as weddings and overseas trips), always take a test shot and view the image to make sure that the camera is working normally.

- FUJIFILM Corporation cannot accept liability for any incidental losses (such as the costs of photography or the loss of income from photography) incurred as a result of faults with this product.

■ Notes on Copyright

Images recorded using your digital camera system cannot be used in ways that infringe copyright laws without the consent of the owner, unless intended only for personal use. Note that some restrictions apply to the photographing of stage performances, entertainments and exhibits, even when intended

purely for personal use. Users are also asked to note that the transfer of Memory Card containing images or data protected under copyright laws is only permissible within the restrictions imposed by those copyright laws.

■ Handling Your Digital Camera

To ensure that images are recorded correctly, do not subject the camera to impact or shock while an image is being recorded.

■ Liquid Crystal

If the LCD monitor is damaged, take particular care with the liquid crystal in the monitor. If any of the following situations arise, take the urgent action indicated.

- If liquid crystal comes in contact with your skin:
Wipe the area with a cloth and then wash thoroughly with soap and running water.
- If liquid crystal gets into your eye:
Flush the affected eye with clean water for at least 15 minutes and then seek medical assistance.
- If liquid crystal is swallowed:
Flush your mouth thoroughly with water. Drink large quantities of water and induce vomiting. Then seek medical assistance.

■ Trademark Information

-  and **xD-Picture Card™** are trademarks of FUJIFILM Corporation.

- IBM PC/AT is a registered trademark of International Business Machines Corp. of the U.S.A.
- Macintosh, Quick-Time, and Mac OS are trademarks of Apple Inc. in the U.S.A. and other countries.
- Windows 7, Windows Vista and the Windows logo are trademarks of the Microsoft group of companies.
- IrSimple™ Trademark is owned by the Infrared Data Association®.
- IrSS™ Trademark or IrSimpleShot™ Trademark is owned by the Infrared Data Association®.
- SDHC logo is a trademark.
- HDMI logo is a trademark.
- YouTube is a trademark of Google Inc.
- Other company or product names are trademarks or registered trademarks of the respective companies.

■ Notes on Electrical Interference

If the camera is to be used in hospitals or aircrafts, please note that this camera may cause interference to other equipment in the hospital or aircraft. For details, please check with the applicable regulations.

■ Explanation of Color Television System

- NTSC: National Television System Committee, color television telecasting specifications adopted mainly in the U.S.A., Canada and Japan.
- PAL: Phase Alternation by Line, a color television system adopted mainly by European countries and China.

■ Exif Print (Exif ver. 2.2)

Exif Print Format is a newly revised digital camera file format that contains a variety of shooting information for optimal printing.

FUJIFILM

FUJIFILM Corporation

7-3, AKASAKA 9-CHOME, MINATO-KU, TOKYO 107-0052, JAPAN

<http://www.fujifilm.com/>

Free Manuals Download Website

<http://myh66.com>

<http://usermanuals.us>

<http://www.somanuals.com>

<http://www.4manuals.cc>

<http://www.manual-lib.com>

<http://www.404manual.com>

<http://www.luxmanual.com>

<http://aubethermostatmanual.com>

Golf course search by state

<http://golfingnear.com>

Email search by domain

<http://emailbydomain.com>

Auto manuals search

<http://auto.somanuals.com>

TV manuals search

<http://tv.somanuals.com>