

FUJIFILM

DIGITAL CAMERA

FinePix Z5fd

OWNER'S MANUAL

This manual will show you how to use your FUJIFILM DIGITAL CAMERA FinePix Z5fd correctly. Please follow the instructions carefully.

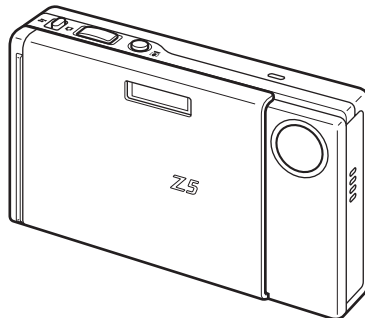

digital
tools for the imagination.



xD
xD-Picture Card™

Exif Print

PictBridge

Getting Ready

Using the Camera

Advanced Features • Photography

• Playback

• Movie

Settings

Camera Connection

Software
Installation

Appendices

Troubleshooting

BL00582-200(1) **E**

Warning

WARNINGS

To reduce the risk of fire or electric shock, do not expose the AC power adapter to rain or moisture.

The AC power adapter should not be exposed to dripping or splashing and that no objects filled with liquids, such as vases, should be placed on the AC power adapter.

IMPORTANT SAFETY INSTRUCTIONS

- Read these instructions.
- Keep these instructions.
- Heed all warnings.
- Follow all instructions.
- Do not use this apparatus near water.
- Clean only with dry cloth.
- Do not block any ventilation openings. Install in accordance with the manufacturer's instructions.
- Do not install near any heat sources such as radiators, heat registers, stoves, or other apparatus (including amplifiers) that produce heat.
- Protect the power cord from being walked on or pinched particularly at plugs, convenience receptacles, and the point where they exit from the apparatus.
- Only use attachments/accessories specified by the manufacturer.
- Unplug this apparatus during lightning storms or when unused for long periods of time.
- Refer all servicing to qualified service personnel. Servicing is required when the apparatus has been damaged in any way, such as power-supply cord or plug is damaged, liquid has been spilled or objects have fallen into the apparatus, the apparatus has been exposed to rain or moisture, does not operate normally, or has been dropped.

To prevent fire or shock hazard, do not expose the unit to rain or moisture.

For customers in the U.S.A.

*Tested To Comply
With FCC Standards
FOR HOME OR OFFICE USE*

FCC Statement

This device complies with Part 15 of the FCC Rules. Operation is subject to the following two conditions: (1) This device may not cause harmful interference, and (2) this device must accept any interference received, including interference that may cause undesired operation.

CAUTION

This equipment has been tested and found to comply with the limits for a Class B digital device, pursuant to Part 15 of the FCC Rules. These limits are designed to provide reasonable protection against harmful interference in a residential installation. This equipment generates, uses, and can radiate radio frequency energy and, if not installed and used in accordance with the instructions, may cause harmful interference to radio communications. However, there is no guarantee that interference will not occur in a particular installation. If this equipment does cause harmful interference to radio or television reception, which can be determined by turning the equipment off and on, the user is encouraged to try to correct the interference by one or more of the following measures:

- Reorient or relocate the receiving antenna.
- Increase the separation between the equipment and receiver.
- Connect the equipment into an outlet on a circuit different from that to which the receiver is connected.
- Consult the dealer or an experienced radio/TV technician for help.

You are cautioned that any changes or modifications not expressly approved in this manual could void the user's authority to operate the equipment.

Notes on the Grant:

To comply with Part 15 of the FCC Rules, this product must be used with a Fujifilm-specified ferrite-core A/V cable, USB cable, and DC supply cord.

For customers in Canada

CAUTION

This Class B digital apparatus complies with Canadian ICES-003.

Please read the Safety Notes (→p.157) and make sure you understand them before using the camera.

NOTICE

BEFORE OPENING THE CD-ROM PROVIDED BY FUJIFILM CORPORATION, PLEASE READ THIS END USER LICENSE AGREEMENT CAREFULLY. ONLY IF YOU AGREE WITH THIS AGREEMENT, SHOULD YOU USE THE SOFTWARE RECORDED ON THE CD-ROM. BY OPENING THE PACKAGE, YOU ACCEPT AND AGREE TO BE BOUND BY THIS AGREEMENT.

End User License Agreement

This End User License Agreement ("Agreement") is an agreement between FUJIFILM Corporation ("FUJIFILM") and you, which sets forth the terms and conditions of the license granted for you to use the software provided by FUJIFILM.

The CD-ROM contains third party software. In case a separate agreement is provided by a third party supplier for its software, the provisions of such separate agreement shall apply to the use of such third party software, prevailing over those of this Agreement.

1. Definitions.

- (a) "Media" means the CD-ROM titled "Software for FinePix CX" - which is provided to you together with this Agreement.
- (b) "Software" means the software which is recorded on Media.
- (c) "Documentation" means the operation manuals of Software and other related written materials which are provided to you together with Media.
- (d) "Product" means Media (including Software) and Documentation collectively.

2. Use of Software.

FUJIFILM grants to you a nontransferable, nonexclusive license:

- (a) to install one copy of Software onto one computer in binary machine executable form;
- (b) to use Software on the computer onto which Software is installed; and
- (c) to make one backup copy of Software.

3. Restrictions.

- 3.1 You shall not distribute, rent, lease or otherwise transfer all or any part of Software, Media or Documentation to any third party without FUJIFILM's prior written consent. You also shall not sublicense, assign or otherwise transfer all or any part of the rights granted to you by FUJIFILM under this Agreement without FUJIFILM's prior written consent.
- 3.2 Except as expressly granted by FUJIFILM hereunder, you shall not copy or reproduce all or any part of Software or Documentation.
- 3.3 You shall not modify, adapt or translate Software or Documentation. You also shall not alter or remove copyright and other proprietary notices that appear on or in Software or Documentation.
- 3.4 You shall not, or shall not have any third party, reverse-engineer, decompile, or disassemble Software.

4. Ownership.

All copyrights and other proprietary rights to Software and Documentation are owned and retained by FUJIFILM or the third party suppliers as indicated on or in Software or Documentation. Nothing contained herein shall be construed, expressly or implicitly, as transferring or granting any right, license, or title to you other than those explicitly granted under this Agreement.

5. Limited Warranty.

FUJIFILM warrants to you that Media is free from any defect in material and workmanship under normal use for ninety (90) days from the date of your receipt of Media. Should Media not meet the foregoing warranty, FUJIFILM shall replace such defective Media with other Media bearing no defect. FUJIFILM's entire liability and your sole and exclusive remedy with regard to any defect in Media shall be expressly limited to such FUJIFILM's replacement of Media as provided herein

6. DISCLAIMER OF WARRANTY.

EXCEPT AS PROVIDED IN SECTION 5 HEREIN, FUJIFILM PROVIDES PRODUCT "AS IS" AND WITHOUT WARRANTIES OF ANY KIND, EXPRESS OR IMPLIED. FUJIFILM SHALL MAKE NO WARRANTY, EXPRESS, IMPLIED OR STATUTORY, AS TO ANY OTHER MATTERS, INCLUDING, BUT NOT LIMITED TO NON-INFRINGEMENT OF ANY COPYRIGHT, PATENT, TRADE SECRET, OR ANY OTHER PROPRIETARY RIGHTS OF ANY THIRD PARTY, MERCHANTABILITY, OR FITNESS FOR ANY PARTICULAR PURPOSE.

7. LIMITATION OF LIABILITY.

IN NO EVENT SHALL FUJIFILM HAVE ANY LIABILITY FOR ANY GENERAL, SPECIAL, DIRECT, INDIRECT, CONSEQUENTIAL, INCIDENTAL, OR OTHER DAMAGES (INCLUDING DAMAGES FOR LOSS OF PROFITS OR LOST SAVINGS) INCURRED FROM THE USE OF OR INABILITY TO USE PRODUCT EVEN IF FUJIFILM HAS BEEN ADVISED OF THE POSSIBILITY OF SUCH DAMAGES.

8. No export.

You acknowledge that neither Software nor any part thereof, will be transferred, or exported to any country or used in any manner in violation of any export control laws and regulations to which Software is subject.

9. Termination.

In case you breach any of the terms and conditions hereof, FUJIFILM may immediately terminate this Agreement without any notice.

10. Term.

This Agreement is effective until the date when you cease to use Software, unless earlier terminated in accordance with Section 9 hereof.

11. Obligation upon termination.

Upon termination or expiration of this Agreement, you shall, at your own responsibility and expense, delete or destroy immediately all Software (including its copies), Media and Documentation.

12. Governing Law.

This Agreement shall be governed by and construed in accordance with laws of Japan.

EC Declaration of Conformity

We

Name: FUJIFILM Europe GmbH
Address: Heesenstrasse 31
40549 Dusseldorf, Germany

declare that the product

Product Name: FUJIFILM DIGITAL CAMERA FinePix Z5fd
Manufacturer's Name: FUJIFILM Corporation
Manufacturer's Address: MIDTOWN WEST, 7-3, AKASAKA 9-CHOME
MINATO-KU, TOKYO 107-0052, JAPAN

conforms to the following Standards:

Safety: EN60065
EMC: EN55022: 1998 Classe B
EN55024: 1998
EN61000-3-2: 1995 + A1: 1998 + A2: 1998

following the provision of the EMC Directive (89/336/EEC, 92/31/EEC and 93/68/EEC) and Low Voltage Directive (73/23/EEC).



Dusseldorf, Germany

November 1, 2006

Place

Date

Signature/Managing Director



This product comes with batteries. When these are empty, you shouldn't throw them away but deliver them as domestic chemical refuse.

Disposal of Electric and Electronic Equipment in Private Households

Disposal of used Electrical & Electronic Equipment (Applicable in the European Union and other European countries with separate collection systems)



This symbol on the product, or in the manual and in the warranty, and/or on its packaging indicates that this product shall not be treated as household waste.

Instead it should be taken to an applicable collection point for the recycling of electrical and electronic equipment.

By ensuring this product is disposed of correctly, you will help prevent potential negative consequences to the environment and human health, which could otherwise be caused by inappropriate waste handling of this product.

If your equipment contains easy removable batteries or accumulators please dispose these separately according to your local requirements.

The recycling of materials will help to conserve natural resources. For more detailed information about recycling of this product, please contact your local city office, your household waste disposal service or the shop where you have purchased the product.

In Countries outside the EU:

If you wish to discard this product, please contact your local authorities and ask for the correct way of disposal.



Contents

Warning.....	2
IMPORTANT	3
EC Declaration of Conformity.....	4
Disposal of Electric and Electronic Equipment in Private Households	5
Contents.....	6
Preface.....	8
About this Manual	10
Accessories Included	11
Camera Parts and Features.....	12
Example of LCD Monitor Text Display	13















Getting Ready

Loading the Battery	14
Charging the Battery	16
Loading the xD-Picture Card	18
Turning On and Off	20
Setting the language, date, and time	21
Correcting the Date and Time	23
Selecting the Language	24

Using the Camera

Taking Pictures (AUTO Mode).....	25
Using Intelligent Face Detection when taking pictures	28
Taking pictures with the focus and exposure locked	30
Adjusting the shot composition	32
Viewing the Images.....	33
 Erasing the Images/Movies.....	37
Using the erase button ( / ).....	37
Erasing from the PLAYBACK MENU	37

Advanced Features — Photography

Using the Shooting Functions — Procedure of Setting	40
Setting the Shooting Mode	42
Setting  Picture stabilization (Anti-blur) and  Natural & 	42
Setting a Shooting mode suited to the scene	43
 Macro (Close-up).....	48
 Setting the Flash (Intelligent Flash)	49
 Self-Timer	51
 Increasing Monitor Brightness	53
Using F -MODE MENU (Shooting)/ SHOOTING MENU	54
Setting the F -MODE MENU (Shooting) ...	54
Setting the SHOOTING MENU	54
F -MODE MENU (Shooting)	57
Changing the sensitivity setting ( ISO) ...	57
Changing the quality setting ( QUALITY).....	58
Changing the FinePix COLOR setting ( FinePix COLOR)	59
SHOOTING MENU.....	60
Adjusting exposure compensation ( EXP. COMPENSATION)	60
Adjusting color balance ( WHITE BALANCE)	61
Focusing the shot quickly ( HIGH-SPEED SHOOTING)	61
Taking pictures continuously ( CONTINUOUS).....	62

Specifying focusing mode (AF MODE).....	64
Advanced Features — Playback	
F -MODE MENU (Playback).....	66
Sending and receiving images	
(IR COMMUNICATION).....	66
Transmitting and saving blog images	
(TRIMMING FOR BLOG).....	69
Setting automatic playback	
(SLIDE SHOW).....	70
DPOF set frame	
(PRINT ORDER (DPOF)).....	71
Using PLAYBACK MENU.....	77
Setting the PLAYBACK MENU.....	77
Rotating the images	
(IMAGE ROTATE).....	78
Protecting the images (PROTECT).....	79
Copying the images (COPY).....	80
Adding voice memos to the images	
(VOICE MEMO).....	83
Trimming the images (TRIMMING).....	86
Advanced Features — Movie	
Recording Movies.....	88
Changing movie size.....	90
Playing Back Movies.....	91
Settings	
SET-UP.....	94
Using the SET-UP menu.....	94
SET-UP menu option.....	95

Camera Connection

Connecting to a TV.....	104
Connecting Camera Directly to Printer — PictBridge Function.....	105

Software Installation

Installation on a Windows PC.....	110
Installation on a Mac OS X.....	113
Connecting to a PC.....	116
Using FinePixViewer.....	119

Appendices

System Expansion Option.....	122
Accessories Guide.....	123
Using Your Camera Correctly.....	125
Power Supply and Battery.....	126
Notes on the xD-Picture Card™ and the Internal Memory.....	129
Warning Displays.....	131

Troubleshooting

Troubleshooting.....	135
----------------------	-----

Specifications.....	143
Explanation of Terms.....	149
FUJIFILM Digital Camera Worldwide	
Network.....	150
Safety Notes.....	157

Preface

■ Test Shots Prior to Photography

For important photographs (such as weddings and overseas trips), always take a test shot and view the image to make sure that the camera is working normally.

- FUJIFILM Corporation cannot accept liability for any incidental losses (such as the costs of photography or the loss of income from photography) incurred as a result of faults with this product.

■ Notes on Copyright

Images recorded using your digital camera system cannot be used in ways that infringe copyright laws without the consent of the owner, unless intended only for personal use. Note that some restrictions apply to the photographing of stage performances, entertainments and exhibits, even when intended purely for personal use. Users are also asked to note that the transfer of **xD-Picture Card** containing images or data protected under copyright laws is only permissible within the restrictions imposed by those copyright laws.

■ Handling Your Digital Camera

This camera contains precision electronic components. To ensure that images are recorded correctly, do not subject the camera to impact or shock while an image is being recorded.

■ Liquid Crystal

If the LCD monitor is damaged, take particular care with the liquid crystal in the monitor. If any of the following situations arise, take the urgent action indicated.

- If liquid crystal comes in contact with your skin
Wipe the area with a cloth and then wash thoroughly with soap and running water.
- If liquid crystal gets into your eye
Flush the affected eye with clean water for at least 15 minutes and then seek medical assistance.
- If liquid crystal is swallowed
Flush your mouth thoroughly with water. Drink large quantities of water and induce vomiting. Then seek medical assistance.

■ Trademark Information

-  and **xD-Picture Card™** are trademarks of FUJIFILM Corporation.
- IBM PC/AT is a registered trademark of International Business Machines Corp. of the U.S.A.
- Macintosh, Power Macintosh, iMac, PowerBook, iBook and Mac OS are trademarks of Apple Computer, Inc., registered in the U.S. and other countries.
- Microsoft, Windows, and the Windows logo are trademarks, or registered trademarks of Microsoft Corporation in the United States and/or other countries. Windows is an abbreviated term referring to the Microsoft® Windows® Operating System.
- * The “Designed for Microsoft® Windows® XP” logo refers to the camera and the driver only.
- IrSimple™ Trademark is owned by the Infrared Data Association®.
- Other company or product names are trademarks or registered trademarks of the respective companies.

■ Notes on Electrical Interference

If the camera is to be used in hospitals or aircrafts, please note that this camera may cause interference to other equipment in the hospital or aircraft. For details, please check with the applicable regulations.

■ Explanation of Color Television System

NTSC: National Television System Committee, color television telecasting specifications adopted mainly in the U.S.A., Canada and Japan.

PAL: Phase Alternation by Line, a color television system adopted mainly by European countries and China.

■ Exif Print (Exif ver. 2.2)

Exif Print Format is a newly revised digital camera file format that contains a variety of shooting information for optimal printing.

* See "Using Your Camera Correctly" (→p.125) for more information.

About this Manual

Macro (Close-up)

Use this mode to take close-up shots.

Available Shooting modes: **ON**, AUTO, **1**, **2**, **3**, **4**, **5**, **6**, **7**, **8**, **9**, **10**, **11**, **12**, **13**, **14**, **15**, **16**, **17**, **18**, **19**, **20**, **21**, **22**, **23**, **24**, **25**, **26**, **27**, **28**, **29**, **30**, **31**, **32**, **33**, **34**, **35**, **36**, **37**, **38**, **39**, **40**, **41**, **42**, **43**, **44**, **45**, **46**, **47**

Press **2** (▲) to select Macro mode.
Press **2** (▲) again to cancel Macro mode.

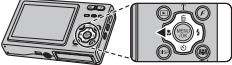

CHECK

- Focal range
Wide angle:
Approx. 8 cm to 80 cm (3.1 in. to 2.6 ft.)
Telephoto:
Approx. 45 cm to 80 cm (1.5 ft. to 2.6 ft.)
- Effective flash range
Approx. 30 cm to 80 cm (1.0 ft. to 2.6 ft.)

MEMO

- We recommend using a tripod to prevent camera shake in Macro mode.
- Any of the following cancels Macro mode:
 - Changing the Shooting mode setting
 - Turning the camera off
- Even if the **AF MODE** is set to **[] MULTI** (→p.64), the camera focuses near the center of the LCD monitor.

2 appears on the LCD monitor indicating that you can take close-up shots.

Icons indicate the modes that are available.

! CAUTION

This mark denotes issues that may affect the camera's operation.

✓ CHECK

This mark denotes points to notice in the camera's operation.

📄 MEMO

This mark denotes additional topics that complement the basic operating procedures.

■ 4-direction (▲▼◀▶) button

Up, down, left, and right are indicated by black triangles in the Owner's Manual. Up or down is shown as ▲ or ▼, and left or right is shown as ◀ or ▶.

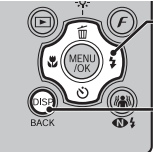

When pressing ▶:

When pressing DISP/BACK:



Accessories Included

- **Rechargeable Battery NP-40 (1)**
Soft case included



- **Strap (1)**

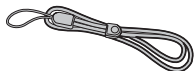

- **AC Power Adapter AC-5VZ (1 set)**

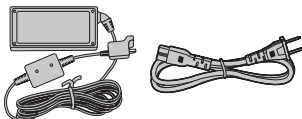

- **A/V cable (1)**

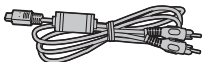

- **USB cable (1)**

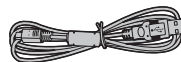

- **CD-ROM (1)**
Software for FinePix CX



- **Owner's Manual (this manual) (1)**

Attaching the strap

Attach the strap as shown in 1 and 2.
When attaching the strap, move the fastener to adjust the length and slightly away from the end of the strap, as shown in figure 1.

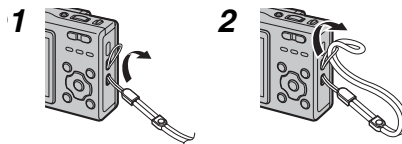

Camera Parts and Features

- Refer to the pages in parentheses for information on using the camera parts or features.

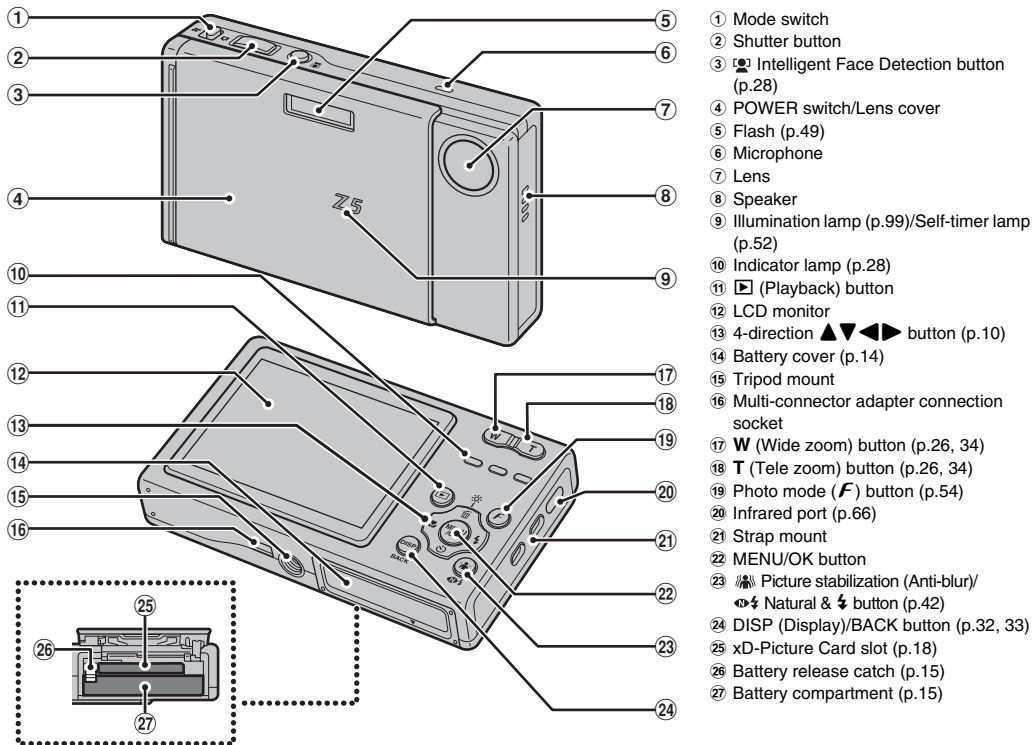

Example of LCD Monitor Text Display

Photography mode

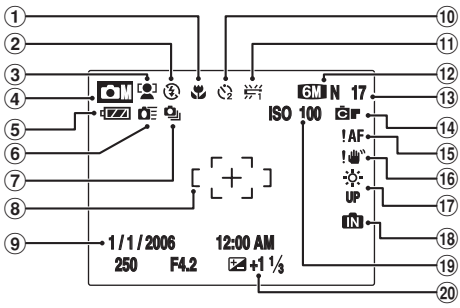

- 1 Macro (close-up) (p.48)
- 2 Flash (p.49)
- 3 Intelligent Face Detection (p.28)
- 4 Shooting mode (p.42)
- 5 Battery level indicator (p.17)
- 6 High-speed shooting (p.61)
- 7 Continuous shooting (p.62)
- 8 AF frame (p.26)
- 9 Date/Time (p.21)
- 10 Self-timer (p.51)
- 11 White balance (p.61)

- 12 **GMN** Quality mode (p.58)
- 13 Number of available frames (p.147)
- 14 FinePix COLOR (p.59)
- 15 **!** AF AF warning (p.131)
- 16 **!** Camera shake warning (p.131)
- 17 ***** Increasing monitor brightness (p.53)
- 18 **!** Internal memory (p.19)
- 19 ISO 100 Sensitivity (p.57)
- 20 Exposure compensation (p.60)

Playback mode

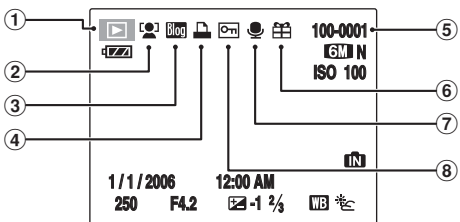

- 1 Playback mode (p.33)
- 2 Intelligent Face Detection (p.35)
- 3 Blog image (p.69)
- 4 DPOF (p.71)
- 5 Frame number (p.98)
- 6 Present (p.33)
- 7 Voice memo (p.83)
- 8 Protection (p.79)

FinePix Z5fd has internal memory that can store images without **xD-Picture Card**. **!** appears on the LCD monitor when the internal memory is active.

Loading the Battery

Battery is required to operate the digital camera. At first, load the battery in the camera.

Compatible battery

Rechargeable Battery NP-40 (1)

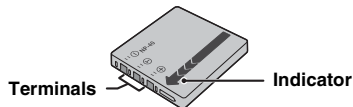

CAUTION

- The battery is not fully charged at shipment and must be fully charged before being used.
- Do not stick labels onto the battery as this could cause the battery to become jammed inside the camera.
- Any contact between the battery terminals could cause the battery to short circuit and overheat.
- See p.126-127 for information on the battery.
- Always use the Rechargeable Battery NP-40 (included). The use of other brands of rechargeable battery could cause faults or damage to the camera.

1 Open the battery cover.

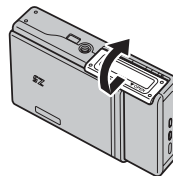

CHECK

Check that the camera is turned off before opening the battery cover.

CAUTION

- Do not open the battery cover while the camera is on. This could damage the **xD-Picture Card** or ruin the image files on the **xD-Picture Card**.
- Do not apply force to the battery cover.

2 Load the battery.

Make sure that the indicators are aligned. Push the battery release catch down while loading the battery. Check that the battery is firmly held in place.

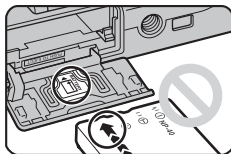
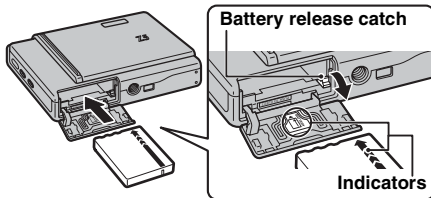

! CAUTION

Load the battery in the correct direction.

3 Close the battery cover.

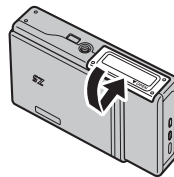

To remove the battery

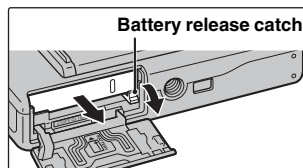

Open the battery cover, and unlock the battery release catch with your finger.

! CAUTION

Make sure the camera is turned off before removing the battery.

Charging the Battery

The battery is not fully charged at shipment and must be fully charged before being used.

Connecting the AC power adapter to the camera

① Connect the AC power adapter to the camera.

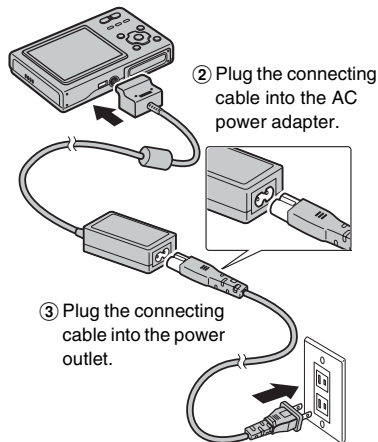

✓ CHECK

Loading the Battery (→p.14)

! CAUTION

- Always check that the camera is turned off.
- Make sure the AC power adapter is fully and securely inserted into the multi-connector adapter connection socket.

■ Using the AC power adapter

You can take pictures and play back images without worrying about depleting the battery.

! CAUTION

- Always use the FUJIFILM AC Power Adapter AC-5VZ (included).
- See p.128 for notes on using the AC power adapter.
- Only connect and disconnect the AC power adapter when the camera is off. Connecting or disconnecting the AC power adapter while the camera is on temporarily interrupts the power supply to the camera, which will stop the recording of images or movies being shot. Failing to turn the camera off before connecting/disconnecting can also result in damage to the **xD-Picture Card** or malfunctions during PC connection.
- The power outlet should be nearby the equipment and easily accessible.
- The shape of the plug and power outlet depends on the country of use.

Camera operation during charging

When connection is completed, battery charging begins. Charging ends after about 2 hours.

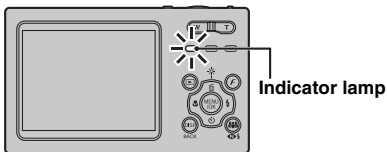

✓ CHECK Indicator lamp

[During charging] Lit red
 [Charging completed] Off
 [Charging error] Blinking red (→p.136)

Battery protection function

When you try to charge the battery immediately after the camera has been used continuously for a long period, charging may not begin soon (the indicator lamp does not turn red).

This is not a camera fault, but is for protecting the battery from being charged while it is warm. Battery may degrade when charged at high temperatures.

Leave the camera connected to the AC power adapter, and charging will automatically begin within 30 minutes.

! CAUTION Notes on charging the battery

- Turning the camera on during charging interrupts the charging.
- Charging times increase at low temperatures.

Checking the battery charge

Turn the camera on and check the battery level indicator on the LCD monitor.

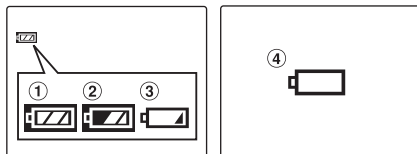

- ① There is ample battery charge. (Lit white)
- ② The battery is almost half charged. (Lit white)
- ③ There is insufficient charge left in the battery. The battery will soon run out. Have a charged battery ready. (Lit red)
- ④ The battery is depleted. The display will shortly go blank and the camera will stop working. Replace or recharge the battery. (Blinking red)

! CAUTION

- Due to the nature of the battery, the battery level indicator (☐, ☐, or ☐) may appear early when the camera is used in cold locations. Try warming the battery in your pocket or a similar location before use.
- Battery with no remaining charge (☐ blinking red) may cause camera faults. Always load a fully charged battery.
- Depending on the camera mode, the transition from ☐ to ☐ may occur more quickly.

Loading the xD-Picture Card

Although you can store pictures in the camera's internal memory, you can store many more images on the **xD-Picture Card** (sold separately). There is a slot for the **xD-Picture Card** inside the battery compartment.

1 Open the battery cover.

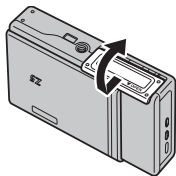

2 Insert an xD-Picture Card.

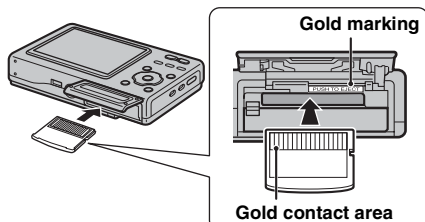

Align the gold marking with the gold contact area, and insert the card firmly into place.

3 Close the battery cover.

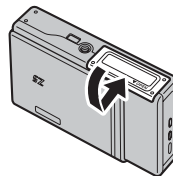

How to replace the xD-Picture Card

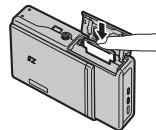

Push the **xD-Picture Card** into the slot and then slowly remove your finger. The lock is released and the **xD-Picture Card** is pushed out.

! CAUTION

- When storing **xD-Picture Cards**, make sure that they are kept out of the reach of children. An **xD-Picture Card** could be swallowed and cause suffocation. If a child swallows an **xD-Picture Card**, seek medical attention or call emergency number right away.
- If the **xD-Picture Card** is oriented incorrectly, it will not go all the way into the slot. Do not apply force when inserting an **xD-Picture Card**.
- Note that the **xD-Picture Card** may spring out if you release your finger quickly from the card immediately after the lock is released.
- Operation of this camera is only guaranteed when it is used with FUJIFILM **xD-Picture Card**.
- See p.129 for information on the **xD-Picture Card** and the internal memory.

📄 MEMO

- The size of an image file varies depending on the subject. For this reason, the number recorded may not represent the actual number of frames.
- See p.147 for information on the standard number of available frames.

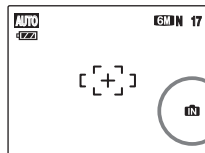
■ About internal memory

FinePix Z5fd has internal memory that can store images without **xD-Picture Card**. **IN** appears on the LCD monitor when internal memory is active.

When an xD-Picture Card (sold separately) is inserted

[Record images]: Record images to an **xD-Picture Card**.

[Playback images]: Playback images in an **xD-Picture Card**.

When an xD-Picture Card (sold separately) is not inserted

[Record images]: Record images to internal memory.

[Playback images]: Playback images in internal memory.

■ About images in the internal memory

Images held in the camera's internal memory may be corrupted or erased due to problems such as camera faults. Save your important data to another media (i.e., CD-R, CD-RW, DVD-R, hard disk, etc.).

It is possible to transfer saved images on the internal memory to an **xD-Picture Card** (→p.80).

Turning On and Off

Turning the camera on in Shooting mode

Open the lens cover completely to turn the camera on. Close the lens cover until it stops to turn the camera off.

• Power-ON

• Power-OFF

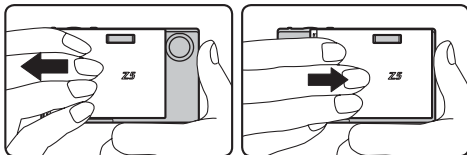

MEMO

Changes between Shooting mode and Playback mode

Press  during shooting to change to Playback mode. Press the shutter button down halfway to return to Shooting mode.

CAUTION

Take care not to get fingerprints on the camera lens as this will result in impaired image quality in your shots.

Turning the camera on in Playback mode

① Leave the lens cover closed.

• Close the lens cover

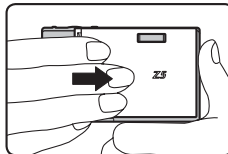

② Press  for about 1 second to turn the camera on in Playback mode.

Press  during playback to turn the camera off.

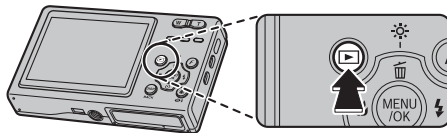

CAUTION

When the lens cover is open, even if you press , the power cannot be turned off. Follow the instructions on the LCD monitor.

MEMO

To change to Shooting mode, open the lens cover completely so that it will not move further.

Setting the language, date, and time

When using the camera for the first time after purchasing, the language, date, and time are cleared. Set the language, date, and time.

1 言語/LANG. screen appears when turning the camera on.



① Press ▲, ▼, ◀, or ▶ to select the language.



② Press MENU/OK to confirm the setting.

2 Set the date and time.

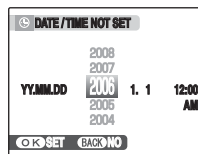

① Press ◀ or ▶ to select Year, Month, Day, Hour, or Minute.



② Press ▲ or ▼ to correct the setting.



MEMO

- Holding down ▲ or ▼ changes the numbers continuously.
- When the time displayed passes “12”, the AM/PM setting changes.

Continued ➔

3 Change the date format.



① Press ◀ or ▶ to select the date format.



② Press ▲ or ▼ to set the format.



③ Always press MENU/OK after the settings are completed.

Date format

ex. November 24, 2006
 YY.MM.DD: 2006.11.24
 MM/DD/YY: 11/24/2006
 DD.MM.YY: 24.11.2006

MEMO

START MENU screen also appears when the battery has been removed and the camera has been left for a long period. Once the AC power adapter has been connected or the battery has been installed for 2 hours or more, the camera settings will be retained for roughly 6 hours even if both sources of power are removed.

Auto power off function

When the Auto power off function is active, if the camera is left unused for 2 or 5 minutes, this function turns the camera off (→p.102). To restore power to the camera to take pictures, briefly close the lens cover completely and then reopen it. To play back images, hold down  for about 1 second.

Correcting the Date and Time

1 Open the SET-UP menu.

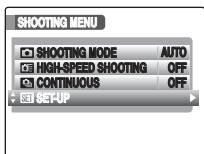

① Press MENU/OK to open the menu.



② Press ▲ or ▼ to select **SET** SET-UP.



③ Press ►.

2 Display the DATE/TIME screen.

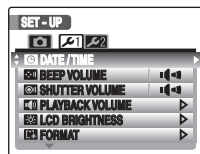

① Press ◀ or ▶ to select **1**.



② Press ▼ to move to menu item.



③ Press ▲ or ▼ to select **DATE/TIME**.



④ Press ►.
See “2 Set the date and time.” (→p.21).

Selecting the Language

1 Open the SET-UP menu.

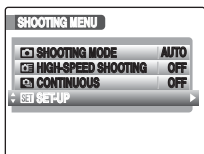

① Press MENU/OK to open the menu.



② Press ▲ or ▼ to select **SET** SET-UP.



③ Press ►.

2 Display the 言語/LANG. screen.

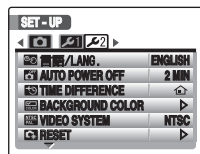

① Press ◀ or ▶ to select 2.



② Press ▼ to move to menu item.



③ Press ▲ or ▼ to select 言語/LANG..



④ Press ►.

See "1 言語/LANG. screen appears when turning the camera on." (→p.21).

Taking Pictures (AUTO Mode)

This section describes the basic operations.

1 Turn the camera on.

- 1 Open the lens cover completely so that it will not move further.

- Power-ON

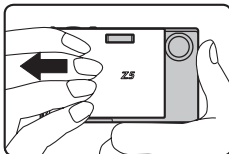

- 2 Set the Mode switch to .

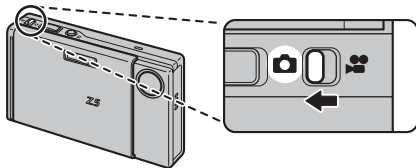

Holding the camera correctly



Brace your elbows against your sides and hold the camera with both hands.

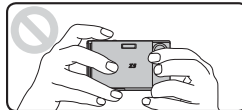

Do not cover the lens or flash with your fingers.

! CAUTION

- Moving the camera while shooting gives a blurred picture (camera shake). Hold the camera steadily with both hands.
- If the lens or flash is obscured by your fingers or the strap, subjects may be out of focus or the brightness (exposure) of your shot may be incorrect.
- Check that the lens is clean. If it is dirty (getting fingerprints on the lens etc.), clean the lens as informed on p.125.

Continued ➔

2 Check the composition on the LCD monitor. To adjust zoom scale using the Zoom button:

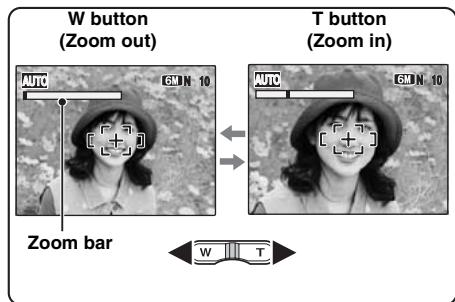

- **Focal range**
Approx. 60 cm (2.0 ft.) to infinity
- **Optical zoom focal length (35 mm camera equivalent)**
Approx. 36 mm to 108 mm
(**3x**): Approx. 38 mm to 114 mm)
- **Max. zoom scale**
3x

MEMO

- Select Macro mode to take close-up shots (→p.48).
- Use digital zoom when you want to shoot the subject closer (→p.99).

3 Focus on the main subject in the AF frame and press the shutter button down halfway.

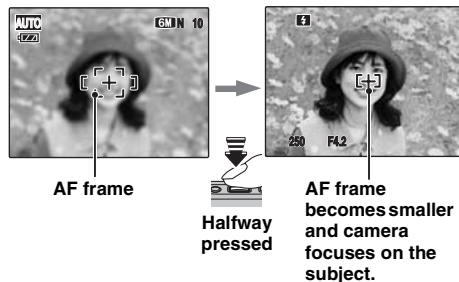

CHECK

- **Focus on the subject**
Double beep is heard
Indicator lamp lit green
- **Not focus on the subject**
No sound
!AF indicated
Indicator lamp blinking green

MEMO

The shutter button has a halfway point at which focus and exposure are automatically optimized before taking the picture by pressing fully down.

CAUTION

When the shutter button is pressed halfway, the movement of the lens will emit a sound.

4 Press the shutter button fully.

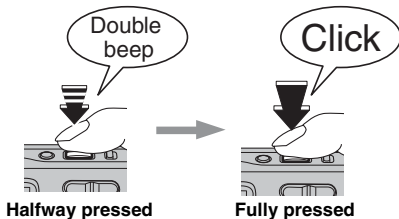

Halfway pressed

Fully pressed

! CAUTION

When taking a picture using the flash, the image may disappear and go dark briefly due to flash charging. The indicator lamp blinks orange during charging.

MEMO

- When the subject is not in the AF frame, use AF/AE lock to take the picture (→p.30).
- When pressing the shutter button down fully in one motion, the camera takes the picture without the AF frame changing.
- When a picture is taken, the illumination lamp on the front of the camera lights to indicate that shooting is complete.

Flash



When pressing the shutter button down halfway, **F** appears on the LCD monitor before the flash fires.

Change the flash mode when you want to take pictures without flash. See p.49 for information on flash.

! CAUTION

- The image shown on the LCD monitor before the picture is taken may differ in brightness, color, etc. from the image actually recorded. Play back the recorded image to check it (→p.33).
- When selecting a slow shutter speed that will cause camera shake, **!** appears on the LCD monitor. Use flash or a tripod.
- See p.131-134 for information on Warning displays. See "Troubleshooting" (→p.135-142) for more information.

Continued ➡

Indicator lamp display

The indicator lamp lights or blinks when pressing the shutter button, etc. The indicator lamp shows the camera status.

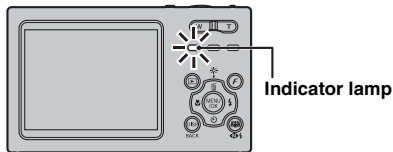

MEMO

Only the slip stopper on the left side lights as the indicator lamp. The other two slip stoppers are for holding the camera only and do not light.

Display	Status
Lit green	Locking the focus
Blinking green	Camera shake warning, AF warning, or AE warning (ready to shoot)
Blinking green and orange alternately	Recording to xD-Picture Card or internal memory (ready to shoot)
Lit orange	Recording to xD-Picture Card or internal memory (not ready)
Blinking orange	Charging flash (flash will not fire)
Lit red	Charging battery
Blinking red	<ul style="list-style-type: none"> Warnings for xD-Picture Card and internal memory Card not formatted, incorrect format, memory full, xD-Picture Card or internal memory error Lens operation error

MEMO

Detailed warning messages appear on the LCD monitor (→p.131-134).

Using Intelligent Face Detection when taking pictures

Intelligent Face Detection allows you to focus on and adjust the brightness of people's faces. Intelligent Face Detection is effective with the camera held horizontally or vertically.

Available Shooting modes: AUTO, OFF,

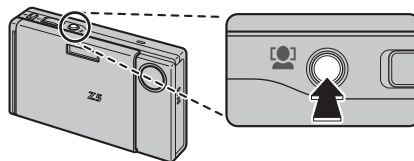

- To activate Intelligent Face Detection, press once. To turn Intelligent Face Detection off, press again.



Green frame

When there are multiple people in the frame, Intelligent Face Detection will set a green frame around the face nearest to the center of the picture. This face has focusing priority.

! CAUTION

- If the camera or subject moves as the picture is taken, the subject's face may move out of the Intelligent Face Detection frame.
- When the camera is detecting multiple faces, the green frame is set around the face near the center. If you want to focus on another subject, move the camera so that the new subject is in the center of the LCD monitor. If focus is still not achieved, press  (Intelligent Face Detection) to turn off the function, and take the picture using AF/AE lock (→p.30). Intelligent Face Detection can focus on a face in a white frame providing the subjects in the green and white frame are of the same focal length.
- When the shutter button is pressed halfway with Intelligent Face Detection off, the focus will be on the center of the LCD monitor.
- When the shooting mode is set to  or , the image will be focused with respect to faces, but because the exposure will be controlled by the shooting mode, faces will not be adjusted for optimal exposure.

- ② Press the shutter button down fully to take pictures.

**Subjects not suitable for Intelligent Face Detection**

Intelligent Face Detection automatically focuses on a face(s) turned towards the camera. However, difficulties will occur with the Intelligent Face Detection mode in the following situations:

- The face is obscured by glasses, sunglasses, a hat, or hair.
- A person turned sideways, or who has their head tilted.
- The subject is too far away to recognize a face.

Intelligent Face Detection will not work in cases where the subject is standing on his/her head, is not a person (pet or other animal), or if the camera is not held correctly.

Continued ➔

Taking pictures with the focus and exposure locked

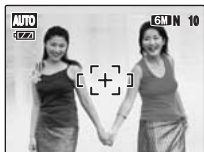

In the above composition, the subjects (two people in this case) are not in the AF frame. Pressing the shutter button halfway at this point will result in the subjects being out of focus.

AF/AE lock is useful:

Use AF/AE lock to guarantee best result when shooting a subject that is not suited to autofocusing (→p.31).

CAUTION

When shooting with the AF/AE lock function, turn off  Intelligent Face Detection.

Using AF/AE lock

1 Move the camera slightly so that one of the subjects is in the AF frame.

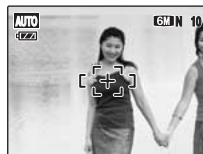

2 Press the shutter button down halfway to focus on the subject.

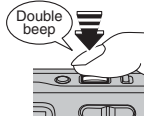

Halfway pressed



- 3** Continue to hold the shutter button down halfway. Move the camera back to the original image and press the shutter button fully.



 **MEMO**

- AF/AE lock can be applied repeatedly before the shutter is released.
- On FinePix Z5fd, pressing the shutter button down halfway locks the focus and exposure settings (AF and AE lock).

Subjects not suitable for autofocus

FinePix Z5fd uses a high-precision autofocus mechanism. However, it may have difficulty focusing on the following:



Very shiny subjects such as a mirror or car body

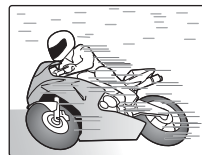

Fast moving subjects

- Subjects photographed through glass
- Subjects that do not reflect well, such as hair or fur
- Subjects with no substance, such as smoke or flames
- Dark subjects
- Subjects with little or no contrast between the subject and the background (such as subjects dressed in the same color as the background)
- Shots where another high-contrast object (not the subject) is close to the AF frame and is either closer or further away than your subject (such as a shot of someone against a background with strongly contrasting elements)

For such subjects use AF/AE lock (→p.30).

Adjusting the shot composition

Select the LCD monitor display.

Press DISP/BACK to change the LCD monitor display.

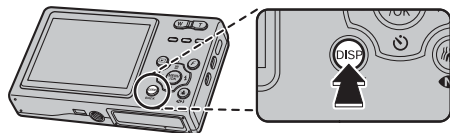

Text displayed

No text displayed



Framing guideline displayed

Best framing

Position the main subject at the intersection of two lines in this frame or align one of the horizontal lines with the horizon. Use this frame as a guide to the subject's size and the balance of the shot while composing a shot.



MEMO

Always use AF/AE lock when composing a shot. The image may be out of focus if AF/AE lock is not used.

Viewing the Images

Play back your images to check them. For important photographs, always take a test shot and view the image to make sure that the camera is working normally.

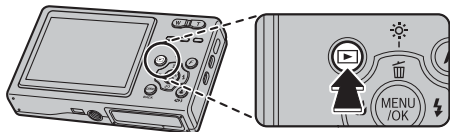

Setting the camera to Playback mode

Press  during shooting to change to Playback mode.



When the camera is off, press  for about 1 second to turn the camera on in Playback mode.

MEMO

- When pressing , the last image shot appears on the LCD monitor.
- When playing back images shot with a camera other than FinePix Z5fd, "  " (present icon) appears on the LCD monitor.

CAUTION Still images viewable on FinePix Z5fd

This camera will display still images recorded on FinePix Z5fd or still images (excluding some uncompressed images) recorded on any FUJIFILM digital camera that supports **xD-Picture Cards**. Clear playback or playback zooming may not be possible for still images shot on cameras other than FinePix Z5fd.

Select the LCD monitor display.

Press DISP/BACK during Playback mode to change the LCD monitor display.

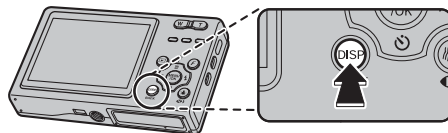

Text displayed



No text displayed



Sorting by date

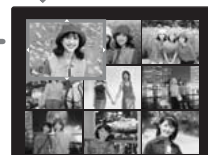

Multi-frame playback

Continued 

Single-frame playback





To select the required image:

Press ◀: last image

Press ▶: next image

Intelligent Face Detection

When playing back images taken with Intelligent Face Detection (→p.28) (IFD) appears on the LCD monitor, press  (Intelligent Face Detection). A frame appears around the faces that were detected by FinePix Z5fd. Press  (Intelligent Face Detection) to alternate the detected face. For images shot with a camera other than FinePix Z5fd, the frame does not appear.

Selecting images



To select images on the thumbnail lists screen, hold down ◀ or ▶ for 1 second during playback. When releasing ◀ or ▶, camera returns to single-frame playback.

Playback zoom

1 Zoom in / Zoom out.

To zoom in an image during single-frame playback:

W button (Zoom out)

T button (Zoom in)

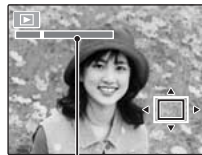

Zoom bar



Press W or T to zoom in or out on an image.

2 Display another part of the image.



Navigation screen
(Current displayed image)



Press ▲, ▼, ◀, or ▶ to display another part of the image.

Zoom scales

Quality mode	Max. zoom scale
6M (2848 × 2136 pixels)	Approx. 4.5x
3:2 (3024 × 2016 pixels)	Approx. 4.7x
3M (2048 × 1536 pixels)	Approx. 3.2x
2M (1600 × 1200 pixels)	Approx. 2.5x

MEMO

Pressing DISP/BACK cancels playback zoom.

Intelligent Face Detection

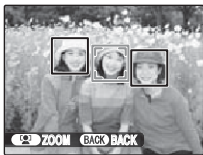

For images taken with Intelligent Face Detection (→p.28) (IFD appears on the LCD monitor), the displayed face switches each time you press IFD (Intelligent Face Detection). Press the **W** button (zoom out) or **T** button (zoom in) to display the selected face zoomed in or out. Press **▲**, **▼**, **◀** or **▶** to display another part of the image.

Multi-frame playback

Multi-frame playback screen (9 frames) appears on the LCD monitor. Select required frame from the 9 frames.

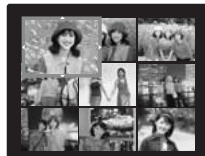

- Press **▲**, **▼**, **◀**, or **▶** to move the cursor (colored frame) to the selecting frame. Press **▲** or **▼** repeatedly to jump to the next page.



- Press MENU/OK to enlarge the image.

Continued ➔

Sorting by date

In sorting by date mode, you can view all images taken on the same day.



- ① Press ▲, ▼, ◀, or ▶ to move the cursor (colored frame) to the selecting frame.



- ② Press MENU/OK to enlarge the image.

Selecting the date



- ① Press ▲, ▼, ◀, or ▶ to move the cursor (colored frame) to ◀ on the upper left frame.



- ② Press ◀ to display the selecting date.



- ③ Press ▲ or ▼ to move the cursor (colored frame) to select the date.
Press ▲ or ▼ repeatedly to jump to the next page.



- ④ Press ▶.

Erasing the Images/Movies

Setting the camera to 
Playback mode (→p.33)

Use this mode to erase unnecessary images or movies to have ample free space on the xD-Picture Card or internal memory. Your camera calls images "frames".

Using the erase button (/▲)

Pressing  (▲) erases images easily.

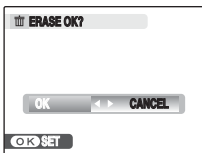

① Press ◀ or ▶ to select the erasing image.



② Press  (▲).



③ Press ◀ or ▶ to select OK.



④ Press MENU/OK to erase the displayed image.

Erasing from the PLAYBACK MENU

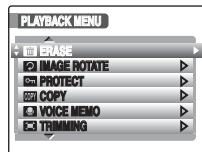

① Press MENU/OK to open the PLAYBACK MENU.



② Press ▲ or ▼ to select  ERASE.



③ Press ▶.

Continued ➔

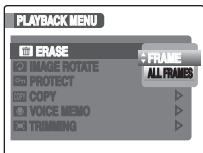

- ④ Press ▲ or ▼ to select FRAME or ALL FRAMES.



- ⑤ Press MENU/OK to confirm the setting.

Erasing one frame at a time (FRAME)

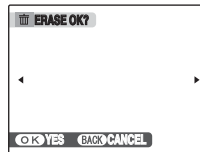

- ① Press ◀ or ▶ to select the erasing frame (file).



- ② Press MENU/OK to erase the currently displayed frame (file).



MEMO

To erase another frame (file), repeat above steps. When erasing frames (files) is completed, press DISP/BACK.



CAUTION

Pressing MENU/OK repeatedly erases consecutive frames (files). Take care not to erase a frame (file) by mistake.

Erasing all frames (ALL FRAMES)

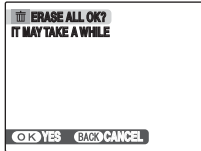

Press MENU/OK to erase all the frames (files).

MEMO

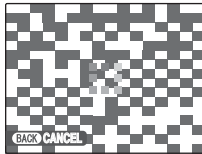

Press DISP/BACK to cancel erasing of all the frames (files). Some unprotected frames (files) will be left unerased.

MEMO

- When using an **xD-Picture Card**, the images in the **xD-Picture Card** are erased. When not using an **xD-Picture Card**, the images in the internal memory are erased.
- Protected frames (files) cannot be erased. Unprotect the frames (files) before erasing them (→p.79).
- If “DPOF SPECIFIED. ERASE OK?” or “DPOF SPECIFIED. ERASE ALL OK?” appears, press MENU/OK again to erase the frames (files).

CAUTION

Erased frames (files) cannot be recovered. Back up important frames (files) onto your PC or another media.

Using the Shooting Functions — Procedure of Setting

Specify the camera settings for taking pictures to get the best result. A general guide is given below.

1 Select the Shooting mode.

Set the Shooting mode from the menu.
The camera settings are tailored to the scene being shot.

	This mode provides detailed settings that are impossible to set in AUTO mode (→p.47).
AUTO	This is the easiest mode for taking pictures (→p.44).
	Select the best Shooting mode for the scene being shot (→p.44-47).
	Used for selecting a fast shutter speed that reduces camera shake and moving-subject blurring (→p.47).



2 Specify the photography settings.

Pressing buttons or selecting menu allows you to specify photography functions. You can obtain the best result for shooting.

■ Specifying functions using buttons

	Pressing this button allows you to focus on people's faces (→p.28).
	Used for close-up shots (→p.48).
	Used for shots in dark locations or for backlit subjects, etc. (→p.49).
	Used in situations such as group shots where the photographer is included in the shot (→p.51).
	Used for selecting a fast shutter speed that reduces camera shake and moving-subject blurring (→p.42).
	Used to shoot the same scene with and without flash (→p.42).

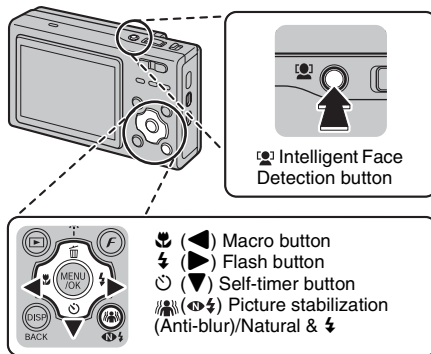

■ Specifying functions using *F*-MODE MENU (*F* button)

ISO	Use to specify required sensitivity setting (→p.57).
QUALITY	Use to specify required image size (→p.58).
FinePix COLOR	Use to specify required color tone (→p.59).

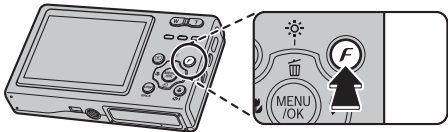

<i>F</i> MODE MENU	
ISO	AUTO
QUALITY	N
FinePix COLOR	STD

■ Specifying functions using SHOOTING MENU (MENU/OK button)

EXP. COMPENSATION	Use this setting to obtain the correct exposure (only (→p.60).
WHITE BALANCE	Use to adjust the color tone (only (→p.61).
HIGH-SPEED SHOOTING	Use to focus the shot quickly (→p.61).
CONTINUOUS	Use to take pictures continuously (→p.62).
AF MODE	Use to specify focusing mode (only (→p.64).

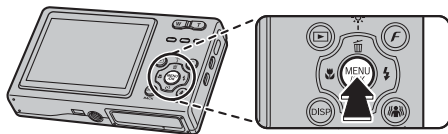





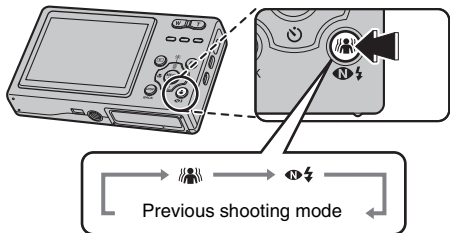

SHOOTING MENU	
SHOOTING MODE	
EXP. COMPENSATION	0
WHITE BALANCE	AUTO
HIGH-SPEED SHOOTING	OFF
CONTINUOUS	OFF
AF MODE	[B]

Setting the Shooting Mode





You can select the most suitable setting according to the subject by selecting one of the Shooting modes.





Setting Picture stabilization (Anti-blur) and Natural &



Press the " ()" button to set  Picture stabilization (Anti-blur) or  Natural & .

The setting switches with each press of the button.

You can select  Picture stabilization (Anti-blur) and  Natural &  from the  Shooting modes on the shooting menu (->p.43)

When  Picture stabilization (Anti-blur) or  Natural &  is selected on the shooting menu, pressing the " ()" button switches between these two modes.

Picture stabilization (Anti-blur)

This mode can reduce both camera blur and subject blur by increasing the shutter speed.

NATURAL &

This mode shoots 2 images continuously without flash and with flash. Shooting with flash allows you to take a picture of a main subject brightly. Shooting without flash produces beautiful images that retain the natural ambience. This mode is useful for shooting 2 different types of pictures at the same time.



When pressing the shutter button, first picture is taken without flash and next picture is taken with flash.

Always 2 pictures are taken per 1 shot.

Do not move the camera until the shooting ended.

MEMO

This mode helps to avoid failed shots that may occur when using other Shooting modes when taking a picture against the sun, etc.

CHECK

Flash fires automatically. Do not use this mode at situations where the flash cannot be used.

CAUTION







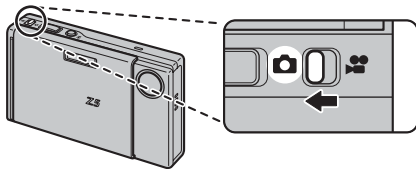

- When there is insufficient space on the **xD-Picture Card** or internal memory for 2 shots, this mode cannot be set.
- Continuous shooting is disabled when setting .

Setting a Shooting mode suited to the scene

- ① Set the Mode switch to .



MEMO

- See p.50 for information on the available flash modes.
- When anything other than AUTO, , , , and  in the  SHOOTING MODE is selected,  F-CHROME (→p.59) cannot be set.
- When anything other than  in the  SHOOTING MODE is selected, only AUTO can be selected for the ISO (sensitivity) setting.



- ② Press MENU/OK to open the menu.





- ③ Press  or  to select the  SHOOTING MODE.



- ④ Press .



- ⑤ Press  or  to select the setting.



- ⑥ Press MENU/OK to confirm the setting.

Continued ➔

AUTO

This is the easiest mode for providing crisp and clear shots.

Use this mode for ordinary photography.

Camera specifies all setting other than **F**-MODE (Quality and FinePix COLOR) automatically.

NATURAL LIGHT

This mode produces beautiful images that retain the natural ambience when shots are taken in low-light conditions.

This mode is also ideal for shooting indoor or situations where the flash cannot be used.

Camera sets the high-sensitivity setting when selecting the Natural light mode. This mode is effective for reducing camera shake and moving-subject blurring when taking pictures in low-light conditions.



CHECK

Flash cannot be used in the Natural light mode.

NATURAL &

Use this mode to shoot the same scene with and without flash.

- You can also select this mode by pressing the " (Natural & Flash) button.
- Natural & Flash (→p.42)

PORTRAIT

Use this mode for photography to get beautiful skin tones and soft overall tone.



LANDSCAPE

Use this mode for shooting scenery in daylight and provides crisp, clear shots of scenery such as buildings and mountains.



CHECK



Flash cannot be used in the Landscape mode.

SPORT

Use this mode to take pictures of a moving subject. It gives priority to faster shutter speeds.



CHECK

When setting  Sport mode, the camera sets to  High-speed shooting mode (→p.61) automatically.

NIGHT

Use this mode for shooting evening and night scenes.



A picture is taken with a slow shutter of up to 4 seconds.

CHECK

We recommend using a tripod to prevent camera shake. Because a picture is taken with a slow shutter.

FIREWORKS

Use this mode to shoot fireworks. It is effective for taking more vivid shots of fireworks with a slow shutter.



CHECK

- Flash cannot be used in the Fireworks mode.
- Shutter speed setting: 1/2 sec. to 4 sec.
- We recommend using a tripod to prevent camera shake in the Fireworks mode.

Selecting the exposure time setting

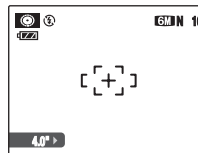

Press  or  to select the exposure time.

SUNSET

Use this mode to shoot sunset, making the colors more vivid.



SNOW

Use this mode to prevent darkening images and provide crisp, clear shots, when shooting at snowy scene where the whole screen appears white.



BEACH

Use this mode to prevent darkening images and provide crisp, clear shots, when shooting at beach under strong sunlight.



MUSEUM

Use this mode for taking pictures in places such as museum where the use of flash and making an operation sound and a shutter sound are restricted.

The flash mode is set to suppressed flash and the operation sound, shutter sound, and illumination lamp are disabled.



MEMO

Check whether photography is permitted before using this mode.

PARTY

Use this mode for shooting at indoor wedding and party.

This mode produces beautiful images that retain the natural ambience when shots are taken in low-light conditions.



* FLOWER

Use this mode to take clear close-up shots when zooming up a flower. It is effective for taking more vivid shots of flower petal.



✓ CHECK

- Flash cannot be used in the Flower mode.
- Focal range
Wide angle:
Approx. 8 cm to 2 m (3.1 in. to 6.6 ft.)
Telephoto:
Approx. 45 cm to 2 m (17.7 in. to 6.6 ft.)

TEXT

Use this mode to shoot documents and white board. It is effective for taking clearer shots of letters.



✓ CHECK

- Focal range
Wide angle:
Approx. 8 cm to 2 m (3.1 in. to 6.6 ft.)
Telephoto:
Approx. 45 cm to 2 m (17.7 in. to 6.6 ft.)

ANTI-BLUR (Picture stabilization)

Use this mode to select a fast shutter speed that reduces camera shake and moving-subject blurring. You can also select this mode by pressing the "⏏" (⏏) button (→p.42).

MANUAL





Set the Photography functions to manual to easily control yourself.

Photography functions:

- **EXP. COMPENSATION** (→p.60)
- **WB WHITE BALANCE** (→p.61)
- **AF MODE** (→p.64)

Macro (Close-up)

Use this mode to take close-up shots.

Available Shooting modes:  M, AUTO, ,  OFF, 
 (→p.44, 46, 47)

Press  (◀) to select Macro mode.

Press  (◀) again to cancel Macro mode.

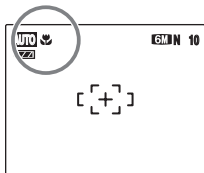
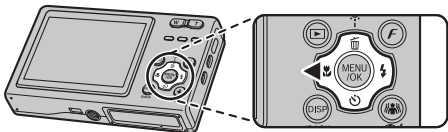



 appears on the LCD monitor indicating that you can take close-up shots.

CHECK

- Focal range
Wide angle:
Approx. 8 cm to 80 cm (3.1 in. to 2.6 ft.)
Telephoto:
Approx. 45 cm to 80 cm (1.5 ft. to 2.6 ft.)
- Effective flash range
Approx. 30 cm to 80 cm (1.0 ft. to 2.6 ft.)

MEMO

- We recommend using a tripod to prevent camera shake in Macro mode.
- Any of the following cancels Macro mode:
 - Changing the Shooting mode setting
 - Turning the camera off
- Even if the  AF MODE is set to  MULTI (→p.64), the camera focuses near the center of the LCD monitor.

⚡ Setting the Flash (Intelligent Flash)

Flash photography is useful for taking pictures at night or indoor dark locations. Choose from 6 flash modes according to the type of shot. See p.50 for information on the available Photography modes.

📄 MEMO What is Intelligent Flash?

The Intelligent Flash feature instantly determines the subject's position, distance from the camera, exposure, etc., and automatically adjusts the camera settings to the optimal flash volume and sensitivity for the scene. Even dimly lit indoor scenes can be shot beautifully, just as they appear, without subjects being washed out or losing background details.

The Intelligent Flash feature is always used when shooting with flash.

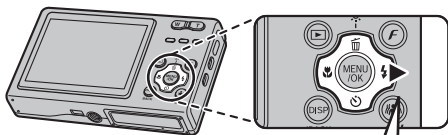

The flash setting changes each time you press ⚡ (▶).

📄 MEMO

When pressing the shutter button down halfway,  appears on the LCD monitor before the flash fires.

AUTO Auto flash (not displayed)

Use this mode for ordinary photography. The flash fires as required by the shooting conditions.

RED EYE REDUCTION

This mode is suitable for shooting portraits in low-light conditions.

Use this mode to minimize red-eye (eyes appear in red in the finished photo).



📄 MEMO Red-eye effect

When using the flash to take a picture of people in low-light conditions, their eyes sometimes appear red in the picture. This is caused by the light of the flash reflecting off the inside of the eye.

⚡ FORCED FLASH

Use this mode in backlit scenes, or to get the correct colors when taking a picture under bright lighting. In this mode, the flash fires in bright as well as dark conditions.



SUPPRESSED FLASH

This mode is suitable for situations where the flash cannot be used.

In dark conditions, we recommend using a tripod. Any time, flash does not fire.

Continued ➔

**⚡ SLOW SYNCHRO,
SLOW RED EYE & SLOW**

This mode allows you to take pictures of people at night that clearly show both your subjects and the night time backdrop. Always use a tripod in this mode. Using  synchronizes Red-eye reduction mode. Using  selects slow shutter speeds of up to 4 seconds.

! CAUTION

In bright scenes, overexposure may occur.

✓ CHECK

Effective flash range ( : AUTO)

Wide-angle:

Approx. 60 cm to 3.5 m (2.0 ft. to 11.5 ft.)

Telephoto:

Approx. 60 cm to 2.8 m (2.0 ft. to 9.2 ft.)

















If you take pictures outside of the effective flash range, the image may appear dark even if the flash is used.

! CAUTION Notes on using flash

- If pressing the shutter button while the flash is charging (indicator lamp blinking orange), the picture will be taken without the flash (when using AUTO and .
- The flash charging time may increase when the battery is low on charge.
- When taking a picture using the flash, the image may disappear and go dark briefly due to flash charging. The indicator lamp blinks orange during charging.
- The flash fires several times (pre-flashes and the main flash). Do not move the camera until the picture is taken.

✓ CHECK

List of available flash modes in each Photography mode

	AUTO		⚡		⚡	
	✓	✓	✓	✓	✓	✓
AUTO	✓	✓	✓	✓		
				✓		
		✓	✓			
	✓	✓	✓	✓	✓	✓
				✓		
	✓		✓	✓		
				✓	✓	✓
				✓		
	✓	✓	✓	✓		
	✓	✓	✓	✓		
				✓		
		✓				
				✓		
	✓	✓	✓	✓		

Self-Timer

The self-timer is used in situations where the photographer is included in the shot.

Available Shooting modes: All

Setting self-timer

The self-timer setting changes each time you press  (▼).

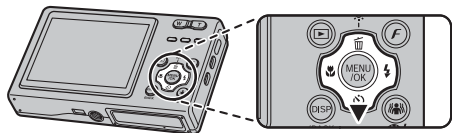

The last displayed setting is the selected mode.

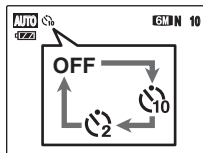

: The picture is taken after 10 seconds.

: The picture is taken after 2 seconds.

Intelligent Face Detection

Using Intelligent Face Detection with the self-timer allows the camera to detect the faces of subjects in the picture and automatically bring them into focus, without the need for manual focusing beforehand. This is convenient when taking a self portrait.

Taking pictures using self-timer

- 1 Press the shutter button down halfway to focus on the subject and press the shutter button fully.

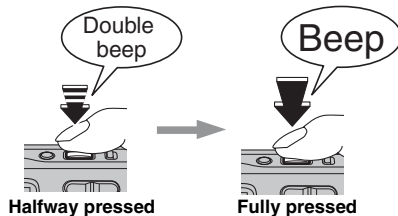

Pressing the shutter button down halfway that focuses on the subject. Without releasing the shutter button, press the button all the way down (fully pressed) to start the self-timer.

Continued ➔

2 Take pictures in selected time.

A picture is taken after the self-timer lamp changes from lit to blinking (only blinks with the 2-second self-timer).

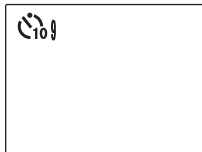
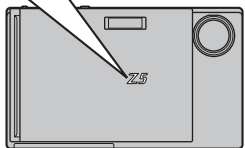
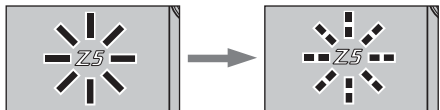

A countdown appears on the LCD monitor indicating the time remaining until the picture is taken.

Using the 2-second self-timer

This is useful when you worry about camera shake even if attaching the camera on a tripod.

MEMO

- To stop the self-timer, once it has started running, press DISP/BACK.
- Any of the following cancels the self-timer setting:
 - Completing the shooting
 - Changing the Photography mode setting
 - Setting the camera to Playback mode
 - Turning the camera off
- Take care not to stand in front of the lens when pressing the shutter button as this can prevent the correct focus or brightness (exposure) from being achieved.

☀ Increasing Monitor Brightness

This is useful when checking the shot composition for dimly lit scenes, or bright scenes such as outdoor shots.

☀ Increasing the LCD monitor brightness

Press ☀ (▲) to display the LCD monitor brightly.
Press ☀ (▲) again to return to normal LCD monitor brightness.

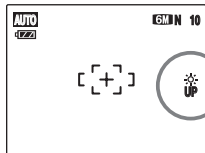
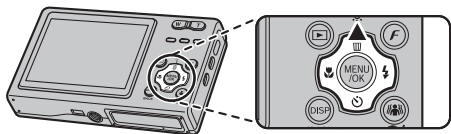

☀ lights up on the LCD monitor when the function is working.

MEMO

- This function is automatically canceled after each shot.
- When this function is active, it will increase the amount of speckling in images on the LCD monitor. This is normal and does not affect the photographed image.
- This function is purely for checking the composition of your shot. It does not increase the brightness of the image.
- Even if you increase the brightness in low-light conditions, you cannot check the subject.
- The color tones may vary depending on the subjects.

Using *F*-MODE MENU (Shooting)/SHOOTING MENU

Use the *F*-MODE MENU/SHOOTING MENU to adjust image quality or focus. You can take pictures in a wide range of conditions.

Setting the *F*-MODE MENU (Shooting)

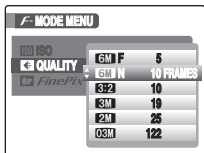

① Press *F* to open the *F*-MODE MENU.



② Press ▲ or ▼ to select the menu.



③ Press ►.



④ Press ▲ or ▼ to change the setting.



⑤ Press MENU/OK to confirm the setting.



Setting the SHOOTING MENU

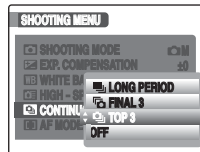

① Press MENU/OK to open the SHOOTING MENU.



② Press ▲ or ▼ to select the menu.



③ Press ►.



④ Press ▲ or ▼ to change the setting.



⑤ Press MENU/OK to confirm the setting.

List of F-MODE MENU options

Menu	Functions	Settings	Factory default
ISO (→p.57)	Specifies required sensitivity setting of the ambient light around the subject. The larger value of the sensitivity, the higher sensitivity is obtained. The higher sensitivity settings will allow you to take pictures in darker locations.	AUTO/1600/800/ 400/200/100	–
QUALITY (→p.58)	Specifies the image size. The larger image size, the better image quality is obtained. The smaller image size, the larger number of images are recorded.	6M F/ 6M N/ S:2 / SM / 2M / 4M	6M N
FinePix COLOR (→p.59)	Specifies required color tone. This mode is effective for taking more vivid shots or black and white shots.	STD//	STD

List of SHOOTING MENU options

Menu	Functions	Settings	Factory default
SHOOTING MODE (→p.42)	Use this setting to provide the best photography menu setting for the scene being shot.	/AUTO//// ///// /	AUTO
EXP. COMPENSATION (→p.60)	This setting can be used when the SHOOTING MODE is set to . Use this setting to obtain the correct exposure.	–2 EV to +2 EV (1/3 EV increments)	±0
WHITE BALANCE (→p.61)	This setting can be used when the SHOOTING MODE is set to . Use this setting to adjust the color balance to suit the color of the ambient light around the subject.	AUTO / / / / / /	AUTO
HIGH-SPEED SHOOTING (→p.61)	This setting can be used with any of the modes. This setting is always set to ON when the SHOOTING MODE is set to . Use this setting to reduce the time required for focusing.	ON/OFF	OFF
CONTINUOUS (→p.62)	This setting can be used when the SHOOTING MODE is set to anything other than . Use this setting to select the required continuous shooting mode.	/ / OFF	OFF
AF MODE (→p.64)	This setting can be used when the SHOOTING MODE is set to and Intelligent Face Detection is set to OFF. Use this setting to specify the focusing mode.	/	

Continued →

 **MEMO**

The options available in the SHOOTING MENU vary depending on whether the mode is selected.

- AUTO, , , , , , , , , , OFF, , , , 

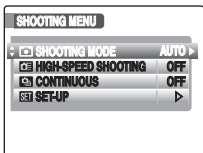

- 

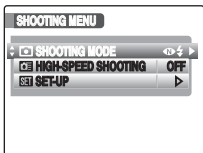

- 

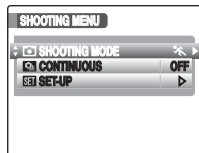

- 

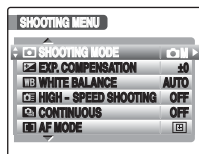

Changing the sensitivity setting (ISO ISO)

Use this menu to specify required sensitivity setting of the ambient light around the subject.
The larger value of the sensitivity, the higher sensitivity is obtained. The higher sensitivity settings will allow you to take pictures in darker locations.

CHECK

Settings

AUTO/1600/800/400/200/100

Selecting AUTO as the sensitivity setting, the camera selects the best sensitivity setting for the subject's brightness.

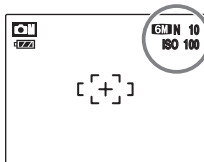

The selected sensitivity setting appears on the LCD monitor when the sensitivity setting is set to another setting excluding AUTO.

MEMO

When anything other than **M** MANUAL in the Photography mode is selected, only AUTO can be selected for the ISO (sensitivity) setting.

CAUTION

- Although higher sensitivity settings will allow you to take pictures in darker locations, they will also increase the amount of speckling in your images. Choose the sensitivity setting that best suits the conditions.
- Only if the sensitivity setting is set to "1600" and the camera is turned off, the setting is not retained. When turning the camera on again, the setting has been set to AUTO. Select "1600" before taking pictures with "1600" sensitivity setting.

Continued →

Changing the quality setting (QUALITY)

Use this menu to specify the image size (number of recorded pixels).

Select the quality setting for the scene being shot.

Quality settings in Photography mode

Quality mode	Sample uses
6M F (2848 × 2136)	Printing at up to 10R (25.4 × 30.5 cm/ 10 × 12 in.) / A4 size For better quality, select 6M F
6M N (2848 × 2136)	
3:2 (3024 × 2016)	
6M (2048 × 1536)	Printing at up to 6R (15.2 × 20.3 cm/ 6 × 8 in.) / A5 size
2M (1600 × 1200)	Printing at up to 4R (10.2 × 15.2 cm/ 4 × 6 in.) / A6 size
6M (640 × 480)	To use for e-mail or web site

Area shot and quality setting

Area shot excluding **3:2**



Area shot with **3:2**



Normal shooting provides an aspect ratio of 4:3 and **3:2** shooting provides an aspect ratio of 3:2 (same aspect ratio as 35 mm film and post card).

MEMO



- The bigger the number of recorded pixels, the better the image quality becomes. As the number of recorded pixels becomes smaller, you will be able to record more frames to an **xD-Picture Card**.
- The quality setting is retained even when the camera is turned off or the mode setting is changed.
- When changing the quality setting, the number of available frames also changes (→p.147). The numbers to the right of setting show the number of available frames.



Changing the FinePix COLOR setting (FinePix COLOR)

Use this menu to specify required color tone.
It is effective for taking vivid shots or black and white shots.







CHECK

FinePix COLOR settings

 F-STANDARD	The contrast and color saturation are set to standard. Use this mode for normal photography.
 F-CHROME	The contrast and color saturation are set to high. This mode is effective for taking more vivid shots of subjects such as scenery (blue sky and greenery) and flowers.
 F-B&W	This mode converts the colors in the photographed image to black and white.

When setting  **F-CHROME** or  **F-B&W**, the icon appears on the LCD monitor.

CAUTION

When anything other than AUTO,  **MANUAL**,  **NATURAL LIGHT**,  **NATURAL & S**, and  Picture stabilization (Anti-blur) in the  **SHOOTING MODE** is selected,  does not appear on the LCD monitor.

MEMO

- The FinePix COLOR setting is retained even when the camera is off or the mode setting is changed.
- **F-CHROME** may have little visible effect with some subjects or the scene being shot. You may not be able to see any difference on the LCD monitor.

Adjusting exposure compensation (EXP. COMPENSATION)

Available Shooting mode:  (→p.47)

Use this menu for shots to get the correct brightness (exposure), such as shots with extremely high contrast between the subject and the background.

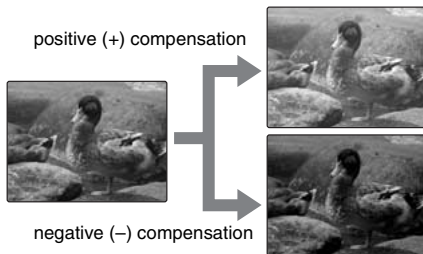
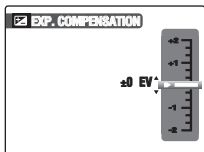

CHECK

- Compensation range: -2 EV to +2 EV (13 steps in 1/3 EV increments)
- Explanation of Terms "EV" (→p.149)

Guide to compensation

- Backlit portraits: +2/3 EV to +1 2/3 EV





- Very bright scenes (such as snowfields) and highly reflective subjects: +1 EV



- Shots made up predominantly of sky: +1 EV
- Spotlit subjects, particularly against dark backgrounds: -2/3 EV
- Scenes with low reflectivity, such as shots of pine trees or dark foliage: -2/3 EV

MEMO

- The exposure compensation setting is retained when the camera is turned off ( icon appears). Set the exposure value to "±0 EV" unless compensation is required.
- Any of the following disables exposure compensation:
 - Using the flash in AUTO or  mode
 - Shooting dark scenes in  mode

Adjusting color balance (WB WHITE BALANCE)

Available Shooting mode: (→p.47)

Adjust the color balance based on white to suit the color of the ambient light around the subject.

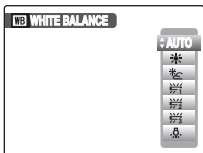

AUTO: Automatic adjustment

☀️: Shooting outdoors in good weather

☁️: Shooting in shade

☀️: Shooting under Daylight fluorescent lamps

☀️: Shooting under Warm White fluorescent lamps

☀️: Shooting under Cool White fluorescent lamps

💡: Shooting in incandescent light

MEMO

- In AUTO mode, the correct white balance may not be achieved for subjects such as close-ups of people's faces and pictures taken under a special light source. Select the correct white balance for the light source.
- When the flash fires, the white balance setting for the flash is used. Consequently, to achieve a particular effect, the flash mode should be set to Suppressed flash (→p.49).
- The color tones may vary depending on the shooting conditions (light source, etc.).
- We recommend playing back images after shooting to check the color tones (white balance).
- Explanation of Terms "White Balance" (→p.149)

⚙️ Focusing the shot quickly (HIGH-SPEED SHOOTING)

Available Shooting modes:

All (except for) (→p.44 – 47)

Use this mode to reduce the time required for focusing when pressing the shutter button down halfway. It is useful to avoid missing snapshot opportunities.

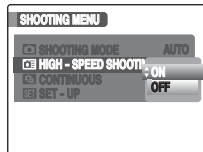

CAUTION

The LCD MODE function on the SET-UP menu cannot be set in this mode (→p.100).

MEMO

- The available shooting distance is from about 1 m (3.3 ft.) to infinity.
- When taking pictures while the High-speed shooting mode is set to ON, the battery will run down more quickly.

CHECK



When setting Sport mode, the camera sets to High-speed shooting mode automatically.

Continued →

Taking pictures continuously CONTINUOUS

Use this mode to take pictures of a moving subject.





- : LONG PERIOD continuous shooting
- : FINAL 3 continuous shooting
- : TOP 3 continuous shooting

CAUTION

- As long as the shutter button is held down, the camera will continue to take pictures.
- Number of available frames is limited depending on the available space on the **xD-Picture Card** or internal memory.
- In TOP 3 and FINAL 3 continuous shooting mode, the focus is determined in the first frame and cannot be changed in mid-sequence.
- The exposure is determined in the first frame, but in LONG PERIOD continuous shooting the exposure is adjusted for the scene being shot.
- The speed of continuous shooting varies depending on the shutter speed.
- The flash cannot be used as the flash mode is set to  Suppressed flash (→p.49). However, if you switch back to the normal shooting setting, the flash mode resets to what it was before you selected continuous shooting.
- For TOP 3 and FINAL 3 continuous shooting, the results are always displayed after you shoot. Note that

pictures taken using LONG PERIOD continuous shooting are recorded without displaying the results.

- Only 1 frame can be shot when using the FINAL 3 or LONG PERIOD continuous shooting mode and Self-timer mode together.
- Continuous shooting cannot be selected in  NATURAL &  setting.
- Recording times may be longer for files shot with TOP 3 continuous shooting or FINAL 3 continuous shooting.

TOP 3 continuous shooting

Available Shooting modes:

All (except for ) (→p.44 – 47)



Shooting continues as long as holding the shutter button down. This mode shoots up to 3 frames (max. 2.2 frames/sec.).

FINAL 3 continuous shooting

Available Shooting modes:

All (except for ) (→p.44 – 47)

Shooting continues as long as holding the shutter button down.

This mode shoots up to 40 times (max. 2.2 frames/sec.). The camera records the final 3 frames shot when you release the shutter button.

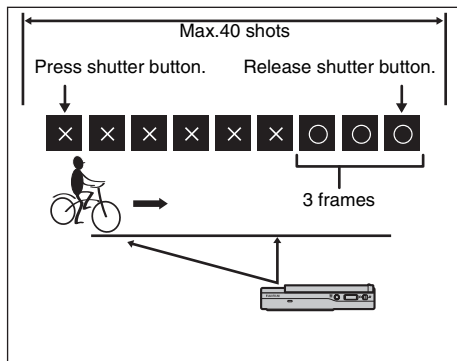

LONG PERIOD continuous shooting

Available Shooting modes:

All (except for ) (→p.44 – 47)

Shooting continues as long as holding the shutter button down. This mode shoots up to **xD-Picture Card** or internal memory end.

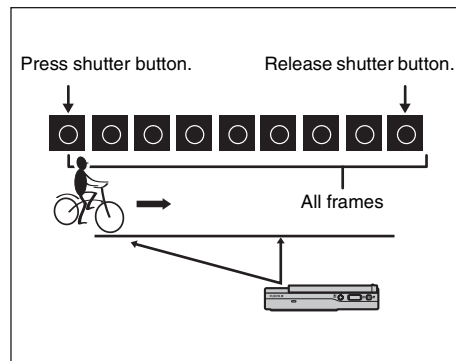

Continued ➔

Specifying focusing mode (**AF MODE**)

Available Shooting mode: (→p.47)
(When Intelligent Face Detection is turned OFF)

Use this mode to specify focusing mode that best suits the subject.

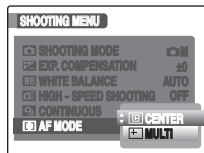

: CENTER
: MULTI

CENTER

The camera focuses on the center of the LCD monitor.
Use this setting when taking pictures with AF/AE lock
(→p.30).

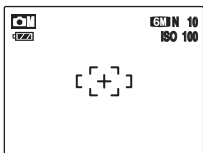

MULTI

When pressing the shutter button down halfway, the camera recognizes any strongly contrasting subject near the center of the LCD monitor and displays the AF frame over subject in focus.

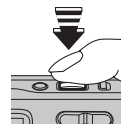

Halfway pressed



AF frame

CAUTION

When taking pictures in Macro mode, the camera focuses on the center of the LCD monitor.

MEMO

When the AF frame does not appear in the focusing position, select CENTER in the AF mode and use AF/AE lock (→p.30).

F-MODE MENU (Playback)

Sending and receiving images IR COMMUNICATION

You can send photographed images to a FUJIFILM digital camera, other devices with high-speed infrared transmission capability, or any other mobile device with the IrSimple function. You can also receive photographed images from a FUJIFILM digital camera, another device with high-speed infrared transmission capability, or another mobile device with the IrSimpleShot™ (IrSS™) function.

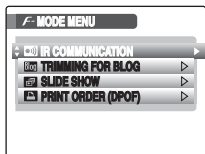

① Press  to set the camera to Playback mode (→p.33).



② Press **F** to open the **F-MODE MENU**.



③ Press  or  to select  IR COMMUNICATION.



④ Press **F**.

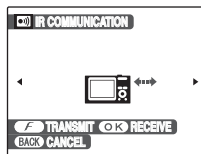

Sending image data

Sending image data to a FUJIFILM digital camera is shown as an example here. You can send the data to another device in the same way.



① Turn the camera on.



② Press  or  to select the sending frame (file).

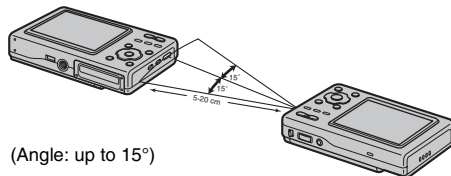

(Angle: up to 15°)

③ Point the infrared port on the transmitting camera directly at the infrared port on the receiving camera (→p.12). Transmission distance is about 5 to 20 cm (2 to 7.9 in.) within approx. 15°.

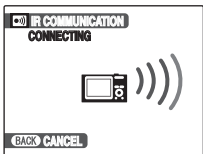

- ④ Press **F** to begin transmission.
When transmission is completed,
"TRANSMISSION COMPLETED" will appear
on the LCD monitor.



CAUTION

- Make sure the receiving camera is turned on when transmitting image data.
- Movie images cannot be transmitted.

CHECK

You can send the image data by simply pressing **F** three times.

Receiving the image data

Receiving the image data from a FUJIFILM digital camera is shown as an example here. You can receive data from another device in the same way.

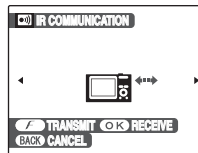

- ① Turn the camera on.
② Press **◀** or **▶** to select the sending frame (file).

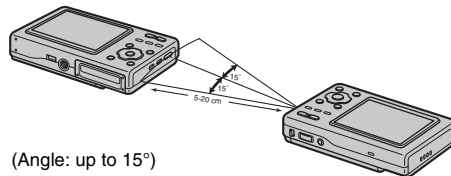

(Angle: up to 15°)

- ③ Point the camera's infrared port towards the front of the camera's infrared port (→p.12). Transmission distance is about 5 to 20 cm (2 to 7.9 in.) within approx. 15°.

Continued ➔

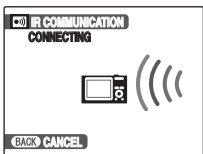

- ④ Press MENU/OK to begin transmission.
When transmission is completed, "DATA RECEIVED" will appear on the LCD monitor.

✓ CHECK

You can receive image data by simply pressing buttons as the order below.

F → **F** → MENU/OK

! CAUTION

- Movie images cannot be transmitted.
- Image data may be compressed when transmitted.
- If "COMMUNICATION ERROR", "CANNOT BE TRANSMITTED", or "CANNOT BE RECEIVED" appears, press **F** or MENU/OK to retransmit the image data, or press DISP/BACK to cancel transmitting.
- Do not place anything between the transmitting and receiving device.
- Leaving the camera in direct sunlight or directly under fluorescent lighting may prevent successful data transfer.
- Successful transfer may not be possible when transmitting near infrared transmission devices (such as the remote controller of TV or VCR) or devices that generate electrical noise.
- Correctly aim the infrared port towards the front of the device or camera's infrared port during image data transmission.



MEMO

When playing back an image received from another camera,  (present icon) will appear in the LCD monitor.

Transmitting and saving blog images

(Blog) TRIMMING FOR BLOG

You can change the pictures you take to a smaller size and then transmit or save them. This function is perfect when you want to post your pictures on a blog or other online forum. It is also possible to trim images before transmitting or saving them.

MEMO

The sizes available for blog images are "640 × 480" or "720 × 480" (when shot at 3:2).

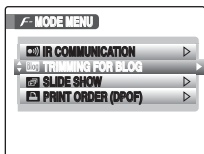

① Press  to set the camera to Playback mode (→p.33).



② Press **F** to open the **F**-MODE MENU.



③ Select  TRIMMING FOR BLOG.



④ The Transmit/Save screen appears.

MEMO Trimming Images

You can trim out the desired area of an image before transmitting or saving it.

- ① Zoom the image in or out with the **W** button (zoom out) or **T** button (zoom in).
- ② Press **▲▼◀▶** to move the screen to the area you want to trim out.
- ③ Press MENU/OK to confirm the setting and return to the Transmit/Save screen.

Transmitting blog images

You can resize images to VGA and then transmit them to a device that supports the IrSimple function.

Continued ➔

Saving blog images



① Select the frame (file) to save.



② Press MENU/OK to save the image.

✓ CHECK

- Saved blog images have filenames that start with “BLOG” when they are imported to a PC or similar device.
- When saved blog images are played back, appears on the screen and the images are surrounded by a black frame.

! CAUTION

Saved blog images cannot be rotated or trimmed.

📄 MEMO

Images rotated with IMAGE ROTATE are transmitted or saved in their rotated state.



Setting automatic playback SLIDE SHOW

Use this mode to play back photographed images continuously. You can select playback interval and type of image transition.

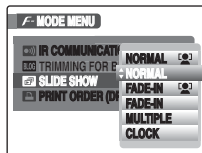

① Press to set the camera to Playback mode (→p.33).



② Press **F** to open the **F**-MODE MENU.



③ Press or to select SLIDE SHOW.



④ Press .



- ⑤ Press ▲ or ▼ to select the type of image transition.





- ⑥ Press MENU/OK. The image frames are played back automatically.

MEMO

- To interrupt  SLIDE SHOW, press MENU/OK.
- Press ◀ or ▶ to advance or go back through the images when selecting NORMAL or FADE-IN.
- The Auto power off function (→p.102) does not operate during a slide show.
- Movie starts automatically. When the movie ends, the playback function moves it on.
- Press DISP/BACK once during playback to display on-screen help.

Intelligent Face Detection

The camera plays back the image taken with Intelligent Face Detection (→p.28) zoomed in on the detected face when NORMAL  or FADE-IN  is selected.



DPOF set frame (PRINT ORDER (DPOF))

You can specify the image, number of prints, with or without date of printing with a DPOF-compatible printer.

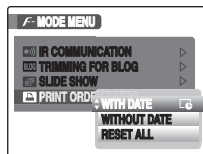

- ① Press  to set the camera to Playback mode (→p.33).



- ② Press **F** to open the **F**-MODE MENU.



- ③ Press ▲ or ▼ to select  PRINT ORDER (DPOF).



- ④ Press ▶.



- ⑤ Press ▲ or ▼ to select WITH DATE , WITHOUT DATE, or RESET ALL.

Continued 



⑥ Press MENU/OK.

WITH DATE : The date will be imprinted on your prints.

WITHOUT DATE: The date will not be imprinted on your prints.

RESET ALL : All DPOF settings will be canceled.

WITH DATE / WITHOUT DATE

Selecting WITH DATE , appears on the LCD monitor and the date will be imprinted on your prints.

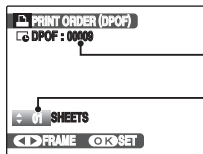

Total number of prints

Setting for that frame



① Press ◀ or ▶ to display the frame (file) for specifying DPOF setting.



② Press ▲ or ▼ to set a value.
Up to 99 sheets are printed.
For frames (files) that you do not want printed, set the number of prints to 0 (zero).

To specify more DPOF settings, repeat steps ① and ②.



③ Always press MENU/OK after the settings are completed.
Pressing DISP/BACK cancels those settings.



④ Press MENU/OK again.
The total number of prints appears on the LCD monitor.



MEMO Canceling DPOF setting

- ① Press **F** to open the **F**-MODE MENU and press ▲ or ▼ to select PRINT ORDER (DPOF).
- ② Press ▶.
- ③ Press ▲ or ▼ to select WITH DATE or WITHOUT DATE and press MENU/OK.
- ④ Press ◀ or ▶ to select the frame (file) with the DPOF setting you want to cancel.
- ⑤ Press ▼ to set the number of prints to 0 (zero).

To cancel the DPOF setting for another frame (file), repeat steps ④ and ⑤.

Always press MENU/OK to complete the settings.

- RESET ALL (→p.74)

MEMO

- When DPOF settings were specified on another camera.

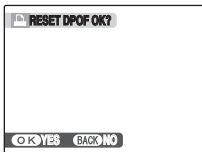

When the data includes a frame (file) with DPOF settings that were specified on another camera, "RESET DPOF OK?" appears.

Pressing MENU/OK erases all of the DPOF settings already specified for each frame (file). Specify the DPOF setting for each frame (file) again.

- Prints of up to 999 frames (files) can be ordered on the same **xD-Picture Card**.
- DPOF settings cannot be specified for movies.

CAUTION

- Pressing DISP/BACK while choosing settings will cancel all current settings. If there were previous DPOF settings, only the modifications are canceled.
- When selecting the WITH DATE setting, the date is imprinted on your shots using the Print Service or a DPOF-compatible printer (depending on the printer specifications, the date may not be printed in some cases).
- Images photographed with a camera other than FinePix Z5fd may not be specified DPOF settings.

Intelligent Face Detection

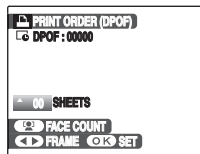

When setting images taken with Intelligent Face Detection (→p.28) (IFD) appears on the LCD monitor), if you press IFD (Intelligent Face Detection), frames appear around the faces detected by the camera, and the number of frames is set as the number of prints. This allows you to easily prepare the same number of prints as the number of people detected by the camera. In addition, you can adjust the number of prints by pressing ▲ or ▼. To reset the number of prints to the number of detected faces, press IFD (Intelligent Face Detection) again.

Make sure to press MENU/OK when your settings are complete.

Continued ➔

RESET ALL

To cancel all DPOF settings:

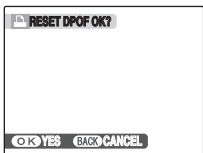



Select RESET ALL in the F-MODE MENU (→p.71).

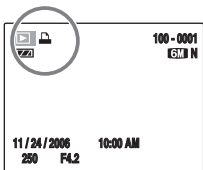

Press MENU/OK.

 MEMO



 appears on the LCD monitor during playback when the image has specified DPOF settings.

PRINT ORDER (DPOF)



DPOF stands for Digital Print Order Format and refers to a format that is used for recording printing specifications for images shot using a digital camera on media such as an **xD-Picture Card**. The recorded specifications include information on which frames are to be printed.

This section gives a detailed description of how to order your prints with FinePix Z5fd.

*Some printers do not support date and time imprinting or specification of the number of prints.

*The warnings shown below may appear while specifying the prints.

“DPOF SPECIFIED. ERASE OK ?”

“DPOF SPECIFIED. ERASE ALL OK ?” (→p.39)

When erasing the image, the DPOF setting for that image is deleted at the same time.

 RESET DPOF OK ?” (→p.73)

When inserting an **xD-Picture Card** that contains images specified for printing by another camera, those print specifications are all reset and replaced by the new print specifications.

[DPOF FILE ERROR] (→p.133)

Up to 999 images can be specified on the same **xD-Picture Card**.

Using PLAYBACK MENU

Use this menu to play back photographed images.

Setting the PLAYBACK MENU



- 1 Press to set the camera to Playback mode (→p.33).

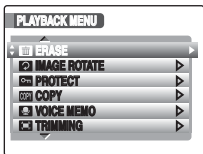

- 2 Press MENU/OK to open the PLAYBACK MENU.



- 3 Press or to select the menu.



- 4 Press .

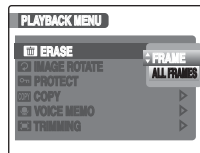

- 5 Press or to change the setting.



- 6 Press MENU/OK to confirm the setting.

Rotating the images (IMAGE ROTATE)

When shooting in the vertical position, the image appears horizontal on the LCD monitor. Use this mode to rotate an image and to display correct direction.

! CAUTION

Protected frames (files) cannot be rotated. Unprotect the frames (files) before rotating them (→p.79).

MEMO

An image can be rotated only when playing back using FinePix Z5fd.

You may not be able to rotate images that were shot with a camera other than FinePix Z5fd.

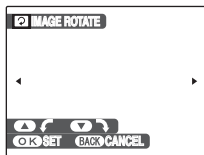

① Select the frame (file) to rotate.



② Press ▲ or ▼ to rotate the image.

▼: Rotates the image clockwise at a 90 degree angle.

▲: Rotates the image counterclockwise at a 90 degree angle.

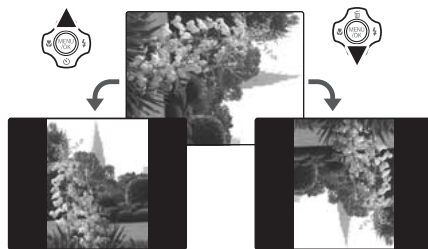

③ Press MENU/OK to confirm the setting. Next time the image is played back, it will be automatically rotated. Press DISP/BACK to cancel rotating the image.



Intelligent Face Detection

When shooting a person in a vertical position, press  (Intelligent Face Detection) to rotate to display the correct direction.

Protecting the images (**PROTECT**)

Use this mode to prevent frames (files) from being accidentally erased. Your camera calls images "frames".

FRAME SET / RESET

To protect or unprotect only the selected frame (file):

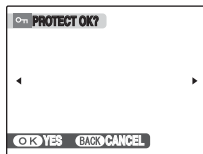

Unprotected

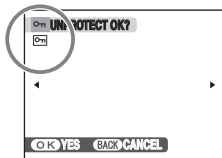

Protected (**PROTECT** appears)



- ① Press ◀ or ▶ to select the protecting/unprotecting frame (file).



- ② Press MENU/OK to protect/unprotect the currently displayed frame (file).
Unprotected: protecting frame (file)
Protected: reset frame (file)

To protect another frame (file), repeat steps ① and ②.
When protecting frames (files) is completed, press DISP/
BACK.

SET ALL

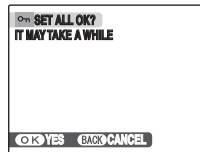

Press MENU/OK to protect all the frames (files).

RESET ALL

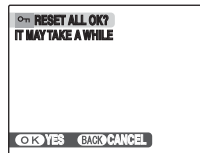

Press MENU/OK to unprotect all the frames (files).

Continued ➔

 **MEMO** To stop the procedure midway

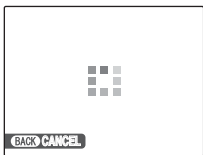

If the images are very large, protecting or unprotecting all the frames (files) may take some time.
If you want to take a picture or record a movie during the procedure, press DISP/BACK.

 **CAUTION**

The Format function erases all the frames (files), including protected frames (files) (→p.101).

 **Copying the images**
(COPY COPY)

It is possible to transfer saved images between the internal memory and an **xD-Picture Card**. Your camera calls images "frames".

■ **Selecting COPY**

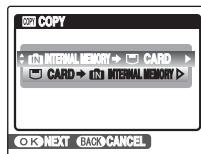

- ① Press ▲ or ▼ to select **INTERNAL MEMORY** → **CARD** or **CARD** → **INTERNAL MEMORY**.



- ② Press ►.

Copying one frame at a time (FRAME)

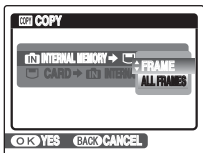

① Press ▲ or ▼ to select FRAME.



② Press MENU/OK.

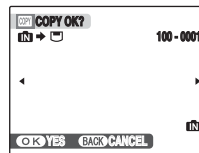

③ Press ◀ or ▶ to select the copying frame (file).



④ Press MENU/OK to copy the currently displayed frame (file).



MEMO

To copy another frame (file), repeat steps ③ and ④.
When copying frames (files) is completed, press DISP/
BACK.

Continued ➔

Copying all frames (ALL FRAMES)

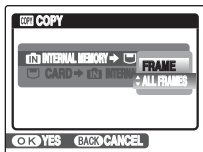

① Press ▲ or ▼ to select ALL FRAMES.



② Press MENU/OK.

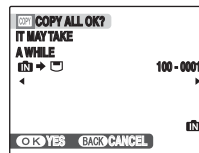

③ Press MENU/OK to copy all the frames (files).







! CAUTION

- When “MEMORY FULL” or “MEMORY FULL” appears on the LCD monitor, copying the data stops on the way.
- When copying the image that has specified DPOF setting, the DPOF setting is not copied.

Adding voice memos to the images (🗣️ VOICE MEMO)

Voice memos of up to 30 seconds can be added to still images.

Recording voice memos

- 1 Press  to set the camera to Playback mode (→p.33)
- 2 Press  or  to select the image to add a voice memo.
- 3 Press MENU/OK to open the menu.
- 4 Press  or  to select  VOICE MEMO.
- 5 Press .



- 6 Press MENU/OK to start recording.

Face the microphone to record your comment. Hold the camera about 20 cm (7.9 in.) away for the best results.

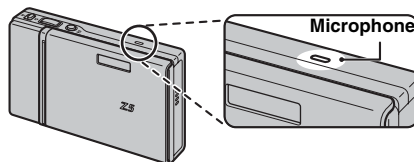

The remaining recording time appears during recording.

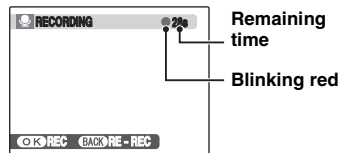

Continued ➔

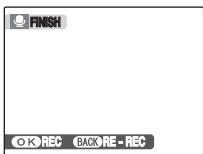

- ⑦ The voice memo ends when pressing MENU/OK midway or 30 seconds pass.

To record your comment: press MENU/OK.
To rerecord the comment: press DISP/BACK.

MEMO

- When the image already has a voice memo

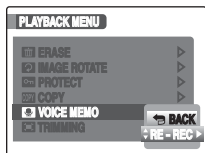

If you select an image that already has a voice memo, a screen appears in which you can select whether to rerecord the memo.

- When "PROTECTED FRAME" appears, unprotect the frame (→p.79).
- Voice memos cannot be added to movies.

Playing back voice memo



- ① Press ◀ or ▶ to select an image file with a voice memo. appears on the LCD monitor.
(Setting the camera to Playback mode (→p.33))



- ② Press ▼ to start playing back the voice memo.

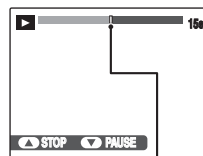

Progress bar



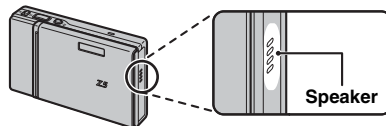

The playback time appears on the LCD monitor along with a progress bar.

CAUTION



Uncover the speaker.
The sound may be difficult to hear.

■ Playing back voice memos

	Control	Description
Playback		Playback begins. The voice memo stops when playback ends.
Pause / Resume		Pauses the voice memo during playback. Press ▼ again to resume playback.
Stop		Stops playback. Press ◀ or ▶ while voice memo playback is stopped to go back to the previous file or advance to the next file respectively.
Fast forward / Rewind		Press ◀ or ▶ during playback to skip forwards or backwards through the voice memo. These buttons do not function while playback is paused.

✓ CHECK

- Audio recording format:
WAVE (→p.149), PCM recording format
- Audio file size:
Approx. 480 KB (for a 30-second voice memo)

📁 MEMO Playing back voice memo files

You may not be able to play back some voice memo files recorded on other cameras.

Adjusting volume of voice memos

Volume can be adjusted while playing back voice memos.

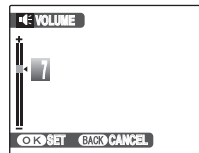

- 1 Press MENU/OK while playing back voice memo.
The voice memo is paused during playback.



- 2 Press ▲ or ▼ to adjust the volume.



- 3 Press MENU/OK to confirm your selection.
Camera starts to play back the voice memo.

Trimming the images (TRIMMING)

Use this mode to trim the required part of the photographed image.

CHECK

Before selecting the “” TRIMMING menu, select the frame (file) to trim.

W button
(Zoom out)



Zoom bar

T button
(Zoom in)



- 1 Press **W** or **T** to zoom in or out on an image.



Navigation screen
(Current displayed image)



- 2 Press **▲**, **▼**, **◀**, or **▶** to display another part of the image.





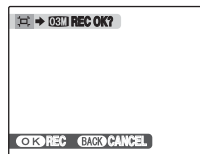

- 3 Press **MENU/OK**.



- 4 Check the saved image size and press **MENU/OK**.
The trimmed image is added as a separate file in the final frame.

 **MEMO**

- Pressing DISP/BACK in step ① or ② returns to single-frame playback.
- A saved image size varies depending on the zoom scale of step ①. For 0.3 M,  YES option appears in yellow.
- Image sizes



	Printing at up to 6R (15.2 × 20.3 cm/6 × 8 in.) / A5 size
	Printing at up to 4R (10.2 × 15.2 cm/4 × 6 in.) / A6 size
	To use for e-mail or web site

- When  quality setting is selected, the image is trimmed to normal size (4:3 aspect ratio).

 **CAUTION**

You may not be able to trim images that were shot with a camera other than FinePix Z5fd.

 **Intelligent Face Detection**

For images taken with Intelligent Face Detection (→p.28) ( appears on the LCD monitor), you can zoom in on the focused faces and easily trim the main subject by pressing  (Intelligent Face Detection). When you want the freedom to trim a particular location, you can adjust images with the normal trimming procedure.

Recording Movies

Use this mode to record movies with sound.

1 Set the camera to Movie mode.

Set the Mode switch to .

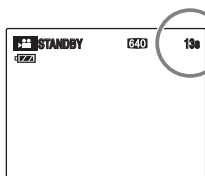
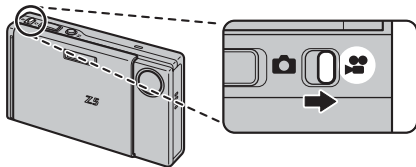

The available recording time appears on the LCD monitor.

■ Zooming the image

You must zoom beforehand as you cannot zoom during recording.

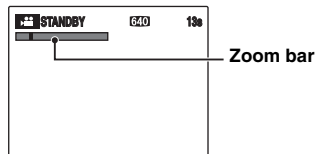

Press **W** or **T** to zoom in or out on an image.

CHECK

- Optical zoom focal length
Approx. 36 mm to 108 mm (35 mm camera equivalent)
Max. zoom scale: 3x
- Focal range
Approx. 60 cm (2.0 ft.) to infinity

2 Record movies.



Fully pressed

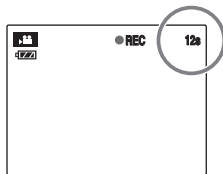

Press the shutter button down fully to start recording. During recording, ●REC and a counter that shows the remaining time appear on the LCD monitor.



Halfway pressed

Recording ends when pressing the shutter button down halfway during recording or the remaining time runs out.

MEMO

There is no need to hold down the shutter button during recording.

CHECK Recording movies

- Specifications: Motion JPEG (→p.149), Monaural sound
- Quality selection method: **640** (640 × 480 pixels)
320 (320 × 240 pixels)
- Frame rate (→p.149): 30 frames per second (fixed)

MEMO

- The brightness and color of the LCD monitor shown during movie recording may differ from those shown before recording begins.
- Pressing the shutter button down fully fixes the focus, however the exposure and white balance are adjusted to the scene being shot.
- If recording is stopped immediately after it begins, 1 second of the movie is recorded onto the **xD-Picture Card** or internal memory.

CAUTION

- Because a movie is recorded onto the **xD-Picture Card** or internal memory as it is saved, it cannot be recorded correctly if the camera suddenly loses power (if the battery runs out or the AC power adapter is disconnected).
- A movie file taken by FinePix Z5fd may not be playable on other cameras.
- Because sound is recorded concurrently with the images, make sure that you do not cover the microphone with a finger, etc. (→p.12).
- Camera operation noises may be recorded during movie shooting.

Continued ➔

Changing movie size

Press **F** to open the **F-MODE MENU**.

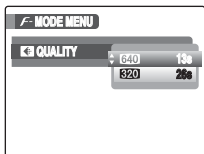

① Press **▶**.



② Press **▲** or **▼** to change the setting.



③ Press **MENU/OK** to confirm the setting.

Quality settings in Movie mode

640 (640 × 480 pixels): For better quality

320 (320 × 240 pixels): To record longer movies

MEMO

- The quality setting is retained even when the camera is turned off or the mode setting is changed.
- In **Movie mode**, you cannot set the **ISO** (sensitivity) setting and **FinePix COLOR** setting.
- See p.147 for information on recording times per **xD-Picture Card** or internal memory.

CAUTION

If you shoot using the **xD-Picture Cards** with model numbers containing "M" such as DPC-M1GB, movie recording time may be reduced if you repeatedly record and erase (frame erase) image files. In such a case, erase all frames or format the **xD-Picture Card** before use. Back up important frames (files) onto your PC or another media.

▶ Playing Back Movies

Setting the camera to ▶
Playback mode (→p.33)

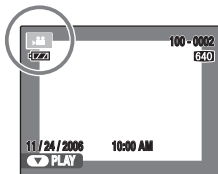

① Press ◀ or ▶ to select the movie file. ▶ appears on the LCD monitor.



② Press ▼ to begin playing back movie.

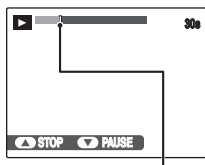

Progress bar

The playback time appears on the LCD monitor along with a progress bar.

■ Playing back movies

	Control	Description
Playback		Playback begins. Playback stops when the end of the movie is reached.
Pause / Resume		Pauses the movie during playback. Press ▼ again to resume playback.
Stop		Stops playback. Press ◀ or ▶ while playback is stopped to go back to the previous file or advance to the next file respectively.
Fast forward / Rewind		Press ◀ or ▶ during playback to skip forwards or backwards through the movie.
Skip playback		Press ◀ or ▶ when the movie is paused, the movie advances or goes back one frame. Hold down ◀ or ▶ to move through the frames quickly.

Continued ➔

 **MEMO**

If the subject of the shot is very bright, white vertical streaks or black horizontal streaks may appear in the image during playback. This is normal.

 **CAUTION**

- You may not be able to play back some movie files recorded on other cameras.
- To play back movie files on a PC, save the movie file on the **xD-Picture Card** or internal memory to the PC's hard disk and then play back the saved file.
- Uncover the speaker. The sound is difficult to hear.

Adjusting volume of movies

Volume can be adjusted while playing back movies.

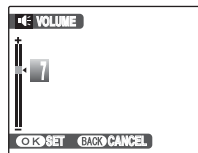

- 1 Press MENU/OK while playing back movie.
The movie is paused during playback.



- 2 Press ▲ or ▼ to adjust the volume.



- 3 Press MENU/OK to confirm the setting.
Camera starts to play back the movie.

Using the SET-UP menu

1 Open the SET-UP menu.



① Press MENU/OK to open the menu.



② Press ▲ or ▼ to select SET SET-UP.



③ Press ►.

2 Change the page.

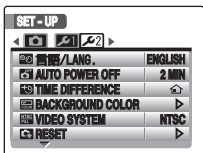

① Press ◀ or ▶ to select the page.



② Press ▼ to move to menu item.

3 Change the setting.

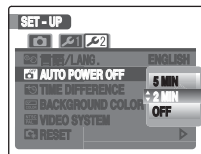

① Press ▲ or ▼ to select the menu.



② Press ►.
Different type of screen appears depending on selected item.





















③ Press ▲ or ▼ to change the setting.



④ Press MENU/OK to confirm the setting.

SET-UP menu option

	Setting	Display	Factory default	Explanation	Page
	 IMAGE DISP.	3 SEC/1.5 SEC/ZOOM (CONTINUOUS)	1.5 SEC	Sets the way for displaying the check image screen (photograph result) after taking a picture. The color tones in images recorded may differ from actual color. Play back the recorded images to check them.	97
	 FRAME NO.	CONT./RENEW	CONT.	Specifies whether frame numbers are assigned consecutively from previous numbers or begin again.	98
	 ILLUMINATION	ON/OFF	ON	Sets whether the illumination lamp lights at startup and after shooting is complete.	99
	 DIGITAL ZOOM	ON/OFF	OFF	Specifies whether digital zoom is used together.	99
	 LCD MODE			Sets the LCD monitor display to the fine mode or power save mode.	100
	 DATE/TIME	–	–	Corrects the date or time.	23
	 BEEP VOLUME	 OFF		Sets the volume of the tone emitted when the camera controls are used.	–
	 SHUTTER VOLUME	 OFF		Sets the volume of the sound emitted when the shutter operates.	–
	 PLAYBACK VOLUME	–	7	Sets the volume of playing back movie and voice memo.	100
	 LCD BRIGHTNESS	–	0	Sets the LCD monitor brightness.	101
	 FORMAT	–	–	Initializes an xD-Picture Card or internal memory. Select this menu to erase all the frames (files).	101

Continued →











	Setting	Display	Factory default	Explanation	Page
2	 言語/LANG.	日本語/ENGLISH/ FRANCAIS/DEUTSCH/ ESPAÑOL/ITALIANO/ 中文簡/繁體/한글 РУССКИЙ/PORTUGUÊS NEDERLANDS/TÜRKÇE	ENGLISH	Specifies the language used for LCD monitor display.	24
	 AUTO POWER OFF	5 MIN/2 MIN/OFF	2 MIN	Sets the time of turning camera off when camera is not used.	102
	 TIME DIFFERENCE			Specifies the time difference settings.	102
	 BACKGROUND COLOR	-	-	Specifies the colors of menu and background.	-
	 VIDEO SYSTEM	NTSC/PAL	-	Specifies whether video output is set to NTSC or PAL.	-
 RESET	-	-	Resets all the camera settings (other than the DATE/TIME, TIME DIFFERENCE, BACKGROUND COLOR, and VIDEO SYSTEM) to the factory default values set at shipment. A confirmation message appears when you press  . To reset the camera settings, press  or  to select OK and press MENU/OK.	-	

IMAGE DISP.

Use this setting to specify the way for displaying the check image screen (photograph result) after taking a picture.

3 SEC/1.5 SEC:

The image appears for about 3 or 1.5 seconds and is then recorded.

ZOOM (CONTINUOUS):

The image appears enlarged. Use this mode to check details of image.

! CAUTION

- The color tones in images displayed when 3 SEC or 1.5 SEC is selected may differ slightly from those in the images actually recorded.
- IMAGE DISP. cannot be used when  LONG PERIOD (→p.63) is set.

■ Enlarging images

Navigation screen
(Current displayed image)



- 1 Press **W** or **T** to zoom in or out the image.





- 2 Press **▲**, **▼**, **◀**, or **▶** to display another part of the image.



- 3 Press **MENU/OK** to take another picture.
The image is recorded automatically.

**MEMO**

- When  IMM quality setting is selected, the image cannot be enlarged.
- Press **DISP/BACK** to cancel the zoom setting.
- This function is disabled when setting the continuous shooting.
- This function is disabled when selecting  in the **SHOOTING MODE**.



Intelligent Face Detection

For images taken with Intelligent Face Detection (→p.28), the displayed face switches to allow confirmation each time you press  (Intelligent Face Detection).

Press the **W** button (zoom out) or **T** button (zoom in) to display the selected face zoomed in or out. Press **▲**, **▼**, **◀**, or **▶** to display another part of the image.

FRAME NO.

Use this function to specify whether frame numbers are assigned consecutively from previous numbers or begin again.

	<CONT.>	<RENEW>
	0001 ⋮ 0005	0001 ⋮ 0005
↓		
	0006 ⋮ 0010	0001 ⋮ 0005

* Formatted **xD-Picture Card** or internal memory used for both A and B.

CONT. : Pictures are stored beginning from the highest file number stored on the last **xD-Picture Card** or internal memory used.

RENEW: Pictures are stored on each **xD-Picture Card** beginning with a file number 0001.

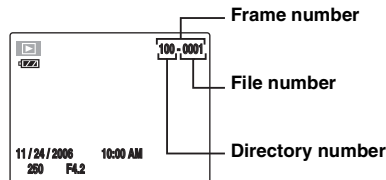
 **CHECK**

The last 4 digits of the 7-digit number in the top right corner of the LCD monitor are the file numbers, while the first 3 digits show the directory number.

 **MEMO**

- Setting this function to **CONT.** makes file management easier as it makes sure that file names are not duplicated when images are downloaded to a PC.
- When the camera settings are  **RESET** (→p.96), the frame number setting (**CONT.** or **RENEW**) is changed to **CONT.** and the frame number itself does not return to 0001.
- In **CONT.** setting, images are stored beginning from the highest file number on the current **xD-Picture Card** when the **xD-Picture Card** already contains image files with file numbers higher than the highest file number on the last **xD-Picture Card**.
- File number runs from 0001 to 9999. Once 9999 is exceeded, the directory number changes from 100 to 101. The maximum number is 999-9999.
- The displayed frame number may differ for images photographed on other cameras.

ILLUMINATION

Use this function to specify whether the illumination lamp lights at startup and after shooting is complete. When turned ON, it indicates to the subjects of the picture that shooting is complete.

DIGITAL ZOOM

Use this function to shoot enlarged images than maximum optical zoom scale.

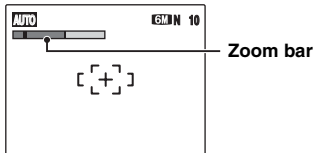

Zoom bar display

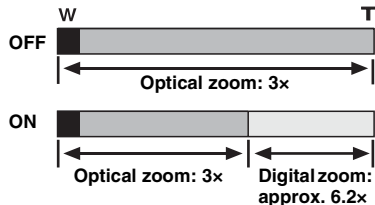

✓ CHECK

- Optical zoom focal length*
Approx. 36 mm to 108 mm
(**6.2x**: Approx. 38 mm to 114 mm)
- Digital zoom focal length*
Approx. 108 mm to 670 mm
(**6.2x**: Approx. 114 mm to 707 mm)
Max. zoom scale: approx. 6.2x
* 35 mm camera equivalents

📄 MEMO

When zooming changes between optical and digital, the position of the "■" indicator stops. Press the same Zoom button again to start the "■" indicator moving again.

⚠ CAUTION

Using the digital zoom allows you to enlarge your subject and shoot it. However, it will lower your image quality. Set the digital zoom when requiring it.

LCD MODE

Use this function to set the LCD monitor display to the fine mode or power save mode.

30fps/60fps

Use this function to change the number of images (frames) per second on the LCD monitor display.

 60 fps is the finer setting.

POWER SAVE

The LCD monitor darkens when camera is not used for 10 seconds.

When this function is active, you can save power and get the maximum possible running time from your battery.

MEMO

Pressing any button wakes the camera up.

CAUTION

- The LCD MODE function is disabled during the High-speed shooting mode, Playback mode, and Movie mode.
- Power save mode is disabled when Intelligent Face Detection (→p.28) is on.

PLAYBACK VOLUME

Use this function to adjust volume while playing back movie and voice memo.

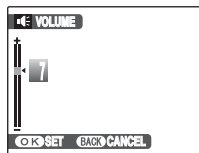

- 1 Press ▲ or ▼ to adjust the volume.
The larger the number, the larger the volume is emitted. 0 indicates a sound deadening.



- 2 Press MENU/OK to confirm the setting.

LCD BRIGHTNESS

Use this function to adjust the LCD monitor brightness.

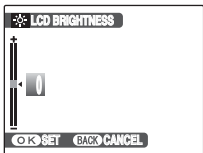



- 1 Press ▲ or ▼ to adjust the LCD monitor brightness.
The indicator moves to the + to display the LCD monitor brightly or to the – to darken the LCD monitor.
- 2 Press MENU/OK to confirm the setting.

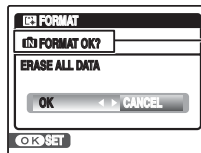

FORMAT

Initialize (format) the **xD-Picture Card** or internal memory for use with the camera.



Place of initialize
 **FORMAT:**
 Internal memory
 **FORMAT:**
 xD-Picture Card



- 1 Press ◀ or ▶ to select OK.



- 2 Pressing MENU/OK initializes the **xD-Picture Card** or internal memory.

! CAUTION

- The Format function erases all the frames (files), including protected frames (files).
Back up important frames (files) onto your PC or another media.
- Do not open the battery cover during formatting, as formatting will be interrupted.

AUTO POWER OFF

When this function is active and the camera remains unused for 2 or 5 minutes, it turns camera off. Use this function when you want to get the maximum possible running time from your battery.

! CAUTION

The Auto power off function is disabled during slide shows (→p.70), and when a printer or a PC connection (→p.105, 116) is being used.

MEMO To restore power to the camera





To take pictures, close the lens cover completely and then reopen it (→p.20). To play back images, hold down  for about 1 second (→p.20).

TIME DIFFERENCE

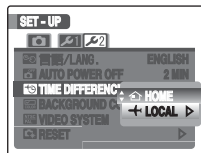
Use this function when traveling to destinations in different time zones. This function sets a time difference relative to the date and time currently set. When this setting is enabled, the specified time difference is applied when pictures are taken.

1 Use Time difference function.



Press  or  to change between  HOME and  LOCAL.

To set the time difference, select  LOCAL.

 HOME: Your home time zone

 LOCAL: Your destination time zone

2 Move to TIME DIFFERENCE screen.

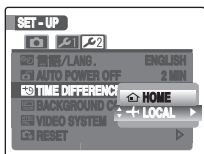

Press ►.

3 Set time difference.

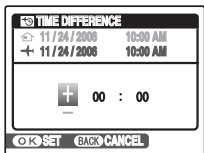

① Press ◀ or ▶ to select +/-, hour, and minute.



② Press ▲ or ▼ to change the setting.



③ Always press MENU/OK after the settings are completed.

✓ CHECK

Available time setting

-23:45 to +23:45 (in 15-minute increments)

📄 MEMO

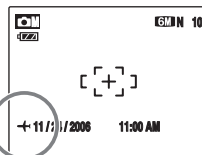

In the time difference setting, when you change to the Shooting mode, + and the date is displayed for 3 seconds, the date display turns yellow.

✓ CHECK

Upon returning from a trip, always change the time difference setting back to HOME and then check the date and time again.

Connecting to a TV

When connecting to a TV, images can be displayed on wider screen. You can enjoy using the slide show function (→p.70) at parties and other gatherings.

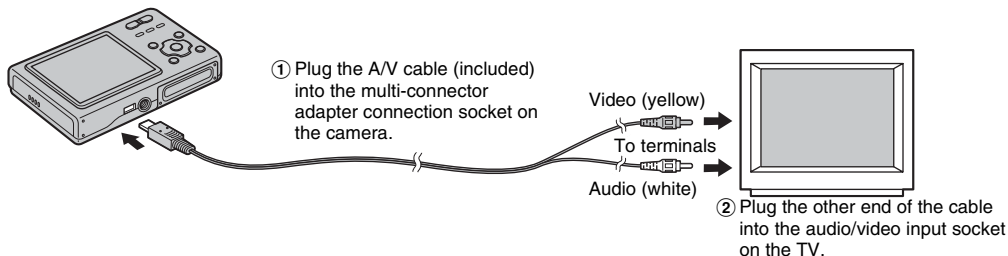

! CAUTION

Plug the A/V cable (included) correctly and push it in the terminal.

MEMO

- When connecting the A/V cable (included) to TV, the LCD monitor is turned off.
- The image quality for movie playback is lower than for still images.
- When connecting to a TV, even if you adjust the volume from the **[M]** PLAYBACK VOLUME, the TV volume cannot be changed. Refer to the instructions provided with your TV for more information on audio/video input for your TV.

Connecting Camera Directly to Printer — PictBridge Function



When a printer that supports PictBridge is available, images can be printed by connecting the camera directly to the PictBridge-compatible printer without a PC.

Connecting to a printer

- 1 Connect the camera to your printer using the USB cable.

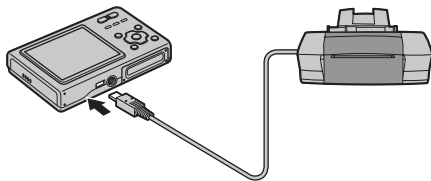

- 2 Connect the camera to a printer and turn the printer on. Press  for about 1 second to turn the camera on.



"USB" appears on the LCD monitor.

- 3 The following screen appears on the LCD monitor after a moment.

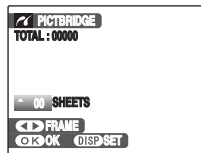

"Specifying images for printing"
→p.106
"Printing with DPOF setting"
→p.107



MEMO

Depending on the printer, some functions are disabled.

Continued ➔

Specifying images for printing (PRINT WITH DATE / PRINT WITHOUT DATE)

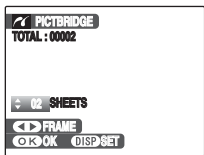

- ① Press ◀ or ▶ to display the frame (file) for specifying PRINT setting.



- ② Press ▲ or ▼ to set a value.
Up to 99 sheets are printed.

To specify more PRINT settings, repeat steps ① and ②.



- ③ Press MENU/OK to display the confirm setting.

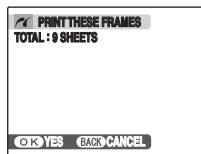

- ④ Press MENU/OK again to download the data to the printer and start printing the specified number of prints.



MEMO

Even if MENU/OK is pressed with total number of images set at 0 (zero), the screen printing once appears on the LCD monitor. Press MENU/OK again and printing starts.



MEMO Printing with date

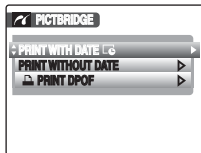

- ① Press DISP/BACK to display the setting display.
② Press ▲ or ▼ to select PRINT WITH DATE L6.
③ Press MENU/OK.



CAUTION

PRINT WITH DATE L6 is not available when the camera is connected to a printer that does not support date printing.

Printing with DPOF setting (PRINT DPOF)

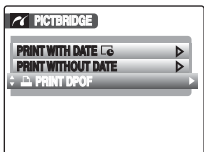

- ① Press DISP/BACK to open the menu.



- ② Press ▲ or ▼ to select PRINT DPOF.



- ③ Press MENU/OK to display the confirm setting.

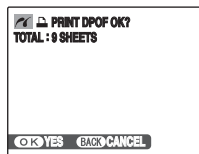

- ④ Press MENU/OK again to download the data to the printer and start printing the specified frames (files) continuously.

✓ CHECK

To select PRINT DPOF, the DPOF settings must be specified on FinePix Z5fd beforehand (→p.71).

! CAUTION

Even when WITH DATE is specified in the DPOF settings (→p.71), the date is not inserted on printers that do not support date printing.

Continued ➔

 **MEMO**

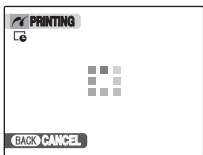

Press DISP/BACK to cancel the printing. Depending on the printer, the printing may not be canceled immediately or printing may stop midway through. When printing stops midway, press  to turn the camera off and then on again.

Disconnecting the printer

- ① Check that "PRINTING" is not displayed on the camera's LCD monitor.
 - ② Press  to turn the camera off. Unplug the USB cable.
-

 **MEMO**

DPOF setting can be specified for images on internal memory.

 **CAUTION**

- In PictBridge function, images photographed on other than a camera may not be printed.
- The camera cannot be used to specify printer settings such as the paper size and print quality.
- Use internal memory or an **xD-Picture Card** that was formatted on FinePix Z5fd.
- Movies cannot be printed.
- Images photographed with a camera other than FinePix Z5fd may not be printed.

Installation on a Windows PC

Pre-installation checklist

■ Hardware and software requirements

To run this software, you must have the hardware and software described below. Check your system before you begin the installation.

Operating System *1	Windows 98 SE Windows Millennium Edition (Windows Me) Windows 2000 Professional*2 Windows XP Home Edition*2 Windows XP Professional*2
CPU	200 MHz Pentium minimum
RAM	64 MB minimum
Hard disk space	Amount required for installation: 450 MB minimum Amount required for operation: 600 MB minimum (When using ImageMixer VCD2 LE for FinePix: 2 GB or better)
Display	800 × 600 pixels or better, 16-bit color or better (When using ImageMixer VCD2 LE for FinePix: 1024 × 768 pixels or better)
Internet connection *3	<ul style="list-style-type: none">• To use the FinePix Internet Service or mail attachment function: An Internet connection or e-mail transmission software is needed• Connection speed: 56 k or better recommended

*1 Models with one of the above operating systems pre-installed.

*2 When you install the software, login using a system administrator account (e.g. "Administrator").

*3 Required to use the FinePix Internet Service. The software can still be installed even if you do not have an Internet connection.

■ Recommended system

Operating System	Windows XP
CPU	2 GHz Pentium 4 or better recommended
RAM	512 MB or better recommended
Hard disk space	2 GB or better
Display	1024 × 768 pixels or better, Highest (32 bit)
Internet connection	Broadband (ADSL, FTTH, CATV, etc.)

MEMO

- Connect the camera directly to the PC using the USB cable. The software may not operate correctly when you use an extension cable or connect the camera via a USB hub.
- When your PC has more than one USB port, the camera can be connected to either port.
- Push the USB connector fully into the socket to ensure that it is securely connected. The software may not operate correctly if the connection is faulty.
- Additional USB interface board is not guaranteed.
- Windows 95, Windows 98 and Windows NT cannot be used.
- Operation is not guaranteed on home-built PCs or on PCs running updated operating system software.
- When you reinstall or remove FinePixViewer, the Internet menu and your user ID and password for the FinePix Internet Service are deleted from your PC. Click the [Register now] button, enter your registered user ID and password and download the menu again.

Continued ➔

Do not connect the camera to your PC until the software installation is completed.

1 Install FinePixViewer as instructed in the Quick start guide.

Launching the installer manually

- ① Double-click the "My Computer" icon.
* Windows XP users should click "My Computer" in the "Start" menu.
- ② Right-click "FINEPIX" (CD-ROM drive) in the "My Computer" window and select "Open".
- ③ Double-click "SETUP" or "SETUP.exe" in the CD-ROM window.



- * The way file names are displayed differs as described below depending on your PC settings.
- File extensions (3-letter suffixes indicating the file type) may be shown or hidden. (e.g. Setup.exe or Setup)
 - Text may be shown normally or all in uppercase (e.g. Setup or SETUP).

Installing other applications

You may see messages for installing ImageMixer VCD2 LE for FinePix. Install this application as directed by the on-screen instructions.

2 Install DirectX as directed by the on-screen instructions and then restart your PC. If the latest version of DirectX is already installed on your PC, this installation is not performed.

! CAUTION

- If the latest version is already installed, this window does not appear.
- Do not remove the CD-ROM during this procedure.

3 After restarting, the USB Video Class Driver would be installed.

! CAUTION

If the latest version is already installed, this window does not appear.

4 After restarting the PC, a message appears stating "Installation of the FinePixViewer has been completed".

Installation on a Mac OS X

Pre-installation checklist

Hardware and software requirements

To run this software, you must have the hardware and software described below. Check your system before you begin the installation.

Compatible Mac *1	Power Macintosh G3*2, PowerBook G3*2, Power Macintosh G4, iMac, iBook, Power Macintosh G4 Cube, PowerBook G4, Power Macintosh G5, MacBook, MacBook Pro, or Mac mini
Operating System	Mac OS X (compatible with version 10.3.9 to 10.4.7)
RAM	192 MB minimum 256 MB or better recommended
Hard disk space	Amount required for installation: 200 MB minimum Amount required for operation: 400 MB minimum (When using ImageMixer VCD2 LE for FinePix: 2 GB or better)
Display	800 × 600 pixels or better, at least 32,000 colors (When using ImageMixer VCD2 LE for FinePix: 1024 × 768 pixels or better)
Internet connection *3	<ul style="list-style-type: none">• To use the FinePix Internet Service or mail attachment function: An Internet connection or e-mail transmission software is needed• Connection speed: 56 k or better recommended

*1 PowerPC or Intel Processor loaded

*2 Models with a USB port as a standard feature

*3 Required to use the FinePix Internet Service. The software can still be installed even if you do not have an Internet connection.

MEMO

- Connect the camera directly to the Macintosh using the USB cable. The software may not operate correctly if you use an extension cable or connect the camera via a USB hub.
- Push the USB connector fully into the socket to ensure that it is securely connected. The software may not operate correctly if the connection is faulty.
- Additional USB interface board is not guaranteed.

Continued ➔

- 1** Turn your Macintosh on and start up Mac OS X. Do not launch any other applications.
- 2** When the bundled CD-ROM is loaded into the CD-ROM drive, the “FinePix” icon appears. Double-click the “FinePix” icon to open the “FinePix” volume window.
- 3** Double-click on “Installer for MacOSX”.
- 4** The Installer setup dialog appears. Click the [Installing FinePixViewer] button.

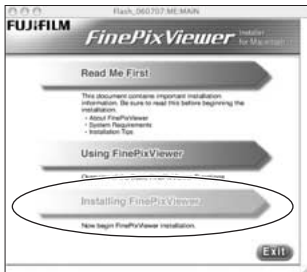

! **CAUTION**

For more information on what is installed, click the [Read Me First] button and [Using FinePixViewer] button.

- 5** The “Authenticate” dialog appears. Enter the name and password for the administrator account and then click the [OK] button.*
- * The administrator account is the user account used for Mac OS X installation and you can confirm the user account in the Accounts dialog in the System Preferences.
- 6** The “License” dialog appears. Read the agreement carefully and then, if you agree to the terms of the Agreement, click the [Accept] button.
- 7** The “Read me” dialog appears. Click the [Continue] button.
- 8** The “FinePixInstallOSX” window appears. Click the [Install] button to install FinePixViewer.

9 The ImageMixer VCD2 LE for FinePix installer automatically starts up and a window showing the installation progress appears (Installation may take several minutes).

10 The “FinePixViewer installation completed” message dialog appears. Then click exit button and close it.

! **CAUTION**

When Safari is used as the Web browser, a message may be displayed and the CD-ROM may not be removed. If this happens, click the Safari icon in the Dock to make Safari the active application and then select “Quit Safari” in the “Safari” menu to shut down Safari.

11 Launch “Image Capture” from the “Applications” folder.

12 Change the Image Capture settings. Select “Preferences...” from the “Image Capture” menu.



13 Select “Other...” from “When a camera is connected, open”.

14 Select “FPVBridge” from “FinePixViewer” folder in the “Applications” folder and click the [Open] button.



15 Select “Quit Image Capture” menu in the “Image Capture” menu.

Connecting to a PC

By connecting the camera to a PC, your system can be expanded to fill a wide range of uses. Using "FinePixViewer" performs images saving, browsing and file management etc.

MEMO

We recommend connecting the camera when it has sufficient battery charge remaining. If the power cuts out during data transmission, the data will not be transmitted correctly. Always use the AC power adapter when connecting the camera to a PC.

Refer to Software Installation (→p.110, 113) the first time you connect the camera to your PC.

Install the software first. Do not connect the camera to the PC before installing all the software.



CD-ROM
(Software for FinePix CX)

- ① Insert the **xD-Picture Card** with images into the camera (→p.18).

CAUTION

- Do not format the **xD-Picture Card** in the camera on the PC.
- Use the **xD-Picture Card** with images taken by a FUJIFILM Digital camera.
- When connecting to a PC, if the **xD-Picture Card** contains large image or movie files, connection or transmission may take time or images may not be stored. In these cases, use the Image Memory Card Reader (sold separately), etc.

- ② Connect the camera to the PC with the supplied USB cable.

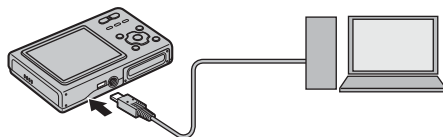

- ③ Press  for about 1 second to turn the camera on.

! CAUTION

- The FinePix Z5fd is a PTP-compatible camera. PTP-compatible cameras automatically recognize PC or printer connections for easy connectability.
- We recommend connecting the camera when it has sufficient battery charge remaining. If the camera suddenly loses power during data exchange, the **xD-Picture Card** or internal memory could be damaged.
- Do not disconnect the USB cable when the camera is communicating with a PC. If disconnecting the USB cable during communication, the files on the **xD-Picture Card** or internal memory could be damaged.
- In Mac OS X, you must set the automatic setup when the first time you connect the camera to your PC.
- Make sure that USB cable is connected correctly and pushed in.
- Perform pre-arranged steps to disconnect and turn off the camera (→p.118).
- When the camera and PC are exchanging data, the indicator lamp blinks alternately green and orange.
- Auto power off is disabled during PC connection.
- Before replacing the **xD-Picture Card**, always disconnect the camera from the PC. See p.118 for information on the disconnection procedure.
- The camera and PC may be exchanging data even when "Copying" disappears on your PC screen. Before disconnecting the USB cable, always check that the indicator lamp is off.
- Always use FinePixViewer to transfer images with voice memos to a PC.

④ Set a PC.

Windows 98 SE / Me / 2000 Professional / Macintosh

! CAUTION

The Windows CD-ROM may also be required during installation. In this event, change CD-ROMs as directed by the on-screen instructions.

- FinePixViewer automatically starts up and the Save Image Wizard window (Save Image dialog box) appears. Follow the instructions provided on screen to save the images. To proceed without saving the images, click the [Cancel] button.



* Screen for Windows 2000 Professional

Continued ➔

 **MEMO**

- Only images saved with FinePix Viewer can be viewed. We recommend always saving your images on a PC.
- If you cancel saving by clicking the [Cancel] button, make sure to press  to turn off the camera before disconnecting it from the PC.

Windows XP

① The “Found New Hardware” help message appears in the bottom-right corner of your screen. This message will close when the settings are completed. No action is required.

 **CAUTION**

This step is not required for subsequent connections.

② FinePixViewer automatically starts up and the Save Image Wizard window (Save Image dialog box) appears. Follow the instructions provided on screen to save the images. To proceed without saving the images, click the [Cancel] button.

 **MEMO**

- Only images saved with FinePix Viewer can be viewed. We recommend always saving your images on a PC.
- If you cancel saving by clicking the [Cancel] button, make sure to press  to turn off the camera before disconnecting it from the PC.

Proceed to “Using FinePixViewer” (→p.119).

Disconnecting the camera

1 Windows

Once the image has been saved, the window below appears (Save Image Wizard window). To disconnect the camera, click the [Remove] button.



Macintosh

Once the image has been saved, the window below appears. To disconnect the camera, click the [OK] button.

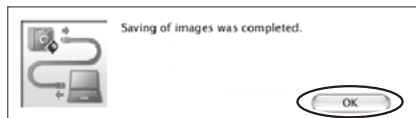

2 ① Press  to turn the camera off.

② Disconnect the USB cable from the camera.

Using FinePixViewer

Mastering FinePixViewer

For all information on FinePixViewer functions, refer to “How to Use FinePixViewer” in the Help menu for details.

• **What is explained in “How to Use FinePixViewer”...**
“How to Use FinePixViewer” covers a range of topics, including batch processing and ordering prints.

Example: Looking up slide shows

- 1 Click “How to Use FinePixViewer” in the FinePixViewer Help menu.
- 2 Click “Basic Operation” and then click “Slide Show” in the menu that appears.
- 3 The “Slide Show” information appears. Press the “<<<” key to view the previous page or the “>>>” key to view the next page.

Uninstalling the software

Only perform this operation when you no longer require the installed software or when the software was not installed correctly.

Windows

- 1 Check that the camera is not connected to the PC.
- 2 Quit all currently running applications.
- 3 Open the “My Computer” window. Then open the “Control Panel” and double-click on “Add/Remove Programs”.



- 4 The “Add/Remove Programs Properties” window appears. Select the software to be uninstalled (FinePixViewer or the driver) and then click the [Add/Remove] button.

To remove FinePixViewer

FinePixViewer Ver.5.3

To remove the driver software

FWJIFILM USB Driver



Continued ➔

- ⑤ When the message appears, click the [OK] button.
Check your selection carefully since the process cannot be canceled once you click the [OK] button.



- ⑥ Automatic uninstallation begins.
When uninstallation ends, click the [OK] button.

Macintosh

Quit FinePixViewer. Then drag the installed FinePixViewer folder to the Trash and select "Empty Trash" in the "Finder" menu.

System Expansion Option

By using FinePix Z5fd together with other optional FUJIFILM products, your system can be expanded to fill a wide range of uses. Accessory availability may vary by country. Please check with your local Fujifilm representative to confirm product availability.

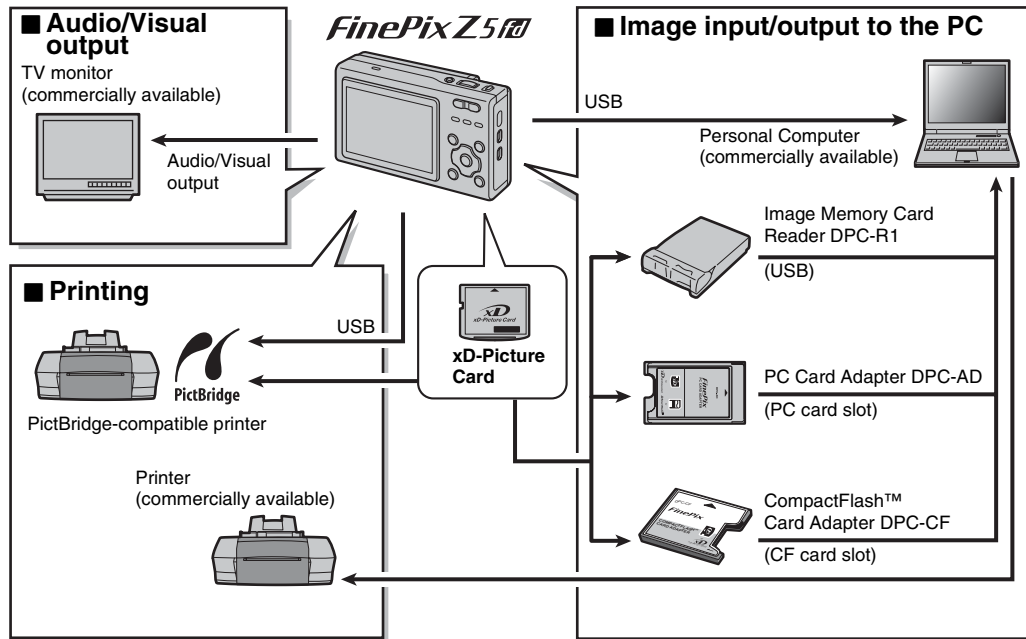

Accessories Guide

Visit the FUJIFILM web site for the latest information on camera accessories.

<http://home.fujifilm.com/products/digital/index.html>

Accessory availability may vary by country. Please check with your local Fujifilm representative to confirm product availability.

- **xD-Picture Card**

Use the following **xD-Picture Cards**:

16MB/32MB/64MB/128MB/256MB/512MB/1GB/2GB

There are two types of **xD-Picture Card**: standard type and Type M (containing "M" in the model number, such as DPC-M1GB).

FinePix Z5fd is compatible with Type M, however they may not be compatible depending on the device used (Image Memory Card Reader, etc.).



- **Battery Charger BC-65S**

Quickly charges the rechargeable battery. The BC-65S reduces charging time to approx. 95 minutes (for the NP-40). Use the Battery adapter when the NP-40 is being charged. The battery adapter is supplied with the BC-65S.

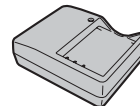

- **Rechargeable Battery NP-40 (750 mAh)**

A Lithium-ion slimline rechargeable battery

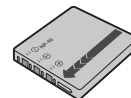

Continued ➔

• **Image Memory Card Reader DPC-R1**

The DPC-R1 provides a quick and easy way to transfer images back and forth between your PC and an image memory card (**xD-Picture Card** and SmartMedia). The DPC-R1 uses the USB interface for high-speed file transfer.

-Compatible with **xD-Picture Card** of 16 MB to 512 MB, and SmartMedia of 3.3 V, 4 MB to 128 MB.

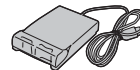

• **PC Card Adapter DPC-AD**

The PC Card Adapter allows the **xD-Picture Card** and SmartMedia to be used as a PC Card Standard ATA-compliant (PCMCIA 2.1) PC card (Type II).

-Compatible with **xD-Picture Card** of 16 MB to 512 MB, and SmartMedia of 3.3 V, 2 MB to 128 MB.



• **CompactFlash™ Card Adapter DPC-CF**

Loading an **xD-Picture Card** into this adapter allows you to use the card as a CompactFlash card (Type I).



Using Your Camera Correctly

Read this information and the “Safety Notes” (→p.157), to make sure you use your camera correctly.

■ Places to Avoid

Do not store or use the camera in the following types of locations:

- In the rain or in very humid, dirty, or dusty places
- In direct sunlight or in places subject to extreme temperature rises, such as in a closed car in summer
- Extremely cold places
- Places with strong vibration
- Places with smoke or steam
- Places subject to strong magnetic fields (such as near motors, transformers, or magnets)
- In contact with chemicals such as pesticides
- Next to rubber or vinyl products

■ Damaged by Water or Sand

FinePix Z5fd can be damaged on the inside and outside by water and sand. When you are at the beach or close to water, make sure that the camera is not damaged by water or sand. Take care not to place the camera on a wet surface.

■ Damaged by Condensation

If the camera is carried from a cold location into a warm place, water droplets (condensation) may form on the inside of the camera or on the lens. When this occurs, turn the camera off and wait an hour before using the camera. Condensation may also form on the **xD-Picture Card**. In this event, remove the **xD-Picture Card** and wait a short time.

■ When the Camera is Not Used or is stored Periods of Time

If you do not intend to use the camera for a long period of time, remove the battery and the **xD-Picture Card**.

■ Cleaning Your Camera

- Use a blower brush to remove any dust on the lens or LCD monitor, and then gently wipe the camera with a soft, dry cloth to remove soil such as fingerprints. If any soil remains, apply a small amount of lens cleaning liquid to a piece of FUJIFILM lens cleaning paper and wipe gently.
- Do not scratch hard objects against the lens or LCD monitor.
- Clean the body of the camera with a soft, dry cloth. Do not use volatile substances or cleaning products these items can cause damage.

■ Using the Camera When Traveling

When traveling overseas, do not place your camera in the check-in baggage. Baggage can be subjected to violent shocks, and the camera may be damaged inside or outside.

Power Supply and Battery

Notes on the Battery (NP-40)

This camera uses the Rechargeable Lithium-ion Battery NP-40. Note the points below when using the rechargeable battery. Take particular care to read the Safety Notes to make sure that you use the battery correctly.

- * When shipped, the NP-40 is not fully charged. Always charge the NP-40 before using it.
- When carrying the NP-40, install it in a digital camera or keep it in the soft case.
- When storing the NP-40, place it inside the special soft case provided.

Battery Features

- The NP-40 gradually loses its charge even when not used. Use a NP-40 that has been charged recently (in the last day or two) to take pictures.
- To maximize the life of the NP-40, turn the camera off as quickly as possible when it is not being used.
- The number of available frames will be lower in cold locations or at low temperatures. Take along a spare fully charged NP-40.

You can also increase the amount of power produced by putting the NP-40 in your pocket or another warm place to heat it and then loading it into the camera just before you take a picture.

If you are using a heating pad, take care not to place the NP-40 directly against the pad. The camera may not operate if you use a depleted NP-40 in cold conditions.

Charging the Battery

- You can charge the battery using the camera, and the AC power adapter (included).
 - The NP-40 can be charged at ambient temperatures between 0°C and +40°C (+32°F and +104°F). At an ambient temperature of +23°C (+73°F), it takes approx. 2 hours to charge a fully depleted NP-40 battery.
 - You should charge the NP-40 at an ambient temperature between +10°C and +35°C (+50°F and +95°F). If you charge the NP-40 at a temperature outside this range, charging takes longer because the performance of the NP-40 is impaired.
 - You cannot charge the NP-40 at temperatures of 0°C (+32°F) or below.
- You can also use the optional Battery Charger BC-65S to charge the NP-40. When charging, use the NP-40 battery adapter supplied with the BC-65S (Refer to the Owner's Manual for details).
 - The NP-40 can be charged using the BC-65S Battery Charger at ambient temperatures between 0°C and +40°C (+32°F and +104°F). At an ambient temperature of +23°C (+73°F), it takes approx. 95 minutes to charge a fully depleted NP-40 battery.
 - You should charge the NP-40 at an ambient temperature between +10°C and +35°C (+50°F and +95°F). If you charge the NP-40 at a temperature outside this range, charging takes longer because the performance of the NP-40 is impaired.
- The NP-40 does not need to be fully discharged or exhausted flat before being charged.
- The NP-40 may feel warm after it has been charged or immediately after being used. This is perfectly normal.
- Do not recharge a fully charged NP-40.

■ Battery Life

At normal temperatures, the NP-40 can be used at least 300 times.

If the time for which the NP-40 provides power shortens markedly, this indicates that the NP-40 has reached the end of its effective life and should be replaced.

■ Notes on storage

The Rechargeable Lithium-ion Battery NP-40 is both compact and capable of storing large quantities of power. However, if it is stored for long periods while charged, the performance of the battery can be impaired.

- If the battery will not be used for some time, run the battery out before storing it.
- If you do not intend to use the camera for a long period of time, remove the battery from the camera.
- Place the battery pack inside the soft case and store in a cool place.
- * The battery should be stored in a dry location with an ambient temperature between +15°C and +25°C (+59°F and +77°F).
- * Do not leave the battery in hot or extremely cold places.

■ Handling the Battery

To avoid injury or damage, observe the following:

- Do not carry or store battery with metal objects such as necklaces or hairpins.
- Do not heat the battery or throw it into a fire.
- Do not attempt to take apart or change the battery.
- Do not recharge the battery with chargers other those specified.
- Dispose of used battery promptly.

To avoid damaging the battery or shortening its life, observe the following:

- Do not drop the battery or otherwise subject it to strong impacts.
- Do not expose the battery to water.

To make sure that you obtain optimum battery performance, observe the following:

- Always keep the battery terminals clean.
- Do not store battery in warm or humid places. Storing the battery for long periods in a hot location can shorten the battery life.

If you use the battery for a long period, the camera body and the battery itself will become warm. This is normal. Use the AC power adapter supplied with the camera if you are taking pictures or viewing images for a long period of time.

■ Specifications of the included NP-40

Nominal voltage	DC 3.6 V
Nominal capacity	750 mAh
Operating temperature	0°C to +40°C (+32°F to +104°F)
Dimensions	35.3 mm × 40 mm × 6 mm (1.4 in. × 1.6 in. × 0.2 in.) (W × H × D)
Mass (Weight)	Approx. 20 g (0.7 oz.)

AC Power Adapter

Always use the AC Power Adapter AC-5VZ with the camera.

The use of an AC power adapter other than AC-5VZ can be damaged to your digital camera.

- Use the AC power adapter for indoor use only.
 - Plug the connection cord plug securely into the multi-connector adapter connection socket on the camera.
 - Turn off the camera before disconnecting the cord from the multi-connector adapter connection socket on the camera. To disconnect, pull out the plug gently. Do not pull on the cord.
 - Do not use the AC power adapter with any device other than your camera.
 - During use, the AC power adapter will become hot to the touch. This is normal.
 - Do not take apart the AC power adapter. Doing so could be dangerous.
 - Do not use the AC power adapter in a hot and humid place.
 - Do not subject the AC power adapter to strong shocks.
 - The AC power adapter may emit a humming. This is normal.
 - If used near a radio, the AC power adapter may cause static. If this happens, move the camera away from the radio.
- * Very occasionally, DC output will be prevented by the operation of the internal protection circuit. In this event, unplug the AC power adapter AC-5VZ from the power socket for a few moments and then plug it in again. This will restore DC output.

■ Specifications (AC-5VZ)

Power Supply	AC 100V to 240V,50/60Hz
Rated Input	13W (U.S.A and Canada)
Capacity	0.08A to 0.2A(other countries)
Rated Output	DC 5.0V 1.5A
Temperature During Use	0°C to +40°C (+32°F to +104°F)
Dimensions (MAX.)	40 mm × 21 mm × 79 mm (1.6 in. × 0.8 in. × 3.1 in.) (W × H × D)
Mass (Weight)	Approx. 110 g (3.9 oz.) (excluding power cord)

Notes on the xD-Picture Card™ and the Internal Memory

■ Image Memory Card

- This Image Memory Card is a new image recording media (**xD-Picture Card**) developed for digital cameras. The Image Memory Card consists of a semiconductor memory (NAND-type flash memory) to record digital image data. The recording process is electrically performed and enables erasure of existing image data as well as re-recording of new image data.
- When using a new Memory Card, or a Memory Card that has been formatted by a PC, be sure to format the card with your digital camera before using it.

■ Internal Memory

- Images held in the camera's internal memory may be corrupted or erased due to problems such as camera faults. Save your important data to another media (i.e., CD-R, CD-RW, DVD-R, hard disk, etc.).
- Data stored in the camera's internal memory cannot be guaranteed in the event that the camera is submitted for repairs.
- When the camera is repaired, any data stored in the camera's internal memory is subject to checking by the repairer.

■ Protecting Your Data

- Images and movies may be lost or destroyed in the following situations. Please note that FUJIFILM assumes no responsibility for data that is lost or destroyed.
 1. Removal of the memory card or turning the power off while the memory card or internal memory is being accessed (i.e., during record, erase, initialization, and playback operations).
 2. Improper handling and use of the memory card or internal memory by the user or third party.



MEMO

Save your important data to another media (i.e., CD-R, CD-RW, DVD-R, hard disk, etc.).

■ Handling xD-Picture Card

- When storing **xD-Picture Cards**, make sure that they are kept out of the reach of children. An **xD-Picture Card** could be swallowed cause suffocation. If a child swallows an **xD-Picture Card**, seek medical attention or call emergency number right away.
- When inserting the **xD-Picture Card** into the camera, hold the **xD-Picture Card** straight as you push it in.
- Do not expose an **xD-Picture Card** to shock. Do not apply pressure, and avoid bending.
- Do not use or store **xD-Picture Card** in hot and humid places.
- Clean the **xD-Picture Card** with a soft dry piece of cloth when dirty.
- When carrying or storing an **xD-Picture Card**, keep it in the special protective case.
- The **xD-Picture Card** will work well for long time, but will sooner or later lose its ability to store and play back images or movies. If this happens replace it with a new **xD-Picture Card**.
- Never remove the **xD-Picture Card** or turn the camera off during data recording or erasing (**xD-Picture Card** formatting) as this could be damaged to the **xD-Picture Card**.
- The use of **xD-Picture Cards** is recommended with FinePix Z5fd.
The recording quality cannot be guaranteed when **xD-Picture Cards** other than those manufactured by FUJIFILM are used.

Continued ➔

- The **xD-Picture Card** may feel warm when it is removed from the camera after taking pictures. This is normal.
- Do not put labels on the **xD-Picture Card**. Peeling labels can cause the camera not to work properly.

MEMO

- There are two types of **xD-Picture Card**: standard type and Type M (containing “M” in the model number, such as DPC-M1GB).
FinePix Z5fd is compatible with Type M, however they may not be compatible depending on the device used (Image Memory Card Reader, etc.).
- The compatibility of Type H is the same as Type M. However, owners of the xD-Picture Card USB Drive DPC-UD1 can use Type M but not Type H.

■ Using **xD-Picture Card** or Internal Memory with a PC





- When taking pictures using an **xD-Picture Card** or internal memory that has been used on a PC, reformat the **xD-Picture Card** or internal memory using your camera for best quality.
- When formatting an **xD-Picture Card** or internal memory, a directory (folder) is created. Image data is then recorded in this directory.
- Do not change or delete the directory (folder) or file names on the **xD-Picture Card** or internal memory because this will make it impossible to use the **xD-Picture Card** or internal memory in your camera.
- Always use the camera to erase image data on an **xD-Picture Card** or internal memory.
- To edit image data, copy or transfer the image data to the PC and edit the copied or transferred data.

■ Specifications





Type	Image memory card for digital cameras (xD-Picture Card)
Memory type	NAND-type flash memory
Conditions for use	Temperature: 0°C to +40°C (+32°F to +104°F) Humidity: 80% max. (no condensation)
Dimensions	25 mm × 20 mm × 2.2 mm (0.98 in. × 0.79 in. × 0.09 in.) (W × H × D)









Warning Displays

The table below lists the warnings that are displayed on the LCD monitor.

Warning Displayed	Explanation	Remedy
 (Lit red)  (Blinking red)	The battery is low or completely out of charge.	Charge the battery or load fully charged battery.
	There is a strong likelihood of camera shake because the shutter speed is slow.	Use flash photography. We recommend using a tripod.
	The AF (autofocus) cannot work effectively.	<ul style="list-style-type: none"> • If the image is too dark, take the picture at a distance of around 2 m (6.6 ft.) from the subject. • Use AF lock to take the picture (→p.30). • Select Macro mode when taking close-up shots.
	The camera cannot shoot the picture at the correct brightness due to too bright or dark shooting condition.	The picture can be taken, but the correct brightness (exposure) will not be obtained.
FOCUS ERROR ZOOM ERROR	Camera malfunction or fault.	<ul style="list-style-type: none"> • Turn the camera on again, taking care not to touch the lens. • Turn the camera off and on again. If the message still appears, contact your FUJIFILM dealer.
NO CARD	xD-Picture Card is not inserted when transferring images.	Insert an xD-Picture Card .
CARD NOT INITIALIZED	<ul style="list-style-type: none"> • The xD-Picture Card or internal memory is not formatted. • The xD-Picture Card contact area is soiled. • Camera fault. 	<ul style="list-style-type: none"> • Format the xD-Picture Card or internal memory on the camera (→p.101). • Wipe the contact area on the xD-Picture Card with a soft, dry cloth. It may be necessary to format the xD-Picture Card (→p.101). If the message still appears, replace the xD-Picture Card. • Contact your FUJIFILM dealer.
CARD ERROR	<ul style="list-style-type: none"> • The xD-Picture Card contact area is soiled. • The xD-Picture Card format is incorrect. • Camera fault. • The xD-Picture Card is damaged. 	<ul style="list-style-type: none"> • Wipe the contact area on the xD-Picture Card with a soft, dry cloth. It may be necessary to format the xD-Picture Card (→p.101). If the message still appears, replace the xD-Picture Card. • Contact your FUJIFILM dealer.

Continued ➔

Warning Displayed	Explanation	Remedy
 MEMORY FULL  MEMORY FULL	The internal memory or xD-Picture Card is full.	Erase some images in internal memory or xD-Picture Card (→p.37), or use an xD-Picture Card that has ample free space.
WRITE ERROR	<ul style="list-style-type: none"> The data could not be recorded due to an xD-Picture Card error or a connection error between the xD-Picture Card and camera. The image cannot be recorded as it is too large to fit in the available space on the xD-Picture Card. The xD-Picture Card or internal memory is not formatted. 	<ul style="list-style-type: none"> Re-insert the xD-Picture Card or turn the camera off and then on again. If the message still appears, contact your FUJIFILM dealer. Use a new xD-Picture Card. Format the xD-Picture Card or internal memory on the camera (→p.101).
BUSY	The timing for recording was incorrect because the xD-Picture Card was formatted on a PC.	Use an xD-Picture Card that was formatted on the camera.
FRAME NO. FULL	The frame number has reached 999-9999.	<ol style="list-style-type: none"> Insert a formatted xD-Picture Card into the camera. Set RENEW as the FRAME NO. setting in the  SET-UP menu (→p.98). Start taking pictures (The frame number starts from "100-0001"). Set CONT. as the FRAME NO. setting in the  SET-UP menu.
READ ERROR	<ul style="list-style-type: none"> The played back file was not recorded correctly. The xD-Picture Card contact area is soiled. Camera fault. An attempt was made to play back the image or the movie that was not recorded on this camera. 	<ul style="list-style-type: none"> This file cannot be played back. Wipe the contact area on the xD-Picture Card with a soft, dry cloth. It may be necessary to format the xD-Picture Card (→p.101). If the message still appears, replace the xD-Picture Card. Contact your FUJIFILM dealer. The movie and image cannot be played back.
TOO MANY FRAMES	An attempt was made to show 5,000 or more image by date sorting.	No more than 4,999 images can be shown by date sorting.

Warning Displayed	Explanation	Remedy
PROTECTED FRAME	<ul style="list-style-type: none"> An attempt was made to erase a protected file. An attempt was made to add a voice memo to protected file. An attempt was made to rotate a protected file. 	<ul style="list-style-type: none"> Protected files cannot be erased. Remove the protection (→p.79). Protected files cannot be added to voice memos. Remove the protection (→p.79). Protected files cannot be rotated. Remove the protection (→p.79).
 ERROR	<ul style="list-style-type: none"> The voice memo file is faulty. Camera fault. 	<ul style="list-style-type: none"> The voice memo cannot be played back. Contact your FUJIFILM dealer.
 NO IMAGE  NO IMAGE	An attempt was made to transfer images from the xD-Picture card or internal memory that memory was empty.	It is impossible to copy.
 CAN NOT TRIM	An attempt was made to trim a 0.3M image.	The image cannot be trimmed.
CAN NOT TRIM	<ul style="list-style-type: none"> An attempt was made to trim an image shot using a camera other than FinePix Z5fd. The image is damaged. 	The image cannot be trimmed.
DPOF FILE ERROR	Prints were specified for 1000 or more frames in the DPOF frame settings.	The maximum number of frames for which prints can be specified on the same xD-Picture Card is 999. Copy the images for which you want to order prints onto another xD-Picture Card and then specify the DPOF settings.
CAN NOT SET DPOF  CAN NOT SET DPOF	An attempt was made to specify DPOF settings for an image that is not supported by DPOF.	DPOF printing cannot be used with this image format.
CAN NOT ROTATE  CAN NOT ROTATE	An attempt was made to rotate a movie or an image shot using a camera other than FinePix Z5fd.	These images cannot be rotated by image formats.
 CAN NOT EXECUTE  CAN NOT EXECUTE  CAN NOT EXECUTE	An attempt was made to transmit or save an image or movie recorded with another device, or an image that cannot be played back, with TRIMMING FOR BLOG.	Some image formats cannot be transmitted or saved with TRIMMING FOR BLOG.

Continued ➔

Warning Displays

Warning Displayed	Explanation	Remedy
 CAN NOT EXECUTE	An attempt was made to resave an image that was saved with TRIMMING FOR BLOG.	Images saved with TRIMMING FOR BLOG cannot be resaved.
COMMUNICATION ERROR	The camera is not connected to a PC or printer.	<ul style="list-style-type: none"> • Check that the USB cable is connected correctly. • Check that your PC or printer is turned on. • When using IR communication, make sure the camera and the other device are transmitting and receiving within the image transmission range.
PRINTER ERROR	Displayed for PictBridge.	<ul style="list-style-type: none"> • Check that the printer is not out of paper or out of ink. • Turn the printer off briefly and then turn it back on. • Refer to the user manual supplied with your printer.
PRINTER ERROR RESUME?	Displayed for PictBridge.	Check that the printer is not out of paper or out of ink. Printing automatically restarts when the error is cleared. If the message still appears after checking, press MENU/OK to restart printing.
CANNOT BE PRINTED	Displayed for PictBridge.	<ul style="list-style-type: none"> • Refer to the user manual for the printer being used and check whether the printer supports the JFIF-JPEG or Exif-JPEG image format. If not, the printer cannot print the images. • Movie images cannot be printed. • Was the image data photographed using FinePix Z5fd? You may not be able to print some images photographed on other cameras.

Troubleshooting

■ Getting ready

Matters	Problems	Possible causes	Solutions	Page
Battery and power supply	Nothing happens when opening the lens cover completely.	The battery has run out.	Charge the battery or load fully charged battery.	14, 16, 126
		The battery is loaded backward.	Load the battery in the corrected direction.	15
		The battery cover is not closed securely.	Close the battery cover securely.	15
	Battery runs out quickly.	Camera is used in extremely cold conditions.	Put the battery in your pocket or another warm place to heat it and then load it into the camera just before you take a picture.	14, 17, 126
		The terminals are soiled.	Wipe the battery terminals with a clean, dry cloth.	127
		Same battery has been used for a long period.	The battery can no longer be recharged. Load a new battery.	14, 17, 126
	Power cuts out during operation.	The battery has run out.	Charge the battery or load fully charged battery.	14, 16, 126
		The AC power adapter plug has come out of the power outlet.	Plug the AC power adapter back in.	16, 128













Continued ➔

Matters	Problems	Possible causes	Solutions	Page
Charging a battery	Charging does not begin.	There is no battery in the camera.	Load the battery.	15
		The battery is loaded backward.	Load the battery in the correct direction.	15
		The camera, and AC power adapter are not connected correctly.	Connect the camera, and AC power adapter correctly.	16
	The indicator lamp blinks during charging and the battery won't charge.	The battery terminals are soiled.	Take the battery out briefly and wipe the battery terminals with a clean, dry cloth before reloading it.	127
		The battery can no longer be recharged.	Load a new battery. If the battery still fails to charge, contact your FUJIFILM dealer.	126





















■ Setting menu etc.

Matters	Problems	Possible causes	Solutions	Page
LCD monitor display	Screens are not displayed in English.	A language other than English is selected in the 言語/LANG. setting in the SET-UP menu.	Select ENGLISH.	24

■ Shooting

Matters	Problems	Possible causes	Solutions	Page
Basic operations	No photograph is taken when pressing the shutter button.	The xD-Picture Card or internal memory is full.	Insert a new xD-Picture Card or erase some unnecessary frames.	18, 37
		The xD-Picture Card or internal memory is not formatted.	Format the xD-Picture Card or internal memory on the camera.	94, 101
		The xD-Picture Card contact area is soiled.	Wipe the xD-Picture Card contact area with a soft, dry cloth.	18, 129
		The xD-Picture Card is damaged.	Insert a new xD-Picture Card .	18
		The battery has run out.	Charge the battery or load fully charged battery.	14, 16, 126
	The Auto power off function has turned the camera off.	Turn the camera on.	20, 102	
	The LCD monitor darkens after taking a picture.	You took pictures with flash.	The LCD monitor may darken for charging flash. Wait a short time.	50
Focusing	Camera has difficulty in focusing on the subject.	You took a close-up shot without selecting Macro mode.	Select Macro mode.	48
		You photographed scenery with Macro mode selected.	Cancel Macro mode.	48
		You are shooting a subject that is not suited to autofocusing (→p.31).	Use AF/AE lock to take the picture.	30
Intelligent Face Detection	Cannot set Intelligent Face Detection.	The Shooting mode is set to  ,  ,  ,  ,  , or  .	Change the Shooting mode.	42
Macro (Close-up) shooting	Cannot set Macro (Close-up).	The Shooting mode is set to  ,  ,  ,  ,  ,  , or  .	Change the Shooting mode.	42

Continued ➔

Matters	Problems	Possible causes	Solutions	Page
Flash	Cannot use the flash.	The shutter button was pressed while the flash was charging.	Wait until the charging is completed before pressing the shutter button.	50
		The  SHOOTING MODE is set to  ,  ,  , OFF, or  .	Change the Shooting mode.	42
		The battery has run out.	Charge the battery or load fully charged battery.	14, 16, 126
		Continuous shooting is selected.	Set continuous shooting to OFF.	62
		The flash mode is set to  .	Set the flash mode to something other than  .	49
	The flash settings are restricted and cannot be selected.	The  SHOOTING MODE is set to AUTO,  ,  ,  ,  ,  ,  ,  ,  ,  , or  .	The flash settings are restricted because the camera settings are tailored to the scene being shot. Change the Shooting mode for a wider range of flash settings.	42
	The playback image is dark even though the flash was used.	The subject is too far away.	Move to within the effective flash range before taking the picture.	48, 50
Your finger was covering the flash.		Hold the camera correctly.	25	
Photographed images	The image is blurred.	The lens is dirty.	Clean the lens.	125
		 AF appeared when taking pictures.	Check the focus on the subject and take pictures.	26, 28, 131
		 appeared when taking pictures.	It may cause camera shake. Hold the camera steadily.	27, 131
	There is speckling on the image.	The picture was taken with a slow shutter speed (long exposure) in a high-temperature environment.	This is a characteristic of CCDs and does not indicate a camera fault.	-

■ Shooting

Matters	Problems	Possible causes	Solutions	Page
Recording images	Photographed images or movies are not recorded.	AC power adapter was connected or disconnected during turning the camera on.	Connect or disconnect the AC power adapter only when the camera is off. Failing to turn the camera off first can result in damage to the xD-Picture Card or malfunctions during PC connection.	128
Continuous shooting	Only 1 frame can be shot even though continuous shooting mode was set.	A picture is taken using self-timer when setting FINAL 3 or LONG PERIOD continuous shooting mode.	Only 1 frame can be shot when using FINAL 3 or LONG PERIOD continuous shooting mode and Self-timer mode together.	62

Continued ➔

■ **Playing back**

Matters	Problems	Possible causes	Solutions	Page
Playing back movie / voice memo	The camera does not emit any sound.	The camera volume is set too low.	Adjust the volume.	85, 92, 94, 100
		The microphone was blocked during shooting/recording.	Take care not to block the microphone during shooting/recording.	83, 89
		There is something covering the speaker during playback.	Make sure that the speaker is uncovered.	84, 92
Erasing	Erasing FRAME does not erase the frame.	Some frames may be protected.	Unprotect frames using the camera on which the protection was first applied.	79
	Erasing ALL FRAMES does not erase all the frames.			
Frame No.	CONT. in the frame number setting does not function.	You opened the battery cover without turning the camera off when replacing the battery or xD-Picture Card .	Always turn the camera off when replacing the battery or xD-Picture Card . Opening the battery cover without turning the camera off may cause the frame number memory to not function.	20

■ Connecting

Matters	Problems	Possible causes	Solutions	Page
Connecting to TV	There is no image or sound on the TV.	The camera is not connected to the TV correctly.	Connect the camera and TV correctly.	104
		The included A/V cable was connected during movie playback.	After the movie playback mode is stopped, connect the camera and TV correctly.	91, 104
		"TV" is selected as the TV input.	Set the TV input to "VIDEO".	–
		The video output setting is incorrect.	Change the setting to NTSC or PAL.	94, 96
	The TV volume is turned down.	Adjust the volume.	–	
	The TV image is black and white.	The video output setting is incorrect.	Change the setting to NTSC or PAL.	94, 96
Connecting to PC	PC does not recognize the camera.	The USB cable is not correctly connected to the PC or camera.	Set up the camera, and connect the USB cable correctly.	116
Connecting to printer	Cannot print with PictBridge.	<ul style="list-style-type: none"> The USB cable is not correctly connected to the printer or camera. The printer is not turned on. 	<ul style="list-style-type: none"> Set up the camera, and connect the USB cable correctly. Turn the printer on. 	105

Continued ➔

















■ Others

Matters	Problems	Possible causes	Solutions	Page
Camera operation etc.	Nothing happens when pressing the buttons on the camera.	Camera malfunction may be caused temporarily.	Briefly remove the battery or disconnect the AC power adapter. Then reload the battery or reconnect the AC power adapter, try again.	14, 15, 16, 128
		The battery has run out.	Charge the battery or load fully charged battery.	14, 16, 126
	The camera no longer works correctly.	Camera malfunction may be caused temporarily.	Briefly remove the battery or disconnect the AC power adapter. Then reload the battery or reconnect the AC power adapter, try again. If you think the camera is faulty, contact your FUJIFILM dealer.	14, 15, 16, 128

Specifications

System	
Model	Digital camera FinePix Z5fd
Effective pixels	6.3 million pixels
CCD	1/2.5-inch Super CCD HR
Storage media	Internal memory (approx. 26 MB)/ xD-Picture Card (16/32/64/128/256/512 MB/1 GB/2 GB)
File format	Still image: DCF-compliant Compressed: Exif ver.2.2 JPEG, DPOF-compatible *Design rule for Camera File System compliant DPOF compatible Movie: AVI format, Motion JPEG Audio: WAVE format, Monaural sound
Number of recorded pixels	Still image: 2848 × 2136 pixels/3024 × 2016 pixels/2048 × 1536 pixels/ 1600 × 1200 pixels/640 × 480 pixels (6M/3.2M/3M/2M/0.8M)
File size	See the table on the p.147
Lens	Fujinon 3x optical zoom lens F3.5-F4.2
Focal length	f=6.1 mm-18.3 mm (Equivalent to approx. 36 mm-108 mm on a 35 mm camera) (3.2: Equivalent to approx. 38 mm-114 mm on a 35 mm camera)
Digital zoom	Approx. 6.2× (3× optical zoom lens is used together: Max. zoom scale: approx. 18.5×)
Aperture (Wide-angle)	F3.5/F5/F8 (up to 3 steps)
Focal range	Normal: approx. 60 cm (2.0 ft.) to infinity Macro: wide-angle: approx. 8 cm (3.1 in.) to 80 cm (2.6 ft.) telephoto: approx. 45 cm (1.5 ft.) to 80 cm (2.6 ft.)

Continued ➡

System	
Sensitivity	AUTO/Equivalent to ISO 100/200/400/800/1600
Photometry	TTL 256-zones metering
Exposure control	Program AE
Scene position	 (NATURAL LIGHT),  (NATURAL & FIREWORKS),  (PORTRAIT),  (LANDSCAPE),  (SPORT),  (NIGHT),  (FIREWORKS),  (SUNSET),  (SNOW),  (BEACH),  (MUSEUM),  (PARTY),  (FLOWER),  (TEXT)
Picture stabilization	Available
Intelligent Face Detection	Available
Exposure compensation	-2 EV to +2 EV in 1/3 EV-step increments ()
Shutter speed	4 sec. to 1/1000 sec. (depend on Exposure mode)
Continuous shooting	Top-3: Number of recorded frames: up to 3 frames (Max. 2.2 frames/sec.) Final-3: Number of recorded frames: Last 3 frames before releasing the shutter button (Max. 2.2 frames/sec.) Long-period: Number of recorded frames: Depend on memory size 1.5 sec. interval at  N depending on quality level (Max. 0.6 frames/sec.)
Focus	Mode: Single-AF AF system: TTL contrast-type AF frame selection: AF (CENTER), AF (MULTI)

System	
White balance	Automatic scene recognition/Preset (Fine, Shade, Fluorescent (Daylight), Fluorescent (Warm White), Fluorescent (Cool White), Incandescent)
Self-timer	Approx. 2 sec./10 sec.
Flash type	Auto flash Effective range: (☺: AUTO)Wide-angle: approx. 60 cm-3.5 m (2.0 ft.-11.5 ft.) Telephoto: approx. 60 cm-2.8 m (2.0 ft.-9.2 ft.) Macro: approx. 30 cm-80 cm (1.0 ft.-2.6 ft.)
Flash mode	Auto, Red-eye Reduction, Forced Flash, Suppressed Flash, Slow Synchro, Red-eye Reduction + Slow Synchro
LCD monitor	2.5 inches, Aspect ratio: 4:3; 230,000 pixels Amorphous silicon TFT, Approx. 100% coverage
Movie	640 × 480 pixels/320 × 240 pixels (640/820) (30 frames per second with monaural sound) A series of continuous image can be recorded depending on the available space on an xD-Picture Card or internal memory. Zoom cannot be used during movie recording.
Photography functions	Intelligent Face Detection, High-speed shooting, Best framing, Frame NO. memory
Playback functions	Intelligent Face Detection, Trimming for blog, Trimming, Slide show, Multi-frame playback, Sorting by date, Image rotate, Voice memo, IR communication
Other functions	PictBridge, Exif print, Language (日本語, English, Francais, Deutsch, Español, Italiano, 中文簡, 繁體, 한글, Русский, Português, Nederlands, Türkçe), Time difference, FinePix photo mode(F -mode)
Input/Output Terminal	
A/V OUT (Audio/Visual output)	NTSC/PAL-type (with monaural sound)
Digital input/output	USB 2.0 High-Speed, PTP (Picture Transfer Protocol)
DC input socket	AC Power Adapter

Continued ➔

Power Supply and Others**Power supply** Rechargeable Battery NP-40 (included)**Guide to the number of available frames for battery operation**

Battery Type	Number of frames
NP-40 (750 mAh)	Approx. 200 frames

According to the CIPA (Camera & Imaging Products Association) standard procedure for measuring digital still camera battery consumption (extract):

When using a battery, use the battery supplied with the camera. The storage media should be **xD-Picture Card**.

Pictures should be taken at a temperature of +23°C (+73°F), with the LCD monitor turned on, the optical zoom moved from full wide-angle to full telephoto (or vice-versa) and back again to its original position every 30 seconds, the flash used at full power every second shot and the camera turned off and then on again once every 10 shots.

- Note: Because the number of available shots varies depending on the level of charge in the battery, the figures shown here for the number of available shots using the battery is not guaranteed. The number of available shots will also decline at low temperatures.

Camera dimensions (W/H/D) 92.8 mm × 55.0 mm × 19.4 mm/3.5 in. × 2.2 in. × 0.8 in. (not including accessories and attachments)**Camera mass (weight)** Approx. 130 g/4.6 oz. (not including accessories, battery and **xD-Picture Card**)**Weight for photography** Approx. 148 g/5.2 oz. (including battery and **xD-Picture Card**)**Operating Conditions** Temperature: 0°C to +40°C (+32°F to +104°F)
80% humidity or less (no condensation)

■ Standard number of available frames/recording time per xD-Picture Card and internal memory

The number of available frames, recording time or file size varies slightly depending on the subjects photographed. Note also that the divergence between standard number of frames and the actual number of frames is greater for xD-Picture Cards with higher capacities.

Quality setting	6M F	6M N	3:2	3M	2M	3M	640 (30 fps)	320 (30 fps)
Number of recorded pixels	2848 × 2136		3024 × 2016	2048 × 1536	1600 × 1200	640 × 480	640 × 480	320 × 240
Image data size	3.0 MB	1.5 MB	1.5 MB	780 KB	630 KB	130 KB	–	–
Internal memory (approx. 26 MB)	8	17	17	33	41	205	22 sec.	44 sec.
16 MB	5	10	10	19	25	122	13 sec.	26 sec.
32 MB	10	20	20	40	50	247	27 sec.	54 sec.
64 MB	21	42	42	81	101	497	55 sec.	109 sec.
128 MB	42	84	84	162	204	997	111 sec.	219 sec.
256 MB	85	169	169	325	409	1997	223 sec.	7.3 min.
512 MB	170	339	339	651	818	3993	7.4 min.	14.6 min.
1 GB	341	680	680	1305	1639	7995	14.9 min.	29.3 min.
2 GB	680	1360	1360	2558	3198	15992	29.8 min.	58.7 min.

Continued ➔

If you shoot using the **xD-Picture Cards** with model numbers containing "M" such as DPC-M2GB, movie recording time may be reduced if you repeatedly record and erase (frame erase) image files. In such a case, erase all frames or format the **xD-Picture Card** before use. Back up important frames (files) onto your PC or another media.

- * These specifications are subject to change without notice. FUJIFILM shall not be held liable for damages resulting from errors in this Owner's Manual.
- * The LCD monitor on your digital camera is manufactured using advanced high-precision technology. Even so, small bright points and anomalous colors (particularly around text) may appear on the monitor. These are normal display characteristics and do not indicate a fault with the monitor. This phenomenon will not appear on the recorded image.
- * The operation error may be caused in a digital camera by the strong radio interference (i. e. electric fields, static electricity, line noise, etc.).
- * Due to the nature of the lens, the edges of images may appear distorted. This is normal.

Explanation of Terms

EV

A number denotes Exposure Value. The EV is determined by the brightness of the subject and sensitivity (speed) of the film or CCD. The number is larger for bright subjects and smaller for dark subjects. As the brightness of the subject changes, a digital camera maintains the amount of light hitting the CCD at a constant level by adjusting the aperture and shutter speed. When the amount of light striking the CCD doubles, the EV increases by 1. Likewise, when the light is halved, the EV decreases by 1.

Frame rate (fps)

The frame rate refers to the number of images (frames) that are photographed or played back per second. For example, when 10 frames are continuously photographed in a 1-second interval, the frame rate is expressed as 10 fps.

For reference, TV images are displayed at 30 fps (NTSC).

JPEG

Joint Photographic Experts Group

A file format used for compressing and saving color images. The higher the compression rate, the greater the loss of quality in the decompressed (restored) image.

Motion JPEG

A type of AVI (Audio Video Interleave) file format that handles images and sound as a single file. Images in the file are recorded in JPEG format. Motion JPEG can be played back by QuickTime 3.0 or later.

Smear

A phenomenon specific to CCDs whereby white streaks appear on the image when there is a very strong light source, such as the sun or reflected sunlight, in the photography screen.

WAVE

A standard format used on Windows systems for saving audio data. WAVE files have the ".WAV" file extension and the data can be saved in either compressed or uncompressed format. Uncompressed recording is used on this camera.

WAVE files can be played back on a personal computer using the following software:

Windows: MediaPlayer

Macintosh: QuickTime Player (QuickTime 3.0 or later)

White Balance

Whatever the kind of the light, the human eye adapts to it so that a white object still looks white. On the other hand, devices such as digital cameras see a white subject as white by first adjusting the color balance to suit the color of the ambient light around the subject. This adjustment is called matching the white balance.



Exif Print Format is a newly revised digital camera file format that contains a variety of shooting information for optimal printing.

FUJIFILM Digital Camera Worldwide Network

If you have technical questions or if you need repair service, ask the following local distributor.
Please present the warranty card and your purchase receipt when you ask for repairs. Refer to the warranty card for conditions of the warranty.
There is a case that repair and Technical support cannot be accepted for some models which your local distributor does not deal with.
These lists are subject to change without notice.

NORTH AMERICA		
Canada	FUJIFILM Canada Inc.	600 Suffolk Court Mississauga Ontario, L5R 4G4
	Technical support	TEL 1-866-818-FUJI (3854) http://www.fujihelp.ca
	Repair service	600 Suffolk Court Mississauga Ontario, L5R 4G4 TEL 1-800-263-5018 FAX 1-905-755-2993 http://www.fujihelp.ca
U.S.A.	FUJIFILM U.S.A., Inc.	1100 King George Post Rd., Edison, NJ 08837
	Technical support	TEL 800-800-3854 FAX 732-857-3487 digitalinfo@fujifilm.com
	Repair service	1100 King George Post Rd., Edison, NJ 08837 TEL 732-857-3000 FAX 732-857-3471 njcamerarepair@fujifilm.com
Hawaii	FUJIFILM Hawaii, Inc.	94-468 Akoki Street, Waipahu, HI. 96797
	Technical support & Repair service	TEL 1-808-677-3854, ext. 209 FAX 1-808-677-1443 kurt_kmett@fujifilmhawaii.com
CENTRAL & SOUTH AMERICA		
Argentina	Imagen e informacion S.A.	Fondo de la Legua 936 San Isidro Pcia. de Buenos Aires
	Technical support & Repair service	TEL +54-11-4836-1000 FAX +54-11-4836-1144 servtec@imageneinformacion.com.ar
Bolivia	Reifschneider Bolivia Ltda.	Calle H N.º 5 - Equipetrol Norte - Santa Cruz
	Technical support & Repair service	TEL +591 33 44 1129 FAX +591 33 45 2919 gciagral@bibosi.scz.entelnet.bo
Brazil	FUJIFILM do Brasil Ltda.	Av. Vereador José Diniz, 3400 - Campo Belo, São Paulo/SP
	Technical support & Repair service	TEL 0800-12-8600 FAX +55 11 5091-4150 camarasdigitais@fujifilm.com.br
Chile	Reifschneider SA	Av. El Conquistador del Monte 5024, Huechuraba, Santiago, Chile
	Technical support & Repair service	TEL 02-4431500 FAX 02-4431596 ceciliacalvo@reifschneider.cl
Colombia	Animex de Colombia Ltda.	Calle 44 N.º 13-43 Piso 2 Apartado 18001 - Bogotá
	Technical support & Repair service	TEL +57 1 338-0299 FAX +57 1 288-2208 animex@etb.net.co
Ecuador	Espacri Cia Ltda	Bolivar 5-69 y Hermano Miguel
	Technical support & Repair service	TEL 593-72-835526 FAX 593-72-833157

Ecuador	Importaciones Espacri Cia. Ltda. Technical support & Repair service	Simón Bolívar 5-69 y Hno. Miguel - Cuenca TEL +593 783 5526 FAX +593 783 3157 portiz@fujifilm.com.ec
Mexico	Fujifilm de Mexico, S.A. de C.V. Technical support Repair service	Av. Ejercito Nacional 351, Col. Granada 11520 Mexico, D.F. TEL (52-55) 5263-5566 / 68 FAX (52-55) 5254-1508 jlgiraud1@fujifilm.com.mx Av. Presidente Juarez 2007, Col. Tepetlalcálco, 54090 Tlalne-pantla, Edo. de Mexico TEL (52-55) 5263-5500 FAX (52-55) 5254-1508 jlgiraud1@fujifilm.com.mx
Paraguay	Errece S.R.L. Technical support & Repair service	Edificio Unitas 15 de Agosto 1035, Asunción TEL +595 21 444256 FAX +595 21 444651 jmarbulo@fujifilm.com.py
Peru	Procesos de Color S.A. Technical support & Repair service	Pablo Bermudez 111 Apartado 3794 - Esq. Arequipa - Lima 11 TEL +51 14 33 5563 FAX +51 14 33 7177 jalvarado@fujifilm.com.pe
Uruguay	Fotocamara S.R.L. Technical support & Repair service	Cuareim 1439, montevideo, Uruguay TEL +598-2-9002004 FAX +598-2-9008430 fotocam@adinet.com.uy
Uruguay	Kiel S.A. Technical support & Repair service	Maldonado 1787 Montevideo- Uruguay TEL (05982) 419 4542 FAX (05982) 412 0046 kiel@fujifilm.com.uy
Venezuela	C. Hellmund & Cia Sa Technical support & Repair service	Av. Ppal Diego Cisneros Caracas Venezuela Edf Oficentro TEL 0212-2022300 FAX 0212-2399796 hellmund@hellmund.com
EUROPE		
Austria	Fuji Film Oesterreich Technical support & Repair service	Traviatagasse/Pfarrgasse, 1230 Vienna, Austria TEL 0043 1 6162606/51 or 52 FAX 0043 1 6162606/58 kamera.service@fujifilm.at
Belgium	Belgian Fuji Agency Technical support & Repair service	20, Avenue Lavoisier, Wavre, 1300, Belgium TEL 3210242090 FAX 3210238562 info@fuji.be
Croatia	I&I d.o.o. Technical support Repair service	Hondlova 2, Zagreb, Croatia TEL 38512319060 FAX 2310240 dsaravanja@fujifilm.hr Hondlova 2, Zagreb, Croatia TEL 38512316228 FAX 2310240 info@fujifilm.hr
Cyprus	PMS IMAGING LTD Technical support & Repair service	11, Dighenis Akritis Avenue, P.O.BOX 22315, 1586 Nicosia TEL 35722746746 FAX 35722438209 mariosashiotis@fujifilm.com.cy

FUJIFILM Digital Camera Worldwide Network

Cyprus	Doros Neophytou CAMERA REPAIRS Technical support & Repair service	28B, Agiou Demetriou, Acropoli, Nicosia TEL 35722314719 FAX 35722515562 dorosn@logosnet.cy.net
Czech Republic	Fujifilm Cz., s.r.o. Technical support	U nakladoveho nadrazi 2/1949, 130 00 Praha 3 TEL 00420 234 703 411 FAX 00420 234 703 489 fricman@fujifilm.cz
Czech Republic	AWH servis Repair service	Milesovska 1, 130 00 Praha 3, Czech republic TEL 00420 222 721 525 FAX 00420 222 720 122 awh@awh.cz
Denmark	Fujifilm Denmark A/S Technical support & Repair service	Stubbeled 2, 2950 Vedbæk Denmark TEL 0045 45662244 FAX 0045 45662214 fujifilm@fujifilm.dk
Finland	Fuji Finland Oy Technical support & Repair service	Martinkyläntie 41, 01720 Vantaa, Finland TEL +358 9 825951 FAX +358 9 870 3818 fuji@fuji.fi
France	FUJIFILM France Technical support & Repair service	2, Avenue Franklin, 78186 Saint-Quentin en Yvelines, France FAX 33 1 01 30 58 58 65 direction.technique@fujifilm.fr
Germany	FUJIFILM Europe GmbH Technical support & Repair service	Heesenstr. 70, 40549 Düsseldorf International call TEL +49 211 50890 FAX +49 211 5089668 service@fujifilm.de National call* TEL 0180 5898980 FAX 0180 5898982 *12 Cent/Min aus dem deutschen Festnetz
Greece	FUJIFILM HELLAS S.A. Technical support & Repair service	1, Ihou & Ag. Anargiron str., 175 64 P.Phaliro, Athens, Greece TEL 0030 210 9404100 FAX 0030 210 9404397 fujifilm@fujifilm.gr
Hungary	Fujifilm Hungary Ltd. Technical support	Váci ut 19. Budapest, 1134, Hungary TEL 3612389410 FAX 3612389401 fujifilm@fujifilm.hu
Iceland	Icephoto (Ljosmyndavörur) Technical support & Repair service	Skipholt 31, 105 Reykjavik, Iceland TEL 354 568 0450 FAX 354 568 0455 framkollun@fujifilm.is
Italy	FujiFilm Italia S.p.A. Technical support Repair service	Via Dell'Unione Europea, 4 - 20097 San Donato Milanese (MI), Italy TEL 039-02895821 FAX 039-0289582912 info@fujifilm.it Fujifilm On Line - Call center TEL 039-026695272 info@fujifilm.it
Lithuania	Fujifilm Lithuania Technical support & Repair service	Gerosios Vilties str. 38, LT-03143 Vilnius, Lithuania TEL 370-5-2130121 FAX 3705-5-2134066 info@fujifilm.lt

Malta	Ciancio (1913) Co.Ltd. Technical support & Repair service	Fuji Tech Centre, Ciancio House, Cannon Road, Qormi, QRM05 TEL 0356-21-480500 FAX 0356-21-488328 info@fujifilm.com.mt
Netherlands	Fujifilm Nederland BV Technical support Repair service	Hoogstraat 39, 3011 PE, Rotterdam, The Netherlands TEL 010-2812345 FAX 010-2812334 fuji@fujifilm.nl Hoefenseweg 43, 4877 LA, Etten-Leur, The Netherlands TEL 010-2812345 FAX 076-7502641 reparatie@fujifilm.nl
Norway	Fujifilm Norge AS Technical support Repair service	Lilleakerveien 10, 0283 Oslo, Norway TEL 0047-22736000 FAX 0047-22736020 http://www.fujifilm.no/ mailto:post@fujifilm.no Liaveien 1, 5132 Nyborg, Norway TEL 0047-55393880 FAX 0047-55195201 http://www.camera.no/ mailto:service@camera.no
Poland	Fujifilm Polska Distribution Sp. z o.o. Technical support Repair service	Poland Al..Jerozolimskie 178; 02-486 Warszawa TEL +48-22-517-66-00 FAX +48-22-517-66-02 fujifilm@fujifilm.pl Poland, Muszkieterow 15, 02-273 Warszawa TEL +48-22-886-94-40 FAX +48-22-886-94-42 serwis@fujifilm.pl
Portugal	Fujifilm Portugal, Lda Technical support Repair service	Av. Fontes Pereira de Melo, 342, 4100-259 Porto, Portugal TEL (351) 226194200 FAX (351) 226194213 finepix@fujifilm.pt Av. Fontes Pereira de Melo, 342, 4100-259 Porto, Portugal TEL (351) 226194200 FAX (351) 225194662 cameras@fujifilm.pt
Romania	CTS-Cardinal Top Systems Ltd Technical support & Repair service	112, Calea Dorobanti street, 4 flat, 1sector, Bucharest, Romania TEL 4021-230-09-82 FAX 4021-230-09-82 cts_tirla@hotmail.com
Russia	ZAO "Fujifilm RU" Technical support Repair service	Bld. 1, 10, Rozanova str., Moscow, 123007, Russia TEL +7-095-956-9858 FAX +7-095-230-6217 info@fujifilm.ru 18, Shelepikhinskaya Naberezhnaya str., Moscow, 123290, Russia TEL +7-095-797-3434 FAX +7-095-797-3434
Slovakia	Fujifilm Slovakia Technical support Repair service	Pribylinska 2, 831 04 Bratislava, Slovakia TEL 00421 2 44 888 077 FAX 00421 2 44 889 300 fujifilm@fujifilm.sk FIS Tatracentrum, Hodzovo nam. 4 - Tatracentrum, 811 06 Bratislava, Slovakia TEL 00421 2 54 647 347 fis.tatracentrum@stonline.sk
Spain	Fujifilm España S.A. Technical support Repair service	Aragón 180, 08011 Barcelona (España) TEL 902012535 FAX 934515900 / 933230330 info@fujifilm.es Aragón 180, 08011 Barcelona (España) TEL 934511515 FAX 934515900 / 933230330 tallersat@fujifilm.es

FUJIFILM Digital Camera Worldwide Network

Sweden	Fujifilm Sverige AB	Sveavägen 167 104 35 Stockholm
	Technical support	TEL 46 8 506 141 70 FAX 46 8 506 142 09 kamera@fujifilm.se
	Repair service	Sveavägen 167 104 35 Stockholm
		TEL 46 8 506 513 54 FAX 46 8 506513 54 kameraverkstaden@fujifilm.se
Switzerland / Lichtenstein	Fujifilm (Switzerland) AG	Niederhaslistrasse 12, 8157 Dieltlikon, Switzerland
	Technical support & Repair service	TEL +41 44 855 5154 FAX +41 44 855 5329 RepairCenter@fujifilm.ch
Turkey	Fujifilm Turkiye Sinfo A.S.	Fujifilm Plaza, Dereboyu Cad. 39 34660 Halkali, Istanbul, Turkey
	Technical support	TEL +90 212 696 5090 FAX +90 212 696 5009 csarp@fujifilm.com.tr
	Repair service	Fujifilm Plaza, Dereboyu Cad. 39 34660 Halkali, Istanbul, Turkey
		TEL +90 212 696 5090 FAX +90 212 696 5010 servis@fujifilm.com.tr
U.K.	FUJIFILM UK Ltd.	St Martins Way St Martins Business Centre Bedford MK42 0LF
	Technical support	TEL +44 (0)123 424 5383 FAX +44 (0)123 424 5285 fujitec@fuji.co.uk
	Repair service	St Martins Way St Martins Business Centre Bedford MK42 0LF
		TEL +44 (0)123 421 8388 FAX +44 (0)123 424 5285 fujitec@fuji.co.uk
Ukraine	Image Ukraine CJSC	12, Kontraktova ploscha, Kyiv 04070, Ukraine
	Technical support & Repair service	TEL +380-44-4909075 FAX +380-44-4909076 d@fujifilm.ua
MIDDLE EAST		
Iran	Tehran Fuka Co.	229, "Fuji" Bldg., Mirdamad Blvd., Tehran 19189, Iran
	Technical support & Repair service	TEL (+98-21)2254810-19 FAX (+98-21)2221002 fuka@neda.net
Israel	Shimone Group Ltd.	Efal 33 keyriat Arie Petah Tikva 49130, Israel
	Technical support	TEL (+) 972 3 9250666 digital@fujifilm.co.il
	Repair service	Efal 33 keyriat Arie Petah Tikva 49130, Israel
		TEL (+) 972 3 9250666 FAX 972 3 9250699 khaim@shimone.com
Jordan	Grand Stores	Al- Abdali, Amman / Jordan
	Technical support & Repair service	TEL 009626-4646387 FAX 009626-4647542 gstores@go.com.jo
Qatar	Techno Blue	Blue Salon Bldg, 3rd Floor, Suhaim bin Hamad st, Al- Saad, Doha
	Technical support	TEL 00974 44 66 175 FAX 00974 44 79 053 prabu@techno-blue.com
Saudi Arabia	Emam Distribution Co. Ltd.	P.O. Box 1716, Jeddah 21441, Saudi Arabia
	Technical support	TEL 96626978756 FAX 96626917036 service@fujifilm.com.sa

Syria	Film Trading Company Technical support Repair service	Al-Shahbandar P.O. Box:31180 Damascus SYRIA TEL + 963 11 2218049 FAX + 963 11 44673456 f.t.c@Net.SY Al-cheikh Taha P.O. Box: 6171 Aleppo SYRIA TEL + 963 21 4641903 FAX + 963 21 4641907 filmtradin@Net.SY
U.A.E.	Grand Stores Technical support & Repair service	P. O. Box 2144, Saleh Bin Lahej Building, Al Garhoud, Deira, Dubai TEL + 971-4-2823700 FAX + 971-4-2828382 photography@grandstores.ae
Yemen	Al-Haidary Trading Technical support Repair service	P.O.Box-2942 Haddah St. HTC, Sana'a, Yemen TEL 00967-1-503980 FAX 00967-1-503983 P.O.Box-2942 Haddah St. HTC, Sana'a, Yemen TEL 00967-1-503977 FAX 00967-1-503983
AFRICA		
Egypt	Foto Express Egypt Technical support & Repair service	426 Pyramids St., Giza, Egypt TEL (202) 7762062 FAX (202) 7760169 fotoegypt@access.com.eg
Kenya	Fuji Kenya Ltd Repair service	P.O.Box 41669-00100, Fuji Plaza, Chiromo Road, Nairobi, Kenya. TEL (254-20)4446265-8 FAX (254-20)4448515 / 7 info@fujifilm.co.ke
OCEANIA		
Australia	FUJIFILM Australia Pty Ltd Technical support & Repair service	Locked Bag 5100, Brookvale, NSW, 2100 TEL 1800 226 355 FAX +61 (2) 9466 2854 digital@fujifilm.com.au
Fiji	Brijjal & Co. Ltd Technical support & Repair service	70-72 Cumming Street, Suva, Fiji TEL (679)3304133 FAX (679)3302777 kapadia@connect.com.fj
New Caledonia	Phocidis SARL Technical support & Repair service	58, rue Higginson - B.P.661 - 98845 TEL (00 687) 25-46-35 FAX (00 687) 28-66-70 phocidis@phocidis.nc
New Zealand	Fujifilm NZ Ltd Technical support & Repair service	Cnr William Pickering & Bush Road Albany, Auckland TEL +64-9-4140400 FAX +64-9-4140410 glenn.beaumont@fujifilm.co.nz
Papua New Guinea	Oceania PNG Limited Technical support	Section 15, Allotment 1, Reke St, Boroko NCD. PNG. Mail: PO Box 2167, Boroko NCD. PNG. TEL +675 3256411 FAX +675 3250311 oceania@daltron.com.pg

FUJIFILM Digital Camera Worldwide Network

ASIA		
Hong Kong	Fuji Photo Products Co., Ltd. Technical support & Repair service	8/F., TSUEN WAN IND. CENTRE, 220 TEXACO RD., TSUEN WAN, HONG KONG TEL (852)2406 3287 FAX (852)2408 3130 rsd@chinafphoto.com.hk
Indonesia	PT Modern Photo Tbk Technical support & Repair service	Jl.Matraman Raya 12, Jakarta Timur 13150 TEL +62 021 2801000 FAX +62 021 8581620+62 021 2801012 assd-kmr@modernphoto.co.id
Malaysia	FUJIFILM (Malaysia) Sdn. Bhd. Technical support Repair service	Letter Box 1, Level 10, 11 & 12, Menara Axis, No 2, Jalan 51A/223, 46100 Petaling Jaya, Selangor Darul Ehsan, Malaysia TEL 603-79584700 FAX 603-79584110 digital@fujifilm.com.my Letter Box 1, Level 10, 11 & 12, Menara Axis, No 2, Jalan 51A/223, 46100 Petaling Jaya, Selangor Darul Ehsan, Malaysia TEL 603-79584700 FAX 603-79584110 technical@fujifilm.com.my
Philippines	YKL Development & Trdg. Corp. Technical support Repair service	24 Sto. Domingo St., Quezon City 1100, Philippines TEL 632-7436601-06 FAX 632-7324661 digital@yklcolor.com 24 Sto. Domingo St., Quezon City 1100, Philippines TEL 632-7436601-06 FAX 632-7324661 tech_services@yklcolor.com
Singapore	FUJIFILM (Singapore) Pte Ltd Technical support & Repair service	10 New Industrial Road Fujifilm Building Singapore 536201 TEL 65-6380 5557 FAX 65-6281 3594 service@fujifilm.com.sg
South Korea	Korea Fujifilm Co., Ltd. Technical support	30-1, Mukjeung-dong, Jung-gu, Seoul, Korea TEL +82-2-3282-7363 FAX +82-2-2269-7435 photo@fujifilm.co.kr
South Korea	Yonsan AS Center (Fujidigital) Repair service	#301, 3F, Jeonjaland, 16-9, Hangangro3-ga, Yongsan-gu, Seoul, Korea TEL +82-2-701-1472 FAX +82-2-718-1331 1bow@hanmail.net
South Korea	Kangnam AS Center (Digitalgallery) Repair service	2F, Hyeongin Tower, 23-2, Bangyi-dong, Songpa-gu, Seoul, Korea TEL +82-2-2203-1472 FAX +82-2-418-5572 nurijili@hanmail.net
South Korea	Busan AS Center (Digital-Sewon) Repair service	241-4, Bujeon-dong, Busanjin-gu, Busan, Korea TEL +82-51-806-1472 FAX +82-51-817-0083 merahan@yahoo.co.kr
Taiwan	Hung Chong Corp. Technical support & Repair service	No. 38, Min-Chuan E. Rd. Sec. 6, Taipei (114), Taiwan, R.O.C. TEL 886-2-6602-8988 FAX 886-2-2791-8647 dah@mail.hungchong.com.tw
Thailand	FUJIFILM (Thailand) Ltd. Technical support Repair service	388 SP Building, 8th Floor, Phayathai, Bangkok 10400 TEL +662-2730029 ext. 755 FAX +662-2730239 supaleark@fujifilm.co.th 388 SP Building, 8th Floor, Phayathai, Bangkok 10400 TEL +662-2730029 ext.761,762 FAX +662-2730239 warin@fujifilm.co.th

Safety Notes

- Make sure that you use your FinePix Z5fd camera correctly. Read these Safety Notes and your Owner's Manual carefully before use.
- After reading these Safety Notes, store them in a safe place.

About the Icons

- The icons shown below are used in this document to indicate the severity of the injury or damage that can result if the information indicated by the icon is ignored and the product is used incorrectly as a result.



WARNING

This icon indicates that death or serious injury can result if the information is ignored.



CAUTION

This icon indicates that personal injury or material damage can result if the information is ignored.

The icons shown below are used to indicate the nature of the information which is to be observed.



Triangular icons tell you that this information requires attention ("important").



Circular icons with a diagonal bar tell you that the action indicated is prohibited ("Prohibited").



Filled circles with an exclamation mark tell you an action that must be performed ("Required").



WARNING

If a problem arises, turn the camera off, remove the battery, disconnect and unplug the AC power adapter.

Continued use of the camera when it is emitting smoke, is emitting any unusual odor, or is in any other abnormal state can cause a fire or electric shock.

- Contact your FUJIFILM dealer.



Unplug from power socket.

Do not allow water or foreign objects to enter the camera.

If water or foreign objects get inside the camera, turn the camera off, remove the battery and disconnect and unplug the AC power adapter.

Continued use of the camera can cause a fire or electric shock.

- Contact your FUJIFILM dealer.



Do not use the camera in the bathroom or shower.

This can cause a fire or electric shock.



Do not use in the bathroom or shower.

Never attempt to change or take apart the camera. (Never open the casing.)







Do not use the camera when it has been dropped or the casing is damaged.





This can cause a fire or electric shock.

- Contact your FUJIFILM dealer.



Do not disassemble.

 WARNING	
<p>Do not change, heat or unduly twist or pull the connection cord and do not place heavy objects on the connection cord.</p> <p>These actions could damage the cord and cause a fire or electric shock.</p> <ul style="list-style-type: none"> • If the cord is damaged, contact your FUJIFILM dealer. 	
<p>Do not place the camera on an unstable surface.</p> <p>This can cause the camera to fall or tip over and cause injury.</p>	
<p>Never attempt to take pictures while in motion.</p> <p>Do not use the camera while you are walking or driving a vehicle. This can result in you falling down or being involved in a traffic accident.</p>	
<p>Do not touch any metal parts of the camera during a thunderstorm.</p> <p>This can cause an electric shock due to induced current from the lightning discharge.</p>	
<p>Do not use the battery except as specified.</p> <p>Load the battery as aligned with the indicator.</p>	

 WARNING	
<p>Do not heat, change or take apart the battery.</p> <p>Do not drop or subject the battery to impacts.</p> <p>Do not store the battery with metallic products.</p> <p>Do not use chargers other than the specified model to charge the battery.</p> <p>Any of these actions can cause the battery to burst or leak and cause fire or injury as a result.</p>	
<p>Use only the battery or AC power adapters specified for use with this camera.</p> <p>Do not use voltages other than the power supply voltage shown.</p> <p>The use of other power sources can cause a fire.</p>	
<p>If the battery leaks and fluid gets in contact with your eyes, skin or clothing. Flush the affected area with clean water and seek medical attention or call an emergency number right away.</p>	
<p>Do not use the charger to charge battery other than those specified here.</p> <p>The charger is designed for NP-40 Rechargeable Battery. Using the charger to charge conventional battery or other types of rechargeable battery can cause the battery to leak fluid, overheat or burst.</p>	



WARNING

When carrying the NP-40, install it in a digital camera or keep it in the soft case provided.

When storing the NP-40, keep it in the soft case provided.

When discarding, cover the battery terminals with insulation tape.

Contact with other metallic objects or battery could cause the battery to ignite or burst.



Keep xD-Picture Cards out of the reach of small children.

Because xD-Picture Cards are small, they can be swallowed by children. Be sure to store xD-Picture Cards out of the reach of small children. If a child swallows an xD-Picture Card, seek medical attention or call an emergency number.



CAUTION

Do not use this camera in locations affected by oil fumes, steam, humidity or dust.

This can cause a fire or electric shock.



Do not leave this camera in places subject to extremely high temperatures.

Do not leave the camera in locations such as a sealed vehicle or in direct sunlight. This can cause a fire.



Keep out of the reach of small children.

This product could cause injury in the hands of a child.



Do not place heavy objects on the camera.

This can cause the heavy object to tip over or fall and cause injury.



Do not move the camera while the AC power adapter is still connected.

Do not pull on the connection cord to disconnect the AC power adapter.

This can damage the power cord or cables and cause a fire or electric shock.



Do not use the AC power adapter when the plug is damaged or the plug socket connection is loose.







This could cause a fire or electric shock.





Do not cover or wrap the camera or the AC power adapter in a cloth or blanket.

This can cause heat to build up and distort the casing or cause a fire.



 CAUTION	
<p>When you are cleaning the camera or you do not plan to use the camera for an extended period, remove the battery and disconnect and unplug the AC power adapter.</p> <p>Failure to do so can cause a fire or electric shock.</p>	
<p>When charging ends, unplug the charger from the power socket.</p> <p>Leaving the charger plugged into the power socket can cause a fire.</p>	
<p>Using a flash too close to a person's eyes may temporarily affect the eyesight.</p> <p>Take particular care when photographing infants and young children.</p>	
<p>When an xD-Picture Card is removed, the card could come out of the slot too quickly. Use your finger to hold it and gently release the card.</p>	
<p>Request regular internal testing and cleaning for your camera.</p> <p>Build-up of dust in your camera can cause a fire or electric shock.</p> <ul style="list-style-type: none"> • Contact your FUJIFILM dealer to request internal cleaning every 2 years. • Please note this is not a free of charge service. 	

 CAUTION	
<p>Do not sit down putting the camera into a trousers pocket etc.</p> <p>When putting the camera into a bag, keep it in the special protective case. Do not place heavy objects on the camera.</p> <p>Do not leave the camera on the place such as floor. When storing the camera, keep it in the special protective case. It prevents subjecting the camera to strong shocks.</p> <ul style="list-style-type: none"> • Any of these actions can cause an unexpected injury by broken reinforced glass. • Be careful of glass splinter if the LCD monitor is broken. When the camera suffers damage, put the camera into a plastic bag and take in it to your FUJIFILM dealer. 	
<p>During extended periods of use, minimize direct skin contact with the camera.</p> <p>If you use the camera for a long time, it may become warm and result in minor burns.</p>	

FUJIFILM

FUJIFILM Corporation

MIDTOWN WEST,7-3,AKASAKA 9-CHOME,MINATO-KU,TOKYO 107-0052,JAPAN

<http://www.fujifilm.com/products/digital/>

Printed in Japan

Download from [Www.Somanuals.com](http://www.Somanuals.com). All Manuals Search And Download.

X-608111-PY

Free Manuals Download Website

<http://myh66.com>

<http://usermanuals.us>

<http://www.somanuals.com>

<http://www.4manuals.cc>

<http://www.manual-lib.com>

<http://www.404manual.com>

<http://www.luxmanual.com>

<http://aubethermostatmanual.com>

Golf course search by state

<http://golfingnear.com>

Email search by domain

<http://emailbydomain.com>

Auto manuals search

<http://auto.somanuals.com>

TV manuals search

<http://tv.somanuals.com>