

# FUJITSU

OPERATING MANUAL



## ROOM AIR CONDITIONER WALL MOUNTED TYPE

Indoor Unit

**AWU18CXQ**  
**AWU18RXQ**  
**AWU24CXQ**  
**AWU24RXQ**

Outdoor Unit

**AOU18CXQ**  
**AOU18RXQ**  
**AOU24CXQ**  
**AOU24RXQ**

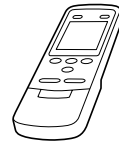
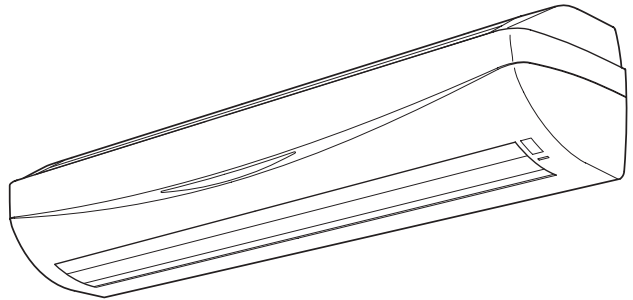

KEEP THIS MANUAL  
FOR FUTURE REFERENCE

FUJITSU GENERAL LIMITED



P/N9373459019

# CONTENTS

SAFETY PRECAUTIONS .....	1	ADJUSTING THE DIRECTION OF AIR CIRCULATION .....	11
FEATURES AND FUNCTIONS .....	2	SWING OPERATION .....	12
NAME OF PARTS .....	3	CLEANING AND CARE .....	13
PREPARATION .....	5	CLEANING THE ELECTRONIC AIR CLEAN UNIT .....	14
OPERATION .....	6	SELECTING THE REMOTE CONTROL UNIT	
AIR CLEANING OPERATION .....	8	SIGNAL CODE .....	16
TIMER OPERATION .....	9	TROUBLESHOOTING .....	17
MANUAL AUTO OPERATION .....	10	OPERATING TIPS .....	18

## SAFETY PRECAUTIONS

- Before using the appliance, read these "PRECAUTIONS" thoroughly and operate in the correct way.
- The instructions in this section all relate to safety; be sure to maintain safe operating conditions.
- "DANGER", "WARNING" and "CAUTION" have the following meanings in these instructions:

 <b>DANGER!</b>	This mark indicates procedures which, if improperly performed, are most likely to result in the death of or serious injury to the user or service personnel.
 <b>WARNING!</b>	This mark indicates procedures which, if improperly performed, might lead to the death or serious injury of the user.
 <b>CAUTION!</b>	This mark indicates procedures which, if improperly performed, might possibly result in personal harm to the user, or damage to property.

### **DANGER!**

- Do not attempt to install this air conditioner by yourself.
- This unit contains no user-serviceable parts. Always consult authorized service personnel for repairs.
- When moving, consult authorized service personnel for disconnection and installation of the unit.
- Do not become over-exposed to cold air by staying in the direct path of the air flow of the air conditioner for extended periods of time.
- Do not insert fingers or objects into the outlet port or intake grilles.
- Do not start and stop air conditioner operation by turning off the electrical breaker or disconnecting the power supply plug and so on.
- Take care not to damage the power supply cord.
- In the event of a malfunction (burning smell, etc.), immediately stop operation, turn off the electrical breaker or disconnect the power supply plug, and consult authorized service personnel.

### **CAUTION!**

- Provide occasional ventilation during use.
- Do not direct air flow at fireplaces or heating apparatus.
- Do not climb on, or place objects on, the air conditioner.
- Do not hang objects from the indoor unit.
- Do not set flower vases or water containers on top of air conditioners.
- Do not expose the air conditioner directly to water.
- Do not operate the air conditioner with wet hands.
- Do not pull power supply cord.
- Turn off power source when not using the unit for extended periods.
- Always turn off the electrical breaker or disconnect the power supply plug whenever cleaning the air conditioner or the air filter.
- Connection valves become hot during Heating; handle with care.
- Check the condition of the installation stand for damage.
- Do not place animals or plants in the direct path of the air flow.
- Do not drink the water drained from the air conditioner.
- Do not use in applications involving the storage of foods, plants or animals, precision equipment, or art works.
- Do not apply any heavy pressure to radiator fins.
- Operate only with air filters installed.
- Do not block or cover the intake grille and outlet port.
- Ensure that any electronic equipment is at least one metre away from either the indoor or outdoor units.
- Avoid installing the air conditioner near a fireplace or other heating apparatus.
- When installing the indoor and outdoor units, take precautions to prevent access by infants.
- Do not use inflammable gases near the air conditioner.
- When restarting the air conditioner after a long period of disuse, turn the power switch on at least 12 hours before starting the unit.
- When cleaning the heat exchanger, do not get any water, liquid detergent, etc., on the electronic air clean filter. The filter may be damaged.

# FEATURES AND FUNCTIONS

---

## AUTOMATIC OPERATION

### ● COOLING MODEL

Merely press the START/STOP button, and the unit will begin automatic operation in the Cooling or Dry mode as appropriate, in accordance with the thermostat setting and the actual temperature of the room.

### ● HEAT & COOL MODEL (REVERSE CYCLE)

Merely press the START/STOP button, and the unit will begin automatic operation in either the Heating, Cooling or Monitor modes as appropriate, in accordance with the thermostat setting and the actual temperature of the room.

## ELECTRONIC AIR CLEAN FILTER

Electrical power is used to charge the filter to remove contaminants from the air and to effectively collect dust and remove odors. It also helps to reduce the bacterial activity.

## SLEEP TIMER

### ● COOLING MODEL

When the SLEEP timer button is pressed during Cooling or Dry mode, the thermostat setting is gradually raised during the period of operation. When the set time is reached, the unit automatically turns off.

### ● HEAT & COOL MODEL (REVERSE CYCLE)

When the SLEEP timer button is pressed during Heating mode, the air conditioner's thermostat setting is gradually lowered during the period of operation; during Cooling or Dry mode, the thermostat setting is gradually raised during the period of operation. When the set time is reached, the unit automatically turns off.

## WIRELESS REMOTE CONTROL UNIT

The WIRELESS REMOTE CONTROL UNIT allows convenient control of air conditioner operation.

## OMNI-DIRECTIONAL AIR FLOW (SWING OPERATION)

Three-dimensional control over air direction swing is possible through dual use of both an UP/DOWN air direction swing and RIGHT/LEFT air direction swing. Since UP/DOWN air direction flaps operate automatically according to the operating mode of the unit, it is possible to set air direction based on the operating mode.

## REMOVABLE INTAKE FILTER

The indoor unit's INTAKE FILTER can be removed for easy cleaning and maintenance.

## MILDEW-RESISTANT FILTER

The INTAKE FILTER has been treated to resist mildew growth, thus allowing cleaner use and easier care.

# NAME OF PARTS

Instructions relating to heating (\*) are applicable only to "HEAT & COOL MODEL" (Reverse Cycle).

Fig. 1

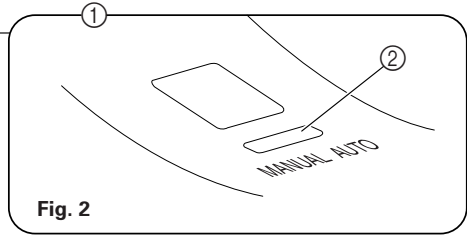
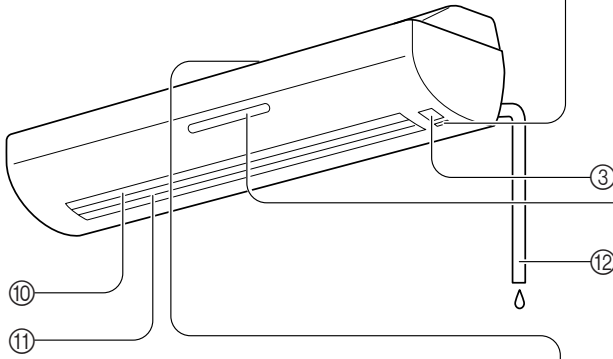

Fig. 2

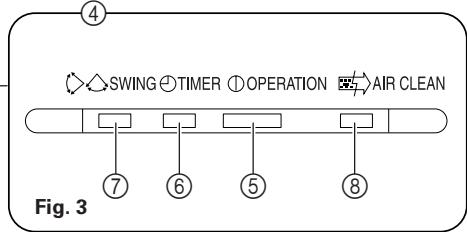

Fig. 3

Fig. 5

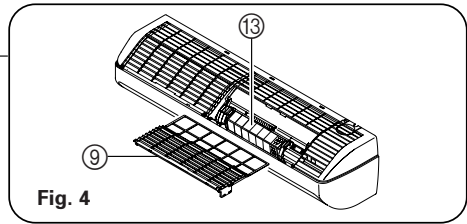
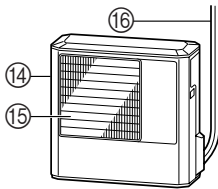

Fig. 4

Fig. 6

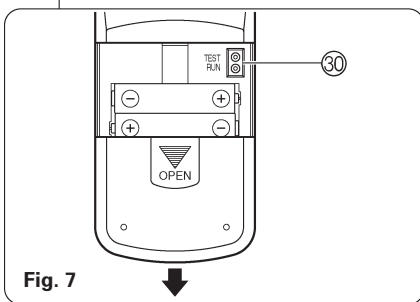
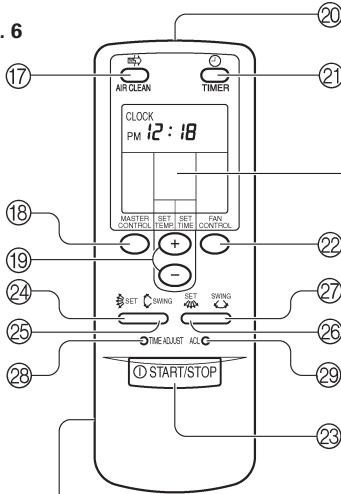

Fig. 7

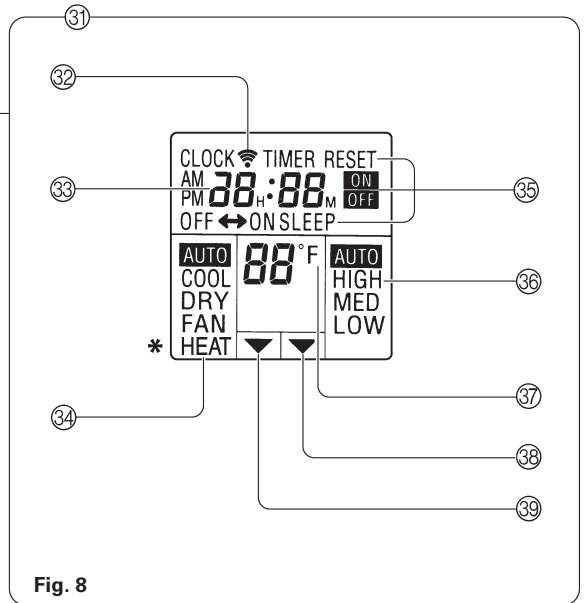

Fig. 8

**Fig. 1 Indoor Unit**

- ① Operating Control Panel (Fig. 2)
- ② MANUAL AUTO button
- ③ Remote Control Signal Receiver
- ④ Indicator Lamps (Fig. 3)
  - ⑤ OPERATION Indicator Lamp  
(green ..... COOL, DRY, FAN)  
(red ..... \*HEAT)
  - ⑥ TIMER Indicator Lamp (yellow)
  - ⑦ SWING Indicator Lamp (orange)  
(VERTICAL/HORIZONTAL SWING)
  - ⑧ AIR CLEAN Indicator Lamp (green)
    - If the TIMER indicator lamp flashes when the timer is operating, it indicates that a fault has occurred with the timer setting (See page 19 Auto Restart).
- ⑨ Intake Filter (Fig. 4)
- ⑩ UP/DOWN Air Direction Flaps
- ⑪ RIGHT/LEFT Air Direction Louvers  
(behind UP/DOWN Air Direction Flaps)
- ⑫ Drain Hose
- ⑬ Electronic Air Clean Unit (Fig. 4)

**Fig. 5 Outdoor Unit**

- ⑭ Intake Port
- ⑮ Outlet Port
- ⑯ Pipe Unit

**Fig. 6 Remote Control Unit**

- ⑰ AIR CLEAN button
- ⑱ MASTER CONTROL button
- ⑲ SET TEMP./SET TIME buttons (⊕/⊖)
- ⑳ Signal Transmitter
- ㉑ TIMER button
- ㉒ FAN CONTROL button
- ㉓ START/STOP button
- ㉔ AIR FLOW DIRECTION  
VERTICAL SET button
- ㉕ AIR FLOW DIRECTION  
VERTICAL SWING button
- ㉖ AIR FLOW DIRECTION  
HORIZONTAL SET button
- ㉗ AIR FLOW DIRECTION  
HORIZONTAL SWING button
- ㉘ TIME ADJUST button
- ㉙ ACL button

**Rear side (Fig. 7)**

- ⑳ TEST RUN
  - Touch the two metal contacts with a metallic object to send the signal to perform a test run.
  - Perform a test run only when installing the air conditioner. If the signal to perform a test run is received during normal operation, the air conditioner's thermostat will malfunction.
  - If the signal to perform a test run is received during normal operation, the unit will switch to the test operation mode and the indoor unit's OPERATION and TIMER indicator lamps will flash simultaneously.
  - To stop the test operation mode, press the START/STOP button to stop the air conditioner.

**⑳ Remote Control Unit Display (Fig. 8)**

- ㉑ Transmit Indicator
- ㉒ Clock Display
- ㉓ Operating Mode Display
- ㉔ Timer Mode Display
- ㉕ Fan Speed Display
- ㉖ Temperature Set Display
- ㉗ Timer Set Indicator
- ㉘ Temperature Set Indicator

# PREPARATION

## Load Batteries (R03/LR03 × 2)

- 1 Press and slide the battery compartment lid on the reverse side to open it.**

Slide in the direction of the arrow while pressing the  mark.

- 2 Insert batteries.**

Be sure to align the battery polarities (+/−) correctly.

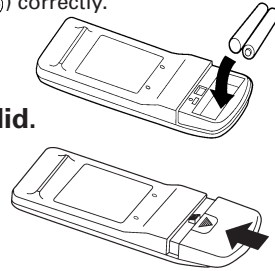

- 3 Close the battery compartment lid.**

## ⚠ CAUTION!

- Take care to prevent infants from accidentally swallowing batteries.
- When not using the remote control unit for an extended period, remove the batteries to avoid possible leakage and damage to the unit.
- If leaking battery fluid comes in contact with your skin, eyes, or mouth, immediately wash with copious amounts of water, and consult your physician.
- Dead batteries should be removed quickly and disposed of properly, either by placing in a public battery collection receptacle, or by returning to appropriate authority.
- Do not attempt to recharge dry batteries.

Never mix new and used batteries, or batteries of different types. Batteries should last about one year under normal use. If the remote control unit's operating range becomes appreciably reduced, replace the batteries and press the ACL button with the tip of a ballpoint pen or other small object.

## Set the Current time

- 1 Press the TIME ADJUST button (Fig. 6 ⑳).**

Use the tip of a ball-point pen or other small object to press the button.

- 2 Use the (+/−) SET TIME buttons (Fig. 6 ⑲) to adjust the clock to the current time.**

**+ button:** Press to advance the time.

**− button:** Press to reverse the time.

(Each time the buttons are pressed, the time will be advanced/reversed in one-minute increments; hold the buttons depressed to change the time quickly in ten-minute increments.)

- 3 Press the TIME ADJUST button again.**

This completes the time setting and starts the clock.

## To Use the Remote Control Unit

- The remote control unit must be pointed at signal receiver (Fig. 1 ③) to operate correctly.
- Operating range: About 7 meters.
- When a signal is properly received by the air conditioner, a beeping sound will be heard.
- If no beep is heard, press the remote control unit button again.

## Remote Control Unit Holder

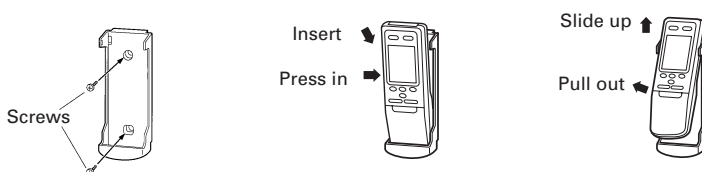

- ① Mount the Holder.**
- ② Set the Remote Control Unit.**
- ③ To remove the Remote Control Unit (when use at hand).**

# OPERATION

Instructions relating to heating (\*) are applicable only to "HEAT & COOL MODEL" (Reverse Cycle).

## To Select Mode Operation

- 1 Press the START/STOP button (Fig. 6 23).**  
The indoor unit's OPERATION indicator lamp (green or red) (Fig. 3 5) will light. The air conditioner will start operating.
- 2 Press the MASTER CONTROL button (Fig. 6 18) to select the desired mode.**  
Each time the button is pressed, the mode will change in the following order:



About three seconds later, the entire display will reappear.

## To Set the Thermostat

Press the SET TEMP. buttons (Fig. 6 19).

- + button:** Press to raise the thermostat setting.
- button:** Press to lower the thermostat setting.

### ●Thermostat setting range:

AUTO .....	64 to 88 °F
* Heating .....	64 to 88 °F
Cooling/Dry .....	64 to 88 °F

The thermostat cannot be used to set room temperature during the FAN mode (the temperature will not appear on the remote control unit's display).

About three seconds later, the entire display will reappear.

The thermostat setting should be considered a standard value, and may differ somewhat from the actual room temperature.

## To Set the Fan Speed

Press the FAN CONTROL button (Fig. 6 22).

Each time the button is pressed, the fan speed changes in the following order:

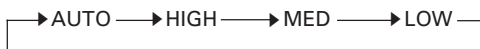

About three seconds later, the entire display will reappear.

### When set to AUTO:

- \* Heating :** Fan operates so as to optimally circulate warmed air. However, the fan will operate at very low speed when the temperature of the air issued from the indoor unit is low.
- Cooling :** As the room temperature approaches that of the thermostat setting, the fan speed becomes slower.
- Fan :** The fan alternately turns on and off; when on, the fan runs at the low fan speed.

The fan will operate at a very low setting during Monitor operation and at the start of the Heating mode.

## To Stop Operation

Press the START/STOP button.

The OPERATION indicator lamp (green or red) (Fig. 3 5) will go out.

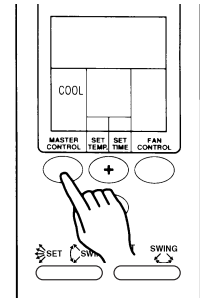

Example: When set to COOL

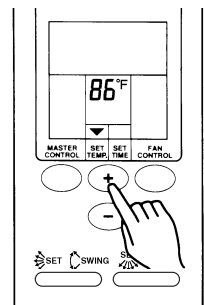

Example: When set to 86 °F

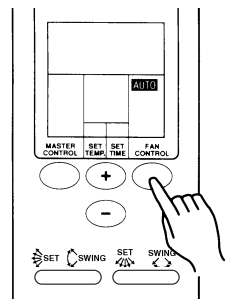

Example: When set to AUTO

# OPERATION

Instructions relating to heating (\*) are applicable only to "HEAT & COOL MODEL" (Reverse Cycle).

## About Mode Operation

### AUTO:

#### COOLING MODEL

- When the room temperature is 4 °F higher than the set temperature, the mode will switch between Cooling and Drying.
- During Drying mode operation, FAN setting is switched to LOW gentle cooling effect, and the room fan may stop rotating temporarily .
- If the mode automatically selected by the unit is not what you wish, see page 6 and select one of the mode operation (COOL, DRY, FAN).

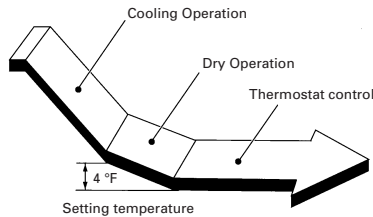

### AUTO (\* AUTO CHANGEOVER):

#### HEAT & COOL MODEL (Reverse cycle)

- When AUTO CHANGEOVER operation is selected, the air conditioner selects the appropriate operation mode (Cooling or Heating) in response to your room's temperature.
- When AUTO CHANGEOVER operation first selected, the fan will operate at very low speed for about one minute, during which time the unit detects the room conditions and selects the proper operating mode.
- When the air conditioner has adjusted your room's temperature to near the thermostat setting, it will begin monitor operation. In the monitor operation mode, the fan will operate at low speed. If the room temperature subsequently changes, the air conditioner will once again select the appropriate operation (Heating, Cooling) to adjust the temperature to the value set in the thermostat. (The monitor operation range is  $\pm 4$  °F relative to the thermostat setting.)
- If the mode automatically selected by the unit is not what you wish, see page 6 and select one of the mode operation (HEAT, COOL, DRY, FAN).

#### \*Heating:

- Use to warm your room.
- When Heating mode is selected, the air conditioner will operate at very low fan speed for about 3 to 5 minutes, after which it will switch to the selected fan setting. This period of time is provided to allow the indoor unit to warm up before beginning full operation.
- When the room temperature is very low, frost may form on the outside unit, and its performance may be reduced. In order to remove such frost, the unit will automatically enter the defrost cycle from time to time. During Automatic Defrosting operation, the OPERATION indicator lamp (red) will flash, and the heat operation will be interrupted.

#### Cooling:

- Use to cool your room.

#### Dry:

- Use for gently cooling while dehumidifying your room.
- You cannot heat the room during Dry mode.
- During Dry mode, the unit will operate at low speed; in order to adjust room humidity, the indoor unit's fan may stop from time to time. Also, the fan may operate at very low speed when detecting room humidity.
- The fan speed cannot be changed manually when Dry mode has been selected.

#### Fan:

- Use to circulate the air throughout your room.

#### \* During Heating mode:

Set the thermostat to a temperature setting that is higher than the current room temperature. The Heating mode will not operate if the thermostat is set lower than the actual room temperature.

#### During Cooling/Dry mode:

Set the thermostat to a temperature setting that is lower than the current room temperature. The Cooling and Dry modes will not operate if the thermostat is set higher than the actual room temperature (in Cooling mode, the fan alone will operate).

#### During Fan mode:

You can not use the unit to heat and cool your room.



# AIR CLEANING OPERATION

- Use this function to remove airborne impurities such as dust, tobacco smoke and pollen and clean the air of the room.
- The air cleaning operation can be used alone or combined with cooling, heating (only heating model) and dry (dehumidifying) operations.

## Starting air cleaning operation

- 1 Start the operation in any one of the following: AUTO, COOL, HEAT, DRY or FAN.**  
Refer to pages 6 and 7 for information about starting these operations.
- 2 Press the AIR CLEAN button (Fig. 6 ⑰).**  
The air clean indicator lamp will light up.

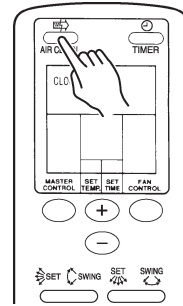

## Stopping air cleaning operation

- 1 Press the AIR CLEAN button.**  
The air clean indicator lamp will go out. (This will not stop the main operation of the air conditioner.)
- 2 Press the START/STOP button (Fig. 6 ⑳).**  
The OPERATION indicator lamp (green or red) will go out.

## Air cleaning

- During operation, the unit produces a small amount of ozone that can be smelled.
- When this unit is used in combination with the ultrasonic humidifier, white particles may become attached to the dust collection unit. If this happens, clean the dust collection unit as soon as possible. (Refer to page 14.)
- The air cleaning unit cannot remove gases such as carbon monoxide and alcohol from the air. During operation, ventilate the room often to prevent asphyxiation or suffocation.
- If the intake filter is removed during operation, a safety device will stop the operation of the air cleaning unit. If this happens, the air clean indicator lamp (green) on the indoor unit will flash after some time has passed. Use the START/STOP button on the remote controller to stop the operation, install the intake filter, and then use the START/STOP button to restart the operation.
- Use the FAN CONTROL button to change the fan speed. (Refer to page 6.) The air cleaning unit operates most effectively at the highest fan speed.
- The air clean indicator lamp will flash to inform you that the periodic cleaning of the dust collection unit is required. (Refer to page 14.)

# TIMER OPERATION

Before using the timer function, be sure that the Remote Control Unit is set to the correct current time (See page 5).

## To Use the ON timer or OFF timer

### 1 While the air conditioner is operating or stopped, press the **TIMER** button (Fig. 6 ⑳).

Both the indoor unit's OPERATION indicator lamp (green or red) (Fig. 3 ⑤) and the TIMER indicator lamp (yellow) (Fig. 3 ⑥) will light.

### 2 Press the **TIMER** button (Fig. 6 ⑳) to select the **OFF** timer or **ON** timer operation.

Each time the button is pressed the timer function changes in the following order:

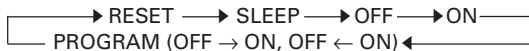

The indoor unit's TIMER indicator lamp (yellow) (Fig. 3 ⑥) will light.

### 3 Use the **SET TIME** buttons (Fig. 6 ⑲) to adjust the desired **OFF** time or **ON** time.

Set the time while the time display is flashing (the flashing will continue for about five seconds).

➡ **button**: Press to advance the time.

⬅ **button**: Press to reverse the time.

About five seconds later, the entire display will reappear.

## To Use the PROGRAM timer

### 1 While the air conditioner is operating or stopped, press the **TIMER** button (Fig. 6 ⑳).

Both the indoor unit's OPERATION indicator lamp (green or red) (Fig. 3 ⑤) and the TIMER indicator lamp (yellow) (Fig. 3 ⑥) will light.

### 2 Set the desired times for **OFF** timer and **ON** timer.

See the section "To Use the ON timer or OFF timer" to set the desired mode and times.

About three seconds later, the entire display will reappear.

The indoor unit's TIMER indicator lamp (yellow) (Fig. 3 ⑥) will light.

### 3 Press the **TIMER** button (Fig. 6 ⑳) to select the **PROGRAM** timer operation (either **OFF** → **ON** or **OFF** ← **ON** will display).

The display will alternately show "OFF timer" and "ON timer", then change to show the time setting for the operation to occur first.

● The PROGRAM timer will begin operation. (If the ON timer has been selected to operate first, the unit will stop operating at this point.)

About five seconds later, the entire display will reappear.

#### About the PROGRAM timer

- The PROGRAM timer allows you to integrate OFF timer and ON timer operations in a single sequence. The sequence can involve one transition from OFF timer to ON timer, or from ON timer to OFF timer, within a twenty-four hour period.
- The first timer function to operate will be the one set nearest to the current time. The order of operation is indicated by the arrow in the remote control unit's display (OFF → ON, or OFF ← ON).
- One example of PROGRAM timer use might be to have the air conditioner automatically stop (OFF timer) after you go to sleep, then start (ON timer) automatically in the morning before you rise.

#### To Cancel the Timer

Use the TIMER button to select "TIMER RESET".

The air conditioner will return to normal operation.

#### To Change the Timer Settings

Perform steps 2 and 3.

#### To Stop Air Conditioner Operation while the Timer is Operating

Press the START/STOP button.

#### To Change Operating Conditions

If you wish to change the operating conditions (Mode, Fan Speed, Thermostat Setting), after making the timer setting, wait until the entire display reappears, then press the appropriate buttons to change the operating condition desired.

#### To Cancel the Timer

Use the TIMER button to select "TIMER RESET".

The air conditioner will return to normal operation.

#### To Change the Timer Settings

1. Follow the instructions given in the section "To Use the ON Timer or OFF Timer" to select the timer setting you wish to change.
2. Press the TIMER button to select either OFF → ON or OFF ← ON.

#### To Stop Air Conditioner Operation while the Timer is Operating

Press the START/STOP button.

#### To Change Operating Conditions

If you wish to change operating conditions (Mode, Fan Speed, Thermostat Setting), after making the timer setting, wait until the entire display reappears, then press the appropriate buttons to change the operating condition desired.

#### About the ON timer

- The timer function is designed to bring your room to a comfortable temperature by the set time; as a result, the unit automatically begins operation before the set time so that the room reaches the desired temperature by the time set on the timer.
- The hotter it is in summer, or the colder it is in winter, the earlier that operation will begin.
- \* During Heating Operation ..... from 45 to 10 minutes before set time.  
During Cooling/Dry Operation ... from 20 to 10 minutes before set time.  
During Fan Operation ..... at the set time.

# TIMER OPERATION

Unlike other timer functions, the SLEEP timer is used to set the length of time until air conditioner operate is stopped.

## To Use the SLEEP timer

While the air conditioner is operating or stopped, press the **TIMER** button (Fig. 6 ⑳).

Both the indoor unit's OPERATION indicator lamp (green or red) (Fig. 3 ⑤) and the TIMER indicator lamp (yellow) (Fig. 3 ⑥) will light.

## To Change the Timer Settings

Press the **TIMER** button (Fig. 6 ㉑) once again and set the time using the **SET TIME** buttons (Fig. 6 ㉒).

Set the time while the Timer Mode Display is flashing (the flashing will continue for about five seconds).

- + button:** Press to advance the time.
- button:** Press to reverse the time.

About five seconds later, the entire display will reappear.

## About the SLEEP timer

To prevent excessive warming or cooling during sleep, the SLEEP timer function automatically modifies the thermostat setting in accordance with the time setting. When the set time has elapsed, the air conditioner completely stops.

**During Heating operation (HEAT & COOL MODEL (Reverse cycle) only):**

When the SLEEP timer is set, the thermostat setting is automatically lowered 2 °F every thirty minutes. When the thermostat has been lowered a total of 8 °F, the thermostat setting at that time is maintained until the set time has elapsed, at which time the air conditioner automatically turns off.

**During Cooling/Dry operation:**

When the SLEEP timer is set, the thermostat setting is automatically raised 2 °F every sixty minutes. When the thermostat has been raised a total of 4 °F, the thermostat setting at that time is maintained until the set time has elapsed, at which time the air conditioner automatically turns off.

SLEEP timer setting

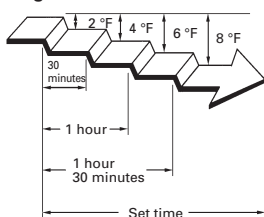

SLEEP timer setting

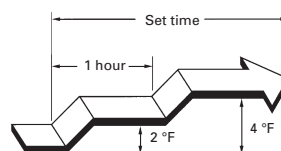

# MANUAL AUTO OPERATION

Use the MANUAL AUTO operation in the event the remote control unit is lost or otherwise unavailable.

## How To Use the Main Unit Controls

Press the **MANUAL AUTO** button (Fig. 2 ㉑) on the main unit control panel.

To stop operation, press the **MANUAL AUTO** button once again.

### ⚠ CAUTION!

Do not press the **MANUAL AUTO** button with wet hands or pointed objects, otherwise an electric shock or malfunction may occur.

- When the air conditioner is operated with the controls on the Main unit, it will operate under the same mode as the AUTO mode selected on the remote control unit (see page 7).
- The fan speed selected will be "AUTO" and the thermostat setting will be 76 °F.

# ADJUSTING THE DIRECTION OF AIR CIRCULATION

Instructions relating to heating (\*) are applicable only to "HEAT & COOL MODEL" (Reverse Cycle).

Vertical (up-down) direction of airflow is adjusted by pressing the remote control unit's AIR FLOW DIRECTION VERTICAL SET button. Horizontal (right-left) direction of airflow is adjusted by pressing the remote control unit's AIR FLOW DIRECTION HORIZONTAL SET button.

## Vertical Air Direction Adjustment

Press the AIR FLOW DIRECTION VERTICAL SET button (Fig. 6 24).

Each time the button is pressed, the air direction range will change as follows:



### Types of Air flow Direction Setting:

- ①,②,③ : During Cooling/Dry mode
- ①,②,③,④,⑤ : \* During Heating mode

The remote control unit's display does not change.

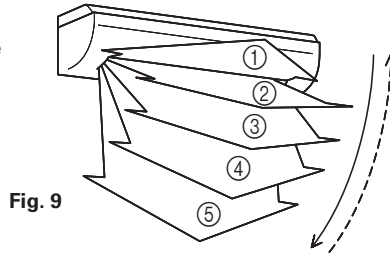

Fig. 9

- Use the air direction adjustments within the ranges shown above.
- The vertical airflow direction is set automatically as shown, in accordance with the type of operation selected.
  - During Cooling/Dry mode : Horizontal flow ①
  - \* During Heating mode : Downward flow ⑤
- During AUTO mode operation, for the first minute after beginning operation, airflow will be horizontal ①; the air direction cannot be adjusted during this period.

## ⚠ DANGER!

Never place fingers or foreign objects inside the outlet ports, since the internal fan operates at high speed and could cause personal injury.

- Always use the remote control unit's AIR FLOW DIRECTION button to adjust the UP/DOWN air direction flaps or RIGHT/LEFT air direction louvers. Attempting to move them manually could result in improper operation; in this case, stop operation and restart. The louvers should begin to operate properly again.
- During use of the Cooling and Dry modes, do not set the UP/DOWN air direction flaps in the range ④ to ⑤ for long periods of time, since water vapor may condense near the outlet port and drops of water may drip from the air conditioner.
- When used in a room with infants, children, elderly or sick persons, the air direction and room temperature should be considered carefully when making settings.

## Horizontal Air Direction Adjustment

Press the AIR FLOW DIRECTION HORIZONTAL SET button (Fig. 6 26).

Each time the button is pressed, the air direction range will change as follows:



The remote control unit's display does not change.

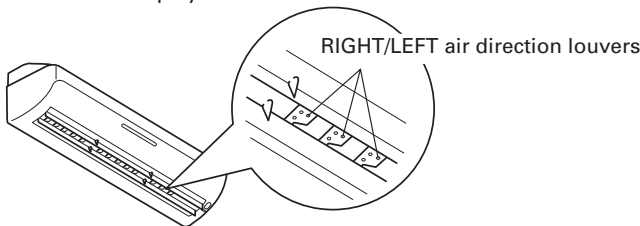

- Use the air direction adjustments within the ranges shown above.

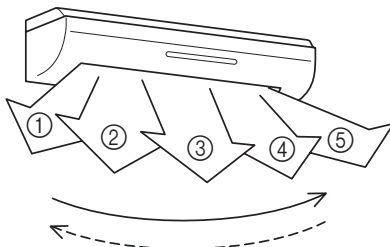
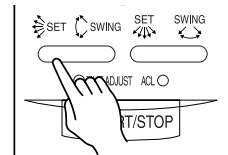
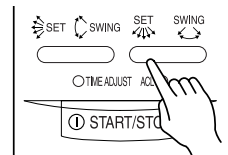

Fig. 10



Example: When set to vertical air direction



Example: When set to horizontal air direction

# SWING OPERATION

Begin air conditioner operation before performing this procedure.

## To select Vertical airflow SWING Operation

Press the **AIR FLOW DIRECTION VERTICAL SWING** button (Fig. 6 25).

The SWING indicator lamp (VERTICAL SWING) (Fig. 3 7) will light. In this mode, the UP/DOWN air direction flaps will swing automatically to direct the air flow both up and down.

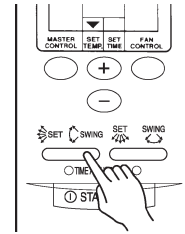

## To Stop Vertical airflow SWING Operation

Press the **AIR FLOW DIRECTION VERTICAL SWING** button (Fig. 6 25) once again.

The SWING indicator lamp (VERTICAL SWING) (Fig. 3 7) will go out. Airflow direction will return to the setting before swing was begun.

## About Swing Operation

- The range of swing is relative to the currently set airflow direction.

Air flow direction set	Range of swing
①	① to ③
②	① to ③
③	② to ④
④	③ to ⑤
⑤	① to ⑤ (All range)

Air direction range (See page 11, Fig. 9)

- If the swing range is not as desired, use the remote control unit's AIR FLOW DIRECTION VERTICAL SET button to change the range of swing.
- The SWING operation may stop temporarily when the air conditioner's fan is not operating, or when operating at very low speeds.
- During use of the Cooling and Dry modes, do not set the air UP/DOWN direction flaps, in the range ④ to ⑤ for long periods of time, since water vapor may condense near the outlet port and drops of water may drip from the air conditioner.

## To select Horizontal airflow SWING Operation

Press the **AIR FLOW DIRECTION HORIZONTAL SWING** button (Fig. 6 27).

The SWING indicator lamp (HORIZONTAL SWING) (Fig. 3 7) will light. In this mode, the RIGHT/LEFT air direction louvers will swing automatically to direct the airflow both right and left.

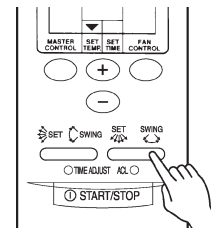

## To Stop Horizontal airflow SWING Operation

Press the **AIR FLOW DIRECTION HORIZONTAL SWING** button (Fig. 6 27) once again.

The SWING indicator lamp (HORIZONTAL SWING) (Fig. 3 7) will go out. Airflow direction will return to the setting before swing was begun.

## About Swing Operation

- The range of swing is relative to the currently set airflow direction.

Air flow direction set	Range of swing
①	① to ⑤ (All range)
②	① to ③
③	② to ④
④	③ to ⑤
⑤	① to ⑤ (All range)

Air direction range (See page 11, Fig. 10)

- If the swing range is not as desired, use the remote control unit's AIR FLOW DIRECTION HORIZONTAL SET button to change the range of swing.
- The SWING operation may stop temporarily when the air conditioner's fan is not operating, or when operating at very low speeds.

# CLEANING AND CARE

## CAUTION!

- Before cleaning the air conditioner, be sure to turn it off and disconnect the power supply.
- Turn off the electrical breaker.
- Be sure the intake filter (Fig. 4 ⑨) is installed securely.
- When removing and replacing the intake filters, be sure not to touch the heat exchanger, as personal injury may result.

### Cleaning the Intake Filters

#### 1. Remove the intake filters.

- ① Place fingers in grids on the front of the intake filters and lift up.

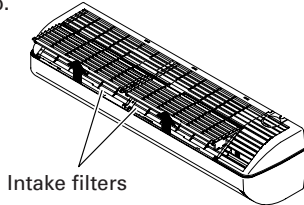

- ② Hold the intake filters level and pull them out.

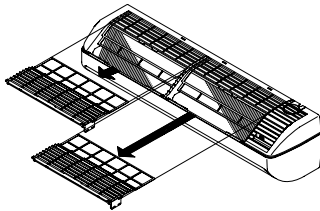

#### 2. Clean the intake filters.

Remove the dust from the intake filters by vacuuming or washing them. After washing, allow the intake filters to dry thoroughly in an area protected from sunlight.

- Dust can be cleaned from the intake filters either with a vacuum cleaner, or by washing the filters in a solution of mild detergent and warm water. If you wash the filters, be sure to allow them to dry thoroughly in a shady place before reinstalling.
- If dirt is allowed to accumulate on the intake filters, air flow will be reduced, lowering operating efficiency and increasing noise.
- During periods of normal use, the intake filters should be cleaned every five weeks.

#### 3. Install the intake filters.

Hang the edge of the intake filter on the body. Using this as a support point, push forward to secure as shown in the illustration.

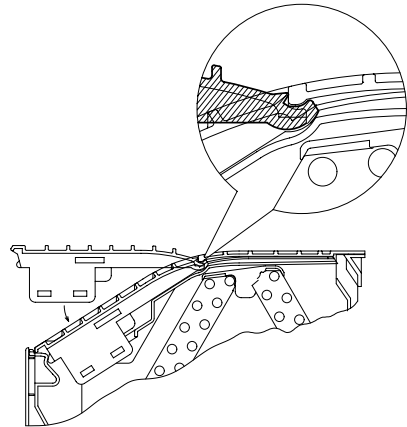

- When used for extended periods, the unit may accumulate dirt inside, reducing its performance. We recommend that the unit be inspected regularly, in addition to your own cleaning and care. For more information, consult authorized service personnel.
- When cleaning the unit's body, do not use water hotter than 100 °F, harsh abrasive cleansers, or volatile agents like benzene or thinner.
- Do not expose the unit body to liquid insecticides or hairsprays.
- When shutting down the unit for one month or more, first allow the fan mode to operate continuously for about one-half day to allow internal parts to dry thoroughly.

# CLEANING THE ELECTRONIC AIR CLEAN UNIT

## **WARNING!**

Before cleaning the dust collection unit, be sure to turn off the power supply to the air conditioner. Electric shock may result.

## **CAUTION!**

- Make sure the dust collection unit is properly mounted before cleaning or performing other tasks on it. If the unit is not properly mounted, it could fall off and cause damage or injury.
- You can be injured if you touch the heat exchanger when removing or installing the dust collection unit. Do not insert your fingers between the dust collection unit and the heat exchanger.

The display section for the air clean indicator will flash when it is time for the periodic cleaning of the dust collection unit.

- When the flashing of the display section for the air clean indicator is slow (approximately 1 flash every 7 seconds)  
This will flash after approximately 400 hours of operation. Cleaning of the dust collection unit as soon as possible is recommended.
- When the flashing of the display section for the air clean indicator is fast (approximately 1 flash every 3 seconds)  
This will flash after approximately 500 hours of operation. Stop the air cleaning operation and clean the dust collection unit.

- As a guideline, clean every 6 months.
- If unusual sounds like the rushing of air or popping are heard, clean the dust collection unit as quickly as possible.
- If the air cleaning check function is operating, open the intake grille and press the MANUAL AUTO button.

### Removing the dust collection unit

1. Use the remote controller to stop operation and turn off the power supply.
2. Open the right side intake grille and remove the air filter. (Refer to page 13.)
3. Remove the dust collection unit.

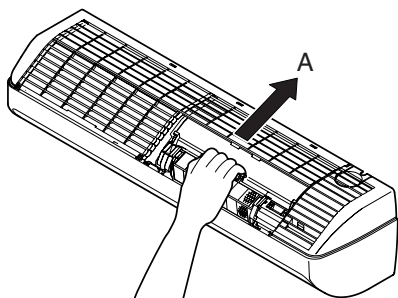

Grasp the handle of the dust collection unit. Pull up to remove (shown as direction A).

### Cleaning the dust collection unit

#### Wash with water and dry.

- ① Soak the dust collection unit in warm water (100 to 115 °F) for 10 to 15 minutes. If the dust collection unit is extremely dirty, extremely dilute a mild synthetic laundry detergent (low alkalinity or isotope detergent) to 15 times the standard concentration and allow the dust collection unit to soak in it.
- ② Gently move up and down and to the right and left. A soft sponge can also be used to wipe the rear surface.
- ③ Rinse with clean water.
- ④ Shake the dust collection unit to drain off the water. (If the dust collection unit is extremely dirty, repeat Steps ① through ④ two or three more times.)
- ⑤ Place the dust collection unit in the shade and allow it to dry completely.



- Only use a mild synthetic laundry detergent (low alkalinity or isotope detergent).
- Never disassemble the dust collection unit.
- Never soak the dust collection unit in hot water.
- Never wipe the dust collection unit with a scrub brush or other hard or abrasive items. This will damage the honey comb filter.
- Never insert a brush into the inside of dust collection unit for washing. This will damage the internal parts and cause malfunctioning of the air cleaning unit.
- Never use dryer or other device to blow hot air on the dust collection unit. This will cause deformation or other damage.



# CLEANING THE ELECTRONIC AIR CLEAN UNIT

## **WARNING!**

Before cleaning the dust collection unit, be sure to turn off the power supply to the air conditioner. Electric shock may result.

## **CAUTION!**

- Make sure the dust collection unit is properly mounted before cleaning or performing other tasks on it. If the unit is not properly mounted, it could fall off and cause damage or injury.
- You can be injured if you touch the heat exchanger when removing or installing the dust collection unit. Do not insert your fingers between the dust collection unit and the heat exchanger.

### Mounting the dust collection unit

#### 1. Mount the dust collection unit.

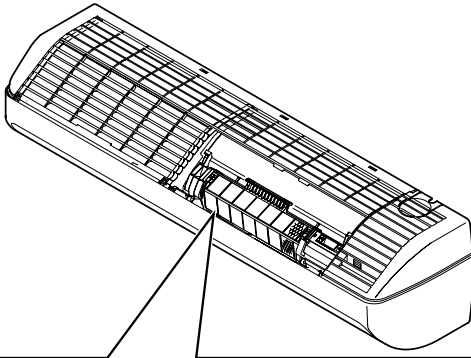

- ① Slide the dust collection unit onto the guide rails of the electronic air clean filter.

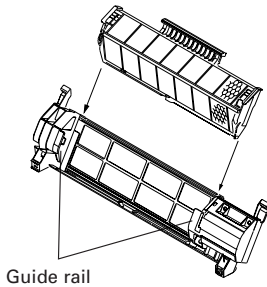

- ② Slide the dust collection unit until the projections (2 locations) on the guide rails "click."

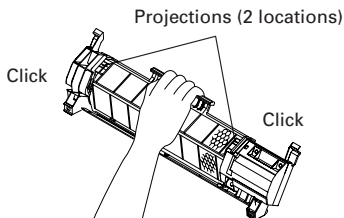

- Make sure the dust collection unit is completely dry before mounting it.
- After the dust collection unit has been mounted into place, make sure that the dust collection unit is securely inserted in the frame. If the dust collection unit is not properly mounted, the air cleaning operation will stop.

#### 2. Install the intake filter. (Refer to page 13.)

- If the lamps flash after cleaning the dust collection unit, check if the dust collection unit is wet and if the intake filters are closed tightly.
- If the dust collection unit is completely dry and the intake filters are installed tightly but the lamps still flash quickly, see TROUBLESHOOTING (Page 17).



# SELECTING THE REMOTE CONTROL UNIT SIGNAL CODE

When two or more air conditioners are installed in a room and the remote control unit is operating an air conditioner other than the one you wish to set, change the signal code of the remote control unit to operate only the air conditioner you wish to set (four selections possible).

When two or more air conditioners are installed in a room, please contact your retailer to set the individual air conditioner signal codes.

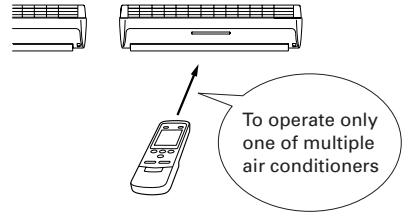

## Selecting the Remote Control Unit Signal Code

Use the following steps to select the signal code of the remote control unit. (Note that the air conditioner cannot receive a signal code if the air conditioner has not been set for the signal code.)

**1** Press the **START/STOP** button (Fig. 6 23) until only the clock is displayed on the remote control unit display.

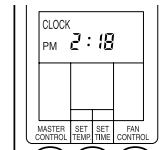

**2** Press the **MASTER CONTROL** button (Fig. 6 18) for at least five seconds to display the current signal code (initially set to **A**).

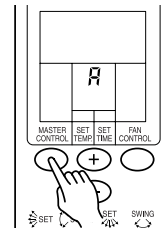

**3** Press the **+/-** buttons (Fig. 6 19) to change the signal code between **A**→**b**→**c**→**d**. Match the code on the display to the air conditioner signal code.

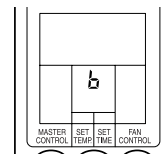

**4** Press the **MASTER CONTROL** button again to return to the clock display. The signal code will be changed.

If no buttons are pressed within 30 seconds after the signal code is displayed, the system returns to the original clock display. In this case, start again from step 1.

The air conditioner signal code is set to A prior to shipment. Contact your retailer to change the signal code.

The remote control unit resets to signal code A when the batteries in the remote control unit are replaced. If you use a signal code other than signal code A, reset the signal code after replacing the batteries. If you do not know the air conditioner signal code setting, try each of the signal codes (**A**→**b**→**c**→**d**) until you find the code which operates the air conditioner.

# TROUBLESHOOTING

Instructions relating to heating (\*) are applicable only to "HEAT & COOL MODEL" (Reverse Cycle).



## WARNING!

In the event of a malfunction (burning smell, etc.), immediately stop operation, turn off the electrical breaker or disconnect the power supply plug, and consult authorized service personnel. Merely turning off the unit's power switch will not completely disconnect the unit from the power source. Always be sure to turn off the electrical breaker or disconnect the power supply plug to ensure that power is completely off.

Before requesting service, perform the following checks:

	Symptom	Problem	See Page
NORMAL FUNCTION	Doesn't operate immediately:	<ul style="list-style-type: none"> <li>● If the unit is stopped and then immediately started again, the compressor will not operate for about 3 minutes, in order to prevent fuse blowouts.</li> <li>● Whenever the electrical breaker is turned off then on again or the power supply plug is disconnected and then reconnected, the protection circuit will operate for about 3 minutes, preventing unit operation during that period.</li> </ul>	—
	Noise is heard:	<ul style="list-style-type: none"> <li>● During operation and immediately after stopping the unit, the sound of water flowing in the air conditioner's piping may be heard. Also, noise may be particularly noticeable for about 2 to 3 minutes after starting operation (sound of coolant flowing).</li> <li>● During operation, a slight squeaking sound may be heard. This is the result of minute expansion and contraction of the front cover due to temperature changes.</li> </ul>	—
		<ul style="list-style-type: none"> <li>● If an unusual noise is heard from the electronic air clean unit, check if the dust collection unit is dirty and make sure that it is installed correctly. Clean the dust collection unit and install it correctly if necessary.</li> </ul>	14, 15
		<ul style="list-style-type: none"> <li>*● During Heating operation, a sizzling sound may be heard occasionally. This sound is produced by the Automatic Defrosting operation.</li> </ul>	18
	Smells:	<ul style="list-style-type: none"> <li>● Some smell may be emitted from the indoor unit. This smell is the result of room smells (furniture, tobacco, etc.) which have been taken into the air conditioner.</li> </ul>	—
	Mist or steam are emitted:	<ul style="list-style-type: none"> <li>● During Cooling or Dry operation, a thin mist may be seen emitted from the indoor unit. This results from the sudden Cooling of room air by the air emitted from the air conditioner, resulting in condensation and misting.</li> </ul>	—
		<ul style="list-style-type: none"> <li>*● During Heating operation, the outdoor unit's fan may stop, and steam may be seen rising from the unit. This is due to the Automatic Defrosting operation.</li> </ul>	18
	Airflow is weak or stops:	<ul style="list-style-type: none"> <li>*● When Heating operation is started, fan speed is temporarily very low, to allow internal parts to warm up.</li> <li>*● During Heating operation, if the room temperature rises above the thermostat setting, the outdoor unit will stop, and the indoor unit will operate at very low fan speed. If you wish to warm the room further, set the thermostat to a higher setting.</li> </ul>	—
		<ul style="list-style-type: none"> <li>*● During Heating operation, the unit will temporarily stop operation (between 7 and 15 minutes) as the Automatic Defrosting mode operates. During the Automatic Defrosting operation, the OPERATION indicator lamp will flash.</li> </ul>	18
		<ul style="list-style-type: none"> <li>● The fan may operate at very low speed during Dry operation or when the unit is monitoring the room's temperature.</li> </ul>	6
		<ul style="list-style-type: none"> <li>● In the monitor AUTO operation, the fan will operate at very low speed.</li> </ul>	6
	Water is produced from the outdoor unit:	<ul style="list-style-type: none"> <li>*● During Heating operation, water may be produced from the outdoor unit due to the Automatic Defrosting operation.</li> </ul>	18
	Flashing air clean indicator lamp (green):	<ul style="list-style-type: none"> <li>● This lamp will flash slowly after approximately 400 hours of air cleaning operation. Stop the operation, turn off the power supply and clean the dust collection unit and air filter.</li> <li>● This lamp will flash quickly after approximately 500 hours of air cleaning operation. The air cleaning operation will be stopped when this flashing occurs. Make sure the operation is stopped, turn off the power supply and clean the dust collection unit and air filter.</li> </ul>	14
<ul style="list-style-type: none"> <li>● This lamp will flash quickly if the dust collection unit is not installed correctly. Stop the operation, turn off the power supply, and then install the dust collection unit correctly.</li> </ul>		15	

# TROUBLESHOOTING

Instructions relating to heating (\*) are applicable only to "HEAT & COOL MODEL" (Reverse Cycle).

	Symptom	Items to check	See Page
CHECK ONCE MORE	Doesn't operate at all:	<ul style="list-style-type: none"> <li>● Has there been a power failure?</li> <li>● Has a fuse blown out, or a circuit breaker been tripped?</li> </ul>	—
		<ul style="list-style-type: none"> <li>● Is the timer operating?</li> </ul>	9 to 10
	Poor Cooling (or *Heating) performance:	<ul style="list-style-type: none"> <li>● Is the air filter dirty?</li> <li>● Are the air conditioner's intake filter or outlet port blocked?</li> <li>● Did you adjust the room temperature settings (thermostat) correctly?</li> <li>● Is there a window or door open?</li> <li>● In the case of Cooling operation, is a window allowing bright sunlight to enter? (Close the curtains.)</li> <li>● In the case of Cooling operation, are there heating apparatus and computers inside the room, or are there too many people in the room?</li> </ul>	—
	The unit operates differently from the remote control unit's setting:	<ul style="list-style-type: none"> <li>● Are the remote control unit's batteries dead?</li> <li>● Are the remote control unit's batteries loaded properly?</li> </ul>	5
	Signal is not received after replacing the batteries for the remote control unit:	<ul style="list-style-type: none"> <li>● Are you using an air conditioner signal code other than signal code A?</li> </ul>	16

If the problem persists after performing these checks, or if you notice burning smells, or the TIMER indicator lamp (Fig. 3 ㉔) flashes, immediately stop operation, turn off the power supply, and consult authorized service personnel.

## OPERATING TIPS

### Operation and Performance

#### \*Heating Performance

- This air conditioner operates on the heat-pump principle, absorbing heat from outdoor air and transferring that heat indoors. As a result, the operating performance is reduced as outdoor air temperature drops. If you feel that insufficient heating performance is being produced, we recommend you use this air conditioner in conjunction with another kind of heating appliance.
- Heat-pump air conditioners heat your entire room by recirculating air throughout the room, with the result that some time may be required after first starting the air conditioner until the room is heated.

#### \*When Indoor and Outdoor Temperatures are High

When both indoor and outdoor temperatures are high during use of the heating mode, the outdoor unit's fan may stop at times.

#### \*Microcomputer-controlled Automatic Defrosting

When using the Heating mode under conditions of low outdoor air temperature high humidity, frost may form on the outdoor unit, resulting in reduced operating performance.

In order to prevent this kind of reduced performance, this unit is equipped with a Microcomputer-controlled Automatic Defrosting function. If frost forms, the air conditioner will temporarily stop, and the defrosting circuit will operate briefly (for about 7 to 15 minutes).

During Automatic Defrosting operation, the OPERATION indicator lamp (red) will flash.

#### \*Low Ambient Cooling

When the outdoor temperature drops, the outdoor unit's fans may switch to Low Speed.

# OPERATING TIPS

Instructions relating to heating (\*) are applicable only to "HEAT & COOL MODEL" (Reverse Cycle).

## AUTO Restart

### In Event of Power Interruption

- Should the power supply to the air conditioner be interrupted by a power failure, the air conditioner will restart automatically in the previously selected mode once the power is restored.
- Should a power failure occur during TIMER operation, the timer will be reset and the unit will begin (or stop) operating under the new timer setting. In this event, the TIMER indicator lamp (yellow) will flash (see page 4).
- Use of other electrical appliances (electric shaver, etc.) or nearby use of a wireless radio transmitter may cause the air conditioner to malfunction. In this event, temporarily disconnect the power supply, reconnect it, and then use the remote control unit to resume operation.

## Temperature and Humidity Range

### COOLING/DRY MODE

	Outdoor Unit	Outdoor Temperature	Indoor	
			Temperature	Humidity
COOLING MODELS	AOU18CXQ AOU24CXQ	About 32 to 110 °F	About 65 to 90 °F	About 80 % or less If the unit is used for long periods under high-humidity conditions, condensation may form on the surface of the indoor unit, and drip onto the floor or other objects underneath.
HEAT & COOL MODELS (Reverse Cycle)	AOU18RXQ AOU24RXQ	About 32 to 110 °F		

### \*HEATING MODE

	Outdoor Unit	Outdoor Temperature	Indoor Temperature
HEAT & COOL MODELS (Reverse Cycle)	AOU18RXQ AOU24RXQ	About 32 to 75 °F	About 86 °F or less

- If the air conditioner is operated under higher temperature conditions than those listed, the built-in protection circuit may operate to prevent internal circuit damage. Also, during Cooling and Dry modes, if the unit is used under conditions of lower temperature than those listed above, the heat-exchanger may freeze, leading to water leakage and other damage.
- Do not use this unit for any purposes other than the Cooling, (\*)Heating, Dehumidifying, and air-circulation of rooms in ordinary dwellings.



FUJITSU GENERAL LIMITED  
1116, Suenaga, Takatsu-ku, Kawasaki 213-8502, Japan

## Free Manuals Download Website

<http://myh66.com>

<http://usermanuals.us>

<http://www.somanuals.com>

<http://www.4manuals.cc>

<http://www.manual-lib.com>

<http://www.404manual.com>

<http://www.luxmanual.com>

<http://aubethermostatmanual.com>

Golf course search by state

<http://golfingnear.com>

Email search by domain

<http://emailbydomain.com>

Auto manuals search

<http://auto.somanuals.com>

TV manuals search

<http://tv.somanuals.com>