

Display

# B17-5 ECO/B19-5 ECO

Operating Manual



English

## Do you have ...

... any technical questions or problems?

Please contact:

- our Hotline/Help Desk (please refer to the enclosed Help Desk list or look up the contact details on our website at: "<http://ts.fujitsu.com/support/>" )
- your sales partner
- your sales office

The latest information about our products, useful tips, updates etc. is available on our website: "<http://ts.fujitsu.com/support/>"



**Copyright**

© Fujitsu Technology Solutions 2009  
2009/05

**Published by**

Fujitsu Technology Solutions GmbH  
Mies-van-der-Rohe-Straße 8  
80807 München, Germany

**Contact**

<http://ts.fujitsu.com/support>

All rights reserved, including intellectual property rights.  
Technical data subject to modifications and delivery subject to availability. Any liability that the data and illustrations are complete, actual or correct is excluded. Designations may be trademarks and/or copyrights of the respective manufacturer, the use of which by third parties for their own purposes may infringe the rights of such owner. For further information see [http://ts.fujitsu.com/terms\\_of\\_use.html](http://ts.fujitsu.com/terms_of_use.html)

# FUJITSU B17-5 ECO / B19-5 ECO

## Operating Manual

<b>Your LCD screen...</b>	<b>1</b>
<b>Important notes</b>	<b>3</b>
<b>Getting started</b>	<b>7</b>
<b>Operation</b>	<b>14</b>
<b>Troubleshooting</b>	<b>23</b>
<b>Notes regarding the DIN EN ISO 13406-2 standard</b>	<b>25</b>
<b>Technical specification</b>	<b>26</b>

VESA, DDC and DPMS are registered trademarks of the Video Electronics Standards Association.

Copyright © Fujitsu Technology Solutions GmbH 2009

All rights reserved, including rights of translation, reproduction by printing, copying or similar methods, in part or in whole.

Offenders will be liable for damages.

All rights reserved, including rights created by patent grant or registration of a utility model or design.

Subject to availability and technical modifications.

No liability for content or printing errors.

---

# Contents

<b>Your LCD screen...</b> .....	<b>1</b>
Target group .....	1
Further information .....	2
Notational conventions .....	2
<b>Important notes</b> .....	<b>3</b>
Safety instructions .....	3
Power cable .....	4
Transporting the device .....	4
Cleaning the device .....	4
CE marking .....	5
Energy Star .....	5
Disposal and recycling .....	6
<b>Getting started</b> .....	<b>7</b>
Unpacking and checking the delivery .....	7
Setting up the device .....	7
Setting up an ergonomic video workstation .....	8
Adjusting the height .....	10
Adjusting the inclination .....	10
Adjusting the rotation .....	10
Adjusting portrait format .....	10
Removing monitor base .....	11
Connecting the device .....	12
Connecting cables to the monitor .....	12
Connecting cables to the computer .....	13
<b>Operation</b> .....	<b>14</b>
Switching the device on and off .....	14
Notes on power management .....	15
Changing the monitor settings .....	16
Changing the monitor settings with the buttons of the control panel .....	16
Changing the monitor settings using the OSD menu .....	17
<b>Troubleshooting</b> .....	<b>23</b>
<b>Notes regarding the DIN EN ISO 13406-2 standard</b> .....	<b>25</b>
<b>Technical specification</b> .....	<b>26</b>
VESA-DDC-compatible VGA interface .....	27
Preset operating modes .....	27
Most frequent operating modes .....	27
SUB D port .....	28
DVI-D port .....	29





---

# Your LCD screen...

has a whole range of useful features and functions, e.g.:

- TFT display (Thin Film Transistor; active matrix)
- minimal space requirements thanks to slim casing
- optimum ergonomic characteristics (totally distortion-free, excellent picture definition and colour purity right into the corners)
- high degree of brightness and good contrast
- high resolution (1280 x 1024)
- presentation of up to 16.7 million colours (in conjunction with an appropriate display adapter)
- automatic scanning of horizontal frequencies from 30 to 83 kHz and refresh rates (vertical frequencies) from 55 to 76 Hz (absolutely flicker-free)
- digital screen controller with microprocessor for storing 28 different display modes
- freely adjustable colour alignment for matching the screen colours to the colours of various input and output devices
- convenient operation via integrated OSD (On-Screen-display) menu
- VESA-DDC compatibility
- VESA-FPMPMI compatibility (Flat Panel Monitor Physical Mounting Interface) – Mounting device for swivel arm and wall bracket
- Plug&Play capability
- power management for reducing power consumption when the computer is not in use
- Compliance with the recommendations according to TCO
- the monitor fulfills all GS ("Geprüfte Sicherheit", Certified Security) requirements.

This operating manual contains important information you require to start up and run your LCD monitor.

A graphics card (display adapter) with VGA interface or a digital display adapter with DVI interface is required to control the LCD monitor. The monitor processes the data supplied to it by the display adapter. The display adapter or the associated driver software is responsible for setting the modes (resolution and refresh rate).

When putting the monitor into operation for the first time, the screen display should be optimally adapted to the display adapter used and adjusted in accordance with your needs (see chapter ["Changing the monitor settings", Page 16](#)).

## Target group

You don't need to be an "expert" to perform the operations described here. However, please observe the safety information given in the operating instructions for the computer and in this manual.

In the event of any problems occurring, please contact your sales outlet or our Help Desk.







## Further information

Details of how you set the resolution and refresh rate are provided in the documentation for your display adapter and the associated driver software.

For ergonomic reasons, a screen resolution of 1280 x 1024 pixels is recommended.

Because of the technology used (active matrix) an LCD monitor provides a totally flicker-free picture even with a refresh rate of 60 Hz.

## Notational conventions

	Pay particular attention to text marked with this symbol. Failure to observe these warnings could pose a risk to health, damage the device or lead to loss of data. The warranty will be invalidated if the device becomes defective through failure to observe these warnings.
	Indicates important information for the proper use of the device.
	Indicates an activity that must be performed
	Indicates a result
<b>This font</b>	indicates data entered using the keyboard in a program dialogue or command line, e.g. your password (( <b>Name123</b> ) or a command used to start a program ( <b>start.exe</b> )
This font	indicates information that is displayed on the screen by a program, e.g.: <i>Installation is complete.</i>
<i>This font</i>	indicates <ul style="list-style-type: none"> <li>• terms and texts used in a software interface, e.g.: Click on <i>Save</i></li> <li>• names of programs or files, e.g. <i>Windows</i> or <i>setup.exe</i>.</li> </ul>
"This font"	indicates <ul style="list-style-type: none"> <li>• cross-references to another section, e.g. "Safety information"</li> <li>• cross-references to an external source, e.g. a web address: For more information, go to "<a href="http://ts.fujitsu.com">http://ts.fujitsu.com</a>"</li> <li>• Names of CDs, DVDs and titles or designations of other materials, e.g.: "CD/DVD Drivers &amp; Utilities" or "Safety" Manual</li> </ul>
	indicates a key on the keyboard, e.g. 
<b>This font</b>	indicates terms and texts that are emphasised or highlighted, e.g.: <b>Do not switch off the device</b>

# Important notes

In this chapter you will find information regarding safety which it is essential to take note of when working with your device.

## Safety instructions

This device complies with the relevant safety regulations for data processing equipment, including electronic office machines for use in an office environment. If you have any questions, contact your sales outlet or our Help Desk.

- The display surface of the device is sensitive to pressure and scratches. You should therefore be careful with the display surface in order to avoid lasting damage (scratches).
- If the device is brought into the installation site from a cold environment, condensation can form. Before operating the device, wait until it is absolutely dry and has reached approximately the same temperature as the installation site.
- When installing and operating the device, please observe the notes on environmental conditions in Chapter ["Technical specification", Page 26](#) as well as the instructions in Chapter ["Setting up an ergonomic video workstation", Page 8](#).
- To ensure sufficient ventilation, the air inlet and outlet openings of the device must be kept clear.
- The device automatically sets itself to the correct voltage within the range from 100 V to 240 V. Make sure that the local mains voltage is neither higher nor lower than this range.
- Ensure that the power socket on the device and the mains outlet are freely accessible.
- The ON/OFF switch does not disconnect the monitor from the mains voltage. To disconnect fully from the mains supply, disconnect the power plug from the socket.
- The device is equipped with a power cable that complies with safety standards.
- Use the supplied power cable only.
- Lay the cables in such a way that they do not create a hazard (danger of tripping) and cannot be damaged. When connecting the device, observe the relevant notes in chapter ["Connecting the device", Page 12](#).
- No data transfer cables should be connected or disconnected during a thunderstorm.
- Make sure that no objects (e.g. jewellery chains, paper clips, etc.) or liquids get inside the device (danger of electric shock, short circuit).
- The device is not waterproof! Never immerse the device in water and protect it from spray water (rain, sea water).
- In emergencies (e.g. damaged casing, elements or cables, penetration of liquids or foreign matter), switch off the device, disconnect the power plug and contact your sales outlet or our Help Desk.
- Repairs to the device must only be performed by qualified technicians. Unauthorised opening and incorrect repair may greatly endanger the user (electric shock, fire risk).
- Only use the screen resolution settings and refresh rates specified in Chapter ["Technical specification", Page 26](#). Otherwise you may damage the device. If you are in any doubt, contact your sales outlet or our Help Desk.
- Use a screen saver with moving images and activate the power management for your monitor to prevent still images from "burning in".
- If you operate the device with the swivel arm or wall bracket, it must not be turned by 180°.

- The device must only be operated in landscape mode (0°) and portrait mode (90°). The control buttons are located in the middle of the bottom of the monitor in landscape mode (0°) and at the left-hand side of the monitor in portrait mode (90°).
- Store this manual close to the device. If you pass the device on to third parties, you should pass this manual on with it.
- We recommend that you place your device on a durable, non-slip surface. In view of the many different finishes and varnishes used on furniture, it is possible that the feet of the device may mark the surface they stand on.
- To ensure sufficient ventilation, the air supply and air outlet openings of the monitor must never be blocked.

## Power cable

Use the supplied power cable only.

Use the following guidelines if it is necessary to replace the original cable set.

- The female/male receptacles of the cord set must meet IEC60320/CEE-22 requirements.
- The cable has to be HAR-certified or VDE-certified. The mark HAR or VDE will appear on the outer sheath.
- For devices which are mounted on a desk or table, type SVT or SJT cable sets may be used. For devices which sit on the floor, only SJT type cable sets may be used.
- The cable set must be selected according to the rated current for your device.
- If necessary, replace the original power cable with a regular grounded 3-core mains lead.

## Transporting the device



Transport all parts separately in their original packaging or in a packaging which protects them from knocks and jolts, to the new site.

Do not unpack them until all transportation manoeuvres are completed.

If the device is brought from a cold environment into the room where it will be used, condensation may occur. Before operating the device, wait until it is absolutely dry and has reached approximately the same temperature as the installation site.

## Cleaning the device



Switch off the device and unplug the power plug.

Do not clean any interior parts yourself, leave this job to a service technician.

Do not use any cleaning agents that contain abrasives or may corrode plastic.

Ensure that no liquid enters the device.

The display surface of the device is sensitive to pressure and scratches. Clean it only using a soft, slightly moistened cloth.

The surface of the casing can be cleaned with a dry cloth. If particularly dirty, use a cloth that has been moistened in mild domestic detergent and then carefully wrung out.

## CE marking



The shipped version of this device complies with the requirements of EEC directives 2004/108/EC "Electromagnetic compatibility" and 2006/95/EC "Low voltage directive".

## Energy Star



The Fujitsu LCD colour monitor is equipped with a power management system which reduces the power draw in OFF mode to less than 1 W. As a result, the LCD monitor satisfies the requirements of the U.S. Environmental Protection Agency (EPA).

The EPA estimates that computer equipment uses approximately 5 % of all business electricity and that this is growing rapidly. If all desktop PCs and peripherals were to enter a low-power mode when not in use, the overall electricity saving could amount to \$ 2 billion annually. These savings could also prevent the emission of 20 million tons of carbon dioxide into the atmosphere - equivalent to the discharge from 5 million cars.

As an Energy Star Partner, Fujitsu Technology Solutions GmbH has determined that this product meets the Energy Star guidelines for energy efficiency.

## Disposal and recycling

This device has been manufactured as far as possible from materials which can be recycled or disposed of in such a way that the environment is not damaged. The device may be taken back after use to be reused or recycled, provided that it is returned in a condition that befits its intended use. Any components not reclaimed will be disposed of in an environmentally acceptable manner.

The device must be disposed of in accordance with local regulations for disposal of special waste. The screen background lighting contains mercury. You must observe the applicable handling and disposal safety regulations for fluorescent tubes.

If you have any questions regarding disposal, please contact your local sales office, our Help Desk, or:

Germany	Belgium	Switzerland
Fujitsu Technology Solutions GmbH Remarketing and Recycling D-33106 Paderborn Germany Tel.: +49 5251 / 81 80 10 Fax: +49 5251 / 81 80 15 <a href="http://ts.fujitsu.com/wvm">"http://ts.fujitsu.com/wvm"</a>	RECUPEL Boulevard Reyers, 80 B-1030 Brussels Tel.: +32 2 / 706 86 16 Fax: +32 2 / 706 86 13 E-mail: <a href="mailto:info@recupel.be">info@recupel.be</a> <a href="http://www.recupel.be">"http://www.recupel.be"</a>	SWICOSchweizerischer Wirtschaftsverband der Informations-, Kommunikations- und Organisationstechnik (Swiss Trade Association for Information, Communications and Organisational Technology). For a list of SWICO disposal sites, see: <a href="http://www.swico.ch">"http://www.swico.ch"</a>
Asia	USA	
Taiwan: Environmental Protection Administration Executive, Yuan, R.O.C. <a href="http://recycle.epa.gov.tw">"http://recycle.epa.gov.tw"</a>	Fujitsu America Inc. 1250E. Arques Avenue Sunnyvale, CA 94085 U.S.A. Contact: Bernd Henning Phone No.: (408) 329-6737 Fax No.: (408) 746-8299	

Information on this subject is also available on the Internet at ["http://ts.fujitsu.com/recycling"](http://ts.fujitsu.com/recycling).

# Getting started

## Unpacking and checking the delivery



The display surface of the device is sensitive to pressure and scratches. Always hold the device by the casing!

The complete device package includes:

- one monitor
- one data cable (D-SUB)
- one data cable (DVI-D)
- one audio cable
- one power cable
- one CD with software and documentation
- one Warranty Booklet
- one "Safety" manual

- ▶ Unpack all the individual parts.
- ▶ Check the contents of the package for any visible damage caused during transport.
- ▶ Check whether the delivery conforms to the details in the delivery note.
- ▶ Should you discover that the delivery does not correspond to the delivery note, notify your local sales outlet immediately.



Do not discard the original packing material of the devices. You may need the packaging in the future if you need to transport your device.

## Setting up the device



To ensure sufficient ventilation, the air inlet and outlet openings of the device must be kept clear.

## Setting up an ergonomic video workstation

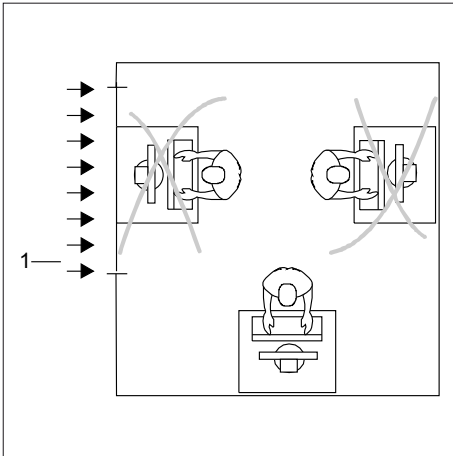

- ▶ Do not position the video workstation opposite a window (1).

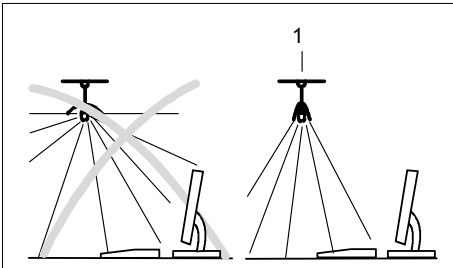

- ▶ Position the monitor outside the reach of a light source (1).



- ▶ Position the keyboard where it is easiest to reach (1).



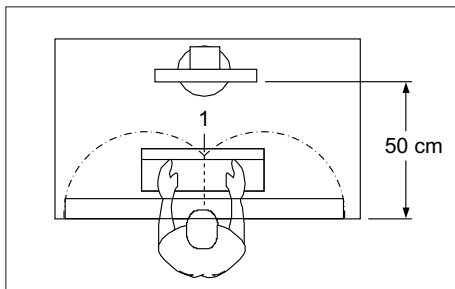

- Position the monitor so that the eye distance to the screen (1) is around 50 cm.

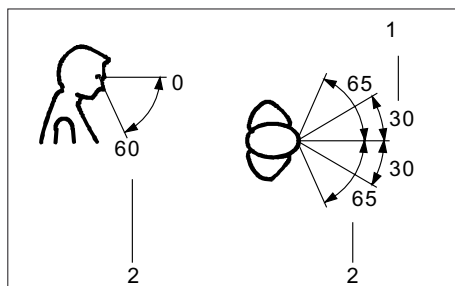

- Position the monitor for optimum viewing (1). The monitor should under no circumstances fall outside the permissible viewing space (2).



Depending on the situation, it may be advisable to use a swivel arm or wall bracket (VESA FPMPI), which are available from specialist dealers. For this purpose the monitor base must be removed beforehand as described in Chapter ["Removing monitor base", Page 11](#).

### Adjusting the height

The height of the monitor can be adjusted by approximately 120 mm.

- ▶ Grasp the monitor with both hands on the right and left edge of the casing and move it upward or downward.

### Adjusting the inclination

- ▶ Hold the monitor with both hands on the left and right sides of the casing and move it to the desired angle.

### Adjusting the rotation

The monitor can be horizontally rotated by  $\pm 45^\circ$  from its centre position.

- ▶ Grasp the monitor with both hands on the right and left edge of the casing and turn it to the desired position.

### Adjusting portrait format

The monitor can be rotated from horizontal format (landscape mode) into vertical format (portrait mode).

- ▶ Grasp the monitor with both hands on the right and left edge of the casing, move it into the highest position and turn it clockwise until it is in the portrait position.



For you to be able to display the screen contents in portrait mode, your graphics card will also need to support this function or you will need to use special software.

In the OSD menu you have the option of switching the OSD manually from landscape mode to portrait mode (see ["Changing the monitor settings using the OSD menu", Page 17](#)).

To reset the monitor to landscape mode, the monitor should be turned anti-clockwise. The OSD display can be reset again in the OSD menu.

## Removing monitor base

Before you can use a swivel arm or a wall bracket, you must remove the monitor base.



The display surface is susceptible to scratching!

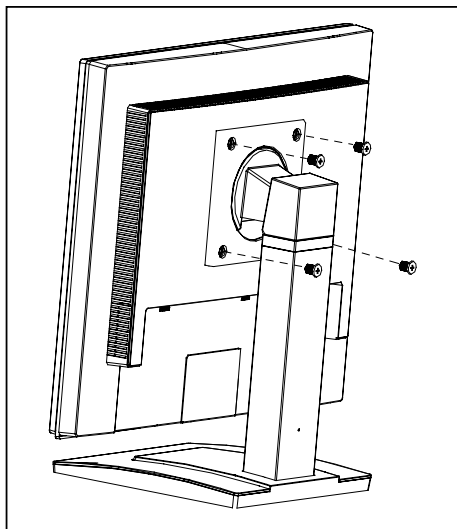

- ▶ Switch off the monitor and pull the power plug out of the power socket.
- ▶ Lay the monitor on its face on a soft surface.
- ▶ Remove all cables.
- ▶ To remove the monitor base, undo the screws on the monitor base.
- ↳ You can now mount a swivel arm or a wall bracket in accordance with VESA FPMPMI using a hole spacing of 100 mm.  
For instructions on how to mount the swivel arm or wall bracket, please see the documentation for the swivel arm or wall bracket.



For instructions on how to mount the swivel arm or wall bracket, please see the documentation for the swivel arm or wall bracket.

## Connecting the device



Please observe the safety information in ["Important notes", Page 3](#).  
CE conformance and optimum picture quality are guaranteed only if you use the data cables supplied.

- ▶ Switch off the monitor and the computer.
- ▶ Disconnect the power plug from the computer.

## Connecting cables to the monitor

The data cables supplied have two 15-pin D-SUB connectors or two 24-pin DVI connectors for connection to the monitor and to the computer.

Information on the computer connections and interfaces is contained in the operating manual for the computer.

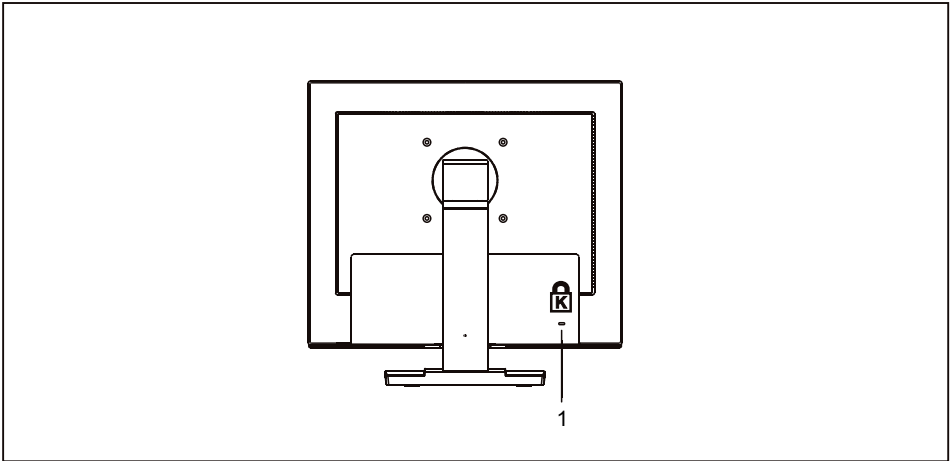

1 = Security slot for "Kensington Lock"

- ▶ Select the data cable which is suitable for your computer.

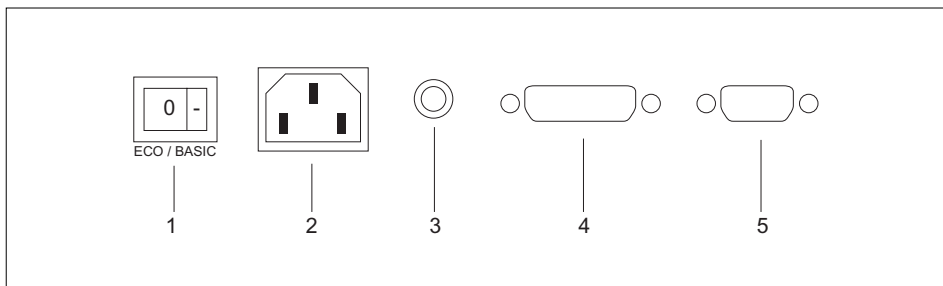

1 = Green standby mode switch

2 = Power connector

3 = AUDIO-IN socket

4 = DVI-D socket (DVI)

5 = D-SUB socket (VGA)

- ▶ Connect one of the connectors of the data cable to the D-SUB socket or DVI-D socket of the monitor and secure the plug-in connection by tightening the safety screws.



The monitor automatically detects the input when only one signal source is connected.

- ▶ Insert one plug of the audio line in the AUDIO IN socket on the monitor and make sure it is properly engaged.
- ▶ Plug the power cable supplied into the power connector of the monitor.
- ▶ Secure the cover over the connections.



A lock (Kensington Lock) can be mounted in the security slot to protect the monitor from theft. A Kensington Lock is not included with the monitor at delivery.

## Connecting cables to the computer

Information on the computer connections and interfaces is contained in the operating manual for your computer.

- ▶ Connect the data cable to the (active) monitor port on the computer and secure the plug-in connection by tightening the safety screws.
- ▶ Insert the other plug of the audio cable in the audio output of the computer.
- ▶ Plug the power connector of the monitor into a properly grounded mains outlet.
- ▶ Plug the power connector of the computer into a properly grounded mains outlet.



If your computer has two monitor ports ("onboard" screen controller and separate graphics card), the monitor port for the separate graphics card is active as standard.

# Operation

## Switching the device on and off

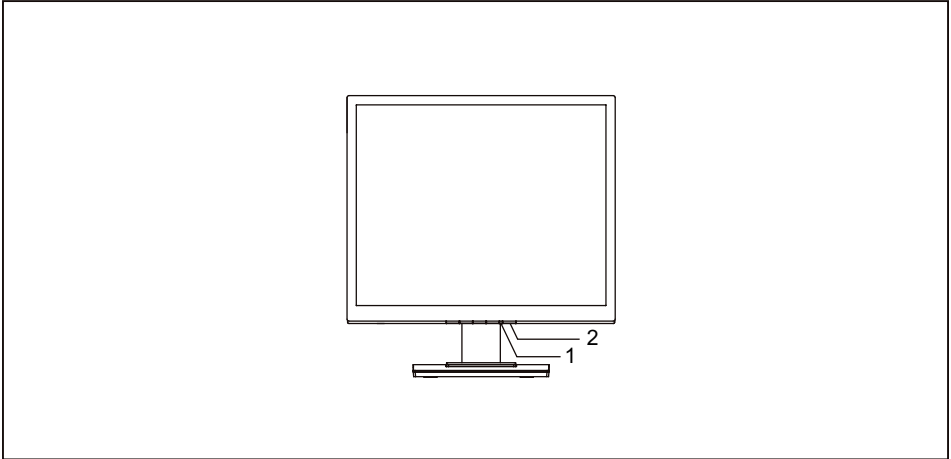

1 = Power supply indicator

2 = ON/OFF switch



Press the buttons from the bottom up.

The colour of the LED indicator changes as follows:

LED indicator	Status
blue	Monitor and computer are switched on (normal mode).
green	Monitor and computer are switched on (ECO mode).
orange	The monitor is not receiving a video signal or is in energy-saving mode.
does not light up	The monitor is switched off (or is in green standby mode - power consumption in standby and off mode $\leq 0.1W$ )

Front	Rear
1 = power indicator	3 = green standby mode switch
2 = ON/OFF switch	



In switch position "0" (ECO), green standby mode is activated, in which the monitor consumes  $\leq 0.1$  W. If the monitor cannot be switched on and remains dark, the switch must be set to "-" (BASIC). The monitor then consumes  $< 1$  W in standby mode.

- Switch the device on using the ON/OFF switch.



Only switch on the computer after you have switched on the monitor.

## Notes on power management

If your computer is equipped with power management (power-saving mode), the monitor can fully support this function. Here the monitor does not distinguish between the individual energy-saving modes of the computer (standby mode, suspend mode and OFF mode), as it is capable of immediately switching into the mode with the highest energy-saving effect.

Stage	Operation		Power saving mode	
	Normal	ECO	Green Standby Mode	Compatible
Power supply indicator	Lights up blue	Lights up green	unlit	Lights up orange
Monitor	Max. brightness	typ. 200 cd/m <sup>2</sup>	Unlit	Unlit
Power consumption (typical)	B17-5 : $< 24$ W B19-5 : $< 28$ W	B17-5 : $< 17$ W B19-5 : $< 19$ W	reduced to $\leq 0.1$ W	reduced to $< 1$ W

If your computer detects inactivity (no input), it sends an appropriate signal to the monitor to reduce the power consumption (energy-saving mode). The power indicator of the monitor changes colour to indicate the status change. ECO and Green Standby Mode are the preset factory defaults.

Once an input is made at the computer the screen contents are restored.



For detailed information on how energy-saving mode operates, please refer to the operating manual or technical manual of the computer.

## Changing the monitor settings

When putting the monitor into operation for the first time, the screen display should be optimally adapted to the display adapter used.

### Changing the monitor settings with the buttons of the control panel



The buttons of the control panel have two functions. With the OSD menu not activated, you can make the following settings directly:

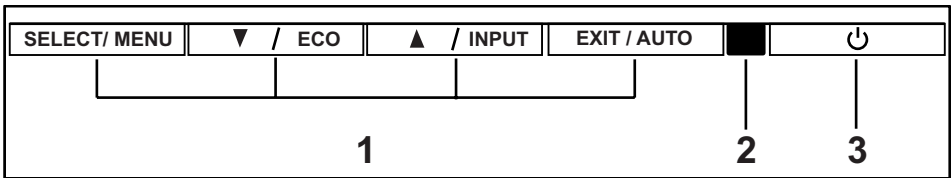

- 1 = Buttons for the OSD menu (On-Screen Display)
- 2 = Power supply indicator
- 3 = ON/OFF switch

### Performing auto-adjustment of the monitor

- ▶ Press the **EXIT / AUTO** button for about 1 second.
- ↳ The *Auto Processing* message appears  
Picture quality and position are set to optimum values for your system.

### Selecting input signal (D-SUB/DVI-D)

- ▶ Press the Back / **INPUT** button to open the *Input select* setting window.
- ▶ Press the Forwards / ECO button or the Back / **INPUT** button to select the desired monitor connection (VGA or DVI).



This setting window can also be called when the OSD menu is locked.



## Activate/deactivate ECO operating mode



The power consumption of the device can be decreased by reducing the brightness of the picture.

- ▶ Press the Forwards / ECO button to switch the ECO operating mode on or off.
  - ↳ The message *ECO on / off* is displayed.
- If the ECO operating mode is activated, the following OSD settings are changed:

<i>Colour</i>	6500K
<i>temperature</i>	
<i>Brightness</i>	reduced

After the ECO operating mode is switched off, the brightness previously set by the user is restored.

## Locking the OSD menu

The OSD menu can be locked to prevent accidental or unauthorised changes to the monitor settings.

- ▶ Press and keep the **SELECT/MENU** button pressed for a few seconds while you switch on the monitor with the ON/OFF switch.
- ↳ The message *OSD locked / unlocked* is displayed.



Proceed in the same way to release the locked OSD menu again.

## Locking the ON/OFF button

The ON/OFF switch can be locked to prevent accidental or unauthorised changes to the monitor settings.

- ▶ Press the Forwards / ECO button and the Back / **INPUT** button at the same time and keep them pressed for a few seconds.
- ↳ The message *Power button locked / unlocked* is displayed.



Proceed in the same way to release the locked ON/OFF switch again.

## Changing the monitor settings using the OSD menu

With the buttons on the control panel, you can call up and use the integrated OSD (On-Screen Display) menu.



The OSD menu is available in various languages. The English menu names are used in the following description (default setting). You can select another language using the *OSD Language* function in the *OSD Setup* menu.

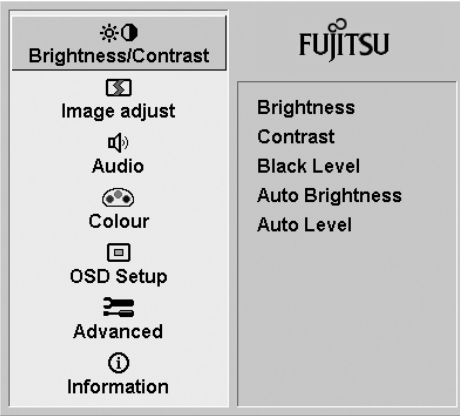

- ▶ Press the **[SELECT/MENU]** button to activate the OSD menu.
- ↳ The main menu appears, with icons for the setting functions.  
The first icon, (*Brightness/Contrast*), is highlighted and the associated functions are visible in the right-hand menu field.

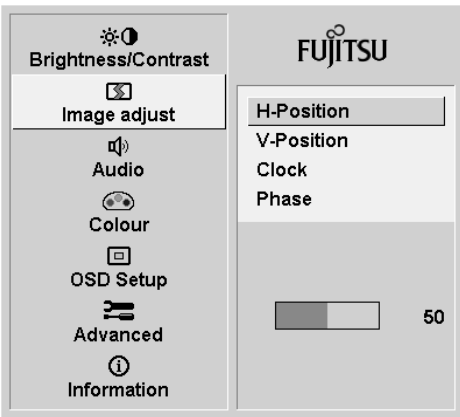

- ▶ Press the **Forwards / ECO** button or the **Back / [INPUT]** button to highlight another icon (e.g. *Image adjust*).
- ▶ Press the **[SELECT/MENU]** button to select the highlighted icon.
- ↳ The *Image adjust* setup window will be displayed.
- ▶ Press the **Forwards / ECO** button or the **Back / [INPUT]** button to highlight another function.
- ▶ Press the **[SELECT/MENU]** button to select the highlighted function.
- ▶ Press the **Forwards / ECO** button or the **Back / [INPUT]** button to highlight another function.
- ▶ Press the **[EXIT / AUTO]** button to exit the function.
- ▶ Press the **Forwards / ECO** button or the **Back / [INPUT]** button to highlight another function or press the **[EXIT / AUTO]** button to return to the main menu.
- ↳ All changes are stored automatically.



If you wish to change other settings, select the corresponding function from the OSD main menu. All possible adjustments of the main menu are described below.

## OSD menu functions



The OSD menu for analog monitor operation is described below. During digital operation some functions are not available, as they are not required due to the digital transmission technology used.

## Adjusting the brightness and contrast

	Call up the <i>Brightness/Contrast</i> setting window
<i>Brightness</i>	Set the brightness of the display With this function you change the brightness of the background lighting. You can see whether the ECO operating mode is active under the bar for displaying the brightness setting.
<i>Contrast</i>	Set the contrast of the display With this function you modify the contrast of bright colour tones.
<i>Black level</i>	Set the brightness of the display With this function you modify the contrast of dark colour tones.
<i>Auto level</i>	Adjust the signal level With this function you can automatically set the contrast. The function is executed with the <input type="button" value="SELECT / MENU"/> button.



If the contrast is set too high, bright surfaces can no longer be distinguished from very bright surfaces. If the contrast is set too low, the maximum brightness will not be achieved.

## Adjusting the picture size and position

	Open the <i>Image adjust</i> window
<i>H-position</i>	Adjusting the horizontal position With this function you can move the picture to the left or to the right.
<i>V-position</i>	Adjusting the vertical position With this function you can move the picture up or down.
<i>Clock</i>	Adjusting the synchronisation With this function you can adjust the picture width in order to eliminate vertical picture faults.
<i>Phase</i>	Eliminating picture faults With this function you fine-tune your monitor to eliminate picture faults.
<i>Sharpness</i>	Adjusting the picture sharpness This function is used to adjust the picture sharpness.

## Adjusting the volume

	Call the <i>Audio</i> setting window
<i>Volume</i>	Set the volume for playback with the integrated loudspeakers
<i>Mute</i>	Switch the loudspeakers off or on

## Setting the colour temperature and colours

	Call the <i>Colour</i> setting window
	Select the colour temperature The "warmth" of the screen colours is set using the colour temperature. The colour temperature is measured in Kelvin (K). You can choose between <i>sRGB</i> , <i>6500 K</i> , <i>7500 K</i> , <i>9300 K</i> , <i>Native</i> and <i>Custom Colour</i> . In the user-defined setting you can change the colour ratios of the basic colours (red, green, blue) as required.

## Adjusting the display of the OSD menu

	Calling the <i>OSD Setup</i> adjustment window
<i>Language</i>	Selecting the language for the OSD menu With this function you choose between English (default setting), French, German, Italian and Spanish as the language for the OSD menu.
<i>OSDH position</i>	Setting the horizontal position of the OSD menu With this function you can move the OSD menu to the left or to the right.
<i>OSDV position</i>	Setting the vertical position of the OSD menu With this function you can move the OSD menu up or down.
<i>OSDTimeout</i>	Setting the display duration of the OSD menu With this function you can select a value from 10 to 120 seconds. If the set time expires without a setting being made, the OSD menu is automatically hidden.
<i>OSD Rotation</i>	With this function you switch the OSD menu from portrait mode to landscape mode and vice versa. Off = The OSD menu is displayed in portrait mode. On = The OSD menu is displayed in landscape mode.

## Setting functions in the Advanced menu

	Call up the <i>Advanced</i> setting window
<i>Input select</i>	Selecting the input signal This function allows you to switch the monitor from analogue to digital mode and vice versa, when two signal sources are connected. This is on condition that the graphic card supports this function.
<i>DDC-CI</i>	Activation/deactivation of the DDC-CI <i>On</i> = The DDC-CI function is enabled (standard setting) <i>Off</i> = The DDC-CI function is disabled
<i>Factory Recall</i>	Activating the factory settings With this function all settings are reset to the factory settings without prompting for confirmation. Press the <b>[SELECT/MENU]</b> button to activate the function. The <i>Auto Processing</i> message is displayed.

## Displaying information

	<p>Call the <i>Information</i> setting window</p> <p>With this function the model designation, serial number, resolution, H/V frequency, input signal and polarity of the synchronisation signal are displayed.</p>
--	---

# Troubleshooting

Should an error occur, first check the following points. If the distortion is still not eliminated, the monitor should, if possible, be checked on another computer.

If you are unable to solve the problem, please inform our help desk.

Having this problem?	Check the following points:
No screen display Power indicator does not light up	<ul style="list-style-type: none"> <li>▶ Check whether the main switch at the rear of the monitor is switched on.</li> <li>▶ Check whether the power cable on the monitor is connected correctly.</li> <li>▶ Check whether the computer is switched on.</li> </ul>
No screen display Power indicator is lit	<ul style="list-style-type: none"> <li>▶ Check whether the computer is switched on.</li> <li>▶ Check whether the data cable for the monitor is correctly attached to the monitor port on the computer.</li> <li>▶ Press any key on the computer keyboard. The computer may be in power saving mode.</li> <li>▶ Alter the brightness and/or contrast until you get a picture.</li> </ul>
Message: No Signal	<ul style="list-style-type: none"> <li>▶ Check whether the data cable for the monitor is correctly attached to the monitor port on the computer.</li> <li>▶ Check whether the computer is switched on.</li> </ul>
Message: Frequency out of range:## kHz / ## Hz Please change the display mode to 1280 x 1024 with 60 Hz	<p>The input signal (horizontal frequency and refresh rate) at the displayed input does not correspond to the technical data for the monitor.</p> <ul style="list-style-type: none"> <li>▶ Adjust the video frequency range using the computer software (see documentation for the computer or display adapter).</li> <li>▶ Set a different screen resolution using the computer software (see documentation for the computer or display adapter).</li> </ul>
Picture position not correct	<p>The monitor recognises an undefined mode (see chapter <a href="#">"Technical specification", Page 26</a>).</p> <ul style="list-style-type: none"> <li>▶ Press the <b>[EXIT / AUTO]</b> button to perform auto-adjustment of the screen.</li> </ul>
Picture is shaking	<ul style="list-style-type: none"> <li>▶ Check whether the data cable for the monitor is correctly attached to the monitor port on the computer.</li> <li>▶ Press the <b>[EXIT / AUTO]</b> button to perform auto-adjustment of the screen.</li> </ul>
Picture is wrongly adjusted	<ul style="list-style-type: none"> <li>▶ Press the <b>[SELECT / MENU]</b> button to activate the <i>Factory Recall</i> function.</li> </ul> <p>The <i>Auto Processing</i> message appears.</p>

<b>Having this problem?</b>	<b>Check the following points:</b>
Picture disturbances (vertical lines)	▶ Press the [EXIT / AUTO] button to perform auto-adjustment of the screen.
Picture disturbances (horizontal lines, picture noise)	▶ Press the [EXIT / AUTO] button to perform auto-adjustment of the screen.
The screen becomes darker	The background lighting has a limited lifetime. If your monitor display should become too dark, the background lighting will have to be replaced. ▶ Please contact our help desk.



# Notes regarding the DIN EN ISO 13406-2 standard

## Permanently unlit or lit pixels

The standard of production techniques today cannot guarantee an absolutely fault-free screen display. A few isolated constant lit or unlit pixels (picture elements) may be present. The maximum permitted number of pixels faults is stipulated in the international standard ISO 13406-2 (Class II).

Examples:

Example: A 17"/19" flat-screen monitor with a resolution of 1280 x 1024 has 1280 x 1024 = 1310720 pixels. Each pixel consists of three subpixels (red, green and blue), so there are almost 4 million subpixels (dots) in total. In accordance with ISO 13406-2 (Class II), a maximum of 6 pixels and also 7 subpixels may be faulty.

# Technical specification



Condensation is not permitted, neither in the rated range of operation nor in the limit range of operation.

		<b>B17-5 ECO</b>	<b>B19-5 ECO</b>
<b>Dimensions and weight</b>			
Visible diagonals		43 cm	48 cm
Dot pitch		0.264 mm	0.294 mm
Image size	Width	337.9 mm	376.3 mm
	Height	270.3 mm	301 mm
Maximum resolution		1280 x 1024	1280 x 1024
Dimensions incl. monitor base	Width	373 mm	412 mm
	Height	405 mm	409 mm
	Depth	209 mm	209 mm
Dimensions of box	Width	453 mm	453 mm
	Height	436 mm	464 mm
	Depth	212 mm	212 mm
Weight (without packaging)		approx. 5.2 kg	approx. 5.9 kg
Storable display modes		28	28
Pixel error classes according to ISO 13406-2	Class	II	II
<b>Accessories</b>		Power cable (1.8 m)	
		D-SUB data cable (1.8 m)	
		DVI-D data cable (1.8 m)	
		Audio cable (1.8 m)	
<b>Electrical data</b>			
Video	Analogue	positive, 0.7 V <sub>SS</sub> , 75 Ω	
	Digital	DVI-D	
Synchronisation		Separate Sync. TTL, positive or negative	
Horizontal frequency		30 kHz .... 83 kHz (multi-scanning)	
Refresh rate		55 Hz .... 76 Hz	
Max. pixel rate		165 MHz	
Power supply		switches automatically 100 V – 240 V, 50 Hz – 60 Hz	
Total power consumption	Normal operation	< 24 W in normal operation (17") < 28 W in normal operation (19")	
	Energy saving mode	≤ 0.1 W in Green Standby Mode	
Max. sound output		1.0 W left; 1.0 W right	

### Environmental conditions

Environment class 3K2, DIN IEC 721

Rated range of operation	15 °C .... 35 °C
Humidity	20 % .... 85 %
Limit range of operation	5 °C .... 35 °C
Humidity	20 % .... 85 %

## VESA-DDC-compatible VGA interface

Your monitor is equipped with a VESA-DDC-compatible VGA interface. VESA-DDC (Video Electronics Standard Association, Display Data Channel) is used as the communications interface between the monitor and the computer. If the computer is equipped with a VESA-DDC-compatible VGA interface, it can automatically read the data for ensuring optimum operation from the monitor and select the appropriate settings.

## Preset operating modes



The picture position and size have been optimised at the factory for the operating modes listed above. Depending on the graphics card used, it may be necessary to adjust the display position or size. In this case you can change and save the settings (see chapter "[Changing the monitor settings](#)", [Page 16](#)).

## Most frequent operating modes

Horizontal frequency	Refresh rate	Screen resolution
31.5 kHz	70 Hz	720 x 400
31.5 kHz	60 Hz	640 x 480
37.5 kHz	75 Hz	640 x 480
37.9 kHz	60 Hz	800 x 600
46.9 kHz	75 Hz	800 x 600
48.4 kHz	60 Hz	1024 x 768
60.0 kHz	75 Hz	1024 x 768
64.0 kHz	60 Hz	1280 x 1024
79.9 kHz	75 Hz	1280 x 1024

For ergonomic reasons, a screen resolution of 1280 x 1024 pixels is recommended. Because of the technology used (active matrix), an LCD monitor provides a totally flicker-free picture, even with a refresh rate of 60 Hz.

## SUB D port

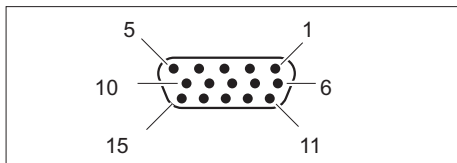

Pin	Meaning
1	Video input red
2	Video input green
3	Video input blue
4	Ground
5	Ground
6	Video ground red
7	Video ground green
8	Video ground blue
9	+5 V (DDC)
10	Sync. ground
11	Ground
12	DDC Data
13	H. sync
14	V. sync
15	DDC Clock

## DVI-D port

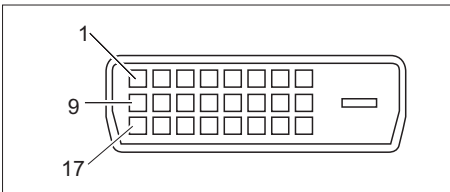

Pin	Meaning
1	TMDS Data2-
2	TMDS Data2+
3	TMDS Data 2/4 Shield
4	not connected
5	not connected
6	DDC Clock
7	DDC Data
8	Analog Vertical Sync
9	TMDS Data1-
10	TMDS Data1+
11	TMDS Data 1/3 Shield
12	not connected
13	not connected
14	+5V Power
15	Earth
16	Hot Plug Detect
17	TMDS Data0-
18	TMDS Data0+
19	TMDS Data 0/5 Shield
20	not connected
21	not connected
22	TMDS Clock Shield
23	TMDS Clock+
24	TMDS Clock-

## Free Manuals Download Website

<http://myh66.com>

<http://usermanuals.us>

<http://www.somanuals.com>

<http://www.4manuals.cc>

<http://www.manual-lib.com>

<http://www.404manual.com>

<http://www.luxmanual.com>

<http://aubethermostatmanual.com>

Golf course search by state

<http://golfingnear.com>

Email search by domain

<http://emailbydomain.com>

Auto manuals search

<http://auto.somanuals.com>

TV manuals search

<http://tv.somanuals.com>