

Quick Start Guide for FUJITSU DL7400 Printer

User's Manual

The User's Manual is provided as an Adobe® Acrobat® PDF file on the CD shipped with your printer. It requires Adobe Acrobat Reader for viewing. To view the User's Manual, access it from the DL7400 User's Manual line folder on the CD and double-click on the file name. If you do not have Adobe Acrobat Reader, it is available for downloading from the Adobe web site, www.adobe.com.

Unpacking the printer

Please confirm that the following things are enclosed

- Printer (1)
- Black ribbon cartridge (1)
- Power cord (1)
- Setup disk (1)
- This guide (1)

Setting up

Open the carton and pull the printer and its components out. Remove the tapes and cushions securing the printer.

1. Setting the paper table

Turn the paper table (1) as shown in the table below, then push it (2) and set it (3).

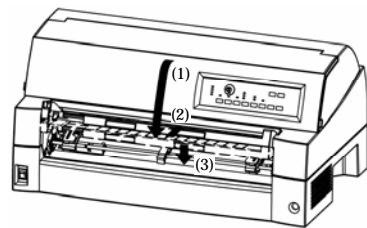

The complete setup conditions are shown below. Make sure that the top end of the paper table is engaged with the printer guide pin and the guide pin on the paper table is inserted into the cover groove.

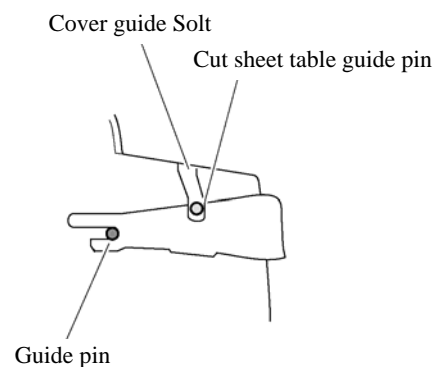

2. Open the front cover and remove the shipping restraint cardboard that holds the print head carriage in place (shown below).

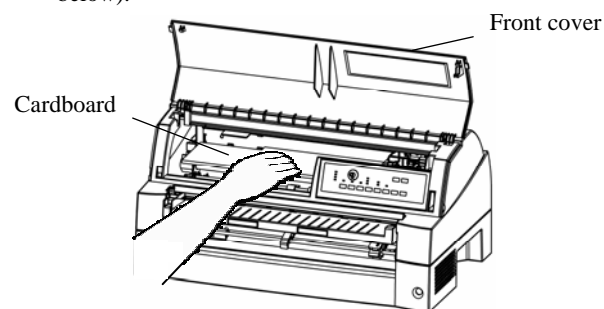

3. Installing the Ribbon Cartridge.

Release the ribbon cartridge from its package and push in the gray ribbon release tabs on the side, and slide the roller from the LOCK position to the FREE position.

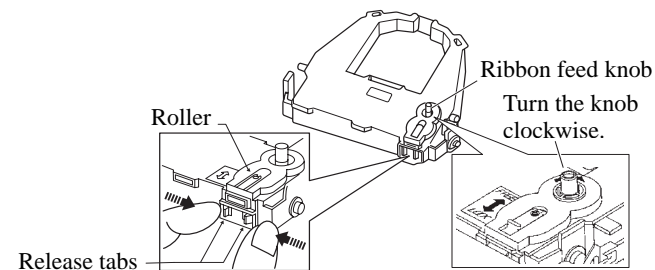

Thread the ribbon between the print head and the print guide, then gently press down on the ribbon cartridge against the printer until it clicks into place.

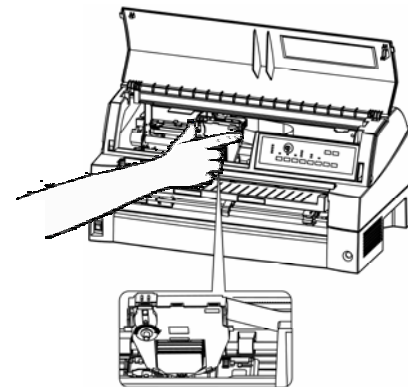

4. Connecting the interface cable

Attach the interface cable to the connector.

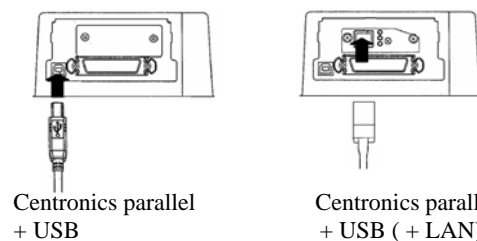
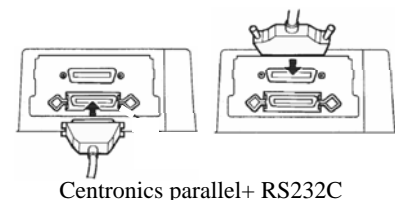

* The LAN interface is a user add-on option.

5. Plug one end of the power cord into the power connector on the rear of the printer.

Plug the other end of the power cord into the power outlet.

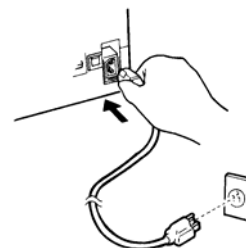

Paper handling

• Adjusting for paper thickness

You can use the MANUAL GAP DIAL to adjust the paper thickness manually at manual mode. Refer to "Manual Gap Dial Settings" of the manual before it adjusts.

• Loading single sheets

1. Make sure that the printer is turned on. Press the PAPER PATH button to select CUT SHEET.
2. Adjust the left margin. Push the lock lever down to secure the guide.
3. Pull the sub guide out as required to accommodate the paper size.

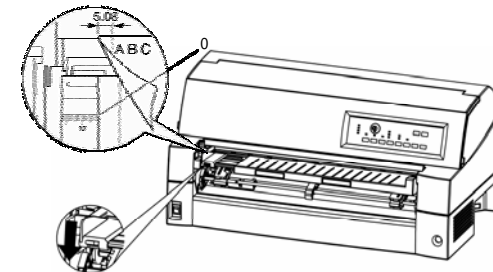

4. Insert a sheet of paper into the paper table. Make sure that the front edge of the paper engages snugly with the feed roller.
5. Press the LOAD button. The paper will advance to the top-of-form position. The top-of-form position is the first line on which printing can start. To adjust the position of the paper slightly, press the ▲ MICRO FEED button or the ▼ MICRO FEED button.

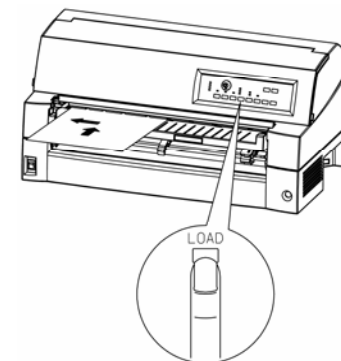

• Loading Continuous Forms (Front Feed)

1. Make sure that the printer is turned on. Remove any single-sheet paper from the printer.
2. Lift up the paper table as shown below.
3. Release the tractor locking levers by pulling them up. Open the tractor paper holders. See the following figure.

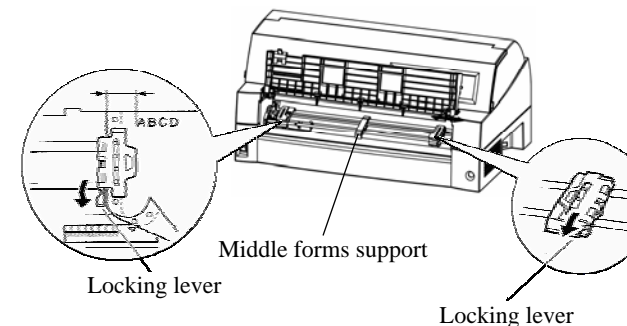

4. Position the left tractor. Push the left locking lever down to secure the tractor. Center the middle forms support.
5. Adjust the left margin.
6. Fit the paper feed holes onto the left and right tractor pins. Adjust the right tractor to the width of the form. Close the paper holders.

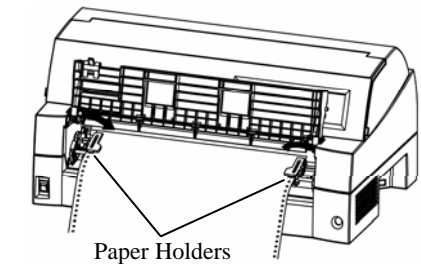

7. Pull the right tractor to stretch the paper taut. Push the right locking lever down to secure the tractor in place.
8. Lower the paper table to the down position (normal mode).

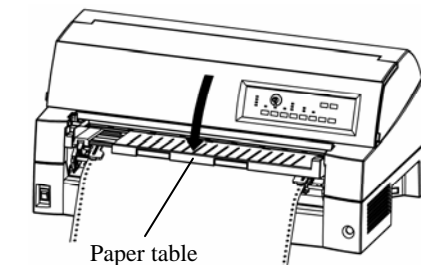

9. Press the PAPER PATH button to select TRACTOR F.
10. Press the LOAD button to load the paper to the top-of-form position. Top-of-form is the first line on which printing can start. After loading paper, the printer goes into online mode.

* Rear feed : Please refer to the chapter of "Paper Handling" of the user's manual.

Installing the printer driver

A printer driver is required to use the printer in a Windows environment. Special printer drivers for Windows 95, 98, Me, NT 4.0, 2000, XP, and 2003 are provided with the DL7400 printer. For information on how to install printer drivers, refer to the Readme.txt file for the printer driver to be installed.

- These printer drivers run with DPL24C+ emulation. Be sure to specify DPL24C+ emulation for the printer mode.
- The DL7400 printer driver is a printer driver for monochrome printing.

Use the following procedure to install the DL MENU.

1. Create an appropriate folder in the hard disk and copy to it all of the files in the DL MENU folder (DLMENU.EXE, DLMENU.HLP, DLMENU.CNT).

NOTE: A disk capacity of 500KB is required to install the DL MENU.

2. Start by double clicking the DLMENU.EXE file or by specifying the DLMENU.EXE file from "Start" > "Run".

Free Manuals Download Website

<http://myh66.com>

<http://usermanuals.us>

<http://www.somanuals.com>

<http://www.4manuals.cc>

<http://www.manual-lib.com>

<http://www.404manual.com>

<http://www.luxmanual.com>

<http://aubethermostatmanual.com>

Golf course search by state

<http://golfingnear.com>

Email search by domain

<http://emailbydomain.com>

Auto manuals search

<http://auto.somanuals.com>

TV manuals search

<http://tv.somanuals.com>