

FUJITSU Server

PRIMEQUEST 2000 Series

REMCS Installation Manual



Preface

This manual describes the functions and features of the PRIMEQUEST 2000 series. The manual is intended for system administrators.

For details on the regulatory compliance statements and safety precautions, see the *PRIMEQUEST 2000 Series Safety and Regulatory Information* (C122-E171XA).

Errata and addenda for the manual

The *PRIMEQUEST 2000 Series Errata and Addenda* (C122-E182EN) provides errata and addenda for the manual. Read the *PRIMEQUEST 2000 Series Errata and Addenda* (C122-E182EN) thoroughly in reference to the manual.

Organization of this manual

This manual is organized as follows.

[CHAPTER 1 REMCS Service Overview](#)

Chapter 1 provides an overview of the REMCS service.

[CHAPTER 2 Before Using the REMCS Service](#)

Chapter 2 describes the connection to the REMCS center, which is required during use of the REMCS service.

[CHAPTER 3 REMCS Service Start Procedure](#)

Chapter 3 describes the procedure for starting the REMCS service.

[CHAPTER 4 REMCS Service Operations](#)

Chapter 4 describes the operating procedures for the REMCS service.

[CHAPTER 5 CHAPTER 5 REMCS Service Detail Settings](#)

Chapter 5 describes the detail settings of the REMCS service.

[CHAPTER 6 REMCS Messages](#)

Chapter 6 describes the major error messages displayed in the window.

[CHAPTER 7 MMB Log Collection](#)

Chapter 7 describes MMB log collection.

[CHAPTER 8 Notes on Using REMCS GUI](#)

Chapter 8 describes the notes on using the REMCS GUI.

Revision History

Edition	Date	Revised location (type) (*1)	Description
01	2014-02-18	-	-

1: Chapter, section, and item numbers in the "Revised location" column refer to those in the latest edition of the document. However, a number marked with an asterisk () denotes a chapter, section, or item in a previous edition of the document.

Product operating environment

This product is a computer intended for use in a computer room environment. For details on the product operating environment, see the following manual:

PRIMEQUEST 2000 Series Hardware Installation Manual (C122-H007EN)

Safety Precautions

Alert messages

This manual uses the following alert messages to prevent users and bystanders from being injured and to prevent property damage.



This indicates a hazardous (potentially dangerous) situation that is likely to result in death or serious personal injury if the user does not perform the procedure correctly.



This indicates a hazardous situation that could result in minor or moderate personal injury if the user does not perform the procedure correctly. This also indicates that damage to the product or other property may occur if the user does not perform the procedure correctly.

Important

This indicates information that could help the user use the product more efficiently.

Alert messages in the text

An alert statement follows an alert symbol. An alert statement is indented on both ends to distinguish it from regular text. Similarly, one space line is inserted before and after the alert statement.



Only Fujitsu certified service engineers should perform the following tasks on this product and the options provided by Fujitsu. Customers must not perform these tasks under any circumstances. Otherwise, electric shock, injury, or fire may result.

- Newly installing or moving equipment
- Removing the front, rear, and side covers
- Installing and removing built-in options
- Connecting and disconnecting external interface cables
- Maintenance (repair and periodic diagnosis and maintenance)

The List of important alert items table lists important alert items.

List of important alert items

This manual does not contain important alert items.

Warning labels



Never remove the warning labels.

Warning label location (the main cabinet top)

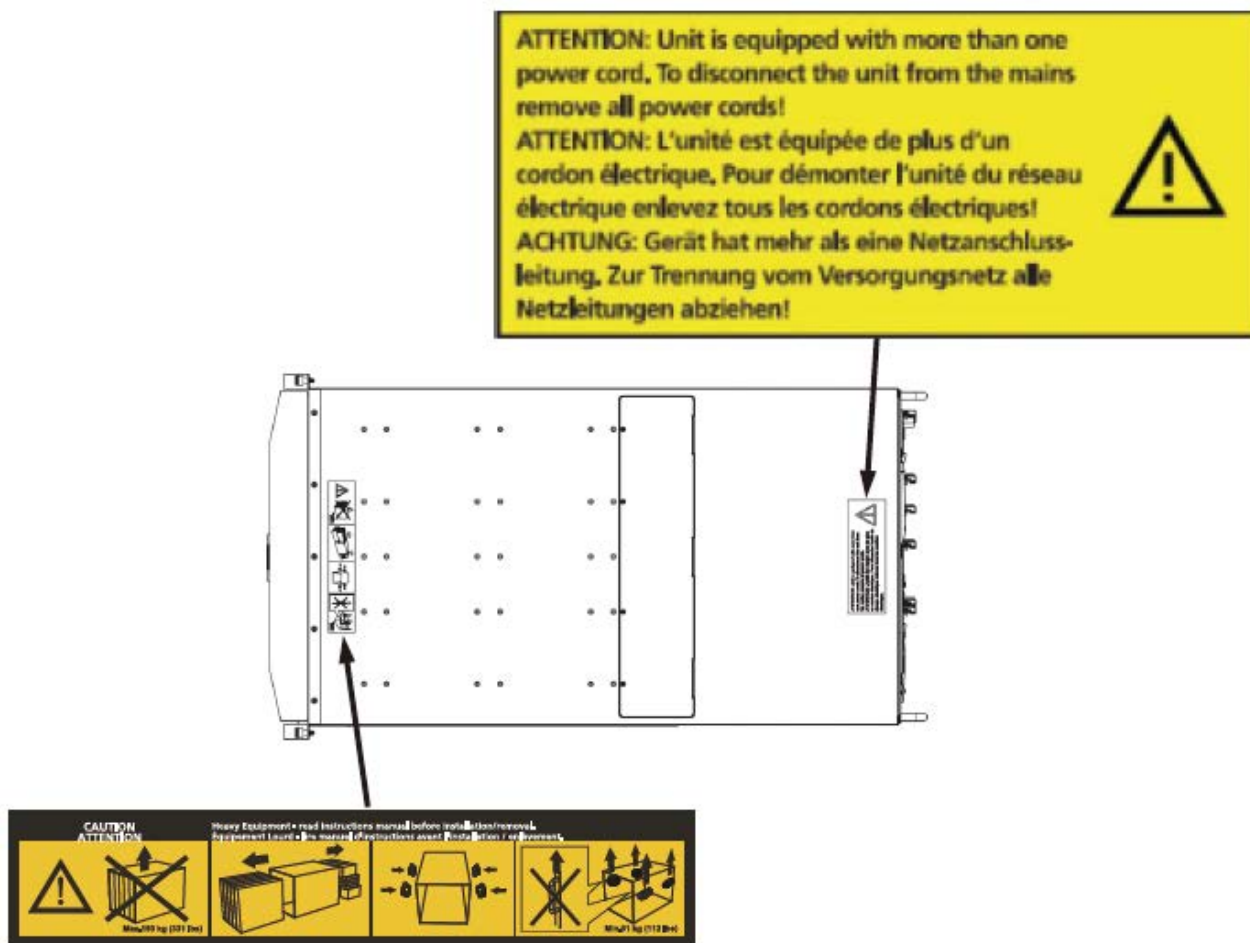

Warning label location (the main cabinet left)

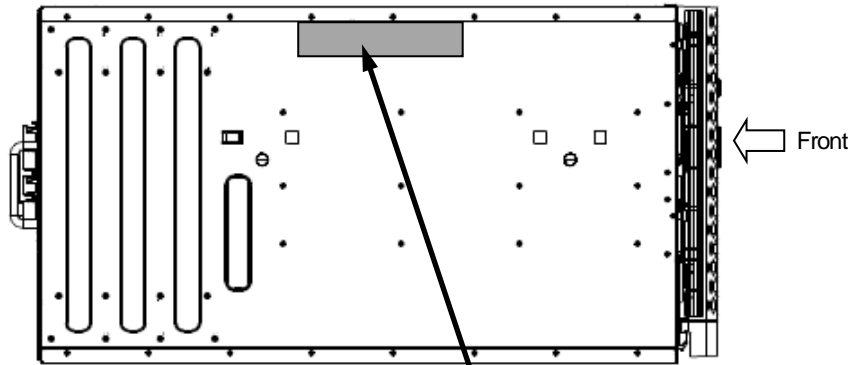

<p>⚠️ ⚠️ 注意 CAUTION ATTENTION 感電 触电 内部には高電圧部分があり、感電する恐れがあります。保守担当者以外の方は内部に触れないでください。 HAZARDOUS VOLTAGE. SERVICE ENGINEER ONLY TOUCH THE INSIDE. 装置内有高电压部分,有引起触电的危险。除保养担当者之外,请勿触摸装置内部。 TENSIONS DANGEREUSES. SEUL UN INGÉNIEUR PEUT VÉRIFIER L'INTÉRIEUR.</p>	<p>注意 CAUTION ATTENTION 本機器を搭載する前に、設置マニュアルを見てください。 SEE INSTALLATION INSTRUCTIONS BEFORE INSTALLING THIS UNIT. 请务必先阅读本装置安装手册之后,再进行机器的安装。 VOIR LE MANUEL D'INSTRUCTIONS AVANT D'INSTALLER CET UNITÉ.</p>	<p>⚠️ 注意 CAUTION ATTENTION 保守時は静電気を除去すること。 ELECTROSTATIC SENSITIVE DEVICES. 维护保养时必须采取防静电措施。 CIRCUITS SENSIBLES A L'ELECTRICITÉ STATIQUE.</p>
---	---	---

Warning label location (PCI_Box)

<p>⚠️ 注意 CAUTION 本機器を搭載する前に、設置マニュアルを見てください。 请务必先阅读本装置安装手册之后,再进行机器的安装。 SEE INSTALLATION INSTRUCTIONS BEFORE INSTALLING THIS UNIT.</p>	<table border="1"> <tr> <td data-bbox="518 1120 925 1265"> <p>⚠️ 注意 CAUTION 感電 触电 内部には高電圧部分があり、感電する恐れがあります。保守担当者以外の方は内部に触れないでください。 HAZARDOUS VOLTAGE. SERVICE ENGINEER ONLY TOUCH THE INSIDE. 装置内有高电压部分,有引起触电的危险。除保养担当者之外,请勿触摸装置内部。 TENSIONS DANGEREUSES. SEUL UN INGÉNIEUR PEUT VÉRIFIER L'INTÉRIEUR.</p> </td> <td data-bbox="925 1120 1356 1265"> <p>⚠️ 注意 CAUTION 本機器を搭載する前に、設置マニュアルを見てください。 请务必先阅读本装置安装手册之后,再进行机器的安装。 SEE INSTALLATION INSTRUCTIONS BEFORE INSTALLING THIS UNIT.</p> </td> </tr> <tr> <td data-bbox="518 1265 925 1411"> <p>⚠️ 注意 CAUTION 保守時は静電気を除去すること。 ELECTROSTATIC SENSITIVE DEVICES. 维护保养时必须采取防静电措施。</p> </td> <td data-bbox="925 1265 1356 1411"> <p>⚠️ 注意 CAUTION 内部には高電圧部分があり、感電する恐れがあります。保守担当者以外の方は内部に触れないでください。 HAZARDOUS VOLTAGE. SERVICE ENGINEER ONLY TOUCH THE INSIDE. 装置内有高电压部分,有引起触电的危险。除保养担当者之外,请勿触摸装置内部。 TENSIONS DANGEREUSES. SEUL UN INGÉNIEUR PEUT VÉRIFIER L'INTÉRIEUR.</p> </td> </tr> </table>	<p>⚠️ 注意 CAUTION 感電 触电 内部には高電圧部分があり、感電する恐れがあります。保守担当者以外の方は内部に触れないでください。 HAZARDOUS VOLTAGE. SERVICE ENGINEER ONLY TOUCH THE INSIDE. 装置内有高电压部分,有引起触电的危险。除保养担当者之外,请勿触摸装置内部。 TENSIONS DANGEREUSES. SEUL UN INGÉNIEUR PEUT VÉRIFIER L'INTÉRIEUR.</p>	<p>⚠️ 注意 CAUTION 本機器を搭載する前に、設置マニュアルを見てください。 请务必先阅读本装置安装手册之后,再进行机器的安装。 SEE INSTALLATION INSTRUCTIONS BEFORE INSTALLING THIS UNIT.</p>	<p>⚠️ 注意 CAUTION 保守時は静電気を除去すること。 ELECTROSTATIC SENSITIVE DEVICES. 维护保养时必须采取防静电措施。</p>	<p>⚠️ 注意 CAUTION 内部には高電圧部分があり、感電する恐れがあります。保守担当者以外の方は内部に触れないでください。 HAZARDOUS VOLTAGE. SERVICE ENGINEER ONLY TOUCH THE INSIDE. 装置内有高电压部分,有引起触电的危险。除保养担当者之外,请勿触摸装置内部。 TENSIONS DANGEREUSES. SEUL UN INGÉNIEUR PEUT VÉRIFIER L'INTÉRIEUR.</p>
<p>⚠️ 注意 CAUTION 感電 触电 内部には高電圧部分があり、感電する恐れがあります。保守担当者以外の方は内部に触れないでください。 HAZARDOUS VOLTAGE. SERVICE ENGINEER ONLY TOUCH THE INSIDE. 装置内有高电压部分,有引起触电的危险。除保养担当者之外,请勿触摸装置内部。 TENSIONS DANGEREUSES. SEUL UN INGÉNIEUR PEUT VÉRIFIER L'INTÉRIEUR.</p>	<p>⚠️ 注意 CAUTION 本機器を搭載する前に、設置マニュアルを見てください。 请务必先阅读本装置安装手册之后,再进行机器的安装。 SEE INSTALLATION INSTRUCTIONS BEFORE INSTALLING THIS UNIT.</p>				
<p>⚠️ 注意 CAUTION 保守時は静電気を除去すること。 ELECTROSTATIC SENSITIVE DEVICES. 维护保养时必须采取防静电措施。</p>	<p>⚠️ 注意 CAUTION 内部には高電圧部分があり、感電する恐れがあります。保守担当者以外の方は内部に触れないでください。 HAZARDOUS VOLTAGE. SERVICE ENGINEER ONLY TOUCH THE INSIDE. 装置内有高电压部分,有引起触电的危险。除保养担当者之外,请勿触摸装置内部。 TENSIONS DANGEREUSES. SEUL UN INGÉNIEUR PEUT VÉRIFIER L'INTÉRIEUR.</p>				

Notes on Handling the Product

About this product

This product is designed and manufactured for standard applications. Such applications include, but are not limited to, general office work, personal and home use, and general industrial use. The product is not intended for applications that require extremely high levels of safety to be guaranteed (referred to below as "safety-critical" applications). Use of the product for a safety-critical application may present a significant risk of personal injury and/or death. Such applications include, but are not limited to, nuclear reactor control, aircraft flight control, air traffic control, mass transit control, medical life support, and missile launch control. Customers shall not use the product for a safety-critical application without guaranteeing the required level of safety. Customers who plan to use the product in a safety-critical system are requested to consult the Fujitsu sales representatives in charge.

Storage of accessories

Keep the accessories in a safe place because they are required for server operation.

Adding optional products

For stable operation of the PRIMEQUEST 2000 series server, use only a Fujitsu-certified optional product as an added option.

Note that the PRIMEQUEST 2000 series server is not guaranteed to operate with any optional product not certified by Fujitsu.

Maintenance



Only Fujitsu certified service engineers should perform the following tasks on this product and the options provided by Fujitsu. Customers must not perform these tasks under any circumstances. Otherwise, electric shock, injury, or fire may result.

- Newly installing or moving equipment
- Removing the front, rear, and side covers
- Installing and removing built-in options
- Connecting and disconnecting external interface cables
- Maintenance (repair and periodic diagnosis and maintenance)



Only Fujitsu certified service engineers should perform the following tasks on this product and the options provided by Fujitsu. Customers must not perform these tasks under any circumstances. Otherwise, product failure may result. PRIMEQUEST 2000 Series General Description

- Unpacking an optional Fujitsu product, such as an optional adapter, delivered to the customer

Modifying or recycling the product



Modifying this product or recycling a secondhand product by overhauling it without prior approval may result in personal injury to users and/or bystanders or damage to the product and/or other property.

Note on erasing data from hard disks when disposing of the product or transferring it

Disposing of this product or transferring it as is may enable third parties to access the data on the hard disk and use it for unforeseen purposes. To prevent the leakage of confidential information and important data, all of the data on the hard disk must be erased before disposal or transfer of the product.

However, it can be difficult to completely erase all of the data from the hard disk. Simply initializing (reformatting) the hard disk or deleting files on the operating system is insufficient to erase the data, even though the data appears at a glance to have been erased. This type of operation only makes it impossible to access the data from the operating system.

Malicious third parties can restore this data.

If you save your confidential information or other important data on the hard disk, you should completely erase the data, instead of simply carrying out the aforementioned operation, to prevent the data from being restored. To prevent important data on the hard disk from being leaked when the product is disposed of or transferred, you will need to take care to erase all the data recorded on the hard disk on your own responsibility.

Furthermore, if a software license agreement restricts the transfer of the software (operating system and application software) on the hard disk in the server or other product to a third party, transferring the product without deleting the software from the hard disk may violate the agreement. Adequate verification from this point of view is also necessary.

Support and service

Product and service inquiries

For all product use and technical inquiries, contact the distributor where you purchased your product, or a Fujitsu sales representative or systems engineer (SE). If you do not know the appropriate contact address for inquiries about the PRIMEQUEST 2000 series, use the Fujitsu contact line.

Fujitsu contact line

We accept Web inquiries. For details, visit our website:

https://www-s.fujitsu.com/global/contact/computing/PRMQST_feedback.html

Warranty

If a component failure occurs during the warranty period, we will repair it free of charge in accordance with the terms of the warranty agreement. For details, see the warranty.

Before requesting a repair

If a problem occurs with the product, confirm the problem by referring to 11.2 Troubleshooting in the *PRIMEQUEST 2000 Series Administration Manual* (C122-E175EN). If the error recurs, contact your sales representative or a field engineer. Confirm the model name and serial number shown on the label affixed to the right front of the device and report it. Also check any other required items beforehand according to 11.2 Troubleshooting in the *PRIMEQUEST 2000 Series Administration Manual* (C122-E175EN).

The system settings saved by the customer will be used during maintenance.

Manual

How to use this manual

This manual contains important information about the safe use of this product. Read the manual thoroughly to understand the information in it before using this product. Be sure to keep this manual in a safe and convenient location for quick reference.

Fujitsu makes every effort to prevent users and bystanders from being injured and to prevent property damage. Be sure to use the product according to the instructions in this manual.

Manuals for the PRIMEQUEST 2000 series

The following manuals have been prepared to provide you with the information necessary to use the PRIMEQUEST 2000 series.

You can access HTML versions of these manuals at the following sites:

Japanese-language site: <http://jp.fujitsu.com/platform/server/primequest/manual/2000/>

Global site: <http://www.fujitsu.com/global/services/computing/server/primequest/>

Title	Description	Manual code
<i>PRIMEQUEST 2000 Series Getting Started Guide</i>	Describes what manuals you should read and how to access important information after unpacking the PRIMEQUEST 2000 series server. (This manual comes with the product.)	C122-E170XA
<i>PRIMEQUEST 2000 Series Safety and Regulatory Information</i>	Contains important information required for using the PRIMEQUEST 2000 series safely.	C122-E171XA
<i>PRIMEQUEST 2000 Series Errata and Addenda</i>	Provides errata and addenda for the PRIMEQUEST 2000 series manuals. This manual will be updated as needed.	C122-E182EN
<i>PRIMEQUEST 2000 Series General Description</i>	Describes the functions and features of the PRIMEQUEST 2000 series.	C122-B025EN
<i>SPARC Enterprise/ PRIMEQUEST Common Installation Planning Manual</i>	Provides the necessary information and concepts you should understand for installation and facility planning for SPARC Enterprise and PRIMEQUEST installations.	C120-H007EN
<i>PRIMEQUEST 2000 Series Hardware Installation Manual</i>	Includes the specifications of and the installation location requirements for the PRIMEQUEST 2000 series.	C122-H007EN
<i>PRIMEQUEST 2000 Series Installation Manual</i>	Describes how to set up the PRIMEQUEST 2000 series server, including the steps for installation preparation, initialization, and software installation.	C122-E174EN
<i>PRIMEQUEST 2000 Series User Interface Operating Instructions</i>	Describes how to use the Web-UI and UEFI to assure proper operation of the PRIMEQUEST 2000 series server.	C122-E176EN
<i>PRIMEQUEST 2000 Series Administration Manual</i>	Describes how to use tools and software for system administration and how to maintain the system (component replacement and error notification).	C122-E175EN
<i>PRIMEQUEST 2000 Series Tool Reference</i>	Provides information on operation methods and settings, including details on the MMB, PSA, and UEFI functions.	C122-E177EN
<i>PRIMEQUEST 2000 Series Message Reference</i>	Lists the messages that may be displayed when a problem occurs during operation and describes how to respond to them.	C122-E178EN
<i>PRIMEQUEST 2000 Series REMCS Installation Manual</i>	Describes REMCS service installation and operation	C122-E180EN
<i>PRIMEQUEST 2000 Series Glossary</i>	Defines the PRIMEQUEST 2000 series related terms and abbreviations.	C122-E179EN

Related manuals

The following manuals relate to the PRIMEQUEST 2000 series.

You can access these manuals at the following site:

<http://www.fujitsu.com/global/services/computing/server/primequest/>Contact your sales representative for inquiries about the ServerView manuals.

Title	Description	Manual code
<i>ServerView Suite ServerView Operations Manager Quick Installation (Windows)</i>	Describes how to install and start ServerView Operations Manager in a Windows environment.	None
<i>ServerView Suite ServerView Operations Manager Quick Installation (Linux)</i>	Describes how to install and start ServerView Operations Manager in a Linux environment.	None
<i>ServerView Suite ServerView Installation Manager</i>	Describes the installation procedure using ServerView Installation Manager.	None
<i>ServerView Suite ServerView Operations Manager Server Management</i>	Provides an overview of server monitoring using ServerView Operations Manager, and describes the user interface of ServerView Operations Manager.	None
<i>ServerView Suite ServerView RAID Management User Manual</i>	Describes RAID management using ServerView RAID Manager.	None
<i>ServerView Suite Basic Concepts</i>	Describes basic concepts about ServerView Suite.	None
<i>ServerView Operations Manager Installation ServerView Agents for Linux</i>	Describes installation and update installation of ServerView Linux Agent.	None
<i>ServerView Operations Manager Installation ServerView Agents for Windows</i>	Describes installation and update installation of ServerView Windows Agent.	None
<i>ServerView RAID Manager VMware vSphere ESXi 5 Installation Guide</i>	Describes the installation and settings required to use ServerView RAID Manager on the VMware vSphere ESXi 5 server.	None
<i>MegaRAID SAS Software</i>	Provides technical information on using array controllers. Refer to the manual from the second DVD for ServerView Suite which you can purchase optionally or from the following URL: The Fujitsu Technology Solutions manuals server http://manuals.ts.fujitsu.com/	None
<i>MegaRAID SAS Device Driver Installation</i>	Provides technical information on using array controllers. Refer to the manual from the second DVD for ServerView Suite which you can purchase optionally or from the following URL: The Fujitsu Technology Solutions manuals server http://manuals.ts.fujitsu.com/	None

Title	Description	Manual code
<i>Modular RAID Controller Installation Guide</i>	Provides technical information on using array controllers. Refer to the manual from the second DVD for ServerView Suite which you can purchase optionally or from the following URL: The Fujitsu Technology Solutions manuals server http://manuals.ts.fujitsu.com/	None

Abbreviations

This manual uses the following product name abbreviations.

Formal product name	Abbreviation
Microsoft® Windows Server® 2012 R2 Datacenter	Windows, Windows Server 2012
Microsoft® Windows Server® 2012 R2 Standard	
Microsoft® Windows Server® 2012 Datacenter	
Microsoft® Windows Server® 2012 Standard	
Microsoft® Windows Server® 2008 R2 Standard	Windows, Windows Server 2008
Microsoft® Windows Server® 2008 R2 Enterprise	
Microsoft® Windows Server® 2008 R2 Datacenter	
Red Hat® Enterprise Linux® 6 (for Intel64)	Linux, RHEL6, RHEL
Oracle Linux 6 (x86_64)	Oracle Linux, Oracle Linux 6
VMware vSphere (R) 5	VMware, vSphere 5.x, VMware 5, VMware 5.x
VMware (R) ESXi (TM) 5	ESXi, ESXi 5, ESXi 5.x
Novell (R) SUSE(R) LINUX Enterprise Server 11 Service Pack 3	SLES11 SP3

Trademarks

Microsoft, Windows, and Windows Server are trademarks or registered trademarks of Microsoft Corporation in the United States and/or other countries.

Linux is a registered trademark of Linus Torvalds.

Red Hat, the Shadowman logo and JBoss are registered trademarks of Red Hat, Inc. in the U.S. and other countries.

Oracle and Java are registered trademark of Oracle Corporation and its related company.

Celeron, Celeron Inside, Centrino, Centrino Inside, Core Inside, Intel, the Intel logo, Intel Atom, Intel Atom Inside, Intel Core, Intel Inside, the Intel Inside logo, Intel vPro, Itanium, Itanium Inside, Pentium, Pentium Inside, the Rapid Start Technology logo, vPro Inside, Ultrabook, Xeon, and Xeon Inside are trademarks or registered trademarks of Intel Corporation in the U.S. and other countries.

Ethernet is a registered trademark of Fuji Xerox Co., Ltd. in Japan and is a registered trademark of Xerox Corp. in the United States and other countries.

VMware is a trademark or registered trademark of VMware, Inc. in the United States and other countries.

Novell and SUSE Linux Enterprise Server are trademarks of Novell, Inc.

Xen is a trademark or registered trademark of Citrix Systems, Inc. or its subsidiaries in the United States and other countries.

Other company names and product names are the trademarks or registered trademarks of their respective owners.

Trademark indications are omitted for some system and product names in this manual.

Notation

This manual uses the following fonts and symbols to express specific types of information.

Font or symbols	Meaning	Example
<i>italics</i>	Title of a manual that you should refer to	See the <i>PRIMEQUEST 2000 Series Installation Manual (C122-E174EN)</i> .
[]	Window names as well as the names of buttons, tabs, and drop-down menus in windows are enclosed in brackets.	Click the [OK] button.

Notation for the CLI (command line interface)

The following notation is used for commands.

Command syntax

Command syntax is represented as follows.

- Variables requiring the entry of a value are enclosed in angle brackets < >.
- Optional elements are enclosed in brackets [].
- Options for optional keywords are grouped in | (stroke) separated lists enclosed in brackets [].
- Options for required keywords are grouped in | (stroke) separated lists enclosed in braces { }.

Command syntax is written in a box.

Remarks

The command output shown in the PDF manuals may include line feeds at places where there is no line feed symbol (\ at the end of the line).

Notes on notations

- If you have a comment or request regarding this manual, or if you find any part of this manual unclear, please take a moment to share it with us by filling in the form at the following webpage, stating your points specifically, and sending the form to us:
https://www-s.fujitsu.com/global/contact/computing/PRMQST_feedback.html
- The contents of this manual may be revised without prior notice.
- In this manual, the Management Board and MMB firmware are abbreviated as "MMB."
- In this manual, IOU_10GbE and IOU_1GbE are collectively referred to as IO Units.
- Screenshots contained in this manual may differ from the actual product screen displays.
- The IP addresses, configuration information, and other such information contained in this manual are display examples and differ from that for actual operation.
- The PDF file of this manual is intended for display using Adobe® Reader® in single page viewing mode at 100% zoom.

This manual shall not be reproduced or copied without the permission of Fujitsu Limited.

Copyright 2014 FUJITSU LIMITED

Contents

Preface.....	i
CHAPTER 1 REMCS Service Overview	1
1.1 Purpose of REMCS Service	1
1.2 REMCS Linkage Overview	1
1.2.1 Components implementing the REMCS function.....	1
1.2.2 Installing the REMCS function.....	2
1.2.3 Connection configurations supported by the REMCS function	2
CHAPTER 2 Before Using the REMCS Service.....	3
2.1 Overview of Connection to the REMCS Center.....	3
2.2 Connection Configuration for Connecting to the REMCS Center.....	3
2.2.1 Internet connection (e-mail).....	3
2.2.2 P-P connection (ISDN: e-mail).....	4
CHAPTER 3 REMCS Service Start Procedure.....	6
3.1 Start Procedure Overview	6
3.2 REMCS Center Registration.....	8
3.2.1 Starting REMCS	8
3.2.2 Setting the connection configuration	9
3.2.3 Setting up the environment	10
3.2.4 Setting the periodic connection schedule	13
3.2.5 Setting the customer information	14
3.2.6 Confirming the registration result.....	17
3.2.7 Checking the connection	18
3.3 Importing the Registration Information.....	19
3.4 Replacing the S/MIME certificate during the initialization work.....	22
CHAPTER 4 REMCS Service Operations	24
4.1 REMCS Operations Overview.....	24
4.2 REMCS Service Menu	25
4.2.1 Customer Information update.....	25
4.2.2 Re-register.....	25
4.2.3 Connection Environment.....	25
4.2.4 Periodical Connection.....	26
4.2.5 Export Settings.....	27
4.2.6 Connection type change.....	29
4.2.7 Displaying the certificate	29
4.2.8 Replacing the certificate.....	31
4.2.9 Restoring a certificate	32
4.2.10 Connection check	33
4.2.11 Temporary Disconnection	35
4.2.12 Reconnection	36
4.2.13 HW Config. Info.....	37
4.2.14 SW Config. Info.....	37
CHAPTER 5 CHAPTER 5 REMCS Service Detail Settings	39

5.1	Overview of REMCS Service Detail Settings.....	39
5.2	Detail Environment Settings.....	40
5.3	Selecting REMCS Center	43
5.4	Select Language.....	43
5.5	Machine Name Display Change.....	44
5.6	Deleting the Personal Information.....	45
5.7	Display of certificate	45
CHAPTER 6	REMCS Messages.....	47
6.1	Messages in REMCS Windows	47
6.2	Communication Error Messages (SMTP Communication).....	60
6.3	Other Error Messages	62
CHAPTER 7	MMB Log Collection.....	63
7.1	MMB Log Collection	63
CHAPTER 8	Notes on Using REMCS GUI.....	64
8.1	Notes on Using REMCS GUI.....	64

Figures

FIGURE 1.1 REMCS linkage	1
FIGURE 2.1 Internet connection (using the network connected to the user port)	4
FIGURE 2.2 Internet connection (using REMCS port)	4
FIGURE 2.3 P-P connection (ISDN: e-mail) (using the network connected to a USER port)	5
FIGURE 2.4 P-P connection (ISDN: e-mail) (using the REMCS port)	5
FIGURE 3.1 REMCS Center registration flow	7
FIGURE 3.2 [Customer Information Registration Instructions] window	9
FIGURE 3.3 [Selecting REMCS Center] window	10
FIGURE 3.4 [Initial Settings] window	11
FIGURE 3.5 [Internet(Mail Only) connection environment settings] window	12
FIGURE 3.6 [Point-to-Point Connection environment settings] window	13
FIGURE 3.7 [Periodical Connection settings] window	14
FIGURE 3.8 [Customer Information] window	15
FIGURE 3.9 [Customer Information Review] window	16
FIGURE 3.10 [Information Transmit Agreement] window	17
FIGURE 3.11 [Registration result] window	18
FIGURE 3.12 [Connection check] window	18
FIGURE 3.13 [Result of connection check] window	19
FIGURE 3.14 [Importation of the REMCS settings] window	20
FIGURE 3.15 [After automatic registration, do you delete the personal information] window	20
FIGURE 3.16 [Connection check information] window	21
FIGURE 3.17 [Information Transmit Agreement] (for automatic setting) window	21
FIGURE 3.18 [Automatic registration state] window	22
FIGURE 3.19 [Replacement of certificates] window (during initialization work)	22
FIGURE 3.20 [Confirmation of certificate] window (during initialization work)	23
FIGURE 4.1 [REMCS initial] window	24
FIGURE 4.2 [Internet (Mail Only) connection environment settings] window	26
FIGURE 4.3 [Point-to-Point Connection environment settings] window	26
FIGURE 4.4 [Periodical Connection settings] window	27
FIGURE 4.5 [Exportation of the REMCS settings] window	28
FIGURE 4.6 Window for changing the active connection configuration	29
FIGURE 4.7 [Display of certificate] window (with certificate not replaced)	30
FIGURE 4.8 [Display of certificate] window (during use of certificate that has been replaced)	30
FIGURE 4.9 [Display of certificate] window (Certificate that has been displayed – previous certificate)	31
FIGURE 4.10 [Replacement of certificates] window	31
FIGURE 4.11 [Confirmation of certificate] window	32
FIGURE 4.12 [Replacement to the previous certificate] window	32
FIGURE 4.13 [Connection check] window (without personal information deleted)	33
FIGURE 4.14 [Connection check] window (with personal information deleted)	34
FIGURE 4.15 [Result of connection check] window	35
FIGURE 4.16 [Temporary Disconnection] window	36
FIGURE 4.17 [Reconnection] window	37

FIGURE 4.18 [Sending Hardware Configuration Information] window.....	37
FIGURE 4.19 [Sending Software Configuration Information] window	38
FIGURE 5.1 FE operation initial window.....	39
FIGURE 5.2 [Environment settings] window in case of internet connection (only mail).....	40
FIGURE 5.3 [Environment settings] window in case of P-P connection	42
FIGURE 5.4 [Selecting REMCS Center] window.....	43
FIGURE 5.5 [Select language (Japanese or English)] window.....	44
FIGURE 5.6 [Select to Display Machine ID or Machine Unique Name] window.....	45
FIGURE 5.7 [Deleting the personal information] window.....	45
FIGURE 5.8 [Display of certificate] window (SSL).....	46

Tables

TABLE 3.1 Input items for the [Internet(Mail Only) connection environment settings] window.....	12
TABLE 3.2 Input items for the [Point-to-Point Connection environment settings] window.....	13
TABLE 3.3 Input items for the [Periodical Connection settings] window.....	14
TABLE 3.4 Input items for the [Customer Information] window.....	15
TABLE 4.1 Items in the REMCS initial window.....	24
TABLE 5.1 Items of the FE operation initial window.....	39
TABLE 5.2 Items in the [Environment settings] window in case of internet connection (only mail).....	40
TABLE 5.3 Items in the [Environment settings] window in case of P-P connection.....	42
TABLE 6.1 Messages common to all windows.....	47
TABLE 6.2 Messages at GUI startup.....	47
TABLE 6.3 Messages in the menu frame.....	47
TABLE 6.4 Messages in the state display frame.....	48
TABLE 6.5 Messages in the setting progress display window.....	48
TABLE 6.6 Messages in the [Customer Information] window.....	48
TABLE 6.7 Messages in the initial window.....	48
TABLE 6.8 Messages in the [Initial Settings] window.....	49
TABLE 6.9 Messages in the [Importation of the REMCS settings] window.....	49
TABLE 6.10 Messages in the [Customer Information Review] window.....	50
TABLE 6.11 Messages in the [Automatic registration state] window.....	50
TABLE 6.12 Messages in the [Internet (Mail Only) connection environment settings] window.....	50
TABLE 6.13 Messages in the [Point-to-Point Connection environment settings] window.....	51
TABLE 6.14 Messages in the [Periodical Connection settings] window.....	52
TABLE 6.15 Messages in the [Customer Information] window.....	52
TABLE 6.16 Message in the [Customer Information Review] window.....	53
TABLE 6.17 Message in the [Information Transmit Agreement] window.....	53
TABLE 6.18 Messages in the [Registration result] window.....	54
TABLE 6.19 Messages in the [Exportation of the REMCS settings] window.....	54
TABLE 6.20 Messages in the [Connection check] window or [Connection check information] window.....	55
TABLE 6.21 Messages in the [Result of connection check] window.....	55
TABLE 6.22 Messages in the [Temporary Disconnection] window or [Reconnection] window.....	55
TABLE 6.23 Message in the [Sending Hardware Configuration Information] window.....	56
TABLE 6.24 Message in the [Sending Software Configuration Information] window.....	56
TABLE 6.25 Messages in the CE initial frame.....	56
TABLE 6.26 Messages in the [Environment settings] window.....	57
TABLE 6.27 Messages in the [Selecting REMCS Center] window.....	57
TABLE 6.28 Messages in the [Select language(Japanese or English)] window.....	58
TABLE 6.29 Messages in the [Select to Display Machine ID or Machine Unique Name] window.....	58
TABLE 6.30 Messages in the processing progress display window.....	58
TABLE 6.31 Messages in the [Deleting the personal information] window.....	58
TABLE 6.32 Messages in the [Replacement of certificates] window.....	59
TABLE 6.33 Messages in the [Confirmation of certificate] window.....	59
TABLE 6.34 Messages in the [Replacement to the previous certificate] window.....	60

TABLE 6.35 Messages in the [Display of certificate] window	60
TABLE 6.36 List of communication error messages (SMTP communication)	60
TABLE 8.1 REMCS message window	64

CHAPTER 1 REMCS Service Overview

This chapter provides an overview of the REMCS service.

1.1 Purpose of REMCS Service

The REMCS service connects your PRIMEQUEST 2000 Series to the REMCS Center, a total support center for Fujitsu customers, through the Internet or P-P (point to point) connection to enable the system to send server configuration information and automatically report failures when they occur. The REMCS service is thus intended to facilitate prompt responses and solutions to problems.

To receive the REMCS service, you will need a relevant service agreement with Fujitsu. Users without an agreement may register with the REMCS Center (registration) but cannot receive the service. For details on the service, contact the distributor where you purchased your product or your sales representative.

1.2 REMCS Linkage Overview

REMCS Agent reports resource information or problems in a partition to the REMCS Center in linkage with the MMB. REMCS Agent reports error information, log information, and other information of the PRIMEQUEST 2000 Series system to the REMCS Center via the Internet or P-P (point to point) connection.

FIGURE 1.1 REMCS linkage

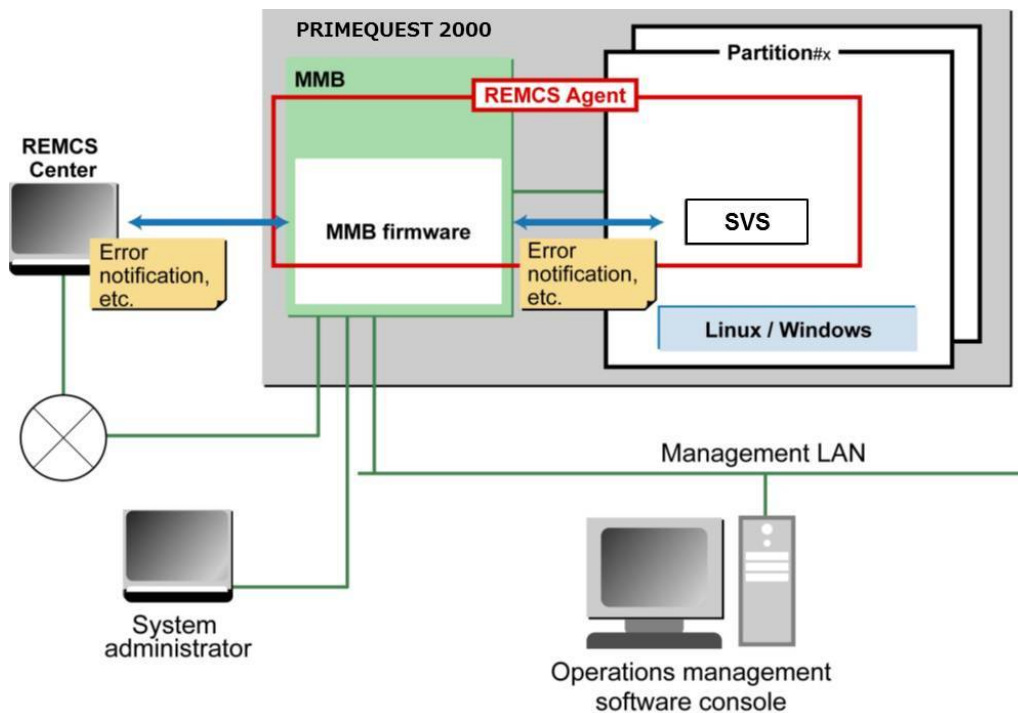

REMCS Agent of the PRIMEQUEST 2000 Series consists of the MMB firmware and SVS installed in each partition. As the REMCS linkage in the figure shows, the MMB firmware monitors the entire system for problems, and reports them to the REMCS Center when it detects them. SVS notifies the REMCS Center of hardware problem information and hardware configuration information detected by the operating system in the partition via the MMB firmware.

1.2.1 Components implementing the REMCS function

The REMCS functions of the PRIMEQUEST 2000 Series are implemented by the following components:

- MMB

Collects hardware configuration information of the entire server, monitors the server for problems, and reports thereon to the REMCS Center.

- SVS

Collects configuration information of the PCI cards and SCSI devices recognized in the partition and monitors them for problems.

Configuration information monitoring

Detects changes in the hardware or software configuration, and reports the latest configuration information to the REMCS Center.

Problem notification

When a hardware problem occurs in a server, automatically notifies the REMCS Center of the problem and sends problem information including logs to the REMCS Center.

Whenever an event involving a hardware problem occurs in the same unit after the REMCS Center has been notified of the hardware problem, notification thereon to the REMCS Center is suppressed. Events detected by SVS are cleared when the operating system is rebooted or when SVS is stopped or restarted. When a problem with a notification level that is higher than that of an event for which notification is being suppressed occurs in the same part, problem notification takes place even within the notification suppression period. At this time, the notification suppression time is cleared to 0, and the notification suppression continues. For SVS, there is no processing related to notification suppression time. Accordingly, until a problem with a high notification level occurs or until the events are cleared, notification of abnormalities is suppressed.

Periodic connection

Automatically connects to the REMCS Center at specified times to confirm the existence of the communication path and REMCS Agent

1.2.2 Installing the REMCS function

The REMCS function of the PRIMEQUEST 2000 Series consists of the MMB and SVS installed on the partition side.

Installation in the MMB

The MMB REMCS function is installed as standard. The function does not need to be installed.

Installation in SVS

For details on the procedure for installing the function in SVS, see 5.2 Setting of SVS (SVagent) in the *PRIMEQUEST 2000 Series Installation Manual (C122-E174EN)*.

1.2.3 Connection configurations supported by the REMCS function

The PRIMEQUEST 2000 Series supports only the connection configurations shown below. Each of these connection configurations uses only SMTP for communication with the REMCS Center.

- Internet connection (e-mail)

With this connection configuration, communication with the REMCS Center is executed via the Internet.

- P-P connection (ISDN: e-mail)

With this connection configuration, communication with the REMCS Center is executed with a P-P system using a line such as an ISDN line.

CHAPTER 2 Before Using the REMCS Service

This chapter describes the connection to the REMCS center, which is required during use of the REMCS service.

2.1 Overview of Connection to the REMCS Center

The connection configuration for connecting to the REMCS Center depends on the network configuration and server configuration of the user. The connection configuration to be used must be determined beforehand.

The PRIMEQUEST 2000 Series supports the following connection configurations. All of these connection configurations use only SMTP to communicate with the REMCS Center.

- Internet connection (e-mail)
- P-P connection (ISDN: e-mail)

Field engineers make the setting for connecting to the REMCS Center.

2.2 Connection Configuration for Connecting to the REMCS Center

This section explains the connection configurations for connecting to the REMCS Center.

The following connection configurations are available.

- [2.2.1 Internet connection \(e-mail\)](#)
- [2.2.2 P-P connection \(ISDN: e-mail\)](#)

2.2.1 Internet connection (e-mail)

This connection configuration is used for communication with the REMCS Center via the Internet.

Using a network connected to the user port

[FIGURE 2.1 Internet connection \(using the network connected to the user port\)](#) shows a configuration that uses a network connected to the user port.

Remarks

If the SMTP server at the customer site is specified with the FQDN, the DNS to be referred to by the MMB must be set. If the SMTP server is specified with the IP address, this setting is not required.

FIGURE 2.1 Internet connection (using the network connected to the user port)

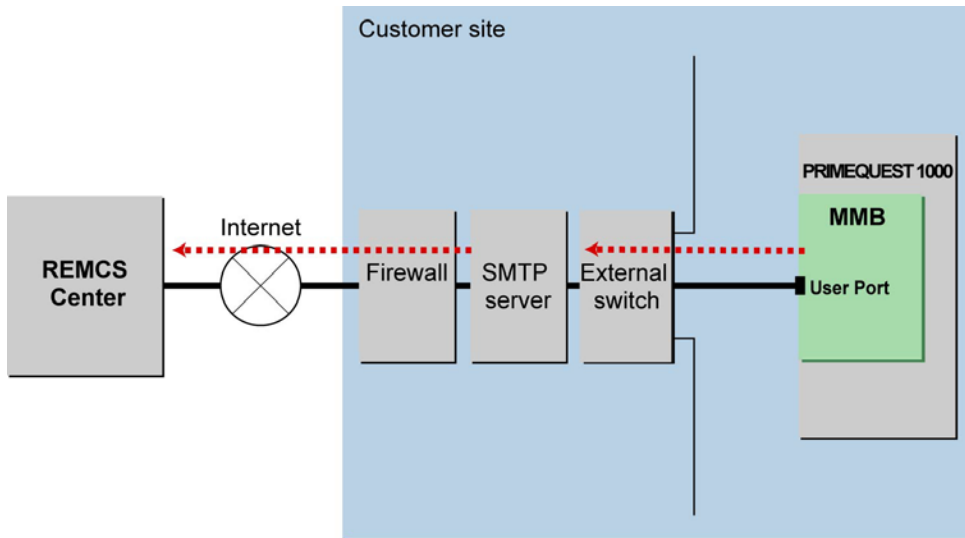

Using a network not connected to the user port

FIGURE 2.2 Internet connection (using REMCS port) shows a configuration that uses the REMCS port to connect to a network other than that connected to the user port. The SMTP server of an ISP (Internet Service Provider) cannot be specified.

Remarks

- The IP address of [Maintenance Port] must be set from the Web-UI of the MMB.
- Be sure to specify the SMTP server with the IP address.

FIGURE 2.2 Internet connection (using REMCS port)

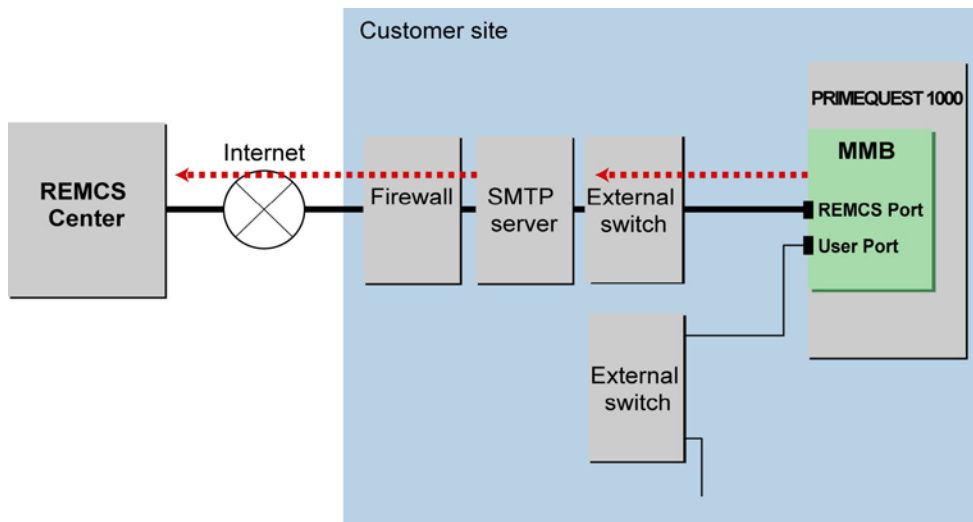

2.2.2 P-P connection (ISDN: e-mail)

Use a P-P system using a line such as an ISDN line for communication with the REMCS Center.

Through the network connected to a USER port

FIGURE 2.3 P-P connection (ISDN: e-mail) (using the network connected to a USER port) shows a configuration that uses the network connected to a USER port.

FIGURE 2.3 P-P connection (ISDN: e-mail) (using the network connected to a USER port)

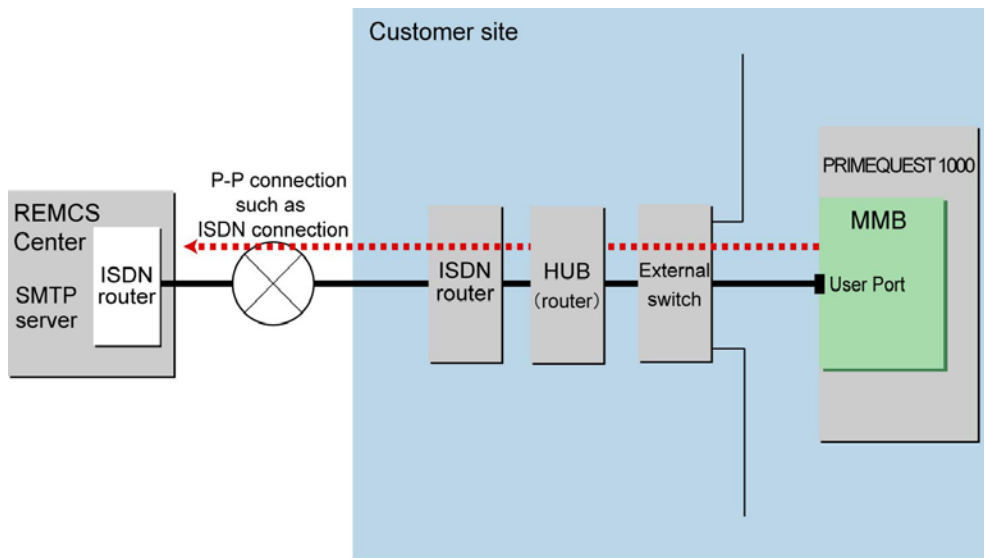

Through a network that is not connected to a USER port

FIGURE 2.4 P-P connection (ISDN: e-mail) (using the REMCS port) shows a configuration that uses the REMCS port to connect to a network other than the network connected to a USER port. There are two types of configuration: one has the REMCS port connected directly to the ISDN router, and the other has the HUB (router) connected to configure a dedicated LAN with other units and to connect the ISDN router to the HUB

Remarks

- The IP address for [MaintenancePort] must be set from the MMB Web-UI. However, DNS cannot be specified.
- Be sure to use the IP address to specify the SMTP server.

FIGURE 2.4 P-P connection (ISDN: e-mail) (using the REMCS port)

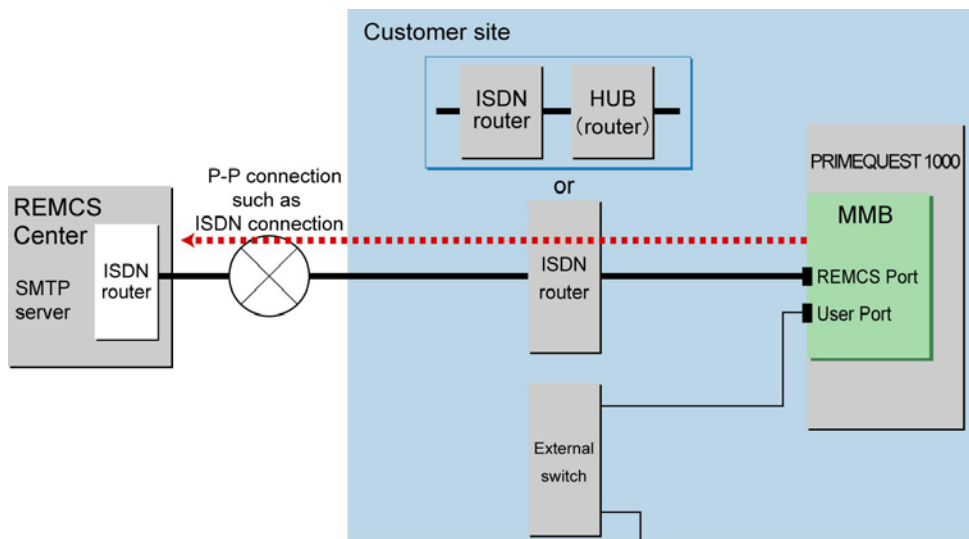

CHAPTER 3 REMCS Service Start Procedure

This chapter describes the procedure for starting the REMCS service.

3.1 Start Procedure Overview

To start the REMCS service, the user must register with the REMCS Center (registration).

Registration means to register customer information with the REMCS Center.

This procedure can be omitted if a field engineer has already completed the registration procedure on behalf of the customer, using the information obtained directly from the customer during product installation.

[FIGURE 3.1 REMCS Center registration flow](#) shows the screen transitions during the initialization work.

FIGURE 3.1 REMCS Center registration flow

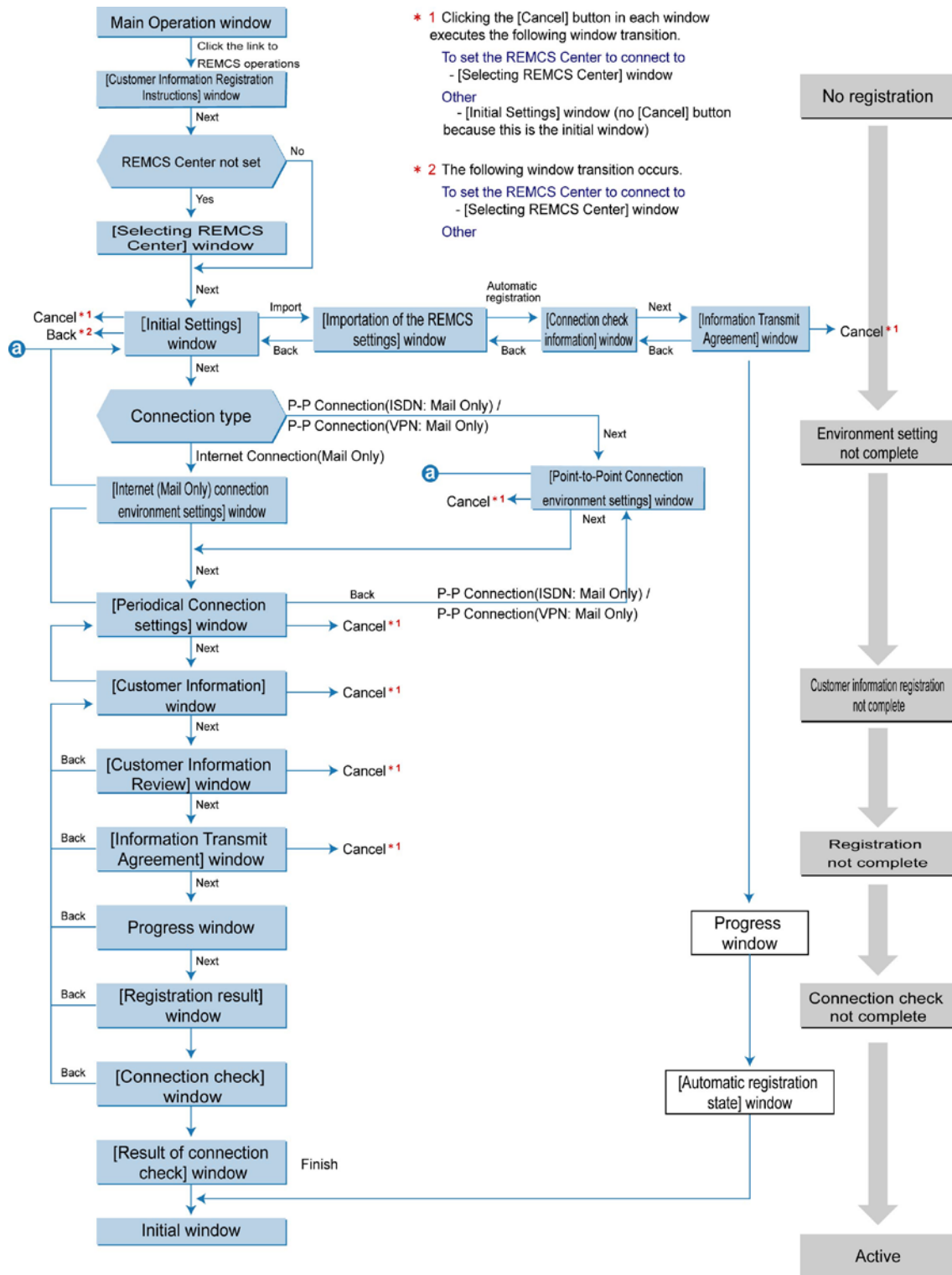

Before registration, prepare the following information.

- Warranty (contains your machine model name, check code, and serial number)
 The warranty is used to confirm that the machine ID displayed at the bottom of the REMCS window is correct.

Example display format: machine ID 00-PQ1000-model name-check code-serial number.

- IP address or FQDN of the mail server to be used

You can specify the FQDN only when using an Internet connection through the user port.
If you specify an FQDN, confirm that a DNS server is specified in [Network] - [Network Interface] of the MMB Web-UI.

- Sender e-mail address (with permission to send external e-mails)
- Whether to enable the mail server for partitioned e-mail sending
- Confirm whether your mail server is enabled for partitioned e-mail sending.

To connect to the REMCS Center through the REMCS port, you first need to set the Maintenance Port in [Network] - [Network Interface] of the MMB Web-GUI. Before making the port settings, prepare such information as the IP address to be assigned, subnet mask, gateway address, and destination SMTP server address.

You can also set the IP address of the REMCS port by using the following CLI.

Set command: Sets the REMCS port.

```
set maintenance_ip <ip address> <netmask> <gateway address>  
<SMTPaddress>
```

Note

You do not need to specify <gateway address> and <SMTP address> if you make point-to-point (P-P) REMCS connections. In this case, specify 0.0.0.0 for both <gateway address> and <SMTP address>.

Display command: Displays the REMCS port settings.

```
show maintenance_ip
```

For details on the commands, see Chapter 2 MMB CLI (Command Line Interface) Operations in the *PRIMEQUEST 2000 Series Tool Reference (C122-E177EN)*.

Note

Do not perform registration during the maintenance work.

3.2 REMCS Center Registration

This section describes how to register with the REMCS Center.
Use the following registration procedure.

- [3.2.1 Starting REMCS](#)
- [3.2.2 Setting the connection configuration](#)
- [3.2.3 Setting up the environment](#)
- [3.2.4 Setting the periodic connection schedule](#)
- [3.2.5 Setting the customer information](#)
- [3.2.6 Confirming the registration result](#)
- [3.2.7 Checking the connection](#)

3.2.1 Starting REMCS

To start REMCS, select the [Maintenance] - [REMCS] - [REMCS] menu in the MMB Web-UI.

If no registration has been made so far, the window shown in [FIGURE 3.2 \[Customer Information Registration Instructions\] window](#) appears.

If the registration has already been made, the window shown in [FIGURE 3.2 \[Customer Information Registration Instructions\] window](#) does not appear. Instead, the window shown in [FIGURE 4.1 \[REMCS initial\] window](#) appears.

For details on the procedure, see [CHAPTER 4 REMCS Service Operations](#)

FIGURE 3.2 [Customer Information Registration Instructions] window

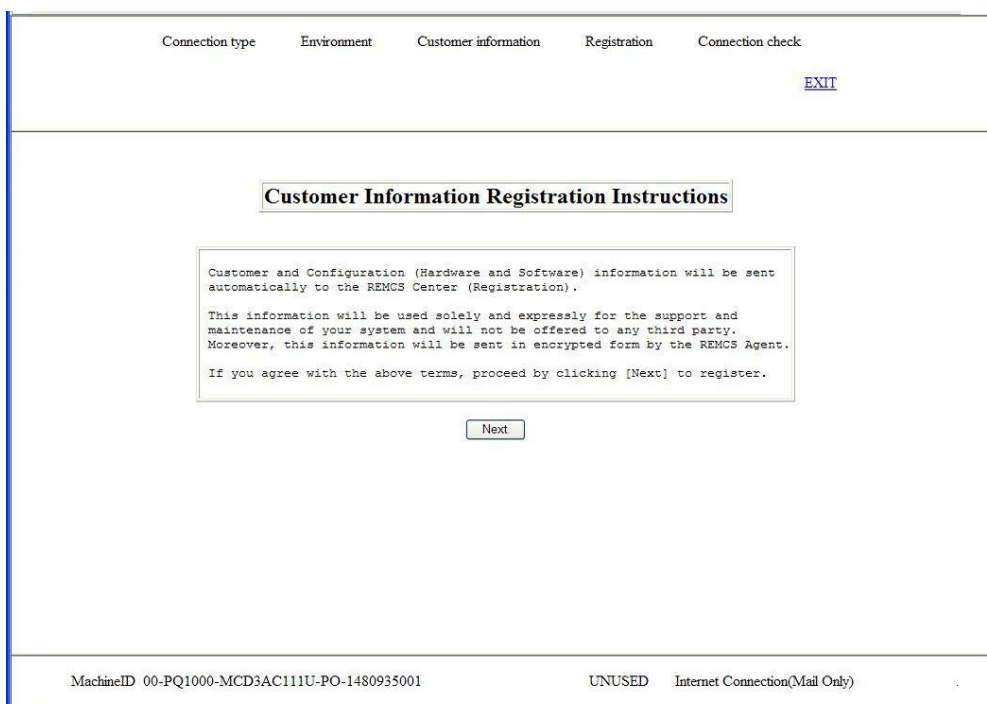

1. Click the [Next] button.
The window for selecting the REMCS Center to connect to appears.

3.2.2 Setting the connection configuration

Select the REMCS Center to connect to in the window shown in [FIGURE 3.3 \[Selecting REMCS Center\] window](#).

The REMCS Center you connect to differs according to the installation country. The initial value for Japan is usually [OSC]. Thus, simply confirm the value in this window.

If you have already confirmed the value, this window does not appear.

FIGURE 3.3 [Selecting REMCS Center] window

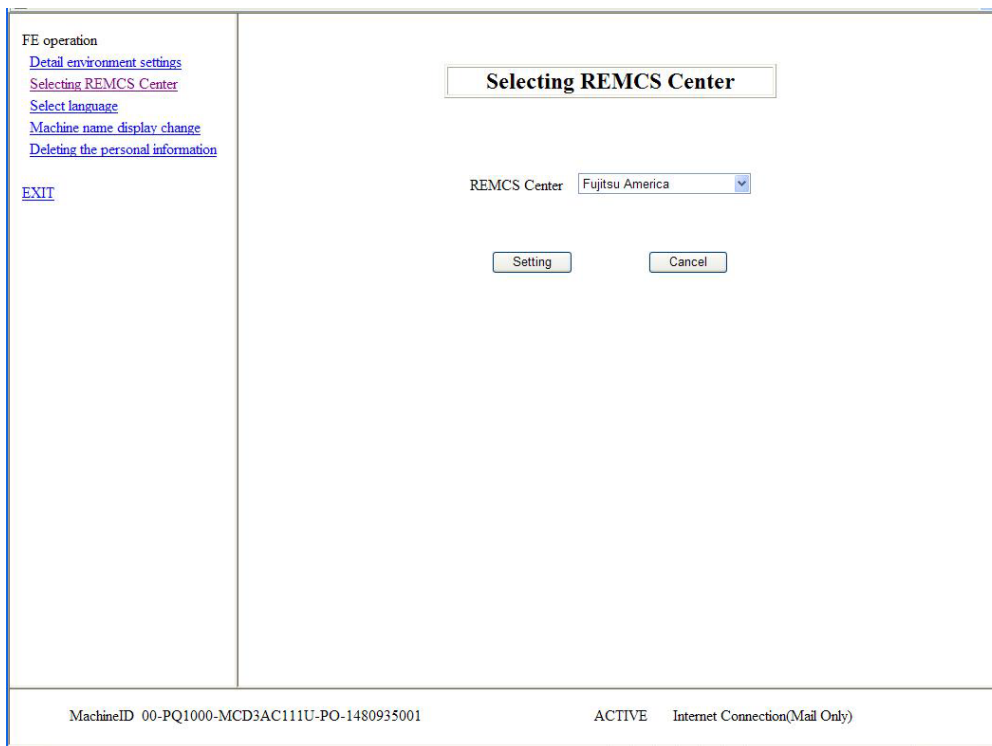

1. Click the [Next] button.
The REMCS Center to connect to is registered. Then, the [Initial Settings] window for setting up the environment appears.

3.2.3 Setting up the environment

Set up the environment from [FIGURE 3.4 \[Initial Settings\] window](#). Specify the connection configuration you selected in [2.2 Connection Configuration for Connecting to the REMCS Center](#).

You can also set up the environment by importing the setting information (environment information such as the SMTP server address and sender e-mail address as well as customer information such as the customer name and administrator's e-mail address) of another machine or the setting information that was backed up and saved in your machine.

After setting the REMCS service, you can still change the connection type by clicking [Initial Settings] from the menu in the window shown in [FIGURE 4.1 \[REMCS initial\] window](#).

FIGURE 3.4 [Initial Settings] window

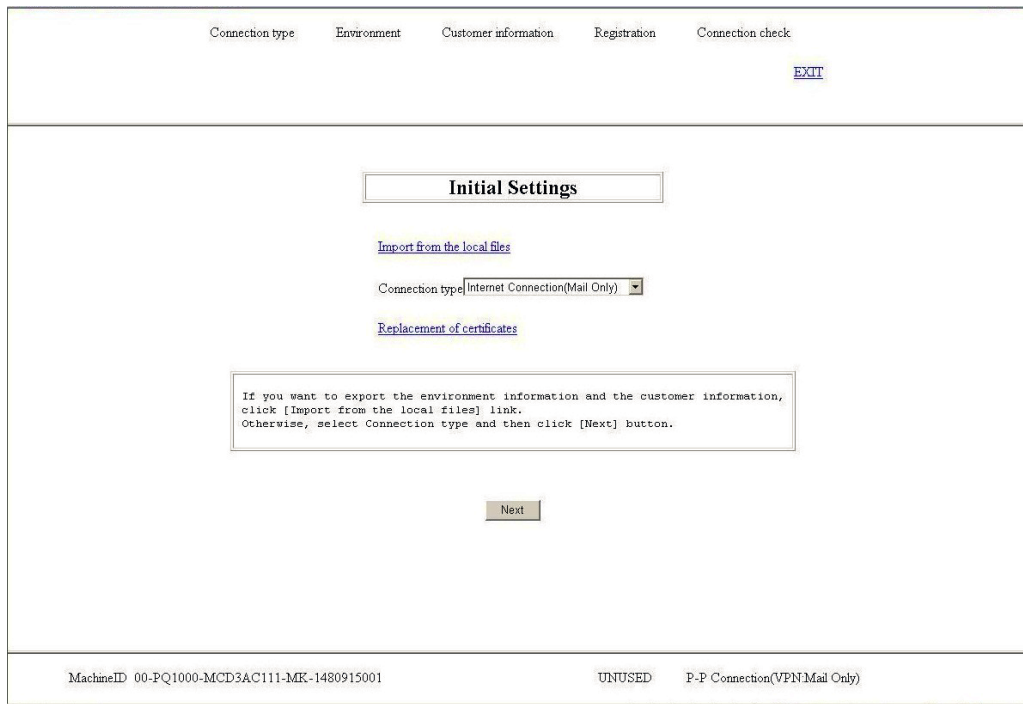

Newly setting up the environment

The procedure for newly setting up the environment is as follows.

1. Select the connection configuration from the following.
 - Internet Connection(Mail Only): The initial setting for the connection configuration
 - P-P Connection(ISDN: Mail Only): Connection via ISDN
 - P-P Connection(VPN: Mail Only): Connection via VPN
2. Click the [Next] button.

After the connection configuration is registered, the corresponding setting window appears.

The following procedure is for cases where the environment information already exists.

If the following setting information exists in another machine or was previously backed up and saved in your machine, you can perform automatic registration by importing the information.

- Customer information: rm_bkcus.def
- Environment information: rm_bkenv.def

For details on the procedure when the environment information is already available, see [3.2.6 Confirming the registration result](#).

When the connection type is [Internet Connection(Mail Only)]

If you selected [Internet Connection(Mail Only)] in the window shown in [FIGURE 3.4 \[Initial Settings\] window](#), the window shown in [FIGURE 3.5 \[Internet\(Mail Only\) connection environment settings\] window](#) appears.

Specify the information for sending e-mail via the Internet.

After setting the REMCS service, you can still change the connection configuration by clicking [Initial Settings] from the menu in the window shown in [FIGURE 4.1 \[REMCS initial\] window](#).

FIGURE 3.5 [Internet(Mail Only) connection environment settings] window

1. Enter the values for the following items.

TABLE 3.1 Input items for the [Internet(Mail Only) connection environment settings] window

Item	Description
SMTP Server	Enter the SMTP server name or IP address in single-byte alphanumeric characters and symbols.
Sender E-mail Address	Enter the sender e-mail address in single-byte alphanumeric characters and symbols.
Authentication type	Select the authentication type from [No certification], [POP Before STMP], and [AUTH STMP].
AUTH SMTP type	Valid if you specified the authentication type [AUTH SMTP]. You can select from [AUTO (initial value)], [CRAM-MD5], [PLAIN], and [LOGIN].
UserID	Enter the user ID for the authentication server in single-byte alphanumeric characters and symbols.
Password	Enter the password for the authentication server in single-byte alphanumeric characters and symbols.
POP Server	If you specified the authentication type [POP Before STMP], enter the POP server name or IP address in single-byte alphanumeric characters and symbols.
Division method	Select the division method from [No division], [Mail division], and [Event division]. The initial value at new installation is [Event division]. The initial value at the firmware update time is the setting before the firmware update.
Division Size	Enter the partitioning size in the range of 10 to 100 Kbytes. The initial value is 64 Kbytes.
Encryption type	If the S/MIME format is not supported before the firmware update, the initial value is [Previous encryption]. The initial value at the firmware update time is the setting before the firmware update.

2. Click the [Next] button.

After the connection configuration is registered, the window shown in [FIGURE 3.7 \[Periodical Connection settings\] window](#) appears.

When the connection configuration is [P-P Connection(ISDN: Mail Only)] or [P-P Connection(VPN:Mail Only)]

If you selected [P-P Connection(ISDN: Mail Only)] or [P-P Connection(VPN: Mail Only)] in the window shown in [FIGURE 3.4 \[Initial Settings\] window](#), the window shown in [FIGURE 3.6 \[Point-to-Point Connection environment settings\] window](#) appears.

After setting the REMCS service, you can still change the connection information by clicking [Connection Environment] from the menu in the window shown in [FIGURE 4.1 \[REMCS initial\] window](#).

FIGURE 3.6 [Point-to-Point Connection environment settings] window

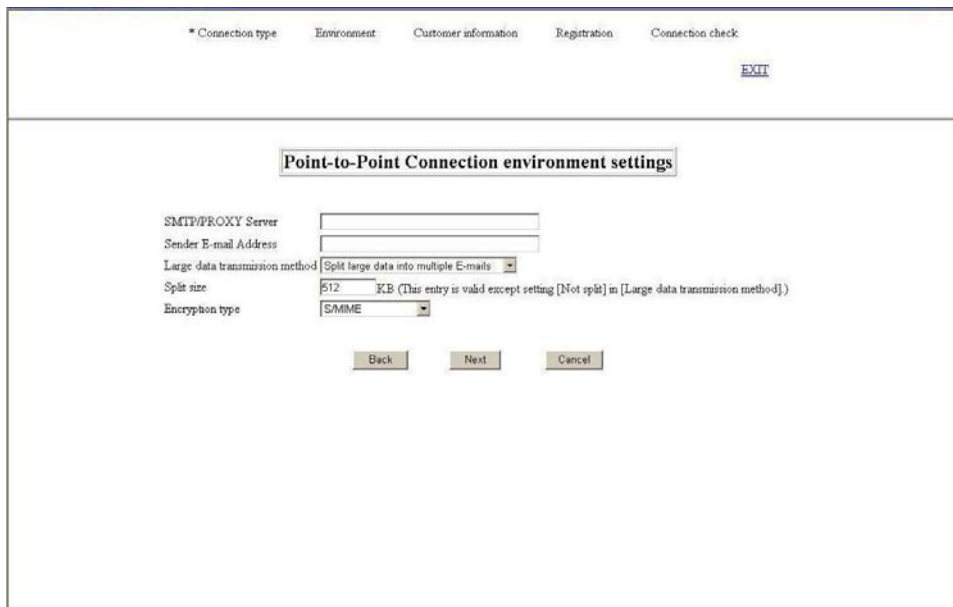

1. Enter the values for the following items.

TABLE 3.2 Input items for the [Point-to-Point Connection environment settings] window

Item	Description
SMTP/PROXY Server	Enter the SMTP/PROXY server name or IP address in single-byte alphanumeric characters and symbols.
Sender E-mail Address	Enter the sender e-mail address in single-byte alphanumeric characters and symbols.
Division method	Select the division method from [No division], [Mail division], and [Event division]. The initial value is [Event division].
Division Size	Enter the partitioning size in the range of 10 to 100 Kbytes. The initial value is 64 Kbytes.
Encryption type	If the S/MIME format is not supported before the firmware update, the initial value is [Previous encryption]. The initial value at the firmware update time is the setting before the firmware update.

2. Click the [Next] button.

After the connection configuration is registered, the window shown in [FIGURE 3.7 \[Periodical Connection settings\] window](#) appears. Proceed to [3.2.4 Setting the periodic connection schedule](#).

3.2.4 Setting the periodic connection schedule

In the window shown in [FIGURE 3.7 \[Periodical Connection settings\] window](#), specify the periodic connection schedule.

After starting the REMCS service, you can still change the periodic connection schedule by clicking [Periodical Connection] from the menu in the window shown in [FIGURE 4.1 \[REMCS initial\] window](#).

FIGURE 3.7 [Periodical Connection settings] window

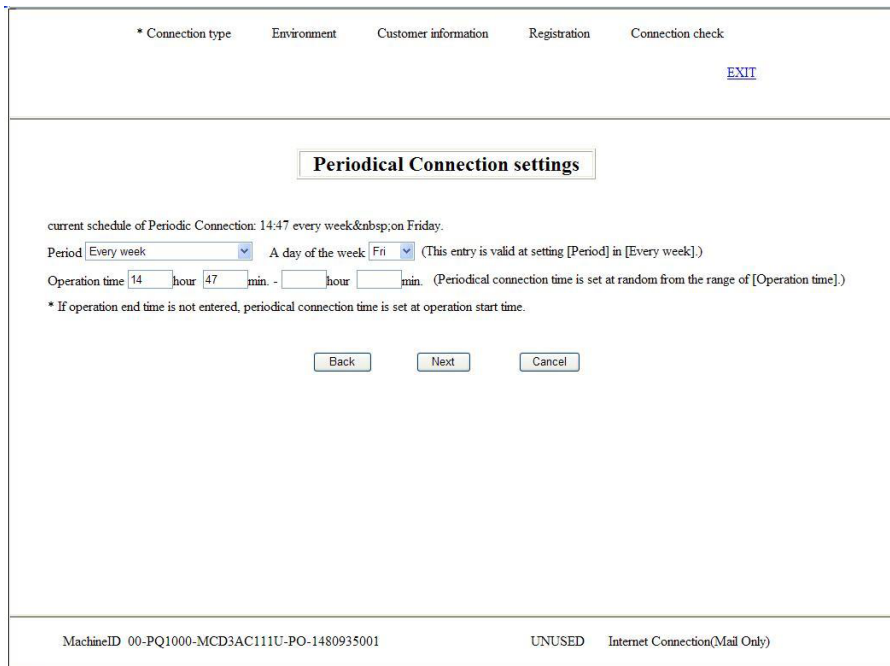

1. Specify the values for the following items.

TABLE 3.3 Input items for the [Periodical Connection settings] window

Item	Description
current schedule of Periodic Connection	The initial values are [Every week] and [10:00] to [15:00]. Specify values if you need to change the setting.
Period	Specify the setting from [Every day], [Every day (excluding Sunday)], [Every day (excluding Saturday & Sunday)], and [Every week].
A day of the week	If you specified [Every week] for the period, you need to specify a day of the week (Sunday to Saturday).

2. Click the [Next] button.
 After the periodic connection schedule is registered, the customer information window appears. Proceed to [3.2.5 Setting the customer information](#).

3.2.5 Setting the customer information

Enter the customer information in the window shown in [FIGURE 3.8 \[Customer Information\] window](#). After starting the REMCS service, you can still change the customer information by clicking [Customer Information update] from the menu in the window shown in [FIGURE 4.1 \[REMCS initial\] window](#).

FIGURE 3.8 [Customer Information] window

You can use the following characters and symbols for input.

- E-mail addresses must include, but cannot begin or end with, an @ mark. Also, the character that follows the @ mark must not be a dot (.).
- E-mail addresses must not use the following symbols: () < > ; : [] \.

The input items and values for the customer information are as follows.

TABLE 3.4 Input items for the [Customer Information] window

Input item	Maximum number of characters	Input	Personal information (*1)	Description
Company Name	30	Required	N/A	Enter the company name.
Department/Division	20	Optional	N/A	Enter your department/division name.
Address	30	Required	N/A	Enter the address.
Administrator Name	20	Required	Applicable	Enter the server administrator name.
Administrator Email Address	60	Required	Applicable	Enter the server administrator's e-mail address in single-byte alphanumeric characters and symbols. E-mail notifications of completed registration or error occurrences are sent to this e-mail address.
Zip/Postal Code	(*2)	Optional	N/A	Enter the zip/postal code for your company address in single-byte numeric characters and '-'.
Phone Number	20	Required	Applicable	Enter the phone number in single-byte numeric characters/symbols and '-'.
FAX Number	20	Optional	Applicable	Enter the FAX number in single-byte numeric characters/symbols and '-'.
Machine Unique Name	32	Optional	N/A	Enter the unique name at your site in single-byte alphanumeric characters and symbols.
Country	2	Required	N/A	Enter the installation country in alphabetic characters ("JP" for Japan; lower case characters are converted to upper case

				characters). Specify the country name with the code in the A2 column of ISO-3166 Code Table (two letters). For a country not specified in the table, specify 99.
Machine Installation Site	30	Optional	N/A	Enter the machine installation site (not required if it is the same as the [Address] value).
Machine Installation Building	20	Optional	N/A	Enter the machine installation building name (not required if it is the same as the [Address] value).
FE's E-mail Address	60	Optional	Applicable	Enter the e-mail address of the installer (field engineer). E-mail notification of completion of the connection check is also sent to this email address.
Delete the personal information	Check box	Optional	N/A	Specify whether personal information should be deleted. If checked, the values entered for the items for which the [Personal information] column in this table indicates [Applicable] are not retained as customer information for the MMB. Checked: The values are deleted. Not checked: The values are not deleted (default).

- *1: Considered personal information to be protected. If the personal information is deleted from the window shown in [FIGURE 5.7 \[Deleting the personal information\] window](#) by the FE, the information is deleted from the MMB customer information.
- *2: The number of characters in the zip/postal code depends on the country in which the PRIMEQUEST 2000 Series server is installed.

1. Enter the customer information.
2. Click the [Next] button.

After the customer information is registered, the window shown in [FIGURE 3.9 \[Customer Information Review\] window](#) appears.

FIGURE 3.9 [Customer Information Review] window

3. Click the [Next] button.

After the customer information is registered, the window shown in [FIGURE 3.10 \[Information Transmit Agreement\] window](#) appears. This window also appears when you click the [Auto Setting] button in the window for restoring setting information to perform automatic setting.

FIGURE 3.10 [Information Transmit Agreement] window



4. Confirm the agreement and click the [Agree] button. After the customer information is registered, the window shown in [FIGURE 3.11 \[Registration result\] window](#) appears.

3.2.6 Confirming the registration result

When the registration is completed, the execution result is displayed in the window shown in [FIGURE 3.11 \[Registration result\] window](#).

FIGURE 3.11 [Registration result] window

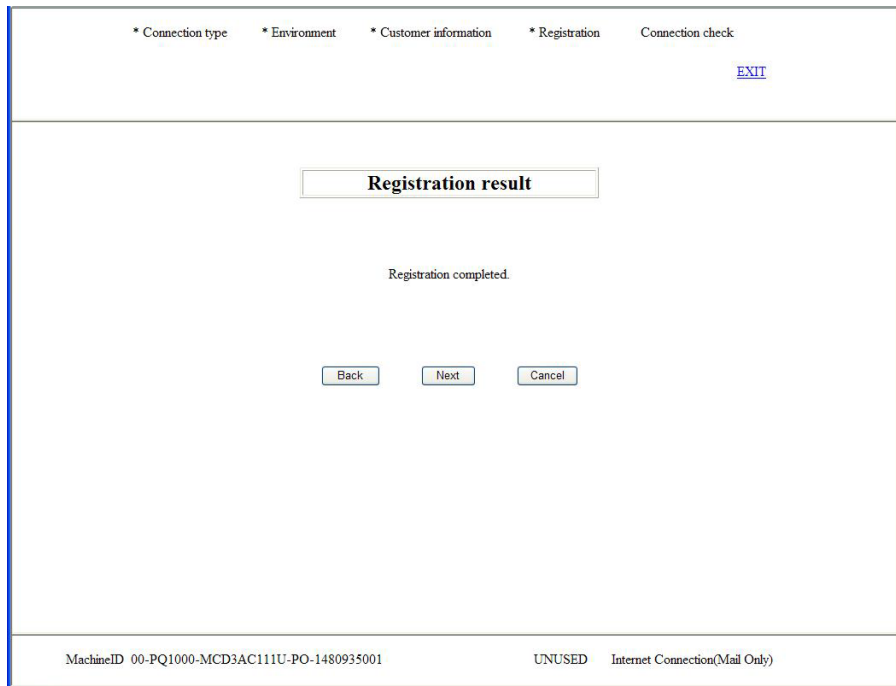

1. Click the [Next] button to proceed to 3.2.7 Checking the connection.

3.2.7 Checking the connection

1. The window shown in FIGURE 3.12 [Connection check] window appears. Confirm the setting of the e-mail addresses that receive the result of the connection check.

FIGURE 3.12 [Connection check] window



- Notification of the result to the administrator:
Specify whether to report the result to the administrator. If the personal information is not deleted, the administrator's e-mail address you entered during the customer information setting is displayed.

- Notification of the result to the installer:
Specify whether to report the result to the installer. If you select notification, set the installer's e-mail address in [E-mail address for receiving results].
- 2. Click the [Check] button to perform the connection check and display the window in [FIGURE 3.13 \[Result of connection check\] window](#).

FIGURE 3.13 [Result of connection check] window

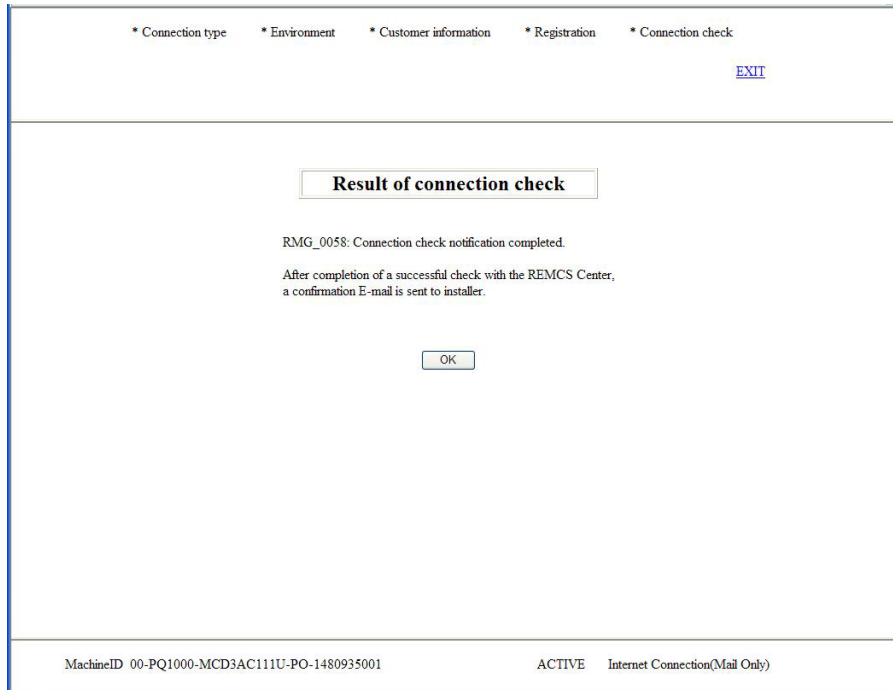

- 3. Click the [OK] button.
After the connection check is completed, the window in [FIGURE 4.1 \[REMCS initial\] window](#) appears.

3.3 Importing the Registration Information

The window shown in [FIGURE 3.14 \[Importation of the REMCS settings\] window](#) appears when you click [Import from the local files] in the window shown in [FIGURE 3.4 \[Initial Settings\] window](#). It imports the specified setting information files (the environment information file and customer information file) and performs automatic setting.

You can use the setting information files backed up in the same or different machine.

FIGURE 3.14 [Importation of the REMCS settings] window

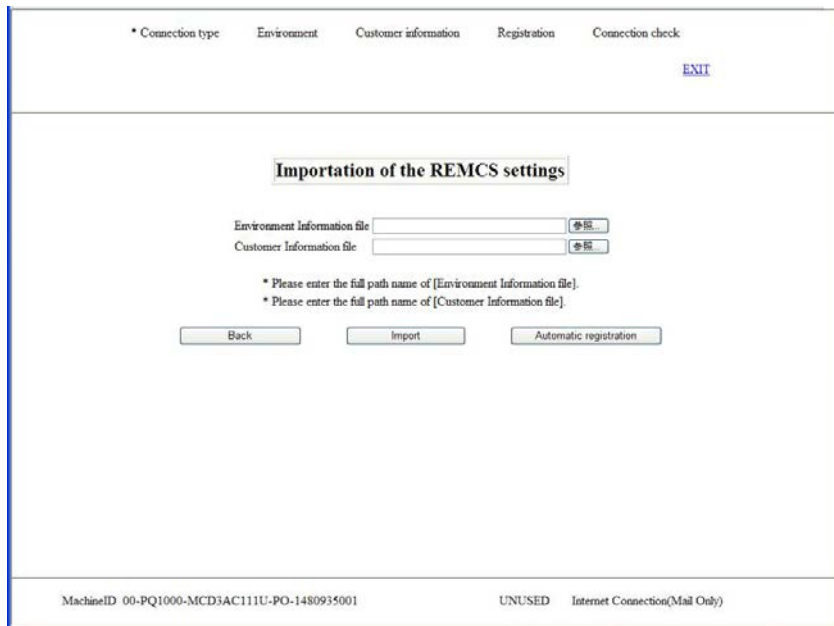

1. In the PC or file server running the Web browser, specify the following files that were previously backed up and saved.
 - Environment information file: Browse an rm_bkenv.def file.
 - Customer information file: Browse an rm_bkcus.def file.
2. Click the [Import] button to import the settings information files.
3. Click the [Automatic registration] button.

The window shown in [FIGURE 3.15 \[After automatic registration, do you delete the personal information\] window](#) appears. After you specify the operation, the window shown in [FIGURE 3.16 \[Connection check information\] window](#) appears. Confirm the setting of the receivers of the connection result.

Note that if you click the [Delete] button in the window shown in [FIGURE 3.15 \[After automatic registration, do you delete the personal information\] window](#), personal information is deleted after the automatic registration is completed.

FIGURE 3.15 [After automatic registration, do you delete the personal information] window



FIGURE 3.16 [Connection check information] window



- Notification of the result to the administrator
Specify whether to report the result to the administrator. The administrator e-mail address in the imported customer information is displayed as your administrator e-mail address.
 - Notification of the result to the installer
Specify whether to report the result to the installer. If you select notification, set the installer's e-mail address in [E-mail address for receiving results].
4. Click the [Next] button to set automatic registration.
The window shown in [FIGURE 3.17 \[Information Transmit Agreement\] \(for automatic setting\) window](#) appears.

FIGURE 3.17 [Information Transmit Agreement] (for automatic setting) window



5. Confirm the agreement and click the [Agree] button.
After the customer information is registered, the window shown in [FIGURE 3.18 \[Automatic registration state\] window](#) appears.

FIGURE 3.18 [Automatic registration state] window

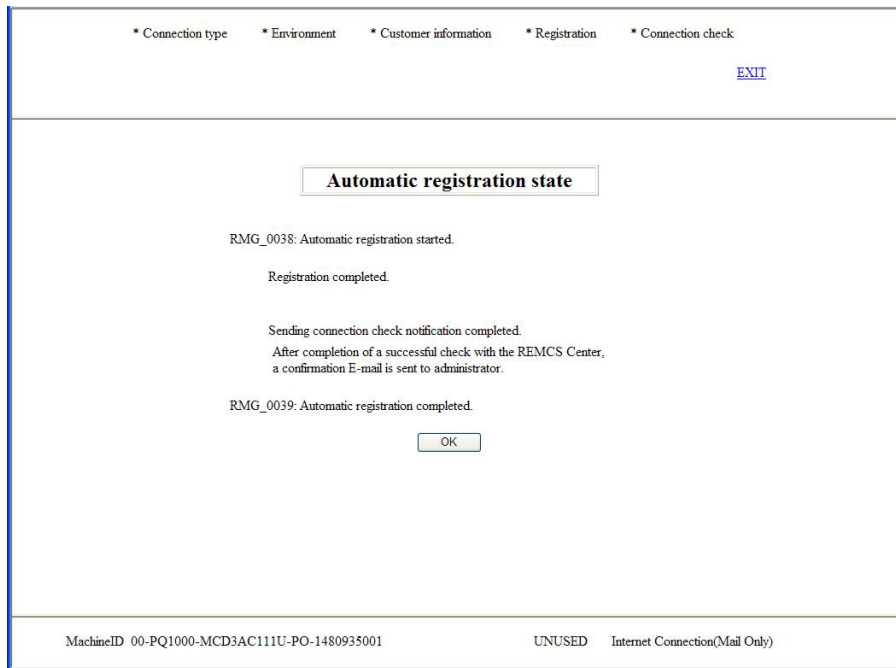

6. Click the [OK] button.
After the registration is completed, the window shown in [FIGURE 4.1 \[REMCS initial\] window](#) appears.

3.4 Replacing the S/MIME certificate during the initialization work

This section describes the procedure for replacing the certificate.

1. Click [Replacement of certificates] from [FIGURE 3.4 \[Initial Settings\] window](#) to display [FIGURE 3.19 \[Replacement of certificates\] window \(during initialization work\)](#).

FIGURE 3.19 [Replacement of certificates] window (during initialization work)

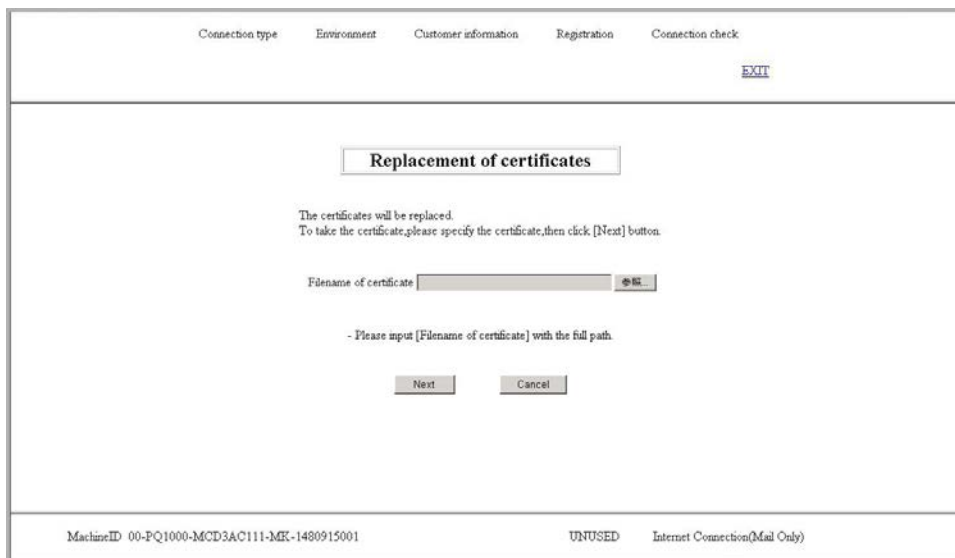

2. Specify the certificate file and then click the [Next] button. [FIGURE 3.20 \[Confirmation of certificate\] window \(during initialization work\)](#).

FIGURE 3.20 [Confirmation of certificate] window (during initialization work)



3. Click the [Next] button to output the following confirmation message.
"The certificates will be replaced. Once the replacement of certificates proceeds, the report to the REMCS center will not be done until connected confirmation is completed. Are you sure?"
4. Click the [OK] button to return to [FIGURE 3.4 \[Initial Settings\] window](#).

CHAPTER 4 REMCS Service Operations

This chapter describes how to operate the REMCS service.

4.1 REMCS Operations Overview

When the REMCS Center registration is completed or cancelled, the window shown in [FIGURE 4.1 \[REMCS initial\] window](#) appears. This window also appears when you start REMCS through the MMB Web-UI after the confirmation of connection to the REMCS Center is completed.

Select the function to perform from the menu on the left side of the window shown in [FIGURE 4.1 \[REMCS initial\] window](#).

[TABLE 4.1 Items in the REMCS initial window](#) shows the menu items in the REMCS initial window.

FIGURE 4.1 [REMCS initial] window

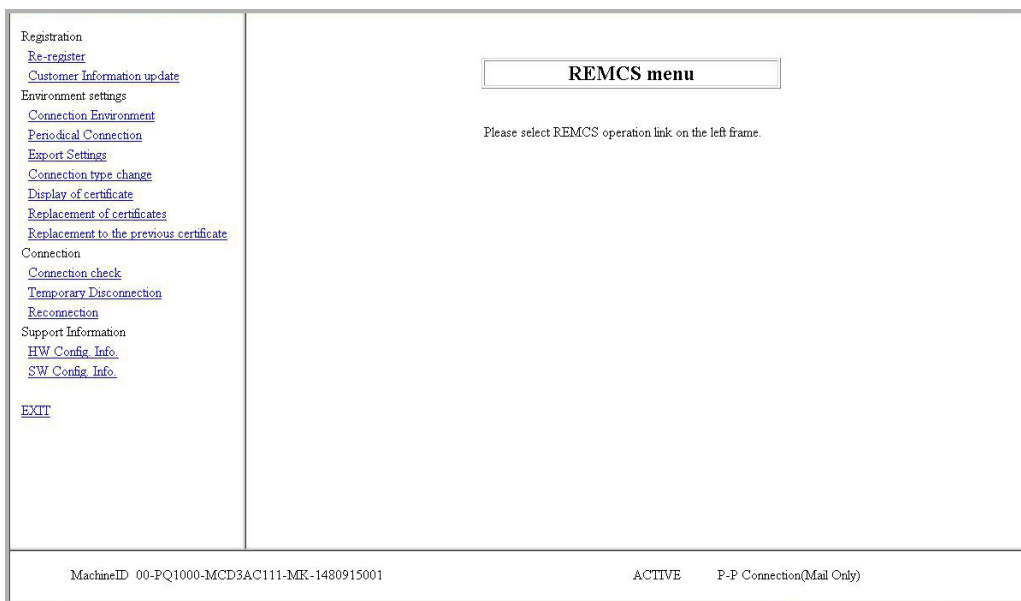

TABLE 4.1 Items in the REMCS initial window

Item	Description
Re-register	Updates the registration information.
Customer Information update	Confirms or changes the customer information. For details, see 4.2.1 Customer Information update .
Connection Environment	Displays or changes the connection information.
Periodical Connection	Specifies or changes the periodic connection schedule.
Export Settings	Exports the setting information.
Connection type change	Specifies or changes the connection configuration.
Display of certificate	Displays the certificate used for transmission in S/MIME format.
Replacement of certificates	Replaces the certificate used for transmission in S/MIME format.
Replacement to the previous certificate	Replaces the certificate used for transmission in S/MIME format with the one used earlier. If a certificate has not been replaced, this item cannot be selected.
Connection check	Checks the connection to the REMCS Center.
Temporary Disconnection	Temporarily disconnects the system from the REMCS Center for cases such as maintenance.
Reconnection	Re-establishes the connection to the REMCS Center after temporary disconnection.
HW Config. Info.	Sends the hardware configuration information.
HW Config. Info.	Sends the software configuration information.
Exit	Exits the REMCS operations and closes the browser window.

4.2 REMCS Service Menu

This section describes the REMCS service menu items.

4.2.1 Customer Information update

Use this menu item to confirm the customer information entered on registration or to change the information such as the administrator name or company address.

The procedure for displaying and confirming the customer information is as follows.

1. From the menu in the window shown in [FIGURE 4.1 \[REMCS initial\] window](#), click [Customer Information update].
The [Customer Information] window appears.
2. If your purpose is confirmation only, click the [Cancel] button. If you want to update the information, change the relevant value and click the [Next] button.
The [Customer Information Review] window appears.
3. Confirm the information. If everything is correct, click the [Next] button. The [FIGURE 3.10 \[Information Transmit Agreement\] window](#) appears. If you find any wrong information and need to correct it, click the [Back] button to return to the [Customer Information Review] window.
4. After confirming that your environment is enabled for sending e-mails, click the [Agree] button. The entered information is automatically sent to the REMCS Center. When the e-mail transfer is completed, the [Registration result] window appears.
5. Click the [Next] button to return to the initial window.
 - The administrator's e-mail address entered in the [Customer Information] window receives an e-mail notification of completed registration.
 - Any updates to the user registration information before receiving the e-mail notification should be invalid. Be sure to update the information after receiving the e-mail notification of completed registration.

4.2.2 Re-register

You can use this menu item only when you have not yet registered customer information after updating it in the [Customer Information] window.

The procedure for re-registration is as follows.

1. From the menu in the window shown in [FIGURE 4.1 \[REMCS initial\] window](#), click [Re-register]. The [FIGURE 3.10 \[Information Transmit Agreement\] window](#) appears.
2. After confirming that your environment is enabled for sending e-mails, click the [Agree] button. The entered information is automatically sent to the REMCS Center. When the e-mail transfer is completed, the [Registration result] window appears.
3. Click the [Next] button to return to the window shown in [FIGURE 4.1 \[REMCS initial\] window](#).
 - The administrator's e-mail address entered in the [Customer Information] window receives an e-mail notification of completed registration.
 - Any updates to the user registration information before receiving the e-mail notification should be invalid. Be sure to update the information after receiving the e-mail notification of completed registration.

4.2.3 Connection Environment

Use this menu item to display the current connection information or to change the setting information such as the mail server setting.

The procedure for displaying and confirming the connection information is as follows.

1. From the menu in the window shown in [FIGURE 4.1 \[REMCS initial\] window](#), click [Connection Environment].
 - If your environment is set for Internet Connection(Mail Only), the window shown in [FIGURE 4.2 \[Internet \(Mail Only\) connection environment settings\] window](#) appears.
 - If your environment is set for other connection types, the window shown in [FIGURE 4.3 \[Point-to-Point Connection environment settings\] window](#) appears. For details on how to operate the windows, see [CHAPTER 3 REMCS Service Start Procedure](#).

FIGURE 4.2 [Internet (Mail Only) connection environment settings] window

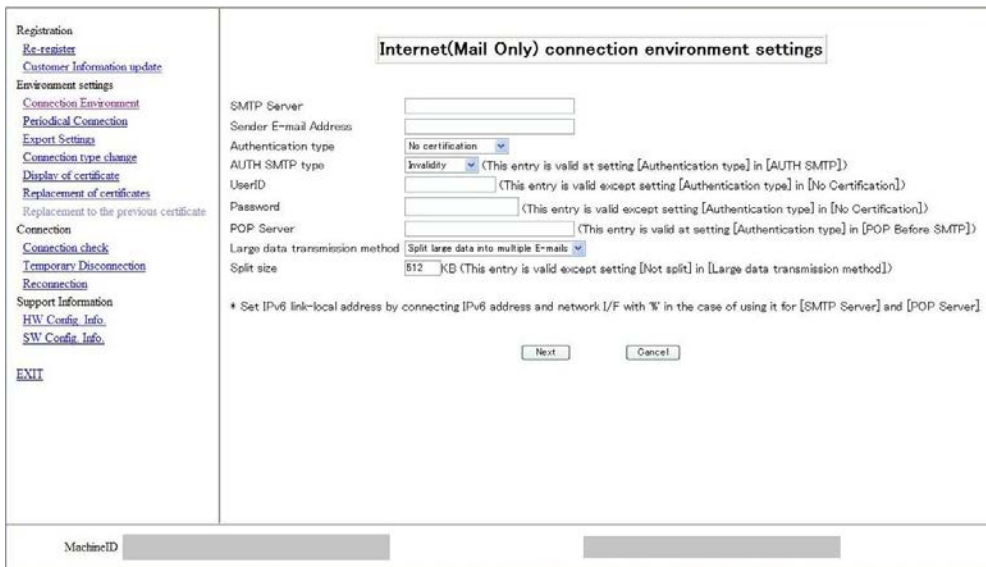
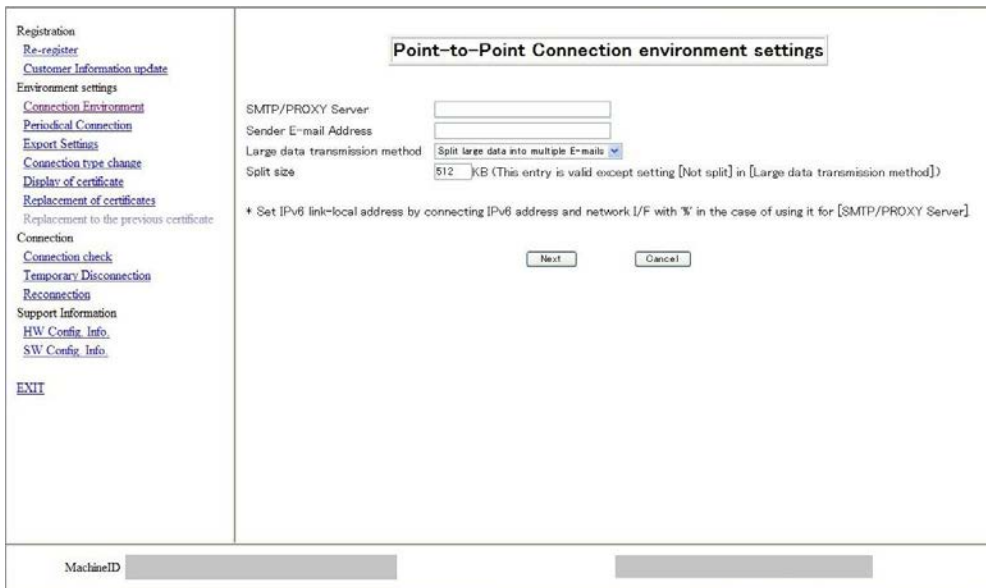

FIGURE 4.3 [Point-to-Point Connection environment settings] window



2. Confirm the information. If you want to correct or change the information, click the [Next] button. After the information is updated, the browser returns to the window shown in [FIGURE 4.1 \[REMCS initial\] window](#). If your purpose is confirmation only, click the [Cancel] button to return to the window in [FIGURE 4.1 \[REMCS initial\] window](#).

4.2.4 Periodical Connection

Use this menu item to display or change the periodic connection schedule.

1. From the menu in the window shown in [FIGURE 4.1 \[REMCS initial\] window](#), click [Periodical Connection]. The window shown in [FIGURE 4.4 \[Periodical Connection settings\] window](#) appears. For details on how to operate the windows, see [CHAPTER 3 REMCS Service Start Procedure](#).

FIGURE 4.4 [Periodical Connection settings] window

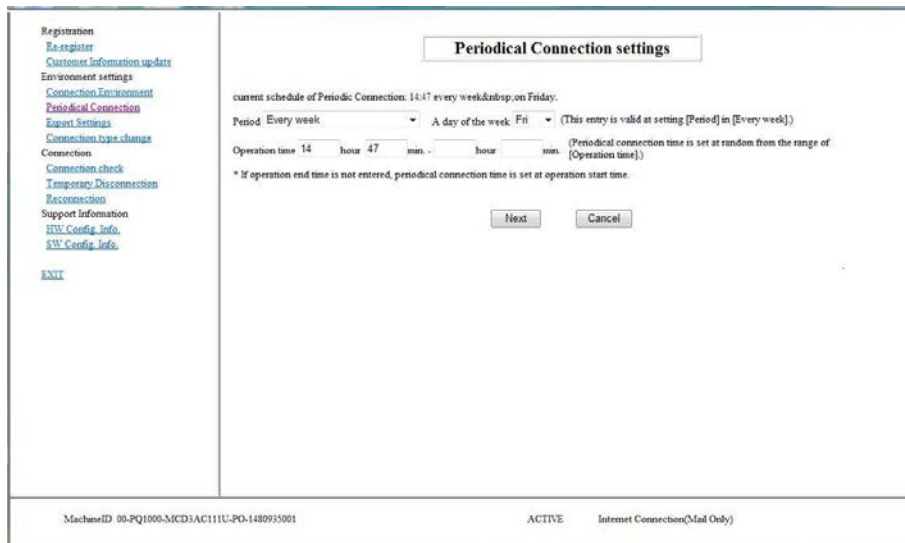

2. After changing the periodic connection schedule, click the [Next] button. A connection check is performed to report the schedule to the REMCS Center. When the processing completes, you will be returned to [FIGURE 4.1 \[REMCS initial\] window](#).
If your purpose is confirmation only, click the [Cancel] button. You will be returned to [FIGURE 4.1 \[REMCS initial\] window](#).

The administrator's e-mail address entered in the [Customer Information] window receives an e-mail notification of completed connection check.

4.2.5 Export Settings

Use this menu item to save the customer information and environment setting information to local files. The exported setting information can be used in different servers to start the REMCS service regardless of the operating system.

1. From the menu in the window shown in [FIGURE 4.1 \[REMCS initial\] window](#), click [Export Settings].The window shown in [FIGURE 4.5 \[Exportation of the REMCS settings\] window](#) appears.
2. Click [Environment information] or [Customer Information].
The dialog box for specifying the file name and the file store location. Specify the following files.
 - Customer information: rm_bkcus.def
 - Environment information: rm_bkenv.def
3. Click the [Cancel] button to return to the window shown in [FIGURE 4.1 \[REMCS initial\] window](#).

FIGURE 4.5 [Exportation of the REMCS settings] window

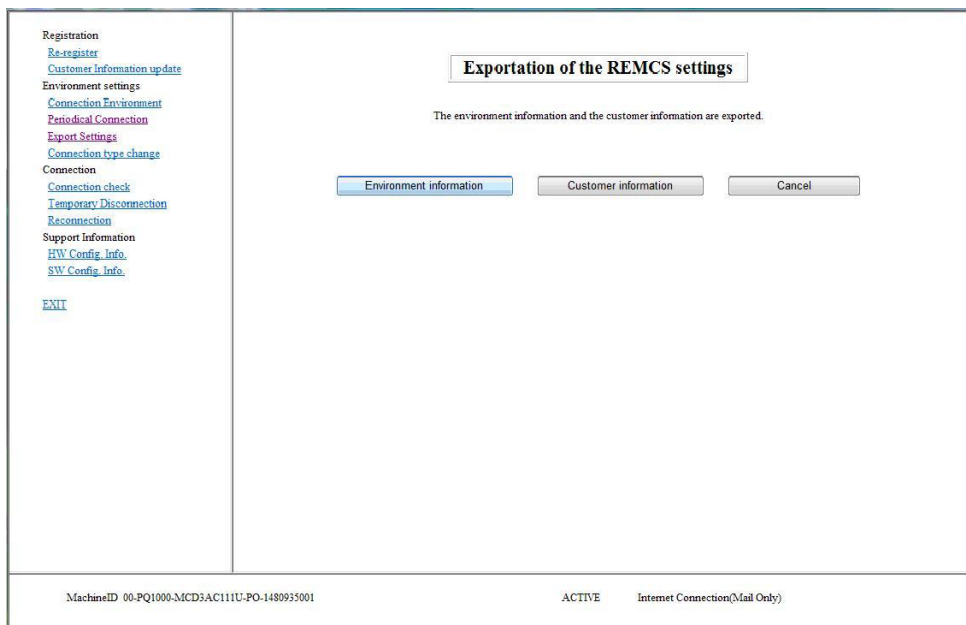

4.2.6 Connection type change

Use this menu item to change the current connection configuration to another configuration.

1. From the menu in the window shown in [FIGURE 4.1 \[REMCS initial\] window](#), click [Connection type change].

The [Connection type change] window (shown in [FIGURE 4.6 Window for changing the active connection configuration](#)) appears.

2. After changing the connection configuration, click the [Next] button. The current setting information is discarded and the machine status becomes [Setting not completed].

You need to perform the service start procedure by specifying the connection information again according to [3.2.2 Setting the connection configuration](#).

FIGURE 4.6 Window for changing the active connection configuration



4.2.7 Displaying the certificate

Use the following procedure to confirm the information of the certificate.

1. From the menu in the window shown in [FIGURE 4.1 \[REMCS initial\] window](#), click [Display of certificate].

The window will appear according to following cases:

- [FIGURE 4.7 \[Display of certificate\] window \(with certificate not replaced\)](#)
- [FIGURE 4.8 \[Display of certificate\] window \(during use of certificate that has been replaced\)](#)
- [FIGURE 4.9 \[Display of certificate\] window \(Certificate that has been displayed – previous certificate\)](#)
- Window displayed when the certificate has not been replaced

FIGURE 4.7 [Display of certificate] window (with certificate not replaced)

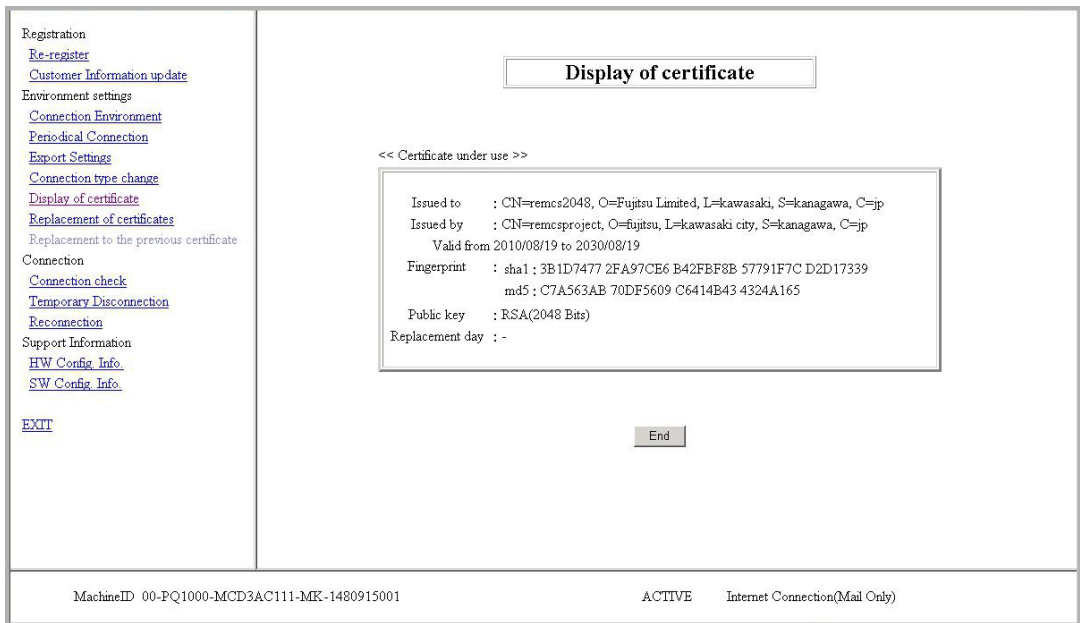

- Certificate display when the certificate has been displayed (certificate in use)
 Select [Certificate under use] and then click the [Display] button.

FIGURE 4.8 [Display of certificate] window (during use of certificate that has been replaced)

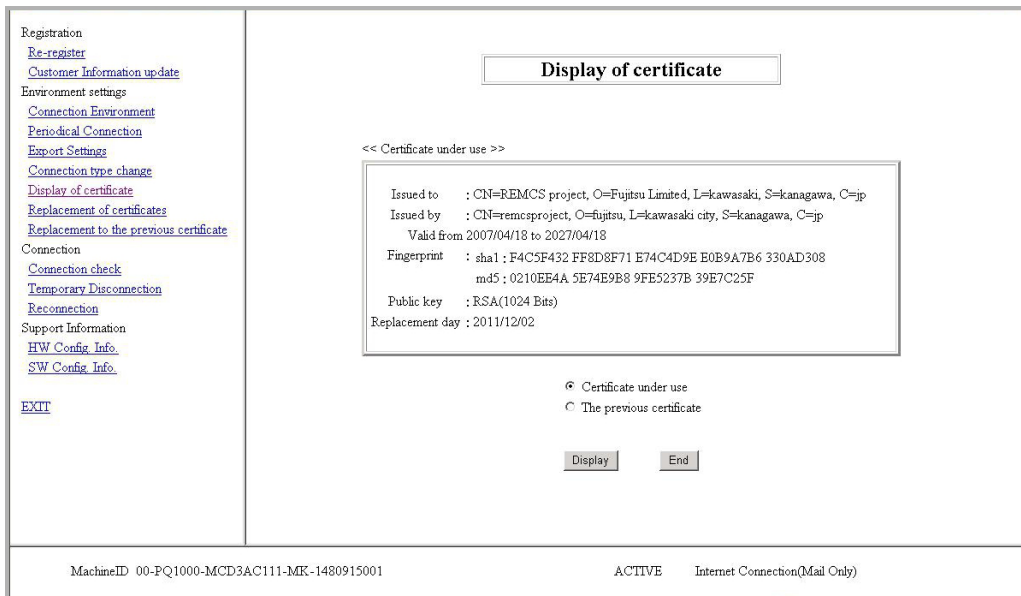

- Certificate display for certificate that has been replaced (previous certificate)
 Select [The previous certificate] and then click the [Display] button.

FIGURE 4.9 [Display of certificate] window (Certificate that has been displayed – previous certificate)

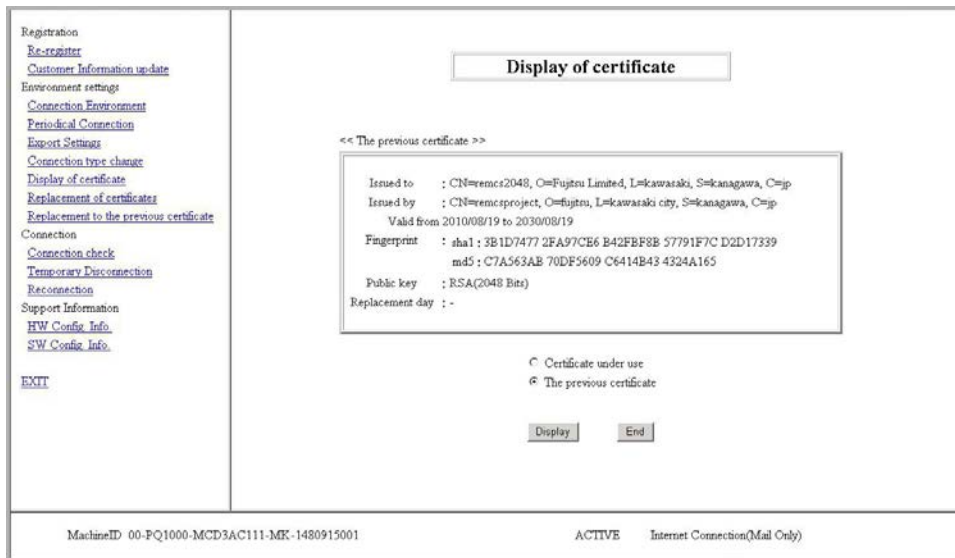

2. To confirm and exit, click the [End] button. Click the [End] button to return to the window shown in [FIGURE 4.1 \[REMSCS initial\] window](#).

4.2.8 Replacing the certificate

Use the following procedure to replace the certificate you are currently using, with another certificate.

1. From the menu in the window shown in [FIGURE 4.1 \[REMSCS initial\] window](#), click [Replacement of certificates].
The window shown in [FIGURE 4.10 \[Replacement of certificates\] window](#) appears.

FIGURE 4.10 [Replacement of certificates] window

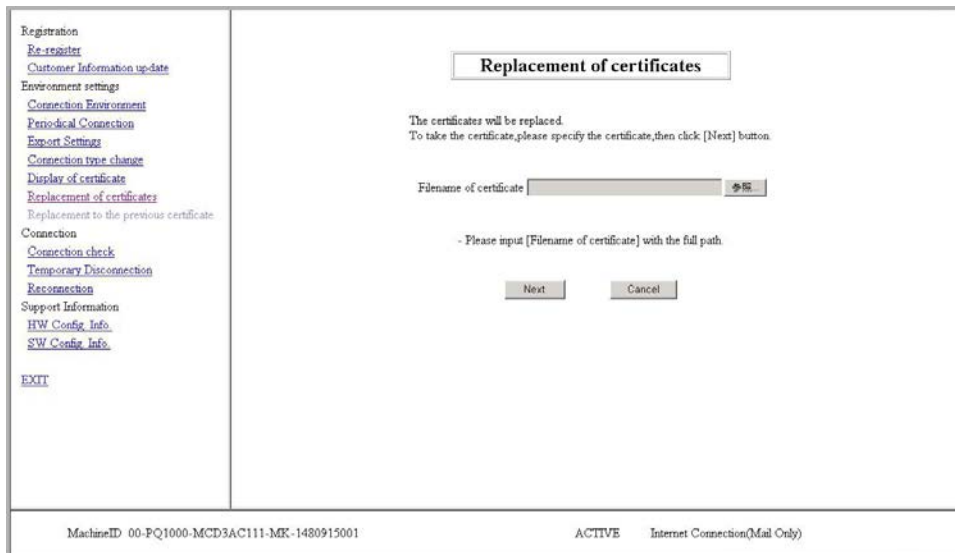

- Specify the certificate file and then click the [Next] button.

FIGURE 4.11 [Confirmation of certificate] window



- Confirm the display contents and, if they are acceptable, click the [Next] button. If you do not intend to replace a certificate, click the [Cancel] button.
- The following confirmation message is displayed. "The certificates will be replaced. Once the replacement of certificates proceeds, the report to the REMCS center will not be done until connected confirmation is completed. Are you sure?" If this is acceptable, click the [OK] button.
- The machine status display becomes [UNUSED] and the [Connection check] window appears. Upon confirmation, [ACTIVE] becomes effective.

4.2.9 Restoring a certificate

Use the following procedure to return to the previous certificate from the replacement certificate.

- From the menu in the window shown in [FIGURE 4.1 \[REMCS initial\] window](#), click [Replacement to the previous certificate].

The window shown in [FIGURE 4.12 \[Replacement to the previous certificate\] window](#) appears.

FIGURE 4.12 [Replacement to the previous certificate] window



2. Confirm the content of the <<Restored certificate>> and then click the [Next] button.
If you do not wish to restore the certificate, click the [Cancel] button.
3. The following confirmation message appears. "The certificates will be replaced. Once the replacement of certificates proceeds, the report to the REMCS center will not be done until connected confirmation is completed. Are you sure?" If this is acceptable, click the [OK] button.
4. The machine status becomes [UNUSED], and the [Connection check] window appears. Upon confirmation, [ACTIVE] becomes effective.

4.2.10 Connection check

Use this menu item to check the connection to the REMCS Center.

1. From the menu in the window shown in [FIGURE 4.1 \[REMCS initial\] window](#), click the [Connection check] button.

The [Connection check] window (the window shown in [FIGURE 4.13 \[Connection check\] window \(without personal information deleted\)](#) or [FIGURE 4.14 \[Connection check\] window \(with personal information deleted\)](#)) appears.

2. Confirm the setting of the receivers of the connection results and click the [Check] button.

FIGURE 4.13 [Connection check] window (without personal information deleted)

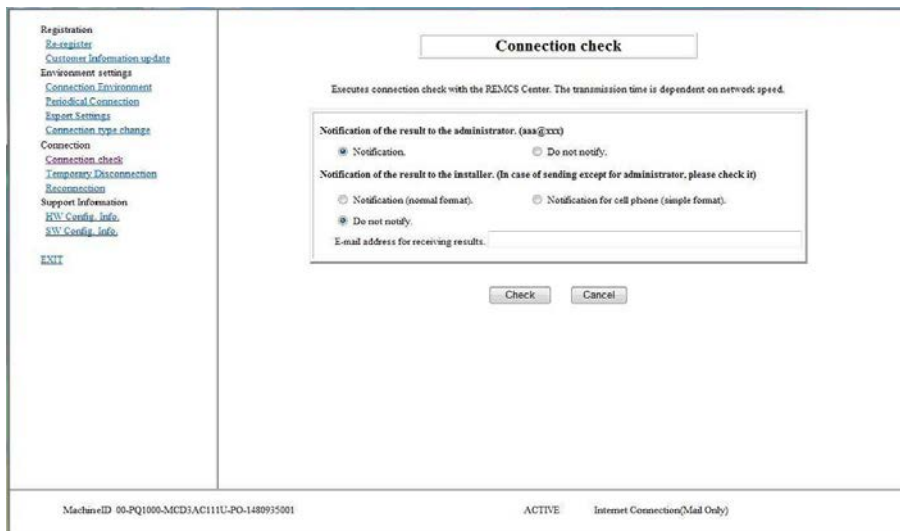

FIGURE 4.14 [Connection check] window (with personal information deleted)



3. The window shown in [FIGURE 4.15 \[Result of connection check\] window](#) appears. Click the [OK] button. You will be returned to the window shown in [FIGURE 4.1 \[REMCS initial\] window](#).

FIGURE 4.15 [Result of connection check] window



The e-mail addresses displayed in the [Connection check] window as the receivers of the connection results receive an e-mail notification of the completed connection check.

4.2.11 Temporary Disconnection

Use this menu item to temporarily disconnect from the REMCS Center.

- It disconnects the server from the REMCS Center when the server is stopped for maintenance or holidays and cannot establish periodic connections.
- While being disconnected from the REMCS Center, the system does not communicate with the REMCS Center at all.
- To restart the system operation after being disconnected from the REMCS Center, you need to perform [Reconnection].

1. From the menu in the window shown in [FIGURE 4.1 \[REMCS initial\] window](#), click [Temporary Disconnection].

The window shown in [FIGURE 4.16 \[Temporary Disconnection\] window](#) appears.

2. Click the [Disconnect] button. A confirmation dialog box appears and a notification of the temporary disconnection is sent to the REMCS Center.

After processing completes, a pop-up window appears with the results.

Then, the window shown in [FIGURE 4.1 \[REMCS initial\] window](#) appears.

FIGURE 4.16 [Temporary Disconnection] window



4.2.12 Reconnection

Use this menu item to re-establish the connection with the REMCS Center after a temporary disconnection. If the server operating status has been shown as [DISCONNECT], it becomes [ACTIVE].

1. If the status has been in [MAINTAIN/DISCONNECT], it becomes [MAINTAIN].
From the menu in the window shown in [FIGURE 4.1 \[REMCS initial\] window](#), click [Reconnection] to display the window shown in [FIGURE 4.17 \[Reconnection\] window](#).
2. Click the [Reconnect] button. A confirmation dialog box appears.
Send the notification of reconnection to the REMCS Center.
After processing completes, a pop-up window appears with the results.
Then, the window shown in [FIGURE 4.1 \[REMCS initial\] window](#) appears.

FIGURE 4.17 [Reconnection] window



4.2.13 HW Config. Info.

Use this menu item to send the hardware configuration information of the server to the REMCS Center. From the menu in the window shown in [FIGURE 4.1 \[REMCS initial\] window](#), click [HW Config. Info.] to display the window shown in [FIGURE 4.18 \[Sending Hardware Configuration Information\] window](#).

1. Click the [Send] button.

A confirmation dialog box appears. Send the hardware configuration information to the REMCS Center. After processing completes, a pop-up window appears with the results. Then, the window shown in [FIGURE 4.1 \[REMCS initial\] window](#) appears.

FIGURE 4.18 [Sending Hardware Configuration Information] window

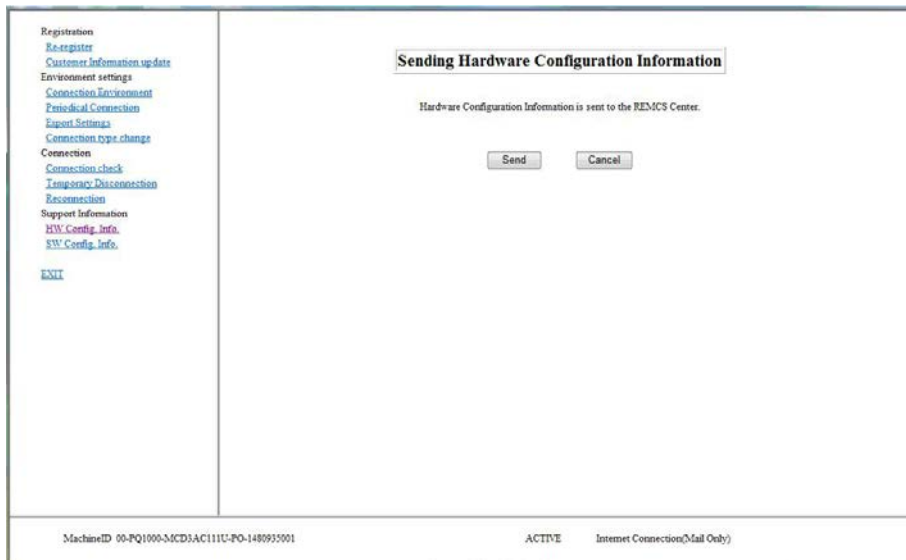

4.2.14 SW Config. Info.

Use this menu item to send the software configuration information of the server to the REMCS Center. From the menu in the window shown in [FIGURE 4.1 \[REMCS initial\] window](#), click [SW Config. Info.] to display the window shown in [FIGURE 4.19 \[Sending Software Configuration Information\] window](#).

1. Click the [Send] button.
A confirmation dialog box appears. Send the software configuration information to the REMCS Center. After processing completes, a pop-up window appears with the results. Then, the window shown in [FIGURE 4.1 \[REMCS initial\] window](#) appears.

FIGURE 4.19 [Sending Software Configuration Information] window

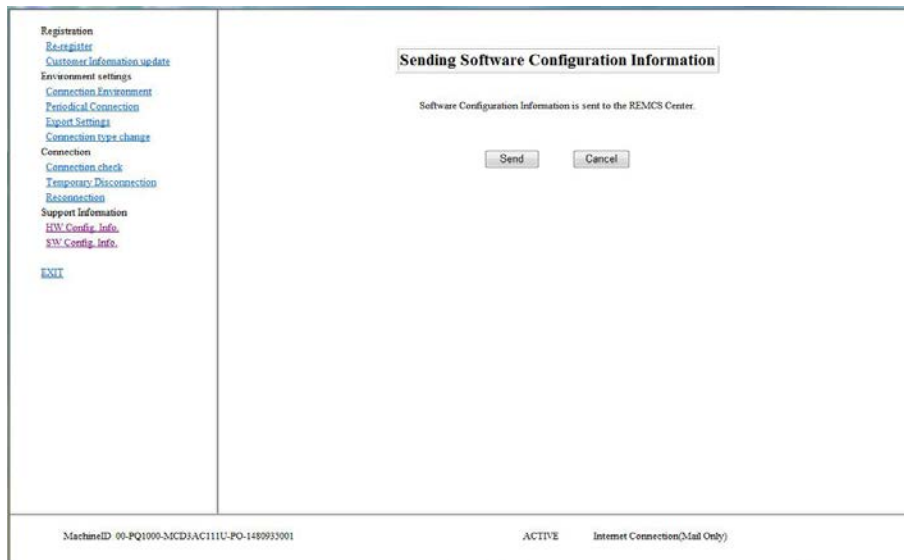

Remarks

It may take some time before the software configuration information of the partition takes effect. Therefore, the latest information may not be displayed immediately after the software replacement.

CHAPTER 5 CHAPTER 5 REMCS Service Detail Settings

This chapter describes the detail settings of the REMCS service.

5.1 Overview of REMCS Service Detail Settings

REMCS Service Detail Settings are used to make detailed settings such as the transmission retry count and timeout triggers for avoiding transmission problems. They are also used to change the REMCS Center to connect to, switch the machine name to be displayed, and for other purposes.

Normally, these settings need not be used. Use them when so instructed by a field engineer or the support center.

To start the window to be used for the REMCS service detail settings, select [Maintenance] - [REMCS] - [Detail Setup] from the MMB Web-UI.

The initial window shown in [FIGURE 5.1 FE operation initial window](#) appears.

FIGURE 5.1 FE operation initial window

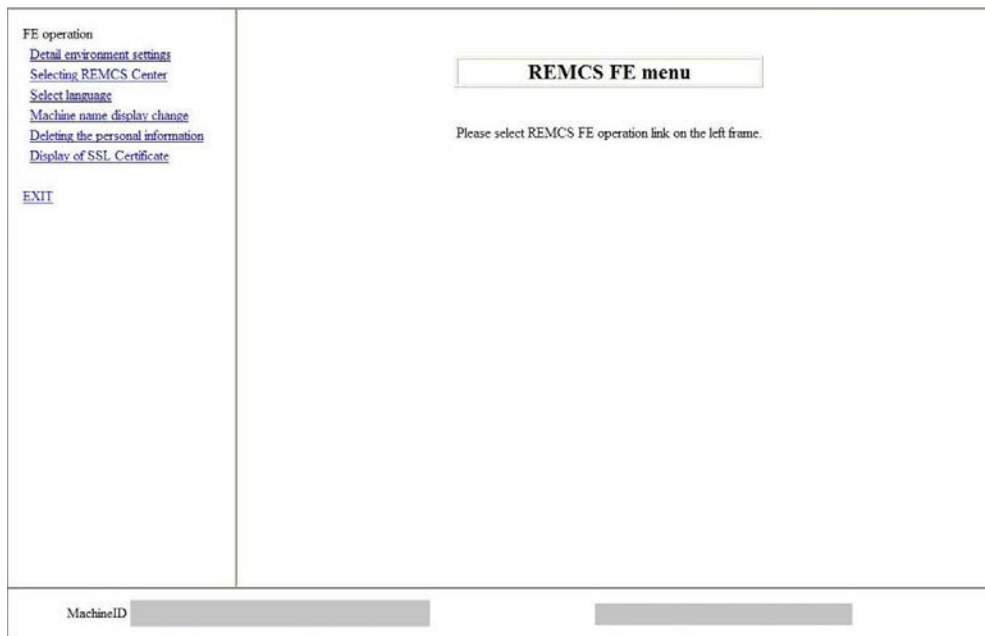

TABLE 5.1 Items of the FE operation initial window

Item	Description
Detail environment settings	Change the timeout triggers, the retry count, etc., that are applicable when the Internet is used.
Selecting REMCS Center	Changes the REMCS Center to connect to.
Select language	Switches the displayed language between Japanese and English.
Machine name display change	Specifies whether to use the machine ID or a unique name as the machine name displayed by the Web-GUI.
Deleting the personal information	Deletes the personal information included in the customer information.
Display of SSL Certificate	SSL certificate acquired by SMTP server will be displayed when sending is done on SMTPoverSSL (*1). If SSL certificate does not exist, following message will appear: " RMG_0229: TBD " *1: When STARTTLS or SSL/TLS is selected as type of encryption connection on [Environment settings] window

5.2 Detail Environment Settings

This item is used to change the communication environment settings for Internet use. The displayed window contents depend on the authentication type of the connection configuration as shown in [FIGURE 5.2 \[Environment settings\] window in case of internet connection \(only mail\)](#) and [FIGURE 5.3 \[Environment settings\] window in case of P-P connection](#). Take adequate care when making the setting. Otherwise it may become impossible to send events to the REMCS Center if an incorrect setting is made.

FIGURE 5.2 [Environment settings] window in case of internet connection (only mail)

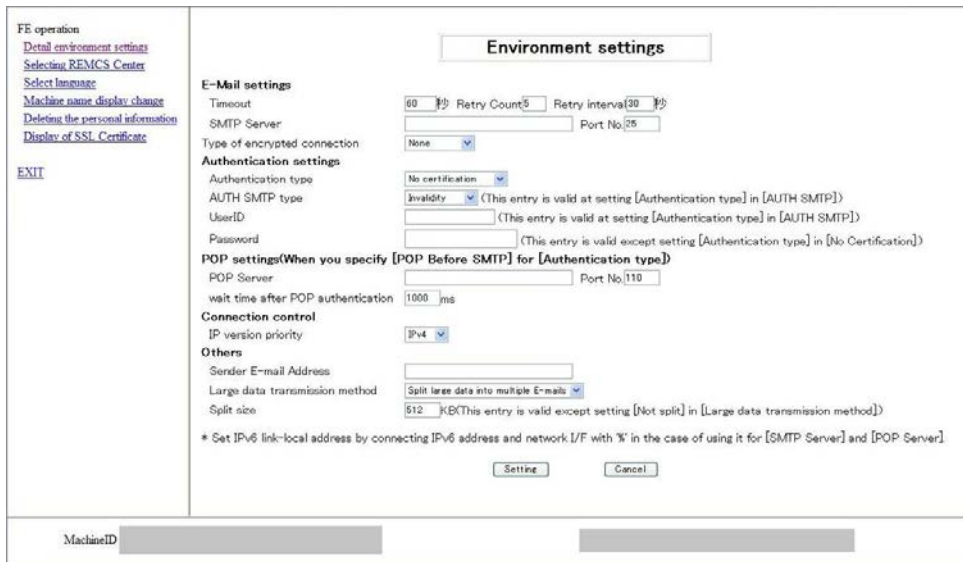

TABLE 5.2 Items in the [Environment settings] window in case of internet connection (only mail)

Input item	Maximum number of digits	Input	Description
E-Mail settings			
Timeout	4	Required	Enter the timeout trigger for E-Mail (seconds) in single-byte numeric characters. Range: 60 to 3600
Retry Count	2	Required	Enter the retry count for E-Mail in single-byte numeric characters.
Retry interval	3	Required	Enter the retry interval for E-Mail in single-byte numeric characters. Range: 1 to 600
SMTP server	128	Required	Enter the name of SMTP server or IP address in single-byte numeric character and alphabets
PORT No.	5	Required	Enter the port number of the SMTP server in single-byte numeric characters. Initial value: 25 (Well Known Port is used.) Range: 1 to 65535
Type of encrypted connection	-	Required	Select type of encrypted connection of SMTP over SSL from 'None' (default), 'STARTTLS' and 'SSL/TLS'
Authentication settings			
Authentication type	-	Required	Select authentication type from 'None', 'AUTO' (default), 'POP before SMTP', 'AUTH SMTP'.
AUTH SMTP type (This entry is valid at setting [Authentication type] in [AUTH SMTP])	-	Required	Select SMTP authentication from 'Auto' (default), 'CRAM-MD5', 'PLAIN', 'LOGIN'.

User ID	64	Required (*1)	Enter user ID of authentication server in single-byte numeric number and alphabets.
Password	64	Required (*1)	Enter password of authentication server in single-byte numeric number and alphabets. Entered values are all displayed as *.
POP settings (When you specify [POP Before SMTP] for [Authentication type])			
POP server	128	Required (*2)	Enter the name of POP server or IP address in single-byte numeric number and alphabets.
Port No.	5	Required	Enter the port number of the POP3 authentication server in single-byte numeric characters. Initial value: 110 (Well Known Port is used.) Range: 1 to 65535
wait time after POP authentication	4	Required	Enter the wait time from POP3 authentication to the start of mail sending (milliseconds) in single-byte numeric characters. Recommended value: 1000 ms Range: 0 to 30000
Connection control			
IP version priority	-	Required	Select the priority of IP version from 'none', 'IPv4 (default)' and 'IPv6'
Others			
Sender E-mail Address	128	Required	Enter the e-mail address of originator in single-byte numeric characters and alphabets.
Large data transmission method	-	Required	Select dividing method from 'none', 'event dividing' (default).
Split size	3	Required (*3)	Enter dividing size in single-byte numeric characters. - mail Default: 64 KB Range: 10 to 100 KB - event Default: 512 KB Range: 64 to 512 KB

*1: It is required if you select item except for 'None' in authentication type.

*2: It is required if you select item except for 'POP Before SMTP' in authentication type.

*3: It is required if you select item except for 'None' in dividing method.

FIGURE 5.3 [Environment settings] window in case of P-P connection

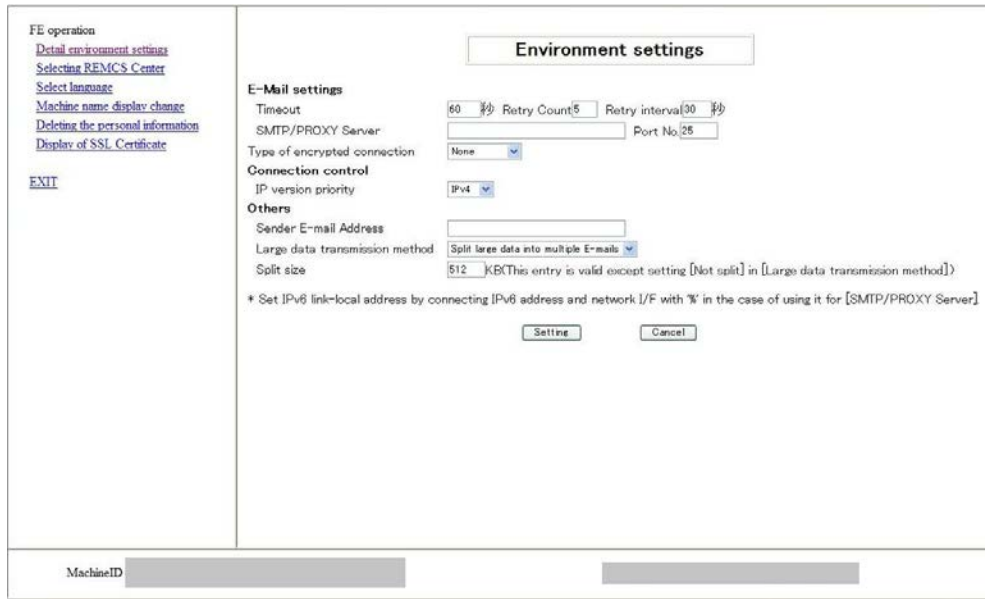

TABLE 5.3 Items in the [Environment settings] window in case of P-P connection

Input item	Maximum number of digits	Input	Description
E-Mail settings			
Timeout	4	Required	Enter the timeout trigger for E-Mail (seconds) in single-byte numeric characters. Range: 60 to 3600
Retry Count	2	Required	Enter the retry count for E-Mail in single-byte numeric characters.
Retry interval	3	Required	Enter the retry interval for E-Mail in single-byte numeric characters. Range: 1 to 600
SMTP/PROXY server	128	Required	Enter the name of SMTP/PROXY server or IP address in single-byte numeric character and alphabets
PORT No.	5	Required	Enter the port number of the SMTP server in single-byte numeric characters. Initial value: 25 (Well Known Port is used.) Range: 1 to 65535
Type of encrypted connection	-	Required	Select type of encrypted connection of SMTP over SSL from 'none' (default), 'STARTTLS' and 'SSL/TLS'
Connection control			
IP version priority	-	Required	Select the priority of IP version from 'none', 'IPv4 (default)' and 'IPv6'
Others			
Sender E-Mail Address	128	Required	Enter the e-mail address of originator in single-byte numeric characters and alphabets.
Large data transmission method	-	Required	Select dividing method from 'none', 'event dividing' (default).
Split size	3	Required (*1)	Enter dividing size in single-byte numeric characters. - mail Default: 64 KB Range: 10 to 100 KB - event Default: 512 KB Range: 64 to 512 KB

*1: It is required if you select item except for 'none' in dividing method.

1. From the initial window menu of the FE operation, select [Detail environment settings].
Depending on the current setting conditions, [FIGURE 5.2 \[Environment settings\] window in case of internet connection \(only mail\)](#) or [FIGURE 5.3 \[Environment settings\] window in case of P-P connection](#) appears.
2. Click the [Setting] button.
When a confirmation dialog box appears, register the setting.
After the processing, the result is displayed in a pop-up window, and the initial window is displayed again.
During operation, maintenance or stopping connection, [Confirming connection] window will appear.

5.3 Selecting REMCS Center

This item is used to change the REMCS Center to connect to.

1. From the initial window menu of the FE operation, select [Selecting REMCS Center] to display [FIGURE 5.4 \[Selecting REMCS Center\] window](#).
2. Select the REMCS center to connect to. It cannot be input directly. Select one from the provided list of REMCS Centers. The initial value is the current center name.
3. Click the [Setting] button. A confirmation dialog box appears. Register the setting.
After the processing, the result is reported in a pop-up window, and the initial window is displayed again.

FIGURE 5.4 [Selecting REMCS Center] window

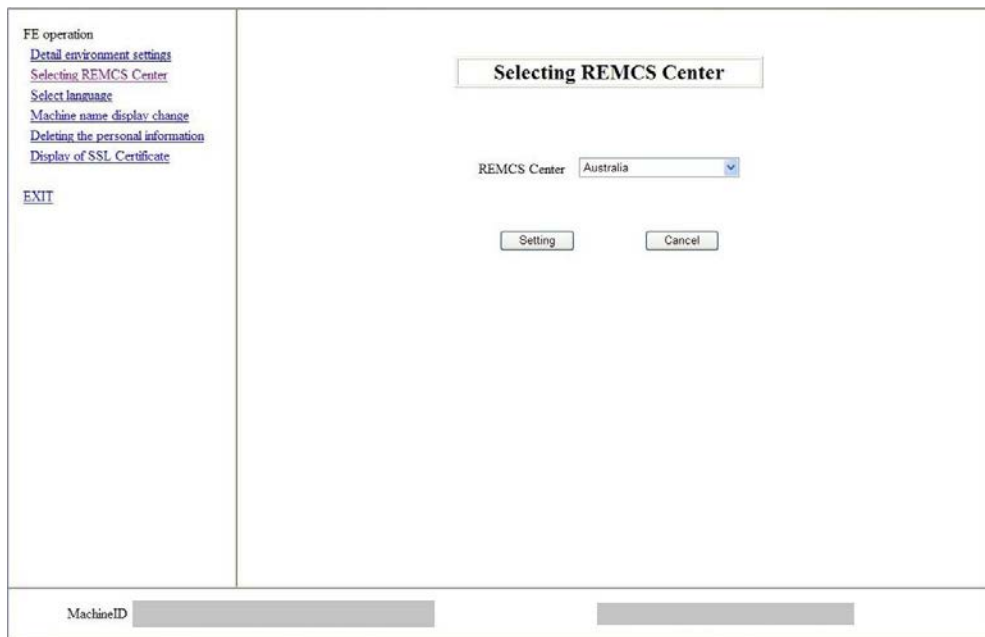

5.4 Select Language

This item is used for switching the displayed language between Japanese and English.

1. From the initial window menu of the FE operation, select [Select language] to display [FIGURE 5.5 \[Select language \(Japanese or English\)\] window](#).
2. Select [Japanese] or [English]. The initial value is the current setting value.
3. Click the [Setting] button.
When a confirmation dialog box appears, register the setting.
After the processing, the result is reported in a pop-up window, and the initial window is displayed again.

FIGURE 5.5 [Select language (Japanese or English)] window

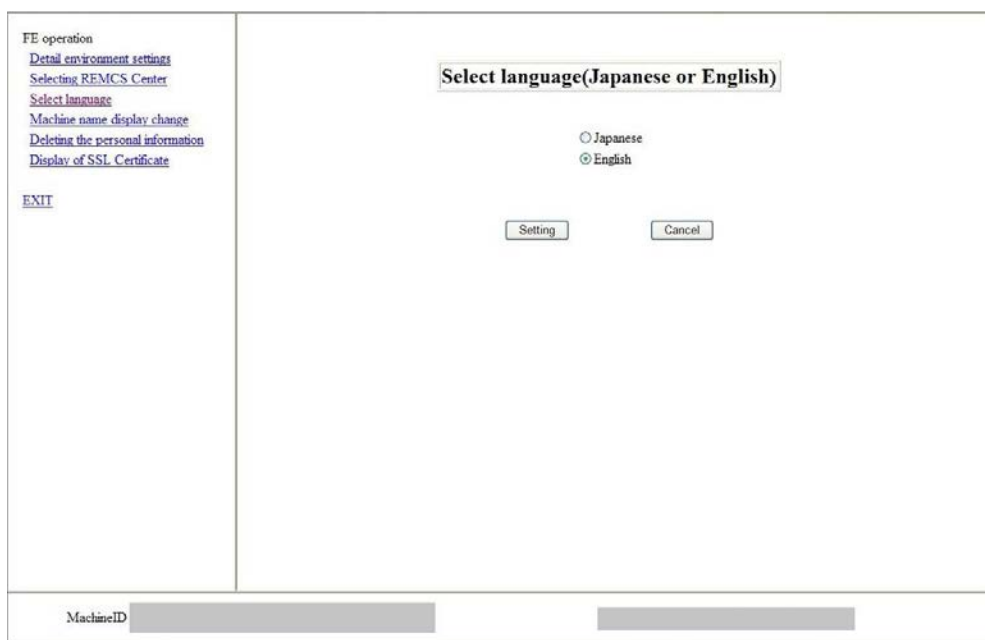

5.5 Machine Name Display Change

This item is used for switching the machine name to be displayed by the GUI between the machine ID or machine unique name, which has been specified in the [Customer Information] window.

1. From the initial window menu of the FE operation, select [Machine name display change] to display [FIGURE 5.6 \[Select to Display Machine ID or Machine Unique Name\] window](#).
2. Specify the machine name to be displayed in the state display frame. The initial value is the current setting value.
3. Click the [Setting] button.

When a confirmation dialog box appears, register the setting.

After the processing, the result is reported in a pop-up window, and the initial window is displayed again.

FIGURE 5.6 [Select to Display Machine ID or Machine Unique Name] window

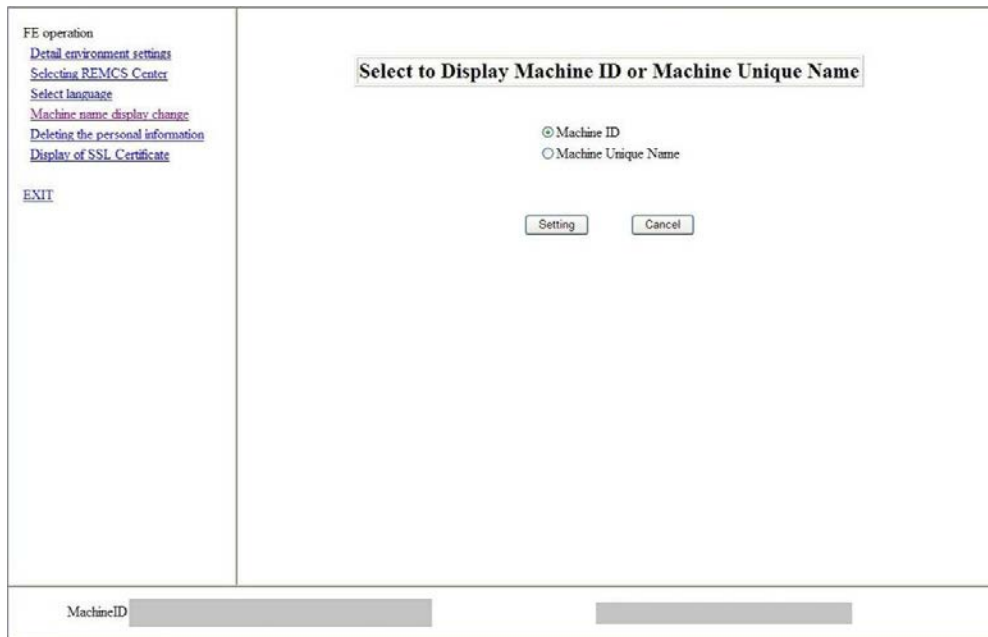

5.6 Deleting the Personal Information

This item is used for deleting the personal information included in the customer information after registration.

1. From the initial window menu of the FE operation, select [Deleting the personal information] to display [FIGURE 5.7 \[Deleting the personal information\] window](#).
2. When the [Delete] button is clicked, a confirmation dialog box appears. After the processing, the result is reported in a pop-up window.

FIGURE 5.7 [Deleting the personal information] window

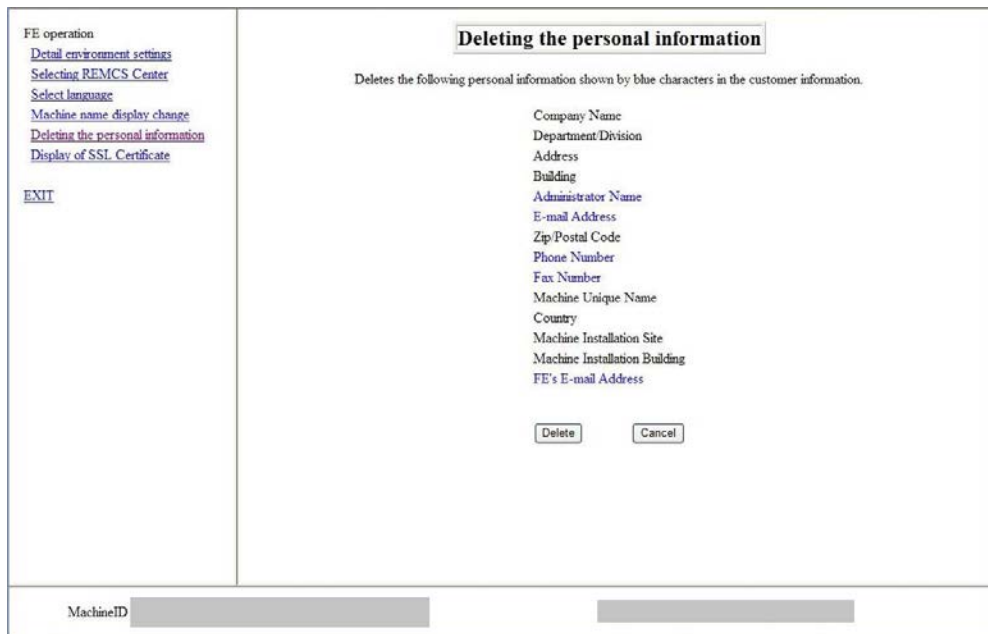

5.7 Display of certificate

This item is used for displaying and confirming SSL certificate.

1. From the initial window menu of the FE operation, select [Display of certificate] to display **エラー! 参照元が見つかりません。**
2. Click [End] button.

FIGURE 5.8 [Display of certificate] window (SSL)



CHAPTER 6 REMCS Messages

This chapter describes the major error messages that are displayed in the windows.

6.1 Messages in REMCS Windows

This section describes the messages displayed in the REMCS windows. In the messages, xxx represents a character string such as a returned value that should be replaced when printed out.

TABLE 6.1 Messages common to all windows

Message code	Message	Action
RMG_0150	Failed to read setting file. (xxx)	If the error still occurs when you retry the operation, exit and restart the REMCS window and try again. If the problem is not solved, contact the support center.
RMG_1121	This session was disconnected.(xxx)	
RMG_1123	This session was disconnected.	If operations need to be performed in the REMCS window, restart the REMCS window.
RMG_1125	Session timeout.	
RMG_1135	This session was disconnected.	

TABLE 6.2 Messages at GUI startup

Message code	Message	Action
RMG_0001	Failed to get Machine status. (xxx)	If the error still occurs when you retry the operation, exit and restart the REMCS window and try again. If the problem is not solved, contact the support center.
RMG_0002	Failed to make frame screen data. (xxx)	
RMG_0007	Failed to get Machine ID..(xxx)	
RMG_0012	Change language to English.	None.
RMG_0018	Failed to get registration data..(xxx)	If the error still occurs when you retry the operation, exit and restart the REMCS window and try again. If the problem is not solved, contact the support center.
RMG_0041	Failed to setting Machine status.(xxx)	
RMG_0164	Failed to change language to Japanese.(xxx)	
RMG_0165	Failed to change language to English.(xxx)	
RMG_0166	Change language to Japanese completed.	Proceed with registration.
RMG_0167	Changing language to English completed.	
RMG_0172	Failed to get Destination information. (xxx)	If the error still occurs when you retry the operation, exit and restart the REMCS window and try again. If the problem is not solved, contact the support center.
RMG_0188	The setting file error was detected and initialized it.	Perform registration.
RMG_0193	The REMCS frame is not displayed, because the REMCS module is not available.	If the error still occurs when you retry the operation, exit and restart the REMCS window and try again. If the problem is not solved, contact the support center.

TABLE 6.3 Messages in the menu frame

Message code	Message	Action
RMG_0001	Failed to get Machine status. (xxx)	If the error still occurs when you retry the operation, exit and restart the REMCS window and try again. If the
RMG_0002	Failed to make frame screen data. (xxx)	
RMG_0004	Invalid CGI parameter specified.	

		problem is not solved, contact the support center.
RMG_0005	Frame data make completed.	None.
RMG_0006	Failed to get connect mode. (xxx)	If the error still occurs when you retry the operation, exit and restart the REMCS window and try again. If the problem is not solved, contact the support center.
RMG_0035	REMCS menu close. Are you sure?	Click the [OK] or [Cancel] button.

TABLE 6.4 Messages in the state display frame

Message code	Message	Action
RMG_0001	Failed to get Machine status. (xxx)	If the error still occurs when you retry the operation, exit and restart the REMCS window and try again. If the problem is not solved, contact the support center.
RMG_0002	Failed to make frame screen data.(xxx)	
RMG_0004	Invalid CGI parameter specified.	
RMG_0006	Failed to get connect mode. (xxx)	
RMG_0065	Failed to get customer information.(xxx)	

TABLE 6.5 Messages in the setting progress display window

Message code	Message	Action
RMG_0001	Failed to get Machine status. (xxx)	If the error still occurs when you retry the operation, exit and restart the REMCS window and try again. If the problem is not solved, contact the support center.
RMG_0002	Failed to make frame screen data.(xxx)	
RMG_0004	Invalid CGI parameter specified.	
RMG_0035	REMCS menu close. Are you sure?	Click the [OK] or [Cancel] button.

TABLE 6.6 Messages in the [Customer Information] window

Message code	Message	Action
RMG_0002	Failed to make frame screen data.(xxx)	If the error still occurs when you retry the operation, exit and restart the REMCS window and try again. If the problem is not solved, contact the support center.
RMG_0004	Invalid CGI parameter specified.	
RMG_0010	Customer Information Registration frame display completed.	None.
RMG_0018	Failed to get registration data..(xxx)	If the error still occurs when you retry the operation, exit and restart the REMCS window and try again. If the problem is not solved, contact the support center.

TABLE 6.7 Messages in the initial window

Message code	Message	Action
RMG_0002	Failed to make frame screen data. (xxx)	If the error still occurs when you retry the operation, exit and restart the REMCS window and try again. If the problem is not solved, contact the support center.
RMG_0004	Invalid CGI parameter specified.	
RMG_0008	Initial frame display completed.	None.

TABLE 6.8 Messages in the [Initial Settings] window

Message code	Message	Action
RMG_0001	Failed to get Machine status. (xxx)	If the error still occurs when you retry the operation, exit and restart the REMCS window and try again. If the problem is not solved, contact the support center.
RMG_0002	Failed to make frame screen data. (xxx)	
RMG_0004	Invalid CGI parameter specified.	
RMG_0006	Failed to get connect mode. (xxx)	
RMG_0011	Initial Settings frame display completed.	None.
RMG_0025	Failed to set connection mode. (xxx)	If the error still occurs when you retry the operation, exit and restart the REMCS window and try again. If the problem is not solved, contact the support center.
RMG_0026	Changed connection mode to xxx.	None.
RMG_0027	Failed to change Machine status. (xxx)	If the error still occurs when you retry the operation, exit and restart the REMCS window and try again. If the problem is not solved, contact the support center.

TABLE 6.9 Messages in the [Importation of the REMCS settings] window

Message code	Message	Action
RMG_0002	Failed to make frame screen data. (xxx)	If the error still occurs when you retry the operation, exit and restart the REMCS window and try again. If the problem is not solved, contact the support center.
RMG_0004	Invalid CGI parameter specified.	
RMG_0015	Invalid entry.	Correct the entered value.
RMG_0027	Failed to change Machine status. (xxx)	If the error still occurs when you retry the operation, exit and restart the REMCS window and try again. If the problem is not solved, contact the support center.
RMG_0032	The specified file can not be imported.	Specify a valid file.
RMG_0033	Invalid directory name specified.	Specify a valid directory name.
RMG_0036	Required entry.	Enter a valid value.
RMG_0096	The specified file includes an unsupported connection type. The environment information cannot be imported.	Specify a file with the same connection type.
RMG_0118	Failed to import the environment information and the customer information.(xxx)	If the error still occurs when you retry the operation, exit and restart the REMCS window and try again. If the problem is not solved, contact the support center.
RMG_0142	The file doesn't exist in the selected directory.	Specify the directory in which the file is located.
RMG_0143	Invalid REMCS environment information file.	Specify a valid file and try again.
RMG_0144	Invalid customer information file.	
RMG_0194	Automatic registration failed, because there was no required entry in the Customer information file.	Check the customer information file contents, correct the error, and then try again.
RMG_0196	Failed to delete personal information.(xxx)	If the error still occurs when you retry the operation, exit and restart the REMCS window and try again. If the

		problem is not solved, contact the support center.
RMG_0210	Personal information deletion frame display has been completed.	None.

TABLE 6.10 Messages in the [Customer Information Review] window

Message code	Message	Action
RMG_0002	Failed to make frame screen data. (xxx)	If the error still occurs when you retry the operation, exit and restart the REMCS window and try again. If the problem is not solved, contact the support center.
RMG_0004	Invalid CGI parameter specified.	
RMG_0150	Failed to read setting file.(xxx)	
RMG_0215	This certificate cannot be verified up to a CA certificate.	None.

TABLE 6.11 Messages in the [Automatic registration state] window

Message code	Message	Action
RMG_0002	Failed to make frame screen data. (xxx)	If the error still occurs when you retry the operation, exit and restart the REMCS window and try again. If the problem is not solved, contact the support center.
RMG_0004	Invalid CGI parameter specified.	
RMG_0038	Automatic registration started.	None.
RMG_0039	Automatic registration completed.	
RMG_0040	Automatic registration failed. (xxx:xxx)	If the error still occurs when you retry the operation, exit and restart the REMCS window and try again. If the problem is not solved, contact the support center.

TABLE 6.12 Messages in the [Internet (Mail Only) connection environment settings] window

Message code	Message	Action
RMG_0001	Failed to get Machine status. (xxx)	If the error still occurs when you retry the operation, exit and restart the REMCS window and try again. If the problem is not solved, contact the support center.
RMG_0002	Failed to make frame screen data.(xxx)	
RMG_0004	Invalid CGI parameter specified	
RMG_0006	Failed to get connect mode. (xxx)	
RMG_0015	Invalid entry.	Correct the entered value.
RMG_0016	Input value is out of range.	
RMG_0018	Failed to get registration data (xxx)	If the error still occurs when you retry the operation, exit and restart the REMCS window and try again. If the problem is not solved, contact the support center.
RMG_0030	Specify [UserID]/[Password]/[POP Server] all when you specify POP server.	Correct the specified POP server information.
RMG_0031	Specify [UserID]/[Password] all when you specify AUTH SMTP.	Correct the specified AUTH SMTP information.
RMG_0036	Required entry.	Enter a valid value.
RMG_0037	Execute registration of REMCS environment data. Are you sure?	Click the [OK] or [Cancel] button.
RMG_0041	Failed to setting Machine status.(xxx)	If the error still occurs when you retry the operation, exit and restart the REMCS window and try again. If the problem is not solved, contact the support center.

RMG_0042	Internet(Mail Only) connection environment setting frame display completed.	None.
RMG_0043	Failed to set REMCS environment (Internet connection(Mail only)). (xxx)	Confirm the FQDN or IP address of the specified SMTP server. Also check whether the network status is normal.
RMG_0044	Registration of REMCS environment data (Internet connection(Mail only)) completed.	None.
RMG_0056	Failed in the connection check notification. (xxx)	Check whether the network status is normal.
RMG_0095	Connection type mismatch.	If the error still occurs when you retry the operation, exit and restart the REMCS window and try again. If the problem is not solved, contact the support center.
RMG_0181	Invalid E-mail address specified.	Enter a valid value.
RMG_0189	Execute registration of REMCS environment data.After this operation, all events are not sent to the REMCS Center until connection check is completed. \nAre you sure?	Click the [OK] or [Cancel] button.
RMG_0207	Invalid value in [Split size].Please specify it within the range of 10-100.	Enter a valid value.
RMG_0208	Invalid value in [Split size].Please specify it within the range of 64-512.	

TABLE 6.13 Messages in the [Point-to-Point Connection environment settings] window

Message code	Message	Action
RMG_0001	Failed to get Machine status. (xxx)	If the error still occurs when you retry the operation, exit and restart the REMCS window and try again. If the problem is not solved, contact the support center.
RMG_0002	Failed to make frame screen data. (xxx)	
RMG_0004	Invalid CGI parameter specified.	
RMG_0006	Failed to get connect mode. (xxx)	
RMG_0015	Invalid entry.	Correct the entered value.
RMG_0018	Failed to get registration data.(xxx)	If the error still occurs when you retry the operation, exit and restart the REMCS window and try again. If the problem is not solved, contact the support center.
RMG_0028	Input all entries.	Fill in any blank entries.
RMG_0037	Execute registration of REMCS environment data. Are you sure?	Click the [OK] or [Cancel] button.
RMG_0041	Failed to setting Machine status.(xxx)	If the error still occurs when you retry the operation, exit and restart the REMCS window and try again. If the problem is not solved, contact the support center.
RMG_0056	Failed in the connection check notification. (xxx)	Check whether the network status is normal.
RMG_0079	Point-to-Point Connection environment setting frame display completed.	None.
RMG_0080	Failed to set REMCS environment(Point-to-Point).(xxx)	Confirm the FQDN or IP address of the specified SMTP server. Also check whether the network status is normal.
RMG_0081	Registration of REMCS environment data (Point-to-Point) completed.	None.

RMG_0095	Connection type mismatch.	If the error still occurs when you retry the operation, exit and restart the REMCS window and try again. If the problem is not solved, contact the support center.
RMG_0181	Invalid E-mail address specified.	Enter a valid value.
RMG_0189	Execute registration of REMCS environment data.After this operation, all events are not sent to the REMCS Center until connection check is completed. \nAre you sure?	Click the [OK] or [Cancel] button.
RMG_0207	Invalid value in [Split size].Please specify it within the range of 10-100.	Enter a valid value.
RMG_0208	Invalid value in [Split size].Please specify it within the range of 64-512.	

TABLE 6.14 Messages in the [Periodical Connection settings] window

Message code	Message	Action
RMG_0001	Failed to get Machine status. (xxx)	If the error still occurs when you retry the operation, exit and restart the REMCS window and try again. If the problem is not solved, contact the support center.
RMG_0002	Failed to make frame screen data. (xxx)	
RMG_0004	Invalid CGI parameter specified.	
RMG_0006	Failed to get connect mode. (xxx)	
RMG_0015	Invalid entry.	Correct the entered value.
RMG_0016	Input value is out of range.	
RMG_0018	Failed to get registration data.(xxx)	If the error still occurs when you retry the operation, exit and restart the REMCS window and try again. If the problem is not solved, contact the support center.
RMG_0027	Failed to change Machine status. (xxx)	
RMG_0036	Required entry.	Enter a valid value.
RMG_0048	Invalid end time.	Confirm the start time and set a valid end time.
RMG_0049	Execute registration of periodical connection schedule. Are you sure?	Click the [OK] or [Cancel] button.
RMG_0050	Periodical Connection setting frame display completed.	None.
RMG_0051	Failed to register the periodical connection schedule. (xxx)	Check whether the network status is normal.
RMG_0052	Failed to set the periodical connection schedule. (xxx)	If the error still occurs when you retry the operation, exit and restart the REMCS window and try again. If the problem is not solved, contact the support center.
RMG_0054	Registration of the periodical connection schedule completed.	None.
RMG_0056	Failed in the connection check notification.(xxx)	Check whether the network status is normal.
RMG_0186	Failed to send notice of changing agent information.	
RMG_0187	Failed to send agent information.	

TABLE 6.15 Messages in the [Customer Information] window

Message code	Message	Action
RMG_0001	Failed to get Machine status. (xxx)	If the error still occurs when you retry the operation, exit and restart the REMCS
RMG_0002	Failed to make frame screen data. (xxx)	
RMG_0004	Invalid CGI parameter specified.	

RMG_0006	Failed to get connect mode. (xxx)	window and try again. If the problem is not solved, contact the support center.
RMG_0015	Invalid entry.	Correct the entered value.
RMG_0018	Failed to get registration data. (xxx)	If the error still occurs when you retry the operation, exit and restart the REMCS window and try again. If the problem is not solved, contact the support center.
RMG_0029	Invalid length.	Enter a valid length.
RMG_0036	Required entry.	Enter a valid value.
RMG_0065	Failed to get customer information.(xxx)	If the error still occurs when you retry the operation, exit and restart the REMCS window and try again. If the problem is not solved, contact the support center.
RMG_0066	Customer Information setting frame display completed.	None.
RMG_0068	Invalid character specified in [Company Name].	Confirm the valid characters and correct the entry.
RMG_0069	Invalid character specified in [Department/Division].	
RMG_0070	Invalid character specified in [Address].	
RMG_0071	Invalid character specified in [Building].	
RMG_0072	Invalid character specified in [Administrator Name].	
RMG_0073	Invalid character specified in [Machine Installation Site]	
RMG_0074	Invalid character specified in [Machine Installation Building].	
RMG_0075	Characters that cannot be specified are included in the [Company Name(kana)] of customer information.	
RMG_0076	Characters that cannot be specified are included in the [Administrator Name(kana)] of customer information.	
RMG_0181	Invalid E-mail address specified.	

TABLE 6.16 Message in the [Customer Information Review] window

Message code	Message	Action
RMG_0001	Failed to get Machine status. (xxx)	If the error still occurs when you retry the operation, exit and restart the REMCS window and try again. If the problem is not solved, contact the support center.
RMG_0002	Failed to make frame screen data. (xxx)	
RMG_0004	Invalid CGI parameter specified.	
RMG_0041	Failed to setting Machine status.(xxx)	
RMG_0067	Customer Information frame display completed.	None.
RMG_0077	Failed to register customer information. (xxx)	Confirm that HOSTNAME is specified in the MMB Network Interface setting. If the error still occurs when you retry the operation, exit and restart the REMCS window and try again. If the problem is not solved, contact the support center.
RMG_0078	Customer information registration completed.	None.

TABLE 6.17 Message in the [Information Transmit Agreement] window

Message code	Message	Action
--------------	---------	--------

RMG_0001	Failed to get Machine status. (xxx)	If the error still occurs when you retry the operation, exit and restart the REMCS window and try again. If the problem is not solved, contact the support center.
RMG_0002	Failed to make frame screen data. (xxx)	
RMG_0004	Invalid CGI parameter specified.	
RMG_0006	Failed to get connect mode. (xxx)	
RMG_0041	Failed to setting Machine status.(xxx)	
RMG_0056	Failed in the connection check notification. (xxx)	Check whether the network status is normal.
RMG_0082	Registration started.	None.
RMG_0083	Update registration started.	
RMG_0084	Agreement of sending information frame display completed.	
RMG_0085	Registration failed. (xxx)	If the error still occurs when you retry the operation, exit and restart the REMCS window and try again. If the problem is not solved, contact the support center.
RMG_0086	Executed registration.	None.
RMG_0088	Update registration failed.(xxx)	If the error still occurs when you retry the operation, exit and restart the REMCS window and try again. If the problem is not solved, contact the support center.
RMG_0089	Executed update registration.	None.
RMG_0128	Execute registration.	

TABLE 6.18 Messages in the [Registration result] window

Message code	Message	Action
RMG_0001	Failed to get Machine status.(xxx)	If the error still occurs when you retry the operation, exit and restart the REMCS window and try again. If the problem is not solved, contact the support center.
RMG_0002	Failed to make frame screen data.(xxx)	
RMG_0004	Invalid CGI parameter specified.	
RMG_0082	Registration started. None.	None.
RMG_0083	Update registration started.	
RMG_0085	Registration failed.(xxx)	Check whether the network status is normal.
RMG_0086	Executed registration.	None.
RMG_0087	Registration result frame display completed.	
RMG_0088	Update registration failed.(xxx)	Check whether the network status is normal.
RMG_0089	Executed update registration.	None.

TABLE 6.19 Messages in the [Exportation of the REMCS settings] window

Message code	Message	Action
RMG_0002	Failed to make frame screen data. (xxx)	If the error still occurs when you retry the operation, exit and restart the REMCS window and try again. If the problem is not solved, contact the support center.
RMG_0004	Invalid CGI parameter specified.	
RMG_0015	Invalid entry.	
RMG_0033	Invalid directory name specified.	Enter a valid directory.
RMG_0036	Required entry.	Enter data for the item.
RMG_0120	The frame display of the exportation of the environment information and the customer information has completed.	None.
RMG_0121	Failed to export the environment information.(xxx)	If the error still occurs when you retry the operation, exit and restart the REMCS window and try again. If the
RMG_0122	Failed to export the customer information.(xxx)	

		problem is not solved, contact the support center.
RMG_0123	Exportation of the environment information has been completed.	None.
RMG_0124	Exportation of the customer information has been completed.	
RMG_0125	Export customer information to a file.	Click the [OK] or [Cancel] button
RMG_0126	Export the environment information to a file.	
-	Close this screen after you finish export.	Close the screen after finishing export.

TABLE 6.20 Messages in the [Connection check] window or [Connection check information] window

Message code	Message	Action
RMG_0001	Failed to get Machine status. (xxx)	If the error still occurs when you retry the operation, exit and restart the REMCS window and try again. If the problem is not solved, contact the support center.
RMG_0002	Invalid CGI parameter specified.	
RMG_0004	Failed to make frame screen data. (xxx)	
RMG_0015	Invalid CGI parameter specified.	Correct the entered value.
RMG_0041	Failed to setting Machine status.(xxx)	If the error still occurs when you retry the operation, exit and restart the REMCS window and try again. If the problem is not solved, contact the support center.
RMG_0053	Execute the connection check. Are you sure?	Click the [OK] or [Cancel] button
RMG_0055	Connection check frame display completed.	
RMG_0056	Failed in the connection check notification. (xxx)	
RMG_0058	Connection check notification completed.	None.
RMG_0181	Invalid E-mail address specified.	Enter a valid value.
RMG_0182	Enter E-mail address of administrator or installer.	Specify a valid value.
RMG_0183	Specify [E-mail address for receiving results.].	Enter a valid value.

TABLE 6.21 Messages in the [Result of connection check] window

Message code	Message	Action
RMG_0002	Failed to make frame screen data. (xxx)	If the error still occurs when you retry the operation, exit and restart the REMCS window and try again. If the problem is not solved, contact the support center.
RMG_0004	Invalid CGI parameter specified.	
RMG_0041	Failed to setting Machine status. (xxx)	
RMG_0056	Failed in the connection check notification.(xxx)	Check whether the network status is normal.
RMG_0058	Connection check notification completed. None.	None.
RMG_0185	Connection check frame display completed.	

TABLE 6.22 Messages in the [Temporary Disconnection] window or [Reconnection] window

Message code	Message	Action
RMG_0001	Failed to get Machine status. (xxx)	If the error still occurs when you retry the operation, exit and restart the REMCS window and try again. If the problem is not solved, contact the support center.
RMG_0002	Failed to make frame screen data. (xxx)	
RMG_0004	Invalid CGI parameter specified.	
RMG_0041	Failed to setting Machine status.(xxx)	
RMG_0059	Execute temporary disconnection to the REMCS Center. Are you sure?	Click the [OK] or [Cancel] button.
RMG_0060	Reconnection to the REMCS Center	None.

	completed.	
RMG_0061	Temporary disconnection to the REMCS Center completed.	
RMG_0062	Temporary disconnection frame display completed.	
RMG_0063	Reconnection frame display completed.	
RMG_0064	Execute reconnection to the REMCS Center. Are you sure?	Click the [OK] or [Cancel] button.
RMG_0092	Registration has not executed, Setup is incomplete.	Retry after registration is complete.

TABLE 6.23 Message in the [Sending Hardware Configuration Information] window

Message code	Message	Action
RMG_0002	Failed to make frame screen data. (xxx)	If the error still occurs when you retry the operation, exit and restart the REMCS window and try again. If the problem is not solved, contact the support center.
RMG_0004	Invalid CGI parameter specified.	
RMG_0130	Sending Hardware Configuration Information frame display completed.	None.
RMG_0132	Sending hardware configuration information completed.	
RMG_0133	Failed to send hardware configuration information. (xxx)	Check whether the network status is normal.
RMG_0136	Send hardware configuration information to the REMCS Center.	Click the [OK] or [Cancel] button.
RMG_0138	Execute hardware configuration information sending. Confirm sending result on event log display frame.	Confirm sending result on event log display frame.
RMG_0140	Hardware configuration information sending started.	None.

TABLE 6.24 Message in the [Sending Software Configuration Information] window

Message code	Message	Action
RMG_0002	Failed to make frame screen data. (xxx)	If the error still occurs when you retry the operation, exit and restart the REMCS window and try again. If the problem is not solved, contact the support center.
RMG_0004	Invalid CGI parameter specified.	
RMG_0131	Sending Software Configuration Information frame display completed.	None.
RMG_0134	Sending software configuration information completed.	
RMG_0135	Failed to send software configuration information. (xxx)	Check whether the network status is normal.
RMG_0137	Send software configuration information to the REMCS Center.	Click the [OK] or [Cancel] button.
RMG_0139	Execute software configuration information sending. Confirm sending result on event log display frame.	Confirm sending result on event log display frame.
RMG_0141	Software configuration information sending started.	None.

TABLE 6.25 Messages in the CE initial frame

Message code	Message	Action
RMG_0002	Failed to make frame screen data. (xxx)	If the error still occurs when you retry the operation, exit and restart the REMCS window and try again. If the problem is not solved, contact the support center.
RMG_0004	Invalid CGI parameter specified.	

RMG_0009	FE initial frame display completed.	None.
----------	-------------------------------------	-------

TABLE 6.26 Messages in the [Environment settings] window

Message code	Message	Action
RMG_0001	Failed to get Machine status.(xxx) \n(MachineID=xxxxxx)	If the error still occurs when you retry the operation, exit and restart the REMCS window and try again. If the problem is not solved, contact the support center.
RMG_0002	Failed to make frame screen data. (xxx)	
RMG_0004	Invalid CGI parameter specified.	Correct the entered value.
RMG_0015	Invalid entry.	
RMG_0016	Input value is out of range.	
RMG_0018	Failed to get registration data.(xxx)	If the error still occurs when you retry the operation, exit and restart the REMCS window and try again. If the problem is not solved, contact the support center.
RMG_0019	Settings of detail environment frame display completed.	None.
RMG_0021	Failed to register REMCS environment data.(xxx)	If the error still occurs when you retry the operation, exit and restart the REMCS window and try again. If the problem is not solved, contact the support center.
RMG_0022	Registration of REMCS environment data completed. None.	None.
RMG_0023	REMCS environment data registration completed.	
RMG_0036	Required entry. Enter a valid value.	
RMG_0037	Execute registration of REMCS environment data. Are you sure?	Click the [OK] or [Cancel] button.
RMG_0189	All events are not sent to the REMCS Center until environment setting is completed . Are you sure?	

TABLE 6.27 Messages in the [Selecting REMCS Center] window

Message code	Message	Action
RMG_0002	Failed to make frame screen data. (xxx)	If the error still occurs when you retry the operation, exit and restart the REMCS window and try again. If the problem is not solved, contact the support center.
RMG_0004	Invalid CGI parameter specified.	
RMG_0018	Failed to get registration data. (xxx)	
RMG_0027	Failed to change Machine status.	
RMG_0097	Failed to read connection point list file. (xxx)	
RMG_0098	Select REMCS Center frame display completed. None.	None.
RMG_0099	Failed to change the REMCS Center. (xxx)	If the error still occurs when you retry the operation, exit and restart the REMCS window and try again. If the problem is not solved, contact the support center.
RMG_0100	The Connected REMCS Center change completed. None.	None.
RMG_0101	Change the REMCS Center address completed.	
RMG_0102	Change the REMCS Center address. Execute registration again.	Perform registration.
RMG_0103	Change the REMCS Center address. Are you sure?	Click the [OK] or [Cancel] button.
RMG_0150	Failed to read setting file. (xxx)	If the error still occurs when you retry the operation, exit
RMG_0172	Failed to get Destination information. (xxx)	

		and restart the REMCS window and try again. If the problem is not solved, contact the support center.
--	--	---

TABLE 6.28 Messages in the [Select language(Japanese or English)] window

Message code	Message	Action
RMG_0002	Failed to make frame screen data. (xxx)	If the error still occurs when you retry the operation, exit and restart the REMCS window and try again. If the problem is not solved, contact the support center.
RMG_0004	Invalid CGI parameter specified.	
RMG_0041	Failed to setting Machine status.(xxx)	
RMG_0162	Select language(Japanese or English) frame display completed.	None.
RMG_0163	Change language. After this operation, you have to execute registration again. Are you sure?	Click the [OK] or [Cancel] button.
RMG_0164	Failed to change language to Japanese.(xxx)	If the error still occurs when you retry the operation, exit and restart the REMCS window and try again. If the problem is not solved, contact the support center.
RMG_0165	Failed to change language to English.(xxx)	
RMG_0166	Change language to Japanese completed.	
RMG_0167	Changing language to English completed.	Proceed with registration.
RMG_0190	Change language.Are you sure?	Click the [OK] or [Cancel] button.

TABLE 6.29 Messages in the [Select to Display Machine ID or Machine Unique Name] window

Message code	Message	Action
RMG_0002	Failed to make frame screen data. (xxx)	If the error still occurs when you retry the operation, exit and restart the REMCS window and try again. If the problem is not solved, contact the support center.
RMG_0004	Invalid CGI parameter specified.	
RMG_0104	Change machine name. Are you sure?	
RMG_0105	Machine name display change frame display completed.	None.
RMG_0106	Changing machine name display completed.	

TABLE 6.30 Messages in the processing progress display window

Message code	Message	Action
RMG_0002	Failed to make frame screen data. (xxx)	If the error still occurs when you retry the operation, exit and restart the REMCS window and try again. If the problem is not solved, contact the support center.
RMG_0004	Invalid CGI parameter specified.	

TABLE 6.31 Messages in the [Deleting the personal information] window

Message code	Message	Action
RMG_0002	Failed to make frame screen data. (xxx)	If the error still occurs when you retry the operation, exit and restart the REMCS window and try again. If the problem is not solved, contact the support center.
RMG_0004	Invalid CGI parameter specified.	
RMG_0195	Personal information is deleted. Are you sure?	Click the [OK] or [Cancel] button.

RMG_0196	Failed to delete personal information.(xxx)	If the error still occurs when you retry the operation, exit and restart the REMCS window and try again. If the problem is not solved, contact the support center.
RMG_0209	Deleting the personal information is completed.	None.
RMG_0210	Personal information deletion frame display has been completed.	

TABLE 6.32 Messages in the [Replacement of certificates] window

Message code	Message	Action
RMG_0002	Failed to make frame screen data. (xxx)	If the error still occurs when you retry the operation, exit and restart the REMCS window and try again. If the problem is not solved, contact the support center.
RMG_0004	Invalid CGI parameter specified.	
RMG_0033	Invalid directory name specified.	Enter a valid directory.
RMG_0036	Required entry.	Enter data for the item.
RMG_0142	The file doesn't exist in the selected directory.	Check the entered directory name and file name, and enter them correctly.
RMG_0211	The specified file cannot be upload.	Enter a valid file name.
RMG_0212	Failed to upload the certificates.(xxx)	If the error still occurs when you retry the operation, exit and restart the REMCS window and try again. If the problem is not solved, contact the support center.
RMG_0213	Upload of the certificates has been completed.	None.
RMG_0214	The frame display of the permutation of the certificates completed.	
RMG_0215	This certificate cannot be verified up to a CA certificate.	Confirm that the specified certificate is valid.
RMG_0224	This certificate is the same as the one used now. The certificate need not be imported.	Confirm the file to be imported.

TABLE 6.33 Messages in the [Confirmation of certificate] window

Message code	Message	Action
RMG_0001	Failed to get Machine status.(xxx)	If the error still occurs when you retry the operation, exit and restart the REMCS window and try again. If the problem is not solved, contact the support center.
RMG_0002	Failed to make frame screen data. (xxx)	
RMG_0004	Invalid CGI parameter specified.	
RMG_0041	Failed to setting Machine status.(xxx)	
RMG_0216	The certificates will be replaced. Once the replacement of certificates proceeds, the report to the REMCS center will not be done until connected confirmation is completed. Are you sure?	Click the [OK] or [Cancel] button.
RMG_0217	The frame display of confirmation of the certificate has been completed.	None.
RMG_0218	Failed to replace the certificate. Try to replace the certificate again. (xxx)	Replace the certificate again. If the problem is not solved, contact the support center.
RMG_0219	Replacing the certificate has been completed.	None.

TABLE 6.34 Messages in the [Replacement to the previous certificate] window

Message code	Message	Action
RMG_0001	Failed to get Machine status.(xxx)	If the error still occurs when you retry the operation, exit and restart the REMCS window and try again. If the problem is not solved, contact the support center.
RMG_0002	Failed to make frame screen data. (xxx)	
RMG_0004	Invalid CGI parameter specified.	
RMG_0041	Failed to setting Machine status.(xxx)	
RMG_0216	The certificates will be replaced. Once the replacement of certificates proceeds, the report to the REMCS center will not be done until connected confirmation is completed. Are you sure?	Click the [OK] or [Cancel] button.
RMG_0220	The frame display of the previous certificate restoration has been completed.	None.
RMG_0221	Failed to restore to the previous certificate. (xxx)	If the error still occurs when you retry the operation, exit and restart the REMCS window and try again. If the problem is not solved, contact the support center.
RMG_0222	The restoration to the previous certificate has been completed.	None.

TABLE 6.35 Messages in the [Display of certificate] window

Message code	Message	Action
RMG_0002	Failed to make frame screen data. (xxx)	If the error still occurs when you retry the operation, exit and restart the REMCS window and try again. If the problem is not solved, contact the support center.
RMG_0004	Invalid CGI parameter specified.	
RMG_0223	The frame display of the certificate has been completed.	None.

6.2 Communication Error Messages (SMTP Communication)

The following list shows the error messages displayed in the windows when communication errors occur. The communication error messages also indicate the action to be taken. Handle errors by referring to this information. If the problem is not solved even if action is taken, contact the support center. In messages, RL indicates the return value of the REMCS library, and ML indicates the return value of the e-mail sending part.

TABLE 6.36 List of communication error messages (SMTP communication)

Message code	Message
RMG_2000	(SMTP)There is no valid E-Mail address. The E-Mail address is not set up correctly. RL:xxx,ML:xxx
RMG_2001	(SMTP)Insufficient memory to run this operation. Please quit unnecessary applications, and try again. RL:xxx,ML:xxx
RMG_2002	(SMTP)File access error. There is no file. Please confirm following check. - Please check whether /var capacity is sufficient. RL:xxx,ML:xxx
RMG_2003	(SMTP)Communication timeout error was detected. Please try again after several minutes. When you do not solve the trouble, please check the network between the mail(SMTP) server, and check whether the SMTP server is running. RL:xxx,ML:xxx
RMG_2004	(SMTP)An error was detected by the specified mail(SMTP)

	<p>server. Please improve environment with reference to the following messages. (Message from the SMTP server) xxxxxxxxxxxxxxxxxxxxxxxx RL:xxx,ML:xxx</p>
RMG_2005	<p>(SMTP)Unable to connect the specified mail(SMTP) Server. Error was detected during communication to the specified mail (SMTP) server. The following causes can be considered. - The SMTP server name is wrong. - When the DNS server is used, the DNS server is not running. - The problem of the network between mail (SMTP) server. (Message from the SMTP server) xxxxxxxxxxxxxxxxxxxxxxxx RL:xxx,ML:xxx</p>
RMG_2006	<p>(SMTP)Unable to connect the specified mail(SMTP) Server. The following causes can be considered. - The SMTP server name is wrong. - When the DNS server is used, the DNS server is not running. - The problem of the network between mail (SMTP) server. (Message from the SMTP server) xxxxxxxxxxxxxxxxxxxxxxxx RL:xxx,ML:xxx\n</p>
RMG_2007	<p>(SMTP)An error was detected between the mail(POP3) server. POP before SMTP authentication failed. The following causes can be considered. - The POP3 server name is wrong. - User name is wrong. - Passwd is wrong. (Message from the POP3 server) xxxxxxxxxxxxxxxxxxxxxxxx RL:xxx,ML:xxx</p>
RMG_2008	<p>(SMTP)An error was detected between the mail(POP3) server. An error was detected during communication to the specified POP3 server. The following causes can be considered. - The POP3 server name is wrong. - When the DNS server is used, the DNS server is not running. - The problem of the network between POP3 server. (Message from the POP3 server) xxxxxxxxxxxxxxxxxxxxxxxx RL:xxx,ML:xxx</p>
RMG_2009	<p>(SMTP)The error was detected between the mail(POP3) server. The timeout error occurred in communication with a POP3 server. - The problem of the network between POP3server. - POP3 server is not running. RL:xxx,ML:xxx</p>
RMG_2010	<p>(SMTP)An error was detected during communication to the specified mail(POP3) server. The POP3 server name is wrong, or the POP3 server is not running. The following causes can be considered. - The POP3 server name is wrong. - When the DNS server is used, the DNS server is not running. - The problem of the network between POP3 server. (Message from the POP3 server) xxxxxxxxxxxxxxxxxxxxxxxx RL:xxx,ML:xxx</p>
RMG_2011	<p>(SMTP)The error was detected during communication to the specified mail(SMTP) server. Authentication failed on SMTP server. The user name or password is wrong, so it cannot authenticate</p>

	on SMTP server. (Message from the POP3 server) xxxxxxxxxxxxxxxxxxxxxx RL:xxx,ML:xxx
RMG_2012	(SMTP)An error was detected during communication to the specified mail(SMTP) server. The specified SMTP server does not support SMTP AUTH. Or the SMTP server does not support specified auth type. The following causes can be considered. - Specified SMTP server is wrong. - Specified auth type is wrong. (Message from the SMTP server) xxxxxxxxxxxxxxxxxxxxxx RL:xxx,ML:xxx

6.3 Other Error Messages

If an error message not listed above is displayed, exit and restart the REMCS window and try again.
 If the problem is not solved, contact the support center.

CHAPTER 7 MMB Log Collection

This chapter describes MMB log collection.

7.1 MMB Log Collection

If a problem such as being unable to send e-mail messages to the REMCS Center occurs, the MMB operation log may need to be used as troubleshooting information. Following the instructions from the support center, select [System] - [System Event Log] from the MMB Web-UI menu to download the log kept by the MMB. For details of the operation, see Section 1.2.2 [System Event Log] window in the *PRIMEQUEST 2000 Series Tool Reference (C122-E177EN)*. Hand over the downloaded log to a field engineer.

CHAPTER 8 Notes on Using REMCS GUI

This chapter describes the notes on using the REMCS GUI.

8.1 Notes on Using REMCS GUI

The REMCS GUI is displayed in a separate window when the REMCS menu is selected from the MMB Web UI.

At this time, if a security software product with a firewall function has been installed on the personal computer or the like used to run the Web browser, it may block cookies or other information from the site being browsed depending on the default settings. Such products include Symantec Client Firewall and Norton Internet Security manufactured by Symantec Corporation. In this case, a message window displaying [This session was disconnected.] appears, and the REMCS window is not displayed. The setting must be changed so that cookies or other information from the browsed sites are not blocked.

The setting procedure for cases where Symantec Client Firewall is used is provided below. For details on other software products, see the manuals and the HELP menu for each product.

1. Run Symantec Client Firewall to display its window.
2. Select [Privacy control], and then click the [Setting] button.
3. When the [Privacy control] window appears, click the [Custom level] button.
4. When the [Customizing privacy setting] window appears, select [None: Permits cookies] for [Cookie block] and uncheck [Enable browser privacy]. Then click the [OK] button.
5. When the [Privacy control] window is displayed again, click the [OK] button to complete the setting.

After the REMCS GUI is displayed, the connection is canceled if no input occurs within the time specified for [Timeout] of [Web (HTTP/HTTPS)]. [Web (HTTP/HTTPS)] is accessed by selecting [Network] - [Network Protocols] in the [MMB Web-UI] window.

Only one user can use the REMCS GUI concurrently. If any other user is already logged in, the following window appears:

TABLE 8.1 REMCS message window

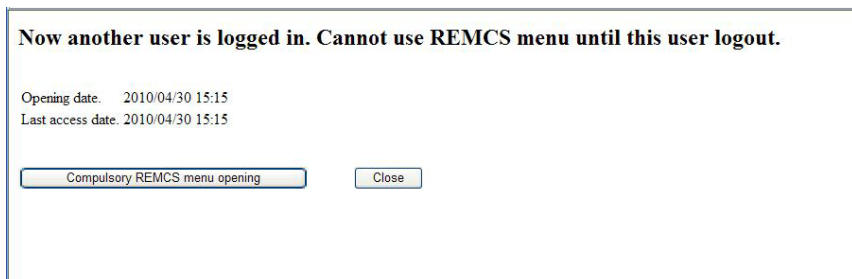

Clicking the [Compulsory REMCS menu opening] button logs you in by forcibly logging out the current login user.

Click the [Close] button to close the window.

If the time zone setting has been changed from the [MMB Web-UI] window, perform the following operation to update the REMCS Center information:

- Execute the periodic connection schedule settings.

The periodic connection schedule of REMCS is interpreted with the time zone currently set.

FUJITSU

Free Manuals Download Website

<http://myh66.com>

<http://usermanuals.us>

<http://www.somanuals.com>

<http://www.4manuals.cc>

<http://www.manual-lib.com>

<http://www.404manual.com>

<http://www.luxmanual.com>

<http://aubethermostatmanual.com>

Golf course search by state

<http://golfingnear.com>

Email search by domain

<http://emailbydomain.com>

Auto manuals search

<http://auto.somanuals.com>

TV manuals search

<http://tv.somanuals.com>