

PRIMERGY RX600 S5 Server

Operating Manual

January 2011

Comments... Suggestions... Corrections...

The User Documentation Department would like to know your opinion of this manual. Your feedback helps us optimize our documentation to suit your individual needs.

Feel free to send us your comments by e-mail to [E-Mail: manuals@ts.fujitsu.com](mailto:manuals@ts.fujitsu.com).

Certified documentation according to DIN EN ISO 9001:2008

To ensure a consistently high quality standard and user-friendliness, this documentation was created to meet the regulations of a quality management system which complies with the requirements of the standard DIN EN ISO 9001:2008.

cognitas. Gesellschaft für Technik-Dokumentation mbH
www.cognitas.de

Copyright and Trademarks

Copyright © 2011 Fujitsu Technology Solutions GmbH.

All rights reserved.

Delivery subject to availability; right of technical modifications reserved.

All hardware and software names used are trademarks of their respective manufacturers.

- The contents of this manual may be revised without prior notice.
- Fujitsu assumes no liability for damages to third party copyrights or other rights arising from the use of any information in this manual.
- No part of this manual may be reproduced in any form without the prior written permission of Fujitsu.

Microsoft, Windows, Windows Server, and Hyper V are trademarks or registered trademarks of Microsoft Corporation in the USA and other countries.

Intel and Xeon are trademarks or registered trademarks of Intel Corporation or its subsidiaries in the USA and other countries.

Before reading this manual

For your safety

This manual contains important information for safely and correctly using this product.

Carefully read the manual before using this product. Pay particular attention to the accompanying manual "Safety notes and other important information" and ensure these safety notes are understood before using the product. Keep this manual and the manual "Safety notes and other important information" in a safe place for easy reference while using this product.

Radio interference

This product is a "Class A" ITE (Information Technology Equipment). In a domestic environment this product may cause radio interference, in which case the user may be required to take appropriate measures. VCCI-A

Aluminum electrolytic capacitors

The aluminum electrolytic capacitors used in the product's printed circuit board assemblies and in the mouse and keyboard are limited-life components. Use of these components beyond their operating life may result in electrolyte leakage or depletion, potentially causing emission of foul odor or smoke.

As a guideline, in a normal office environment (25°C) operating life is not expected to be reached within the maintenance support period (5 years). However, operating life may be reached more quickly if, for example, the product is used in a hot environment. The customer shall bear the cost of replacing replaceable components which have exceeded their operating life. Note that these are only guidelines, and do not constitute a guarantee of trouble-free operation during the maintenance support period.

High safety use

This product has been designed and manufactured for general uses such as general office use, personal use, domestic use and normal industrial use. It has not been designed or manufactured for uses which demand an extremely high level of safety and carry a direct and serious risk to life or body if such safety cannot be ensured.

These uses include control of nuclear reactions in nuclear power plants, automatic airplane flight control, air traffic control, traffic control in mass transport systems, medical devices for life support, and missile guidance control in weapons systems (hereafter, "high safety use"). Customers should not use this product for high safety use unless measures are in place for ensuring the level of safety demanded of such use. Please consult the sales staff of Fujitsu if intending to use this product for high safety use.

Measures against momentary voltage drop

This product may be affected by a momentary voltage drop in the power supply caused by lightning. To prevent a momentary voltage drop, use of an AC uninterruptible power supply is recommended.

(This notice follows the guidelines of Voltage Dip Immunity of Personal Computer issued by JEITA, the Japan Electronics and Information Technology Industries Association.)

Technology controlled by the Foreign Exchange and Foreign Trade Control Law of Japan

Documents produced by Fujitsu may contain technology controlled by the Foreign Exchange and Foreign Trade Control Law of Japan. Documents which contain such technology should not be exported from Japan or transferred to non-residents of Japan without first obtaining authorization in accordance with the above law.

Harmonic Current Standards

This product conforms to harmonic current standard JIS C 61000-3-2.

Only for the Japanese market: About SATA hard disk drives

The SATA version of this server supports hard disk drives with SATA / BC-SATA storage interfaces. Please note that the usage and operation conditions differ depending on the type of hard disk drive used.

Please refer to the following internet address for further information on the usage and operation conditions of each available type of hard disk drive:

<http://primeserver.fujitsu.com/primergy/harddisk/>

Only for the Japanese market:



Although described in this manual, some sections do not apply to the Japanese market. These options and routines include:

- CSS (Customer Self Service)
- USB Flash Module (UFM)
- Replacing the lithium battery



Contents

1	Preface	11
1.1	Concept and target groups for this manual	11
1.2	Documentation overview	12
1.3	Features	14
1.4	Notational conventions	22
1.5	Technical data	22
2	Overview of the installation steps	25
3	Important information	27
3.1	Safety instructions	27
3.2	ENERGY STAR	35
3.3	CE conformity	35
3.4	FCC Class A Compliance Statement	36
3.5	Transporting the server	37
3.6	Notes on installing the server in the rack	38
3.7	Environmental protection	39
4	Hardware installation	41
4.1	Unpacking the server	42
4.2	Rack installation/removal of server	43
4.2.1	Rack system requirements	43
4.2.2	Installation in PRIMECENTER/DataCenter rack	46
4.2.3	Installation in 3rd party racks	51
4.3	Connecting devices to the server	53
4.4	Connecting the server to the mains	55
4.4.1	Installation requirements	55

Contents

4.4.2	Connecting the power cord	60
4.5	Notes on connecting/disconnecting cables	61
5	Starting up and operation	63
5.1	Control elements and indicators	63
5.1.1	Front of server	63
5.1.1.1	Control elements	65
5.1.1.2	Indicators on the control panel	66
5.1.1.3	Indicators on the accessible drives/components	67
5.1.1.4	Indicators on the hot-plug HDD modules	68
5.1.2	Rear of server	69
5.1.2.1	Global Error indicator and CSS indicator	69
5.1.2.2	ID indicator and button	71
5.1.2.3	Indicators on the connector panel (LAN indicators)	72
5.1.2.4	Indicators on the hot-plug power supply units	73
5.2	Switching the server on and off	75
5.3	Configuring the server	78
5.3.1	Configuring the SAS/SATA RAID controller card	78
5.3.2	Configuring the server and installing the operating system with the ServerView Installation Manager	79
5.3.3	Configuring the server and installing the operating system without the ServerView Installation Manager	80
5.4	Cleaning the server	81
6	Property and data protection	83
6.1	Mechanical access protection	83
6.2	BIOS Setup security functions	83
7	Troubleshooting and tips	85
7.1	Power-on indicator remains unlit	85
7.2	Server switches itself off	86
7.3	Screen remains blank	86
7.4	Flickering stripes on monitor screen	87

7.5	No screen display or display drifts	87
7.6	Incorrect date and time	88
7.7	Drives reported as "dead" when starting system	88
7.8	Added drive reported as defective	89
7.9	Error message on screen	89
8	CSS components	91
<hr/>		
8.1	Hot-plug components	93
8.1.1	Hot-plug power supply units	93
8.1.1.1	Replacing a hot-plug power supply unit	94
8.1.1.2	Adding a hot-plug power supply unit	95
8.1.2	Hot-plug fans	97
8.1.2.1	Replacing a defective fan	98
8.1.2.2	Adding new fans	99
8.1.3	Hot-plug HDD modules	100
8.1.3.1	HDD/SSD module and dummy module	102
8.1.3.2	Removing/installing the dummy module	103
8.1.3.3	Installing the HDD module	104
8.1.3.4	Removing the HDD module	105
8.1.4	Hot-plug expansion cards	107
8.1.4.1	Identifying the defective CSS component	109
8.1.4.2	Removing a hot-plug expansion card	109
8.1.4.3	Removing a dummy module	112
8.1.4.4	Installing a hot-plug expansion card	113
8.1.5	Hot-plug memory boards	115
8.1.5.1	Identifying the defective memory	116
8.1.5.2	Removing the memory board in question	117
8.1.5.3	Removing a defective memory module	117
8.1.5.4	Installing a new memory module	119
8.1.5.5	Reinstalling the memory board in question	119
8.1.5.6	Adding a memory board	120
8.2	Non-hot-plug components	121
8.2.1	Identifying the defective CSS component	122
8.2.2	Replacing a non-hot-plug expansion card	122
8.2.2.1	Removing a non-hot-plug expansion card	122
8.2.2.2	Installing a non-hot-plug expansion card	125
8.2.3	Replacing SFP+ transceiver modules	126
8.2.3.1	Removing an SFP+ transceiver module	126

Contents

- 8.2.3.2 Installing SFP+ transceiver modules 129
- 8.3 Opening/Closing the server 134**
- 8.3.1 Opening the server 134
- 8.3.2 Closing the server 136

- 9 Appendix: server specification 137**

- Index 143**

1 Preface

The scalable PRIMERGY RX600 S5 server is an Intel-based rack server for critical company scenarios, e.g. as database management system for medium or large-sized databases or as a consolidation basis to run an immensely large number of different applications using virtualization technologies.

Thanks to its highly developed hardware and software components, the server offers a high level of data security and availability. These include hot-plug HDD modules, hot-plug system fans, and also hot-plug power supply units, the Server Management ServerView Suite, Prefailure Detection and Analysis (PDA) and Automatic Server Reconfiguration and Restart (ASR&R).

Security functions in the BIOS Setup and on the system board protect the data on the server against manipulation. Additional security is provided by the lockable rack door.

The server occupies 4 height units (HU) in the rack.

1.1 Concept and target groups for this manual

This operating manual describes how to install, set up and operate your server.

This operating manual is intended for those responsible for installing the hardware and ensuring that the system runs smoothly. It contains all the information you need to put your PRIMERGY RX600 S5 into operation.

To understand the various expansion options, you will need to be familiar with the fields of hardware and data transmission and you will require a basic knowledge of the underlying operating system.

1.2 Documentation overview

More information on your PRIMERGY RX600 S5 can be found in the following documents:

- "Quick Start Hardware - PRIMERGY RX600 S5" leaflet
"はじめにお読みください-PRIMERGY RX600 S5" for the Japanese market
(only included as a printed copy)
- "Quick Start Software - Quick Installation Guide" DVD booklet
(only included with the ServerView Suite as a printed copy) except for the Japanese market
- "Safety Notes and Regulations" manual
"安全上のご注意" for the Japanese market
- "Warranty" manual
"保証書" for the Japanese market
- "ServerView Suite Local Service Concept - LSC" manual
- "Returning used devices" manual and "Service Desk" leaflet
"サポート&サービス" for the Japanese market
- "PRIMERGY RX600 S5 Server Operating Manual"
- "PRIMERGY RX600 S5 Server Options Guide"
- "System Board D2870 for PRIMERGY RX600 S5 Technical Manual"
- "D2870 BIOS Setup Utility for PRIMERGY RX600 S5" manual



PRIMERGY manuals are available in PDF format on the ServerView Suite DVD 2. The ServerView Suite DVD 2 is part of the ServerView Suite supplied with every server.

If you no longer have the ServerView Suite DVDs, you can obtain the relevant current versions using the order number U15000-C289 (the order number for the Japanese market: please refer to the configurator of the server <http://primeserver.fujitsu.com/primergy/system.html>).

The PDF files of the manuals can also be downloaded free of charge from the Internet. The overview page showing the online documentation available on the Internet can be found using the URL (for EMEA market): <http://manuals.ts.fujitsu.com>. The PRIMERGY server documentation can be accessed using the *Industry standard servers* navigation option.

For the Japanese market please use the URL:
<http://primeserver.fujitsu.com/primergy/manual.html>.

Further sources of information:

- PRIMERGY Abbreviations and Glossary on the ServerView Suite DVD 2
- Manual for the monitor
- Documentation for the boards and drives
- Operating system documentation
- Information files in your operating system

1.3 Features

Customer Self Service (CSS)

The PRIMERGY Customer Self Service (CSS) concept enables you to identify and replace the affected component yourself in the case of certain error scenarios.

In the CSS concept, you can replace the following components yourself in the event of an error:

- Hot-plug hard disk drives
- Hot-plug power supply units
- Hot-plug Memory modules
- Hot-plug System fans
- Expansion cards (as soon as released)

For information on replacing these components, see chapter ["CSS components" on page 91](#).

CSS indicators on the control panel and on the back of the PRIMERGY server provide you with information if a CSS event arises (for more information on the behavior of these indicators, see chapter ["Starting up and operation" on page 63](#) and the "ServerView Suite Local Service Concept - LSC" manual on the ServerView Suite DVD 2).

Your server is equipped with a ServerView Local Service Display, which enables you to identify the type of component affected by the error directly on the server (for more information, see the "ServerView Suite Local Service Concept - LSC" manual on the ServerView Suite DVD 2).

In addition, CSS errors are displayed in the ServerView Operations Manager, the server management software from Fujitsu.

In the event of errors, the ServerView Operations Manager refers you directly to the affected component and its order information in the Illustrated Spares catalog of the server in question. (This feature is not available for the Japanese market.)

System board

The features of the system board are described in the technical manual for the system board D2870 for the hardware and in the BIOS Setup manual for the firmware.

Hot-plug PCI slots

The server has ten PCI-Express slots, where two of them are hot-plug slots. These hot-plug PCI-Express slots allow installation and removal of boards during operation when the operating system supports this function (for further details see section "[Hot-plug expansion cards](#)" on page 107).

Hard disk drives

The server can be equipped with up to 8 SAS/SATA HDD modules. Each HDD module can accommodate a SAS/SATA hard disk drive with a 2.5-inch format. The modules are connected to the SAS/SATA backplane wirelessly. This allows HDD modules to be plugged in or pulled out easily.

The hard disk system is designed for SAS/SATA with one channel for each hard disk drive.

If the server has the corresponding RAID configuration, HDD modules can also be replaced during operation.

SAS/SATA controller card (optionally with RAID controller)

The SAS/SATA controller card for operating up to eight SAS/SATA hard disk drives can be alternately without or with RAID functionality. In case of RAID functionality the levels 0, 1, 1E, 5, 6, 10, 50 and 60 are supported.

Battery Backup Units

Up to two intelligent Battery Backup Units (iBBUs) back up the memory contents of their corresponding RAID controllers in the event of power failure (option).

Accessible drives/components

A number of mounting locations are available:

- An installation slot for a ServerView Local Service Display (standard)
- An installation slot for a slimline CD/DVD/BD drive (standard)
- A 5.25-inch bay for a magnetic tape drive (option)

The accessible drives/components integrated in these locations cannot be replaced during operation.

Power supply

The server has up to four hot-plug power supply units that automatically switch to a mains voltage of 100 - 127 V / 200 - 240 V. This ensures redundant power supply. If one power supply unit is defective, the other(s) then guarantee(s) unimpaired operation. The faulty power supply unit can be replaced during operation (for further details see ["Hot-plug power supply units" on page 93](#)).

Cooling

Each processor has a heat sink. Further cooling for the installed processors is provided by hot-plug fans (optionally in a redundant configuration).

Temperature sensors variably adjust the fans. If a temperature sensor fails or is removed, the fans affected run at maximum speed so as to provide the greatest possible protection for the hardware. When the housing is open, **all** the fans run at maximum speed.

If a fan fails, unimpaired further operation is ensured. A defective fan module can be replaced during operation (for further details see ["Hot-plug fans" on page 97](#)).

High level of availability and data security

When memory data is accessed, 1-bit errors in the main memory are identified and automatically corrected with the ECC (Error Correcting Code) method. The patented memory scrubbing function regularly starts up the EDC mechanism (Error Detection Code) and thus ensures continuous data integrity.

The memory modules used support SDDC technology (Chipkill™), which further increases the effectiveness of memory error monitoring and correction.

Support is likewise provided for hot-spare memory technology, in which a memory module is used like a replacement module. If a memory module fails, the module with the defective memory is automatically deactivated and the replacement module is activated (provided it has been configured for appropriately in the BIOS). The deactivated memory module is no longer used and the faulty memory module can be replaced at the next opportunity. In order to be able to use the hot-spare memory function, all occupied DIMM slots must have an identical memory configuration.

Memory modules can be protected against failure through mirroring (memory mirroring, requires two or four memory modules).

ASR&R (Automatic Server Reconfiguration and Restart) restarts the system in the event of an error and automatically "hides" the defective system components.

The PDA (Prefailure Detection and Analysis) technology from Fujitsu analyzes and monitors all components that are critical for system reliability.

The SAS/SATA controller card supports the RAID levels 0, 1, 1E, 5, 6, 10, 50 and 60 thus increasing system availability and reliability.

Additional reliability is provided by the hot-plug HDD modules, fans and power supply units.

iRMC S2 with integrated management LAN connector



The features of the iRMC S2 Advanced Video Redirection and Remote Storage are available as an option.

The iRMC S2 (integrated **R**emote **M**anagement **C**ontroller) is a BMC with integrated management LAN connector and expanded functionality that was previously only available with additional plug-in cards. In this way, the iRMC S2 enables complete control of PRIMERGY servers, regardless of system status, and thus particularly the control of PRIMERGY servers that are in the "out-of-band" system status.

Major functions supported by the iRMC S2 include the following:

- Browser access via iRMC S2-s own Web server
- Secure communication (SSH, SSL)
- Power Management for the managed server (depending on its system status)
- Power Consumption Management
- Connecting virtual drives as remote storage
- Text-based and graphic console bypass (Advanced Video Redirection)
- Command Line Interface (CLI)
- Simple, interactive or script-based iRMC S2 configuration
- Customer Self Service (CSS)
- iRMC S2-s own user management
- Multi-computer, global iRMC S2 user administration using an LDAP Directory Service
- Automatic network configuration via DNS / DHCP
- Power supply of the iRMC S2 via the system standby supply
- Full-coverage alarm management
- System Event Log (SEL) reading and processing

More information about the iRMC S2 can be found in the "iRMC S2 - integrated Remote Management Controller" user's guide (on the ServerView Suite DVD 2 under *Industry Standard Servers - Software - ServerView Suite - Out-Of-Band Management*).

Server management

Server management is implemented using the ServerView Operations Manager supplied and the PDA (Prefailure Detection and Analysis) technology from Fujitsu. PDA reports the threat of a system error or overload at an early stage, allowing preventive measures to be taken.

The ServerView Operations Manager enables the management of all PRIMERGY servers in the network via a central console. The ServerView Operations Manager supports the following functions:

- Round-the-clock monitoring, regardless of server status
- High-performance, graphical console bypass (AVR) protected by HTTPS/SSL (128 bit)
- Remote storage via USB
- Remote power on
- Temperature monitoring of the CPU and the surrounding area
- Detailed status and error reports for processors and main memory
- Watchdog timer for Automatic Server Reconfiguration and Restart (ASR&R) in the event of failure of memory modules or processors
- Power monitoring
- End-of-life monitoring of fans with prompt notification before failure
- Watchdog timer for monitoring the operating system with ASR&R

Further information on the ServerView Operations Manager is provided in the associated documentation.

ServerView Installation Manager

You can configure the PRIMERGY server quickly and precisely with the ServerView Installation Manager software provided. User-guided menus are available for installing the server operating system (for further details see section "[Configuring the server](#)" on page 78).

Service and support

PRIMERGY servers are service-friendly and modular, enabling quick and easy maintenance.

For easier and immediate recognition, handles and locks (touch points) are color coded. Green touch points are for components that can be replaced without tools as well as for hot-plug components that can be replaced or inserted during operation without the need for tools (see also "[CSS components](#)" on page 91).

You can use the ServerView Local Service Display on the front panel of the server to check the status of the key system components at any time without opening the housing. Further information on ServerView Local Service Display is provided in the associated documentation.

For further information, please refer to the diagnosis LEDs on the hot-plug components (power supply units, fans, expansion cards, HDD modules).

The ServerView Update Manager supplied with the Fujitsu utilities supports a fast remote BIOS update via the LAN interface; the BIOS can also be updated locally via USB. The optional ServerView Remote Management remote testing and diagnostic system enables you to remotely maintain your server.

ServerView Remote Management

ServerView Remote Management is the remote management solution from Fujitsu for PRIMERGY servers. ServerView Remote Management and the relevant hardware components integrated on the system board allow remote monitoring and maintenance as well as fast restoration of operation in the event of errors.

Remote monitoring and maintenance avoids time-consuming and costly on-site repairs and reduces service costs. This leads to a reduction in the total cost of ownership and an excellent return on investment for the remote management solution.

The administrator can access all system information and information from the sensors such as fan speeds or voltages via the iRMC S2's Web interface (see section "[iRMC S2 with integrated management LAN connector](#)" on page 18). You can also start the text-based or graphic console bypass (Advanced Video Redirection, AVR) and connect virtual drives as remote storage.





The features of the iRMC S2 Advanced Video Redirection and Remote Storage are available as an option.

More information about the iRMC S2 can be found in the "iRMC S2 - integrated Remote Management Controller" user's guide (on the ServerView Suite DVD 2 under *Industry Standard Servers - Software - ServerView Suite - Out-Of-Band Management*).

1.4 Notational conventions

The following notational conventions are used in this manual:

<i>Text in italics</i>	indicates commands or menu items.
"Quotation marks"	indicate names of chapters and terms that are being emphasized.
▶	describes activities that must be performed in the order shown.
 CAUTION!	pay particular attention to texts marked with this symbol. Failure to observe this warning may endanger your life, destroy the system or lead to the loss of data.
	indicates additional information, notes and tips.

1.5 Technical data

Electrical data (hot-plug power supply unit)

Rated voltage range	100 - 127 V / 200 - 240 V
Frequency	50 Hz - 60 Hz
Rated current (basic configuration)	3.1 A (240 V)
Max. rated current	14 A (240 V)
Active power min. (typical configuration)	750 W
Active power max. (typical configuration)	1950 W
Rated active power max.	3360 W (14 A x 240 V)
Apparent power (typical configuration)	1990 VA
Heat dissipation	750 W/h = 2559 btu/h 1950 W/h = 6654 btu/h 3360 W/h = 11465 btu/h
Main power fuse	16 A
Protection class	I

Compliance with regulations and standards

Product safety and ergonomics	IEC 60950-1/2 / EN 60950-1/2, UL/CSA 60950-1/2, CNS 14336 / GB 4943 / EN 50371
Electromagnetic compatibility	
Interference emissions	EN 55022 class A; FCC class A; CNS 13438 class A; VCCI class A; AS/NZS CISPR 22 class A; GB 9254 class A; GB 17625; ETSI EN 300 386 V1.3.1
Interference immunity	EN 55024, EN 300386
Harmonic current	EN 61000-3-2
Flicker	EN 61000-3-3
CE marking to EU directives	Low Voltage Directive 2006/95/EC (product safety) Electromagnetic compatibility 2004/108/EC
Environmental conditions	ETSI 300 019-2-3 Class 3.1 (T3.1)
Noise emission	ETSI 300 753 Class 3.1

Dimensions / Weight

Rack (W x D x H)	482.6 mm (Bezel) / 444.8 mm (Body) x 770.0 mm x 176.0 mm
Mounting depth rack	728 mm
Height unit rack	4 U
19" rackmount	Yes
Mounting cable depth rack	100 mm (1000 mm rack recommended)
Weight	min. 32 kg; max. 46 kg (actual weight may vary depending on configuration)
Rack integration kit	rack integration kit as option  Rack integration kit is standard for the Japanese market.

Ventilation clearance

At least 200 mm on the front and rear.

Ambient conditions

Environment class 3K2 Environment class 2K2	EN 60721 / IEC 721 Part 3-3 EN 60721 / IEC 721 Part 3-2
Temperature: Operation (3K2) Transport (2K2)	10 °C 35 °C -25 °C 60 °C
Humidity	10% ... 85% (non condensing)

Condensation during operation must be avoided!

Noise level

Sound power level L_{WAd} (ISO 9296)	< 6.2 B (standby) < 6.6 B (operation)
Sound pressure level at bystander position L_{pAm} (ISO 9296) (at < 23 °C)	< 46 dB(A) (standby) < 51 dB(A) (operation)

2 Overview of the installation steps

This chapter contains an overview of the steps necessary to install your server. Links guide you to sections where you can find more detailed information on the individual steps:

- ▶ At first, please take notice of the safety instructions in chapter "[Important information](#)" on page 27 and following.
- ▶ Transport the server to the place where you want to install it.
- ▶ Unpack all parts, check the contents of the package for visible transport damage and check whether the items delivered match the details on the delivery note (see section "[Unpacking the server](#)" on page 42).
- ▶ Make sure that all necessary manuals (see "[Documentation overview](#)" on page 12) are available; print out the PDF files if required.
- ▶ Fit the server in the rack (see section "[Rack installation/removal of server](#)" on page 43).
- ▶ Wire the server. Follow the instructions in the sections "[Connecting devices to the server](#)" on page 53 and "[Notes on connecting/disconnecting cables](#)" on page 61.
- ▶ Connect the server to the mains (see section "[Connecting the server to the mains](#)" on page 55).
- ▶ Familiarize yourself with the controls and indicators on the front and rear of the server (see section "[Control elements and indicators](#)" on page 63).
- ▶ Configure the server and install the desired operating system and applications. Here you can choose from two possibilities:

- Remote installation with the ServerView Installation Manager:

With the ServerView Suite DVD 1 provided, you can configure the server and install the operating system in a convenient manner.

Details on how to operate the ServerView Installation Manager, as well as some additional information, are included in the "ServerView Suite Installation Manager" user's guide (on ServerView Suite DVD 2 under *Industry Standard Servers - Software - ServerView Suite - Server Installation and Deployment*).

Overview of the installation steps

Configuration information can also be found in section "[Configuring the server and installing the operating system with the ServerView Installation Manager](#)" on page 79.

- Local configuration and installation with or without ServerStart (see section "[Configuring the server and installing the operating system with the ServerView Installation Manager](#)" on page 79 or section "[Configuring the server and installing the operating system without the ServerView Installation Manager](#)" on page 80).



You will find more information on installing the server remotely or locally in the "ServerView Suite Installation Manager" user's guide (on the ServerView Suite DVD 2 under *Industry Standard Servers - Software - ServerView Suite - Server Installation and Deployment*).

3 Important information

In this chapter you will find essential information regarding safety when working on your server.

3.1 Safety instructions



The following safety instructions are also provided in the manual "Safety Notes and Regulations" or "安全上のご注意".

This device meets the relevant safety regulations for IT equipment. If you have any questions about whether you can install the server in the intended environment, please contact your sales outlet or our customer service team.



CAUTION!

- The actions described in this manual shall be performed by technical specialists. A technical specialist is a person who is trained to install the server including hardware and software.
- Repairs to the device that do not relate to CSS failures shall be performed by service personnel. Please note that unauthorized interference with the system will void the warranty and exempt the manufacturer from all liability.
- Any failure to observe the guidelines in this manual, and any improper repairs could expose the user to risks (electric shock, energy hazards, fire hazards) or damage the equipment.
- Before installing/removing internal options to/from the server, turn off the server, all peripheral devices, and any other connected devices. Also unplug all power cords from the power outlet. Failure to do so can cause electric shock.

Before starting up



CAUTION!

- During installation and before operating the device, observe the instructions on environmental conditions for your device (see "[Technical data](#)" on page 22).
- If the server has been moved from a cold environment, condensation may form both inside and on the outside of the machine.

Wait until the server has acclimatized to room temperature and is absolutely dry before starting it up. Material damage may be caused to the server if this requirement is not met.

- Only transport the server in the original packaging or in packaging that protects it from impacts and jolts.

Installation and operation



CAUTION!

- This unit should not be operated in ambient temperatures above 35 °C.
- If the unit is integrated into an installation that draws power from an industrial power supply network with an IEC309 connector, the power supply's fuse protection must comply with the requirements for non-industrial power supply networks for type A connectors.
- The unit automatically adjusts itself to a mains voltage in a range of 100 - 127 V / 200 - 240 V. Ensure that the local mains voltage lies within these limits.
- This device must only be connected to properly grounded power outlets or insulated sockets of the rack's internal power supply with tested and approved power cords.
- Ensure that the device is connected to a properly grounded power outlet close to the device.

**CAUTION!**

- Ensure that the power sockets on the device and the properly grounded power outlets are freely accessible.
- The On/Off button or the main power switch (if present) does not isolate the device from the mains power supply. To disconnect it completely from the mains power supply, unplug all network power plugs from the properly grounded power outlets.
- Always connect the server and the attached peripherals to the same power circuit. Otherwise you run the risk of losing data if, for example, the server is still running but a peripheral device (e.g. memory subsystem) fails during a power outage.
- Data cables must be adequately shielded.
- Ethernet cabling has to comply with EN 50173 and EN 50174-1/2 standards or ISO/IEC 11801 standard respectively. The minimum requirement is a Category 5 shielded cable for 10/100 Ethernet, or a Category 5e cable for Gigabit Ethernet.
- Route the cables in such a way that they do not create a potential hazard (make sure no-one can trip over them) and that they cannot be damaged. When connecting the server, refer to the relevant instructions in this manual.
- Never connect or disconnect data transmission lines during a storm (risk of lightning hazard).
- Make sure that no objects (e.g. jewelry, paperclips etc.) or liquids can get inside the server (risk of electric shock, short circuit).
- In emergencies (e.g. damaged casing, controls or cables, penetration of liquids or foreign bodies), switch off the server immediately, remove all power plugs and contact your sales outlet or customer service team.

**CAUTION!**

- Proper operation of the system (in accordance with IEC 60950-1/2 resp. EN 60950-1/2) is only ensured if the casing is completely assembled and the rear covers for the installation slots have been fitted (electric shock, cooling, fire protection, interference suppression).
- Only install system expansions that satisfy the requirements and rules governing safety and electromagnetic compatibility and those relating to telecommunication terminals. If you install other expansions, they may damage the system or violate the safety regulations. Information on which system expansions are approved for installation can be obtained from our customer service center or your sales outlet.
- The components marked with a warning notice (e.g. lightning symbol) may only be opened, removed or exchanged by authorized, qualified personnel. Exception: CSS components can be replaced.
- The warranty is void if the server is damaged during installation or replacement of system expansions.
- Only set screen resolutions and refresh rates that are specified in the operating manual for the monitor. Otherwise, you may damage your monitor. If you are in any doubt, contact your sales outlet or customer service center.
- Before installing/removing internal options to/from the server, turn off the server, all peripheral devices, and any other connected devices. Also unplug all power cords from the outlet. Failure to do so can cause electric shock.
- Do not damage or modify internal cables or devices. Doing so may cause a device failure, fire, or electric shock.
- Devices inside the server remain hot after shutdown. Wait for a while after shutdown before installing or removing internal options.
- The circuit boards and soldered parts of internal options are exposed and can be damaged by static electricity. Before handling them, first touch a metal part of the server to discharge static electricity from your body.
- Do not touch the circuitry on boards or soldered parts. Hold the metallic areas or the edges of the circuit boards.

**CAUTION!**

- Install the screw removed during installation/detaching Internal Options in former device/position. To use a screw of the different kind causes a breakdown of equipment.
- The installation indicated on this note is sometimes changed to the kind of possible options without notice.

Batteries**CAUTION!**

- Incorrect replacement of batteries may lead to a risk of explosion. The batteries may only be replaced with identical batteries or with a type recommended by the manufacturer (see the technical manual for the system board).
- Do not throw batteries into the trash can.
- Batteries must be disposed of in accordance with local regulations concerning special waste.
- Replace the lithium battery on the system board in accordance with the instructions in the technical manual for the system board.
- All batteries containing pollutants are marked with a symbol (a crossed-out garbage can). In addition, the marking is provided with the chemical symbol of the heavy metal decisive for the classification as a pollutant:

Cd Cadmium

Hg Mercury

Pb Lead

Working with CDs/DVDs/BDs and optical drives

When working with devices with optical drives, these instructions must be followed.



CAUTION!

- Only use CDs/DVDs/BDs that are in perfect condition, in order to prevent data loss, equipment damage and injury.
- Check each CD/DVD/BD for damage, cracks, breakages etc. before inserting it in the drive.

Note that any additional labels applied may change the mechanical properties of a CD/DVD/BD and cause imbalance.

Damaged and imbalanced CDs/DVDs/BDs can break at high drive speeds (data loss).

Under certain circumstances, sharp CD/DVD/BD fragments can pierce the cover of the optical drive (equipment damage) and can fly out of the device (danger of injury, particularly to uncovered body parts such as the face or neck).

- High humidity and airborne dust levels are to be avoided. Electric shocks and/or server failures may be caused by liquids such as water, or metallic items, such as paper clips, entering a drive.
- Shocks and vibrations are also to be avoided.
- Do not insert any objects other than the specified CDs/DVDs/BDs.
- Do not pull on, press hard, or otherwise handle the CD/DVD/BD tray roughly.
- Do not disassemble the optical drive.
- Before use, clean the optical disk tray using a soft, dry cloth.
- As a precaution, remove disks from the optical drive when the drive is not to be used for a long time. Keep the optical disk tray closed to prevent foreign matter, such as dust, from entering the optical drive.
- Hold CDs/DVDs/BDs by their edges to avoid contact with the disk surface.

- Do not contaminate the CD/DVD/BD surface with fingerprints, oil, dust, etc. If dirty, clean with a soft, dry cloth, wiping from the center to the edge. Do not use benzene, thinners, water, record sprays, antistatic agents, or silicone-impregnated cloth.
- Be careful not to damage the CD/DVD/BD surface.
- Keep the CDs/DVDs/BDs away from heat sources.
- Do not bend or place heavy objects on CDs/DVDs/BDs.
- Do not write with ballpoint pen or pencil on the label (printed) side.
- Do not attach stickers or similar to the label side. Doing so may cause rotational eccentricity and abnormal vibrations.
- When a CD/DVD/BD is moved from a cold place to a warm place, moisture condensation on the CD/DVD/BD surface can cause data read errors. In this case, wipe the CD/DVD/BD with a soft, dry cloth then let it air dry. Do not dry the CD/DVD/BD using devices such as a hair dryer.
- To avoid dust, damage, and deformation, keep the CD/DVD/BD in its case whenever it is not in use.
- Do not store CDs/DVDs/BDs at high temperatures. Areas exposed to prolonged direct sunlight or near heating appliances are to be avoided.



You can prevent damage from the optical drive and the CDs/DVDs/BDs, as well as premature wear of the disks, by observing the following suggestions:

- Only insert disks in the drive when needed and remove them after use.
- Store the disks in suitable sleeves.
- Protect the disks from exposure to heat and direct sunlight.

Laser information

The optical drive complies with IEC 60825-1 laser class 1.



CAUTION!

The optical drive contains a light-emitting diode (LED), which under certain circumstances produces a laser beam stronger than laser class 1. Looking directly at this beam is dangerous.

Never remove parts of the optical drive casing!

Modules with Electrostatic-Sensitive Devices

Modules with electrostatic-sensitive devices are identified by the following sticker:

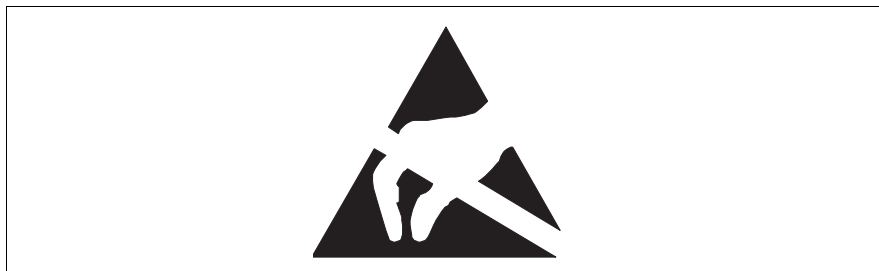

Figure 1: ESD label

When you handle components fitted with ESDs, you must always observe the following points:

- Switch off the system and remove the power plugs from the power outlets before installing or removing components with ESDs.
- You must always discharge static build-up (e.g. by touching a grounded object) before working with such components.
- Any devices or tools that are used must be free of electrostatic charge.
- Wear a suitable grounding cable that connects you to the external chassis of the system unit.
- Always hold components with ESDs at the edges or at the points marked green (touch points).
- Do not touch any connectors or conduction paths on an ESD.
- Place all the components on a pad which is free of electrostatic charge.



For a detailed description of how to handle ESD components, see the relevant European or international standards (EN 61340-5-1, ANSI/ESD S20.20).

Other important information:

- During cleaning, observe the instructions in section "[Cleaning the server](#)" on [page 81](#).
- Keep this operating manual and the other documentation (such as the technical manual, documentation DVD) close to the device. All documentation must be included if the equipment is passed on to a third party.

3.2 ENERGY STAR



Products that have been certified compliant with ENERGY STAR and identified as such are in full compliance with the specification at shipping. Note that energy consumption can be affected by software that is installed or any changes that are made to the hardware configuration or BIOS or energy options subsequently. In such cases, the properties guaranteed by ENERGY STAR can no longer be assured.

The "ServerView Operations Manager" user guide contains instructions for reading out measurement values, including those relating to current energy consumption and air temperatures. Either the Performance Monitor or the Task Manager can be used to read out CPU utilization levels.

3.3 CE conformity



The system complies with the requirements of the EC directives 2004/108/EC regarding "Electromagnetic Compatibility" and 2006/95/EC "Low Voltage Directive". This is indicated by the CE marking (CE = Communauté Européenne).

3.4 FCC Class A Compliance Statement

If there is an FCC statement on the device, it applies to the products covered in this manual, unless otherwise specified herein. The statement for other products will appear in the accompanying documentation.

NOTE:

This equipment has been tested and found to comply with the limits for a "Class A" digital device, pursuant to Part 15 of the FCC rules and meets all requirements of the Canadian Interference-Causing Equipment Standard ICES-003 for digital apparatus. These limits are designed to provide reasonable protection against harmful interference in a residential installation. This equipment generates, uses and can radiate radio frequency energy and, if not installed and used in strict accordance with the instructions, may cause harmful interference to radio communications. However, there is no warranty that interference will not occur in a particular installation. If this equipment does cause harmful interference to radio or television reception, which can be determined by turning the equipment off and on, the user is encouraged to try to correct the interference by one or more of the following measures:

- Reorient or relocate the receiving antenna.
- Increase the separation between equipment and the receiver.
- Connect the equipment into an outlet on a circuit different from that to which the receiver is connected.
- Consult the dealer or an experienced radio/TV technician for help.

Fujitsu is not responsible for any radio or television interference caused by unauthorized modifications of this equipment or the substitution or attachment of connecting cables and equipment other than those specified by Fujitsu. The correction of interferences caused by such unauthorized modification, substitution or attachment will be the responsibility of the user.

The use of shielded I/O cables is required when connecting this equipment to any and all optional peripheral or host devices. Failure to do so may violate FCC and ICES rules.

WARNING:

This is a class A product. In a domestic environment this product may cause radio interference in which case the user may be required to take adequate measures.

3.5 Transporting the server



CAUTION!

Only transport the server in its original packaging or in packaging that protects it from impacts and jolts. Do not unpack the server until it is at its installation location.

If you need to lift or transport the server, ask other people to help you.

Never lift or carry the device by the handles on the front panel.

3.6 Notes on installing the server in the rack



CAUTION!

- **For safety reasons, at least two people are required to install the server in the rack because of its weight and size.**

(For the Japanese market, please refer to "安全上の注意およびその他の重要情報".)

- Never lift the server into the rack using the handles on the front panel.
- When connecting and disconnecting cables, observe the relevant instructions in the "Important Information" chapter of the technical manual for the corresponding rack. The technical manual is supplied with the corresponding rack.
- When installing the rack, make sure that the anti-tilt mechanism is correctly fitted.
- For safety reasons, no more than one unit may be removed from the rack at any one time during installation and maintenance work.
- If several units are simultaneously removed from the rack, there is a risk that the rack could tip over.
- The rack must be connected to the power supply by an authorized specialist (electrician).
- If the server is integrated into an installation that draws power from an industrial power supply network with an IEC309 type connector, the power supply's fuse protection must comply with the requirements for non-industrial power supply networks for the type A connector.

3.7 Environmental protection

Environmentally-friendly product design and development

This product has been designed in accordance with the Fujitsu standard for "environmentally friendly product design and development". This means that key factors such as durability, selection and labeling of materials, emissions, packaging, ease of dismantling and recycling have been taken into account.

This saves resources and thus reduces the harm done to the environment. Further information can be found at:

- http://ts.fujitsu.com/products/standard_servers/index.html (for the EMEA market)
- <http://primeserver.fujitsu.com/primergy/concept/> (for the Japanese market)

Energy-saving information

Devices that do not need to be constantly switched on should be switched off until they are needed as well as during long breaks and after completion of work.

Packaging information

This packaging information doesn't apply to the Japanese market.

Do not throw away the packaging. You may need it later for transporting the system. If possible, the equipment should only be transported in its original packaging.

Information on handling consumables

Please dispose of printer consumables and batteries in accordance with the applicable national regulations.

In accordance with EU directives, batteries must not be disposed of with unsorted domestic waste. They can be returned free of charge to the manufacturer, dealer or an authorized agent for recycling or disposal.

All batteries containing pollutants are marked with a symbol (a crossed-out garbage can). They are also marked with the chemical symbol for the heavy metal that causes them to be categorized as containing pollutants:

Cd Cadmium

Hg Mercury

Pb Lead

Labels on plastic casing parts

Please avoid sticking your own labels on plastic parts wherever possible, since this makes it difficult to recycle them.

Returns, recycling and disposal

Please handle returns, recycling and disposal in accordance with local regulations.



The device must not be disposed of with domestic waste. This device is labeled in compliance with European directive 2002/96/EC on waste electrical and electronic equipment (WEEE).

This directive sets the framework for returning and recycling used equipment and is valid across the EU. When returning your used device, please use the return and collection systems available to you. Further information can be found at

<http://ts.fujitsu.com/recycling>.

Details regarding the return and recycling of devices and consumables within Europe can also be found in the "Returning used devices" manual, via your local Fujitsu branch or from our recycling center in Paderborn:

Fujitsu Technology Solutions
Recycling Center
D-33106 Paderborn

Tel. +49 5251 525 1410

Fax +49 5251 525 32 1410

4 Hardware installation



CAUTION!

- Follow the safety instructions in the chapter "[Important information](#)" on page 27.
- Do not expose the server to extreme environmental conditions (see "[Ambient conditions](#)" on page 24). Protect the server from dust, humidity and heat.
- Make sure that the server is acclimatized for the time indicated in this table before putting it into operation.

Temperature difference (°C)	Minimum acclimatization time (hours)
5	3
10	5
15	7
20	8
25	9
30	10

Table 1: Acclimatization time

In the [table "Acclimatization time"](#), the temperature difference refers to the difference between the operating environment temperature and the temperature to which the server was exposed previously (outside, transport or storage temperature).

4.1 Unpacking the server



CAUTION!

Follow the safety instructions in [chapter "Important information" on page 27](#).

The server must always be lifted or carried by at least two people. (For the Japanese market, please refer to "安全上の注意".)

Do not unpack the server until it is at its installation location.

- ▶ Transport the server to the place where you want to set it up.
- ▶ Unpack all individual parts.

Keep the original packaging in case you want to transport the server again (applies only to EMEA market).

- ▶ Check the delivery for any damage during transport.
- ▶ Check whether the items delivered match the details on the delivery note.

The product name and serial number of the product can be found on the ID card (see section ["ID card" on page 64](#)).

- ▶ Notify your supplier immediately should you discover that the items delivered do not correspond to the delivery note.

4.2 Rack installation/removal of server



CAUTION!

- Please observe the safety information and notes on rack mounting in chapter "[Important information](#)" on page 27.
- At least two people are needed to install / remove the server in the rack. (For the Japanese market, please refer to "安全上の注意およびその他の重要情報".)
- The rack may tip over if more than one unit is removed at the same time.
- The server may not occupy the top height units of the rack (38HU/42HU PRIMECENTER Rack, DataCenter Rack, 19-inch standard rack (for the Japanese market)), as otherwise boards cannot be replaced.

4.2.1 Rack system requirements

The rack systems from Fujitsu PRIMECENTER Rack, DataCenter Rack and 19-inch standard rack (for the Japanese market) support the installation of PRIMERGY servers. Installation in most current rack systems from other manufacturers (3rd party racks) is also supported.

To accommodate the ventilation concept and ensure proper ventilation, any unused areas in the rack must be sealed using dummy covers.

The power is supplied via the multiple socket outlets fitted in the rack.

Fujitsu rack systems

The main features of PRIMECENTER Rack, DataCenter Rack and 19-inch standard rack (for the Japanese market) are as follows:

- support systems that can be mounted without tools
- support systems having a linear alignment feature to ensure that they can be adjusted to different rack depths

PRIMECENTER Rack and DataCenter Rack provide an enhanced cable management in the lateral rack area.



For PRIMECENTER Racks and DataCenter Racks:

The mounting of the rails in the different racks is described in the next sections. Installation of the cable management is described in detail in the Technical Manual for the respective rack.



For 19-inch standard rack (for the Japanese market):

For information on mounting of the rails in the 19-inch standard rack (for the Japanese market) please refer to the "Rack mount guide".

3rd party racks

Certain general conditions must be met:

– Installation dimensions (see the dimensions shown in [figure 2 on page 45](#)):

- 1 Front of rack
- 2 Rear of rack
- A Rack depth (comparison PRIMECENTER Rack 940/1000/1100 mm)
- B Rack width (comparison PRIMECENTER rack 700 mm)
- C Clearance for 19" installation level
- C1 Front 19" installation level
- C2 Rear 19" installation level
- D Cable routing area (cable area depth) and ventilation
- E Space for front panel and ventilation
- F Space for right and left support systems
- P PRIMERGY rack installation depth
- a1 Front left support upright
- a2 Front right support upright
- b1 Rear left support upright
- b2 Rear right support upright

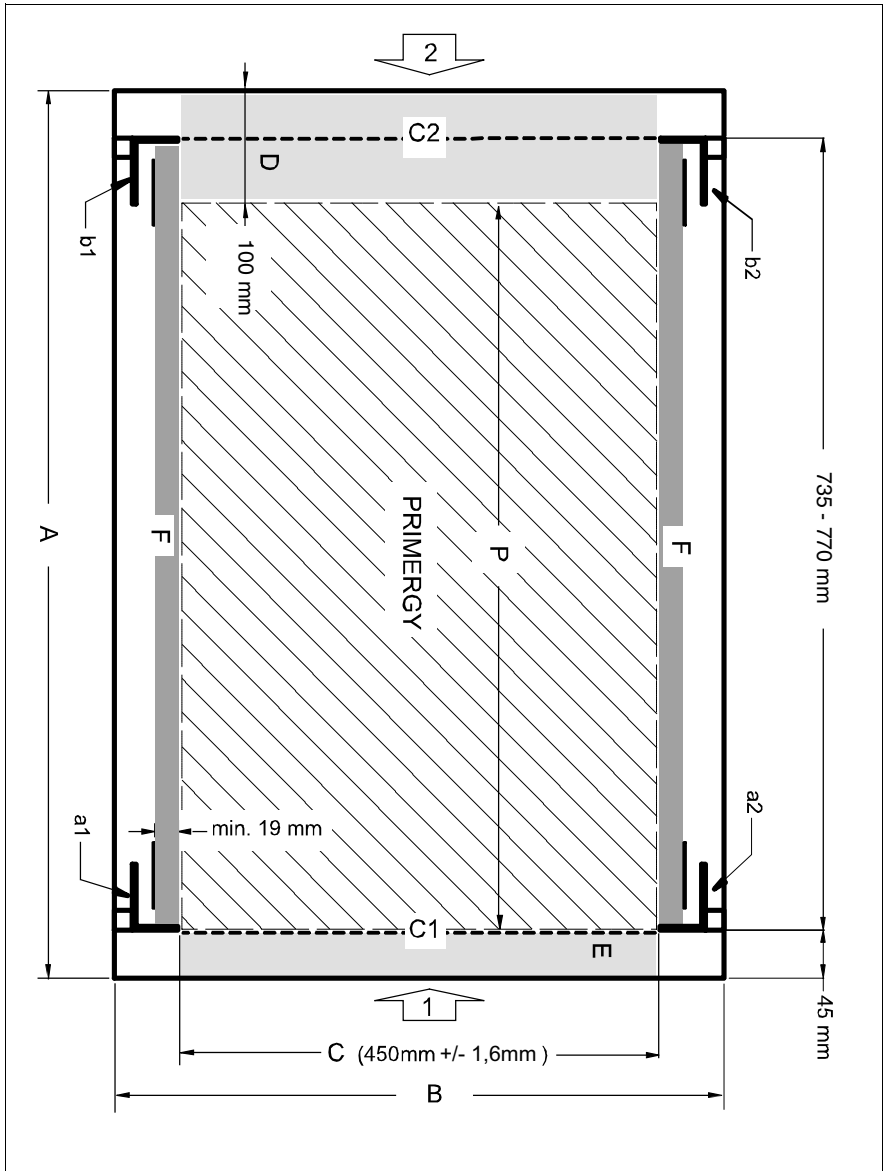

Figure 2: Mechanical requirements

- You must ensure that the safety mechanisms on the server, e.g. stoppers or retaining systems, are functioning correctly.
- The shape of the rack support uprights must ensure that the support systems can be bolted to the front.

The support systems have a linear alignment feature to ensure that they can be adjusted to different rack depths.

- No cable management support (delivered with the mounting kit).

- Climatic conditions:

An unobstructed air intake in the rack front and air discharge in the rear cover of the rack are essential for ventilation of the installed server.

In general, the ventilation concept ensures that the necessary cooling is achieved by the horizontal self-ventilation of the installed devices (air flow from the front to the rear).

- Power supply:

For installation in 3rd party racks, you must ensure that the appropriate socket strips are present.

4.2.2 Installation in PRIMECENTER/DataCenter rack

For installation in a PRIMECENTER/DataCenter rack, the following parts are required:

- Support bracket
- One support system on the left and one on the right
- M5 centering fixtures (screws with integrated plugwashers)



- The descriptions and figures in this section refer to the current support system. For other support systems you will find the appropriate description in the packaging of the rack mounting kit. For information on mounting of the rails in the 19-inch standard rack (for the Japanese market) please refer to the "Rack mount guide".
- General information regarding server installation in the rack is included in the technical manual for the appropriate rack.
- For information on mounting of the server in the 19-inch standard rack (for the Japanese market) please refer to the Rack mount guide.

Fitting the support bracket

When mounting the left support system in the corresponding rack, the supplied support bracket must first be mounted flush with the underside of the device on the rear left support upright.

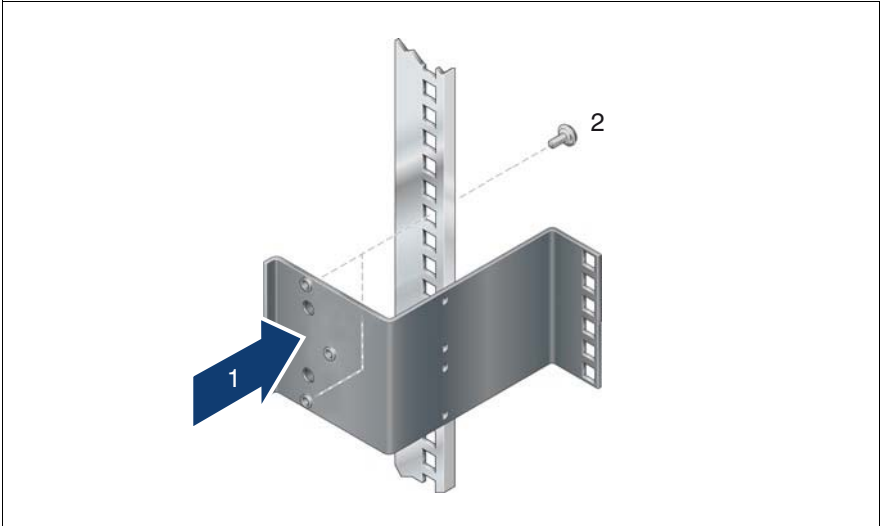

Figure 3: Fitting the support bracket

- Position the support bracket at the corresponding height on the rear left support upright, (place knob in the corresponding hole) (1) and secure it with the two supplied M5 centering fixtures (2).

Installing the support systems

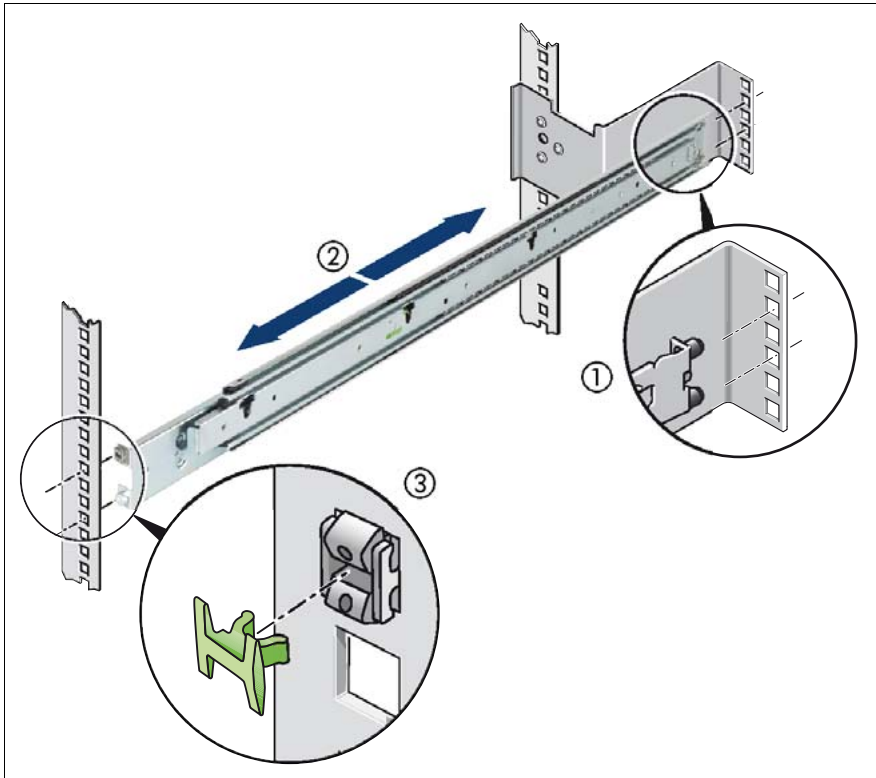

Figure 4: Fit the left support system in the PRIMECENTER/DataCenter rack

- ▶ Position the left-hand support system in the support bracket (insert retaining bolts) - see (1).
- ▶ Clamp the left-hand support system (2) between the front left support upright and the support bracket by pressing the support system together, positioning it on the front support upright and releasing it again. The support system automatically adjusts to the rack depth.

i The support system no longer has to be fixed to the front support upright because the easy lock engages and ensures a firm fit.

- ▶ Insert (3) the safety lock into the easy lock (snap fit).

**CAUTION!**

Ensure that the safety lock has been inserted before the server is inserted!

- ▶ Repeat the above steps for the right-hand support system (with the front and rear right support uprights).
- ▶ Fit the PRIMECENTER/DataCenter rack cable management as described in the Technical Manual for the corresponding rack.

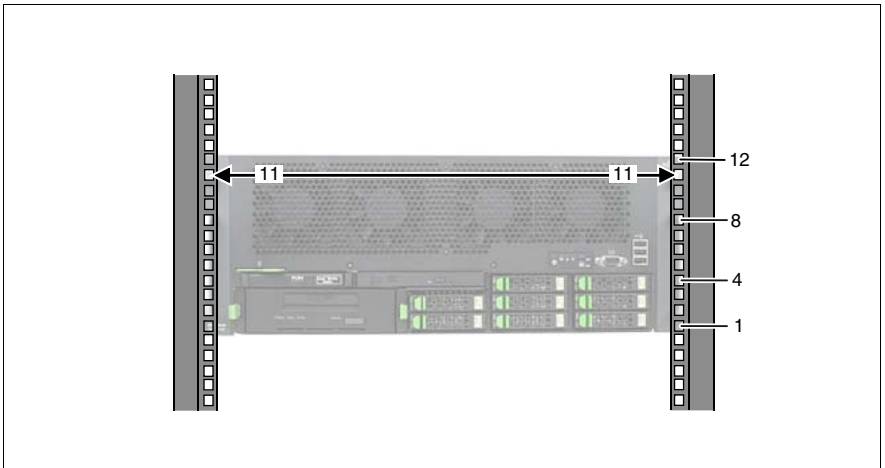

Figure 5: Position of the cage nuts

- ▶ Fit the cage nuts for securing the server in the corresponding catches on the right and left support uprights.
- ▶ Insert the server (see "[Inserting the server](#)" on page 50).

Inserting the server



For the Japanese market:
Refer to the "Rack Mounting Guide" for more detailed explanation and for other support systems.

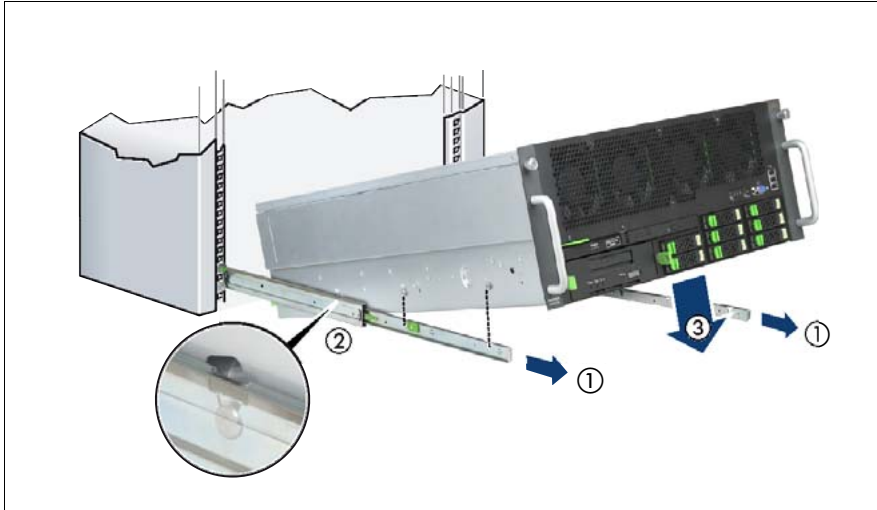

Figure 6: Inserting the server (a)

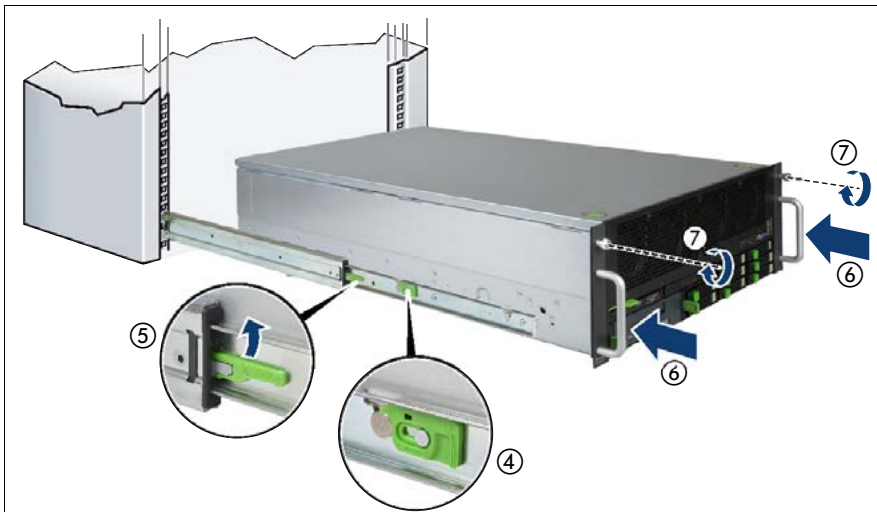

Figure 7: Inserting the server (b)

**CAUTION!**

Ensure that the safety lock has been inserted **before** the server is inserted (see [figure 4 on page 48](#)).

**CAUTION!**

At least two people are needed to position the server in the rack.
(For the Japanese market, please refer to "安全上の注意およびその他の重要情報".)

- ▶ Extend the telescopic rails completely to the front (1).



They must click into place so that they can no longer be moved.

- ▶ Lower the server from above onto the projecting telescopic rails (2), (3). As you do this, the locking bar (4) engages.
- ▶ Push the locking mechanism of both telescopic rails up (5).
- ▶ Push the server as far as it will go into the rack (6).
- ▶ Fasten the server to the rack (7) using the two knurled screws (front panel). Torque: 0.25 Nm
- ▶ Route the cables as described in the Technical Manual for the rack in question with the server pushed in.

4.2.3 Installation in 3rd party racks



The support systems from Fujitsu are suitable for use in any 3rd party racks for standard servers (installation depth 714 - 785 mm) without restrictions.

- ▶ Refer to the manual from the rack manufacturer for details of the mechanical installation and the climatic conditions.

**CAUTION!**

When installing in 3rd party racks, it must be ensured that an air flow from the front to the back of the rack is guaranteed.

- ▶ Fit the required original parts (support bracket or cable management system).



Under certain circumstances, you will not be able to use some of the parts from the rack installation kit supplied - you will need to use original 3rd party rack parts instead.

Racks with installation depth of 735 mm

The lengths of the telescopic rails do not need to be adjusted with respect to each other for the installation in rack systems with 735 mm installation depth.

- ▶ Secure the support systems as described in section "[Installing the support systems](#)" on page 48.
- ▶ Mount the server (see "[Inserting the server](#)" on page 50) and route the cables as described in the original manual of the rack.



CAUTION!

Ensure that the safety lock has been inserted **before** the server is inserted (see [figure 4 on page 48](#)).

Racks with installation depth smaller/greater than 735 mm

The support systems can be used for installation depths of 714 - 785 mm. The spring element of the support system is used to adjust the length as required.

- ▶ Secure the support systems as described in "[Installing the support systems](#)" on page 48.
- ▶ Mount the server (see "[Inserting the server](#)" on page 50) and route the cables as described in the original manual of the rack.



CAUTION!

Ensure that the safety lock has been inserted **before** the server is inserted (see [figure 4 on page 48](#)).

4.3 Connecting devices to the server

The connectors for external devices are on the front and rear of the server. The additional connectors available on your server depend on the expansion cards installed (e.g. optional SAS connector).

i Some of the devices that can be connected may require special software, e.g. drivers (see the documentation for the connected device).



Figure 8: Connectors on the front

On the front of the server are a video connector (1) and three USB connectors (2).

i The two video connectors on the front and rear (see [figure 9 on page 54](#)) can only be used alternatively; the connector not used is automatically deactivated.

The standard connectors on the rear are marked with symbols, and one is color-coded:

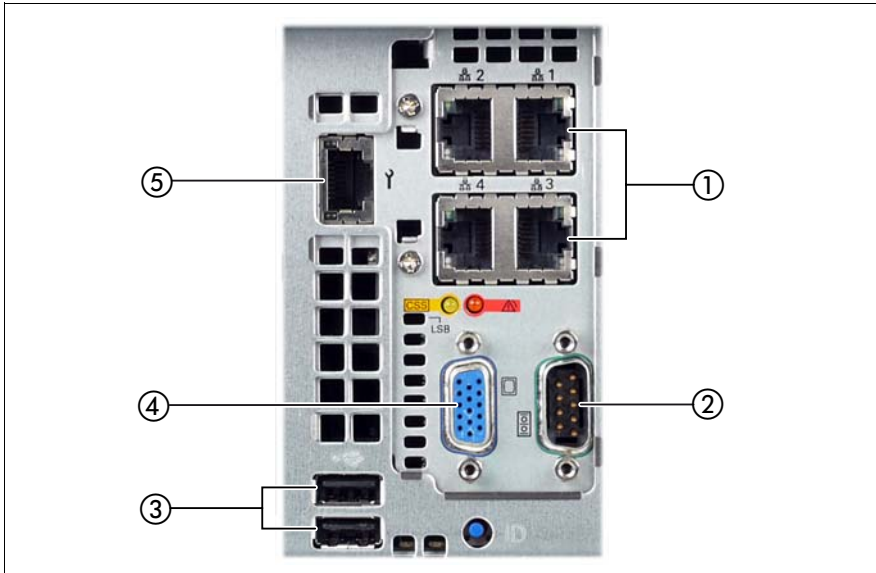

Figure 9: Connectors on the rear

1	4x LAN connector	4	Video connector (blue)
2	Serial connector COM1	5	Management LAN connector
3	2 x USB connector		

- ▶ Connect the data cables to the server and peripherals.



Connect keyboard and mouse via USB. There are no separate PS/2 connectors for them.

Connecting the monitor

- ▶ Plug the data cable for the monitor into the video connector on the server. Alternatively, the video connector at the front or the rear of the server can be used.
- ▶ Connect the power cord of the monitor to a grounded mains outlet of the in-house mains and/or into the mains socket strip of the rack.

4.4 Connecting the server to the mains



CAUTION!

The server is automatically set to a mains voltage in the range 100 - 127 V / 200 - 240 V. You may only operate the server if its rated voltage range corresponds to the local mains voltage.

4.4.1 Installation requirements

The power subsystem consists of:

- Power supply modules (PSU)
- A power distribution board (PDB)

The power supply subsystem can support up to 4 PSUs which all connect to the PDB. The total system is rated 100 - 127 V / 200 - 240 V, 50/60 Hz, 28/14 A. The minimum system configuration requires installation of at least two PSUs. The PSU is considered hot-swappable (see "[Hot-plug power supply units](#)" on [page 93](#)). The system can be configured to support *True AC redundancy or non-AC redundancy.



*True AC redundancy is recommended for systems used for critical business applications. This will result in the system to continue operation during a power failure as the redundant part of the subsystem is plugged into a separate AC source [e.g. uninterruptable power supply (UPS)].



Refer to tables below for maximum DC loading for both AC redundant and AC non redundant configurations.

Installation requirements for AC redundant configurations

The AC redundant configuration is with two PSU plugged into a main AC source and two other PSUs plugged into a separate AC source (e.g. UPS).

PSU Configuration	Max. DC Loading	DC Redundancy
1+1 (2 PSUs)	830W	Yes
2+2 (4 PSUs)	1580W	Yes

Table 2: Maximum DC Loading Requirements

Installation requirements for AC non redundant configurations

For systems not requiring AC redundancy, the power supply subsystem can be installed with up to 4 PSUs. The PSUs can be connected to a single or multiple AC sources.

PSU Configuration	Max. DC Loading	DC Redundancy
1+1 (2 PSUs)	830W	Yes
2+1 (3 PSUs)	1580W	Yes
3+1 (4 PSUs)	2320W	Yes

Table 3: Maximum DC Loading Requirements

Three power supply modules are capable of handling the maximum power requirements for a fully configured PRIMERGY RX600 S5 server system, which include the following:

- Four processors
- 1024 GB of memory
- Eleven PCIe add-in cards (including the SAS/SATA RAID controller card)
- Eight hard disk drives
- One optical drive
- One tape drive

The hot swap feature allows the user to replace a failed power supply module without affecting the system functionality.

AC source related power supply configuration and system load limits

The system configuration and load is limited by the number of AC mains power sources available as indicated in the following table.

Number of power supply modules installed	AC redundant systems (requires 2 AC sources)		AC non-redundant systems (connected to 1 AC source)	
	Max. DC loading to support AC redundancy	Installation requirements	Max. DC loading for AC non-redundant systems	Installation requirements
2	830W	2 PSUs connected to mains (1+1)	1580W	2 PSUs connected to mains (1+1)
3	N/A	N/A	2320W	3 PSUs connected to mains (2+1)
4	1580W	2 PSUs connected to mains 2 PSUs connected to an isolated AC source e.g. UPS (2+2)	2320W	4 PSUs connected to mains (3+1)

Table 4: System power supply configuration and system load limits

Installation in PRIMECENTER/Datacenter rack

Please follow the installation requirements for connection to the mains described in the rack manuals.

Installation in 3rd party racks without main connection according to IEC309 or outside of racks

1. These additional installation requirements **ONLY** apply when 4 PSUs are connected to a high line voltages (220V or higher).
2. These requirements **DO NOT** apply when PSUs are connected to low line voltages (100-127V and 200V) **OR** if at least one PSU is connected into a separate AC source (e.g. UPS).

**CAUTION!**

These additional installation requirements are **REQUIRED** to avoid risk of high leakage current which may result in electric shock.

1. Systems **REQUIRE** being installed in a location having equipotential bonding (such as a telecommunication center, a dedicated computer room or a ***RESTRICTED ACCESS LOCATION**).

* Definition of **RESTRICTED ACCESS LOCATION** is a location for equipment where both of the following apply:

- Access can only be gained by **SERVICE PERSONS** or by **USERS** who have been instructed about the reasons for the restrictions applied to the location and about any precautions that shall be taken; and
 - Access is through the use of a **TOOL** or lock and key, or other means of security, and is controlled by the authority responsible for the location.
2. The building installation shall provide means for connection to protective earth as follows: Connection to protective earth can be provided by the socket-outlet that provides power to the PSU. A service person requires checking the socket-outlet to make sure it has a protective earth. If the socket-outlet does not have a protective earth, then the service person requires arranging:
 - Installation of a protective earth conductor from the system to the building installation. The grounding bolt is located on the chassis rear left side wall designated by the  symbol.

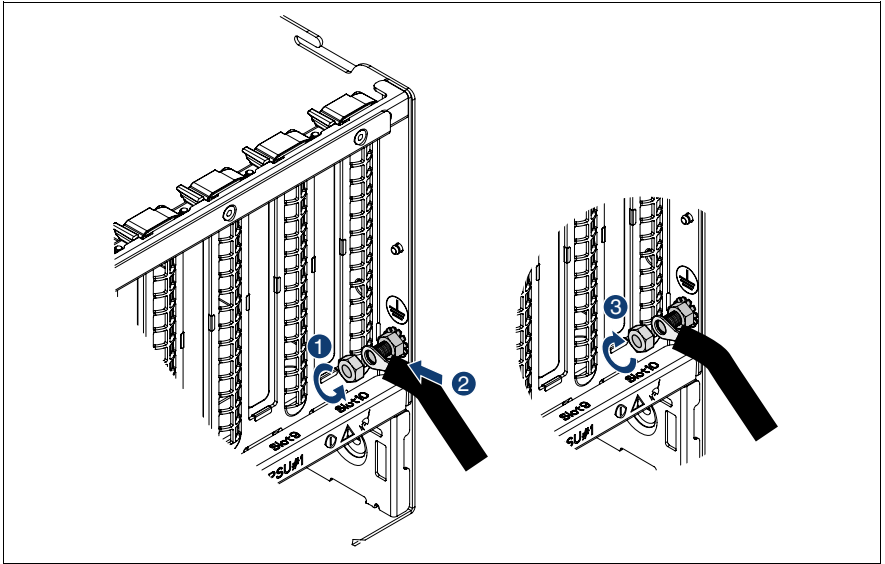

Figure 10: Installing a protective earth conductor

- ▶ Loosen the first nut and remove it (1).
- ▶ Plug the protective earth conductor onto the bolt (2).
- ▶ Replace the nut and tighten it (3).

4.4.2 Connecting the power cord

- ▶ Connect the power cord to the server power supply unit.
- ▶ Connect the mains plug to a grounded mains outlet in the in-house power supply network or a power outlet of the socket strip in the rack (see Technical Manual for the rack).
- ▶ Secure the power cords in the cable clamps so the insulated connectors cannot be disconnected from the server accidentally.



Figure 11: Cable clamps to secure the power cords

- ▶ Thread the cable through the cable clamp as shown in [figure 11](#).
- ▶ Pull the cable clamp tight to secure the power cord.

Now the insulated connector cannot be disconnected from the server accidentally.

i You can loosen the cable clamp by opening the small locking lever.

4.5 Notes on connecting/disconnecting cables



CAUTION!

Always read the documentation supplied with the device you wish to connect.

Never connect, or disconnect cables during a thunderstorm.

Never pull on a cable when disconnecting it. Always take hold of the cable by the plug.

Follow the sequence described below to connect or disconnect external devices to or from the server:

Be sure to wait for 10 seconds or more after shutdown before turning the server on.

Connecting cables

- ▶ Turn off all power and equipment switches.
- ▶ Disconnect all power plugs from the properly grounded power outlets.
- ▶ Connect all cables to the server and peripherals.
- ▶ Plug all data communication cables into the utility sockets.
- ▶ Plug all power cords into the properly grounded power outlets.

Disconnecting cables

- ▶ Turn off all power and equipment switches.
- ▶ Disconnect all power plugs from the properly grounded power outlets.
- ▶ Unplug all data communication cables from the utility sockets.
- ▶ Disconnect the relevant cables from the server and all the peripherals.



For connecting or disconnecting LAN cables, the server need not to be powered off. To avoid loss of data teaming function has to be enabled.

5 Starting up and operation



CAUTION!

Follow the safety instructions in chapter "[Important information](#)" on [page 27](#).

5.1 Control elements and indicators

5.1.1 Front of server

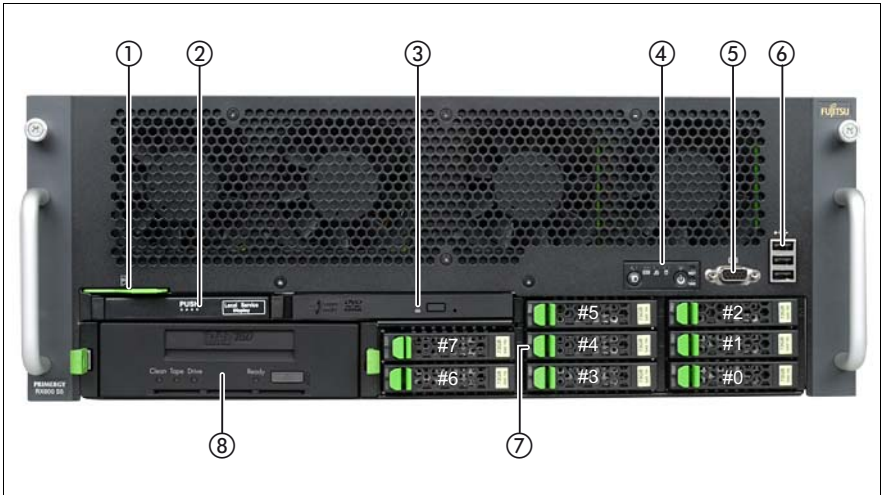

Figure 12: Front - overall view

1	ID card	5	Video connector
2	ServerView Local Service Display	6	3x USB connector
3	Optical drive activity indicator	7	Hard disk indicators
4	Control panel (for details see page 64)	8	Tape (optional)

The white numbers in [figure 12](#) show the HDD slot assignment.

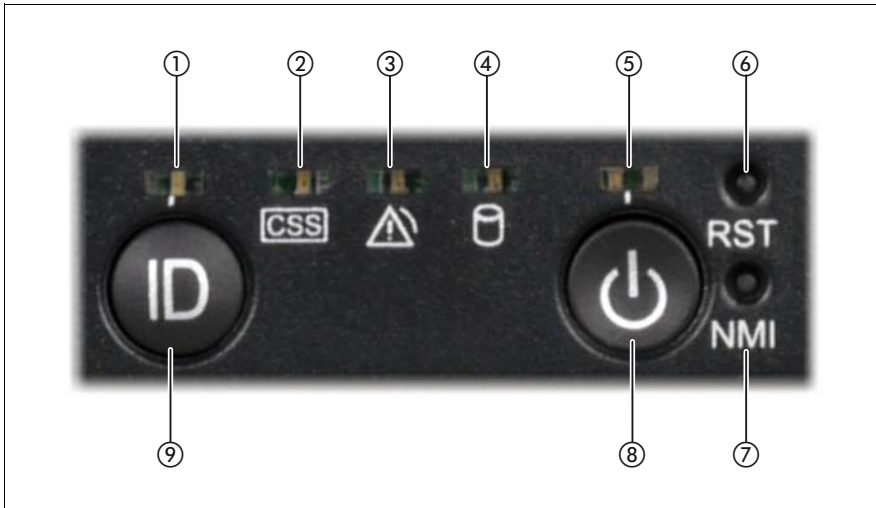

Figure 13: Front - detailed view: control panel

1	ID indicator	6	Reset button
2	CSS indicator	7	NMI button
3	Global Error indicator	8	On/Off button
4	Hard disk activity indicator	9	ID button
5	Power-on indicator		

ID card

You can pull out the ID card (see [figure 12](#) above) as far as it will go and push it back in again.

The ID card contains various system information, such as product name, serial number and order number; in the Japanese market only the product name and the serial number.

5.1.1.1 Control elements

ID ID button

ID LED lights up (blue) on the front and on the rear of the server when the ID button is pressed. Both ID indicators are synchronized.



On/Off button

When the system is switched off, it can be switched on again by pressing the On/Off button.

When the system is operating, pressing the On/Off button will switch off the system.



CAUTION!

Risk of loss of data!



The On/Off button does not disconnect the server from the mains voltage. To disconnect from the mains completely, remove the power plug(s).

RST Reset button

Pressing the reset button reboots the system.



CAUTION!

Risk of loss of data!

NMI NMI button



CAUTION!

Do not press! Risk of loss of data! The NMI button may only be used by service.

5.1.1.2 Indicators on the control panel

ID ID indicator (blue)

Lights up blue when the system has been selected by pressing the ID button. To deactivate, press the button again.

The ID indicator can also be activated via the ServerView Operations Manager and the iRMC S2 Web interface and its status reported to the ServerView Operations Manager and the iRMC S2.



Power-on indicator (green/orange/yellow)

Lights up green – and also lights up orange for less than one second – when the server is switched ON.

Flashes green when the system is in standby mode.

Lights up orange when the server is in shutdown mode (operating system shutdown) or is switched off.

Lights up yellow during power on delay.

CSS CSS indicator (yellow)

- **Lights up yellow** if a prefailure event was detected for a CSS component that you can fix yourself (for reasons of precaution) with the CSS concept.
- **Flashes yellow** if an error was detected that you can fix yourself with the CSS concept.
- **Does not light up** when the system is OK.

If the event is still acute after a power failure, the indicator is activated after the restart.

The indicator also lights up in standby mode.

For more information on the CSS concept, see "[Customer Self Service \(CSS\)](#)" on page 14.



Hard disk activity indicator (green)

Lights up green when an internal hard disk drive is accessed.



Global Error indicator (orange)

- **Lights up orange** if a prefailure event has been detected that requires (precautionary) service intervention.
- **Flashes orange** if an error was detected that requires service intervention.
- **Does not light up** if there is no critical event.

If the event is still acute after a power failure, the indicator is activated after the restart.

The indicator also lights up in standby mode.

You can find more details on the indicated errors in the System Event Log (SEL), on the ServerView Local Service Display, in the ServerView Operations Manager or via the iRMC S2's Web interface.

5.1.1.3 Indicators on the accessible drives/components

DVD drive activity indicator

Lights up green when the storage medium is being accessed.

ServerView Local Service Display

You can use the slot mechanism to pull out the ServerView Local Service Display from the server housing and read the information. Press the front of the module to release the lock.

You can also pivot the ServerView Local Service Display down by an angle of 120° from its normal position. This makes reading easier when the server is located very high in the rack.

Further information on using the ServerView Local Service Display is provided in the "Customer Self Service (CSS)" manual.

5.1.1.4 Indicators on the hot-plug HDD modules



Figure 14: Indicators on a hot-plug HDD module

1	HDD BUSY (green) <ul style="list-style-type: none"> – Lights up: HDD in active phase (drive active, drive being accessed) – Does not light: HDD inactive (drive inactive)
2	HDD FAULT (orange) <ul style="list-style-type: none"> – Does not light: no HDD error – Lights up: HDD Faulty or Rebuild Stopped (drive defective/needs replacing, a rebuild process was stopped or the HDD module is not correctly inserted) – Slow flashing: HDD Rebuild (the data is being restored after changing a drive)

If a hard disk drive continuously indicates an error, the drive should be replaced as soon as possible. This can be done during operation (see "[Hot-plug HDD modules](#)" on page 100).

5.1.2 Rear of server

5.1.2.1 Global Error indicator and CSS indicator

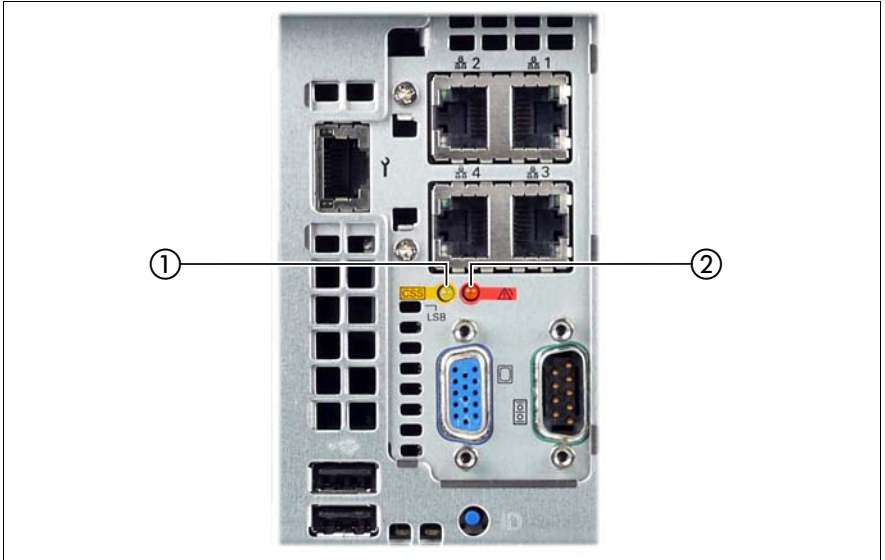

Figure 15: Global Error indicator and CSS indicator

1	<p>CSS indicator (yellow)</p> <ul style="list-style-type: none"> – Lights up yellow if a prefailure event was detected for a CSS component that you can fix yourself (for reasons of precaution) with the CSS concept. – Flashes yellow if an error was detected that you can fix yourself with the CSS concept. – Does not light up when the system is OK. <p>If the event is still acute after a power failure, the indicator is activated after the restart.</p> <p>The indicator also lights up in standby mode.</p> <p>For more information on the CSS concept, see "Customer Self Service (CSS)" on page 14.</p>
---	--

2	<p>Global Error indicator (orange)</p> <ul style="list-style-type: none">– Lights up orange if a prefailure event has been detected that requires (precautionary) service intervention.– Flashes orange if an error was detected that requires service intervention.– Does not light up if there is no critical event. <p>If the event is still acute after a power failure, the indicator is activated after the restart.</p> <p>The indicator also lights up in standby mode.</p> <p>You can find more details on the indicated errors in the System Event Log (SEL), on the ServerView Local Service Display, in the ServerView Operations Manager or via the iRMC S2's Web interface.</p>
---	--

5.1.2.2 ID indicator and button

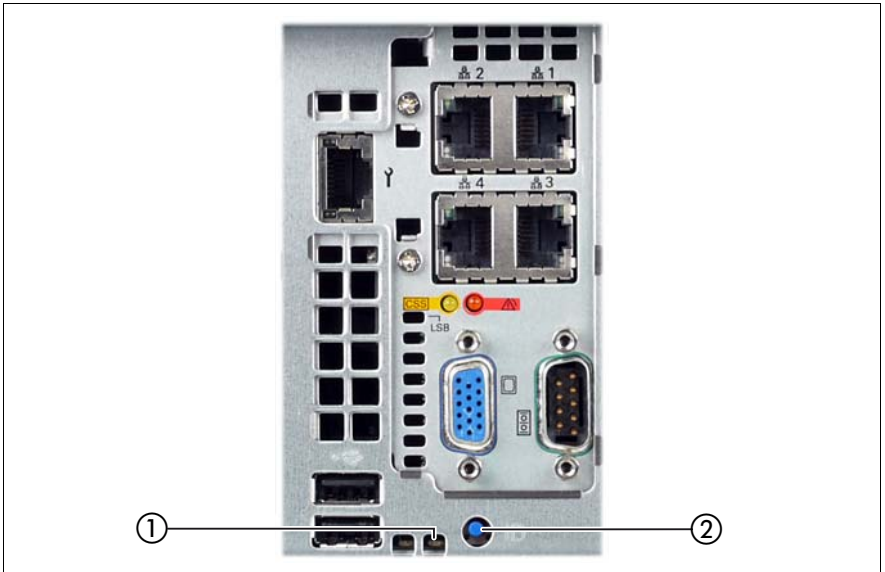

Figure 16: ID indicator

1	<p>ID indicator (blue)</p> <p>Lights up blue when the system has been selected by pressing the ID button. To deactivate, press the ID button again.</p> <p>The ID indicator can also be activated via the ServerView Operations Manager and the iRMC S2 Web interface and its status reported to the ServerView Operations Manager and the iRMC S2.</p>
2	ID button

5.1.2.3 Indicators on the connector panel (LAN indicators)

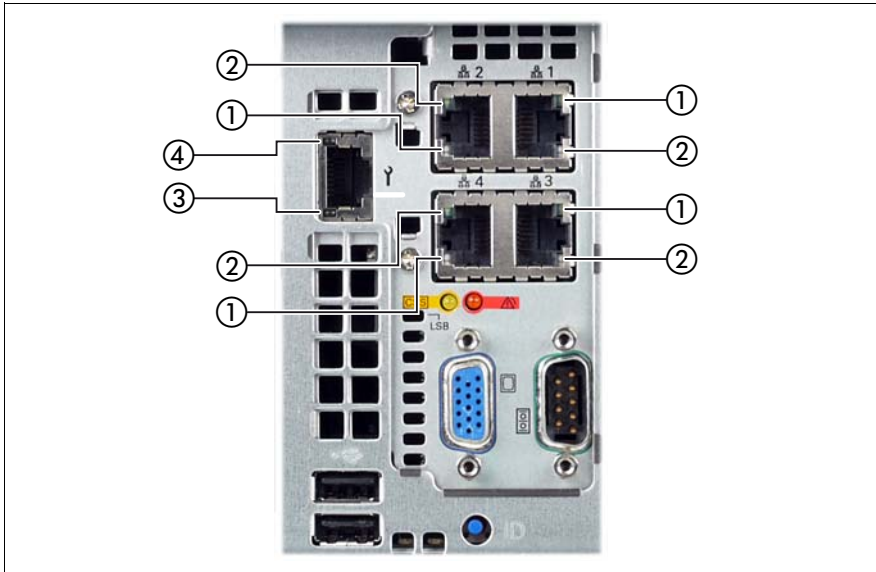

Figure 17: LAN indicators

1	LAN speed (system LAN/ shared LAN)	<p>Steady yellow signal in the event of a LAN transfer rate of 1 Gbit/s.</p> <p>Steady green signal in the event of a LAN transfer rate of 100 Mbit/s.</p> <p>Remains dark in the event of a LAN transfer rate of 10 Mbit/s.</p>
2	LAN link/transfer (system LAN/ shared LAN)	<p>Steady green signal when a LAN connection exists.</p> <p>Remains dark when no LAN connection exists.</p> <p>Flashes green when LAN transfer takes place.</p>
3	LAN speed (management LAN)	<p>Steady green signal in the event of a LAN transfer rate of 100 Mbit/s.</p> <p>Remains dark in the event of a LAN transfer rate of 10 Mbit/s.</p>

4	LAN link/transfer (management LAN)	<p>Steady green signal when a LAN connection exists.</p> <p>Remains dark when no LAN connection exists.</p> <p>Flashes green when LAN transfer takes place.</p>
---	------------------------------------	--

5.1.2.4 Indicators on the hot-plug power supply units

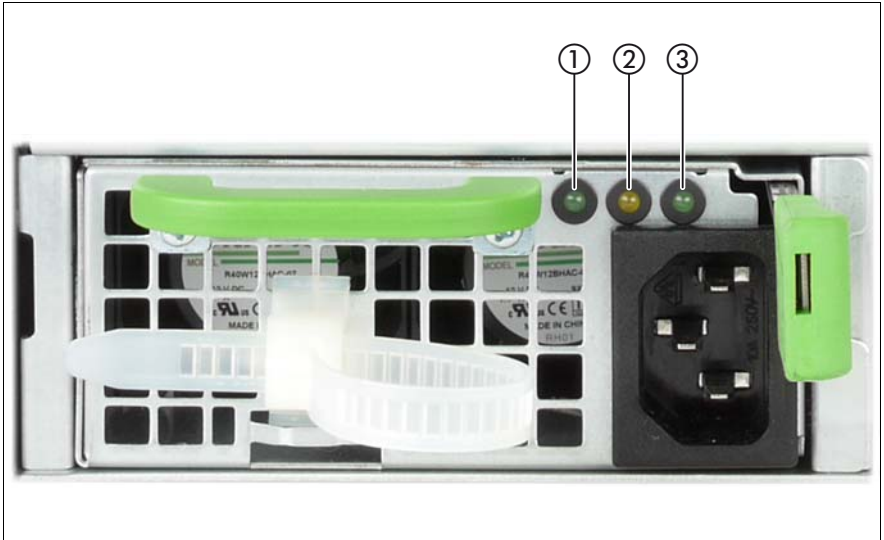

Figure 18: Indicators on the power supply units

1	DC power redundancy indicator	<p>Lights up green when PSU is running.</p> <p>Flashes green when PSU is in cold redundancy mode.</p>
2	PSU failure and warnings indicator	<p>Lights up amber in case of a critical event (PSU shutdown).</p> <p>Flashes amber in case of a warning event (operation continue).</p>
3	AC power supply input status indicator	<p>Lights up green if AC power is present.</p> <p>Flashes green if AC power is not present.</p>

In normal server operation, LED 1 and 3 light up permanently, LED 2 does not light up. As soon as LED 2 indicates a fault by lighting up, the affected power supply unit should be replaced as soon as possible. This can be done during operation (see "[Hot-plug power supply units](#)" on page 93).

5.2 Switching the server on and off



CAUTION!

- If nothing appears on the screen but flickering stripes after switching on the server, switch the server off immediately (see chapter "[Troubleshooting and tips](#)" on page 85).
- The On/Off button does not disconnect the server from the mains voltage. To completely disconnect it from the mains voltage, remove the power plug(s) from the socket(s).
- Do not move, strike, or shake the server when it is turned on. This can damage the hard disk in the server and cause data loss.
- Turn the server on when the temperature is in its operating environment range (10–35°C). For details on the operating environment, refer to "Safety Precautions". When operating the device outside of this operating environment, the server may operate improperly, damage data etc. Furthermore, Fujitsu cannot be held responsible for any related damage, malfunction, or loss of data, etc.
- Be sure to wait for 10 seconds or more after shutdown before turning the server on.
- After connecting the power cords, press the On/Off button after it passes for more than 10 seconds.

Switching the server on

The power-on indicator (see [figure 13 on page 64](#)) lights up orange (standby mode) when the server is connected to the mains.

– Starting up for the first time:

For the Japanese market, please refer to "はじめにお読みください".

- ▶ Press the On/Off button (see [figure 13 on page 64](#)).
- ▶ Insert ServerView Suite DVD 1 in the DVD drive.
- ▶ Follow the on-screen instructions (see also section "[Configuring the server and installing the operating system with the ServerView Installation Manager](#)" on page 79 or section "[Configuring the server and installing the operating system without the ServerView Installation Manager](#)" on page 80).

– **System already installed:**

- ▶ Press the On/Off button (see [figure 13 on page 64](#)).

The server is switched on, performs a system test and boots the operating system.

Switching the server off

The power-on indicator lights up green (item 5 in [figure 13 on page 64](#)).

- ▶ Shut down the operating system properly.

The server is switched off automatically and goes into standby mode. The power-on indicator lights up orange.



If the operating system does not switch the server off automatically, press the On/Off button for at least four seconds and/or send a corresponding control signal.

Other On/Off options

Besides the On/Off button, the server can be switched ON and OFF in the following ways:

– **Timer-controlled switch-on/off**

Using the ServerView Operations Manager or iRMC S2, you can configure that the server is switched on/off controlled by timer.

– **Ring indicator**

The server is switched on by an internal or external modem.

– **Wake up On LAN (WOL)**

The server is switched on by a command via the LAN (Magic Packet™).

– **After power failure**

The server automatically reboots following a power failure (depending on the settings in the BIOS or in iRMC S2).

– **Power button override**

The system can be switched off by pressing and holding down the On/Off button (for approximately 4 - 5 seconds).

**CAUTION!**

There is a risk that data may be lost.

– iRMC S2

iRMC S2 offers various options for switching the server on and off, e.g. via the *Power On Off* page of the iRMC S2 Web interface.

**CAUTION when turning the power off (Windows Server 2008 or Windows Server 2003)!**

The operation of the power switch can be specified as "Do Nothing", "Ask me what to do" (only for Windows Server 2003), "Stand by", "Hibernate", and "Shutdown" depending on the OS settings. The default is "Shutdown".

On this server, functions corresponding to "Stand by" and "Hibernate" are supported as BIOS and hardware functions. However, some drivers and software installed in the server do not support these functions. For this reason, functions corresponding to "Stand by" and "Hibernate" are unavailable on this server. When the operating mode is set to "Stand by" or "Hibernate", the system may operate improperly or hard disk data may be corrupted.

For details about operating mode settings, refer to the manual supplied with the OS.

5.3 Configuring the server

This section contains information about configuring the server and installing the operating system.

-  Make sure that the energy saving functions are disabled in the BIOS Setup during server operation.

5.3.1 Configuring the SAS/SATA RAID controller card

The server comes with a SAS/SATA RAID controller with "MegaRAID functionality". You can configure the SAS/SATA RAID controller either before or during installation with the ServerView Installation Manager. Using the ServerView Installation Manager is recommended.

-  A separate utility is available to the controller for MegaRAID configuration. For further information, refer to the "SAS Software User's Guide" (on the ServerView Suite DVD 2 under *Industry Standard Servers - Expansion Cards - Storage Adapters - LSI Configuration Software*).

Further information on modular RAID controllers is provided in the "Modular RAID Controller Installation Guide" (on the ServerView Suite DVD 2 under *Industry Standard Servers - Expansion Cards - Storage Adapters - LSI RAID / SCSI Controllers*).

-  Descriptions of operating systems not covered in the controller manual are provided in the corresponding readme files on the driver CDs.

5.3.2 Configuring the server and installing the operating system with the ServerView Installation Manager

Using the ServerView Installation Manager on the ServerView Suite DVD 1 provided, you can conveniently configure the server and install the operating system. This includes configuring the server-specific settings using the ServerView Configuration Manager and configuring the RAID controller using the **ServerView RAID Manager**.

Advantages of the ServerView Installation Manager

- Wizard assisted configuration of your server hardware and disk arrays
- Wizard assisted installation of all leading server operating systems
- Wizard-assisted creation of configuration files for unattended installation of several PRIMERGY servers with identical hardware configurations.
- Installation of drivers and additional software.



The software that can be installed depends on your server's hardware configuration. This configuration is detected automatically.



Descriptions of operating systems not covered in the RAID controller manual are provided in the corresponding readme files on the driver CDs.

To find out how to operate the ServerView Installation Manager and for further information, refer to the associated manual.

If you are using the ServerView Installation Manager, you can skip the following section on how to configure the server and install the operating system. Continue from section "[Cleaning the server](#)" on page 81.

5.3.3 Configuring the server and installing the operating system without the ServerView Installation Manager

Installing the operating system

- ▶ Insert the CD/DVD/BD for the operating system you want to install.
- ▶ Reboot the server.
- ▶ Follow the instructions on screen and in the manual for the operating system.

5.4 Cleaning the server



CAUTION!

Switch the server off and disconnect the power plugs from the properly grounded power outlets.

Do not clean any interior parts yourself; leave this job to a service technician.

Do not use any cleaning agents that contain abrasives or may corrode plastic.

Ensure that no liquid enters the system. Ensure that the ventilation areas of the server and the monitor are clear.

Do not use any cleaning sprays (including flammable types). It may cause a device failure or a fire.

Clean the keyboard and the mouse with a disinfecting cloth.

Wipe the server and monitor casing with a dry cloth. If particularly dirty, use a cloth that has been moistened in a mild domestic detergent and then carefully wrung out.

6 Property and data protection

6.1 Mechanical access protection

The lockable rack door protects the server against unauthorized access.

6.2 BIOS Setup security functions

The *Security* menu in BIOS Setup offers various options for protecting your data from unauthorized access. For example, you can assign passwords for users and administrators. By combining these options you can achieve optimum protection for your system.



A detailed description of the *Security* menu and how to assign passwords can be found in the BIOS Setup documentation on the ServerView Suite DVD 2.

7 Troubleshooting and tips



CAUTION!

Follow the safety instructions in the "Safety notes and regulations" manual or "安全上のご注意" and in chapter "[Important information](#)" on [page 27](#).

If a fault occurs, attempt to resolve it using the measures described:

- in this chapter,
- in the documentation for the connected devices,
- in the help systems of the software used.

If you fail to correct the problem, proceed as follows:

- ▶ Make a list of the steps performed and the circumstances that led to the fault. Also make a list of any error messages that were displayed.
- ▶ Switch off the server.
- ▶ Contact our customer service team.

7.1 Power-on indicator remains unlit

The power-on indicator remains dark after you switch on your device.

Power cable incorrectly connected

- ▶ Make sure that the power cable(s) is/are correctly connected to the server and the grounded power outlet(s).

Power supply overloaded

- ▶ Disconnect the server power plug(s) from the grounded power outlet(s).
- ▶ Wait a few seconds before you plug it/them into the grounded power outlet(s) again.
- ▶ Switch on your server.

7.2 Server switches itself off

Server Management has detected an error

- ▶ Check the error list of System Event Log in ServerView Operations Manager or in the iRMC S2 web interface, and attempt to eliminate the error.

7.3 Screen remains blank

Monitor is switched off

- ▶ Switch on your monitor.

Screen has gone blank

- ▶ Press any key on the keyboard.
or
- ▶ Deactivate screen saver. Enter the appropriate password.

Brightness control is set to dark

- ▶ Set the brightness control on the monitor to light. For detailed information, refer to the operating manual supplied with your monitor.

Power cable or monitor cable not connected

- ▶ Switch off the monitor and the server.
- ▶ Check whether the power cable is properly connected to the monitor and to the grounded power outlet.
- ▶ Check whether the monitor cable is properly connected to the server and monitor (if it is plugged in with a connector). If a separate graphics card is installed in the server, then the monitor cable must be connected to the graphics card.
- ▶ Switch on the monitor and the server.

7.4 Flickering stripes on monitor screen



CAUTION!

Switch off the server immediately. Risk of damaging the server.

Monitor does not support the set horizontal frequency

- ▶ Find out which horizontal frequency your monitor screen supports. You will find the horizontal frequency (also known as line frequency or horizontal deflection frequency) in the documentation for your monitor.
- ▶ Refer to the documentation for your operating system or the software for the screen controller for details of how to set the correct horizontal frequency for your monitor, and follow the procedure accordingly.

7.5 No screen display or display drifts

The wrong horizontal frequency or resolution has been selected for the monitor or for the application program.

- ▶ Find out which horizontal frequency your monitor screen supports. You will find the horizontal frequency (also known as line frequency or horizontal deflection frequency) in the documentation for your monitor.
- ▶ Refer to the documentation for your operating system or the software for the screen controller for details of how to set the correct horizontal frequency for your monitor, and follow the procedure accordingly.

7.6 Incorrect date and time

- ▶ Set the date and time in the operating system or in the BIOS Setup under the *Main* menu, using *System Date* and *System Time* respectively.



Note that the operating system may affect the system time. For example, the operating system time may deviate from the system time under Linux, and would overwrite the system time in the default setting on shutdown.

If the date and time are still wrong after the server has been switched off and back on again, replace the lithium battery (for a description refer to the Technical Manual for the D2870 system board) or contact our customer service team.

7.7 Drives reported as "dead" when starting system

RAID controller configuration incorrect

- ▶ Check and correct the settings for the drives using the RAID controller utility.

Further information is provided in the manual for the RAID controller.

7.8 Added drive reported as defective

RAID controller is not configured for this drive

The drive was probably installed when the system was switched off.

- ▶ Reconfigure the RAID controller for the drive using the corresponding utility. Information is provided in the documentation for the RAID controller.

or

- ▶ Remove and reinstall the drive while the system is switched ON.

If the hard disk drive continues to be shown as defective, then replace it (see ["Hot-plug HDD modules" on page 100](#)).

7.9 Error message on screen

The meaning of the error message is explained in the documentation for the relevant components and programs on the ServerView Suite DVD 2.

8 CSS components

This chapter describes how to handle CSS components and how to identify defective CSS components and replace them yourself.



Further information on the CSS concept is provided in the "ServerView Suite Local Service Concept - LSC" manual on the ServerView Suite DVD 2.

For the latest information on optional products provided for the RX600 S5 see the configurator of the server:

http://ts.fujitsu.com/products/standard_servers/index.htm
(for the EMEA market)

<http://primeserver.fujitsu.com/primergy/system.html>
(for the Japanese market)



CAUTION!

- Do not disassemble the power supply unit. Doing so may cause electric shock.
- Do not damage or modify internal cables or devices. Doing so may cause a device failure, fire, or electric shock.
- Devices inside the server remain hot after shutdown. Wait for a while after shutdown before installing or removing internal options.
- The circuit boards and soldered parts of internal options are exposed and can be damaged by static electricity. Before handling them, first touch a metal part of the server to discharge static electricity from your body.
- Do not touch the circuitry on boards or soldered parts. Hold the metallic areas or the edges of the circuit boards.
- If devices are installed or disassembled using methods other than those outlined in this chapter, the warranty will be invalidated.
- The installation indicated on this note is sometimes changed to the kind of possible options without notice.
- Follow the safety instructions in the chapter "[Important information](#)" on page 27.

In the PRIMERGY RX600 S5 server, the following components are considered to be CSS components:

- Hot-plug components
 - Hot-plug power supply units (see [page 93](#))
 - Hot-plug fans (see [page 97](#))
 - Hot-plug HDD modules (see [page 100](#))
 - Hot-plug memory boards (see [page 115](#))
 - Expansion cards in hot-plug PCIe slots (slots 6 & 7 only, see [page 107](#))

You can expand or replace the hot-plug components during operation.

- Non-hot-plug components
 - Expansion cards in non-hot-plug slots (see [page 122](#))

These components can be changed by you in the event of an error. Expansions and upgrades may only be carried out by authorized specialist personnel.

8.1 Hot-plug components

This section describes how to handle hot-plug components and how to modify your server hardware (e.g. adding/replacing hot-plug power supply units).

The hot-plug procedure increases the availability of system operation and guarantees a high degree of data integrity and failsafe performance.

8.1.1 Hot-plug power supply units

The server must have at least two hot-plug power supply units (PSUs) to ensure redundant power supply. If one power supply unit fails, the other unit ensures that the operation can continue uninterrupted. The defective power supply unit can be replaced during operation (hot-plug).



CAUTION!

- Areas around the power supply unit may remain extremely hot after shutdown. Wait for a while after shutdown before removing the power supply unit.
- When installing the power supply unit, be sure to confirm that the connector of the PSU is not damaged or bent.
- Do not insert your hands in the power supply unit slot when removing the power supply unit. Doing so may cause electric shock.
- If the power supply unit is hard to remove, do not pull out it by force.
- The power supply unit is heavy, so handle it carefully. If you drop it by mistake, injuries may result.

8.1.1.1 Replacing a hot-plug power supply unit



Figure 19: Unlocking and removing the power supply unit



CAUTION!

When replacing a non-defective hot-plug power supply unit in a **non-redundant configuration**, the server must be switched off first.

- ▶ Remove the power cord from the cable clamp. You can loosen the cable clamp by opening the small locking lever.
- ▶ Remove the power cord from the installed power supply unit.
- ▶ Press the green release lever (1) and pull out the power supply unit in the direction of the arrow (2). Grip the handle while pulling the power supply.



CAUTION!

Release your hands from lever (1) as soon as the power supply unit has been pulled out a few centimeters.

- ▶ Completely remove the defective power supply unit from the slot.



CAUTION!

Never leave the slot for the power supply unit empty for more than two minutes during operation. Otherwise, excessive temperatures could damage system components.

- ▶ Slide the new power supply unit into the empty slot until it clicks into place.



Make sure that the new power supply unit engages correctly in the mounting location and is locked in position. This is the only way to prevent the power supply unit from sliding out of its mountings and being damaged during transportation.

- ▶ Thread the cable through the cable clamp (see [figure 11 on page 60](#)).
- ▶ Pull the cable clamp tight to secure the power cord.
- ▶ Connect the newly installed power supply unit to the mains.

If everything is functioning correctly, the green LEDs 1 and 3 (see "[Indicators on the hot-plug power supply units](#)" on [page 73](#)) at the rear of the power supply unit will now light up.

8.1.1.2 Adding a hot-plug power supply unit



Figure 20: Removing a PSU dummy module

- ▶ Remove the PSU dummy module as follows:
 1. Press the two metal clips together (see arrows (1) in figure above).
 2. Pull the PSU dummy module out of its slot (see arrow (2) in figure above).
- ▶ Slide the new power supply unit into the empty slot until it clicks into place.



Make sure that the new power supply unit engages correctly in the mounting location and is locked in position. This is the only way to prevent the power supply unit from sliding out of its mountings and being damaged during transportation.

- ▶ Thread the cable through the cable clamp (see [figure 11 on page 60](#)).
- ▶ Pull the cable clamp tight to secure the power cord.
- ▶ Connect the newly installed power supply unit to the mains.

If everything is functioning correctly, the green LEDs 1 and 3 (see "[Indicators on the hot-plug power supply units](#)" on page 73) at the rear of the power supply unit will now light up.

8.1.2 Hot-plug fans

The server comes with four hot-plug fans (eight fans only in a redundant configuration). Each fan is mounted in a fan module that is accessible from the top when opening the server.

A possible fan failure is reported by the CSS indicator lighting up on the front and rear of the server as well as by the indicator on the fan module in question.

The fan failure is also displayed on the ServerView Local Service Display (see the "Customer Self Service (CSS)" manual on the ServerView Suite DVD 2).

Identifying the defective CSS component

- ▶ Open the server (see ["Opening/Closing the server" on page 134](#)).

The defective fan is identified from the indicator on each fan (see [figure 21 on page 97](#)).

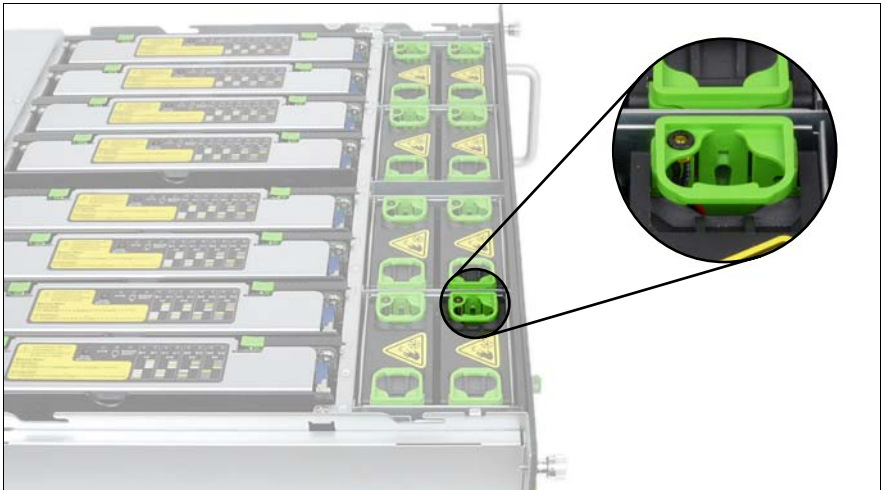

Figure 21: Indicator on a hot-plug fan

8.1.2.1 Replacing a defective fan

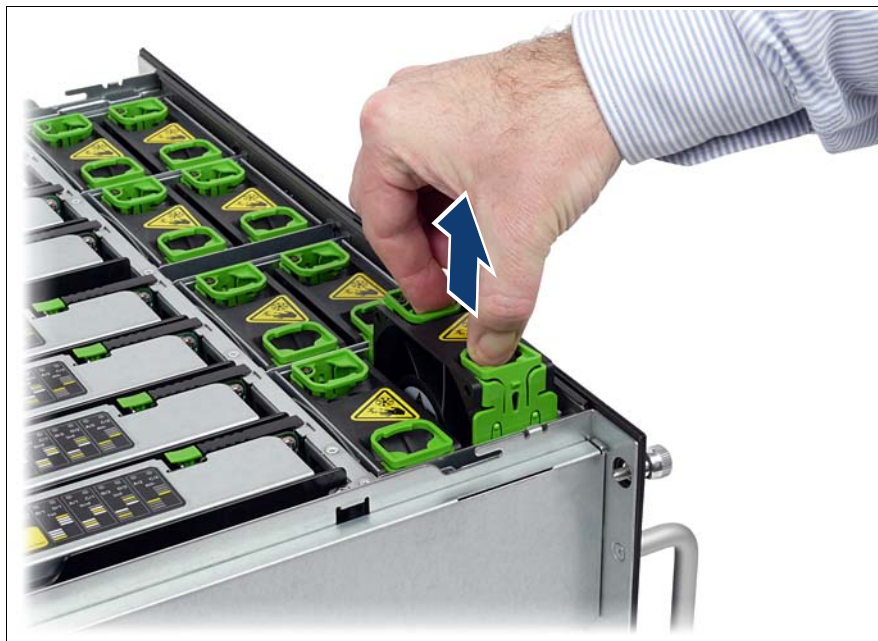

Figure 22: Unlocking a fan module and removing it

- ▶ Press the two green handles and lift the fan module out of the housing (see [figure 22](#)).



CAUTION!

Never leave the fan module slot empty for more than two minutes during operation. Otherwise, excessive temperatures could damage system components.

- ▶ Insert the new fan module in the empty slot until it clicks into place. To make sure the fan has engaged press again.

The new fan module is tested by Server Management. The LED then either does not light at all (fan is ok) or lights up (fan is not ok).

- ▶ Close the server (see "[Opening/Closing the server](#)" on page 134).

8.1.2.2 Adding new fans

- ▶ Open the server (see ["Opening/Closing the server" on page 134](#)).
- ▶ Insert the new fan modules in the empty slots until they engage. To make sure the fan has engaged press again.

The new fan module is tested by Server Management. The LED then either does not light at all (fan is OK) or lights up (fan is not ok).

- ▶ Close the server (see ["Opening/Closing the server" on page 134](#)).

8.1.3 Hot-plug HDD modules

The hard disk drives which can be ordered for the PRIMERGY RX600 S5 are supplied already mounted in an installation frame so that defective hard disk drives can be replaced and new hard disk drives can be added during operation. The hard disk drive and the installation frame together make up the HDD module.



CAUTION!

- The hard disk drive must not be removed from the installation frame by anyone except a service technician.
- The HDD modules (drives) must all be marked clearly so that they can be put back in their original places after an upgrade. If this is not done, existing data can be lost.
- The hot-plug function is only possible in conjunction with a corresponding RAID configuration.

Further information about the RAID configuration or RAID level can be found in the RAID controller documentation.

- Do not touch the circuitry on boards or soldered parts. Hold the metallic areas or the edges of the circuit boards.
- Before removing the unit, wait for about 30 seconds until the disk stops spinning completely.
- When the hard disk unit is starting up, you may hear a resonant noise for a while, but this does not mean a failure.
- Depending on the OS, you can configure the write cache settings for the hard disk drives. If a power failure should occur while the write cache is enabled, cached data may be lost.
- When disposing of, transferring, or returning a hard disk unit, wipe out the data on the drive for your own security.
- Rough handling of hard disk units can damage the stored data. To cope with any unexpected problems, always back up important data. When backing up data to another hard disk drive, you should make backups on a file or partition basis.
- Be careful not to hit the hard disk unit or bring it into contact with metallic objects.
- Use the device on a shock and vibration free surface.

- Do not use the unit in extremely hot or cold locations, or locations with extreme temperature changes.
- Never attempt to disassemble the hard disk unit.

Handling drives and HDD/SSD modules

Drives incorporated in the HDD/SSD modules are highly sensitive electromagnetic devices and must be handled with great care. Incorrect handling can cause partial or total failure of the drives. These failures can result in data errors and to a loss of data or to total corruption of the drive.

Observe the following rules to prevent such problems occurring:

- Only store and transport HDD/SSD modules within the limits stipulated in the specification.
- When transporting HDD/SSD modules (even over short distances), always use the original packaging (ESD label).
- Never expose HDD/SSD modules to a temperature shock. Avoid the formation of condensation inside and on the outside of the drive.



CAUTION!

The HDD/SSD module must be acclimatized in its operating environment for an acclimatization time before it is started up for the first time.

Temperature difference (°C) (operating environment/ outside)	Minimum acclimatization time (hours)
5	3
10	5
15	7
20	8
25	9
30	10

Table 5: Acclimatization times for HDD/SSD modules

- Always set the HDD/SSD module down carefully, with the large surface facing downwards to prevent it from tipping over.

8.1.3.1 HDD/SSD module and dummy module

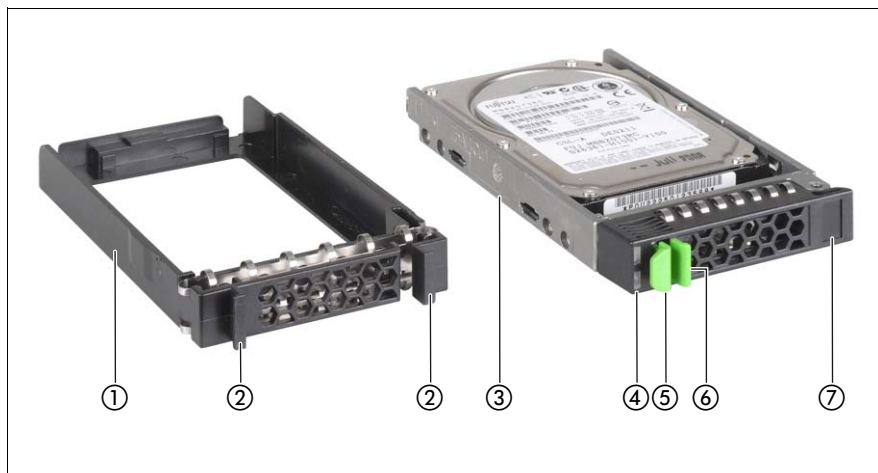

Figure 23: 2.5-inch HDD module and dummy module

1	Dummy module
2	Tabs for unlocking the dummy module
3	HDD module (installation frame with hard disk drive installed)
4	Indicators HDD Busy (LED green) HDD Fault (LED orange) For description see section "Indicators on the hot-plug HDD modules" on page 68.
5	Handle for locking and unlocking the HDD module
6	Button for locking and unlocking the handle
7	Ridge for applying a sticker with the current drive name and drive size

8.1.3.2 Removing/installing the dummy module

Free slots are provided with dummy modules. Remove the dummy module before installing an additional HDD module.

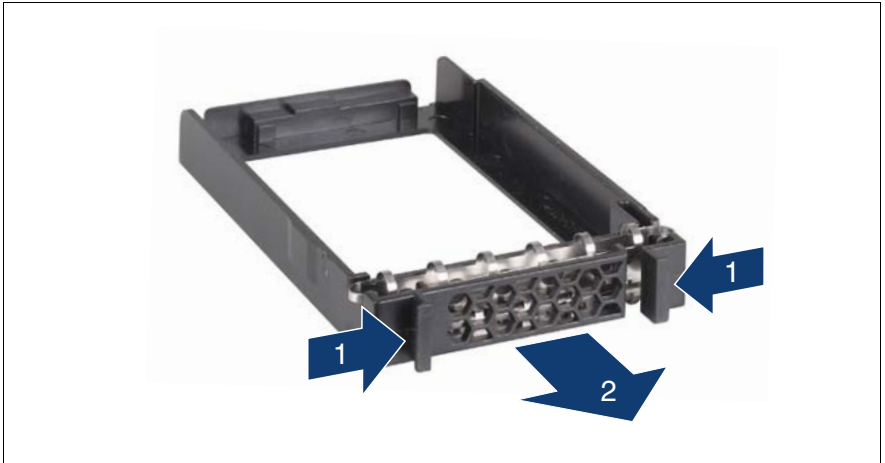

Figure 24: Removing/installing the 2.5-inch dummy module

- ▶ Press both tabs on the dummy module together until the locking mechanism disengages (1).
- ▶ Pull the dummy module out of the bay (2).

To install a dummy module, follow the same procedure in reverse order.



CAUTION!

Store the dummy module in a safe place. If you have removed an HDD module and do not install a new one in its place, put the dummy module back in its place for cooling, to comply with EMC regulations (regulations regarding electromagnetic compatibility), and for protection against fire. Ensure that the dummy module engages correctly in the bay.

8.1.3.3 Installing the HDD module

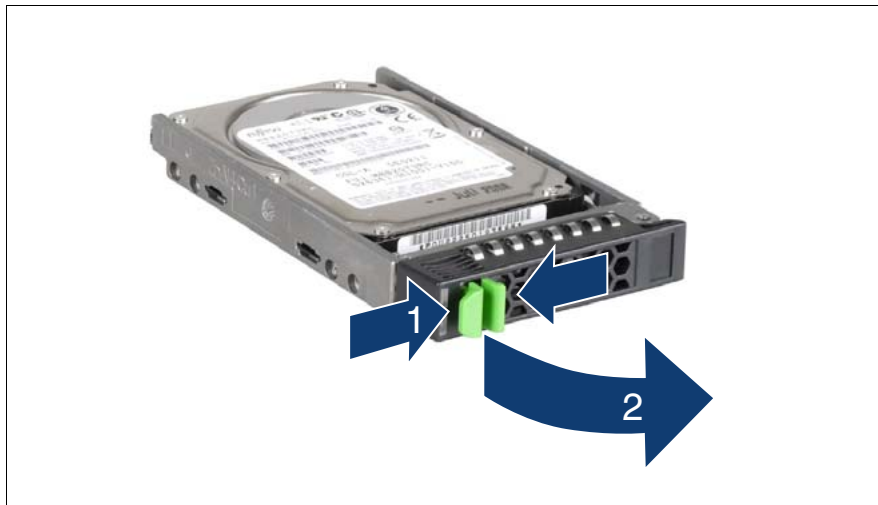

Figure 25: Unlocking the 2.5-inch HDD module

- ▶ Release the locking mechanism as follows:
 1. Press the two green tabs of the locking lever together (1).
 2. Push the handle of the HDD module fully in the direction of the arrow (2). The HDD module is now unlocked.



Figure 26: Installing the 2.5-inch HDD module

- ▶ Carefully push the HDD module into the empty slot (1) until it stops.
- ▶ Push the handle completely (2) in the direction of the arrow until the locking mechanism engages.

8.1.3.4 Removing the HDD module



CAUTION!

- Only remove an HDD module during operation if the drive is not currently being accessed. Observe the control LEDs for the corresponding HDD modules (see "[Indicators on the hot-plug HDD modules](#)" on page 68).
- Under no circumstances should you remove an HDD module while the system is in operation if you are not sure that the hard disk drive is operated by a RAID controller and belongs to a disk array that is operating in RAID level 1, 1E, 10, 5, 50, 6 or 60.

An HDD module can only be replaced during operation in conjunction with a corresponding RAID configuration.

- All HDD modules (drives) must be uniquely identified so that they can be reinstalled in their original mounting locations later. If this is not done, existing data can be lost.

If you want to remove an HDD module during operation, proceed as follows:

- ▶ If you want to remove an HDD module that is not defective, the drive must be first set to "Offline" via the software (RAID controller configuration software).
- ▶ Unlock the HDD module as described in section ["Installing the HDD module" on page 104](#).
- ▶ Pull the HDD module out a few centimeters.
- ▶ Wait for at least 60 seconds.



This period is necessary for the RAID controller to recognize that an HDD module has been removed and for the hard disk drive to come to a stop.

- ▶ Pull the HDD module out completely.
- ▶ Install the new HDD module, as described in ["Installing the HDD module" on page 104](#).

**CAUTION!**

If you have removed an HDD module and do not install a new one in its place, put the dummy module back in its place for cooling, to comply with EMC regulations (regulations regarding electromagnetic compatibility), and for protection against fire. Ensure that the dummy module engages correctly in the bay.

8.1.4 Hot-plug expansion cards



CAUTION!

- The actions described in this section may only be performed by personnel with the appropriate technical training. (The device can be seriously damaged if it is opened without authorization or if repairs are attempted by untrained personnel.)
- Each slot in the server must have either an expansion card or a dummy module. A dummy module comprises a retaining plate with an attached removal tool.
- Please observe the safety information in [chapter "Important information" on page 27](#).

The following operations are possible during operation:

- Replacement of expansion cards (see ["Removing a hot-plug expansion card" on page 109](#) and ["Installing a hot-plug expansion card" on page 113](#))



Only expansion cards of the same type and with the same settings may be exchanged. If the expansion cards do not match, the new expansion card will not be commissioned.

- Adding more expansion cards (see ["Removing a dummy module" on page 112](#) and ["Installing a hot-plug expansion card" on page 113](#))
- ▶ You should read the accompanying documentation supplied with the expansion card beforehand.

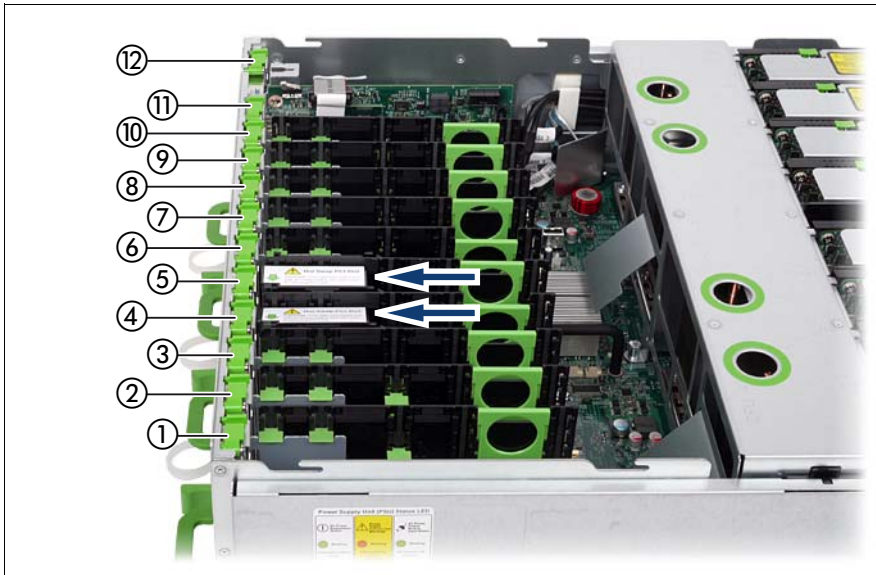

Figure 27: PCI slots with and without hot-plug functionality

Item	Slot #	Description
1	10	PCIe slot 10
2	9	PCIe slot 9
3	8	PCIe slot 8
4	7	PCIe slot 7, hot-plug
5	6	PCIe slot 6, hot-plug
6	5	PCIe slot 5
7	4	PCIe slot 4
8	3	PCIe slot 3
9	2	PCIe slot 2
10	1	PCIe slot 1
11	./.	Dedicated slot for I/O riser board
12	./.	Dedicated slot for SAS controller card



Only slots 6 and 7 are hot-plug slots. These slots are marked with a hot-plug label (see arrows in [figure 27](#)).

8.1.4.1 Identifying the defective CSS component

- ▶ Open the server (see ["Opening/Closing the server" on page 134](#)).
- ▶ Press the Indicate CSS button on the system board (see Technical Manual for the system board D2870 on the ServerView Suite DVD 2).

The PRIMERGY Diagnostic LED of the defective CSS component lights up orange, thereby indicating which CSS component on the system board must be replaced (see Technical Manual for details).

8.1.4.2 Removing a hot-plug expansion card

- ▶ If required by the operating system, start the PCI hot-plug software. You will find information about this in the readme file on the ServerView Suite DVD 2).

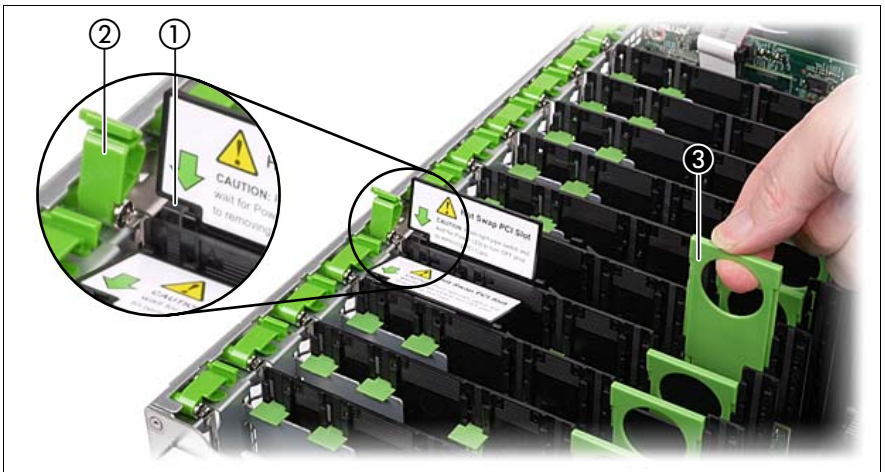

Figure 28: Deactivating, unlocking and removing the board

- ▶ Deactivate the expansion card using either the relevant PCI hot-plug software or by pressing the light-pipe switch (1).
- ▶ Wait until the light-pipe switch (1) no longer lights up.
The slot is now zero potential.
- ▶ If necessary, remove all cables from the expansion card.
- ▶ Open the expansion card lock by lifting it up (2).

The expansion card is now mechanically unlocked.

- ▶ Hold the removal tool by the green handle and pull it out of the PCI slot together with the expansion card (3).



Do not pull on the expansion card itself.

Removing an expansion card from the removal tool



CAUTION!

When removing the expansion card from the removal tool, pay particular attention to the engaging hooks that fasten the board to the removal tool (see arrows in [figure 29](#)). Do not lift them by more than approx. 1 mm, in other words only as far until the expansion card is released. Otherwise you could damage the engaging hooks.

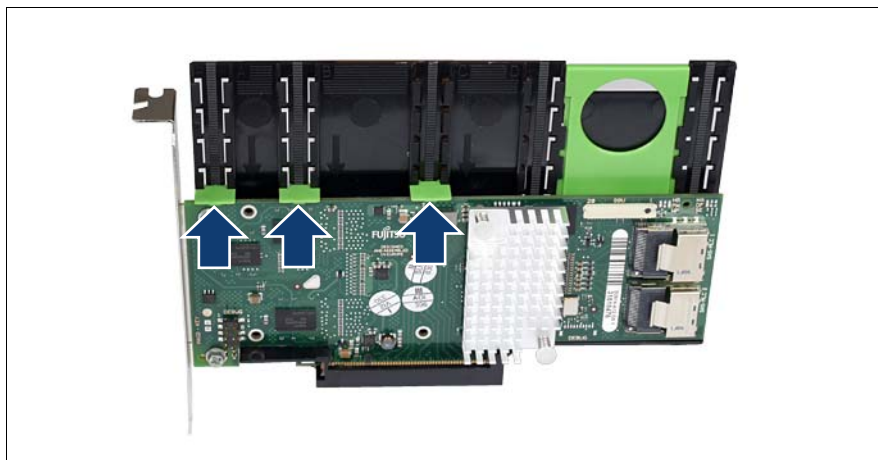

Figure 29: Removing the expansion card from the removal tool

- ▶ Lift the green movable engaging hooks (see arrows in figure above) **no more than approx. 1 mm** until the expansion card is completely released.
- ▶ Take the expansion card out and put it aside.

Removing engaging hooks



Figure 30: Removing engaging hooks from the removal tool

- ▶ Push the green engaging hooks down in the direction of the arrows (1) until they disengage from the removal tool.
- ▶ Remove the engaging hooks (2) and keep them in a safe place.
- ▶ To insert a new expansion card, continue with section "[Installing a hot-plug expansion card](#)" on page 113.



CAUTION!

If you remove an expansion card and do not insert a replacement, you will have to use a dummy module for better cooling, to comply with applicable EMC regulations (regulations on electromagnetic compatibility) and to protect against fire. Ensure that the dummy module engages correctly in the slot.

8.1.4.3 Removing a dummy module

If a slot does not contain an expansion card, it is occupied by a dummy module. This is a retaining plate with an attached removal tool.

Before inserting an additional hot-plug expansion card, you will first have to remove the dummy module from its slot.

- ▶ Open the server (see ["Opening/Closing the server" on page 134](#)).
- ▶ Remove the dummy module in the same way as a PCI board (see [figure 29 on page 110](#)).

Removing the retaining plate from the removal tool



CAUTION!

When removing the retaining plate from the removal tool, pay particular attention to the engaging hooks that fasten it to the removal tool. Never lift the engaging hooks by more than approx. 1 mm, in other words only as far until the retaining plate is released. Otherwise you could damage the engaging hooks.

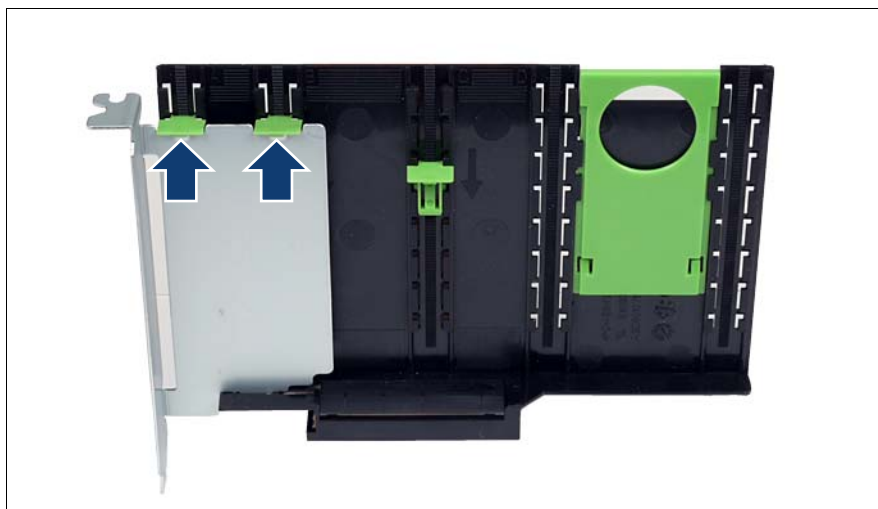

Figure 31: Removing the retaining plate from the removal tool

- ▶ Lift the green engaging hooks (see arrows) **no more than approx. 1 mm** until the retaining plate is released.

- ▶ Take the retaining plate out and put it aside.



Keep the retaining plate for future use.

- ▶ Push the engaging hooks down until they disengage from the removal tool (see [figure 30 on page 111](#)), and keep them in a safe place.

8.1.4.4 Installing a hot-plug expansion card

Inserting an expansion card in the removal tool



Figure 32: Inserting the new expansion card in the removal tool

- ▶ Insert the new expansion card in the provided slot (see oval in figure above) of the removal tool.
- ▶ Insert the green engaging hooks (see circles in [figure 32 on page 113](#)) in the rods and push them down until they engage in the upper edge of the expansion card.



CAUTION!

Make sure that e.g. the ports on the expansion card are not blocked by the engaging hooks.

Operating the expansion card

- ▶ Insert the expansion card fastened to the removal tool in the PCI slot.
- ▶ Close the slot lock (see pos. #2 in [figure 28 on page 109](#)) by folding it down. Make sure that the slot lock engages.
- ▶ If necessary, connect the cables on the expansion card.
- ▶ Activate the expansion card using either the relevant PCI hot-plug software or by pressing the light-pipe switch (see pos. #1 in [figure 28 on page 109](#)).

The light-pipe switch flashes green. The slot is in the enable sequence.

- ▶ Wait until the light-pipe switch is constantly green.

The slot is now powered on.



If the light-pipe switch continues to flash, an error has occurred.

Remove the expansion card and repeat the procedure as described above.

- ▶ Close the server (see ["Opening/Closing the server" on page 134](#)).

8.1.5 Hot-plug memory boards



CAUTION!

- The actions described in this section may only be performed by personnel with the appropriate technical training. (The device can be seriously damaged if it is opened without authorization or if repairs are attempted by untrained personnel.)
- Please observe the safety information in [chapter "Important information" on page 27](#).

The system board has space for up to eight memory boards, each of which can be equipped with up to eight memory modules. The slots for the main memory are suitable for 2 GB, 4 GB, 8 GB and 16 GB DDR3 1066/1333 MHz memory modules. This allows a maximum memory capacity of 1024 GB (with availability of 16 GB memory modules).

A possible memory module fault is reported by the CSS indicator lighting up on the front and rear of the server or displayed on the ServerView Local Service Display (for more information about the behavior of the Local Service Display, see chapter ["Starting up and operation" on page 63](#) and the "Customer Self Service (CSS)" manual on the ServerView Suite DVD 2).

8.1.5.1 Identifying the defective memory

The faulty memory module can be identified from the corresponding DIMM Fault LED on the respective memory board (see [figure 33](#)) when the server is open.

- ▶ Open the server (see ["Opening the server" on page 134](#)).

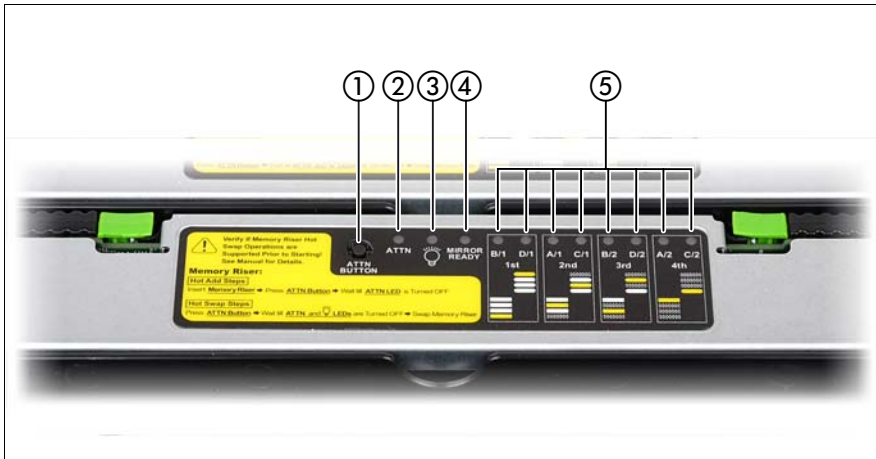

Figure 33: Button and indicators on memory board

1	ATTN button	4	Mirror LED (green)
2	ATTN LED (orange)	5	8x DIMM Fault LED (orange)
3	Power LED (green)		

- ▶ Use the DIMM Fault LEDs (5) to identify the faulty memory module.

The respective DIMM Fault LED lights up orange and indicates the slot on the memory board that is occupied by the faulty memory module.
- ▶ Make a note of which LED (e.g. "1B") on which memory board is lit orange.
- ▶ Press the ATTN button (1) .
- ▶ Wait until ATTN LED (2) and Power LED (3) are turned off.
- ▶ Remove the memory board as described in ["Removing the memory board in question" on page 117](#)

8.1.5.2 Removing the memory board in question

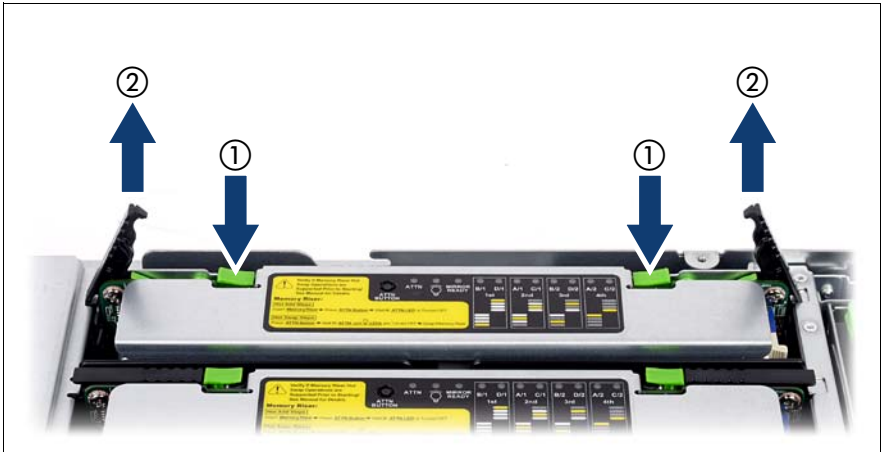

Figure 34: Example: Removing memory board

- ▶ Unlock the memory board in question by pressing the green locks (1). The levers on both sides will be released.
- ▶ Swivel the levers in an upright position and lift the memory board up and out using its levers simultaneously (2).

8.1.5.3 Removing a defective memory module



CAUTION!

- Please note the equipping rules in the Technical Manual for the system board D2870.
- To avoid burning your fingers, wait for a sufficient period of time before installing or removing memory modules.
- Do not install unauthorized third party memory modules. Doing so may cause electric shock, a fire, or failures.
- Do not insert and remove memory modules repeatedly. Doing so may cause failures.
- If the memory module has not been correctly inserted, it may cause a fire. Insert the memory module with attention to its direction.

- If a memory module is installed and you pull the lever strongly outwards, the memory module pops up. Doing so may cause a device failure.
- Please observe the safety information in [chapter "Important information" on page 27](#).

i To guarantee that all memory modules in the relevant storage mode have identical characteristics, you must **always replace 4 memory modules** on each memory board. The only **exception** is memory boards running in **spare mode** or in **independent mode** - these only require 2 memory modules to be replaced.

For more information on the individual storage modes, see the Technical Manual "System Board D2870 for PRIMERGY RX600 S5".

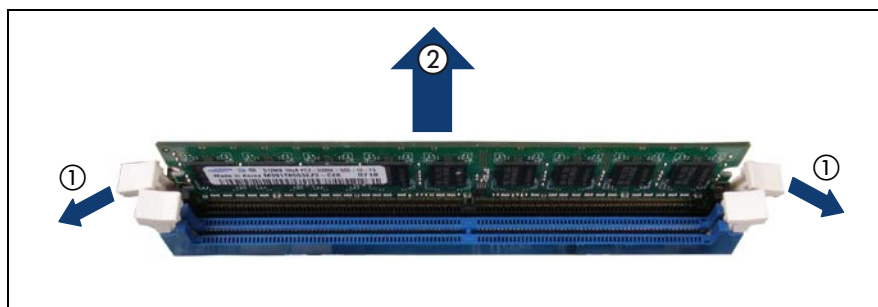

Figure 35: Removing a memory module

- ▶ Press the holders on either side of the memory slot concerned outward (1).
- ▶ Pull the defective memory module out of the slot (2).

8.1.5.4 Installing a new memory module

**CAUTION!**

Observe the safety information concerning memory modules in [section "Removing a defective memory module"](#) on page 117.

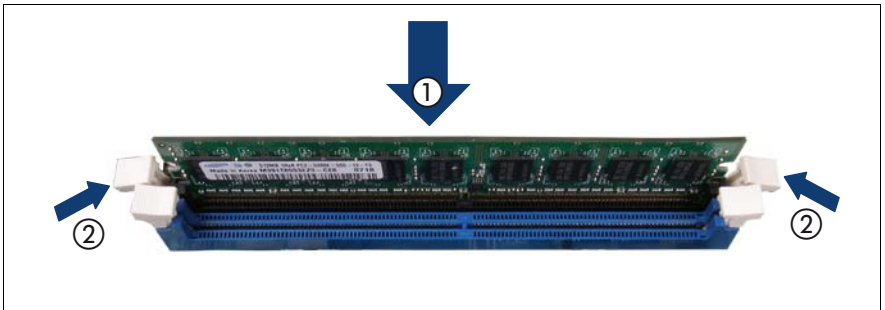

Figure 36: Installing a memory module

- ▶ Carefully press the memory module into the slot (1) until the fastening tabs on both sides of it engage (2).

8.1.5.5 Reinstalling the memory board in question



Figure 37: Installing a memory board

- ▶ Slide the memory board down (1) in the lateral guide channels until it stops. Swivel the levers in the direction of the arrows (2).
- ▶ Make sure that the green locks on the top engage.

- ▶ Press the ATTN button.
- ▶ Wait until the ATTN LED is turned off.
- ▶ Close the server as described in ["Closing the server" on page 136](#).

8.1.5.6 Adding a memory board

To add memory boards during operation, proceed as follows:

- ▶ Open the server (see ["Opening the server" on page 134](#)).
- ▶ Remove the air baffle of the respective memory board slot.

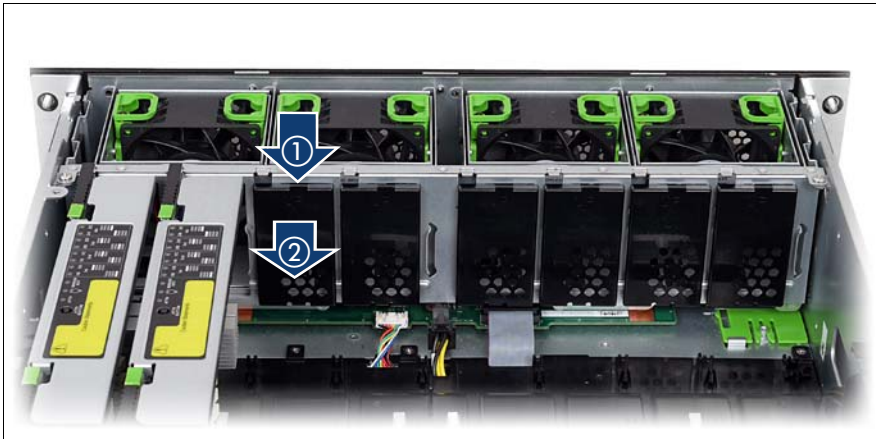

Figure 38: Removing the memory air baffle to add a memory board

- ▶ Press on the top of the memory air baffle (1), move it in the direction of the arrow (2) and out of the housing.



Keep the memory air baffle for future use.

- ▶ Install the equipped memory board into the respective slot.



Memory boards that you insert must suit the fitting rules and the appropriate configuration. See the Technical Manual for details.

- ▶ Press the ATTN button.
- ▶ Wait until the ATTN LED is turned off.
- ▶ Close the server as described in ["Closing the server" on page 136](#).

8.2 Non-hot-plug components



CAUTION!

- The actions described in this section may only be performed by personnel with the appropriate technical training. (The device can be seriously damaged if it is opened without authorization or if repairs are attempted by untrained personnel.)
- The circuit boards and soldered parts of internal options are exposed and can be damaged by static electricity. Before handling them, first touch a metal part on the server to discharge static electricity from your body.
- Do not touch the circuitry on boards and soldered parts. Hold the metallic areas or the edge of the circuit boards.
- Touch only the specified part of the printed circuit board. Failure to do so may cause injury. It may also cause failures.
- Please observe the safety information in [chapter "Important information" on page 27](#).

If a defective non-hot-plug component is detected (for more information, see chapter "[Starting up and operation" on page 63](#) and the "ServerView Suite Local Service Concept - LSC" manual on the ServerView Suite DVD 2), proceed as follows:

- ▶ Exit all applications and shut down the server properly (see section "[Switching the server on and off" on page 75](#)").
- ▶ Pull all power connectors out of the power outlets.
- ▶ Remove the server from the rack (see section "[Rack installation/removal of server" on page 43](#)") and place the server on a table, for example.

8.2.1 Identifying the defective CSS component

- ▶ Open the server (see ["Opening/Closing the server" on page 134](#)).
- ▶ Press the Indicate CSS button on the system board (see Technical Manual for the system board D2870 on the ServerView Suite DVD 2).

The PRIMERGY Diagnostic LED of the defective CSS component lights up orange, thereby indicating which CSS component on the system board must be replaced (see Technical Manual for details).

8.2.2 Replacing a non-hot-plug expansion card

8.2.2.1 Removing a non-hot-plug expansion card

- ▶ If necessary, remove all cables from the expansion card.
- ▶ Open the expansion card lock by lifting it up (see pos. #2 in [figure 28 on page 109](#)).

The expansion card is now mechanically unlocked.

- ▶ Hold the removal tool by the green handle and pull it out of the PCI slot together with the expansion card (see pos. #3 in [figure 28 on page 109](#)).



Do not pull on the expansion card itself.

Removing an expansion card from the removal tool



CAUTION!

When removing the expansion card from the removal tool, pay particular attention to the engaging hooks that fasten the board to the removal tool (see [figure 39](#)). Do not lift them by more than approx. 1 mm, in other words only as far until the expansion card is released. Otherwise you could damage the engaging hooks.

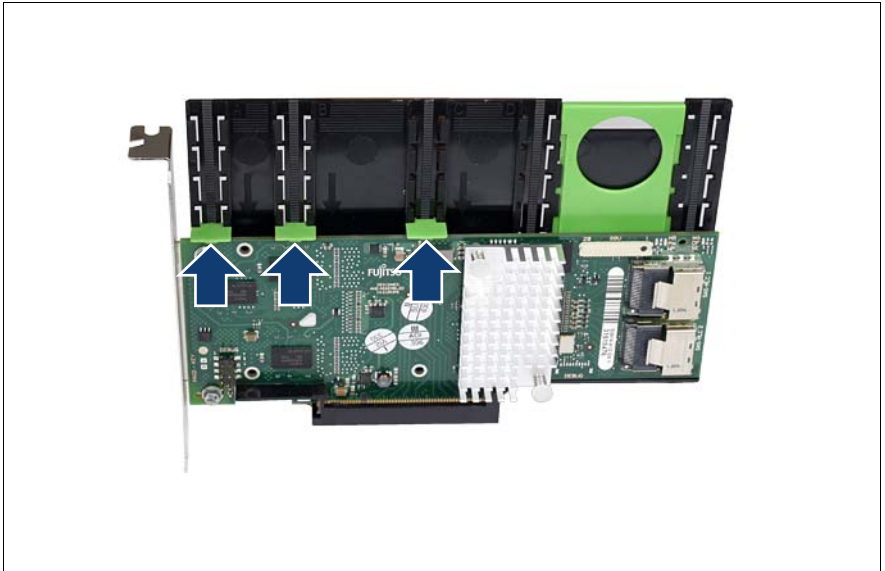

Figure 39: Removing the expansion card from the removal tool

- ▶ Lift the green movable engaging hooks (see arrow in figure above) **no more than approximately 1 mm** until the expansion card is completely released.
- ▶ Take the expansion card out and put it aside.

Removing engaging hooks

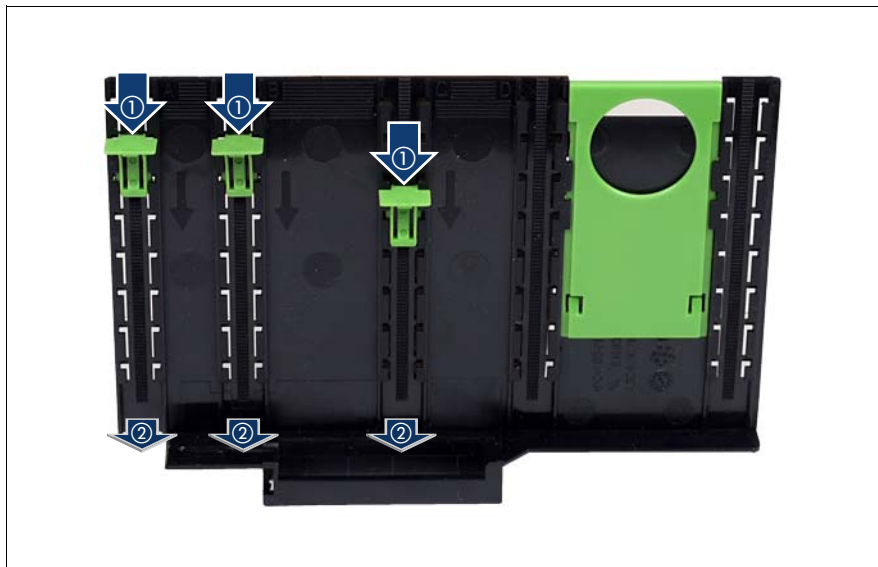

Figure 40: Removing engaging hooks from the removal tool

- ▶ Push the green engaging hooks down in the direction of the arrow (1) until they disengage from the removal tool.
- ▶ Remove the engaging hooks (2) and keep them in a safe place.
- ▶ To insert a new expansion card, continue with section ["Installing a hot-plug expansion card" on page 113](#).

**CAUTION!**

If you remove an expansion card and do not insert a replacement, you will have to use a dummy module for better cooling, to comply with applicable EMC regulations (regulations on electromagnetic compatibility) and to protect against fire. Ensure that the dummy module engages correctly in the slot.

8.2.2.2 Installing a non-hot-plug expansion card



Figure 41: Inserting the new expansion card in the removal tool

- ▶ Insert the new expansion card in the provided slot (see oval in figure above) of the removal tool.
- ▶ Insert the green engaging hooks (see circles in figure above) in the rods and push them down until they engage in the upper edge of the expansion card.



CAUTION!

Make sure that the ports on the expansion card are not blocked by the engaging hooks.

- ▶ Insert the expansion card fastened to the removal tool in the PCI slot.
- ▶ Close the slot lock (see [figure 28 on page 109](#)) by folding it down. Make sure that the slot lock engages.
- ▶ If necessary, connect the cables on the expansion card.
- ▶ Close the server (see "[Opening/Closing the server](#)" on [page 134](#)).

8.2.3 Replacing SFP+ transceiver modules

For Fiber Channel over Ethernet (FCoE) configurations, the ethernet server adapter is equipped with one or two SFP+ (small form-factor pluggable) transceiver modules.

In order to remove, install or replace an SFP+ transceiver module, please proceed as follows.

8.2.3.1 Removing an SFP+ transceiver module

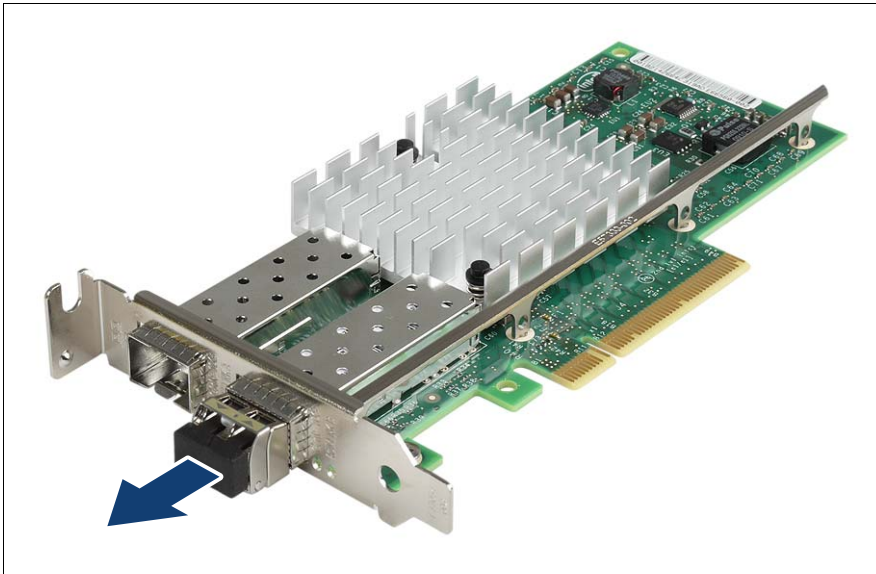

Figure 42: Removing the protective optical port plug

- ▶ If present, remove the protective optical port plug from the SFP+ transceiver module.



CAUTION!

Save the protective port plug for future use.

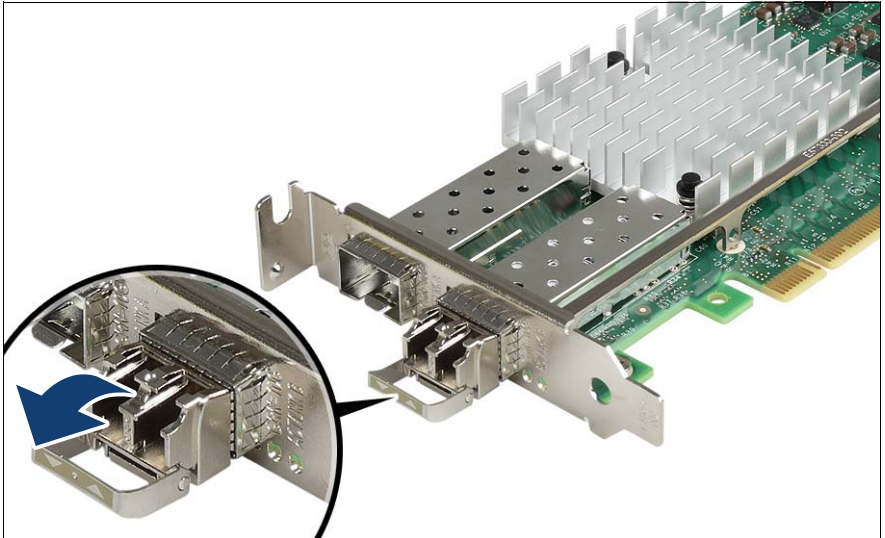

Figure 43: Unlatching the locking bail

- ▶ Carefully unlatch and fold down the locking bail on the SFP+ transceiver module to eject the transceiver from the socket connector.

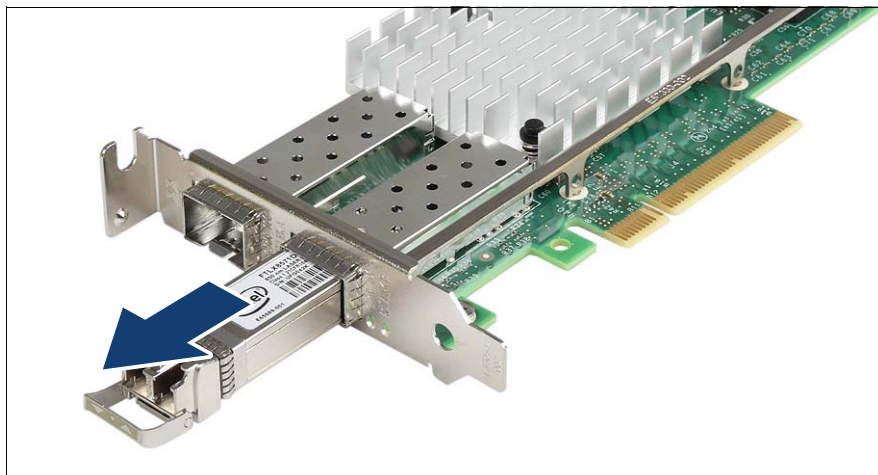

Figure 44: Removing the SFP+ transceiver

- ▶ Pull the SFP+ transceiver module out of its socket connector.
 - ▶ Reattach the protective optical port plug to the transceiver optical bores.
- i** Place the removed SFP+ transceiver module in an antistatic bag or other protective environment.

8.2.3.2 Installing SFP+ transceiver modules



Figure 45: Removing the protective optical port plug

- ▶ Remove the SFP+ transceiver module from its protective packaging.
- ▶ Remove the optical port plug from the new / additional SFP+ transceiver module.



CAUTION!

- Always keep the protective port plugs attached to the transceiver optical bores and fiber-optic cable connectors until you are ready to make a connection.
- Save the protective port plug for future use.



Figure 46: Unlatching the locking bail

- ▶ Carefully unlatch and fold down the locking bail on the SFP+ transceiver module.

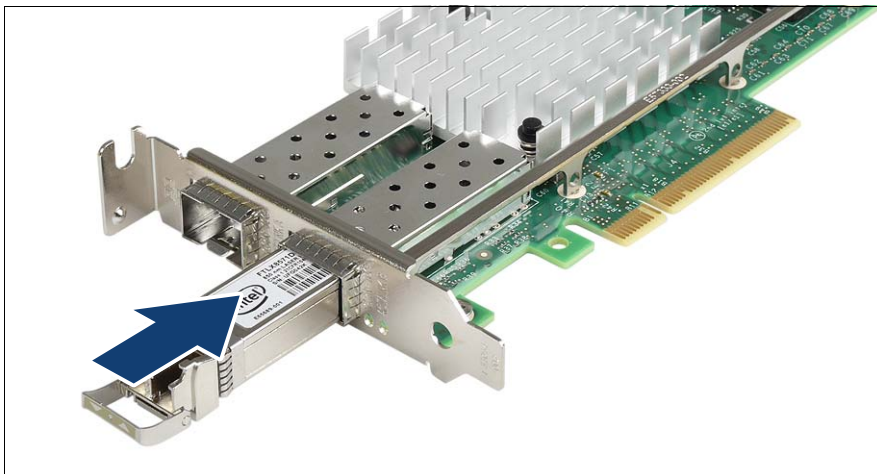

Figure 47: Inserting the SFP+ transceiver

- ▶ Insert and slide the SFP+ transceiver module into the socket connector as far as it will go.



If only one slot is equipped with a SFP+ transceiver module, use the primary right connector as shown.

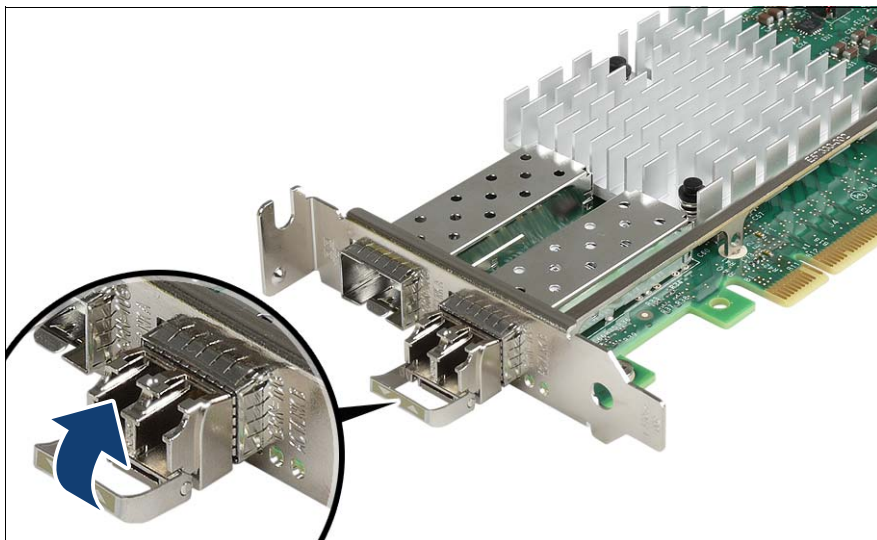

Figure 48: Latching the locking bail

- ▶ Carefully fold up and latch the locking bail.

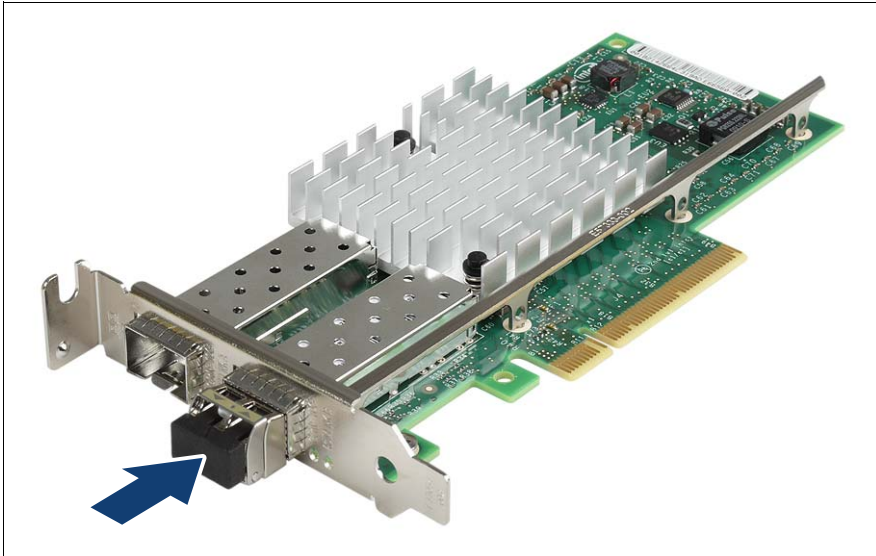

Figure 49: Attaching the protective optical port plug

- ▶ If the SFP+ transceiver module is not immediately connected to an LC connector, attach the protective optical port plug to the transceiver optical bores.

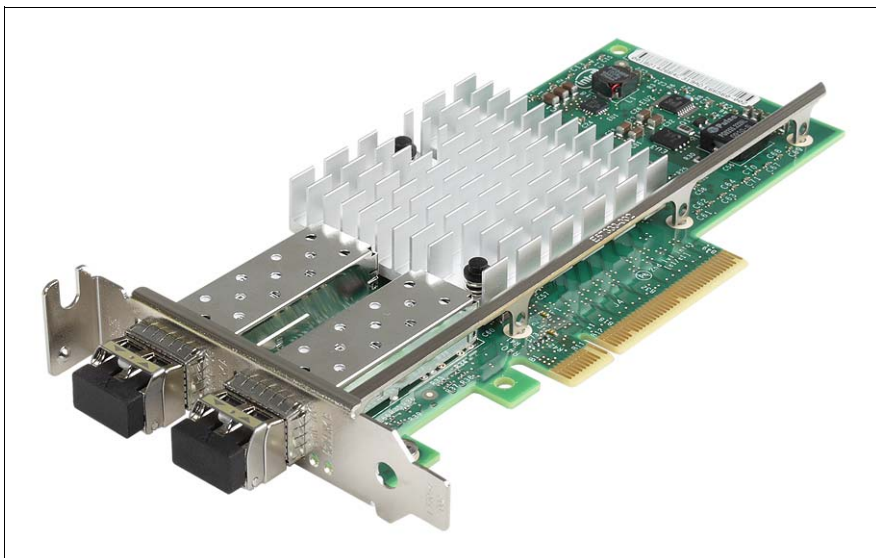

Figure 50: Installing the secondary SFP+ transceiver module

- ▶ If applicable, install the secondary SFP+ transceiver module accordingly.

8.3 Opening/Closing the server



CAUTION!

The actions described in this section may only be performed by personnel with the appropriate technical training. (The device can be seriously damaged if it is opened without authorization or if repairs are attempted by untrained personnel.)

8.3.1 Opening the server



CAUTION!

- The server can be seriously damaged if it is opened without authorization or if repairs are attempted by untrained personnel.
- It is essential to observe the safety instructions in chapter ["Important information" on page 27](#).
- Before removing or attaching covers, turn off the server, all peripheral devices, and any other connected devices. Also unplug all power cords from the outlet. Failure to do so can cause electric shock.
- The housing cover must be replaced as soon as possible for purposes of cooling, to comply with EMC regulations (regulations regarding electromagnetic compatibility) and to prevent fires. The housing cover must not remain open for longer than 5 minutes.
- Use the anti-tilt plate to prevent the rack from tipping when installing the rack. Pulling the server out of the rack without having installed the anti-tilt plate may cause the rack to tip over.
- Be careful not to pinch fingers or clothes when sliding out the server or pushing it back. Failure to do so may cause injury.



Figure 51: Opening the server

- ▶ Loosen the little screw (see circle in figure above) and put it on a safe place.
- ▶ Push the two green touchpoints on the cover and move the cover for approximately 2 cm backwards.
- ▶ Lift the cover upwards.

8.3.2 Closing the server

**CAUTION!**

The housing cover must be replaced as soon as possible for purposes of cooling, to comply with EMC regulations (regulations regarding electromagnetic compatibility) and to prevent fires.



Figure 52: Placing the housing cover

- Place the housing cover onto the server such that it projects approx. 2 cm at the back (see circle in figure above).
- Push the housing cover as far as possible in the direction of the arrow.
- Fasten the little screw (see circle in [figure 51](#)) on the cover.

9 Appendix: server specification

This section explains the specifications for the server. The specifications for this server are liable to be updated without any notice. Please be forewarned.

System Board

System board type	D2870
Chipset	Intel Xeon 7500 Platform

Processor

Processor quantity and type	2-4 x Intel Xeon processor 7500 series
Processor notes	A minimum of 2 processors must be configured, no mix of different processor types

Memory Modules Configuration

Memory slots	64 (distributed on 8 memory boards with 8 slots each)
Memory slot type	DIMM (DDR3) registered
Memory capacity (min. - max.)	8 GB - 1024 GB
Memory protection	Advanced ECC, Memory scrubbing, SDDC, Memory mirroring support, Hot-spare memory support
Memory notes	Memory modules are installed on memory boards (8 DIMM slots per memory board). Two memory boards are preinstalled in base unit, further memory boards as option
Memory module notes	Memory modules will be delivered in sets of 4 DIMMs per order code. Intel 7500 Scalable Memory Buffer supports max. 1066 MHz memory clock speed. 1TB memory capacity will be possible with availability of 16 GB DIMM modules.

Interfaces

USB connectors	6 x USB 2.0 (3x front, 2x rear, 1x internal)
Graphics (15-pin)	2 x VGA (1x front, 1x rear)
Serial (9-pin)	2 x serial RS-232-C
LAN / Ethernet (RJ-45)	4 x Gbit/s Ethernet
Service LAN (RJ45)	1 x dedicated service LAN port for iRMC S2 (10/100 Mbit/s) Service LAN traffic can be switched to shared onboard Gbit LAN port

Onboard or integrated controllers

RAID Controller	8 port RAID 0/1 or RAID 5/6 controller as option
Remote Management Controller	Integrated Remote Management Controller (iRMC S2, 32 MB attached memory incl. graphics controller), IPMI 2.0 compatible
Trusted Platform Module (TPM)	Infineon / separate module; TCG V1.2 compliant (option)

Slots

PCI-Express Gen2 x4 (mech. x8)	3 x full height (2 x 1/2 length, 1 x 3/4 length)
PCI-Express Gen2 x8	4 x full height (all 3/4 length)
PCI-Express Gen2 x16	1 x full height (3/4 length)
PCI-Express x4 (mech. x8)	2 x half height (all 1/2 length)

Drive bays

Hard disk bay configuration	8 x 2.5-inch hot-plug SAS
Accessible drive bays	1 x 5.25/0.5-inch for CD-RW/DVD 1 x 5.25/1.6-inch for backup devices
Notes accessible drives	all possible options described in relevant system configurator

General system information

Number of fans	8
Fan configuration	hot-plug
Fan notes	Different base units available: with 4 fans (non redundant) or 8 fans (redundant)

Operating Panel

Operating buttons	On/off switch
	NMI button
	Reset button
	ID button
Status LEDs	System status (amber / yellow)
	Identification (blue)
	Hard disks access (green)
	Power (amber / green)
	At system rear side:
	System status (amber / yellow)
	Identification (blue)
Service display (optional):	ServerView Local Service Display (LSD)

Dimensions / Weight

Weight	up to 46 kg
Weight notes	Weight may vary depending on actual configuration
Rack mounting kit	Rack mounting kit as option (standard for the Japanese market)

Dimensions (Base unit specific)

Rack (W x D x H)	482.6 mm (Bezel) / 445 mm (Body) x 770 x 176 mm
Mounting Depth Rack	728 mm
Height Unit Rack	4 U
19" rackmount	Yes
Mounting cable depth rack	100 mm (1000 mm rack recommended)

Environmental

Noise emission	Measured according to ISO 7779 and declared according to ISO9296		
Sound pressure (LpAm)	46 dB(A) (idle) / 51 dB(A) (operating)		
Sound power (LWAd; 1B = 10dB)	6.2 B (idle) / 6.6 B (operating)		
Noise notes / description	at ambient temperature < 23°C		
Operating ambient temperature	10 - 35°C		
Operating relative humidity	10 - 85 % (non condensing)		
Exhaust air volume	Ambient temp.	m ³ /h	m ³ /min
	<25°C	49	0.82
	30°C	87	1.45
	35°C	126	2.1

Electrical values

Power supply configuration	Up to 4 hot-plug power supplies Base unit equipped with 2 power supplies; redundancy as option
Max. output of single power supply	850 W
Hot-plug power supply redundancy	Yes
Rated voltage range	100 - 127 V / 200 - 240 V
Rated frequency range	50 - 60 Hz
Active power min. (typical config)	750 W
Active power max. (typical config)	1950 W
Rated active power max.	3360 W (14 A x 240 V)
Apparent power max. (per system unit)	1990 VA
Heat emission	7020.0 kJ/h = 6653.7 BTU/h

Index

3rd party rack
installing in 51
requirements 44

A

accessible drives
DVD 15, 67
magnetic tape 15
acclimatization time 41, 101
Advanced Video Redirection 18
ambient conditions 24
ASR&R 17
automatic server reconfiguration &
restart 17
AVR 18

B

batteries 31
BIOS
security functions 83
update 20

C

cables
connecting 61
disconnecting 61
CE marking 23, 35
chipkill 16
Class A Compliance Statement 36
cleaning
keyboard 81
monitor 81
mouse 81
server 81
connecting
devices 53
monitor 54
connecting cables 61
connection panel 53
connectors

LAN 54
serial COM1 54
USB 54, 63
video 63
consumables 39
controls
ID button 64
on/off button 64
reset button 64
cooling 16
correcting faults 85
CSS indicator 64, 66, 69

D

data protection 83
data security 16
DataCenter rack
installing server 46
requirements 43
date, incorrect 88
delivery note 42
dimensions 24
disconnecting cables 61
disposal, devices 40
drive
“dead” 88
defective 89
drive module
acclimatization time 101
dummy module
expansion card 111, 124
PCI slots 112
dummy module, HDD module 103,
106
DVD drive 15
indicator 67

E

ECC 16
EDC 16
electrical data 22

Index

- electromagnetic compatibility [23, 35](#)
- electrostatic-sensitive devices (ESD) [34](#)
- EMC directive [23](#)
- EMC regulations [103, 106, 111, 124](#)
- ENERGY STAR [35](#)
- environment class [24](#)
- environmental protection [39](#)
- error
 - drifting display on monitor [87](#)
 - drive “dead” [88](#)
 - drive defective [89](#)
 - incorrect date [88](#)
 - incorrect time [88](#)
 - no display on monitor [87](#)
 - power-on indicator does not light [85](#)
 - screen remains blank [86](#)
 - screen shows flickering stripes [87](#)
 - server switches itself off [86](#)
- error correcting code [16](#)
- error correction [85](#)
- error detection code [16](#)
- error message on screen [89](#)
- expansion cards [107](#)
- F**
- fans [16](#)
- fault
 - drifting display on monitor [87](#)
 - drive defective [89](#)
 - incorrect date [88](#)
 - incorrect time [88](#)
 - no display on monitor [87](#)
 - screen remains blank [86](#)
 - screen shows flickering stripes [87](#)
- FCC statement [36](#)
- G**
- global error indicator [64, 67, 70](#)
- H**
- hard disk activity indicator [64, 66](#)
- hard disk drive [15](#)
 - installation frame [100](#)
- hard disk indicators [63](#)
- HDD busy indicator [68](#)
- HDD fault indicator [68](#)
- HDD module [100](#)
 - acclimatization time [41](#)
 - installation frame [104](#)
 - installing/removing [104](#)
- HDD/SSD drives
 - handling [101](#)
- hot-plug components
 - expansion cards [107](#)
 - fans [16, 97](#)
 - HDD modules [100](#)
 - memory boards [115](#)
 - PCI slots [15](#)
 - PSUs [93](#)
- hot-spare memory [16](#)
- I**
- ID button [64, 65](#)
- ID card [63, 64](#)
 - product name [42, 64](#)
 - serial number [42, 64](#)
- ID indicator [64, 66](#)
- IME [78](#)
- indicators
 - CSS [64, 66, 69](#)
 - DVD drive [67](#)
 - global error [64, 67, 70](#)
 - hard disk [63](#)
 - hard disk activity [64, 66](#)
 - HDD busy [68](#)
 - HDD fault [68](#)
 - ID [64, 66](#)
 - operating [66](#)
 - operation [64](#)
 - optical drive [63](#)
 - PSU [73](#)
 - ServerView Local Service Display [67](#)

- system error [67, 70](#)
- information, additional [13](#)
- installation
 - connect to mains voltage [55](#)
 - connecting devices [53](#)
 - connecting monitor [54](#)
 - connectors [53](#)
 - installation in rack [43](#)
 - SFP+ transceiver module [129](#)
- installation overview [25](#)
- installing in
 - 3rd party rack [51](#)
 - DataCenter rack [46](#)
 - PRIMECENTER rack [46](#)
- installing in the rack, notes [38](#)
- Integrated Mirroring Enhanced [78](#)
- integrated Remote Management
 - Controller [18](#)
- iRMC S2 [18](#)
- L**
- labels [40](#)
- LAN connectors [54](#)
- laser information [33](#)
- light emitting diode (LED) [33](#)
- lithium battery [31](#)
- Low Voltage Directive [35](#)
- low voltage directive [23](#)
- M**
- magnetic tape drive [15](#)
- mains voltage [55](#)
- management LAN connector [18](#)
- meaning of the symbols [22](#)
- MegaRAID [78](#)
- memory
 - hot-spare [16](#)
- memory module
 - inserting [119](#)
 - removing [117](#)
- memory scrubbing [16](#)
- monitor
 - connecting [54](#)
 - display drifts [87](#)
 - no display [87](#)
 - monitor port [54](#)
- N**
- NMI button [64, 65](#)
- noise level [24](#)
- notational conventions [22](#)
- O**
- On/Off button [65](#)
- on/off button [64](#)
- operating system, installing [80](#)
- operation
 - configuring the server [78](#)
 - server switch on/off [75](#)
- optical drive indicator [63](#)
- overload [19](#)
- P**
- packaging [39, 42](#)
- PCI slots [15](#)
 - dummy module [112](#)
 - expansion cards, replacing [107](#)
- PDA [17, 19](#)
- power supply unit
 - cable clamp [60](#)
- power supply units [16](#)
- power-on indicator [64, 66](#)
 - does not light [85](#)
- prefailure detection and analysis [17](#)
- PRIMECENTER rack
 - installing server [46](#)
 - requirements [43](#)
- product name [42, 64](#)
- property protection [83](#)
- PSU
 - indicators [73](#)
 - redundance [93](#)
- R**
- rack
 - installing server [43](#)
 - removing server [43](#)
 - requirements [43](#)

- RAID controller [15, 17](#)
- RAID controller is not configured for this drive [89](#)
- RAID level [17](#)
- recycling devices [40](#)
- regulations and standards [23](#)
- Remote Storage [18](#)
- removal
 - SFP+ transceiver module [126](#)
- replace
 - fans [97](#)
 - memory boards [115](#)
 - PSUs [93](#)
 - SFP+ transceiver modules [126](#)
- requirements
 - 3rd party rack [44](#)
 - DataCenter rack [43](#)
 - PRIMECENTER rack [43](#)
- reset button [64, 65](#)
- return of devices [40](#)
- routing
 - cables [49](#)
- S**
- safety precautions [27](#)
- safety standards [23](#)
- SAS Riser Board, RAID controller [15](#)
- SAS riser card [17](#)
- SAS/SATA RAID controller
 - configuring [78](#)
- saving energy [39](#)
- screen
 - error message [89](#)
 - flickering [87](#)
 - remains blank [86](#)
 - shows flickering stripes [87](#)
- serial connector COM1 [54](#)
- serial number [42, 64](#)
- server
 - accessible drives [15](#)
 - availability [16](#)
 - configuration [20, 78](#)
 - connectors [53](#)
 - cooling [16](#)
 - data protection [83](#)
 - data security [16](#)
 - dimensions [24](#)
 - electrical data [22](#)
 - error correction [85](#)
 - features [11, 14](#)
 - installation [41](#)
 - noise level [24](#)
 - open [134](#)
 - operation [63](#)
 - product name [42](#)
 - property protection [83](#)
 - routing cables [49](#)
 - safety precautions [27](#)
 - serial number [42](#)
 - ServerStart [78](#)
 - starting up [63](#)
 - switches itself off (error) [86](#)
 - switching on/off [75](#)
 - technical data [22](#)
 - transport [37](#)
 - troubleshooting [85](#)
 - unpacking [42](#)
 - voltage range [16](#)
- server management [19](#)
- ServerStart [78](#)
- ServerView Installation Manager [20, 79](#)
- ServerView Local Service Display [15, 67](#)
- ServerView Operations Manager [19](#)
 - supported functions [19](#)
- ServerView Remote Management [21](#)
- service [20](#)
- service LAN connector [18](#)
- SFP+ transceiver module
 - installation [129](#)
 - removal [126](#)
- start-up
 - configuring the server [78](#)
 - switching on the server [75](#)
- support [20](#)

support bracket 47
switch off time, defining 76
switch on time, defining 76
switching the server on/off 75
system board, features 15
system information 64

T

target group 11
technical data 22
 ambient conditions 24
time, incorrect 88
tips 85
transport damage 42
transporting the server 37
troubleshooting 85

U

unpacking, server 42
USB connector 63
USB connectors 54
using cable clamps 60

V

video connector 63
voltage 55
voltage range 16

Free Manuals Download Website

<http://myh66.com>

<http://usermanuals.us>

<http://www.somanuals.com>

<http://www.4manuals.cc>

<http://www.manual-lib.com>

<http://www.404manual.com>

<http://www.luxmanual.com>

<http://aubethermostatmanual.com>

Golf course search by state

<http://golfingnear.com>

Email search by domain

<http://emailbydomain.com>

Auto manuals search

<http://auto.somanuals.com>

TV manuals search

<http://tv.somanuals.com>