

# PRIMERGY RX900 S1 Server

## Maintenance Manual

## Comments... Suggestions... Corrections...

The User Documentation Department would like to know your opinion of this manual. Your feedback helps us optimize our documentation to suit your individual needs.

Feel free to send us your comments by e-mail to [manuals@ts.fujitsu.com](mailto:manuals@ts.fujitsu.com).

## Certified documentation according to DIN EN ISO 9001:2008

To ensure a consistently high quality standard and user-friendliness, this documentation was created to meet the regulations of a quality management system which complies with the requirements of the standard DIN EN ISO 9001:2008.

cognitas. Gesellschaft für Technik-Dokumentation mbH  
[www.cognitas.de](http://www.cognitas.de)

## Copyright and Trademarks

Copyright © 2010 Fujitsu Technology Solutions GmbH.

All rights reserved.

Delivery subject to availability; right of technical modifications reserved.

All hardware and software names used are trademarks of their respective manufacturers.

- The contents of this manual may be revised without prior notice.
- Fujitsu assumes no liability for damages to third party copyrights or other rights arising from the use of any information in this manual.
- No part of this manual may be reproduced in any form without the prior written permission of Fujitsu.

Microsoft, Windows, Windows Server, and Hyper V are trademarks or registered trademarks of Microsoft Corporation in the USA and other countries.

Intel and Xeon are trademarks or registered trademarks of Intel Corporation or its subsidiaries in the USA and other countries.

---

## **Before reading this manual**

### **For your safety**

This manual contains important information for safely and correctly using this product.

Carefully read the manual before using this product. Pay particular attention to the accompanying manual "Safety Notes and Regulations" and ensure these safety notes are understood before using the product. Keep this manual and the manual "Safety Notes and Regulations" in a safe place for easy reference while using this product.

### **Radio interference**

This product is a "Class A" ITE (Information Technology Equipment). In a domestic environment this product may cause radio interference, in which case the user may be required to take appropriate measures. VCCI-A

### **Aluminum electrolytic capacitors**

The aluminum electrolytic capacitors used in the product's printed circuit board assemblies and in the mouse and keyboard are limited-life components. Use of these components beyond their operating life may result in electrolyte leakage or depletion, potentially causing emission of foul odor or smoke.

As a guideline, in a normal office environment (25°C) operating life is not expected to be reached within the maintenance support period (5 years). However, operating life may be reached more quickly if, for example, the product is used in a hot environment. The customer shall bear the cost of replacing replaceable components which have exceeded their operating life. Note that these are only guidelines, and do not constitute a guarantee of trouble-free operation during the maintenance support period.

### **High safety use**

This product has been designed and manufactured for general uses such as general office use, personal use, domestic use and normal industrial use. It has not been designed or manufactured for uses which demand an extremely high level of safety and carry a direct and serious risk to life or body if such safety cannot be ensured.

---

These uses include control of nuclear reactions in nuclear power plants, automatic airplane flight control, air traffic control, traffic control in mass transport systems, medical devices for life support, and missile guidance control in weapons systems (hereafter, "high safety use"). Customers should not use this product for high safety use unless measures are in place for ensuring the level of safety demanded of such use. Please consult the sales staff of Fujitsu if intending to use this product for high safety use.

### **Measures against momentary voltage drop**

This product may be affected by a momentary voltage drop in the power supply caused by lightning. To prevent a momentary voltage drop, use of an AC uninterruptible power supply is recommended.

(This notice follows the guidelines of Voltage Dip Immunity of Personal Computer issued by JEITA, the Japan Electronics and Information Technology Industries Association.)

### **Technology controlled by the Foreign Exchange and Foreign Trade Control Law of Japan**

Documents produced by Fujitsu may contain technology controlled by the Foreign Exchange and Foreign Trade Control Law of Japan. Documents which contain such technology should not be exported from Japan or transferred to non-residents of Japan without first obtaining authorization in accordance with the above law.

### **Harmonic Current Standards**

This product conforms to harmonic current standard JIS C 61000-3-2.

### **Only for the Japanese market: About SATA hard disk drives**

The SATA version of this server supports hard disk drives with SATA / BC-SATA storage interfaces. Please note that the usage and operation conditions differ depending on the type of hard disk drive used.

Please refer to the following internet address for further information on the usage and operation conditions of each available type of hard disk drive:

<http://primeserver.fujitsu.com/primergy/harddisk/>



---

**Only for the Japanese market:**



Although described in this manual, some sections do not apply to the Japanese market. These options and routines include:

- CSS (Customer Self Service)
- USB Flash Module (UFM)
- Replacing the lithium battery



---

# Contents

<b>1</b>	<b>Introduction . . . . .</b>	<b>19</b>
<b>1.1</b>	<b>Where to find which information? . . . . .</b>	<b>20</b>
1.1.1	Documents you need at hand . . . . .	21
1.1.2	Accessing PRIMERGY documentation . . . . .	24
<b>1.2</b>	<b>Notational conventions . . . . .</b>	<b>24</b>
<b>2</b>	<b>Before you start . . . . .</b>	<b>25</b>
<b>2.1</b>	<b>Classification of procedures . . . . .</b>	<b>27</b>
<b>2.2</b>	<b>List of required tools . . . . .</b>	<b>29</b>
<b>3</b>	<b>Safety instructions . . . . .</b>	<b>31</b>
<b>4</b>	<b>Basic procedures . . . . .</b>	<b>37</b>
<b>4.1</b>	<b>Using diagnostics information . . . . .</b>	<b>37</b>
4.1.1	Locate the faulty server . . . . .	37
4.1.2	Locate the faulty component by PRIMERGY diagnostics indicators 39	
<b>4.2</b>	<b>Opening the rack door . . . . .</b>	<b>40</b>
<b>4.3</b>	<b>Shutting down the server . . . . .</b>	<b>41</b>
<b>4.4</b>	<b>Sliding the server out of the rack . . . . .</b>	<b>42</b>
<b>4.5</b>	<b>Opening the server . . . . .</b>	<b>44</b>
4.5.1	Removing the front cover . . . . .	45
4.5.2	Removing the rear cover . . . . .	46
<b>4.6</b>	<b>Closing the server . . . . .</b>	<b>47</b>
4.6.1	Installing the front cover . . . . .	47
4.6.2	Installing the rear cover . . . . .	48
<b>4.7</b>	<b>Mounting the server in the rack . . . . .</b>	<b>49</b>
<b>4.8</b>	<b>Bringing the server back to operation . . . . .</b>	<b>51</b>

## Contents

---

<b>4.9</b>	<b>Closing the rack door</b>	<b>51</b>
<b>5</b>	<b>Power supply</b>	<b>53</b>
<b>5.1</b>	<b>Installing a hot-plug Power Supply Unit (PSU)</b>	<b>54</b>
5.1.1	Required tools	54
5.1.2	Starting the task	54
5.1.3	Removing a dummy module (if applicable)	54
5.1.4	Installing a power supply unit	55
5.1.5	Connecting the power cord	56
5.1.6	Completing the task	57
<b>5.2</b>	<b>Replacing a hot-plug power supply unit</b>	<b>57</b>
5.2.1	Required tools	57
5.2.2	Starting the task	58
5.2.3	Removing the power supply unit	58
5.2.4	Reinstalling the PSU	59
5.2.5	Completing the task	59
<b>5.3</b>	<b>Removing a redundant hot-plug power supply unit</b>	<b>59</b>
5.3.1	Required tools	59
5.3.2	Starting the task	59
5.3.3	Removing the power supply unit	60
5.3.4	Installing a dummy module	61
5.3.5	Completing the task	61
<b>5.4</b>	<b>Replacing the power distribution board</b>	<b>62</b>
5.4.1	Required tools	62
5.4.2	Starting the task	62
5.4.3	Sliding the local service display outward	63
5.4.4	Disconnecting the cables	64
5.4.5	Removing the fan cage	65
5.4.6	Removing the CPUMEMR guide	66
5.4.7	Removing the air guide	67
5.4.8	Removing the baseboard	68
5.4.9	Removing the power distribution board	69
5.4.10	Installing the power distribution board	71
5.4.11	Inserting the baseboard	72
5.4.12	Installing the air guide	73
5.4.13	Inserting the CPUMEMR guide	74
5.4.14	Inserting the fan cage	75
5.4.15	Connecting the cables to the baseboard	76
5.4.16	Sliding the local service display inward	77

5.4.17	Completing the task . . . . .	77
<b>6</b>	<b>Hard disk and solid state drives . . . . .</b>	<b>79</b>
<b>6.1</b>	<b>Installing the HDD/SSD module . . . . .</b>	<b>80</b>
6.1.1	Required tools . . . . .	80
6.1.2	Starting the task . . . . .	80
6.1.3	Removing the dummy module . . . . .	81
6.1.4	Unlocking the HDD/SSD module . . . . .	82
6.1.5	Inserting the HDD/SSD module . . . . .	83
6.1.6	Completing the task . . . . .	83
<b>6.2</b>	<b>Replacing the HDD/SSD module . . . . .</b>	<b>84</b>
6.2.1	Required tools . . . . .	84
6.2.2	Starting the task . . . . .	85
6.2.3	Unlocking the HDD/SSD module . . . . .	85
6.2.4	Removing the HDD/SSD module . . . . .	86
6.2.5	Completing the task . . . . .	86
<b>6.3</b>	<b>Removing the HDD/SSD module . . . . .</b>	<b>86</b>
6.3.1	Required tools . . . . .	86
6.3.2	Starting the task . . . . .	86
6.3.3	Unlocking the HDD/SSD module . . . . .	87
6.3.4	Removing the HDD/SSD module . . . . .	87
6.3.5	Installing the dummy module . . . . .	88
6.3.6	Completing the task . . . . .	88
<b>6.4</b>	<b>Replacing the SAS backplane . . . . .</b>	<b>89</b>
6.4.1	Required tools . . . . .	89
6.4.2	Starting the task . . . . .	89
6.4.3	Sliding the local service display outward . . . . .	90
6.4.4	Disconnecting the cables . . . . .	91
6.4.5	Sliding the optical drive outward . . . . .	92
6.4.6	Removing the air guide . . . . .	93
6.4.7	Removing the SAS backplane . . . . .	94
6.4.8	Installing the SAS backplane . . . . .	94
6.4.9	Installing the air guide . . . . .	95
6.4.10	Sliding the optical drive inward . . . . .	96
6.4.11	Connecting the cables to the baseboard . . . . .	97
6.4.12	Sliding the local service display inward . . . . .	98
6.4.13	Completing the task . . . . .	99

<b>7</b>	<b>Fan modules</b>	<b>101</b>
<b>7.1</b>	<b>Replacing a defective fan module</b>	<b>102</b>
7.1.1	Required tools	102
7.1.2	Starting the task	102
7.1.3	Opening the fan cover	102
7.1.4	Replacing the defective fan module	103
7.1.5	Closing the fan cover	104
7.1.6	Completing the task	104
<b>8</b>	<b>Expansion cards and BBU</b>	<b>105</b>
<b>8.1</b>	<b>Mounting expansion card slot brackets</b>	<b>107</b>
8.1.1	Required tools	107
8.1.2	General instructions	108
8.1.3	Network adapter D2735	108
8.1.4	Network adapter D2745	110
8.1.5	Network adapter D2755	112
<b>8.2</b>	<b>Installing SFP+ transceiver modules</b>	<b>114</b>
8.2.1	Required tools	114
8.2.2	Preparing the SFP+ transceiver module	115
8.2.3	Inserting the SFP+ transceiver module	116
8.2.4	Installing the secondary SFP+ transceiver module	119
<b>8.3</b>	<b>Replacing SFP+ transceiver modules</b>	<b>120</b>
8.3.1	Required tools	120
8.3.2	Removing an SFP+ transceiver module	121
8.3.3	Completing the task	123
<b>8.4</b>	<b>Installing a hot-plug expansion card</b>	<b>124</b>
8.4.1	Required tools	124
8.4.2	Starting the task	125
8.4.3	Pulling the removal tool out of the slot	125
8.4.4	Removing the retaining plate	126
8.4.5	Removing the engaging hooks	127
8.4.6	Inserting an expansion card in the removal tool	127
8.4.7	Inserting the expansion card in the slot	130
8.4.8	Activating the expansion card	131
8.4.9	Completing the task	131
<b>8.5</b>	<b>Removing a hot-plug expansion card</b>	<b>132</b>
8.5.1	Required tools	132

8.5.2	Starting the task . . . . .	133
8.5.3	Deactivating the expansion card . . . . .	133
8.5.4	Pulling the expansion card out of the slot . . . . .	134
8.5.5	Removing the expansion card from the removal tool . . . . .	135
8.5.6	Removing the engaging hooks . . . . .	136
8.5.7	Inserting a retaining plate in the removal tool . . . . .	137
8.5.8	Inserting the dummy module in the slot . . . . .	138
8.5.9	Completing the task . . . . .	138
<b>8.6</b>	<b>Replacing a hot-plug expansion card . . . . .</b>	<b>139</b>
8.6.1	Required tools . . . . .	139
8.6.2	Starting the task . . . . .	140
8.6.3	Deactivating the expansion card . . . . .	140
8.6.4	Pulling the expansion card out of the slot . . . . .	141
8.6.5	Removing the expansion card from the removal tool . . . . .	142
8.6.6	Removing the engaging hooks . . . . .	143
8.6.7	Inserting an expansion card in the removal tool . . . . .	143
8.6.8	Inserting the expansion card in the slot . . . . .	146
8.6.9	Activating the expansion card . . . . .	147
8.6.10	Completing the task . . . . .	147
<b>8.7</b>	<b>Installing a non-hot-plug expansion card . . . . .</b>	<b>148</b>
8.7.1	Required tools . . . . .	148
8.7.2	Starting the task . . . . .	149
8.7.3	Removing the PCI Riser (if applicable) . . . . .	149
8.7.4	Removing the slot cover . . . . .	150
8.7.5	Inserting the expansion card in the slot . . . . .	150
8.7.6	Installing the PCI Riser (if applicable) . . . . .	151
8.7.7	Completing the task . . . . .	152
<b>8.8</b>	<b>Removing a non-hot-plug expansion card . . . . .</b>	<b>152</b>
8.8.1	Required tools . . . . .	153
8.8.2	Starting the task . . . . .	153
8.8.3	Removing the PCI Riser (if applicable) . . . . .	154
8.8.4	Removing the expansion card from the slot . . . . .	155
8.8.5	Installing the slot cover . . . . .	156
8.8.6	Installing the PCI Riser (if applicable) . . . . .	157
8.8.7	Completing the task . . . . .	157
<b>8.9</b>	<b>Replacing a non-hot-plug expansion card . . . . .</b>	<b>158</b>
8.9.1	Required tools . . . . .	158
8.9.2	Starting the task . . . . .	159
8.9.3	Removing the PCI Riser (if applicable) . . . . .	159
8.9.4	Removing the expansion card from the slot . . . . .	160

# Contents

---

8.9.5	Inserting the expansion card in the slot . . . . .	161
8.9.6	Installing the PCI Riser (if applicable) . . . . .	162
8.9.7	Completing the task . . . . .	162
<b>8.10</b>	<b>Replacing the Modular RAID controller . . . . .</b>	<b>163</b>
8.10.1	Required tools . . . . .	163
8.10.2	Starting the task . . . . .	164
8.10.3	Removing the PCI Riser . . . . .	164
8.10.4	Removing the Modular RAID controller . . . . .	165
8.10.5	Inserting the Modular RAID controller . . . . .	166
8.10.6	Installing the PCI Riser . . . . .	168
8.10.7	Completing the task . . . . .	168
<b>8.11</b>	<b>Installing a Battery Backup Unit (BBU) . . . . .</b>	<b>169</b>
8.11.1	Required tools . . . . .	169
8.11.2	Starting the task . . . . .	170
8.11.3	Connecting the BBU cable to the BBU . . . . .	170
8.11.4	Installing the BBU in the BBU holder . . . . .	171
8.11.5	Connecting the BBU to the Modular RAID controller . . . . .	173
8.11.6	Completing the task . . . . .	174
<b>8.12</b>	<b>Replacing a Battery Backup Unit (BBU) . . . . .</b>	<b>175</b>
8.12.1	Required tools . . . . .	175
8.12.2	Starting the task . . . . .	176
8.12.3	Disconnecting the BBU from the Modular RAID controller . . . . .	177
8.12.4	Removing the BBU from the BBU holder . . . . .	178
8.12.5	Disconnecting the BBU cable from the BBU . . . . .	179
8.12.6	Reinstalling a new BBU . . . . .	179
8.12.7	Completing the task . . . . .	179
<b>9</b>	<b>Main memory . . . . .</b>	<b>181</b>
<b>9.1</b>	<b>Installing a CPUMEMR . . . . .</b>	<b>183</b>
9.1.1	Required tools . . . . .	183
9.1.2	Starting the task . . . . .	183
9.1.3	Populating the CPUMEMR . . . . .	184
9.1.4	Selecting the CPUMEMR slot . . . . .	184
9.1.5	Removing the air duct (if applicable) . . . . .	185
9.1.6	Inserting the CPUMEMR in the slot . . . . .	186
9.1.7	Inserting the air duct in the slot (if applicable) . . . . .	187
9.1.8	Completing the task . . . . .	187
<b>9.2</b>	<b>Replacing a faulty CPUMEMR . . . . .</b>	<b>188</b>



9.2.1	Required tools . . . . .	188
9.2.2	Starting the task . . . . .	188
9.2.3	Identifying a fault on the CPUMEMR . . . . .	189
9.2.4	Removing the CPUMEMR . . . . .	190
9.2.5	Reinstalling a new CPUMEMR . . . . .	190
9.2.6	Completing the task . . . . .	191
<b>9.3</b>	<b>Installing additional DIMM memory modules . . . . .</b>	<b>191</b>
9.3.1	Required tools . . . . .	191
9.3.2	Starting the task . . . . .	192
9.3.3	Selecting the DIMM memory module slot . . . . .	192
9.3.4	Inserting the DIMM memory module in the slot . . . . .	194
9.3.5	Completing the task . . . . .	194
<b>9.4</b>	<b>Replacing a faulty memory module . . . . .</b>	<b>195</b>
9.4.1	Required tools . . . . .	195
9.4.2	Starting the task . . . . .	195
9.4.3	Removing the DIMM memory module . . . . .	196
9.4.4	Reinstalling a DIMM memory module . . . . .	196
9.4.5	Completing the task . . . . .	197
<b>10</b>	<b>Processors . . . . .</b>	<b>199</b>
<b>10.1</b>	<b>Installing a processor in a new CPUMEMR . . . . .</b>	<b>200</b>
10.1.1	Required tools . . . . .	200
10.1.2	Starting the task . . . . .	201
10.1.3	Removing the socket cover . . . . .	201
10.1.4	Installing the processor . . . . .	202
10.1.5	Applying the thermal paste . . . . .	203
10.1.6	Installing the heat sink . . . . .	205
10.1.7	Completing the task . . . . .	206
<b>10.2</b>	<b>Replacing a processor . . . . .</b>	<b>206</b>
10.2.1	Required tools . . . . .	207
10.2.2	Starting the task . . . . .	207
10.2.3	Removing the heat sink . . . . .	208
10.2.4	Removing the processor . . . . .	209
10.2.5	Installing the processor . . . . .	210
10.2.6	Applying the thermal paste . . . . .	211
10.2.7	Installing the heat sink . . . . .	213
10.2.8	Completing the task . . . . .	214
<b>10.3</b>	<b>Replacing a heat sink . . . . .</b>	<b>215</b>

## Contents

---

10.3.1	Required tools . . . . .	215
10.3.2	Starting the task . . . . .	215
10.3.3	Removing the heat sink . . . . .	216
10.3.4	Applying the thermal paste . . . . .	217
10.3.5	Installing the heat sink . . . . .	219
10.3.6	Completing the task . . . . .	220
<b>11</b>	<b>Optical and backup drives . . . . .</b>	<b>221</b>
<b>11.1</b>	<b>Replacing the optical drive . . . . .</b>	<b>221</b>
11.1.1	Required tools . . . . .	222
11.1.2	Starting the task . . . . .	222
11.1.3	Removing the optical drive . . . . .	223
11.1.4	Replacing the optical drive in the installation frame . . . . .	223
11.1.5	Installing the optical drive . . . . .	224
11.1.6	Completing the task . . . . .	225
<b>12</b>	<b>Front panel and external connectors . . . . .</b>	<b>227</b>
<b>12.1</b>	<b>Replacing the control panel . . . . .</b>	<b>228</b>
12.1.1	Required tools . . . . .	228
12.1.2	Starting the task . . . . .	228
12.1.3	Removing the control panel . . . . .	229
12.1.4	Disconnecting the control panel cable . . . . .	230
12.1.5	Connecting the control panel cable . . . . .	231
12.1.6	Installing the control panel . . . . .	232
12.1.7	Completing the task . . . . .	233
<b>12.2</b>	<b>Replacing the front panel module . . . . .</b>	<b>234</b>
12.2.1	Required tools . . . . .	234
12.2.2	Starting the task . . . . .	234
12.2.3	Removing the front panel module . . . . .	235
12.2.4	Inserting the front panel module . . . . .	237
12.2.5	Completing the task . . . . .	238
<b>12.3</b>	<b>Replacing the USB board . . . . .</b>	<b>239</b>
12.3.1	Required tools . . . . .	239
12.3.2	Starting the task . . . . .	239
12.3.3	Removing the USB board . . . . .	240
12.3.4	Installing the USB board . . . . .	241
12.3.5	Completing the task . . . . .	241

<b>12.4</b>	<b>Replacing the I/O board</b>	<b>242</b>
12.4.1	Required tools	242
12.4.2	Starting the task	242
12.4.3	Removing the PCI Riser	243
12.4.4	Removing the I/O board	244
12.4.5	Installing the I/O board	244
12.4.6	Installing the PCI Riser	245
12.4.7	Completing the task	245
<b>13</b>	<b>Management and diagnostics modules</b>	<b>247</b>
<b>13.1</b>	<b>Replacing the local service display</b>	<b>248</b>
13.1.1	Required tools	248
13.1.2	Starting the task	248
13.1.3	Removing the local service display	249
13.1.4	Inserting the local service display	250
13.1.5	Completing the task	251
<b>13.2</b>	<b>Replacing the chassis ID board</b>	<b>252</b>
13.2.1	Required tools	252
13.2.2	Starting the task	252
13.2.3	Removing the chassis ID board	253
13.2.4	Installing the chassis ID board	256
13.2.5	Completing the task	259
<b>14</b>	<b>Baseboard</b>	<b>261</b>
<b>14.1</b>	<b>Replacing the lithium battery</b>	<b>262</b>
14.1.1	Required tools	262
14.1.2	Starting the task	263
14.1.3	Replacing the faulty battery	263
14.1.4	Completing the task	264
<b>14.2</b>	<b>Installing the UFM</b>	<b>264</b>
14.2.1	Required tools	264
14.2.2	Starting the task	265
14.2.3	Inserting the UFM	265
14.2.4	Completing the task	266
<b>14.3</b>	<b>Replacing the UFM board</b>	<b>267</b>
14.3.1	Required tools	267
14.3.2	Starting the task	268

## Contents

---

14.3.3	Removing the UFM . . . . .	268
14.3.4	Completing the task . . . . .	269
<b>14.4</b>	<b>Installing the TPM . . . . .</b>	<b>270</b>
14.4.1	Required tools . . . . .	270
14.4.2	Starting the task . . . . .	270
14.4.3	Inserting the TPM . . . . .	271
14.4.4	Completing the task . . . . .	272
<b>14.5</b>	<b>Replacing the TPM . . . . .</b>	<b>273</b>
14.5.1	Required tools . . . . .	273
14.5.2	Starting the task . . . . .	274
14.5.3	Removing the TPM . . . . .	274
14.5.4	Completing the task . . . . .	275
<b>14.6</b>	<b>Replacing the baseboard . . . . .</b>	<b>276</b>
14.6.1	Required tools . . . . .	277
14.6.2	Starting the task . . . . .	277
14.6.3	Sliding the local service display outward . . . . .	278
14.6.4	Disconnecting the cables . . . . .	279
14.6.5	Removing the fan cage . . . . .	280
14.6.6	Removing the CPUMEMR guide . . . . .	281
14.6.7	Removing the air guide . . . . .	282
14.6.8	Removing the baseboard . . . . .	283
14.6.9	Inserting the baseboard . . . . .	284
14.6.10	Installing the air guide . . . . .	285
14.6.11	Inserting the CPUMEMR guide . . . . .	286
14.6.12	Inserting the fan cage . . . . .	287
14.6.13	Connecting the cables to the baseboard . . . . .	288
14.6.14	Sliding the local service display inward . . . . .	289
14.6.15	Completing the task . . . . .	289
<b>15</b>	<b>Cables . . . . .</b>	<b>291</b>
<b>15.1</b>	<b>Replacing the fan cables . . . . .</b>	<b>292</b>
15.1.1	Required tools . . . . .	292
15.1.2	Starting the task . . . . .	292
15.1.3	Removing the fan cage . . . . .	293
15.1.4	Removing the CPUMEMR guide . . . . .	294
15.1.5	Removing the fan cable . . . . .	295
15.1.6	Installing the fan cable . . . . .	297
15.1.7	Inserting the CPUMEMR guide . . . . .	299
15.1.8	Inserting the fan cage . . . . .	300

15.1.9	Completing the task . . . . .	300
<b>15.2</b>	<b>Replacing the control panel cable . . . . .</b>	<b>301</b>
15.2.1	Required tools . . . . .	301
15.2.2	Starting the task . . . . .	302
15.2.3	Removing the control panel . . . . .	302
15.2.4	Disconnecting the control panel cable . . . . .	303
15.2.5	Connecting the control panel cable . . . . .	304
15.2.6	Installing the control panel . . . . .	305
15.2.7	Completing the task . . . . .	306
<b>15.3</b>	<b>Replacing the chassis ID board cable . . . . .</b>	<b>307</b>
15.3.1	Required tools . . . . .	307
15.3.2	Starting the task . . . . .	307
15.3.3	Removing the chassis ID board . . . . .	308
15.3.4	Disconnecting the chassis ID board cable . . . . .	310
15.3.5	Connecting the chassis ID board cable . . . . .	311
15.3.6	Installing the chassis ID board . . . . .	312
15.3.7	Completing the task . . . . .	314
<b>15.4</b>	<b>Replacing power cables of the optical drive, the SAS backplane, or the power distribution board . . . . .</b>	<b>315</b>
15.4.1	Required tools . . . . .	315
15.4.2	Starting the task . . . . .	315
15.4.3	Sliding the local service display outward . . . . .	316
15.4.4	Disconnecting the cables . . . . .	317
15.4.5	Removing the fan cage . . . . .	318
15.4.6	Removing the CPUMEMR guide . . . . .	319
15.4.7	Removing the air guide . . . . .	320
15.4.8	Removing the baseboard . . . . .	321
15.4.9	Removing the power distribution board . . . . .	322
15.4.10	Disconnecting the defective power distribution cable(s) . . . . .	323
15.4.11	Connecting the new power distribution cable(s) . . . . .	324
15.4.12	Installing the power distribution board . . . . .	325
15.4.13	Inserting the baseboard . . . . .	326
15.4.14	Installing the air guide . . . . .	327
15.4.15	Inserting the CPUMEMR guide . . . . .	328
15.4.16	Inserting the fan cage . . . . .	329
15.4.17	Connecting the cables to the baseboard . . . . .	330
15.4.18	Sliding the local service display inward . . . . .	331
15.4.19	Completing the task . . . . .	331
<b>15.5</b>	<b>Replacing the SAS cable, the SATA cable, the front video connector cable, or the front USB cable . . . . .</b>	<b>333</b>

## Contents

---

15.5.1	Required tools . . . . .	333
15.5.2	Starting the task . . . . .	334
15.5.3	Sliding the local service display outward . . . . .	335
15.5.4	Disconnecting the cables . . . . .	336
15.5.5	Removing the fan cage . . . . .	337
15.5.6	Removing the CPUMEMR guide . . . . .	338
15.5.7	Removing the air guide . . . . .	339
15.5.8	Removing the baseboard . . . . .	340
15.5.9	Opening the cable guides . . . . .	341
15.5.10	Closing the cable guides . . . . .	342
15.5.11	Inserting the baseboard . . . . .	343
15.5.12	Installing the air guide . . . . .	344
15.5.13	Inserting the CPUMEMR guide . . . . .	345
15.5.14	Inserting the fan cage . . . . .	346
15.5.15	Connecting the cables to the baseboard . . . . .	347
15.5.16	Sliding the local service display inward . . . . .	348
15.5.17	Completing the task . . . . .	348
<b>16</b>	<b>Appendix . . . . .</b>	<b>351</b>
<b>16.1</b>	<b>Mechanical overview . . . . .</b>	<b>351</b>
16.1.1	Front side . . . . .	351
16.1.2	Rear side . . . . .	352
16.1.3	Top view . . . . .	354
<b>16.2</b>	<b>Mounting order for SSD and HDD modules . . . . .</b>	<b>358</b>
<b>16.3</b>	<b>Memory board configuration . . . . .</b>	<b>359</b>
<b>16.4</b>	<b>PCIe slot to CPUMEMR assignment . . . . .</b>	<b>362</b>
<b>16.5</b>	<b>Expansion card configuration table . . . . .</b>	<b>364</b>
<b>16.6</b>	<b>Cabling . . . . .</b>	<b>367</b>

---

# 1 Introduction

This Maintenance manual provides procedures for:

- Replacing faulty units to get the system back to normal operation.
- Expanding the server configuration by using optional hardware components available within the same release to meet new requirements.
- Upgrading the server by replacing existing hardware with high-capacity components to meet new requirements or to react on release upgrades that provide new functionality or require additional capacity.

The manual at hand focusses on local maintenance tasks to be done at the server site. It is recommended to prepare these local maintenance tasks by remote diagnostics procedures introduced in the "ServerView Suite Local Service Concept - LSC" manual on the ServerView Suite DVD 2.



## **CAUTION!**

The document at hand comprises procedures of a wide range of complexity. Check the profile of qualification for technicians before assigning tasks. Before you start, carefully read "[Classification of procedures](#)" on page 27.

# 1.1 Where to find which information?

While the Maintenance manual focuses on maintenance procedures to bring the system back to normal operation, individual manuals provide detailed background information on the board layout, indicators, or BIOS Setup. Other documentation such as service foils attached to the server covers or the illustrated spares catalogue available in the internet (not applicable for the Japanese market) help you to organize your work, see [figure 1](#).

This section provides information on:

- "Documents you need at hand" on page 21
- "Accessing PRIMERGY documentation" on page 24

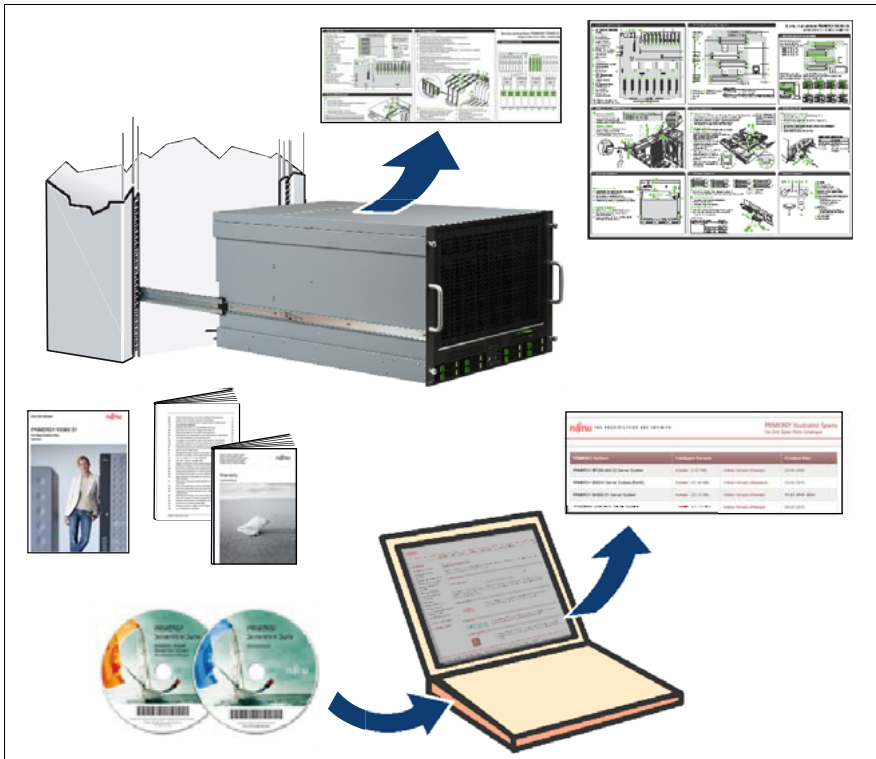

Figure 1: Hardware-related customer documentation



## 1.1.1 Documents you need at hand

In the maintenance procedures, you will find references to other documents for information that does not suit into individual procedure steps. So please check which of these documents you need to have at hand when you leave for maintaining a server.



Document	Description	Format
Abbreviations and Glossary	PRIMERGY abbreviations and glossary are available on the ServerView Suite DVD 2 and in the internet.	
BIOS Setup manual	<p>This manual provides instructions and reference information needed to</p> <ul style="list-style-type: none"> <li>– configure the system functions</li> <li>– view and change device settings</li> <li>– view environmental information for the platform</li> </ul> <p>Most systems are already configured by the manufacturer or the dealer. There is no need to run the BIOS Setup when starting the computer unless there is an error message.</p>	
Foils	Foils attached inside the front and rear cover of the server summarize information such as board layout, indicators, and maintenance tasks.	

Table 1: Documentation you need at hand

## Introduction



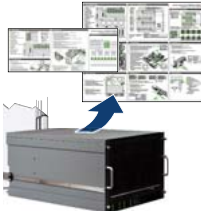

Document	Description	Format
Hardware poster	The hardware poster summarizes information such as rack installation, power supply, HDD modules, and indicators.	
Illustrated spares catalog	In the event of errors, the ServerView Operations Manager refers you directly to the affected component and its order information in the Illustrated Spares catalog of the server in question. (This feature is not available for the Japanese market.)	
Operating manual	This manual provides information on features and technical data of the server. The manual explains the indicators and includes instructions on how to install, set up, and operate the server.	
Safety Notes and Regulations	The safety instructions listed in this manual will help you to avoid making serious errors that could impair your health, damage the device and endanger the data base.	
Technical manual	This manual describes the key characteristics and board layout of the system board. The manual provides detailed information on memory configuration and expansion card configuration.	

Table 1: Documentation you need at hand

Document	Description	Format
Warranty manual	A leaflet guides you to information on warranty regulations in section "Safety / Eco / Warranty" on the ServerView DVD 2.	

Table 1: Documentation you need at hand

Additional documentation is available on more specific topics. Please check which of these documents you need for individual tasks:

- Documentation for the boards and drives
- Information files in your operating system
- Manual for the monitor
- Operating system documentation
- "Returning Used Devices" manual and "Service Desk" leaflet
- "ServerView Suite Local Service Concept - LSC" manual
- "Customer Self Service (CSS)" manual

### 1.1.2 Accessing PRIMERGY documentation

You have the following options to access PRIMERGY documentation:

- Open the ServerView Suite DVD 2 which is part of the ServerView Suite supplied with every server.

The latest version of the ServerView Suite DVD 2 is available by using the following order number: U15000-C289 (EMEA market). The order number for the Japanese market is available via the configurator of the server <http://primeserver.fujitsu.com/primergy/system.html>.

- Download individual documents free of charge from the Internet. You will find an overview of online documentation using these URLs:



<http://manuals.ts.fujitsu.com> (EMEA market) and

<http://primeserver.fujitsu.com/primergy/manual.html> (Japanese market).

PRIMERGY server documentation can be accessed using the navigation option "Industry standard servers".

## 1.2 Notational conventions

The following notational conventions are used in this manual:

<i>Text in italics</i>	indicates commands or menu items.
"Quotation marks"	indicate names of chapters and terms that are being emphasized.
▶	describes activities that must be performed in the order shown.
 <b>CAUTION!</b>	pay particular attention to texts marked with this symbol. Failure to observe this warning may endanger your life, destroy the system or lead to the loss of data.
	indicates additional information, notes and tips.
	indicates the procedure category in terms of complexity and the profile of qualification needed to perform the task, see " <a href="#">Classification of procedures</a> " on page 27.

---

## 2 Before you start

Before you start to replace or install hardware components in the RX900 S1 server, please proceed as follows:

- ▶ Carefully read the safety instructions in the chapter "[Safety instructions](#)" on [page 31](#).
- ▶ Make sure that all necessary manuals are available by using the list of documents in section "[Where to find which information?](#)" on [page 20](#); print the PDF files if required.
- ▶ Become familiar with the procedure categories introduced in section "[Classification of procedures](#)" on [page 27](#).
- ▶ Check whether all required tools are available as explained in section "[List of required tools](#)" on [page 29](#).

### Installing an optional component

The "PRIMERGY RX900 S1 Server - Operating manual" introduces the features of the RX900 S1 server and provides an overview of available hardware options to configure your server as needed in your system setup.

Use the ServerView Suite to plan hardware expansions for example due to capacity problems. For more information see ServerView documentation on the following topics:

- Administration and manageability
- Optimization and virtualization
- Maintenance



For the latest information on optional products provided for the RX900 S1 see the configurator of the server:

[http://ts.fujitsu.com/products/standard\\_servers/rack/primergy\\_rx900s1.html](http://ts.fujitsu.com/products/standard_servers/rack/primergy_rx900s1.html)  
(for the EMEA market)

Please contact your local Fujitsu customer service for details on key data that needs to be close at hand when organizing the expansion and ordering spare parts.

### Replacing a faulty component

The global error indicator on the front and on the rear side of the server indicates that a hardware components needs to be replaced. For information on the control elements and indicators of your server see "PRIMERGY RX900 S1 Server - Operating manual".

If the system has been powered off to replace a non-hot plug unit, a system of PRIMERGY diagnostics indicators guides you to the faulty component. The CSS button enables the indicator of the faulty component to light up even if the power has been switched off, see "[Using diagnostics information](#)" on page 37.

If a defective component is included in the CSS concept, the CSS indicators on the front and rear side of the server light up. For more information see the "ServerView Suite Local Service Concept - LSC" manual and the "Customer Self Service (CSS)" manual on the ServerView Suite DVD 2.

It is recommended to prepare local maintenance tasks by remote diagnostics procedures introduced in the "ServerView Suite Local Service Concept - LSC" manual on the ServerView Suite DVD 2.

## 2.1 Classification of procedures

The complexity of procedures to install or replace hardware components varies a lot. Three categories indicate the degree of difficulty and the profile of qualification needed to perform a task. Warnings help you to assess the consequences for performing procedures without the required qualification.

At the beginning of each procedure, the category is indicated by the symbols introduced in this section. Please ask you local Fujitsu service center for more detailed information.



### Trained personnel

Trained persons can install or replace certain hot-plug components during operation. The hot-plug procedure increases the availability of system operation and guarantees a high degree of data integrity and fail-safe performance.

Components that can be handled by trained personnel are:

- Power supply units, see ["Power supply" on page 53](#)
- Fan modules, see ["Fan modules" on page 101](#)
- HDD modules and SSD modules, see ["Hard disk and solid state drives" on page 79](#)



### Specialized personnel

Specialists can carry out certain expansions, upgrades, or replacements after the server has been shut down properly and powered off.



### CAUTION!

The device can be seriously damaged if it is opened without authorization or if repairs are attempted by untrained personnel.



### Authorized personnel

Authorized specialist personnel can carry out replacement tasks for integral server components. Please ask your local Fujitsu service center for more detailed information.



### CAUTION!

Procedures indicated as "Authorized personnel only" must be done by Fujitsu service personnel or technicians trained by Fujitsu for doing these tasks. Please note that unauthorized interference with the system will void the warranty and exempt the manufacturer from all liability.

Components to be handled by authorized personnel are:

- Processors, see ["Processors" on page 199](#)
- Memory modules, see ["Main memory" on page 181](#)
- Expansion cards, see ["Expansion cards and BBU" on page 105](#)
- Optical drives, see ["Optical and backup drives" on page 221](#)
- SAS backplane, see ["Hard disk and solid state drives" on page 79](#)
- Power distribution board, see ["Power supply" on page 53](#)
- Front panel and I/O board, see ["Front panel and external connectors" on page 227](#)
- Management and diagnostics modules, see ["Management and diagnostics modules" on page 247](#)
- Baseboard, see ["Baseboard" on page 261](#)
- Cables, see ["Cables" on page 291](#)



## 2.2 List of required tools

Before leaving for the server, please make sure that you have Phillips head screw drivers of the size Ph0, Ph1, and Ph2 with you. You will find a list of required tools at the beginning of each procedure.

Table 2 lists all available screws in the RX900 S1 server.



Usage	Type	Figure	Head Tool / Bit insert
2.5-inch HDD/SSD modules	M3 x 4 mm		Phillips Ph0
Cable guide screw	--		Phillips Ph0
Captive screw/ knurled screw	--		Phillips Ph2
Expansion card screw	M3 x 4,5 mm		Phillips Ph0
Fan cable screw	--		Phillips Ph0
Knurled screw	--		Phillips Ph2

Table 2: List of screws for the RX900 S1

## Before you start

Usage	Type	Figure	Head Tool / Bit insert
Slimline Optical drive	M2.0		Phillips Ph0
TPM screw	--		Phillips Ph0
UFM nylon screw	--		Phillips Ph1
USB module screw	--		Phillips Ph1

Table 2: List of screws for the RX900 S1

---

## 3 Safety instructions



The following safety instructions are also provided in the manual "Safety Notes and Regulations".

This device meets the relevant safety regulations for IT equipment. If you have any questions about whether you can install the server in the intended environment, please contact your sales outlet or our customer service team.



### CAUTION!

- The actions described in this manual shall be performed by technical specialists. A technical specialist is a person who is trained to install the server including hardware and software.
- Repairs to the device that do not relate to CSS failures shall be performed by service personnel. Please note that unauthorized interference with the system will void the warranty and exempt the manufacturer from all liability.
- Any failure to observe the guidelines in this manual, and any improper repairs could expose the user to risks (electric shock, energy hazards, fire hazards) or damage the equipment.
- Before installing/removing internal options to/from the server, turn off the server, all peripheral devices, and any other connected devices. Also unplug all power cords from the power outlet. Failure to do so can cause electric shock.

### Before starting up



### CAUTION!

- During installation and before operating the device, observe the instructions on environmental conditions for your device.
- If the device is brought in from a cold environment, condensation may form both inside and on the outside of the device.

Wait until the device has acclimatized to room temperature and is absolutely dry before starting it up. Material damage may be caused to the device if this requirement is not observed.

- Transport the device only in the original packaging or in packaging that protects it from knocks and jolts.

### Installation and operation



#### CAUTION!

- If the device is integrated in an installation that receives power from an industrial (public) power supply network with the IEC309 connector, the (public) power supply protection must comply with the requirements for the non-industrial (public) power supply networks for the type A connector.
- The server supports a mains voltage in the range of 200 - 240 V. You may only operate the server if its rated voltage range corresponds to the local mains voltage.
- This device has a specially approved power cable and must only be connected to a safety socket on the rack mains socket strip.
- The ON/OFF button does not disconnect the device from the mains voltage. To completely disconnect it from the mains voltage, remove the power plug from the safety socket.
- Always connect the device and the attached peripherals to the same power circuit. Otherwise you run the risk of losing data if, for example, the server is still operating but the peripheral device (e.g. storage subsystem) has failed during a power outage.
- Take notice that the data cables to peripheral devices are adequately shielded.
- To the LAN wiring the requirements apply in accordance with the standards EN 50173 and EN 50174-1/2. As minimum requirement the use of a protected LAN line of category 5 for 10/100 MBps Ethernet, and/or of category 5e for Gigabit Ethernet is considered. The requirements of the specification ISO/IEC 11801 are to be considered.
- Route the cables in such a way that they do not form a potential hazard and that they cannot be damaged. When connecting up a device, refer to the relevant notes in this manual.
- Never connect or disconnect data transmission lines during a storm (lightning hazard).



### CAUTION!

- Make sure that no objects (such as bracelets or paper clips) fall into or liquids spill into the device (risk of electric shock or short circuit).
- In emergencies (e.g. damaged casing, controls or cables, penetration of liquids or foreign matter), switch off the device immediately, remove the power plug from the safety socket and contact your sales outlet or customer service team.
- Proper operation of the device (in accordance with IEC 60950-1/ EN 60950-1) is only ensured if the casing is completely assembled and the rear covers for the installation openings have been put in place (electric shock, cooling, fire protection, interference suppression).
- Only install system expansions that satisfy the requirements and rules governing safety and electromagnetic compatibility and relating to telecommunications terminal equipment. If you install other expansions, you may damage the system or violate the safety regulations and regulations governing RFI suppression. Information on which system expansions are suitable can be obtained from the customer service centre or your sales outlet.
- The components or parts marked with a warning label (e.g. lightning symbol) may only be opened, removed or exchanged by authorized, qualified personnel.
- The warranty expires if the device is damaged during the installation or replacement of system expansions.
- You may only set those resolutions and refresh rates specified in the operating manual of the monitor. Otherwise, you may damage your monitor. If you are in any doubt, contact your sales outlet or customer service centre.

### Batteries



#### CAUTION!

- Incorrect replacement of batteries may result in a risk of explosion. The batteries may only be replaced with identical batteries or with a type recommended by the manufacturer (see the Technical Manual for the system board).
- Replace the lithium battery on the system board in accordance with the instructions in the Maintenance manual.
- The battery used in this device may present a fire or chemical burn hazard if mistreated. Do not disassemble, heat about 100 °C (212F), or incinerate the battery.

### Working with CDs/DVDs and CD/DVD drives

When working with devices with CD/DVD drives, these instructions must be followed.



### CAUTION!

- Only use CDs/DVDs that are in perfect condition in your server's CD/DVD drive, in order to prevent data loss, equipment damage and injury.
- Check each CD/DVD for damage, cracks, breakages etc. before inserting it in the drive.

Note that any additional labels applied may change the mechanical properties of a CD/DVD and cause imbalance.

Damaged and imbalanced CDs/DVDs can break at high drive speeds (data loss).

Under certain circumstances, sharp CD/DVD fragments can pierce the cover of the CD/DVD drive (equipment damage) and can fly out of the device (danger of injury, particularly to uncovered body parts such as the face or neck).



You can prevent mechanical damage and damage to the CD/DVD drive, as well as premature CD/DVD wear, by observing the following suggestions:

- Only insert CDs/DVDs in the drive when needed and remove them after use.
- Store the CDs/DVDs in suitable sleeves.
- Protect the CDs/DVDs from exposure to heat and direct sunlight.



#### *Laser information*

The CD/DVD drive complies with IEC 60825-1 laser class 1.



### CAUTION!

The CD/DVD drive contains a light-emitting diode (LED), which under certain circumstances produces a laser beam stronger than laser class 1. Looking directly at this beam is dangerous.

**Never remove parts of the CD/DVD drive casing!**

## Safety instructions

---

### Modules with electrostatic-sensitive components

Systems and components that might be damaged by electrostatic discharge (ESD) are marked with the following label:



Figure 2: ESD label

When you handle components fitted with ESDs, you must observe the following points under all circumstances:

- Remove the power plug before installing or removing components containing ESDs.
- You must always discharge yourself of static charges (e.g. by touching a grounded object) before working.
- The equipment and tools you use must be free of static charges.
- Only touch the components at the positions highlighted in green (touch points).
- Do not touch any exposed pins or conductors on a component.
- Use a grounding cable designed for this purpose to connect yourself to the system unit as you install components.
- Place all components on a static-safe base.



You will find a detailed description for handling ESD components in the relevant European or international standards (DIN EN 61340-5-1, ANSI/ESD S20.20).



---

## 4 Basic procedures

This section introduces all basic procedures that might be needed to start or complete a replacement or expansion task. The individual basic procedures applicable for a replacement or expansion task are indicated in the procedure related to this task.

### 4.1 Using diagnostics information

Use the ServerView Suite to prepare the replacement of hardware components. In the event of hardware replacements due to an error message, use remote diagnostics mechanisms before going to the server site. For more information see ServerView documentation on the following topics:

- Administration and manageability
- Maintenance

Please contact your local Fujitsu service department for details on the service concept for your server as well as key data that need to be close at hand when explaining the problem, organizing the replacement, and ordering spare parts.

The following diagnostics procedures help you to perform the replacement task when you start to install the spare part.

#### 4.1.1 Locate the faulty server



##### Trained personnel

- ▶ Check the Global Error indicator and the CSS indicator at the front and rear of the server:
  - Global Error indicator (orange)
    - **Lights up orange** if a prefailure event has been detected that requires (precautionary) service intervention.
    - **Flashes orange** if an error was detected that requires service intervention.
    - **Does not light up** if there is no critical event.

If the event is still acute after a power failure, the indicator is activated after the restart.

The indicator also lights up in standby mode.

You can find more details on the indicated errors in the System Event Log (SEL), on the ServerView Local Service Panel, on the ServerView Local Service Display, in the ServerView Operations Manager or via the iRMC S2's Web interface.

- CSS indicator (yellow)
  - **Lights up yellow** if a prefailure event was detected for a CSS component that can be fixed (for reasons of precaution) with the CSS concept.
  - **Flashes yellow** if an error was detected that can be fixed with the CSS concept.
  - **Does not light up** when the system is OK.

If the event is still acute after a power failure, the indicator is activated after the restart.

The indicator also lights up in standby mode.

For information on the control elements and indicators of your server see "PRIMERGY RX900 S1 Server - Operating manual".

- ▶ Alternatively, you can check the ServerView Local Service Display. For more information see the "ServerView Suite Local Service Concept - LSC" manual and the "Customer Self Service (CSS)" manual on the ServerView Suite DVD 2.

## 4.1.2 Locate the faulty component by PRIMERGY diagnostics indicators



### Authorized personnel

Authorized specialist personnel can carry out replacement tasks for integral server components. Ask your local Fujitsu service center for more detailed information.



### CAUTION!

Procedures indicated as "Authorized personnel only" must be done by Fujitsu service personnel or technicians trained by Fujitsu for doing these tasks. Please note that unauthorized interference with the system will void the warranty and exempt the manufacturer from all liability.

If the system has been powered off to replace a non-hot-plug unit, a system of PRIMERGY diagnostics indicators guides you to the faulty component.

For the RX900 S1, it is possible to turn on the local diagnostics indicators for 40 s even if AC power is lost for 24 hours.

For more information see the "ServerView Suite Local Service Concept - LSC" manual and the "Customer Self Service (CSS)" manual on the ServerView Suite DVD 2.

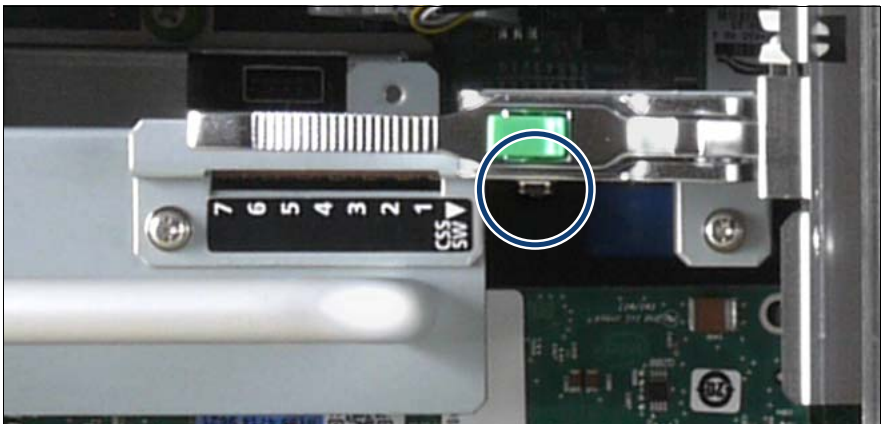

Figure 3: CSS button on the PCI Riser

## Basic procedures

---

- ▶ Press the CSS button located on the PCI Riser (PCIR).
- ▶ The PRIMERGY diagnostics indicator of the faulty unit will light up.  
For information on the control elements and indicators of your server see "PRIMERGY RX900 S1 Server - Operating manual" and "Baseboard D3081, CPUMEMR D3131, PCIR D3082 for PRIMERGY RX900 S1 Technical Manual".
- ▶ Take a note on the faulty component indicated by the indicator:
  - Number of the component
  - Faulty component
  - For DIMM memory modules: Identifier of the slot

## 4.2 Opening the rack door



### Trained personnel

For information on how to open the front and rear doors of the rack see "PRIMECENTER, Rack System for PRIMERGY, PRIME POWER, BS2000, STORAGE".

## 4.3 Shutting down the server



### Authorized personnel

Authorized specialist personnel can carry out replacement tasks for integral server components. Ask your local Fujitsu service center for more detailed information.



### CAUTION!

Procedures indicated as "Authorized personnel only" must be done by Fujitsu service personnel or technicians trained by Fujitsu for doing these tasks. Please note that unauthorized interference with the system will void the warranty and exempt the manufacturer from all liability.



### CAUTION!

Follow the safety instructions in the ["Safety instructions" on page 31](#).



This step is only applicable to replace or expand non-hot plug components.

- ▶ Terminate all applications and shut down the server correctly.
- ▶ If your operating system has not switched off the server, press the On/Off button.
- ▶ Pull all power cords out of the power outlets.

## 4.4 Sliding the server out of the rack



Trained personnel



### CAUTION!

- Use the anti-tilt plate to prevent the rack from tipping when installing the rack. Pulling the server out of the rack without having installed the anti-tilt plate may cause the rack to tip over.
- Be careful not to pinch fingers or clothes when sliding out the server or pushing it back. Failure to do so may cause injury.
- Follow the safety instructions in the [chapter "Safety instructions" on page 31](#).

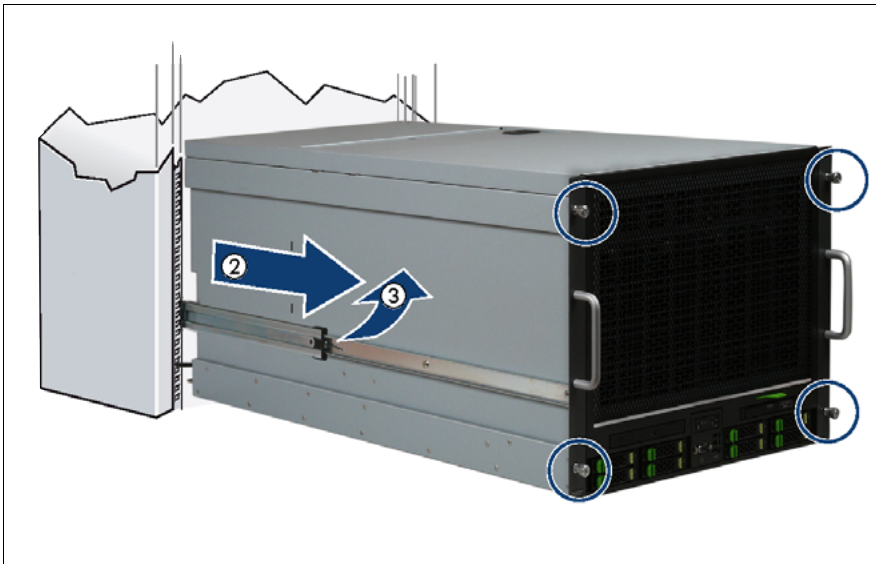

Figure 4: Removing the server

- ▶ Loosen the knurled screws (see circle).

- ▶ Pull the server carefully out of the rack as far as possible (2).



### CAUTION!

Do not use the pulled-out server as a surface on which to put things or as a work surface, and strictly avoid leaning on or against it.

### Removing the server from the rack (if applicable)



### CAUTION!

Due to the heavy weight, it is mandatory to use a suitable lifter for removing the RX900 S1 from the rack.

Do not use the front handles to raise the server as they are not designed to bear the weight of the unit. The front handles are only to be used for pushing the server into the rack or pulling it out of the rack.

- ▶ Slide the server onto the lifter platform.



### CAUTION!

Due to the heavy weight, a suitable lifter is required to remove the server from the rack. Make sure that the lifter is locked in place before you start to slide the server.

- ▶ Release the locking mechanism of both rails (3).
  - Left side of the server: Push upwards
  - Right side of the server: Push downwards
- ▶ Slide the inner part of the rail mounted on the server out of the middle part of the rail as far as possible. The server will now be placed on the lifter.

## 4.5 Opening the server



### Trained personnel



### CAUTION!

- Only for non-hot plug components:  
Before removing or installing covers, turn off the server, all peripheral devices, and any other connected devices. Also unplug all power cables from the outlet. Failure to do so can cause electric shock.
- The housing covers must be replaced as soon as possible for purposes of cooling, to comply with EMC regulations (regulations regarding electromagnetic compatibility) and to prevent fires. The housing covers must not remain open for longer than 5 minutes.
- Follow the safety instructions in the [chapter "Safety instructions" on page 31](#).

The server is accessible via three covers, see [figure 5](#), that can be removed independently from each other:

1. Front cover, see ["Removing the front cover" on page 45](#)
2. Fan cover, see ["Opening the fan cover" on page 102](#)
3. Rear cover, see ["Removing the rear cover" on page 46](#)

You can remove the fan cover as such for accessing the fans directly. For all other tasks, it is removed together with the front cover.



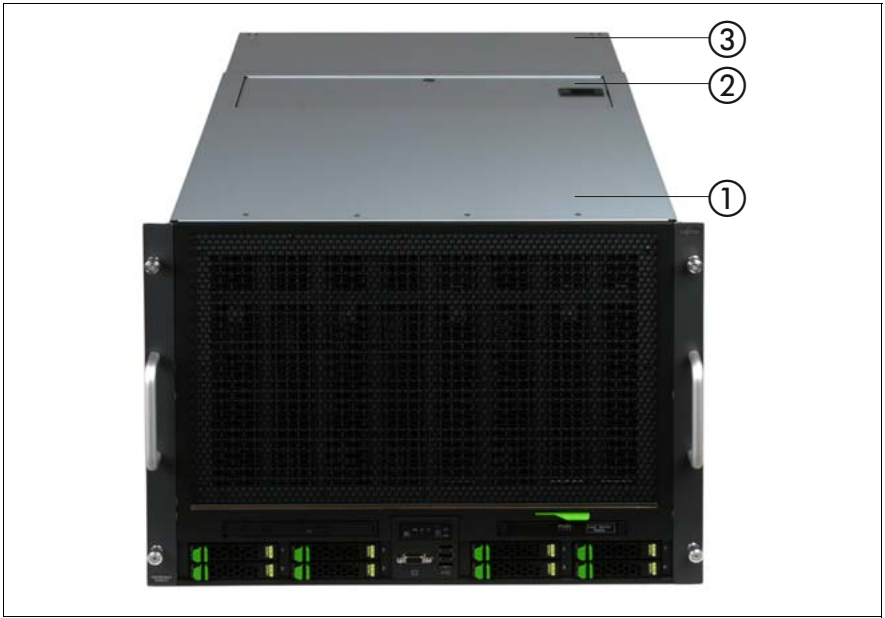

Figure 5: Front cover (1), fan cover (2), and rear cover (3)

### 4.5.1 Removing the front cover



Figure 6: Removing the front cover

## Basic procedures

---

- ▶ Loosen the captive screw on the cover (see circle).
- ▶ Push the front cover back by approximately 1 cm.
- ▶ Remove the front cover by lifting it upward.

### 4.5.2 Removing the rear cover



Figure 7: Removing the rear cover

- ▶ Loosen the captive screws on the rear cover (see circle).
- ▶ Push the rear cover back by approximately 1 cm.
- ▶ Remove the cover by lifting it upward.

## 4.6 Closing the server



Trained personnel



### CAUTION!

- Before attaching the covers, make sure no unnecessary parts or tools are left inside the server.
- The housing covers must be replaced as soon as possible for purposes of cooling, to comply with EMC regulations (regulations regarding electromagnetic compatibility) and to prevent fires.
- Follow the safety instructions in the [chapter "Safety instructions" on page 31](#).

The three covers of the server can be closed independently of each other:

1. Front cover, see ["Installing the front cover" on page 47](#)
2. Fan cover, see ["Closing the fan cover" on page 104](#)
3. Rear cover, see ["Installing the rear cover" on page 48](#)

### 4.6.1 Installing the front cover



Figure 8: Installing the front cover

## Basic procedures

---

- ▶ Place the front cover onto the server such that there is approximately 1 cm distance to the front.
- ▶ Push the front cover as far as possible in the direction of the arrow.
- ▶ Fasten the captive screw on the cover (see circle).

### 4.6.2 Installing the rear cover



Figure 9: Installing the rear cover

- ▶ Place the rear cover onto the server such that it projects approximately 1 cm at the back.
- ▶ Push the rear cover as far as possible in the direction of the arrow.
- ▶ Fasten the captive screws on the cover (see circles).

## 4.7 Mounting the server in the rack



Trained personnel

### Inserting the server (if applicable)



Figure 10: Inserting the server

- ▶ Pull the middle parts of the rails out of the rack completely until they click into place (1).



The middle parts of the rails must click into place so that they can no longer be moved.

- ▶ Place the server in module direction as close as possible in front of the rack and lift it to the mounting position.



### CAUTION!

Due to the heavy weight, a suitable lifter is required to lift the server to the mounting position. Make sure that the lifter is locked in place before you start to mount the server.

## Basic procedures

---

- ▶ Insert the inner parts of the rails that are mounted on the server into the protruding middle parts until the rails engage (2).
- ▶ Release the locking mechanism of both rails (3).
  - Left side of the server: Push upwards
  - Right side of the server: Push downwards
- ▶ Lower the lifter platform and slide the server into the rack (4). Remove the lifter.



### CAUTION

Do not use the front handles to raise the server as they are not designed to bear the weight of the unit. The front handles are only to be used for pushing the server into the rack or pulling it out of the rack.

### Sliding the Server into the rack

- ▶ Slide the server into the rack.
- ▶ Fasten the server to the rack with the four knurled screws on the front panel and the cage nuts, see (5) in [figure 10](#).
- ▶ Route the cables as described in the Technical manual for the rack in question.

## 4.8 Bringing the server back to operation



### Authorized personnel

Authorized specialist personnel can carry out replacement tasks for integral server components. Ask your local Fujitsu service center for more detailed information.



### CAUTION!

Procedures indicated as "Authorized personnel only" must be done by Fujitsu service personnel or technicians trained by Fujitsu for doing these tasks. Please note that unauthorized interference with the system will void the warranty and exempt the manufacturer from all liability.



### CAUTION!

- Before turning on the server, make sure the covers are closed.
- Follow the safety instructions in [chapter "Safety instructions" on page 31](#).



This step is only applicable to replace or expand non-hot plug components.

- ▶ Connect all cables on the rear of the server.
- ▶ Connect all power cords to the power outlets.
- ▶ Press the On/Off button to start up the server.

## 4.9 Closing the rack door



### Trained personnel

For information on how to close the front and rear doors of the rack see "PRIMECENTER, Rack System for PRIMERGY, PRIME POWER, BS2000, STORAGE".





---

## 5 Power supply



### CAUTION!

The server supports a mains voltage in the range of 200 - 240 V. You may only operate the server if its rated voltage range corresponds to the local mains voltage.



Phase redundancy is possible in regions, where a single phase provides 200 - 240V; in other regions with lower single phase voltage, two phases must be coupled and complete phase redundancy thus is not possible.

In the basic configuration, the server is configured with three hot-plug power supply units. This ensures 2 + 1 power supply redundancy. One additional hot-plug power supply unit can be installed to achieve AC redundancy in a 2+2 configuration. For more information on the redundancy concept see "PRIMERGY RX900 S1 Server Operating Manual".



### CAUTION!

- Areas around the power supply unit may remain extremely hot after shutdown. Wait for a while after shutdown before removing the power supply unit.
- When installing the power supply unit, be sure to confirm that the connector of the PSU is not damaged or bent.
- Do not insert your hands in the power supply unit slot when removing the power supply unit. Doing so may cause electric shock.
- If the power supply unit is hard to remove, do not pull out it by force.
- The power supply unit is heavy, so handle it carefully. If you drop it by mistake, injuries may result.

# 5.1 Installing a hot-plug Power Supply Unit (PSU)



Trained personnel

## 5.1.1 Required tools

- Starting and completing the task:
  - key for the rack doors (if applicable)
- Installing the power supply unit: tool-less

## 5.1.2 Starting the task

- ▶ Perform the following procedures:
  1. Open the rear door of the rack, see ["Opening the rack door" on page 40](#)

## 5.1.3 Removing a dummy module (if applicable)



Dummy modules protect free bays against environmental impact. Remove the dummy module before installing an additional power supply unit.



Figure 11: Removing a dummy module from a PSU bay

- ▶ Press the two plastic clips together as indicated by the arrows and remove the dummy module.



### CAUTION!

Keep the dummy module for future use. If the power supply unit is removed and not replaced with a new unit, the dummy module must be reinstalled due to cooling, to comply with applicable EMC regulations (regulations on electromagnetic compatibility), and to protect against fire.

## 5.1.4 Installing a power supply unit

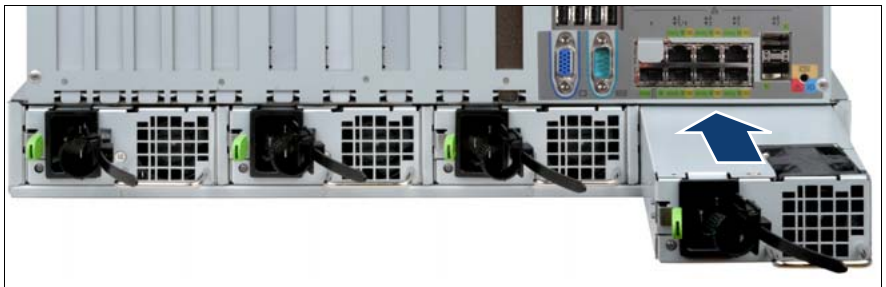

Figure 12: Installing a power supply unit

- ▶ Slide the power supply unit into the empty bay until it clicks into place.
  - i** Make sure that the power supply unit engages correctly in the mounting location and is locked in position. This is the only way to prevent the power supply unit from sliding out of its mountings and being damaged during transportation.

### 5.1.5 Connecting the power cord

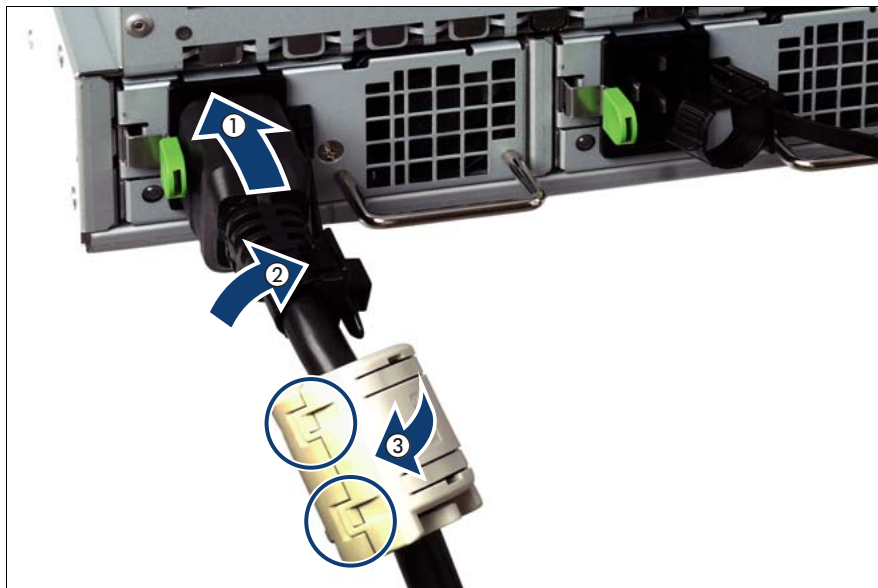

Figure 13: Connecting the power cord and the ferrite core

- ▶ Thread the cable through the cable strap.
- ▶ Pull the cable strap tight to secure the power cord.
- ▶ Connect the newly installed power supply unit to the mains.
- ▶ Check whether the power supply unit works properly.

The PSU works properly when the indicator (1) in [figure 14](#) lights green. For more information see „PRIMERGY RX900 S1 Server - Operating manual“.



Figure 14: Indicators on the power supply unit

### 5.1.6 Completing the task

► Perform the following procedures to complete the task:

1. Close the rear door of the rack, see ["Closing the rack door" on page 51](#)

## 5.2 Replacing a hot-plug power supply unit



**Trained personnel**



### **CAUTION!**

When replacing a **non-defective** hot-plug power supply unit in a non-redundant configuration, the server **must** be switched off first.

### 5.2.1 Required tools

- Starting and completing the task:
  - key for the rack doors (if applicable)
- Replacing the power supply unit: tool-less

### 5.2.2 Starting the task

- ▶ Perform the following procedures:
  1. Open the rear door of the rack, see ["Opening the rack door" on page 40](#)
  2. ["Locate the faulty server" on page 37](#)
  3. Only when replacing a **non-defective** hot-plug power supply unit in a non-redundant configuration: ["Shutting down the server" on page 41](#)
  4. ["Locate the faulty component by PRIMERGY diagnostics indicators" on page 39](#)

### 5.2.3 Removing the power supply unit



Figure 15: Unlocking and removing the power supply unit

- ▶ Remove the power cord from the cable strap. You can loosen the cable strap by opening the small locking lever.
- ▶ Remove the power cord from the installed power supply unit.
- ▶ Press the green release lever (1) and pull out the power supply unit in the direction of the arrow (2). Grip the handle while pulling the power supply.
- ▶ Completely remove the defective power supply unit from the bay.



#### **CAUTION!**

Never leave the bay for the power supply unit empty for more than two minutes during operation. Otherwise, excessive temperatures could damage system components.

## 5.2.4 Reinstalling the PSU

- ▶ Insert the new power supply unit into the bay as described in ["Installing a hot-plug Power Supply Unit \(PSU\)" on page 54](#).



Make sure that the power supply unit engages correctly in the mounting location and is locked in position. This is the only way to prevent the power supply unit from sliding out of its mountings and being damaged during transportation.

## 5.2.5 Completing the task

- ▶ Perform the following procedures to complete the task:
  1. Only when replacing a **non-defective** hot-plug power supply unit in a non-redundant configuration: ["Bringing the server back to operation" on page 51](#)
  2. Close the rear door of the rack, see ["Closing the rack door" on page 51](#)

## 5.3 Removing a redundant hot-plug power supply unit



**Trained personnel**

### 5.3.1 Required tools

- Starting and completing the task:
  - key for the rack doors (if applicable)
- Removing the redundant power supply unit: tool-less

### 5.3.2 Starting the task

- ▶ Perform the following procedures:
  1. Open the rear door of the rack, see ["Opening the rack door" on page 40](#)

### 5.3.3 Removing the power supply unit



Figure 16: Unlocking and removing the power supply unit

- ▶ Remove the power cord from the cable strap. You can loosen the cable strap by opening the small locking lever.
- ▶ Remove the power cord from the installed power supply unit.
- ▶ Press the green release lever (1) and pull out the power supply unit in the direction of the arrow (2). Grip the handle while pulling the power supply.
- ▶ Completely remove the defective power supply unit from the bay.



#### **CAUTION!**

Never leave the bay for the power supply unit empty for more than two minutes during operation. Otherwise, excessive temperatures could damage system components.



### 5.3.4 Installing a dummy module



Dummy modules protect free bays against environmental impact.



Figure 17: Installing a dummy module in a PSU bay

- ▶ Press the two plastic clips together as indicated by the arrows and install the dummy module.

### 5.3.5 Completing the task

- ▶ Perform the following procedures to complete the task:
  1. Close the rear door of the rack, see ["Closing the rack door" on page 51](#)

# 5.4 Replacing the power distribution board



### Authorized personnel

Authorized specialist personnel can carry out replacement tasks for integral server components. Ask your local Fujitsu service center for more detailed information.



### CAUTION!

Procedures indicated as "Authorized personnel only" must be done by Fujitsu service personnel or technicians trained by Fujitsu for doing these tasks. Please note that unauthorized interference with the system will void the warranty and exempt the manufacturer from all liability.

## 5.4.1 Required tools

- Starting and completing the task:
  - key for the rack doors (if applicable)
  - Phillips Ph2 screw driver
- Replacing the power distribution board:
  - Phillips Ph2 screw driver

## 5.4.2 Starting the task

- ▶ Perform the following procedures:
  1. ["Opening the rack door" on page 40](#)
  2. ["Locate the faulty server" on page 37](#)
  3. ["Shutting down the server" on page 41](#)
  4. ["Sliding the server out of the rack" on page 42](#)
  5. ["Opening the server" on page 44](#)
  6. Remove all PSUs, see ["Removing the power supply unit" on page 58](#)

7. Remove all CPUMEMRs, see ["Removing the CPUMEMR" on page 190](#)

**i** Before removing the CPUMEMRs, take a note on the installation slot number for each CPUMEMR. Make sure that you reinstall the CPUMEMR in the slot it was located before the replacement.

8. Remove all expansion cards and dummy modules in PCIe slots #8 to #17, see ["Expansion cards and BBU" on page 105](#)

**i** Before removing the expansion cards, take a note on the installation slot number for each card. Make sure that you reinstall the card in the slot it was located before the replacement.

9. Remove the PCI Riser, see ["Expansion cards and BBU" on page 105](#)

10. Remove the BBU holder, see ["Expansion cards and BBU" on page 105](#)

### 5.4.3 Sliding the local service display outward

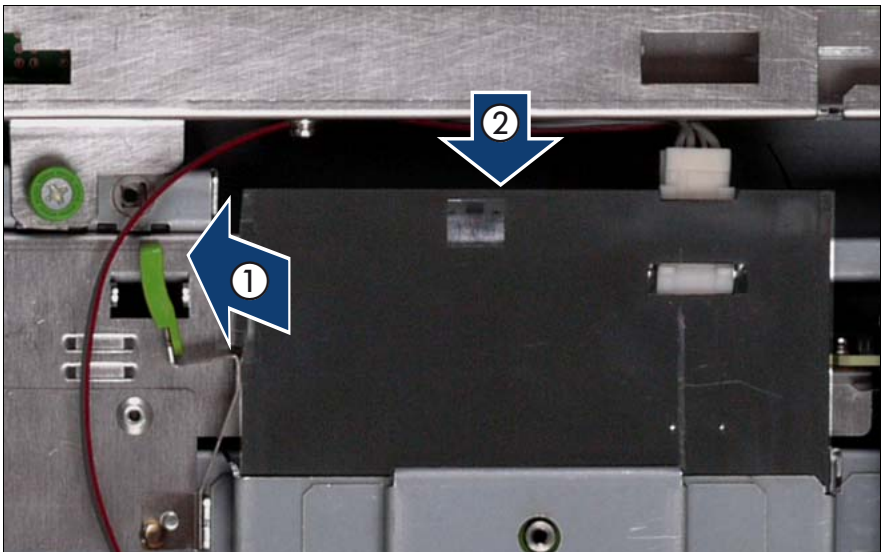

Figure 18: Sliding the local service display outward

- ▶ Unlock the local service display (1).
- ▶ Slide the local service display outward a few centimeters so that you have free access (2).

### 5.4.4 Disconnecting the cables

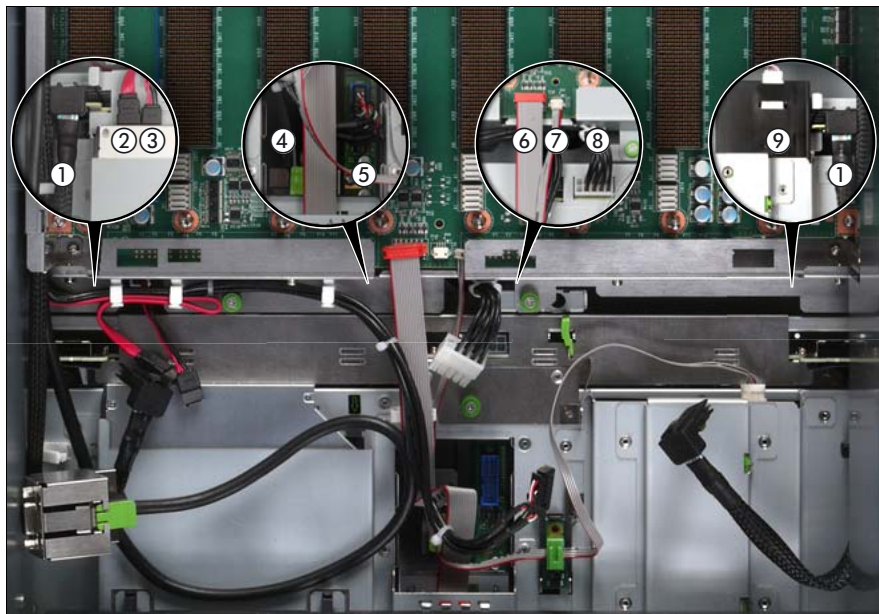

Figure 19: Disconnecting the cables from the baseboard

- ▶ Disconnect the following cables from the baseboard:
  - SAS backplane cable (1)
  - Signalling cable (2) and power cable (3) to the optical drive
  - Front video connector cable (4)
  - Front USB cable (5)
  - Control panel cable (6)
  - Chassis ID cable (7)
  - Power cable for the SAS backplane (8)

For the cable plan see "[Cabling](#)" on page 367.

## 5.4.5 Removing the fan cage

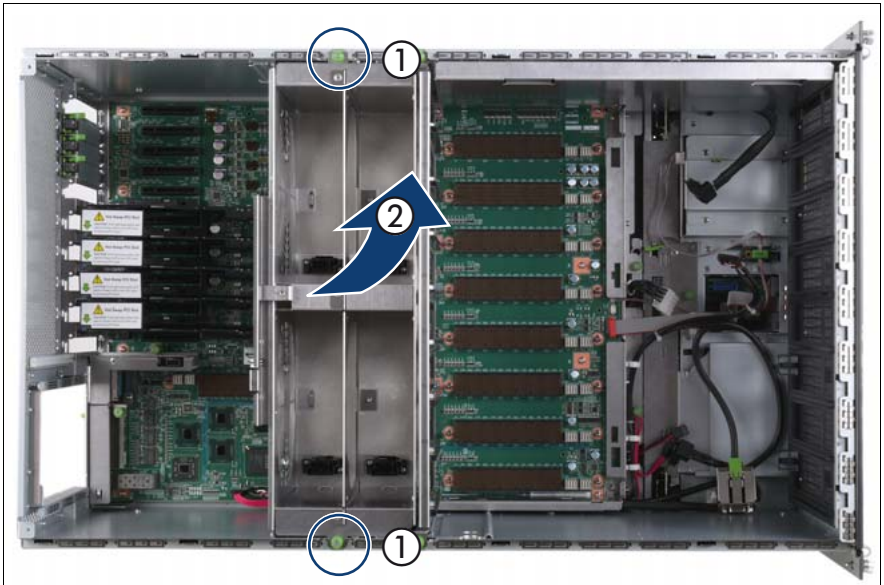

Figure 20: Removing the fan cage

- ▶ Loosen the captive screws (1).
- ▶ Lift the fan cage out of the chassis (2).

### 5.4.6 Removing the CPUMEMR guide

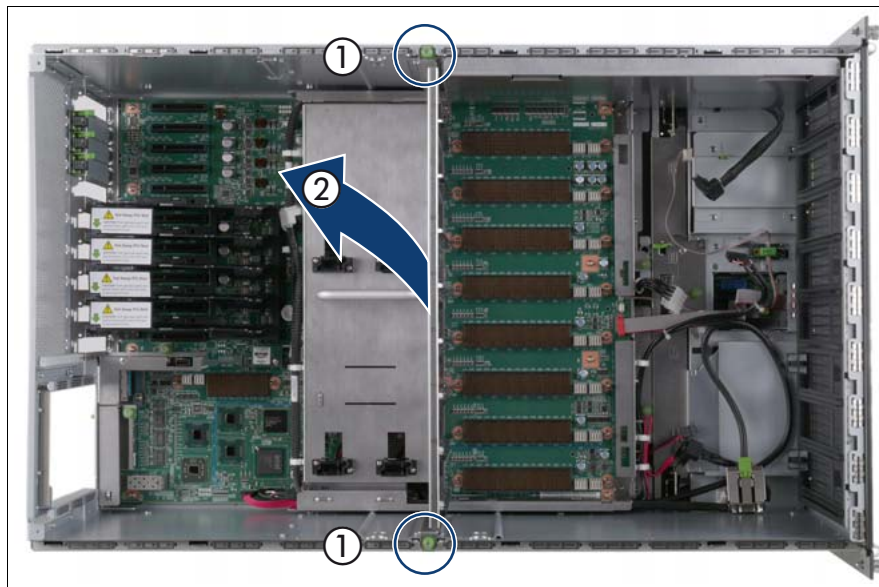

Figure 21: Removing the CPUMEMR guide

- ▶ Loosen the captive screws of the CPUMEMR guide (1).
- ▶ Lift the CPUMEMR guide out of the chassis (2).

## 5.4.7 Removing the air guide

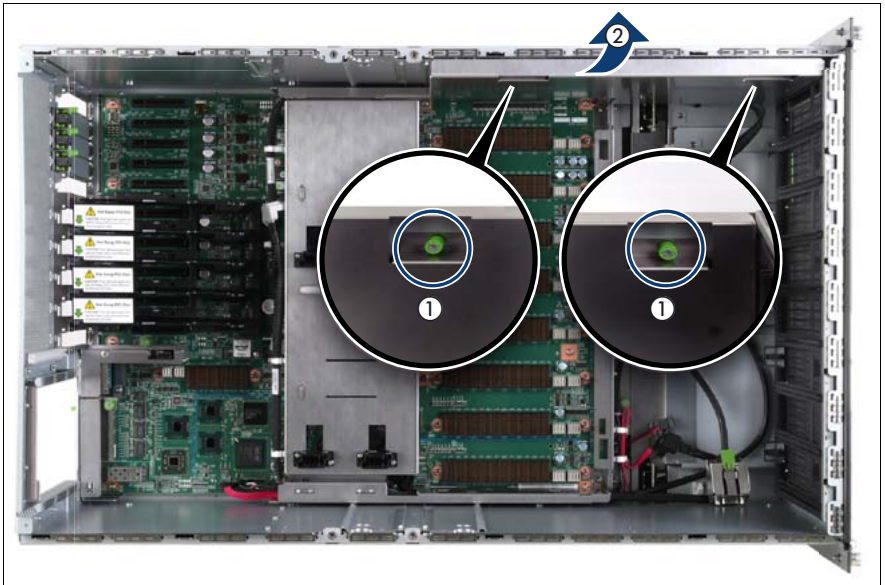

Figure 22: Removing the air guide

- ▶ Loosen the captive screws (1).
- ▶ Lift the air guide out of the chassis (2).



## 5.4.8 Removing the baseboard

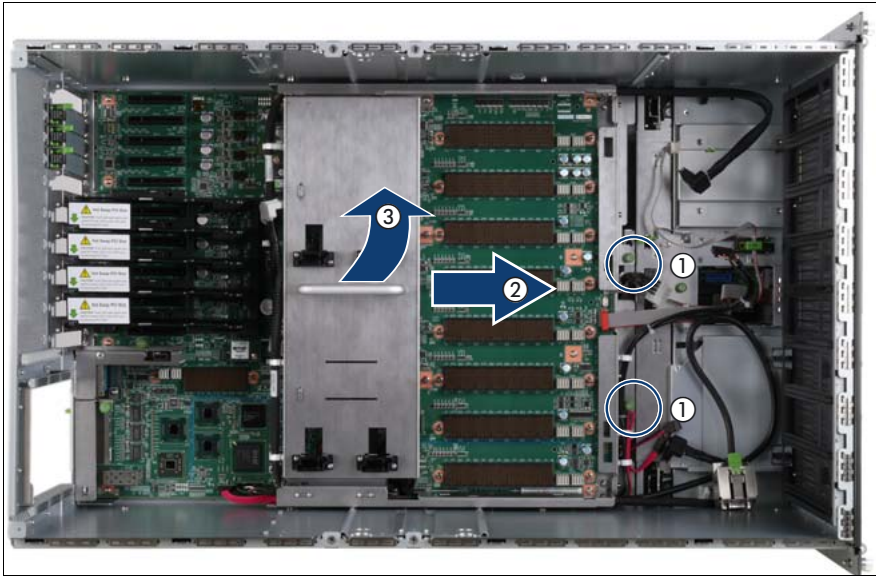

Figure 23: Removing the baseboard

- ▶ Loosen the captive screws (1).
- ▶ Slide the baseboard approximately 1 cm in the direction of the arrow (2).



**CAUTION!**

Make sure that you have removed all power supply units before removing the baseboard. Otherwise, the power supply units or the power distribution board might be damaged.

- ▶ Carefully lift the baseboard out of the chassis by using the handle (3).



## 5.4.9 Removing the power distribution board

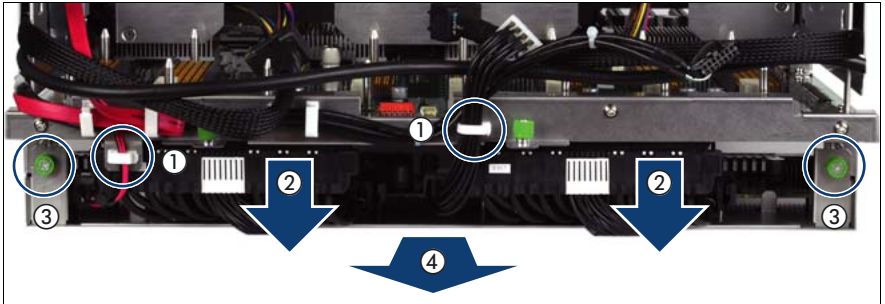

Figure 24: Removing the power distribution board

- ▶ Open the cable clamps (1).
- ▶ Disconnect the power cables from the baseboard (2).
- ▶ Loosen the captive screws (3).
- ▶ Remove the power distribution board from the baseboard.

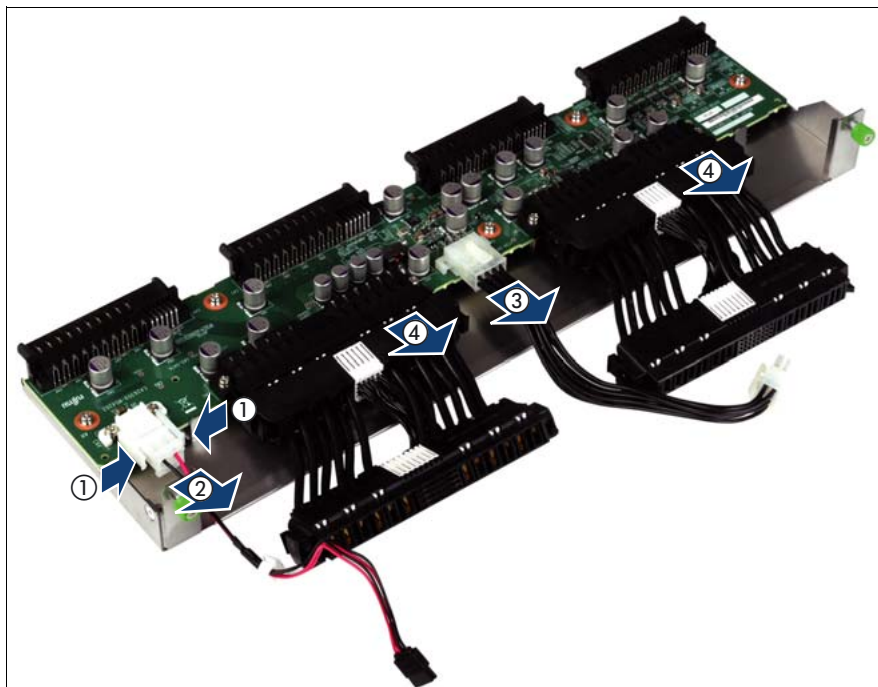

Figure 25: Disconnecting the power cables

- ▶ Disconnect the following cables from the power distribution board:
  - Power cable of the optical drive (1, 2)
  - Power cable for the SAS backplane (3)
  - Power distribution cables (4)

## 5.4.10 Installing the power distribution board

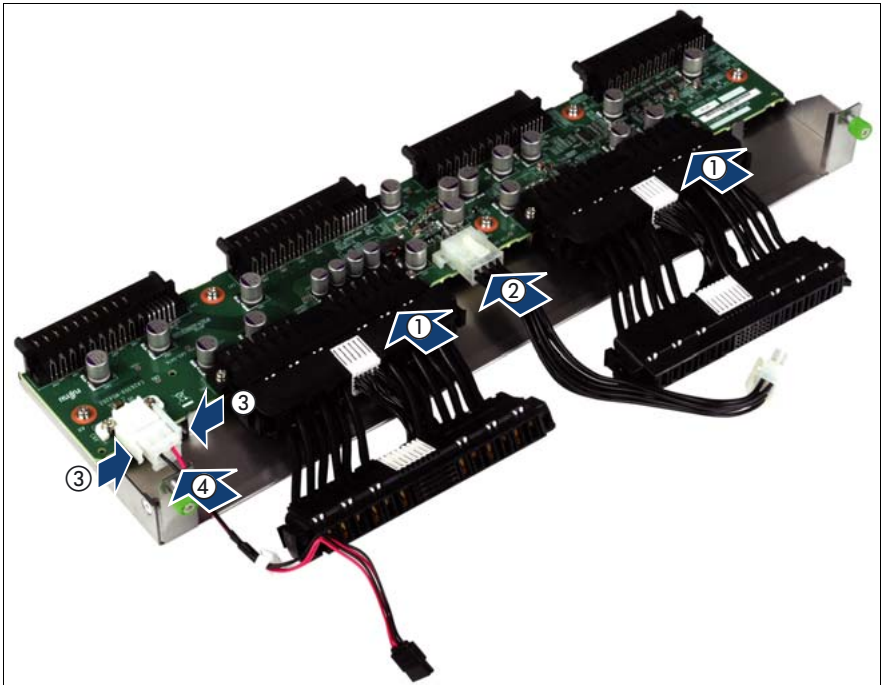

Figure 26: Connecting the power cables

- ▶ Connect the following cables to the power distribution board:
  - Power distribution cables (1)
  - Power cable for the SAS backplane (2)
  - Power cable of the optical drive (3, 4)

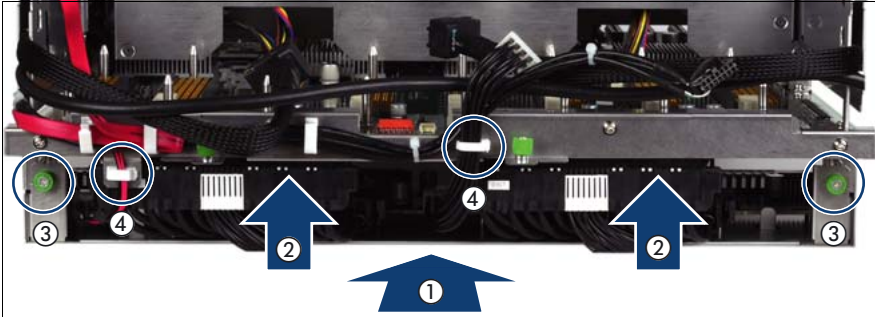

Figure 27: Installing the power distribution board

- ▶ Insert the power distribution board in the baseboard (1).
- ▶ Connect the power cables to the baseboard (2).
- ▶ Fasten the captive screws (3).
- ▶ Close the cable clamps (4).

### 5.4.11 Inserting the baseboard

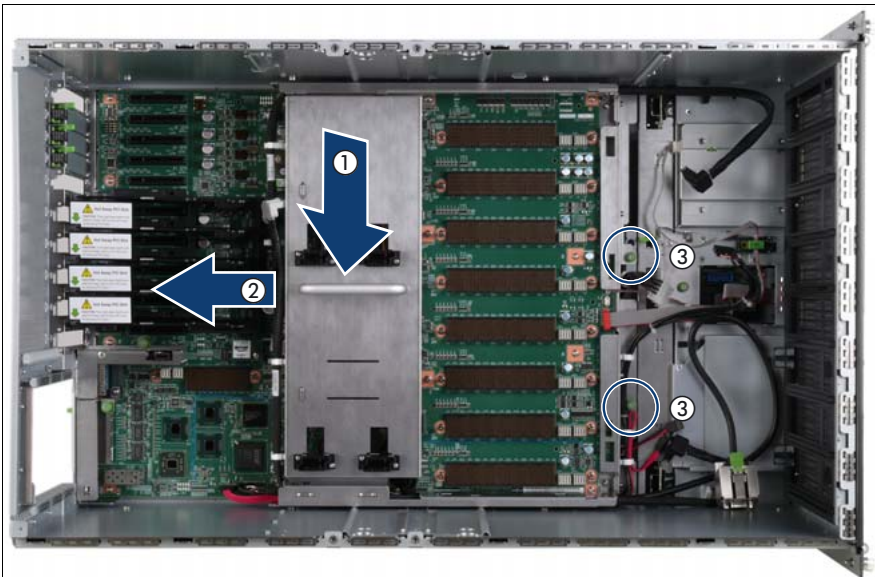

Figure 28: Inserting the baseboard

- ▶ Carefully lower the baseboard in the chassis by using the handle (1).
- ▶ Slide the baseboard in the direction of the arrow (2) until it clicks into place.
- ▶ Fasten the captive screws (3).



**CAUTION!**

Ensure not to damage the EMI springs to comply with applicable EMC regulations and satisfy cooling requirements and fire protection measures.

### 5.4.12 Installing the air guide

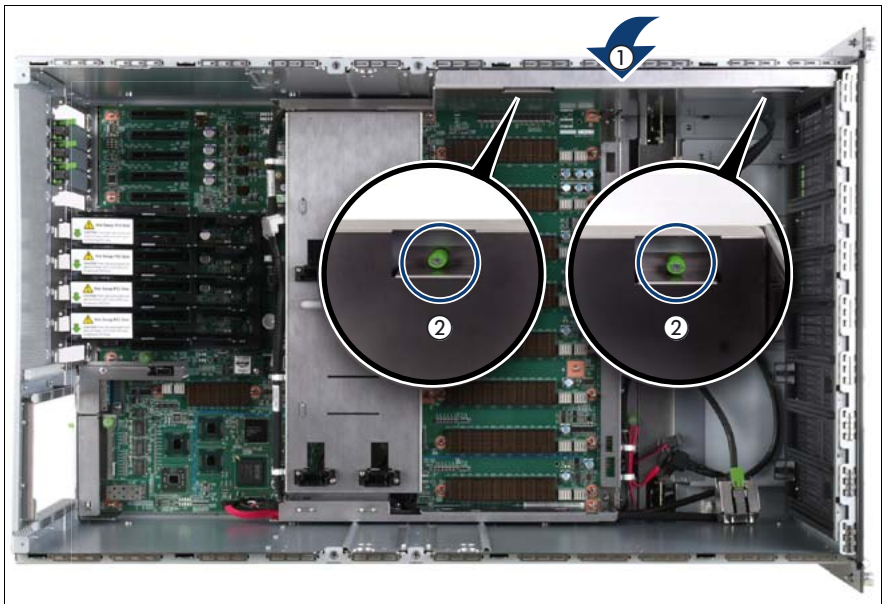

Figure 29: Installing the air guide

- ▶ Place the air guide in the chassis (1).
- ▶ Fasten the captive screws (2).

### 5.4.13 Inserting the CPUMEMR guide

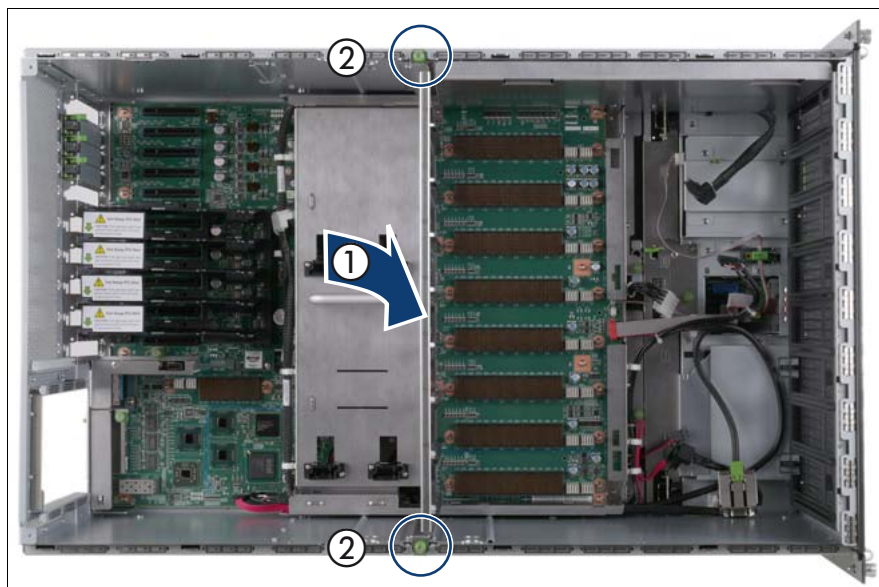

Figure 30: Inserting the CPUMEMR guide

- ▶ Insert the CPUMEMR guide in the installation slot (1).
- ▶ Fasten the captive screws of the CPUMEMR guide (2).

## 5.4.14 Inserting the fan cage

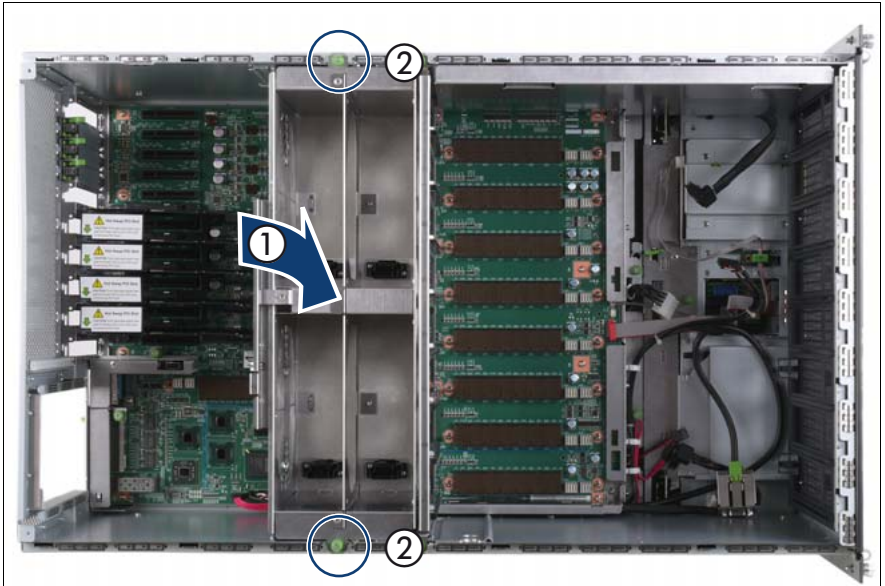

Figure 31: Inserting the fan cage

- ▶ Insert the fan cage in the mounting bay (1).
- ▶ Fasten the captive screws (2).



### 5.4.15 Connecting the cables to the baseboard

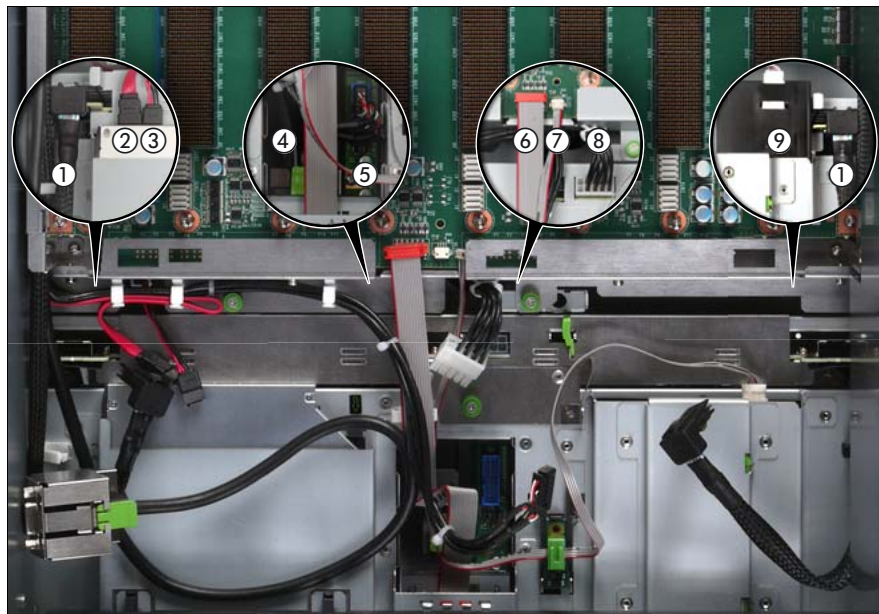

Figure 32: Connecting the cables to the baseboard

- ▶ Connect the following cables to the baseboard:
  - SAS backplane cable (1)
  - Signalling cable (2) and power cable (3) to the optical drive
  - Front video connector cable (4)
  - Front USB cable (5)
  - Control panel cable (6)
  - Chassis ID cable (7)
  - Power cable to the SAS backplane (8)

For the cable plan see ["Cabling" on page 367](#).



## 5.4.16 Sliding the local service display inward

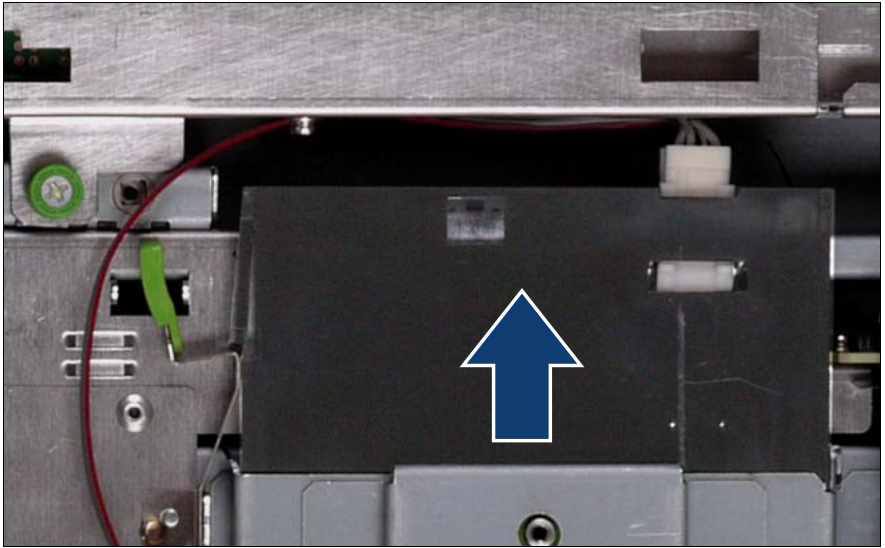

Figure 33: Sliding the local service display inward

- ▶ Slide the local service display inward until it clicks into place.

## 5.4.17 Completing the task

- ▶ Perform the following procedures to complete the task:
  1. Install the BBU holder, see ["Expansion cards and BBU" on page 105](#)
  2. Install the PCI Riser, see ["Expansion cards and BBU" on page 105](#)
  3. Install all expansion cards and dummy modules in PCIe slots #8 to #17, see ["Expansion cards and BBU" on page 105](#)
    - i** Make sure that you reinstall each card in the slots it was located before the replacement.
  4. Install all CPUMEMRs, see ["Removing the CPUMEMR" on page 190](#)
    - i** Make sure that you reinstall each CPUMEMR in the slot it was located before the replacement.
  5. Install all PSUs, see ["Installing a power supply unit" on page 55](#)

## Power supply

---

6. ["Closing the server" on page 47](#)
  7. ["Mounting the server in the rack" on page 49](#)
  8. ["Bringing the server back to operation" on page 51](#)
  9. ["Closing the rack door" on page 51](#)
- ▶ Verify the settings on the baseboard, see the "Baseboard D3081, CPUMEMR D3131, PCIR D3082 for PRIMERGY RX900 S1 Technical Manual" for a detailed description.

---

## 6 Hard disk and solid state drives

The hard disk drives which can be ordered for the PRIMERGY RX900 S1 are supplied already mounted in an installation frame so that defective hard disk drives can be replaced and new hard disk drives can be added during operation. The hard disk drive/solid state drive and the installation frame together make up the HDD/SSD module.

This section provides information on how to install or remove HDD/SSD modules and how to replace the SAS backplane. For information on SAS RAID controllers controlling the HDD/SSD modules see "[Expansion cards and BBU](#)" on page 105.



### CAUTION!

- The hard disk drive must not be removed from the installation frame by anyone except a service technician.
- The HDD/SSD modules (drives) must all be marked clearly so that they can be put back in their original places after an upgrade. If this is not done, existing data can be lost.
- The hot-plug function is only possible in conjunction with a corresponding RAID configuration.

Further information about the RAID configuration or RAID level can be found in the RAID controller documentation.

- Do not touch the circuitry on boards or soldered parts. Hold the metallic areas or the edges of the circuit boards.
- Before removing the unit, wait for about 30 seconds until the disk stops spinning completely.
- When the hard disk unit is starting up, you may hear a resonant noise for a while, but this does not mean a failure.
- Depending on the OS, you can configure the write cache settings for the hard disk drives. If a power failure should occur while the write cache is enabled, cached data may be lost.
- When disposing of, transferring, or returning a hard disk unit, wipe out the data on the drive for your own security.

- Rough handling of hard disk units can damage the stored data. To cope with any unexpected problems, always back up important data. When backing up data to another hard disk drive, you should make backups on a file or partition basis.
- Be careful not to hit the hard disk unit or bring it into contact with metallic objects.
- Use the device on a shock and vibration free surface.
- Do not use the unit in extremely hot or cold locations, or locations with extreme temperature changes.
- Never attempt to disassemble the hard disk unit.

## 6.1 Installing the HDD/SSD module



**Trained personnel**

### 6.1.1 Required tools

- Starting and completing the task:
  - key for the rack doors (if applicable)
- Installing the HDD/SSD module: tool-less

### 6.1.2 Starting the task

- ▶ Perform the following procedures:
  1. ["Opening the rack door" on page 40](#)

### 6.1.3 Removing the dummy module

Dummy modules protect free bays against environmental impact. Remove the dummy module before installing an additional HDD/SSD module.

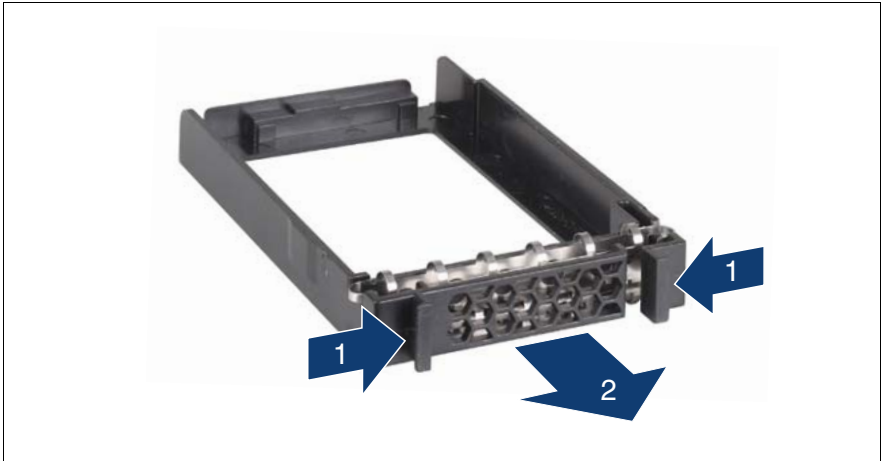

Figure 34: Removing/installing the 2.5-inch dummy module

- ▶ Press both tabs on the dummy module together until the locking mechanism disengages (1).
- ▶ Pull the dummy module out of the bay (2).



#### CAUTION!

Store the dummy module in a safe place. If you have removed an HDD/SSD module and do not install a new one in its place, put the dummy module back in its place for cooling, to comply with EMC regulations (regulations regarding electromagnetic compatibility), and for protection against fire. Ensure that the dummy module engages correctly in the bay.

### 6.1.4 Unlocking the HDD/SSD module

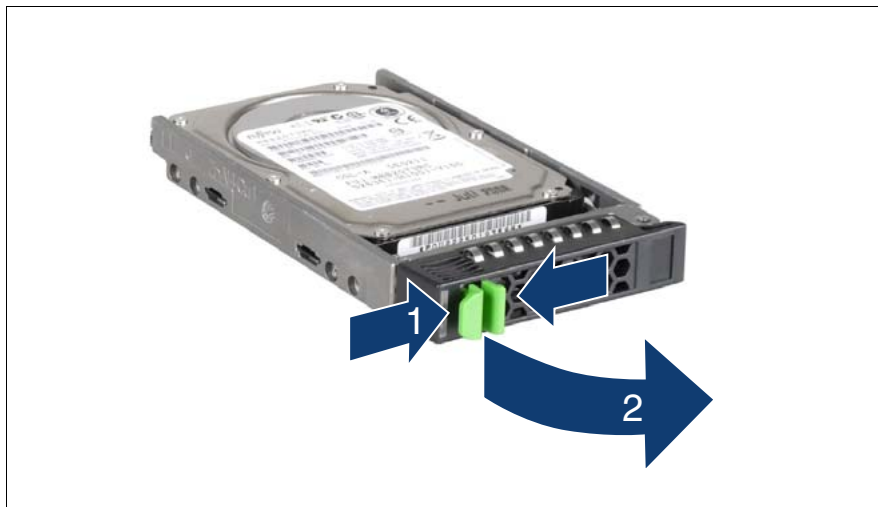

Figure 35: Unlocking the 2.5-inch HDD/SSD module

- ▶ Release the locking mechanism as follows:
  1. Press the two green tabs of the locking lever together (1).
  2. Push the handle of the HDD/SSD module fully in the direction of the arrow (2). The HDD/SSD module is now unlocked.

## 6.1.5 Inserting the HDD/SSD module

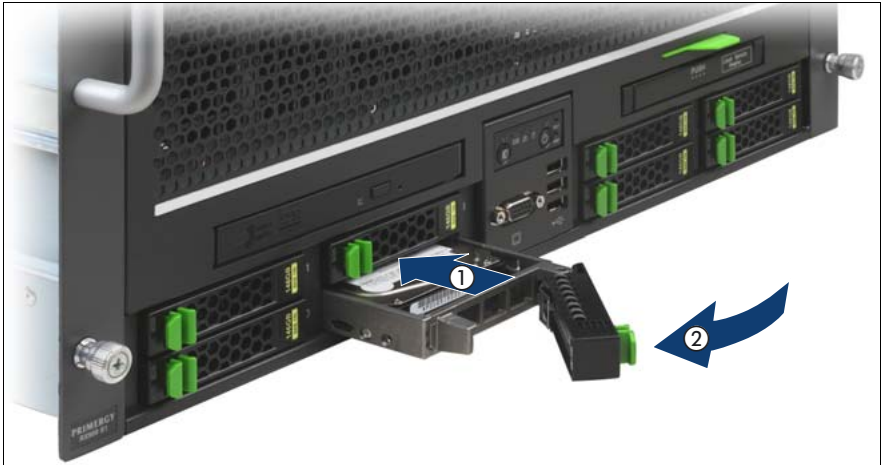

Figure 36: Installing the 2.5-inch HDD/SSD module

- ▶ Carefully push the HDD/SSD module into the empty bay (1) until it stops.
- ▶ Push the handle completely (2) in the direction of the arrow until the locking mechanism engages.

## 6.1.6 Completing the task

- ▶ Perform the following procedures to complete the task:
  1. ["Closing the rack door" on page 51](#)

## 6.2 Replacing the HDD/SSD module



**Trained personnel**



### **CAUTION!**

- Only remove an HDD/SSD module during operation if the drive is not currently being accessed. Observe the indicators for the corresponding HDD/SSD modules, see "PRIMERGY RX900 S1 Server - Operating manual".
- Under no circumstances should you remove an HDD/SSD module while the system is in operation if you are not sure that the drive is operated by a RAID controller and belongs to a disk array that is operating in RAID level 1, 1E, 10, 5, 50, 6 or 60.

An HDD/SSD module can only be replaced during operation in conjunction with a corresponding RAID configuration.

- All HDD/SSD modules (drives) must be uniquely identified so that they can be reinstalled in their original mounting locations later. If this is not done, existing data can be lost.

### 6.2.1 Required tools

- Starting and completing the task:
  - key for the rack doors (if applicable)
- Replacing the HDD/SSD module: tool-less



## 6.2.2 Starting the task

- ▶ Perform the following procedures:
  1. "Opening the rack door" on page 40
  2. "Locate the faulty server" on page 37
  3. "Locate the faulty component by PRIMERGY diagnostics indicators" on page 39

### Only applicable for removing non-defective HDD/SSD modules:

- ▶ Set the drive to "Offline" via the software (RAID controller configuration software), before removing an HDD/SSD module that is not defective.

## 6.2.3 Unlocking the HDD/SSD module

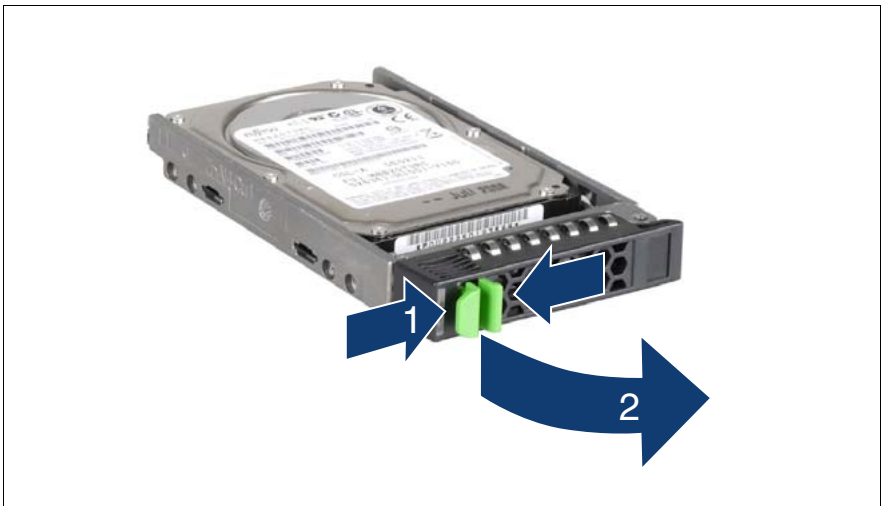

Figure 37: Unlocking the 2.5-inch HDD/SSD module

- ▶ Release the locking mechanism as follows:
  1. Press the two green tabs of the locking lever together (1).
  2. Push the handle of the HDD/SSD module fully in the direction of the arrow (2). The HDD/SSD module is now unlocked.

### 6.2.4 Removing the HDD/SSD module

- ▶ Pull the HDD/SSD module out a few centimeters.
- ▶ Wait for at least 60 seconds.



This period is necessary for the RAID controller to recognize that an HDD/SSD module has been removed and for the hard disk drive to come to a stop.

- ▶ Pull the HDD/SSD module out completely.

### 6.2.5 Completing the task

Perform one of the following procedures to complete the task:

1. ["Installing the dummy module" on page 88](#)
2. ["Installing the HDD/SSD module" on page 80](#)

## 6.3 Removing the HDD/SSD module



**Trained personnel**

### 6.3.1 Required tools

- Starting and completing the task:
  - key for the rack doors (if applicable)
- Removing the HDD/SSD module: tool-less

### 6.3.2 Starting the task

- ▶ Perform the following procedures:
  1. ["Opening the rack door" on page 40](#)

### 6.3.3 Unlocking the HDD/SSD module

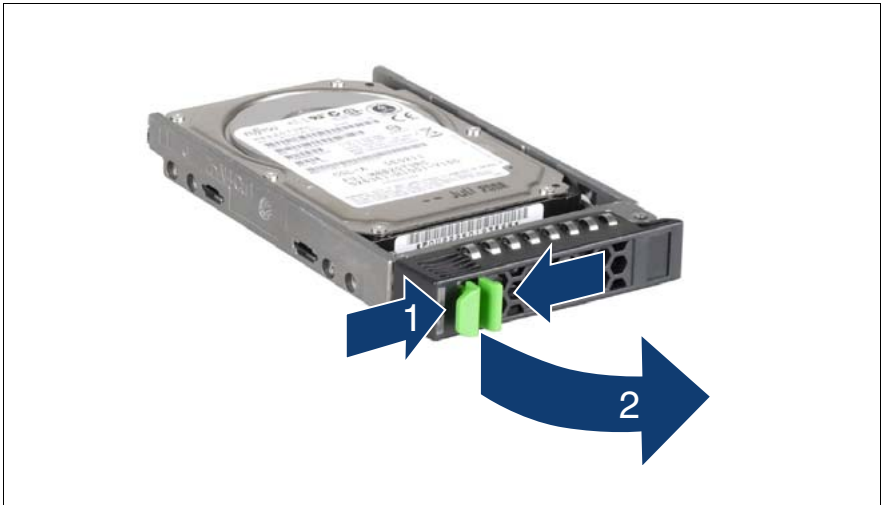

Figure 38: Unlocking the 2.5-inch HDD/SSD module

- ▶ Release the locking mechanism as follows:
  1. Press the two green tabs of the locking lever together (1).
  2. Push the handle of the HDD/SSD module fully in the direction of the arrow (2). The HDD/SSD module is now unlocked.

### 6.3.4 Removing the HDD/SSD module

- ▶ Pull the HDD/SSD module out a few centimeters.
- ▶ Wait for at least 60 seconds.



This period is necessary for the RAID controller to recognize that an HDD/SSD module has been removed and for the hard disk drive to come to a stop.

- ▶ Pull the HDD/SSD module out completely.

### 6.3.5 Installing the dummy module

To install a dummy module, follow the procedure for "[Removing the dummy module](#)" on page 81 in reverse order.

### 6.3.6 Completing the task

- ▶ Perform the following procedures to complete the task:
  1. "[Closing the rack door](#)" on page 51

## 6.4 Replacing the SAS backplane



### Authorized personnel

Authorized specialist personnel can carry out replacement tasks for integral server components. Ask your local Fujitsu service center for more detailed information.



### CAUTION!

Procedures indicated as "Authorized personnel only" must be done by Fujitsu service personnel or technicians trained by Fujitsu for doing these tasks. Please note that unauthorized interference with the system will void the warranty and exempt the manufacturer from all liability.

### 6.4.1 Required tools

- Starting and completing the task:
  - key for the rack doors (if applicable)
  - Phillips Ph2 screw driver
- Replacing the SAS backplane:
  - Phillips Ph2 screw driver

### 6.4.2 Starting the task

- ▶ Perform the following procedures:
  1. ["Opening the rack door" on page 40](#)
  2. ["Locate the faulty server" on page 37](#)
  3. ["Shutting down the server" on page 41](#)
  4. ["Sliding the server out of the rack" on page 42](#)
  5. ["Opening the server" on page 44](#)

## Hard disk and solid state drives

6. Remove all CPUMEMRs, see ["Removing the CPUMEMR" on page 190](#)

**i** Before removing the CPUMEMRs, take a note on the installation slot number for each CPUMEMR. Make sure that you reinstall the CPUMEMR in the slot it was located before the SAS backplane replacement.

7. Unlock and remove all HDD/SSD modules, see ["Unlocking the HDD/SSD module" on page 82](#) and ["Removing the HDD/SSD module" on page 86](#).

**i** Before removing the HDD/SSD modules, take a note on the bay number for each module. Make sure that you reinstall the module in the bay it was located before the SAS backplane replacement.

### 6.4.3 Sliding the local service display outward

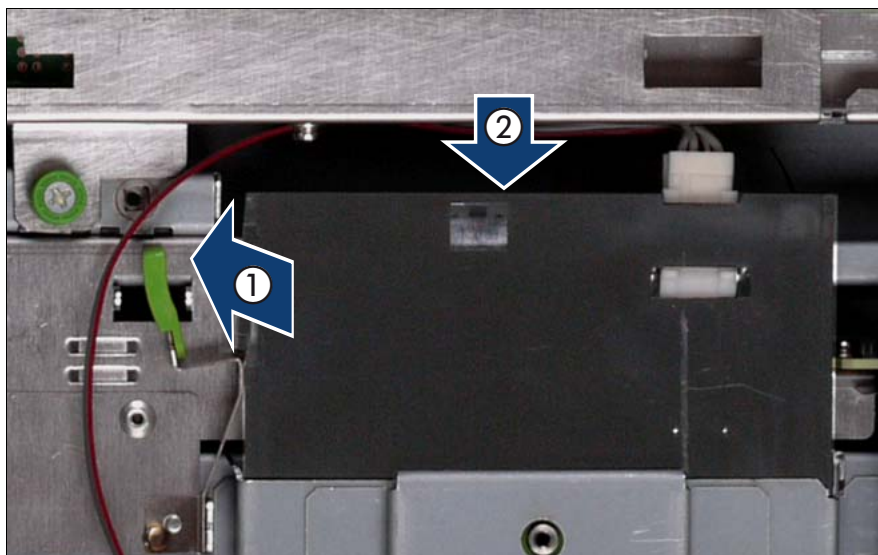

Figure 39: Sliding the local service display outward

- ▶ Unlock the local service display (1).
- ▶ Slide the local service display outward a few centimeters so that you have free access (2).

## 6.4.4 Disconnecting the cables

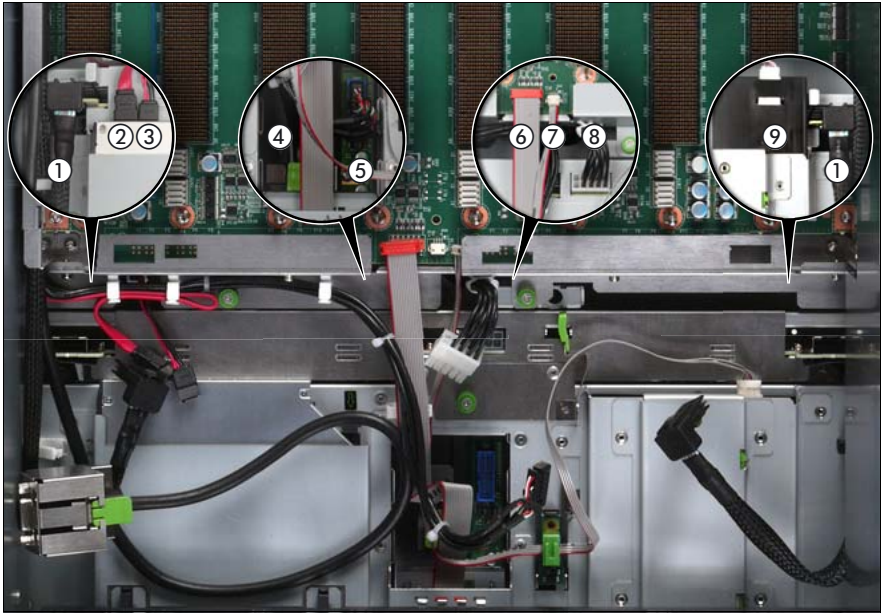

Figure 40: Disconnecting the cables from the baseboard

- ▶ Disconnect the following cables from the baseboard:
  - SAS backplane cable (1)
  - Signalling cable (2) and power cable (3) to the optical drive
  - Front video connector cable (4)
  - Front USB cable (5)
  - Control panel cable (6)
  - Chassis ID cable (7)
  - Power cable for the SAS backplane (8)

For the cable plan see "[Cabling](#)" on page 367.

### 6.4.5 Sliding the optical drive outward

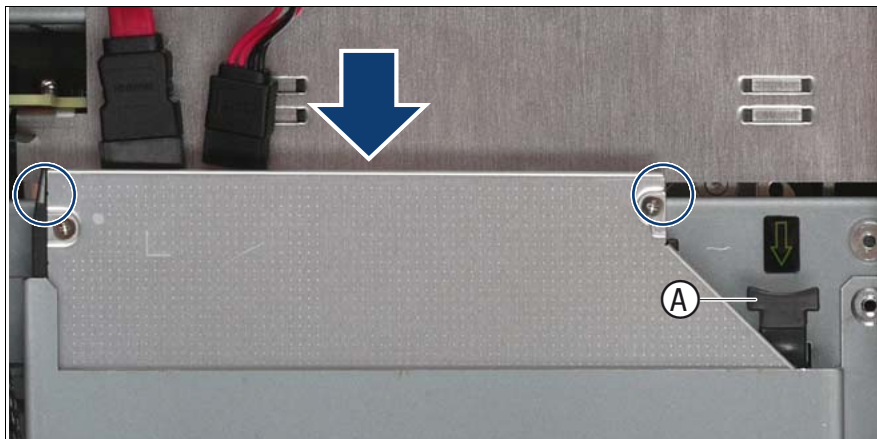

Figure 41: Sliding the optical drive outward

- ▶ Use the handle (A) to unlock the optical drive.
- ▶ Slide the optical drive outward a few centimeters so that you have free access to the SAS backplane (see circles).



## 6.4.6 Removing the air guide

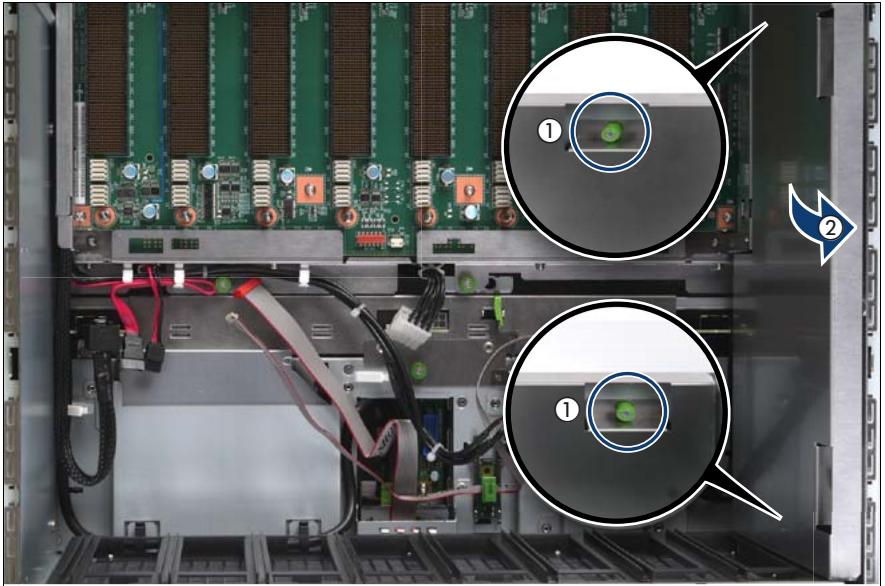

Figure 42: Removing the air guide

- ▶ Loosen the captive screws (1).
- ▶ Lift the air guide out of the chassis (2).

## 6.4.7 Removing the SAS backplane

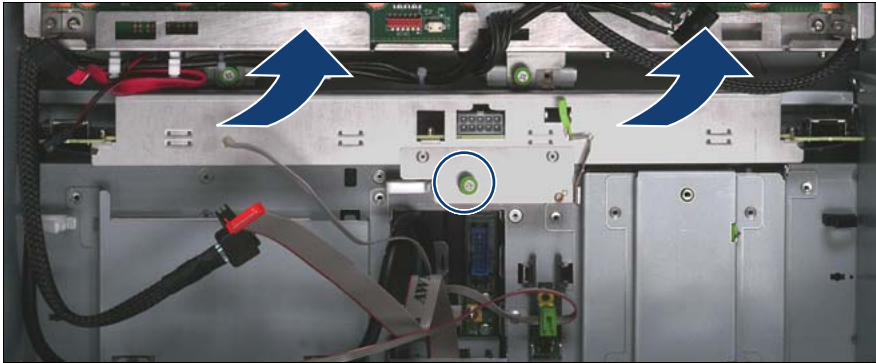

Figure 43: Removing the SAS backplane

- ▶ Loosen the captive screw (see circle) on the SAS backplane.
- ▶ Remove the SAS backplane by pulling it straight upward. Do not tilt it.

## 6.4.8 Installing the SAS backplane

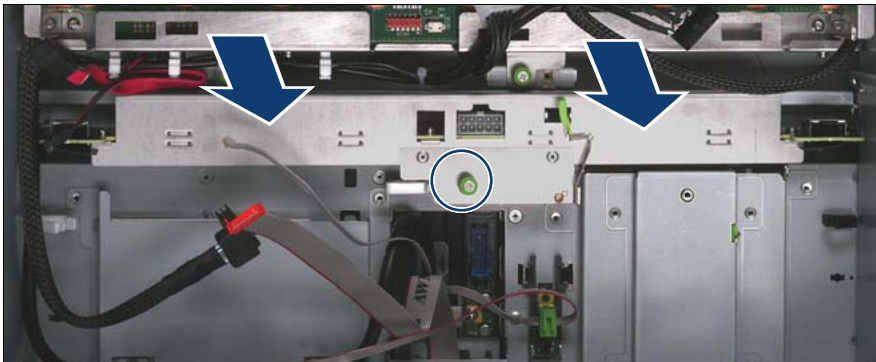

Figure 44: Installing the SAS backplane

- ▶ Insert the SAS backplane into the bay until it clicks into place. Do not tilt it.
  - i** Make sure that the SAS backplane is installed correctly. Otherwise the HDD/SSD modules can be damaged when you install them.
- ▶ Fasten the captive screw (see circle) on the SAS backplane.

## 6.4.9 Installing the air guide

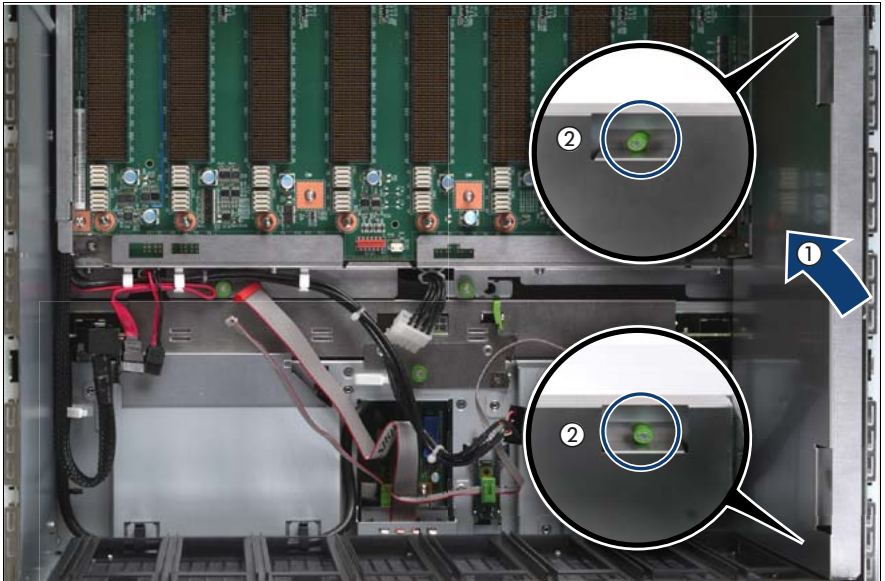

Figure 45: Installing the air guide

- ▶ Place the air guide in the chassis (1).
- ▶ Fasten the captive screws (2).

### 6.4.10 Sliding the optical drive inward

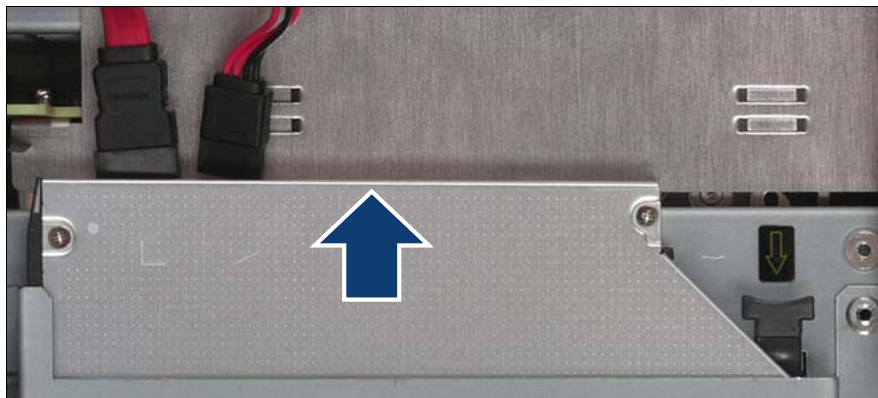

Figure 46: Sliding the optical drive inward

- ▶ Slide the optical drive into the bay until it clicks into place.

## 6.4.11 Connecting the cables to the baseboard

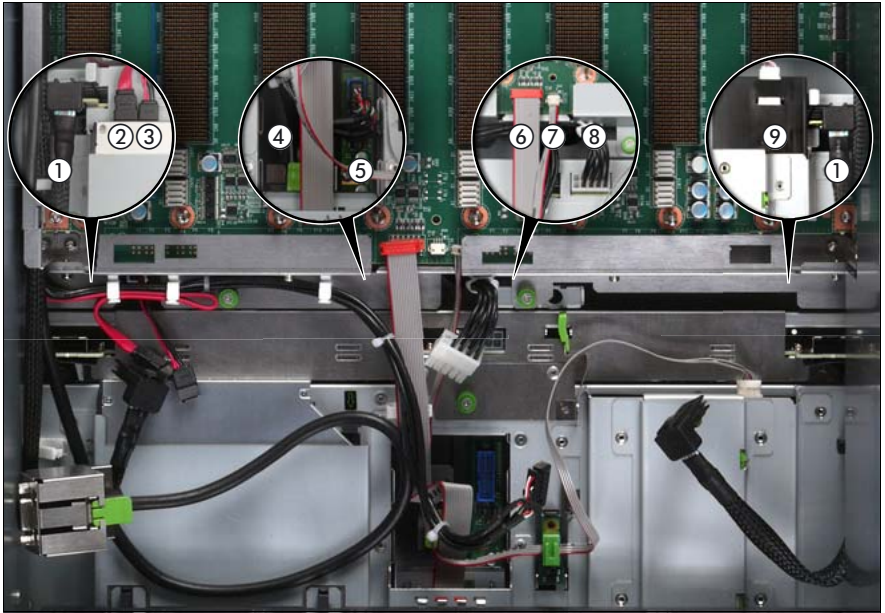

Figure 47: Connecting the cables to the baseboard

- ▶ Connect the following cables to the baseboard:
  - SAS backplane cable (1)
  - Signalling cable (2) and power cable (3) to the optical drive
  - Front video connector cable (4)
  - Front USB cable (5)
  - Control panel cable (6)
  - Chassis ID cable (7)
  - Power cable to the SAS backplane (8)

For the cable plan see "[Cabling](#)" on page 367.

### 6.4.12 Sliding the local service display inward

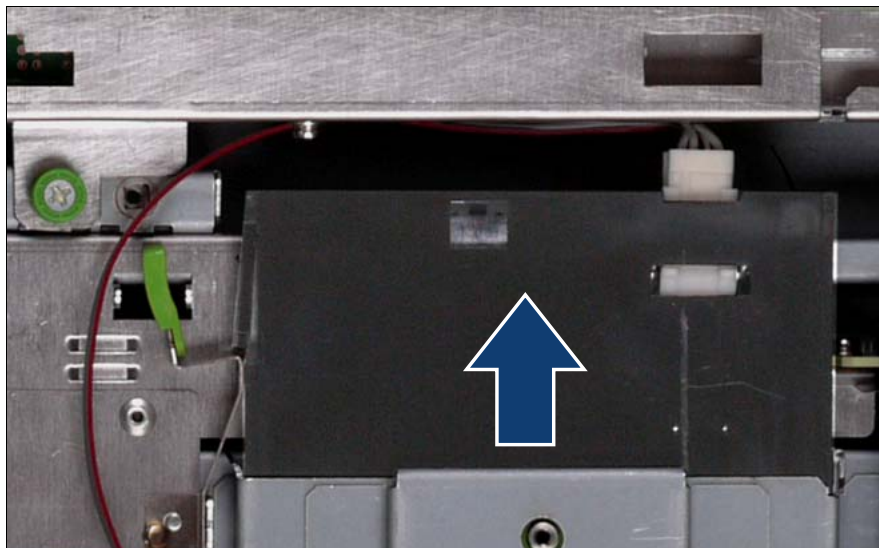

Figure 48: Sliding the local service display inward

- ▶ Slide the local service display inward until it clicks into place.

## 6.4.13 Completing the task

► Perform the following procedures to complete the task:

1. Insert all HDD/SSD modules, see ["Unlocking the HDD/SSD module" on page 82](#) and ["Inserting the HDD/SSD module" on page 83](#).



Make sure that you reinstall the module in the bay it was located before the SAS backplane replacement.

2. Insert all CPUMEMRs, see ["Inserting the CPUMEMR in the slot" on page 186](#)



Make sure that you reinstall the CPUMEMR in the slot it was located before the SAS backplane replacement.

3. ["Closing the server" on page 47](#)
4. ["Mounting the server in the rack" on page 49](#)
5. ["Bringing the server back to operation" on page 51](#)
6. ["Closing the rack door" on page 51](#)





---

## 7 Fan modules

The server is supplied with four hot-plug fan modules in a 3+1 redundant configuration. In other words, if one of the four fan modules fails, the system will operate without any problem.



### CAUTION!

- Do not disassemble the power supply unit. Doing so may cause electric shock.
- Do not damage or modify internal cables or devices. Doing so may cause a device failure, fire, or electric shock.
- Devices inside the server remain hot after shutdown. Wait for a while after shutdown before installing or removing internal options.
- The circuit boards and soldered parts of internal options are exposed and can be damaged by static electricity. Before handling them, first touch a metal part of the server to discharge static electricity from your body.
- Do not touch the circuitry on boards or soldered parts. Hold the metallic areas or the edges of the circuit boards.
- If devices are installed or disassembled using methods other than those outlined in this chapter, the warranty will be invalidated.
- The installation indicated on this note is sometimes changed to the kind of possible options without notice.
- Follow the safety instructions in the chapter "[Safety instructions](#)" on [page 31](#).

## 7.1 Replacing a defective fan module



Trained personnel

### 7.1.1 Required tools

- Starting and completing the task:
  - key for the rack doors (if applicable)
- Replacing the fan module: tool-less

### 7.1.2 Starting the task

- ▶ Perform the following procedures:
  1. ["Opening the rack door" on page 40](#)
  2. ["Locate the faulty server" on page 37](#)
  3. ["Sliding the server out of the rack" on page 42](#)

### 7.1.3 Opening the fan cover



Figure 49: Opening the fan cover

- ▶ Press the handle in direction of the arrow and lift the fan cover.

## 7.1.4 Replacing the defective fan module

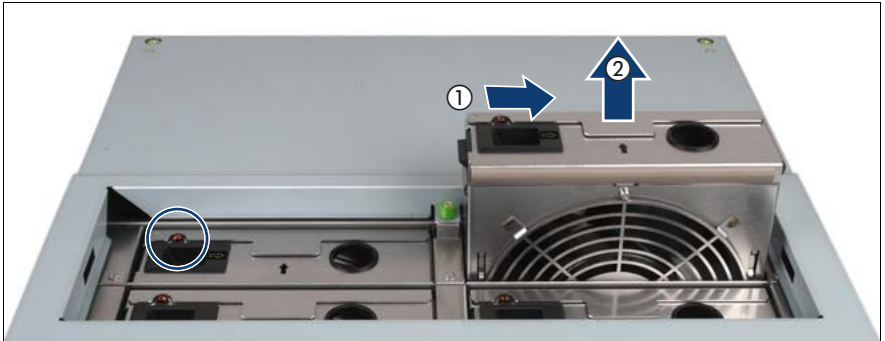

Figure 50: Identifying and removing a defective fan module

- ▶ Identify the defective fan module. The indicator of the defective fan lights up Orange, see circle in [figure 50](#).
- ▶ Have the new fan module ready for the installation.



### CAUTION!

Never leave the fan module bay empty for more than two minutes during operation. Otherwise, excessive temperatures could damage system components.

- ▶ Press the handle (1) and lift the fan module out of the housing (2).
- ▶ Insert the new fan module in the empty bay until it engages.

The new fan module is tested by Server Management. The indicator then either does not light at all (fan is OK) or lights up in Orange (fan is not OK).

### 7.1.5 Closing the fan cover



Figure 51: Closing the fan cover

- ▶ Press the handle in direction of the arrow and insert the fan cover into the front cover.

### 7.1.6 Completing the task

Perform the following procedures to complete the task:

1. ["Mounting the server in the rack" on page 49](#)
2. ["Closing the rack door" on page 51](#)

---

## 8 Expansion cards and BBU



### Authorized personnel

Authorized specialist personnel can carry out replacement tasks for integral server components. Ask your local Fujitsu service center for more detailed information.



### CAUTION!

Procedures indicated as "Authorized personnel only" must be done by Fujitsu service personnel or technicians trained by Fujitsu for doing these tasks. Please note that unauthorized interference with the system will void the warranty and exempt the manufacturer from all liability.



The number and location of available PCIe slots depends on the CPUMEMR configuration. Make sure that the planned CPUMEMR configuration enables you to use the PCIe slots needed for the individual use case of the server.

For detailed information on configuration rules and supported expansion card types see "Baseboard D3081, CPUMEMR D3131, PCIR D3082 for PRIMERGY RX900 S1 Technical Manual" or in the configurator using the following link:

[http://ts.fujitsu.com/products/standard\\_servers/rack/primergy\\_rx900s1.html](http://ts.fujitsu.com/products/standard_servers/rack/primergy_rx900s1.html)  
(for the EMEA market).

Figure 52 shows the PCIe slot configuration. Expansion cards can be installed in the PCIe slots on the PCI Riser (A) and on the baseboard (D). The PCI Riser is connected to the baseboard via the connectors C and E.

The PCIe slots are assigned as follows:

- **B:** non-hot plug PCIe slots on the PCI Riser
- **F:** non-hot plug PCIe slot for the Modular Raid controller only
- **G:** hot-plug PCIe slots
- **H:** non-hot plug PCIe slots on the baseboard

## Expansion cards and BBU

For information on the population order and the capability of the slots see "Baseboard D3081, CPUMEMR D3131, PCIR D3082 for PRIMERGY RX900 S1 Technical Manual".

**i** The RX900 S1 server can be equipped with one Modular RAID controller and two SAS RAID controllers but only for two of these RAID controllers a BBU can be installed.

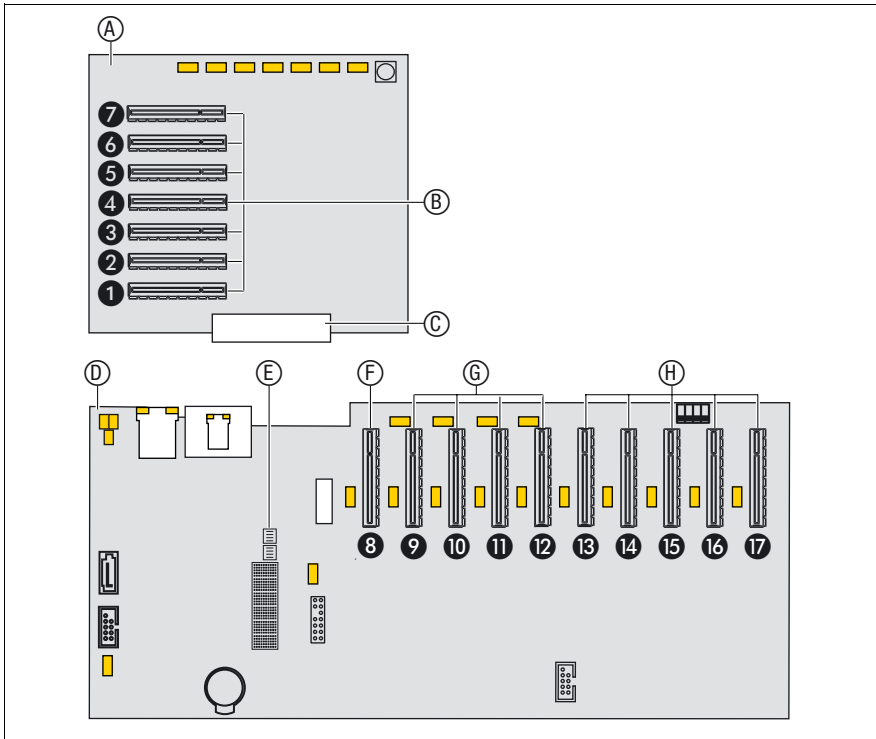

Figure 52: PCIe slot assignment

## 8.1 Mounting expansion card slot brackets



### Authorized personnel

Authorized specialist personnel can carry out replacement tasks for integral server components. Ask your local Fujitsu service center for more detailed information.



### CAUTION!

Procedures indicated as "Authorized personnel only" must be done by Fujitsu service personnel or technicians trained by Fujitsu for doing these tasks. Please note that unauthorized interference with the system will void the warranty and exempt the manufacturer from all liability.

This section provides [General instructions](#) for mounting slot brackets as well as specific instructions for the following expansion cards:

- ["Network adapter D2735" on page 108](#)
- ["Network adapter D2745" on page 110](#)
- ["Network adapter D2755" on page 112](#)

### 8.1.1 Required tools

- Mounting slot brackets:
  - Phillips Ph0 screw driver

## 8.1.2 General instructions

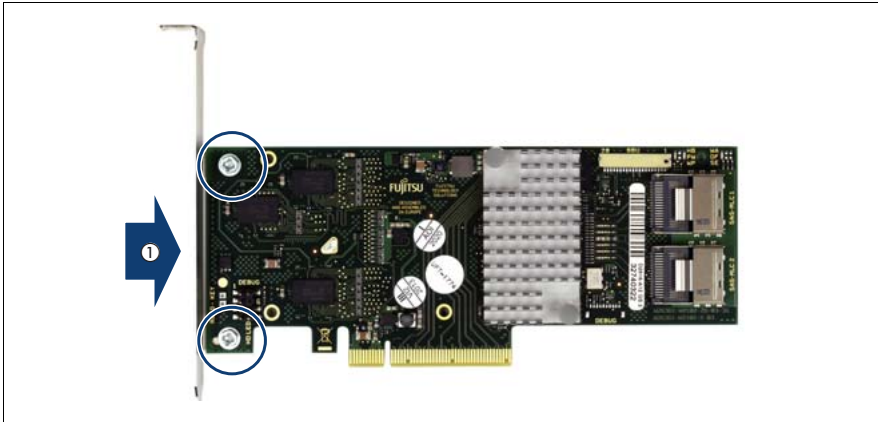
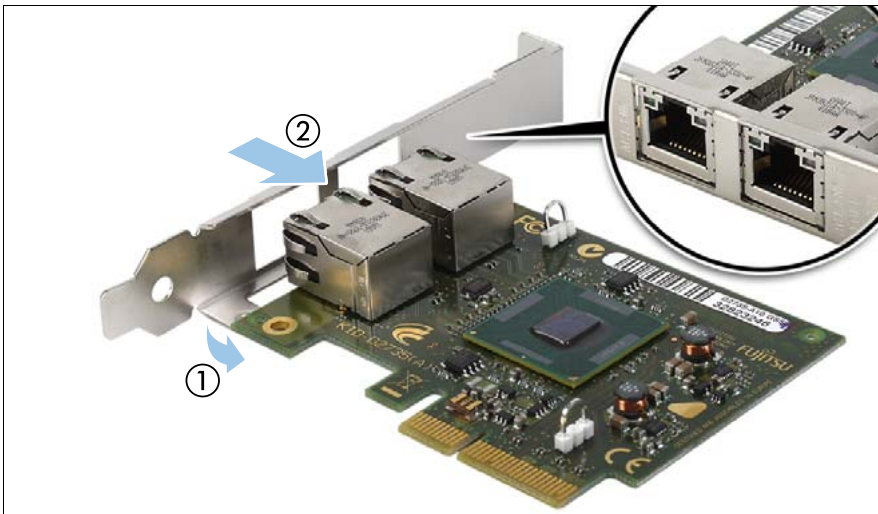

Figure 53: Mounting expansion card slot brackets

- ▶ Place the controller on the mounting tabs on the slot bracket (1).
- ▶ Secure the slot bracket to the controller with two M3 x 4.5 mm screws.

## 8.1.3 Network adapter D2735





- ▶ Place the controller on the mounting tabs on the slot bracket (1).
- ▶ Carefully shift the slot bracket towards the controller (2) until the plug shells engage with the cut-outs in the slot bracket connector panel (see circle).

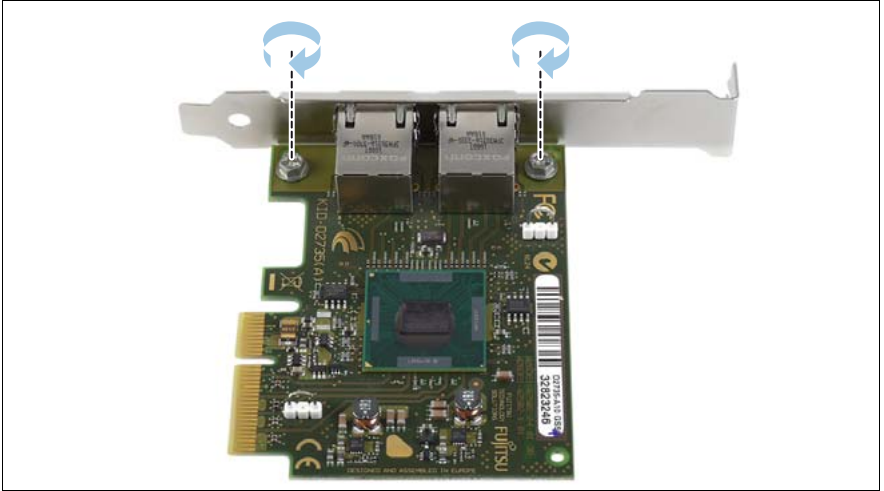

- ▶ Secure the slot bracket to the controller with two M3 x 4.5 mm screws.

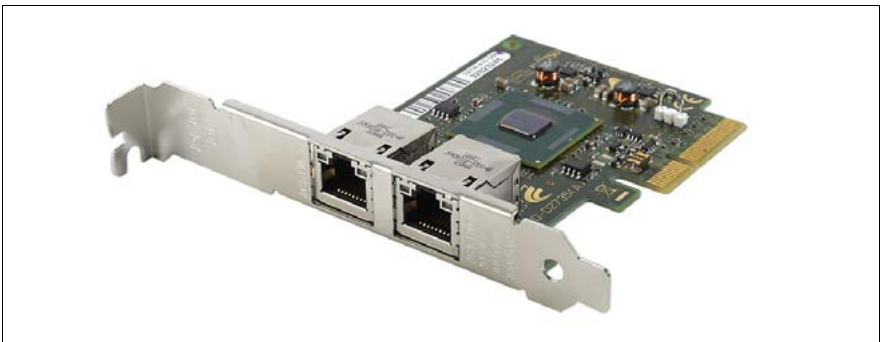

Assembled network adapter D2735.

### 8.1.4 Network adapter D2745

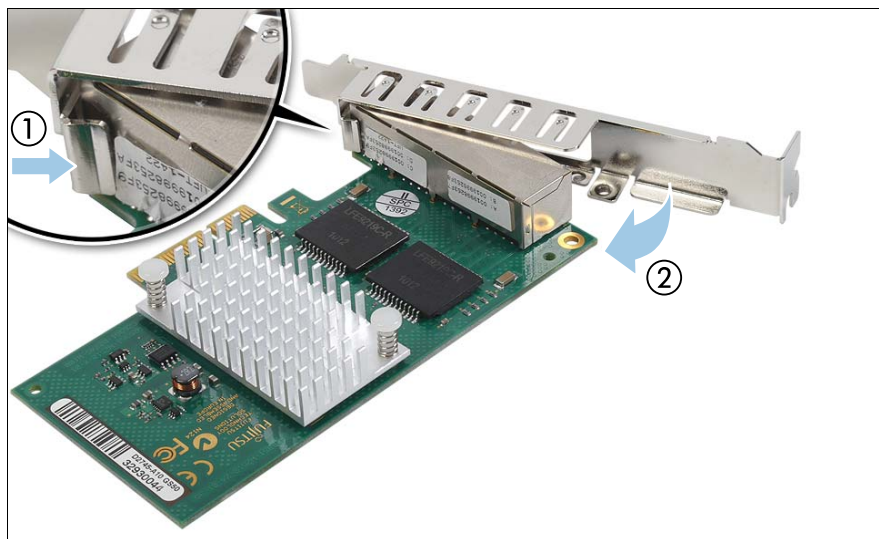

- ▶ Hinge the slot bracket to the plug shell as shown (1).
- ▶ Fold the slot bracket towards the controller until the threaded mounting tab is aligned with the screw hole on the controller (2).

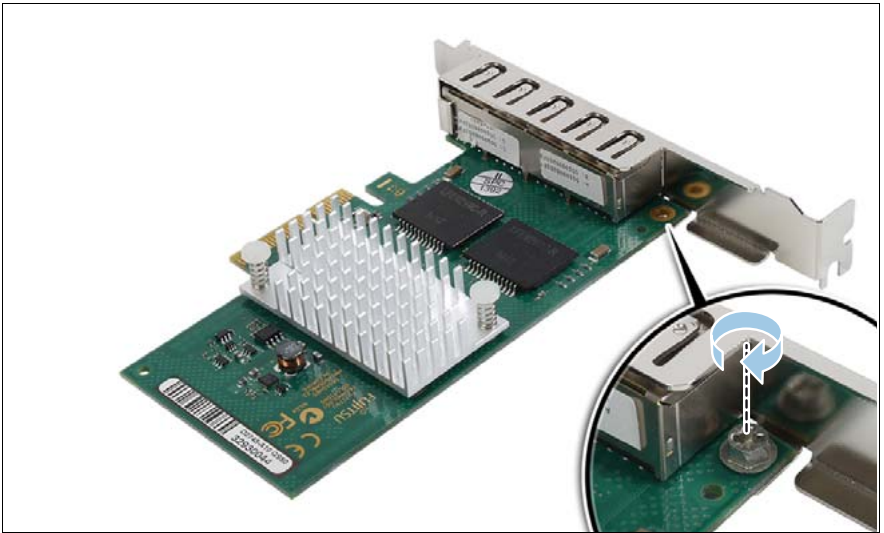

- Secure the slot bracket to the controller with one M3 x 4.5 mm screw.



Assembled network adapter D2745.

## 8.1.5 Network adapter D2755

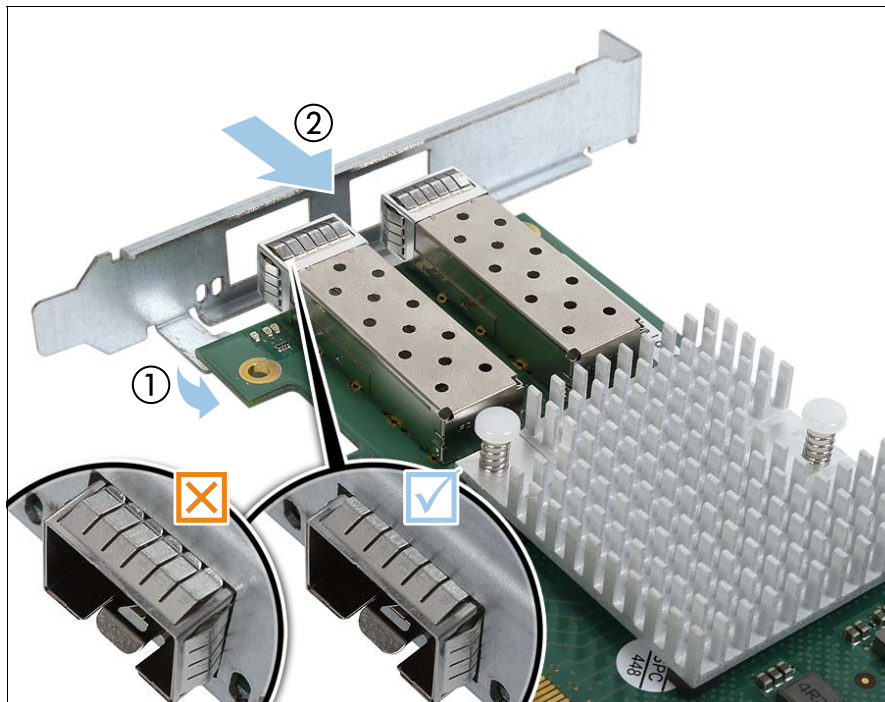

- ▶ Place the controller on the mounting tabs on the slot bracket (1).
- ▶ Carefully shift the slot bracket towards the controller until the plug shells engage with the cut-outs in the slot bracket connector panel (2).
- ▶ Ensure that the ESD springs on the plug shells properly engage with the slot bracket as shown (see circles).

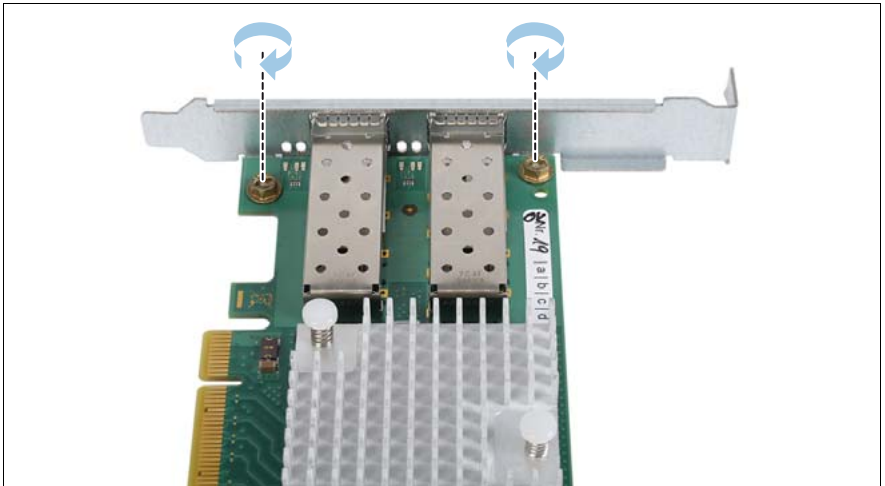

- ▶ Secure the slot bracket to the controller with two M3 x 4.5 mm screws.

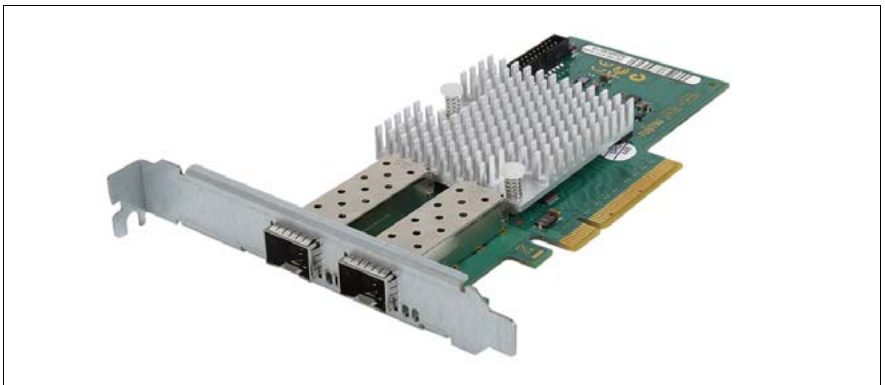

Assembled network adapter D2755.

## 8.2 Installing SFP+ transceiver modules



### Authorized personnel

Authorized specialist personnel can carry out replacement tasks for integral server components. Ask you local Fujitsu service center for more detailed information.



### CAUTION!

Procedures indicated as "Authorized personnel only" must be done by Fujitsu service personnel or technicians trained by Fujitsu for doing these tasks. Please note that unauthorized interference with the system will void the warranty and exempt the manufacturer from all liability.

For Fiber Channel over Ethernet (FCoE) configurations, the ethernet server adapter is equipped with one or two SFP+ (small form-factor pluggable) transceiver modules.

### 8.2.1 Required tools

- Installing SFP+ transceiver modules: tool-less

## 8.2.2 Preparing the SFP+ transceiver module



Figure 54: Removing the protective optical port plug

- ▶ Remove the SFP+ transceiver module from its protective packaging.
- ▶ Remove the optical port plug from the new / additional SFP+ transceiver module.



### CAUTION!

- Always keep the protective port plugs attached to the transceiver optical bores and fiber-optic cable connectors until you are ready to make a connection.
- Save the protective port plug for future use.



Figure 55: Unlatching the locking bail

- ▶ Carefully unlatch and fold down the locking bail on the SFP+ transceiver module.

### 8.2.3 Inserting the SFP+ transceiver module

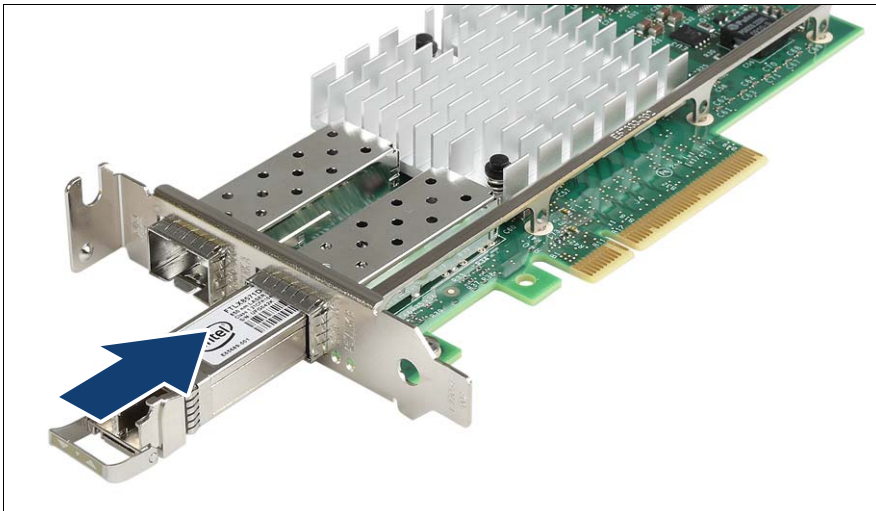

Figure 56: Inserting the SFP+ transceiver module



- ▶ Insert and slide the SFP+ transceiver module into the socket connector as far as it will go.



If only one slot is equipped with a SFP+ transceiver module, use the primary right connector as shown.

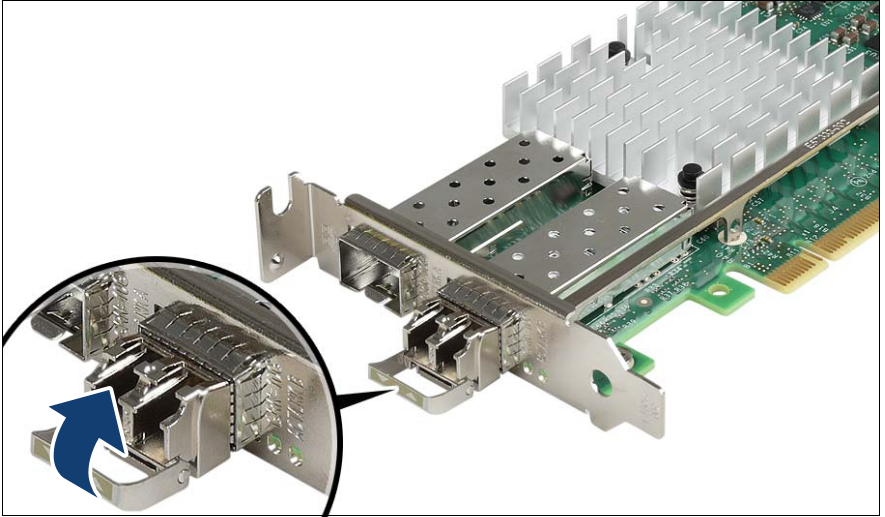

Figure 57: Latching the locking bail

- ▶ Carefully fold up and latch the locking bail.

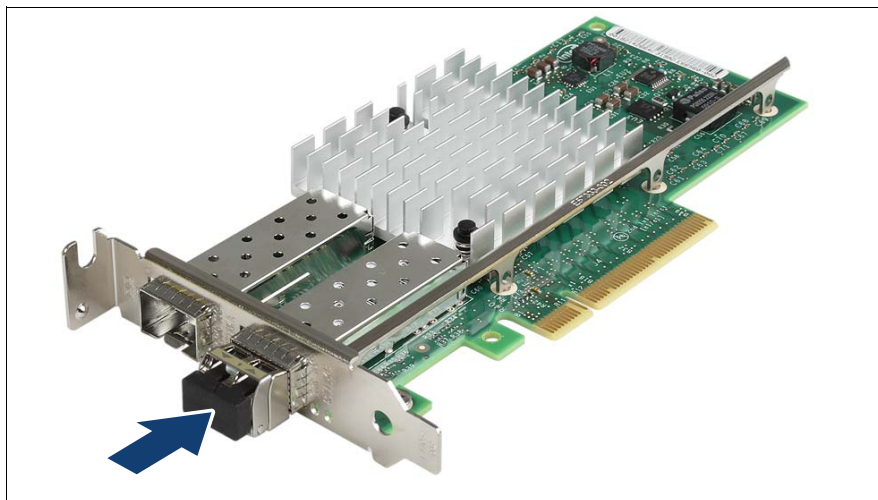

Figure 58: Attaching the protective optical port plug

- ▶ If the SFP+ transceiver module is not immediately connected to an LC connector, attach the protective optical port plug to the transceiver optical bores.

## 8.2.4 Installing the secondary SFP+ transceiver module

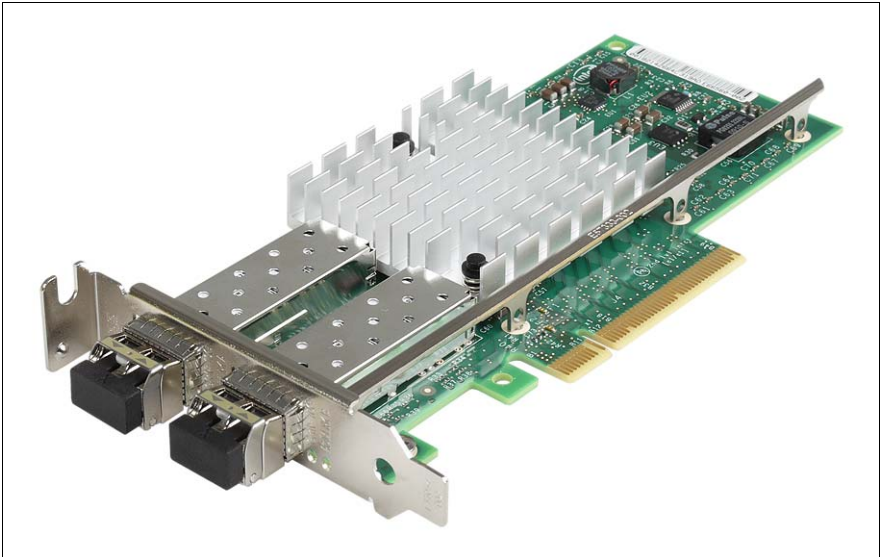

Figure 59: Installing the secondary SFP+ transceiver module

- ▶ If applicable, install the secondary SFP+ transceiver module accordingly.

## 8.3 Replacing SFP+ transceiver modules



### Authorized personnel

Authorized specialist personnel can carry out replacement tasks for integral server components. Ask your local Fujitsu service center for more detailed information.



### CAUTION!

Procedures indicated as "Authorized personnel only" must be done by Fujitsu service personnel or technicians trained by Fujitsu for doing these tasks. Please note that unauthorized interference with the system will void the warranty and exempt the manufacturer from all liability.

For Fiber Channel over Ethernet (FCoE) configurations, the ethernet server adapter is equipped with one or two SFP+ (small form-factor pluggable) transceiver modules.

### 8.3.1 Required tools

- Removing SFP+ transceiver modules: tool-less

### 8.3.2 Removing an SFP+ transceiver module

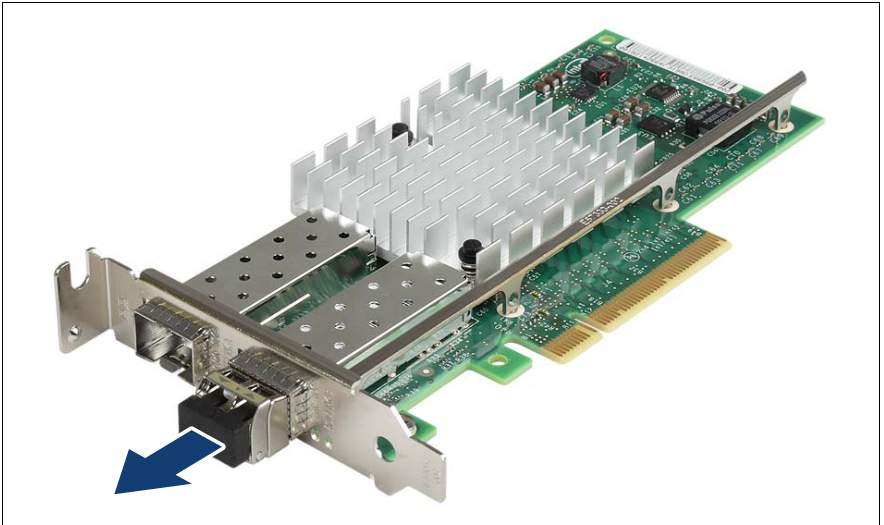

Figure 60: Removing the protective optical port plug

- ▶ If present, remove the protective optical port plug from the SFP+ transceiver module.



**CAUTION!**

Save the protective port plug for future use.

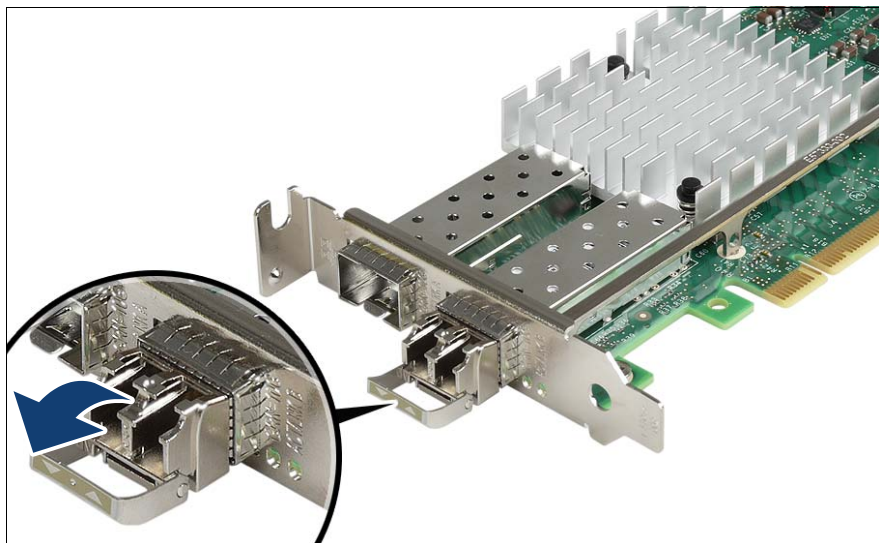

Figure 61: Unlatching the locking bail

- ▶ Carefully unlatch and fold down the locking bail on the SFP+ transceiver module to eject the transceiver from the socket connector.

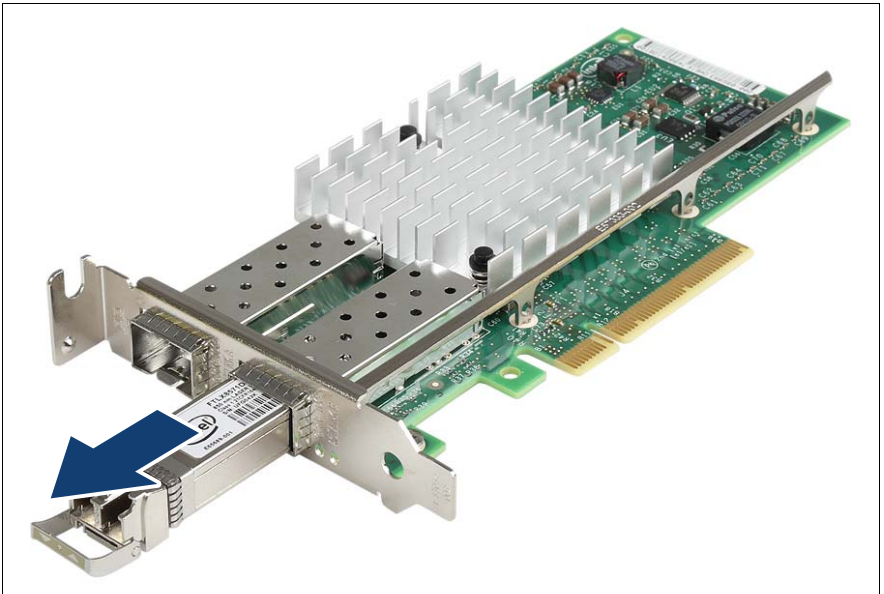

Figure 62: Removing the SFP+ transceiver

- ▶ Pull the SFP+ transceiver module out of its socket connector.
  - ▶ Reattach the protective optical port plug to the transceiver optical bores.
- i** Place the removed SFP+ transceiver module in an antistatic bag or other protective environment.

### 8.3.3 Completing the task

- ▶ Perform the following procedure to complete the task:
  - ["Installing SFP+ transceiver modules" on page 114](#)

## 8.4 Installing a hot-plug expansion card



### Authorized personnel

Authorized specialist personnel can carry out replacement tasks for integral server components. Ask your local Fujitsu service center for more detailed information.



### CAUTION!

Procedures indicated as "Authorized personnel only" must be done by Fujitsu service personnel or technicians trained by Fujitsu for doing these tasks. Please note that unauthorized interference with the system will void the warranty and exempt the manufacturer from all liability.



### CAUTION!

- The actions described in this section may only be performed by personnel with the appropriate technical training. The device can be seriously damaged if it is opened without authorization or if repairs are attempted by untrained personnel.
- Each slot in the server must have either an expansion card or:
  - **Hot-plug PCIe slot:** a dummy module, that is a retaining plate with an attached removal tool
  - **Non-hot plug PCIe slot:** a slot cover
- Please observe the safety information in [chapter "Safety instructions" on page 31](#).

### 8.4.1 Required tools

- Starting and completing the task:
  - key for the rack doors (if applicable)
  - Phillips Ph2 screw driver
- Installing the expansion card: tool-less



## 8.4.2 Starting the task

**i** Read the accompanying documentation supplied with the expansion card before proceeding.

► Perform the following procedures:

1. "Opening the rack door" on page 40
2. "Sliding the server out of the rack" on page 42
3. "Removing the rear cover" on page 46
4. If applicable: "Mounting expansion card slot brackets" on page 107
5. If applicable: "Preparing the SFP+ transceiver module" on page 115

## 8.4.3 Pulling the removal tool out of the slot

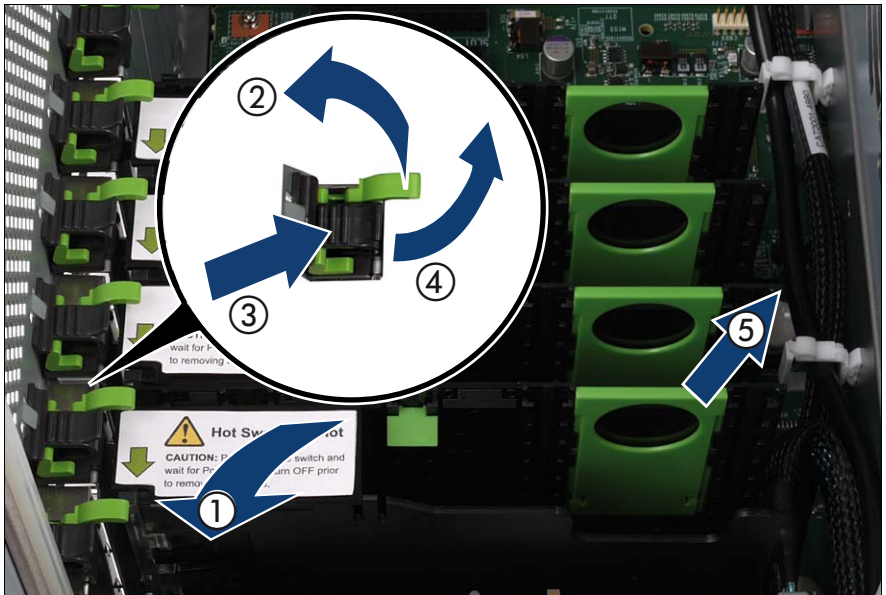

Figure 63: Pulling the removal tool out of the slot

- ▶ Open the slot to be fitted (1).
- ▶ Remove the slot lock by pulling the green handle upward (2), pushing the plastic part down (3) and lifting the slot lock (4).
- ▶ Pull the removal tool out of the slot by the handle (5).

### 8.4.4 Removing the retaining plate



Figure 64: Removing the retaining plate from the removal tool

- ▶ Lift the green movable engaging hooks (see arrows) no more than approximately 1 mm until the retaining plate is completely released.



#### **CAUTION!**

The engaging hooks may easily be damaged if too much pressure is applied.

- ▶ Take the retaining plate out and put it aside.

## 8.4.5 Removing the engaging hooks



Figure 65: Removing the engaging hooks

- ▶ Push the green engaging hooks down in the direction of the arrows (1) until they disengage from the removal tool.
- ▶ Remove the engaging hooks (2) and keep them in a safe place.

## 8.4.6 Inserting an expansion card in the removal tool

Please choose one of the following procedures:

- ["Long expansion cards" on page 128](#)
- ["Short expansion cards such as the network adapter D2735" on page 128](#)

Complete the procedure by performing ["Check the result of the installation for all expansion cards" on page 129](#).

### Long expansion cards



Figure 66: Inserting the expansion card in the removal tool

- ▶ Insert the expansion card in the slot of the removal tool.
- ▶ Insert the green engaging hooks in the rods and push them down until they engage in the upper edge of the expansion card.

**i** Make sure that e.g. the ports on the expansion card are not blocked by the engaging hooks.

### Short expansion cards such as the network adapter D2735

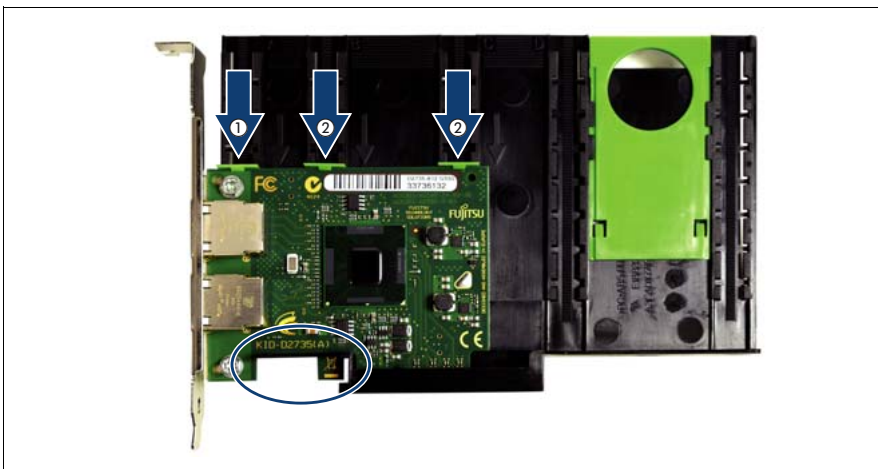

Figure 67: Inserting a short expansion card in the removal tool

- ▶ Insert the expansion card in the removal tool so that its recesses fit exactly in the removal tool (see circle) and fix the card with the engaging hook (1).
- ▶ Insert the other two green engaging hooks (2).

### Check the result of the installation for all expansion cards

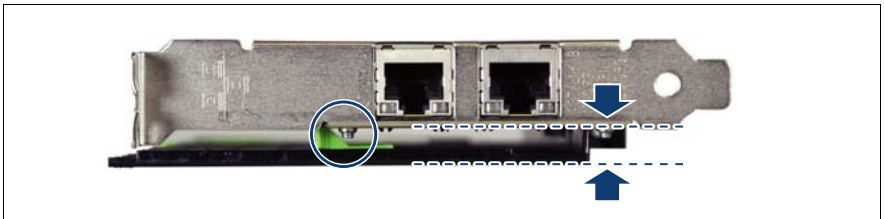

Figure 68: Position of the expansion card

- ▶ Check whether the expansion card is placed in parallel to the removal tool:



Make sure that the screw (see circle) does not interfere with the engaging hook.

## 8.4.7 Inserting the expansion card in the slot

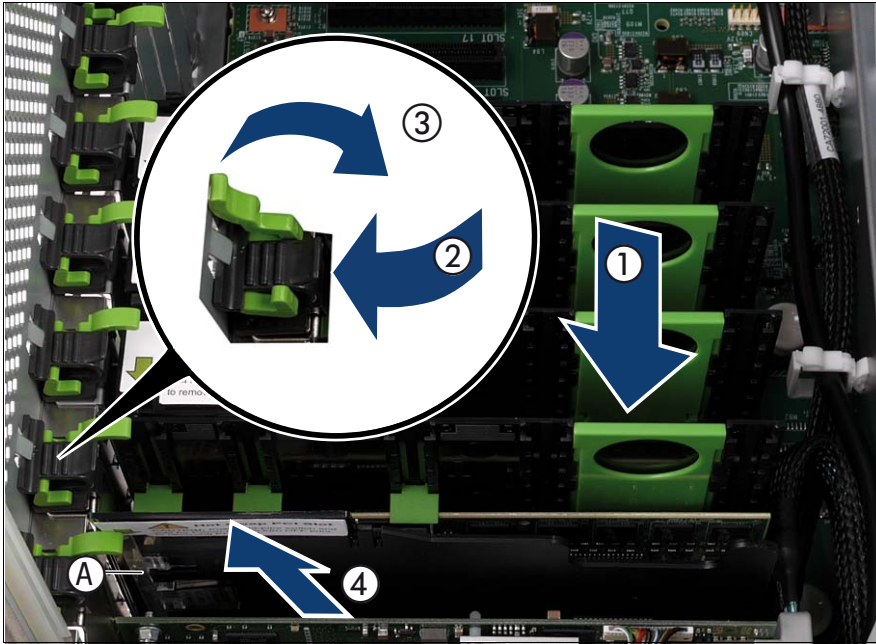

Figure 69: Inserting the expansion card in the slot

- ▶ Carefully insert the removal tool together with the expansion card in the slot (1).
- ▶ Insert the slot lock (2) and relock the slot (3).
- ▶ Close the hot-plug slot (4).
- ▶ If applicable, connect the cables on the expansion card.

## 8.4.8 Activating the expansion card

- ▶ Activate the expansion card using either the related PCI hot-plug software or by pressing the light-pipe switch, see A in [Figure 69](#).

The light-pipe switch flashes green. The slot is in the enable sequence.

- ▶ Wait until the light-pipe switch is constantly green.

The slot is now powered on.



If the light-pipe switch continues to flash, an error has occurred.

Remove the expansion card and repeat the procedure as described above.

## 8.4.9 Completing the task

- ▶ Perform the following procedures to complete the task:
  1. ["Installing the rear cover" on page 48](#)
  2. ["Mounting the server in the rack" on page 49](#)
  3. ["Closing the rack door" on page 51](#)

# 8.5 Removing a hot-plug expansion card



### Authorized personnel

Authorized specialist personnel can carry out replacement tasks for integral server components. Ask your local Fujitsu service center for more detailed information.



### CAUTION!

Procedures indicated as "Authorized personnel only" must be done by Fujitsu service personnel or technicians trained by Fujitsu for doing these tasks. Please note that unauthorized interference with the system will void the warranty and exempt the manufacturer from all liability.



### CAUTION!

- The actions described in this section may only be performed by personnel with the appropriate technical training. The device can be seriously damaged if it is opened without authorization or if repairs are attempted by untrained personnel.
- Each slot in the server must have either an expansion card or:
  - **Hot-plug PCIe slot:** a dummy module, that is a retaining plate with an attached removal tool
  - **Non-hot plug PCIe slot:** a slot cover
- Please observe the safety information in [chapter "Safety instructions" on page 31](#).

## 8.5.1 Required tools

- Starting and completing the task:
  - key for the rack doors (if applicable)
  - Phillips Ph2 screw driver
- Removing the expansion card: tool-less



## 8.5.2 Starting the task

- ▶ Perform the following procedures:
  1. ["Opening the rack door" on page 40](#)
  2. ["Sliding the server out of the rack" on page 42](#)
  3. ["Removing the rear cover" on page 46](#)

## 8.5.3 Deactivating the expansion card

- ▶ Deactivate the expansion card using either the related PCI hot-plug software or by pressing the light-pipe switch, see A in [Figure 70](#).
- ▶ Wait until the light-pipe switch no longer lights up.  
The slot is now zero potential.
- ▶ If applicable, disconnect the cables on the expansion card.

### 8.5.4 Pulling the expansion card out of the slot

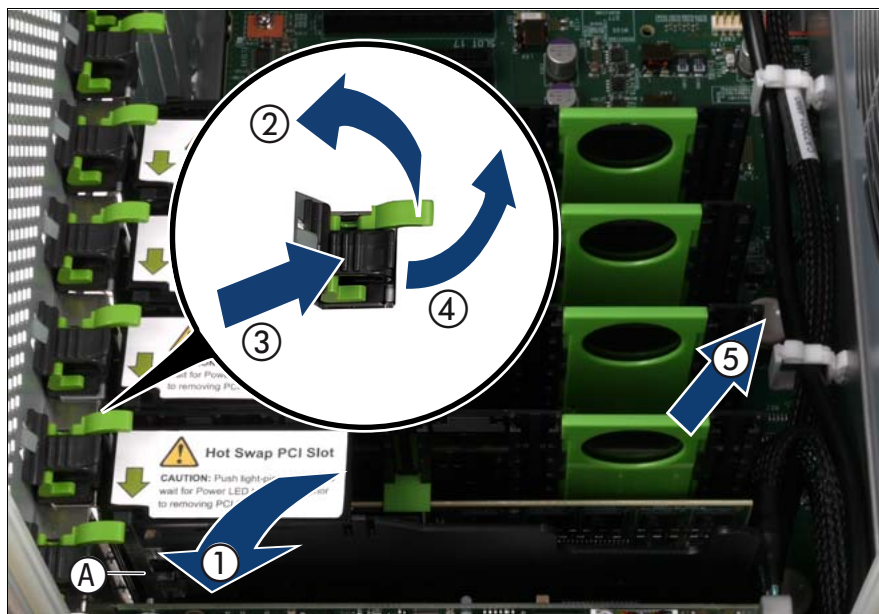

Figure 70: Pulling the expansion card out of the slot

- ▶ Open the slot containing the expansion card (1).
- ▶ Remove the slot lock by pulling the green handle upward (2), pushing the plastic part down (3) and lifting the slot lock (4).
- ▶ Hold the removal tool by the green handle and pull it out of the PCIe slot together with the expansion card (3).

**i** Do not pull on the expansion card itself.

## 8.5.5 Removing the expansion card from the removal tool

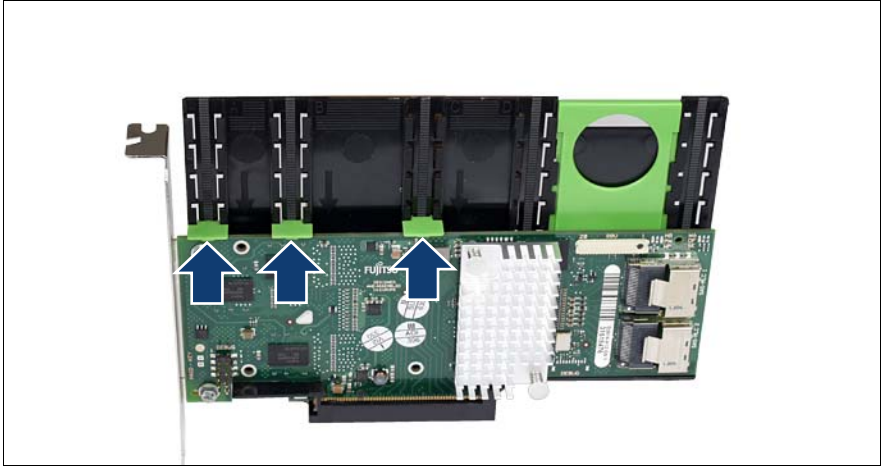

Figure 71: Removing the expansion card from the removal tool

- ▶ Lift the green movable engaging hooks no more than approximately 1 mm until the expansion card is completely released.
- ▶ Take the expansion card out and put it aside.



### CAUTION!

The engaging hooks may easily be damaged if too much pressure is applied.

## 8.5.6 Removing the engaging hooks



Figure 72: Removing the engaging hooks

- ▶ Push the green engaging hooks down in the direction of the arrows (1) until they disengage from the removal tool.
- ▶ Remove the engaging hooks (2) and keep them in a safe place.

## 8.5.7 Inserting a retaining plate in the removal tool

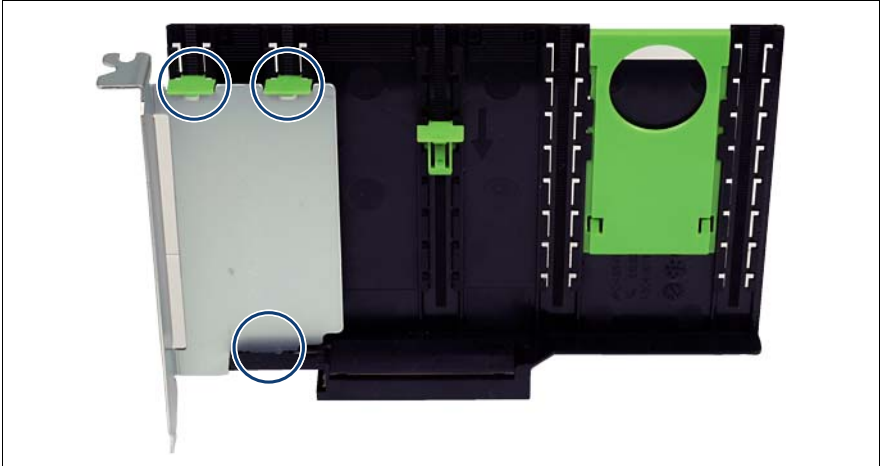

Figure 73: Inserting the retaining plate in the removal tool

- ▶ Insert the retaining plate in the slot of the removal tool.
- ▶ Insert the green engaging hooks in the rods and push them down until they engage in the upper edge of the retaining plate.

### 8.5.8 Inserting the dummy module in the slot

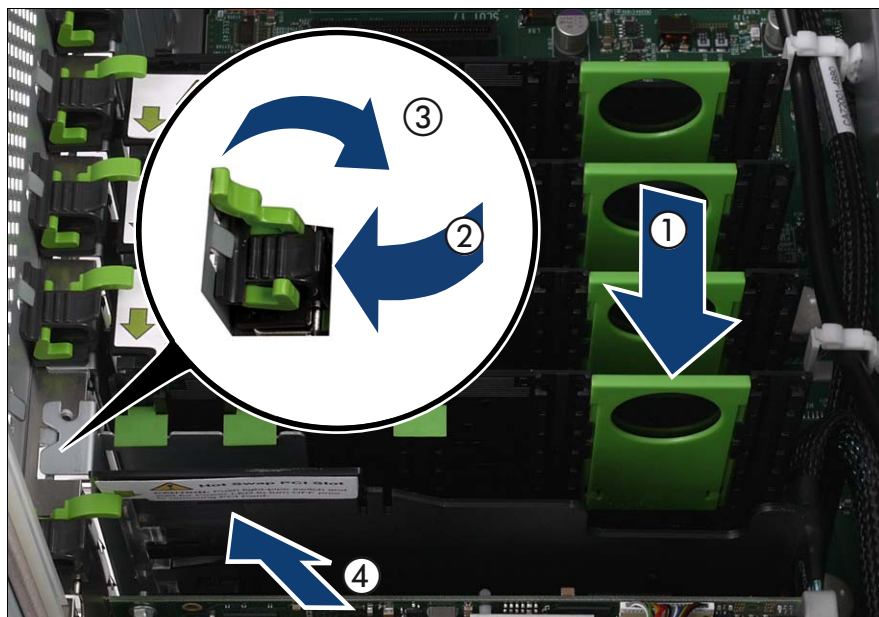

Figure 74: Inserting the dummy module in the slot

- ▶ Carefully insert the removal tool together with the dummy module in the slot (1).
- ▶ Insert the slot lock (2) and relock the slot (3).
- ▶ Close the hot-plug slot (4).

### 8.5.9 Completing the task

- ▶ Perform the following procedures to complete the task:
  1. ["Installing the rear cover" on page 48](#)
  2. ["Mounting the server in the rack" on page 49](#)
  3. ["Closing the rack door" on page 51](#)

## 8.6 Replacing a hot-plug expansion card



### Authorized personnel

Authorized specialist personnel can carry out replacement tasks for integral server components. Ask your local Fujitsu service center for more detailed information.



### CAUTION!

Procedures indicated as "Authorized personnel only" must be done by Fujitsu service personnel or technicians trained by Fujitsu for doing these tasks. Please note that unauthorized interference with the system will void the warranty and exempt the manufacturer from all liability.



### CAUTION!

- The actions described in this section may only be performed by personnel with the appropriate technical training. The device can be seriously damaged if it is opened without authorization or if repairs are attempted by untrained personnel.
- Each slot in the server must have either an expansion card or:
  - **Hot-plug PCIe slot:** a dummy module, that is a retaining plate with an attached removal tool
  - **Non-hot plug PCIe slot:** a slot cover
- Please observe the safety information in "[Safety instructions](#)" on [page 31](#).



Only expansion cards of the same type and with the same settings may be exchanged. If the expansion cards do not match, the new expansion card will not be commissioned.

### 8.6.1 Required tools

- Starting and completing the task:
  - key for the rack doors (if applicable)
  - Phillips Ph2 screw driver
- Replacing the expansion card: tool-less

### 8.6.2 Starting the task



Read the accompanying documentation supplied with the expansion card before proceeding.

- ▶ Perform the following procedures:
  1. ["Opening the rack door" on page 40](#)
  2. ["Locate the faulty server" on page 37](#)
  3. ["Sliding the server out of the rack" on page 42](#)
  4. ["Removing the rear cover" on page 46](#)
  5. ["Locate the faulty component by PRIMERGY diagnostics indicators" on page 39](#)
  6. If applicable: ["Mounting expansion card slot brackets" on page 107](#)
  7. If applicable: ["Preparing the SFP+ transceiver module" on page 115](#)

### 8.6.3 Deactivating the expansion card

- ▶ Deactivate the expansion card using either the related PCI hot-plug software or by pressing the light-pipe switch, see A in [Figure 70](#).
- ▶ Wait until the light-pipe switch no longer lights up.  
The slot is now zero potential.
- ▶ If applicable, disconnect the cables on the expansion card.



## 8.6.4 Pulling the expansion card out of the slot

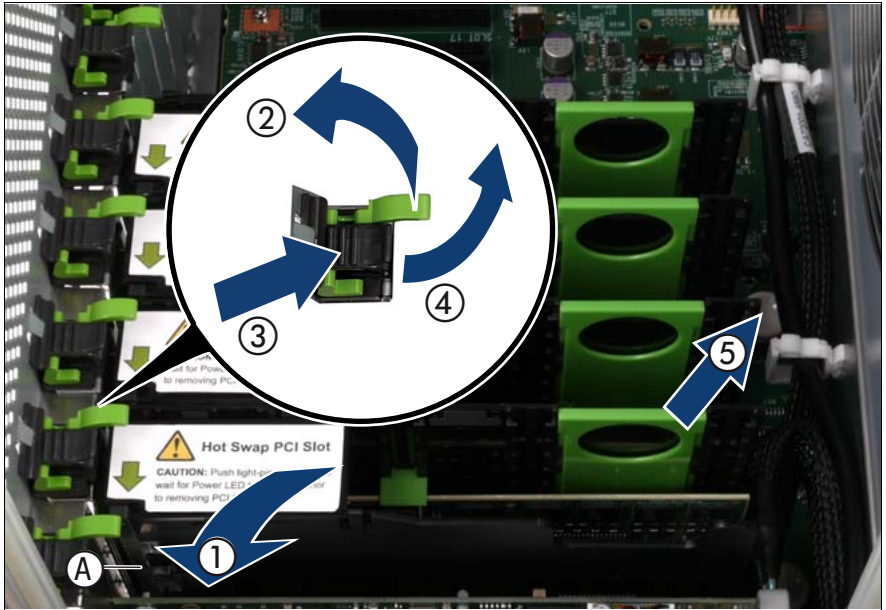

Figure 75: Pulling the expansion card out of the slot

- ▶ Open the slot containing the expansion card (1).
- ▶ Remove the slot lock by pulling the green handle upward (2), pushing the plastic part down (3) and lifting the slot lock (4).
- ▶ Hold the removal tool by the green handle and pull it out of the PCIe slot together with the expansion card (3).



Do not pull on the expansion card itself.

## 8.6.5 Removing the expansion card from the removal tool

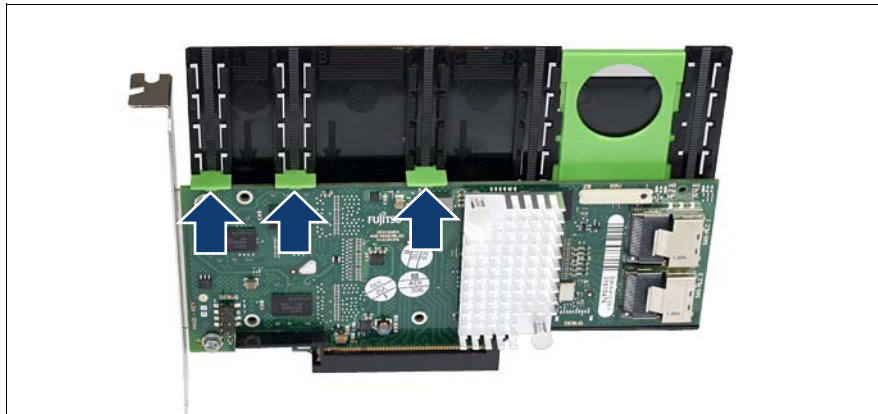

Figure 76: Removing the expansion card from the removal tool

- ▶ Lift the green movable engaging hooks no more than approximately 1 mm until the expansion card is completely released.
- ▶ Take the expansion card out and put it aside.



### **CAUTION!**

The engaging hooks may easily be damaged if too much pressure is applied.

## 8.6.6 Removing the engaging hooks

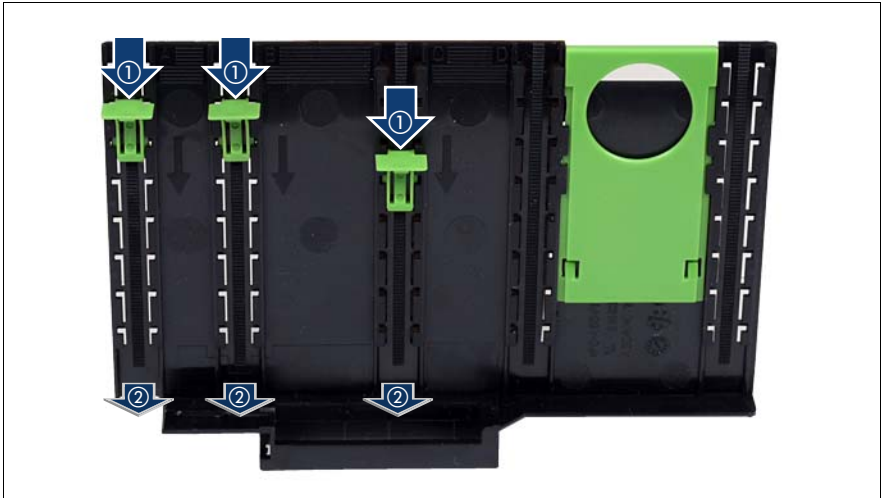

Figure 77: Removing the engaging hooks

- ▶ Push the green engaging hooks down in the direction of the arrows (1) until they disengage from the removal tool.
- ▶ Remove the engaging hooks (2) and keep them in a safe place.

## 8.6.7 Inserting an expansion card in the removal tool

Please choose one of the following procedures:

- ["Long expansion cards" on page 128](#)
- ["Short expansion cards such as the network adapter D2735" on page 128](#)

Complete the procedure by performing ["Check the result of the installation for all expansion cards" on page 129](#).

### Long expansion cards



Figure 78: Inserting the expansion card in the removal tool

- ▶ Insert the expansion card in the slot of the removal tool.
- ▶ Insert the green engaging hooks in the rods and push them down until they engage in the upper edge of the expansion card.

**i** Make sure that e.g. the ports on the expansion card are not blocked by the engaging hooks.

### Short expansion cards such as the network adapter D2735

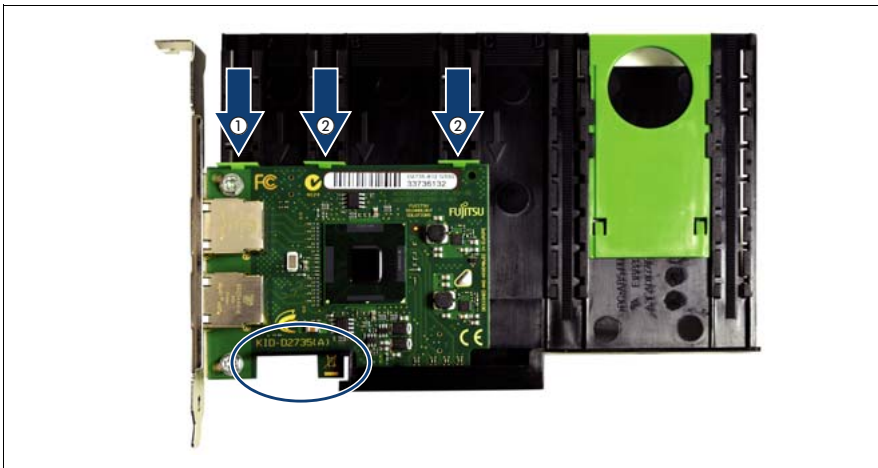

Figure 79: Inserting a short expansion card in the removal tool

- ▶ Insert the expansion card in the removal tool so that its recesses fit exactly in the removal tool (see circle) and fix the card with the engaging hook (1).
- ▶ Insert the other two green engaging hooks (2).

### Check the result of the installation for all expansion cards

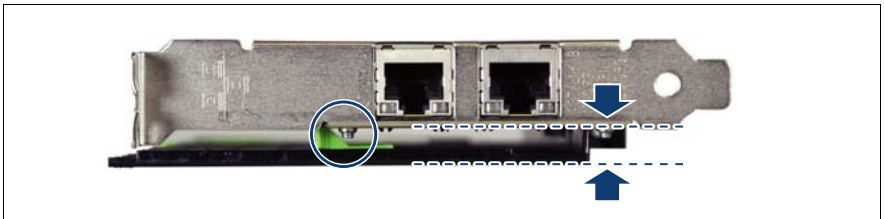

Figure 80: Position of the expansion card

- ▶ Check whether the expansion card is placed in parallel to the removal tool:



Make sure that the screw (see circle) does not interfere with the engaging hook.

## 8.6.8 Inserting the expansion card in the slot

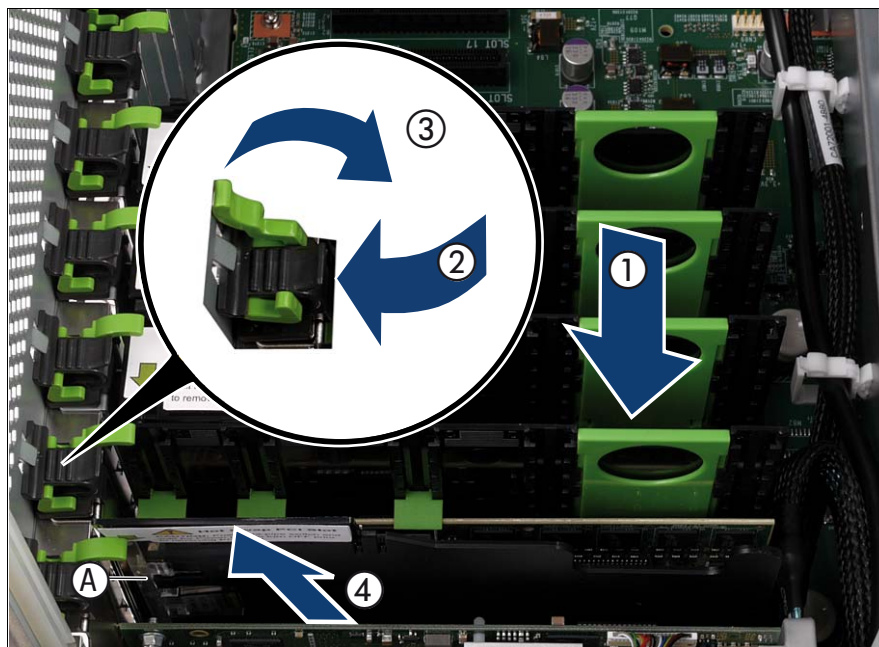

Figure 81: Inserting the expansion card in the slot

- ▶ Carefully insert the removal tool together with the expansion card in the slot (1).
- ▶ Insert the slot lock (2) and relock the slot (3).
- ▶ Close the hot-plug slot (4).
- ▶ If applicable, connect the cables on the expansion card.

### 8.6.9 Activating the expansion card

- ▶ Activate the expansion card using either the related PCI hot-plug software or by pressing the light-pipe switch, see A in [Figure 69](#).

The light-pipe switch flashes green. The slot is in the enable sequence.

- ▶ Wait until the light-pipe switch is constantly green.

The slot is now powered on.



If the light-pipe switch continues to flash, an error has occurred.

Remove the expansion card and repeat the procedure as described above.

### 8.6.10 Completing the task

- ▶ Perform the following procedures to complete the task:
  1. ["Installing the rear cover" on page 48](#)
  2. ["Mounting the server in the rack" on page 49](#)
  3. ["Closing the rack door" on page 51](#)

## 8.7 Installing a non-hot-plug expansion card



### Authorized personnel

Authorized specialist personnel can carry out replacement tasks for integral server components. Ask your local Fujitsu service center for more detailed information.



### CAUTION!

Procedures indicated as "Authorized personnel only" must be done by Fujitsu service personnel or technicians trained by Fujitsu for doing these tasks. Please note that unauthorized interference with the system will void the warranty and exempt the manufacturer from all liability.



### CAUTION!

- Before installing/removing expansion cards to/from the server, turn off the server, all peripheral devices, and any other connected devices. Also unplug all power cables from the power outlet. Failure to do so can cause electric shock.
- The circuit boards and soldered parts of internal options are exposed and can be damaged by static electricity. Before handling them, first touch a metal part on the server to discharge static electricity from your body.
- Do not touch the circuitry on boards and soldered parts. Hold the metallic areas or the edge of the circuit boards.
- Follow the safety instructions in the "[Safety instructions](#)" on page 31.

### 8.7.1 Required tools

- Starting and completing the task:
  - key for the rack doors (if applicable)
  - Phillips Ph2 screw driver
- Installing the expansion card: tool-less



## 8.7.2 Starting the task

- ▶ Perform the following procedures:
  1. "Opening the rack door" on page 40
  2. "Shutting down the server" on page 41
  3. "Sliding the server out of the rack" on page 42
  4. "Removing the rear cover" on page 46
  5. If applicable: "Mounting expansion card slot brackets" on page 107
  6. If applicable: "Preparing the SFP+ transceiver module" on page 115

## 8.7.3 Removing the PCI Riser (if applicable)



Figure 82: Removing the PCI Riser

- ▶ Press the green button (1).
- ▶ Lift the handle (2) to disconnect the PCI Riser (PCIR) from the baseboard.
- ▶ Pull the PCIR up and out by using the handle (3).

### 8.7.4 Removing the slot cover

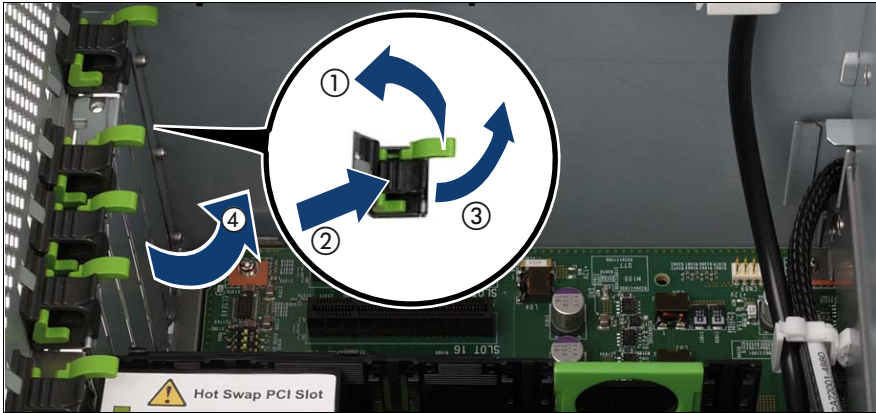

Figure 83: Removing the slot cover

- ▶ Remove the slot lock by pulling the green handle upward (1), pushing the plastic part down (2) and lifting the slot lock (3).
- ▶ Remove the slot cover (4).

### 8.7.5 Inserting the expansion card in the slot

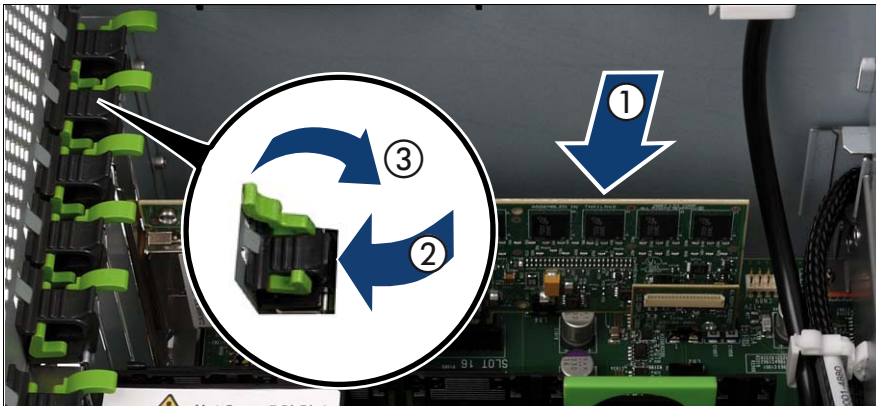

Figure 84: Inserting the expansion card in the slot

- ▶ Carefully insert the expansion card in the slot (1).
- ▶ Insert the slot lock (2) and relock the slot (3).
- ▶ If applicable, connect the cables on the expansion card.

### 8.7.6 Installing the PCI Riser (if applicable)



Figure 85: Installing the PCI Riser

- ▶ Carefully insert the PCIR in the slot (1).
- ▶ Lock the PCIR by pushing down the handle (2).

### 8.7.7 Completing the task

- ▶ Perform the following procedures to complete the task:
  1. ["Installing the rear cover" on page 48](#)
  2. ["Mounting the server in the rack" on page 49](#)
  3. ["Bringing the server back to operation" on page 51](#)
  4. ["Closing the rack door" on page 51](#)

## 8.8 Removing a non-hot-plug expansion card



### Authorized personnel

Authorized specialist personnel can carry out replacement tasks for integral server components. Ask you local Fujitsu service center for more detailed information.



### CAUTION!

Procedures indicated as "Authorized personnel only" must be done by Fujitsu service personnel or technicians trained by Fujitsu for doing these tasks. Please note that unauthorized interference with the system will void the warranty and exempt the manufacturer from all liability.



### CAUTION!

- Before installing/removing expansion cards to/from the server, turn off the server, all peripheral devices, and any other connected devices. Also unplug all power cables from the power outlet. Failure to do so can cause electric shock.
- The circuit boards and soldered parts of internal options are exposed and can be damaged by static electricity. Before handling them, first touch a metal part on the server to discharge static electricity from your body.
- Do not touch the circuitry on boards and soldered parts. Hold the metallic areas or the edge of the circuit boards.
- Follow the safety instructions in the ["Safety instructions" on page 31](#).

## 8.8.1 Required tools

- Starting and completing the task:
  - key for the rack doors (if applicable)
  - Phillips Ph2 screw driver
- Removing the expansion card: tool-less

## 8.8.2 Starting the task

- ▶ Perform the following procedures:
  1. ["Opening the rack door" on page 40](#)
  2. ["Shutting down the server" on page 41](#)
  3. ["Sliding the server out of the rack" on page 42](#)
  4. ["Removing the rear cover" on page 46](#)

### 8.8.3 Removing the PCI Riser (if applicable)



Figure 86: Removing the PCI Riser

- ▶ Press the green button (1).
- ▶ Lift the handle (2) to disconnect the PCI Riser (PCIR) from the baseboard.
- ▶ Pull the PCIR up and out by using the handle (3).

## 8.8.4 Removing the expansion card from the slot

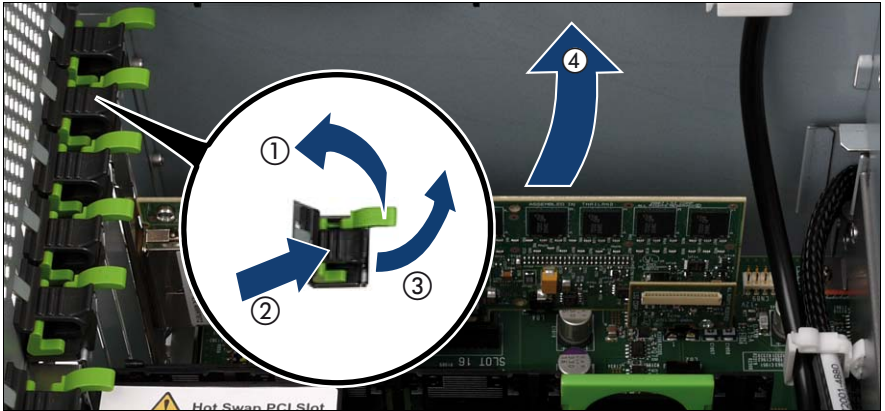

Figure 87: Removing the expansion card from the slot

- ▶ If applicable, remove the cables from the expansion card.

Remove the slot lock by pulling the green handle upward (1), pushing the plastic part down (2), and lifting the slot lock (3).

- ▶ Carefully pull the expansion card out of the slot (4).

## 8.8.5 Installing the slot cover

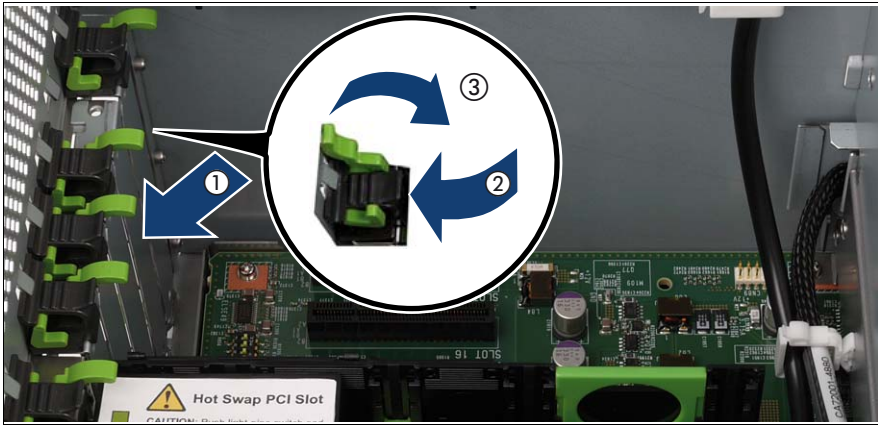

Figure 88: Installing the slot cover

- ▶ Install the slot cover (1).
- ▶ Insert the slot lock (2) and relock the slot (3).



## 8.8.6 Installing the PCI Riser (if applicable)



Figure 89: Installing the PCI Riser

- ▶ Carefully insert the PCIR in the slot (1).
- ▶ Lock the PCIR by pushing down the handle (2).

## 8.8.7 Completing the task

- ▶ Perform the following procedures to complete the task:
  1. ["Installing the rear cover" on page 48](#)
  2. ["Mounting the server in the rack" on page 49](#)
  3. ["Bringing the server back to operation" on page 51](#)
  4. ["Closing the rack door" on page 51](#)

# 8.9 Replacing a non-hot-plug expansion card



### Authorized personnel

Authorized specialist personnel can carry out replacement tasks for integral server components. Ask your local Fujitsu service center for more detailed information.



### CAUTION!

Procedures indicated as "Authorized personnel only" must be done by Fujitsu service personnel or technicians trained by Fujitsu for doing these tasks. Please note that unauthorized interference with the system will void the warranty and exempt the manufacturer from all liability.



### CAUTION!

- Before installing/removing expansion cards to/from the server, turn off the server, all peripheral devices, and any other connected devices. Also unplug all power cables from the power outlet. Failure to do so can cause electric shock.
- The circuit boards and soldered parts of internal options are exposed and can be damaged by static electricity. Before handling them, first touch a metal part on the server to discharge static electricity from your body.
- Do not touch the circuitry on boards and soldered parts. Hold the metallic areas or the edge of the circuit boards.
- Follow the safety instructions in the "[Safety instructions](#)" on page 31.



Only expansion cards of the same type and with the same settings may be exchanged. If the expansion cards do not match, the new expansion card will not be commissioned.

## 8.9.1 Required tools

- Starting and completing the task:
  - key for the rack doors (if applicable)
  - Phillips Ph2 screw driver
- Replacing the expansion card: tool-less

## 8.9.2 Starting the task

- ▶ Perform the following procedures:
  1. "Opening the rack door" on page 40
  2. "Locate the faulty server" on page 37
  3. "Shutting down the server" on page 41
  4. "Sliding the server out of the rack" on page 42
  5. "Removing the rear cover" on page 46
  6. "Locate the faulty component by PRIMERGY diagnostics indicators" on page 39
  7. If applicable: "Mounting expansion card slot brackets" on page 107
  8. If applicable: "Preparing the SFP+ transceiver module" on page 115

## 8.9.3 Removing the PCI Riser (if applicable)

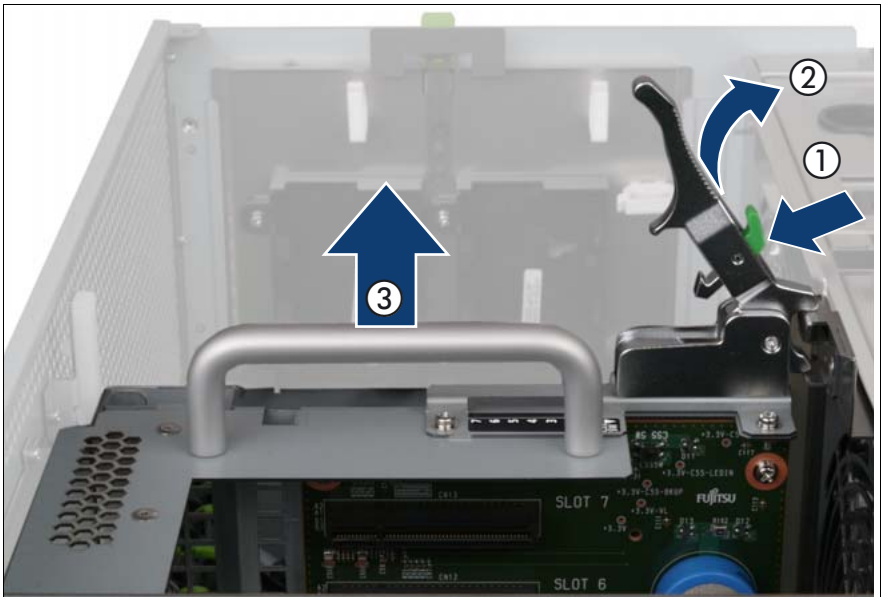

Figure 90: Removing the PCI Riser

- ▶ Press the green button (1).
- ▶ Lift the handle (2) to disconnect the PCI Riser (PCIR) from the baseboard.
- ▶ Pull the PCIR up and out by using the handle (3).

### 8.9.4 Removing the expansion card from the slot

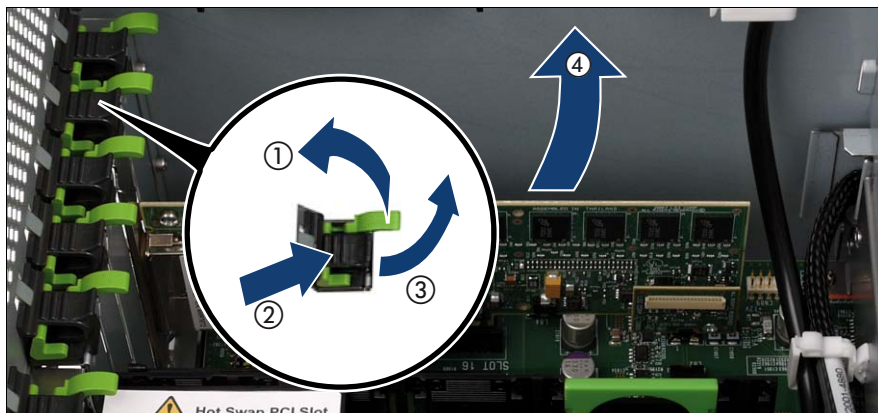

Figure 91: Removing the expansion card from the slot

- ▶ If applicable, remove the cables from the expansion card.  
Remove the slot lock by pulling the green handle upward (1), pushing the plastic part down (2), and lifting the slot lock (3).
- ▶ Carefully pull the expansion card out of the lot (4).

### 8.9.5 Inserting the expansion card in the slot

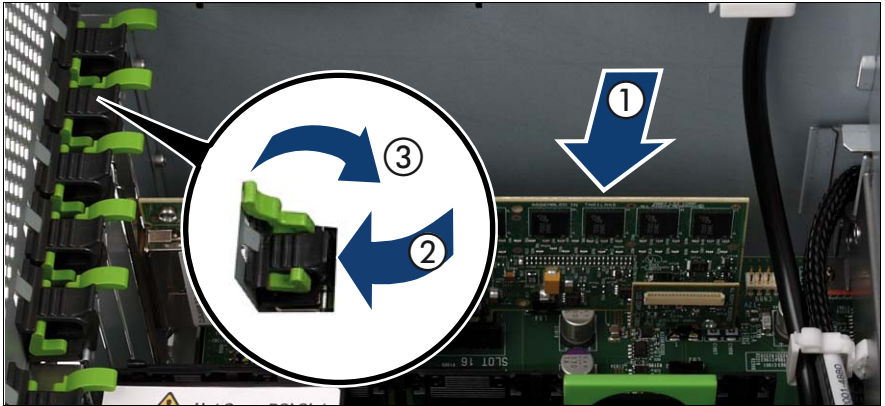

Figure 92: Inserting the expansion card in the slot

- ▶ Carefully insert the expansion card in the slot (1).
- ▶ Insert the slot lock (2) and relock the slot (3).
- ▶ If applicable, connect the cables on the expansion card.

## 8.9.6 Installing the PCI Riser (if applicable)



Figure 93: Installing the PCI Riser

- ▶ Carefully insert the PCIR in the slot (1).
- ▶ Lock the PCIR by pushing down the handle (2).

## 8.9.7 Completing the task

- ▶ Perform the following procedures to complete the task:
  1. ["Installing the rear cover" on page 48](#)
  2. ["Mounting the server in the rack" on page 49](#)
  3. ["Bringing the server back to operation" on page 51](#)
  4. ["Closing the rack door" on page 51](#)

## 8.10 Replacing the Modular RAID controller



### Authorized personnel

Authorized specialist personnel can carry out replacement tasks for integral server components. Ask your local Fujitsu service center for more detailed information.



### CAUTION!

Procedures indicated as "Authorized personnel only" must be done by Fujitsu service personnel or technicians trained by Fujitsu for doing these tasks. Please note that unauthorized interference with the system will void the warranty and exempt the manufacturer from all liability.



### CAUTION!

- Before installing/removing expansion cards to/from the server, turn off the server, all peripheral devices, and any other connected devices. Also unplug all power cables from the power outlet. Failure to do so can cause electric shock.
- The circuit boards and soldered parts of internal options are exposed and can be damaged by static electricity. Before handling them, first touch a metal part on the server to discharge static electricity from your body.
- Do not touch the circuitry on boards and soldered parts. Hold the metallic areas or the edge of the circuit boards.
- Follow the safety instructions in the ["Safety instructions" on page 31](#).

### 8.10.1 Required tools

- Starting and completing the task:
  - key for the rack doors (if applicable)
  - Phillips Ph2 screw driver
- Replacing the expansion card: tool-less

### 8.10.2 Starting the task

- ▶ Perform the following procedures:
  1. "Opening the rack door" on page 40
  2. "Locate the faulty server" on page 37
  3. "Shutting down the server" on page 41
  4. "Sliding the server out of the rack" on page 42
  5. "Removing the rear cover" on page 46
  6. "Locate the faulty component by PRIMERGY diagnostics indicators" on page 39

### 8.10.3 Removing the PCI Riser



Figure 94: Removing the PCI Riser



- ▶ Press the green button (1).
- ▶ Lift the handle (2) to disconnect the PCI Riser (PCIR) from the baseboard.
- ▶ Pull the PCIR up and out by using the handle (3).

#### 8.10.4 Removing the Modular RAID controller

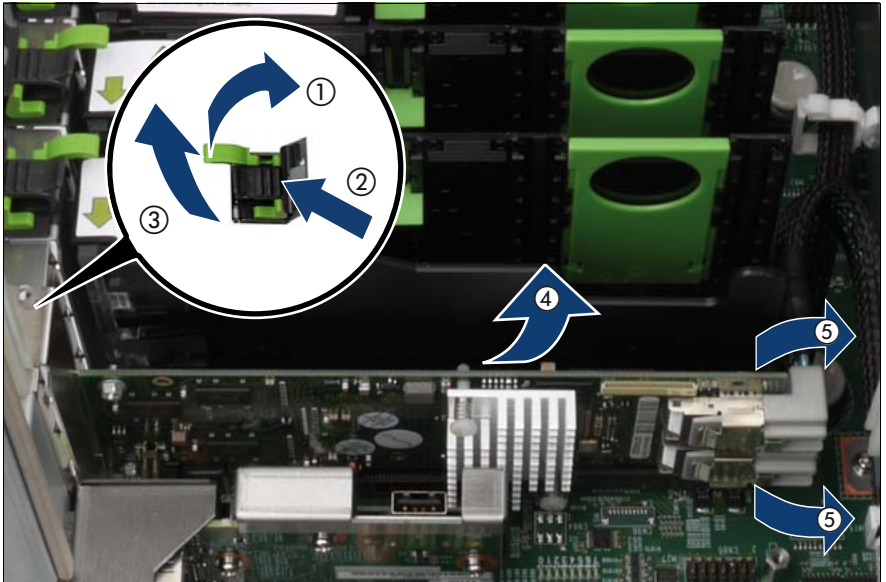

Figure 95: Removing the Modular RAID controller from the slot

- ▶ Remove the slot lock by pulling the green handle upward (1), pushing the plastic part down (2), and lifting the slot lock (3).
- ▶ Carefully pull the Modular RAID controller out of the lot (4).
- ▶ Disconnect the SAS cables from the Modular RAID controller ports.

### 8.10.5 Inserting the Modular RAID controller



Figure 96: Connecting the SAS cables

- ▶ Connect the SAS cables to the Modular RAID controller ports as follows:
  - MLC1 port (A): HDD/SSD modules #0, #1, #2, #3
  - MLC2 port (B): HDD/SSD modules #4, #5, #6, #7

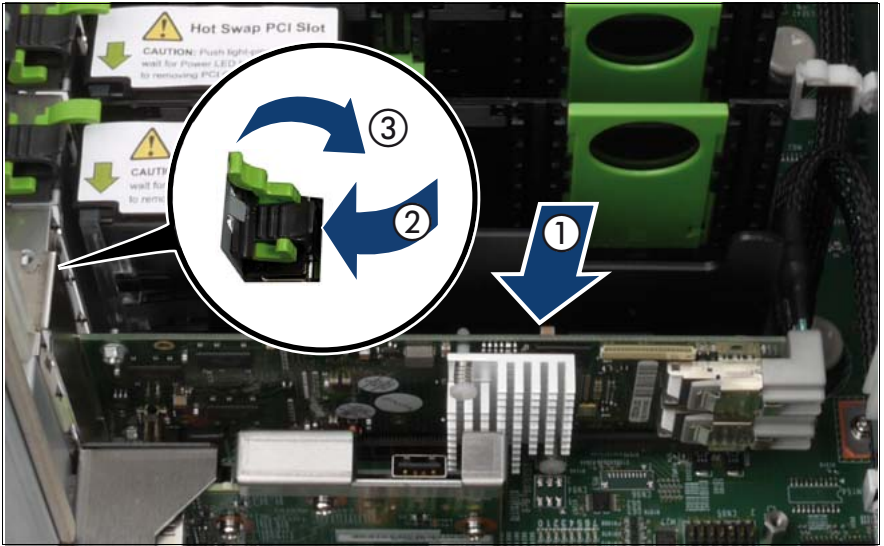

Figure 97: Inserting the Modular RAID controller

- ▶ Carefully insert the Modular RAID controller in its slot (1).
- ▶ Insert the slot lock (2) and relock the slot (3).

## 8.10.6 Installing the PCI Riser



Figure 98: Installing the PCI Riser

- ▶ Carefully insert the PCIR in the slot (1).
- ▶ Lock the PCIR by pushing down the handle (2).

## 8.10.7 Completing the task

- ▶ Perform the following procedures to complete the task:
  1. ["Installing the rear cover" on page 48](#)
  2. ["Mounting the server in the rack" on page 49](#)
  3. ["Bringing the server back to operation" on page 51](#)
  4. ["Closing the rack door" on page 51](#)

## 8.11 Installing a Battery Backup Unit (BBU)



### Authorized personnel

Authorized specialist personnel can carry out replacement tasks for integral server components. Ask your local Fujitsu service center for more detailed information.



### CAUTION!

Procedures indicated as "Authorized personnel only" must be done by Fujitsu service personnel or technicians trained by Fujitsu for doing these tasks. Please note that unauthorized interference with the system will void the warranty and exempt the manufacturer from all liability.



### CAUTION!

- Do not connect the cable using excessive force, the connector is weak.
- Follow the safety instructions in the ["Safety instructions" on page 31](#).

The Battery Backup Unit (BBU) backs up the memory contents of the SAS RAID controller in the event of a power failure. A maximum of two BBUs can be installed for each system.



The RX900 S1 server can be equipped with one Modular RAID controller and two SAS RAID controllers but only for two of these RAID controllers a BBU can be installed.

### 8.11.1 Required tools

- Starting and completing the task:
  - key for the rack doors (if applicable)
  - Phillips Ph2 screw driver
- Installing the BBU: tool-less

### 8.11.2 Starting the task

- ▶ Perform the following procedures:
  1. "Opening the rack door" on page 40
  2. "Shutting down the server" on page 41
  3. "Sliding the server out of the rack" on page 42
  4. "Removing the rear cover" on page 46

### 8.11.3 Connecting the BBU cable to the BBU

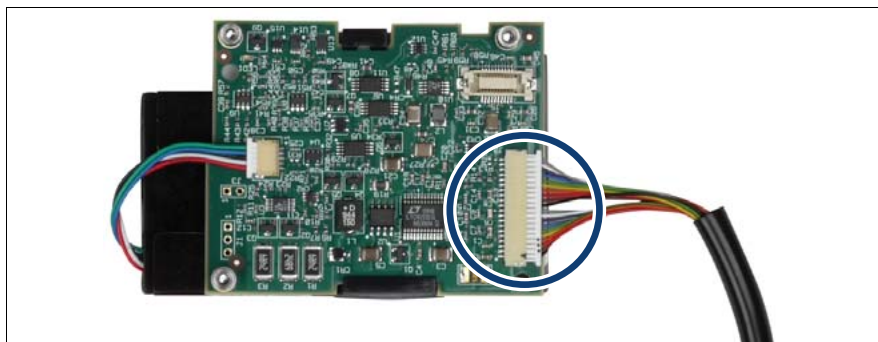

Figure 99: Connecting the BBU cable

- ▶ Connect the BBU cable to the battery.



The cable can only be installed in one direction. Make sure that the markings on the connector are aligned with the corresponding marking on the socket.

### 8.11.4 Installing the BBU in the BBU holder

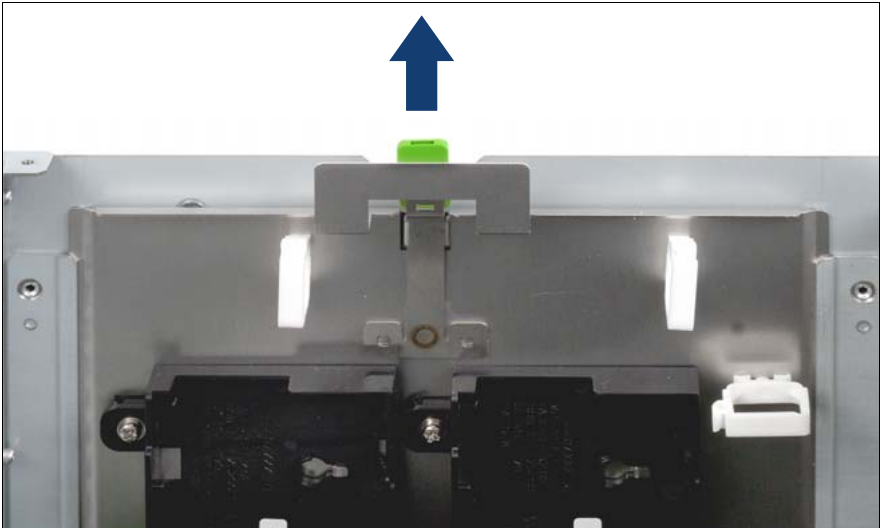

Figure 100: Removing the BBU holder

- Remove the BBU holder from the chassis by lifting it with the green handle.

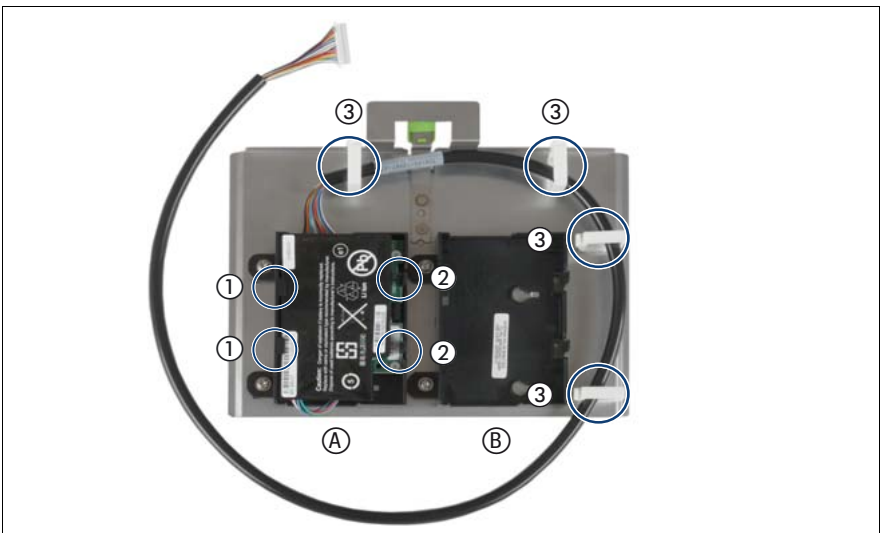

Figure 101: Installing the BBU in the BBU holder

## Expansion cards and BBU

---

- ▶ Select the battery holder as follows:
  - **A:** Insert the BBU for the Modular RAID controller in PCIe slot #8.
  - **B:** Inset the BBU for one of the SAS RAID controllers.
- ▶ Insert the battery at a slight angle behind the clips (1).
- ▶ Carefully press the battery into the holder until it engages under the two locking hooks (2).
- ▶ Route the BBU cable through the cable clamps (3).
- ▶ Install the BBU holder with the BBU in the chassis.



## 8.11.5 Connecting the BBU to the Modular RAID controller

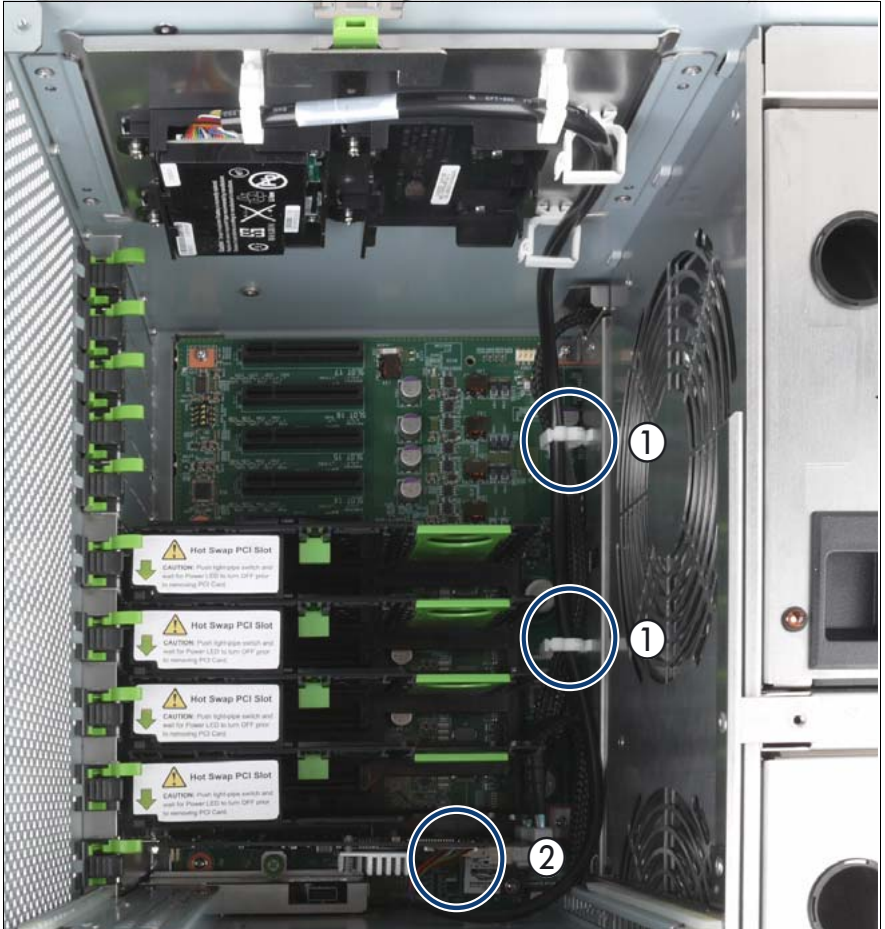

Figure 102: Connecting the BBU to the Modular RAID controller

- ▶ Route the BBU cable through the cable clamps (1).



Avoid cable loops in the PCIe slot area. The BBU cable must be fixed in the cable clamps (1).

- ▶ Connect the BBU cable to the Modular RAID controller (2).



The cable can only be installed in one direction. To distinguish both sides of the BBU plug, there is a tiny triangle in the corner of one of the sides.

### 8.11.6 Completing the task

- ▶ Perform the following procedures to complete the task:
  1. ["Installing the rear cover" on page 48](#)
  2. ["Mounting the server in the rack" on page 49](#)
  3. ["Bringing the server back to operation" on page 51](#)
  4. ["Closing the rack door" on page 51](#)

## 8.12 Replacing a Battery Backup Unit (BBU)



### Authorized personnel

Authorized specialist personnel can carry out replacement tasks for integral server components. Ask your local Fujitsu service center for more detailed information.



### CAUTION!

Procedures indicated as "Authorized personnel only" must be done by Fujitsu service personnel or technicians trained by Fujitsu for doing these tasks. Please note that unauthorized interference with the system will void the warranty and exempt the manufacturer from all liability.



### CAUTION!

- Do not connect the cable using excessive force, the connector is weak.
- Dispose of used battery properly. Keep away from children.
- Follow the safety instructions in the ["Safety instructions" on page 31](#).

### 8.12.1 Required tools

- Starting and completing the task:
  - key for the rack doors (if applicable)
  - Phillips Ph2 screw driver
- Replacing the BBU: tool-less

### 8.12.2 Starting the task

- ▶ Perform the following procedures:
  1. ["Opening the rack door" on page 40](#)
  2. ["Shutting down the server" on page 41](#)
  3. ["Sliding the server out of the rack" on page 42](#)
  4. ["Removing the rear cover" on page 46](#)

### 8.12.3 Disconnecting the BBU from the Modular RAID controller

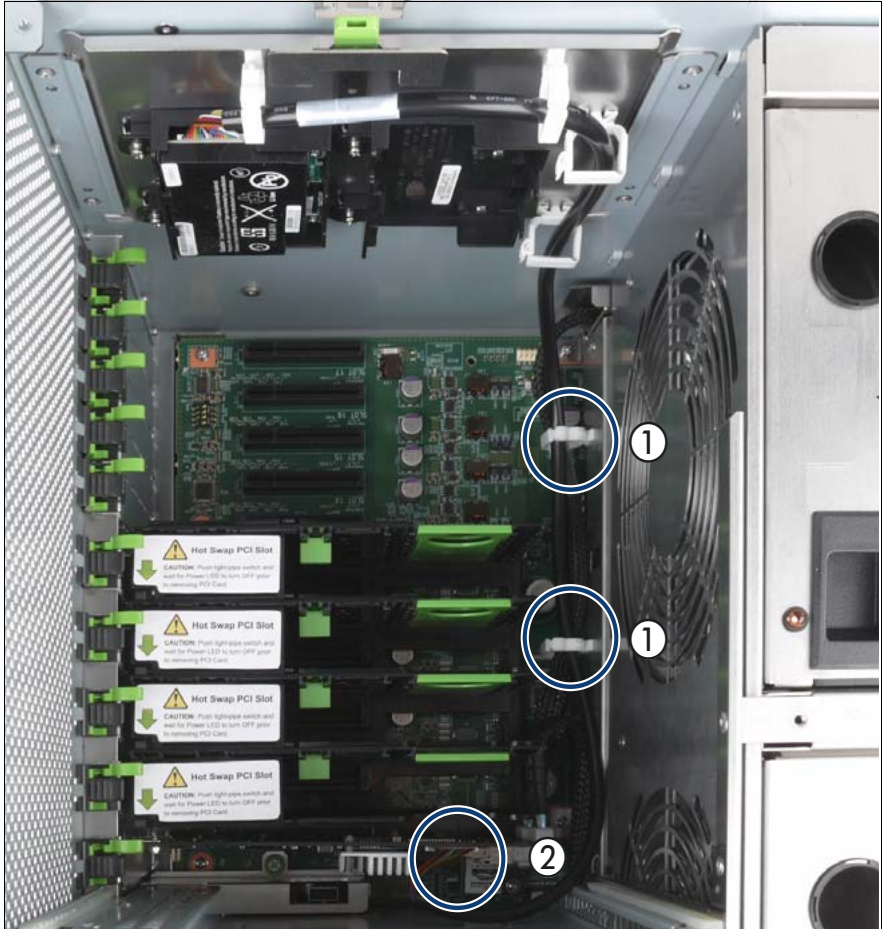

Figure 103: Disconnecting the BBU from the Modular RAID controller

- ▶ Open the cable clamps (1).
- ▶ Disconnect the BBU cable from the SAS RAID controller (2).
- ▶ Remove the BBU holder from the chassis by lifting it with the green handle.

### 8.12.4 Removing the BBU from the BBU holder

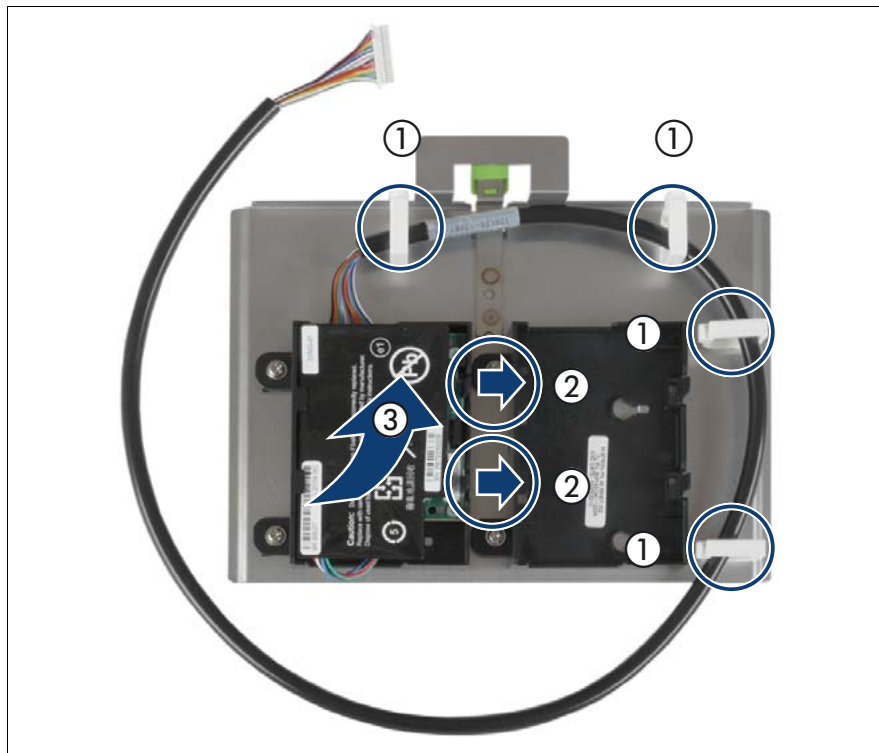

Figure 104: Removing the BBU from the BBU holder

- ▶ Open the cable clamps (1).
- ▶ Carefully press the two locking hooks (2) outward so that the BBU can be removed from the holder at a slight angle (3).

## 8.12.5 Disconnecting the BBU cable from the BBU

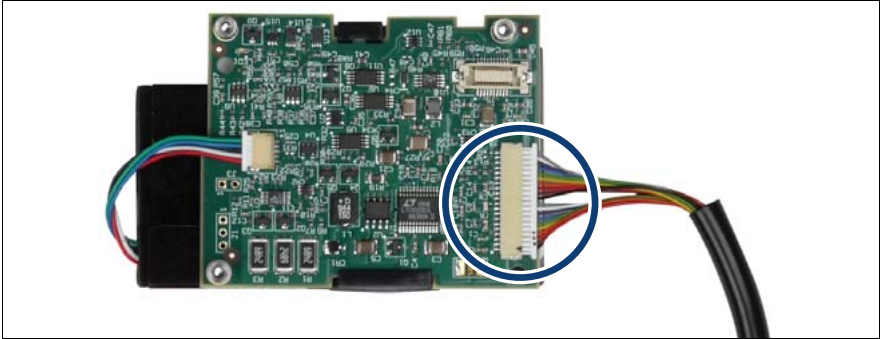

Figure 105: Disconnecting the BBU cable

- ▶ Disconnect the BBU cable from the battery.

## 8.12.6 Reinstalling a new BBU

- ▶ Perform the following two steps:
  1. ["Connecting the BBU cable to the BBU" on page 170](#)
  2. ["Installing the BBU in the BBU holder" on page 171](#)
  3. ["Connecting the BBU to the Modular RAID controller" on page 173](#)

## 8.12.7 Completing the task

- ▶ Perform the following procedures to complete the task:
  1. ["Installing the rear cover" on page 48](#)
  2. ["Mounting the server in the rack" on page 49](#)
  3. ["Bringing the server back to operation" on page 51](#)
  4. ["Closing the rack door" on page 51](#)





---

## 9 Main memory



### Authorized personnel

Authorized specialist personnel can carry out replacement tasks for integral server components. Ask your local Fujitsu service center for more detailed information.



### CAUTION!

Procedures indicated as "Authorized personnel only" must be done by Fujitsu service personnel or technicians trained by Fujitsu for doing these tasks. Please note that unauthorized interference with the system will void the warranty and exempt the manufacturer from all liability.



### CAUTION!

- The actions described in this section may only be performed by personnel with the appropriate technical training. (The device can be seriously damaged if it is opened without authorization or if repairs are attempted by untrained personnel.)
- Do not install unauthorized third party memory modules. Doing so may cause electric shock, a fire, or failures.
- Wait for a sufficient period of time after server shutdown before installing or removing memory modules. Failure to do so may cause burns. When installing or removing memory modules, make sure to remove the screws at the specified points only. Failure to do so may cause injury. It may also cause failures.
- Do not insert and remove memory modules repeatedly. Doing so may cause failures.
- If the memory module has not been correctly inserted, it may cause a fire. Insert the memory module with attention to its direction.
- If a memory module is installed and you pull the lever strongly outwards, the memory module pops up. Doing so may cause a device failure.
- Please observe the safety information in "[Safety instructions](#)" on [page 31](#).

## Main memory

---

The baseboard can be configured with up to 8 CPUMEMRs. Each CPUMEMR includes one processor and can be equipped with up to 16 memory modules.

There are two ways to expand the main memory:

- Filling the empty slots of an already populated CPUMEMRs, see "[Installing additional DIMM memory modules](#)" on page 191.
- Installing an additional CPUMEMRs, see "[Installing a CPUMEMR](#)" on page 183.



The number and location of available PCIe slots depends on the CPUMEMR configuration. Make sure that the planned CPUMEMR configuration enables you to use the PCIe slots needed for the individual use case of the server.

For detailed information on configuration rules and supported memory modules see "Baseboard D3081, CPUMEMR D3131, PCIR D3082 for PRIMERGY RX900 S1 Technical Manual" or in the configurator using the following link:

[http://ts.fujitsu.com/products/standard\\_servers/rack/primergy\\_rx900s1.html](http://ts.fujitsu.com/products/standard_servers/rack/primergy_rx900s1.html)  
(for the EMEA market).

## 9.1 Installing a CPUMEMR



### Authorized personnel

Authorized specialist personnel can carry out replacement tasks for integral server components. Ask your local Fujitsu service center for more detailed information.



### CAUTION!

Procedures indicated as "Authorized personnel only" must be done by Fujitsu service personnel or technicians trained by Fujitsu for doing these tasks. Please note that unauthorized interference with the system will void the warranty and exempt the manufacturer from all liability.



The CPUMEMRs must be installed according to the configuration rules summarized in "[Selecting the CPUMEMR slot](#)" on page 184 and described in the "Baseboard D3081, CPUMEMR D3131, PCIR D3082 for PRIMERGY RX900 S1 Technical Manual".

### 9.1.1 Required tools

- Starting and completing the task:
  - key for the rack doors (if applicable)
  - Phillips Ph2 screw driver
- Installing the CPUMEMR: tool-less

### 9.1.2 Starting the task

- ▶ Perform the following procedures:
  1. "[Opening the rack door](#)" on page 40
  2. "[Shutting down the server](#)" on page 41
  3. "[Sliding the server out of the rack](#)" on page 42
  4. "[Opening the server](#)" on page 44

### 9.1.3 Populating the CPUMEMR

- ▶ Populate the DIMM memory module slots by using the following procedures:
  1. ["Selecting the DIMM memory module slot" on page 192](#)
  2. ["Inserting the DIMM memory module in the slot" on page 194](#)

### 9.1.4 Selecting the CPUMEMR slot

- ▶ Choose the CPUMEMR slot according to the configuration rules summarized in this section. For detailed information see "Baseboard D3081, CPUMEMR D3131, PCIR D3082 for PRIMERGY RX900 S1 Technical Manual".

The basic configuration includes four CPUMEMRs. This configuration can be expanded in two steps. Each step includes two additional CPUMEMRs. In the 4 and 6 CPUMEMR configurations, an air duct is installed in an empty slot as indicated in [table 3](#).

Number of CPUMEMRs	Population order	CPUMEMR position	Air duct position
4	1	#1 + #2 + #3 + #4	#6
6	2	#5 + #6	#8
8	3	#7 + #8	--

Table 3: Population order for CPUMEMRs



Make sure that the selected CPUMEMR configuration enables you to use the PCIe slots needed for the individual use case of the server. For the assignment of CPUMEMRs to PCIe slots see ["PCIe slot to CPUMEMR assignment" on page 362](#).

[Figure 106](#) shows the CPUMEMR slots #1- #8 (from bottom to top). The slots populated in the basic configuration are indicated by the blue color.



Figure 106: CPUMEMR slot assignment

### 9.1.5 Removing the air duct (if applicable)

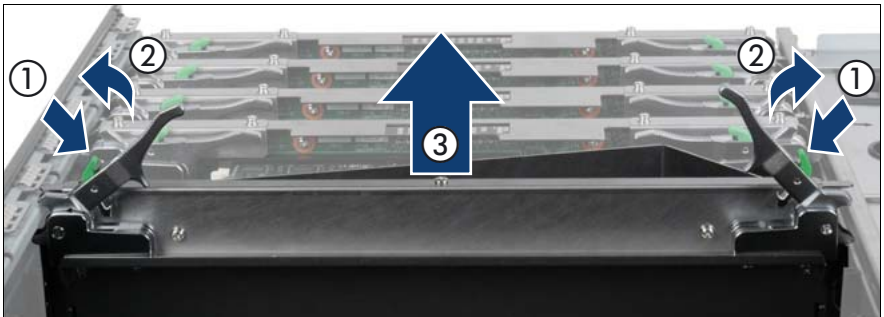

Figure 107: Removing an air duct

- ▶ Press the green buttons (1).
- ▶ Lift the handles (2) to disconnect the air duct from the baseboard.
- ▶ Carefully pull the air duct up and out (3).

### 9.1.6 Inserting the CPUMEMR in the slot



Figure 108: Inserting the CPUMEMR in the slot

- ▶ Carefully insert the CPUMEMR in the slot.



Please make sure that you place the PCB and not the metal shield in the guides (1).

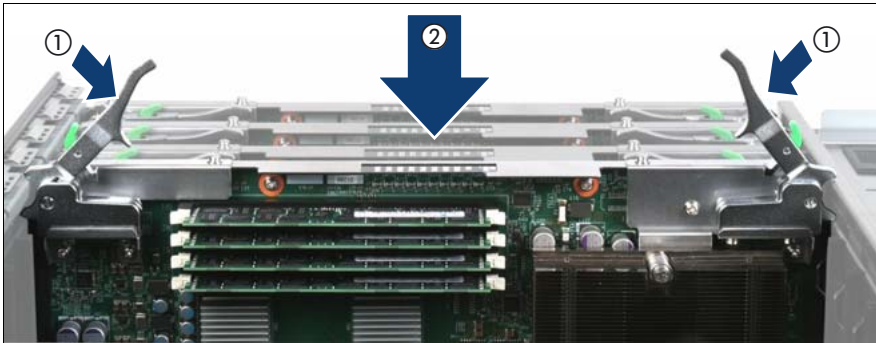

Figure 109: Locking the CPUMEMR

- ▶ Lock the CPUMEMR by pushing down the handles (1).
- ▶ Ensure that the CPUMER is connected properly to the baseboard by pushing it carefully down until it clicks into place (2).

## 9.1.7 Inserting the air duct in the slot (if applicable)

Only applicable for 4 and 6 CPUMEMR configurations.

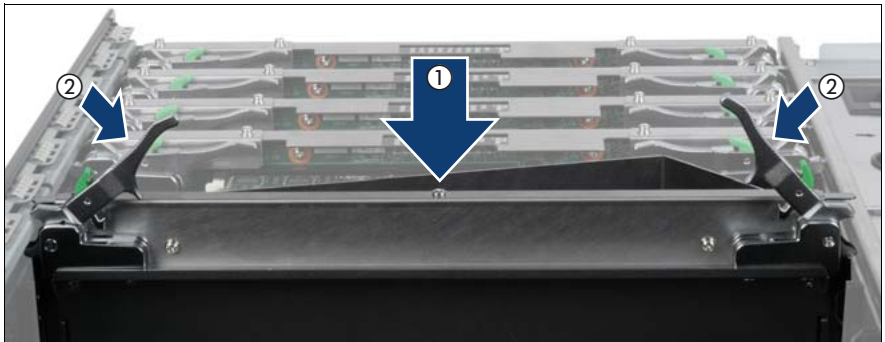

Figure 110: Inserting the air duct

- ▶ Insert the air duct in the CPUMEMR slot (1) as follows:
  - 4 CPUMEMR configuration: slot 6
  - 6 CPUMEMR configuration: slot 8
- ▶ Lock the air duct by pushing down the handles (1).

## 9.1.8 Completing the task

- ▶ Perform the following procedures to complete the task:
  1. ["Closing the server" on page 47](#)
  2. ["Mounting the server in the rack" on page 49](#)
  3. ["Bringing the server back to operation" on page 51](#)
  4. ["Closing the rack door" on page 51](#)

# 9.2 Replacing a faulty CPUMEMR



### Authorized personnel

Authorized specialist personnel can carry out replacement tasks for integral server components. Ask your local Fujitsu service center for more detailed information.



### CAUTION!

Procedures indicated as "Authorized personnel only" must be done by Fujitsu service personnel or technicians trained by Fujitsu for doing these tasks. Please note that unauthorized interference with the system will void the warranty and exempt the manufacturer from all liability.

## 9.2.1 Required tools

- Starting and completing the task:
  - key for the rack doors (if applicable)
  - Phillips Ph2 screw driver
- Replacing the CPUMEMR: tool-less

## 9.2.2 Starting the task

- ▶ Perform the following procedures:
  1. ["Opening the rack door" on page 40](#)
  2. ["Locate the faulty server" on page 37](#)
  3. ["Shutting down the server" on page 41](#)
  4. ["Sliding the server out of the rack" on page 42](#)
  5. ["Opening the server" on page 44](#)



### 9.2.3 Identifying a fault on the CPUMEMR

CPUMEMRs provide PRIMERGY Diagnostics indicators to indicate faulty CPUMEMRs, CPUs, or DIMM memory modules see [figure 111](#).

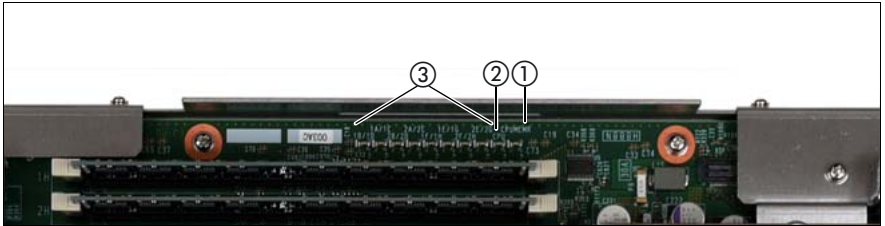

Figure 111: Indicators on the CPUMEMR

1	CSS indicator for the CPUMEMR (orange)	3	8x CSS indicators for each DIMM memory module pair (orange)
2	CSS indicator for the CPU (orange)		

- ▶ Press the CSS button that is located on the PCI Riser to identify a faulty CPUMEMR or a faulty unit on the CPUMEMR, see "[Locate the faulty component by PRIMERGY diagnostics indicators](#)" on page 39.
- ▶ Take a note on the faulty component indicated by the indicator:
  - Number of the CPUMEMR
  - Faulty component
  - For DIMM memory modules: Identifier of the slot

### 9.2.4 Removing the CPUMEMR

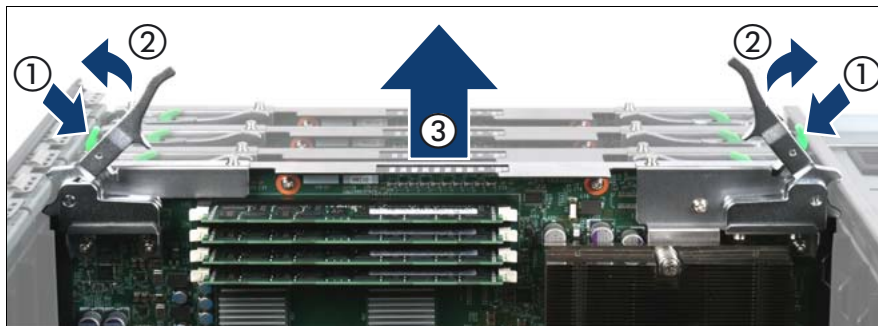

Figure 112: Removing a CPUMEMR

- ▶ Press the green buttons (1).
- ▶ Lift the handles (2) to disconnect the CPUMEMR from the baseboard.
- ▶ Carefully pull the CPUMEMR up and out (3).

### 9.2.5 Reinstalling a new CPUMEMR

- ▶ Populate the DIMM memory module slots:
  1. Cross-check the DIMM memory module configuration of the faulty CPUMEMR, see ["Selecting the DIMM memory module slot" on page 192](#).
  2. Insert all needed DIMM memory modules, see ["Inserting the DIMM memory module in the slot" on page 194](#).
- ▶ Reinstall the CPUMEMR:
  1. Cross-check the CPUMEMR configuration of the faulty CPUMEMR, see ["Selecting the CPUMEMR slot" on page 184](#).
  2. Insert the CPUMEMR, see ["Inserting the CPUMEMR in the slot" on page 186](#).

## 9.2.6 Completing the task

Perform the following procedures to complete the task:

1. ["Closing the server" on page 47](#)
2. ["Mounting the server in the rack" on page 49](#)
3. ["Bringing the server back to operation" on page 51](#)
4. ["Closing the rack door" on page 51](#)

## 9.3 Installing additional DIMM memory modules



### Authorized personnel

Authorized specialist personnel can carry out replacement tasks for integral server components. Ask your local Fujitsu service center for more detailed information.



### CAUTION!

Procedures indicated as "Authorized personnel only" must be done by Fujitsu service personnel or technicians trained by Fujitsu for doing these tasks. Please note that unauthorized interference with the system will void the warranty and exempt the manufacturer from all liability.

### 9.3.1 Required tools

- Starting and completing the task:
  - key for the rack doors (if applicable)
  - Phillips Ph2 screw driver
- Installing the DIMM memory module: tool-less

### 9.3.2 Starting the task

- ▶ Perform the following procedures:
  1. ["Opening the rack door" on page 40](#)
  2. ["Shutting down the server" on page 41](#)
  3. ["Sliding the server out of the rack" on page 42](#)
  4. ["Opening the server" on page 44](#)
  5. ["Removing the CPUMEMR" on page 190](#)

### 9.3.3 Selecting the DIMM memory module slot

- ▶ Choose the DIMM memory module slot according to the configuration rules summarized in this section. For detailed information see "Baseboard D3081, CPUMEMR D3131, PCIR D3082 for PRIMERGY RX900 S1 Technical Manual".

CPUMEMRs are populated in four steps. In each step, four DIMM memory modules are added. At least four DIMM memory modules must be installed on CPUMEMR #1 and #2. CPUMEMRs #3 to #8 can be left empty. [figure 113](#) and [table 4](#) show the population order for DIMM memory modules.

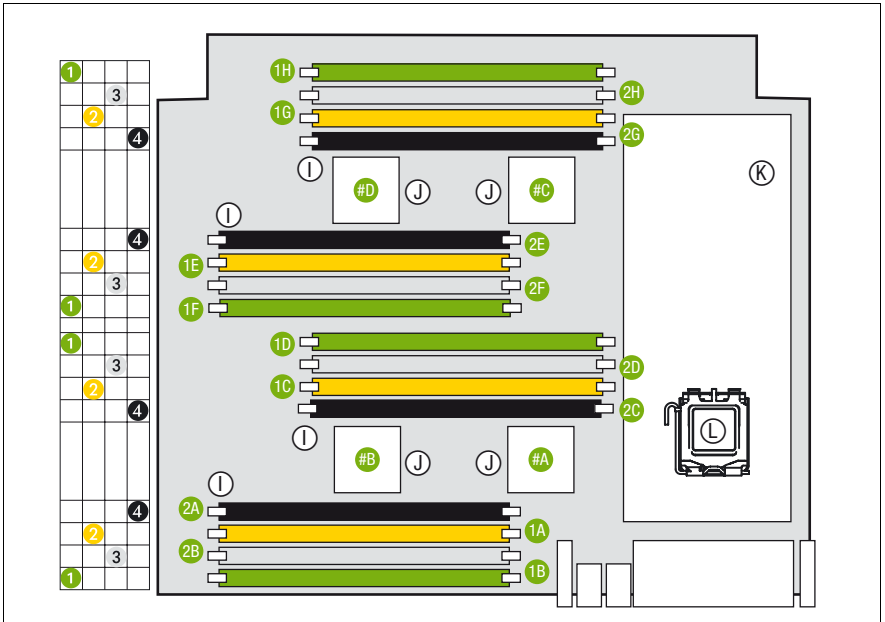

Figure 113: Population order for DIMM memory modules

Population order	DIMM position
1	1B + 1D + 1F + 1H
2	1A + 1C + 1E + 1G
3	2B + 2D + 2F + 2H
4	2A + 2C + 2E + 2G

Table 4: Population order for DIMM memory modules



Only use identical DIMM memory modules in the minimum configuration.

### 9.3.4 Inserting the DIMM memory module in the slot

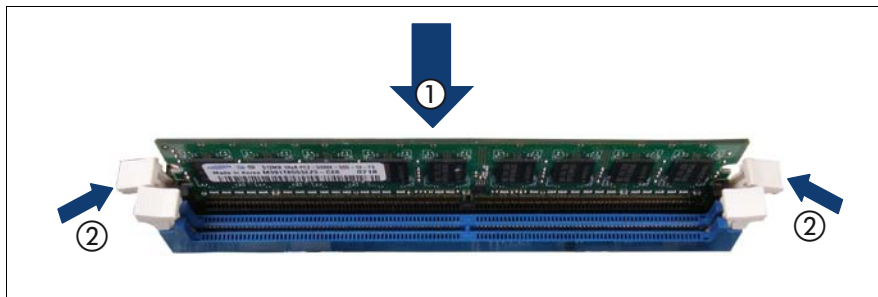

Figure 114: Inserting a DIMM memory module

- ▶ Carefully press the DIMM memory module into the slot (1) until the securing clips on both sides of it engage (2).

### 9.3.5 Completing the task

- ▶ Perform the following procedures to complete the task:
  1. ["Inserting the CPUMEMR in the slot" on page 186](#)
  2. ["Closing the server" on page 47](#)
  3. ["Mounting the server in the rack" on page 49](#)
  4. ["Bringing the server back to operation" on page 51](#)
  5. ["Closing the rack door" on page 51](#)

## 9.4 Replacing a faulty memory module



### Authorized personnel

Authorized specialist personnel can carry out replacement tasks for integral server components. Ask your local Fujitsu service center for more detailed information.



### CAUTION!

Procedures indicated as "Authorized personnel only" must be done by Fujitsu service personnel or technicians trained by Fujitsu for doing these tasks. Please note that unauthorized interference with the system will void the warranty and exempt the manufacturer from all liability.

### 9.4.1 Required tools

- Starting and completing the task:
  - key for the rack doors (if applicable)
  - Phillips Ph2 screw driver
- Replacing the DIMM memory module: tool-less

### 9.4.2 Starting the task

- ▶ Perform the following procedures:
  1. ["Opening the rack door" on page 40](#)
  2. ["Locate the faulty server" on page 37](#)
  3. ["Shutting down the server" on page 41](#)
  4. ["Sliding the server out of the rack" on page 42](#)

## Main memory

---

5. ["Opening the server" on page 44](#)
6. ["Locate the faulty component by PRIMERGY diagnostics indicators" on page 39](#)
7. ["Identifying a fault on the CPUMEMR" on page 189](#)
8. ["Removing the CPUMEMR" on page 190](#)

### 9.4.3 Removing the DIMM memory module

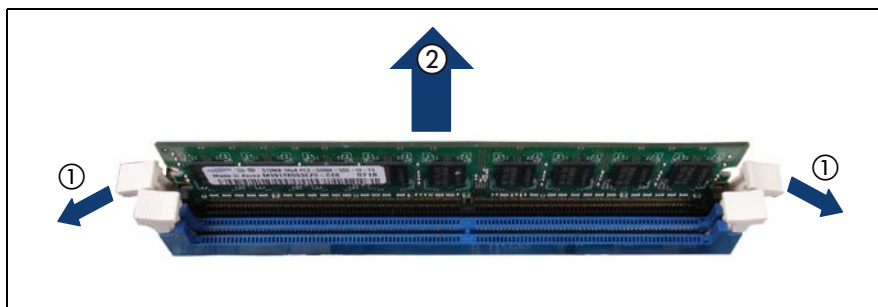

Figure 115: Removing the DIMM memory module

- ▶ Press the securing clips on either side of the DIMM memory module slot outward (1).
- ▶ Pull the DIMM memory module out of the slot (2).

### 9.4.4 Reinstalling a DIMM memory module

- ▶ Cross-check the DIMM memory module slot position with the configuration rules summarized in ["Selecting the DIMM memory module slot" on page 192](#). For detailed information see "Baseboard D3081, CPUMEMR D3131, PCIR D3082 for PRIMERGY RX900 S1 Technical Manual".



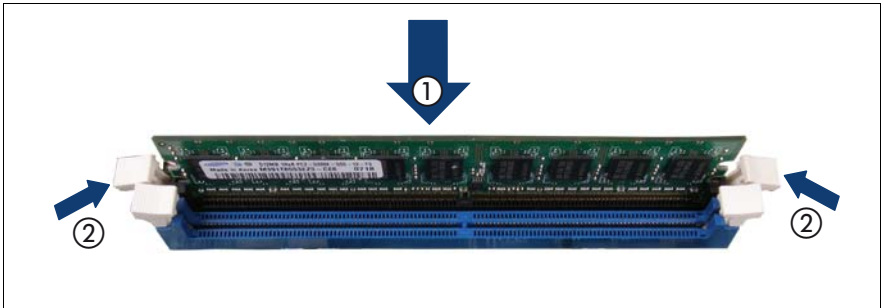

Figure 116: Installing a DIMM memory module

- ▶ Carefully press the DIMM memory module into the slot (1) until the securing clips on both sides of it engage (2).

### 9.4.5 Completing the task

- ▶ Perform the following procedures to complete the task:
  1. ["Inserting the CPUMEMR in the slot" on page 186](#)
  2. ["Closing the server" on page 47](#)
  3. ["Mounting the server in the rack" on page 49](#)
  4. ["Bringing the server back to operation" on page 51](#)
  5. Enter the BIOS menu, select the CPUMEMR where the replaced DIMM memory module is located and enable the replaced DIMM memory module.
  6. ["Closing the rack door" on page 51](#)



---

# 10 Processors



## Authorized personnel

Authorized specialist personnel can carry out replacement tasks for integral server components. Ask your local Fujitsu service center for more detailed information.



### CAUTION!

Procedures indicated as "Authorized personnel only" must be done by Fujitsu service personnel or technicians trained by Fujitsu for doing these tasks. Please note that unauthorized interference with the system will void the warranty and exempt the manufacturer from all liability.



### CAUTION!

- Before installing/removing processors to/from the server, turn off the server, all peripheral devices, and any other connected devices. Also unplug all power cords from the power outlet. Failure to do so can cause electric shock.
- Do not touch the circuitry on boards and soldered parts. Hold the metallic areas or the edge of the circuit boards.
- When installing the processor, be careful not to bend the spring contacts of the processor socket.
- Follow the safety instructions in "[Safety instructions](#)" on page 31.

## 10.1 Installing a processor in a new CPUMEMR

### Authorized personnel

Authorized specialist personnel can carry out replacement tasks for integral server components. Ask you local Fujitsu service center for more detailed information.



### CAUTION!

Procedures indicated as "Authorized personnel only" must be done by Fujitsu service personnel or technicians trained by Fujitsu for doing these tasks. Please note that unauthorized interference with the system will void the warranty and exempt the manufacturer from all liability.

A new CPUMEMR comes together with a heat sink. This procedure explains how to install a processor in a new CPUMEMR.



### CAUTION!

Only processors of the same type may be used in the server. That means the number of the internal processor cores as well as the primary clock and the FSB frequency have to be the same. For multi-processor operation, use a suitable multiprocessor operating system.

### 10.1.1 Required tools

- Starting and completing the task:
  - key for the rack doors (if applicable)
  - Phillips Ph2 screw driver
- Installing the processor:
  - Phillips Ph2 screw driver

## 10.1.2 Starting the task

- ▶ Perform the following procedures:
  1. ["Opening the rack door" on page 40](#)
  2. ["Shutting down the server" on page 41](#)
  3. ["Sliding the server out of the rack" on page 42](#)
  4. ["Opening the server" on page 44](#)
  5. ["Removing the CPUMEMR" on page 190](#)

## 10.1.3 Removing the socket cover



Figure 117: Removing the socket cover

- ▶ Release the socket lever by pressing it downward and outward (1).
- ▶ Open the socket lever and the processor holder (2).
- ▶ Hold the socket cover by the two grips between your thumb and index finger and lift it vertically upward (3).

### 10.1.4 Installing the processor

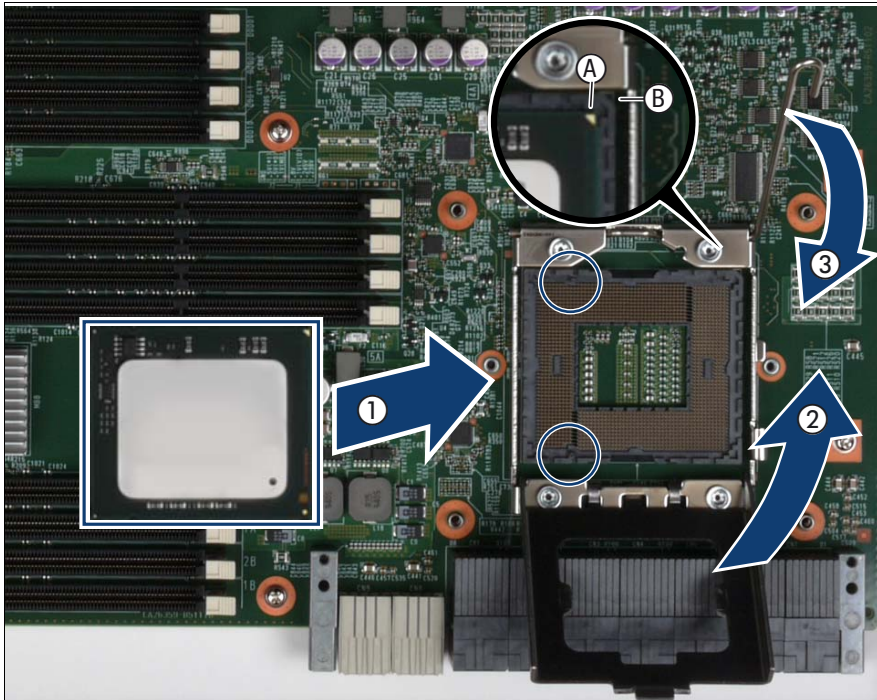

Figure 118: Inserting the processor

- ▶ Hold the processor between your thumb and index finger and align it at the socket coding.



**CAUTION!**

The processor can only be installed in one direction. Make sure that:

- the recesses on the processor (A) are aligned with the corresponding markings on the socket (B)
- the notches of the processor are aligned with the protrusions of the socket (see circle)

To avoid damaging the spring contacts, do not force the processor into the socket.

- ▶ Place the processor in the socket with great care.

**CAUTION!**

Do not move the processor within the socket. This would damage the spring contacts of the socket. Never touch the underside of the processor. Even light contaminants, such as oil from human skin, can destroy the processor or impair its functionality.

- ▶ Close the processor holder (2).
- ▶ Lock the processor in the socket by returning the socket lever back into its original position (3).

### 10.1.5 Applying the thermal paste



Figure 119: Measuring the thermal paste

- ▶ Use 0.2 grams of the supplied thermal paste, that is approximately one graduation mark of the provided application syringe.

One syringe contains thermal paste for 5 processors.

**CAUTION!**

Do not apply a mixture of different thermal paste types on the same processor.



Figure 120: Applying the thermal paste

- ▶ Apply the thermal paste in the center of the processor surface (see circle).
- ▶ Ensure a thin and even distribution of the thermal paste.



## 10.1.6 Installing the heat sink

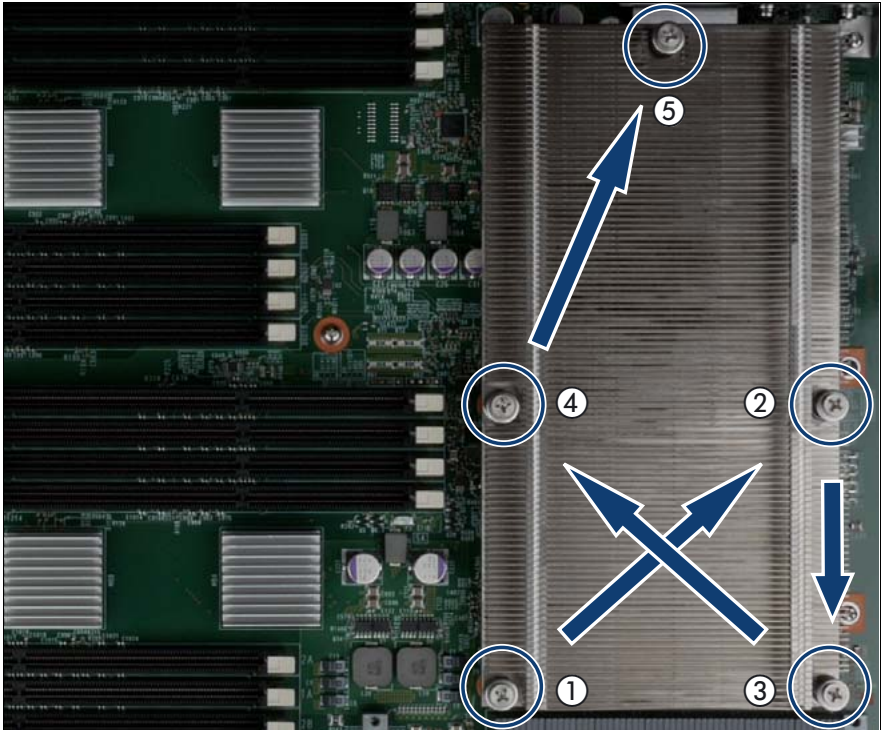

Figure 121: Installing the heat sink

- ▶ Carefully place the heat sink onto the processor.



### CAUTION!

Place the heat sink precisely on the threaded holes (see circles). Careless handling may damage conductors and render the baseboard useless.

- ▶ Fasten the heat sink with its five captive screws. Fasten the screws alternately until they are fully tightened:
  - Give each screw about 4 turns at a time.
  - Start with screw 1 to screw 5 as indicated in [figure 121](#) and continue with screw 1.
  - Torque: 0.6 Nm

### 10.1.7 Completing the task

- ▶ Perform the following procedures to complete the task:
  1. ["Inserting the CPUMEMR in the slot" on page 186](#)
  2. ["Closing the server" on page 47](#)
  3. ["Mounting the server in the rack" on page 49](#)
  4. ["Bringing the server back to operation" on page 51](#)
  5. ["Closing the rack door" on page 51](#)

## 10.2 Replacing a processor



### Authorized personnel

Authorized specialist personnel can carry out replacement tasks for integral server components. Ask you local Fujitsu service center for more detailed information.



### CAUTION!

Procedures indicated as "Authorized personnel only" must be done by Fujitsu service personnel or technicians trained by Fujitsu for doing these tasks. Please note that unauthorized interference with the system will void the warranty and exempt the manufacturer from all liability.



### CAUTION!

Only processors of the same type may be used on the baseboard. That means the number of the internal processor cores as well as the primary clock and the FSB frequency have to be the same. For multi-processor operation, use a suitable multiprocessor operating system.

## 10.2.1 Required tools

- Starting and completing the task:
  - key for the rack doors (if applicable)
  - Phillips Ph2 screw driver
- Replacing the processor:
  - Phillips Ph2 screw driver

## 10.2.2 Starting the task

- ▶ Perform the following procedures:
  1. ["Opening the rack door" on page 40](#)
  2. ["Locate the faulty server" on page 37](#)
  3. ["Shutting down the server" on page 41](#)
  4. ["Sliding the server out of the rack" on page 42](#)
  5. ["Opening the server" on page 44](#)
  6. ["Removing the CPUMEMR" on page 190](#)

### 10.2.3 Removing the heat sink

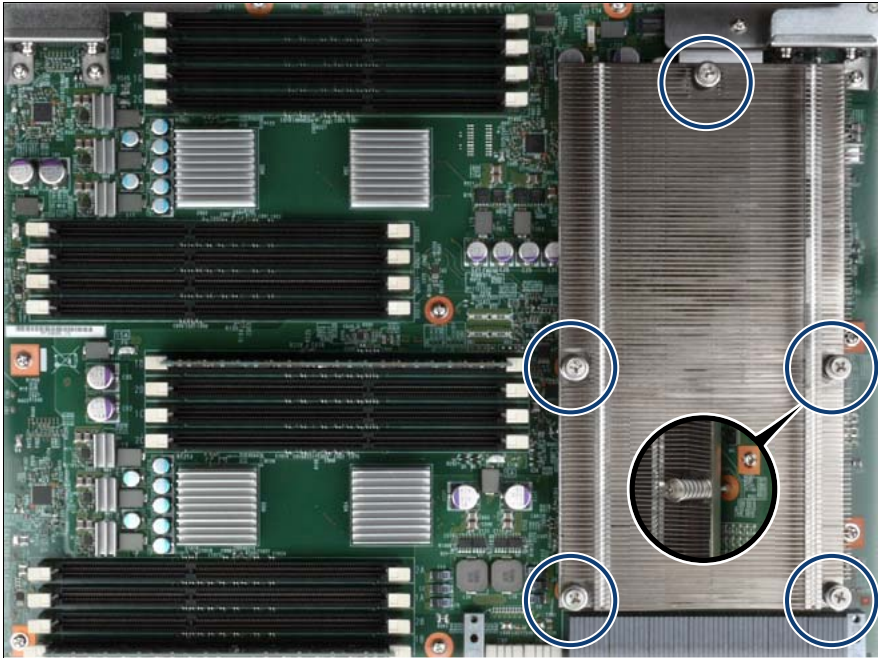

Figure 122: Removing the heat sink

- ▶ Loosen the captive screws of the heat sink alternately until they are fully released.
- ▶ Loosen the heat sink by turning it back and forth and then lift it out.

## 10.2.4 Removing the processor



Figure 123: Removing the processor

- ▶ Release the socket lever by pressing it downward and outward (1).
- ▶ Open the socket lever and the processor holder (2).
- ▶ Lift the installed processor carefully out of the socket (3).



### **CAUTION!**

Do not bend the spring contacts of the processor socket.

## 10.2.5 Installing the processor

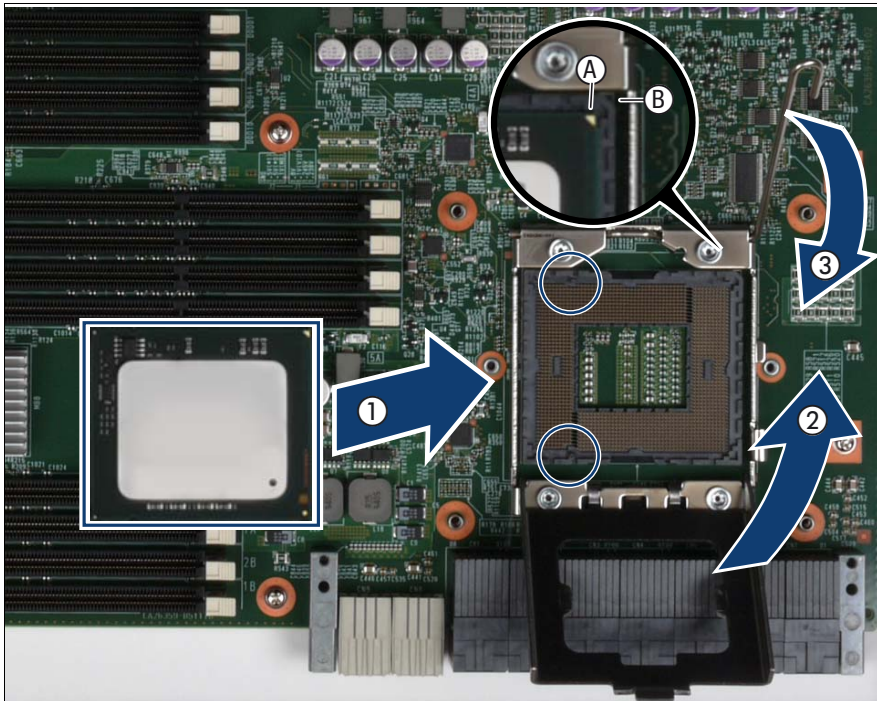

Figure 124: Inserting the processor

- ▶ Hold the processor between your thumb and index finger and align it at the socket coding.



### CAUTION!

The processor can only be installed in one direction. Make sure that:

- the recesses on the processor (A) are aligned with the corresponding markings on the socket (B)
- the notches of the processor are aligned with the protrusions of the socket (see circle)

To avoid damaging the spring contacts, do not force the processor into the socket.

- ▶ Place the processor in the socket with great care.

**CAUTION!**

Do not move the processor within the socket. This would damage the spring contacts of the socket. Never touch the underside of the processor. Even light contaminants, such as oil from human skin, can destroy the processor or impair its functionality.

- ▶ Close the processor holder (2).
- ▶ Lock the processor in the socket by returning the socket lever back into its original position (3).

## 10.2.6 Applying the thermal paste



Figure 125: Measuring the thermal paste

- ▶ Use 0.2 grams of the supplied thermal paste, that is approximately one graduation mark of the provided application syringe.

One syringe contains thermal paste for 5 processors.

**CAUTION!**

Do not apply a mixture of different thermal paste types on the same processor.





Figure 126: Applying the thermal paste

- ▶ Apply the thermal paste in the center of the processor surface (see circle).
- ▶ Ensure a thin and even distribution of the thermal paste.



## 10.2.7 Installing the heat sink

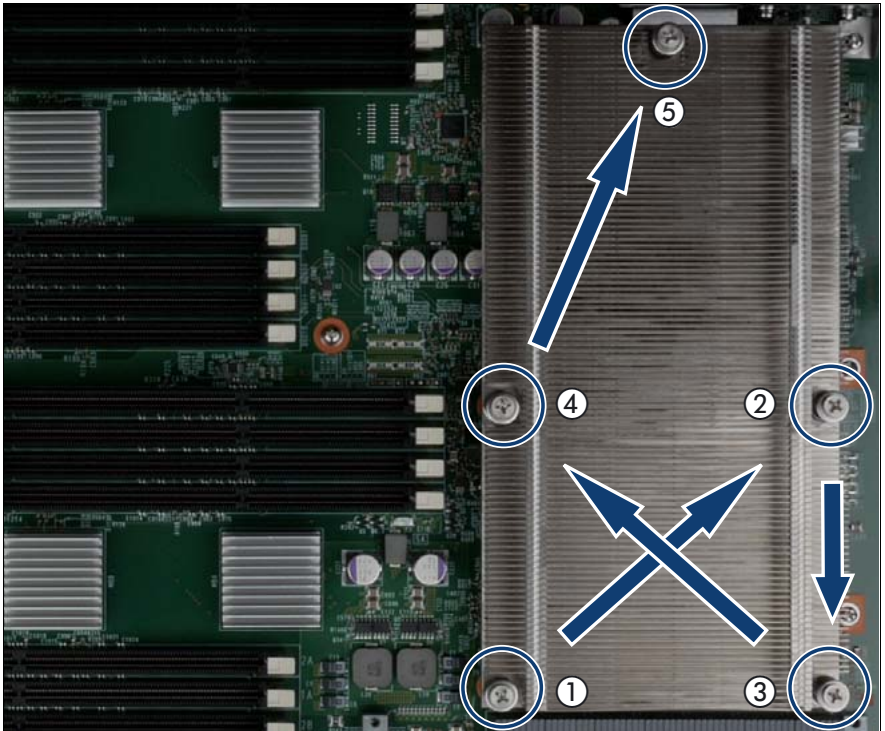

Figure 127: Installing the heat sink

- ▶ Remove the residual thermal paste from the underside of the heat sink.
- ▶ Clean the heat sink using a lint-free cloth.
- ▶ Carefully place the heat sink onto the processor.



### CAUTION!

Place the heat sink precisely on the threaded holes (see circle).

Careless handling may damage conductors and render the baseboard useless.

- ▶ Fasten the heat sink with its five captive screws. Fasten the screws alternately until they are fully tightened:
  - Give each screw about 4 turns at a time.
  - Start with screw 1 to screw 5 as indicated in [figure 127](#) and continue with screw 1.
  - Torque: 0.6 Nm

### 10.2.8 Completing the task

- ▶ Perform the following procedures to complete the task:
  1. ["Inserting the CPUMEMR in the slot" on page 186](#)
  2. ["Closing the server" on page 47](#)
  3. ["Mounting the server in the rack" on page 49](#)
  4. ["Bringing the server back to operation" on page 51](#)
  5. Enter the BIOS menu and enable the replaced processor.
  6. ["Closing the rack door" on page 51](#)

## 10.3 Replacing a heat sink



### Authorized personnel

Authorized specialist personnel can carry out replacement tasks for integral server components. Ask your local Fujitsu service center for more detailed information.



### CAUTION!

Procedures indicated as "Authorized personnel only" must be done by Fujitsu service personnel or technicians trained by Fujitsu for doing these tasks. Please note that unauthorized interference with the system will void the warranty and exempt the manufacturer from all liability.



### CAUTION!

Only processors of the same type may be used on the baseboard. That means the number of the internal processor cores as well as the primary clock and the FSB frequency have to be the same. For multi-processor operation, use a suitable multiprocessor operating system.

### 10.3.1 Required tools

- Starting and completing the task:
  - key for the rack doors (if applicable)
  - Phillips Ph2 screw driver
- Replacing the heat sink:
  - Phillips Ph2 screw driver

### 10.3.2 Starting the task

- ▶ Perform the following procedures:
  1. ["Opening the rack door" on page 40](#)
  2. ["Locate the faulty server" on page 37](#)
  3. ["Shutting down the server" on page 41](#)

4. "Sliding the server out of the rack" on page 42
5. "Opening the server" on page 44
6. "Removing the CPUMEMR" on page 190

### 10.3.3 Removing the heat sink

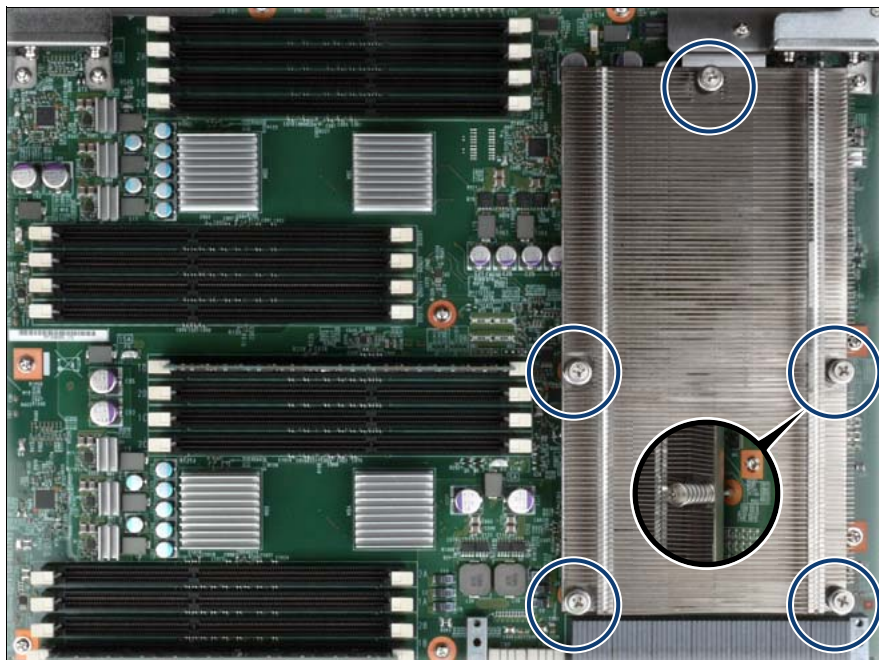

Figure 128: Removing the heat sink

- ▶ Loosen the captive screws of the heat sink alternately until they are fully released.
- ▶ Loosen the heat sink by turning it back and forth and then lift it out.

### 10.3.4 Applying the thermal paste



Figure 129: Measuring the thermal paste

- ▶ Remove the residual thermal paste from the processor surface.
- ▶ Clean the processor surface using a lint-free cloth.
- ▶ Use 0.2 grams of the supplied thermal paste, that is approximately one graduation mark of the provided application syringe.

One syringe contains thermal paste for 5 processors.



#### **CAUTION!**

Do not apply a mixture of different thermal paste types on the same processor.



Figure 130: Applying the thermal paste

- ▶ Apply the thermal paste in the center of the processor surface (see circle).
- ▶ Ensure a thin and even distribution of the thermal paste.

### 10.3.5 Installing the heat sink

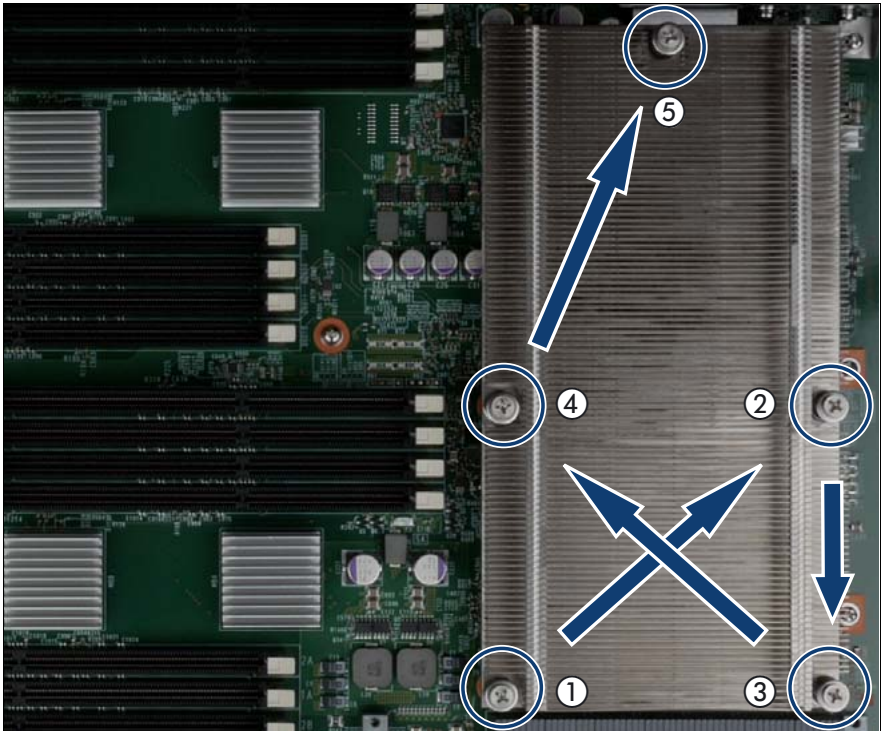

Figure 131: Installing the heat sink

- ▶ Carefully place the heat sink onto the processor.



#### **CAUTION!**

Place the heat sink precisely on the threaded holes (see circles). Careless handling may damage conductors and render the baseboard useless.

- ▶ Fasten the heat sink with its five captive screws. Fasten the screws alternately until they are fully tightened:
  - Give each screw about 4 turns at a time.
  - Start with screw 1 to screw 5 as indicated in [figure 131](#) and continue with screw 1.
  - Torque: 0.6 Nm

### 10.3.6 Completing the task

- ▶ Perform the following procedures to complete the task:
  1. ["Inserting the CPUMEMR in the slot" on page 186](#)
  2. ["Closing the server" on page 47](#)
  3. ["Mounting the server in the rack" on page 49](#)
  4. ["Bringing the server back to operation" on page 51](#)
  5. ["Closing the rack door" on page 51](#)



---

# 11 Optical and backup drives

One optical drive is installed in the RX900 S1. You can choose a DVD or Blu-Ray SATA drive in 0.5x5.25-inch format.

## 11.1 Replacing the optical drive



### Authorized personnel

Authorized specialist personnel can carry out replacement tasks for integral server components. Ask your local Fujitsu service center for more detailed information.



### CAUTION!

Procedures indicated as "Authorized personnel only" must be done by Fujitsu service personnel or technicians trained by Fujitsu for doing these tasks. Please note that unauthorized interference with the system will void the warranty and exempt the manufacturer from all liability.



### CAUTION!

- Before installing/removing an accessible drive to/from the server, turn off the server, all peripheral devices, and any other connected devices. Also unplug all power cables from the outlet. Failure to do so can cause electric shock.
- When installing an accessible drive, hold it by the side. Applying force to the top may cause failures.
- Do not touch the circuitry on boards and soldered parts. Hold the metallic areas or the edge of the circuit boards.
- The circuit boards and soldered parts of internal options are exposed and can be damaged by static electricity. Before handling them, first touch a metal part on the server to discharge static electricity from your body.
- Before installing an internal accessible drive, see the manual for the accessible drive.



### CAUTION!

- When forcing an accessible drive into a server, be careful so as not to pinch the cable etc. connected to an accessible drive.
- Follow the safety instructions in the ["Safety instructions" on page 31](#).

### 11.1.1 Required tools

- Starting and completing the task:
  - key for the rack doors (if applicable)
  - Phillips Ph2 screw driver
- Replacing the optical drive:
  - Phillips Ph0 screw driver

### 11.1.2 Starting the task

- ▶ Perform the following procedures:
  1. ["Opening the rack door" on page 40](#)
  2. ["Shutting down the server" on page 41](#)
  3. ["Sliding the server out of the rack" on page 42](#)
  4. ["Opening the server" on page 44](#)

### 11.1.3 Removing the optical drive

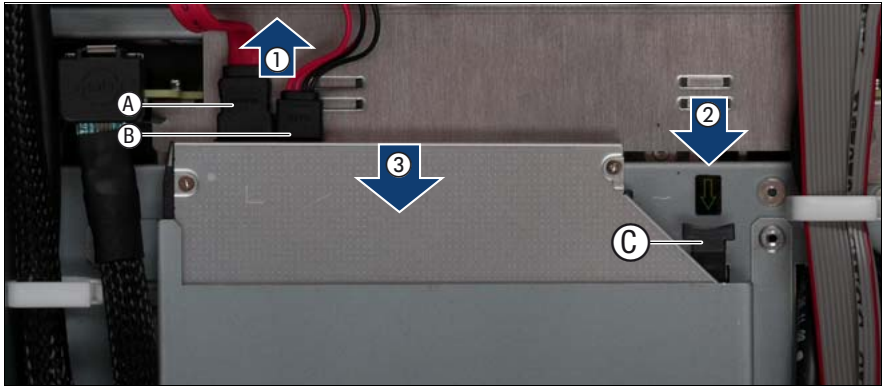

Figure 132: Removing the optical drive

- ▶ Disconnect the SATA cable (A) and the power cable (B) from the back of the optical drive (1).
- ▶ Use the handle (C) to unlock the drive (2).
- ▶ Remove the optical drive from the bay (3).

### 11.1.4 Replacing the optical drive in the installation frame



Figure 133: Replacing the optical drive in the installation frame

## Optical and backup drives

---

- ▶ Remove the four screws (see circles) to remove the drive frames.
- ▶ Put the old optical drive aside.
- ▶ Fasten the drive frames at the new optical drive with the four supplied screws (see circles).

### 11.1.5 Installing the optical drive



Figure 134: Sliding the optical drive in the bay

- ▶ Slide the optical drive into the bay until it clicks into place.



Figure 135: Connecting the SATA and the power cable

- ▶ Connect the SATA and the power cable on the back of the optical drive.

### 11.1.6 Completing the task

- ▶ Perform the following procedures to complete the task:
  1. ["Closing the server" on page 47](#)
  2. ["Mounting the server in the rack" on page 49](#)
  3. ["Bringing the server back to operation" on page 51](#)
  4. ["Closing the rack door" on page 51](#)



## 12 Front panel and external connectors



### Authorized personnel

Authorized specialist personnel can carry out replacement tasks for integral server components. Ask your local Fujitsu service center for more detailed information.



### CAUTION!

Procedures indicated as "Authorized personnel only" must be done by Fujitsu service personnel or technicians trained by Fujitsu for doing these tasks. Please note that unauthorized interference with the system will void the warranty and exempt the manufacturer from all liability.



### CAUTION!

Follow the safety instructions in the chapter "[Safety instructions](#)" on [page 31](#).

This section comprises procedures on:

- "[Replacing the control panel](#)" on [page 228](#)
- "[Replacing the front panel module](#)" on [page 234](#)
- "[Replacing the USB board](#)" on [page 239](#)
- "[Replacing the I/O board](#)" on [page 242](#)

# 12.1 Replacing the control panel



### Authorized personnel

Authorized specialist personnel can carry out replacement tasks for integral server components. Ask your local Fujitsu service center for more detailed information.



### CAUTION!

Procedures indicated as "Authorized personnel only" must be done by Fujitsu service personnel or technicians trained by Fujitsu for doing these tasks. Please note that unauthorized interference with the system will void the warranty and exempt the manufacturer from all liability.

## 12.1.1 Required tools

- Starting and completing the task:
  - key for the rack doors (if applicable)
  - Phillips Ph2 screw driver
- Replacing the control panel: tool-less

## 12.1.2 Starting the task

- ▶ Perform the following procedures:
  1. ["Opening the rack door" on page 40](#)
  2. ["Shutting down the server" on page 41](#)
  3. ["Sliding the server out of the rack" on page 42](#)
  4. ["Opening the server" on page 44](#)
  5. Remove all CPUMEMRs, see ["Removing the CPUMEMR" on page 190](#)



Before removing the CPUMEMRs, take a note on the installation slot number for each CPUMEMR. Make sure that you reinstall the CPUMEMR in the slot it was located before the replacement.



### 12.1.3 Removing the control panel

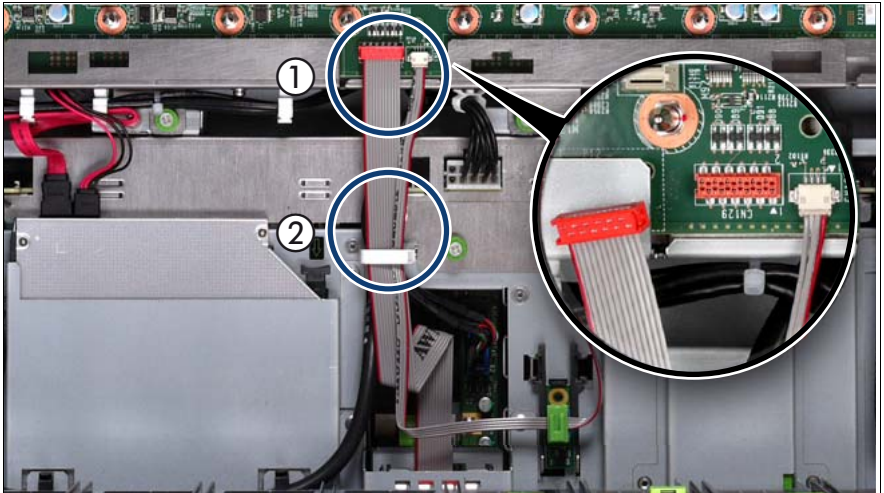

Figure 136: Disconnecting the control panel cable from the baseboard

- ▶ Disconnect the control panel cable from the baseboard (1).
- ▶ Open the cable clamp (2).

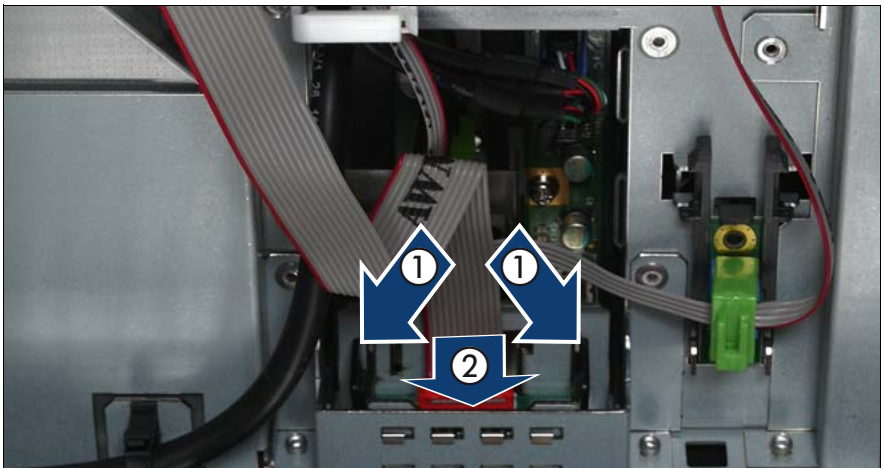

Figure 137: Removing the control panel

## Front panel and external connectors

---

- ▶ Press the plastic tongues slightly outward as indicated by the arrows (1).
- ▶ Push the control panel outward (2).

### 12.1.4 Disconnecting the control panel cable

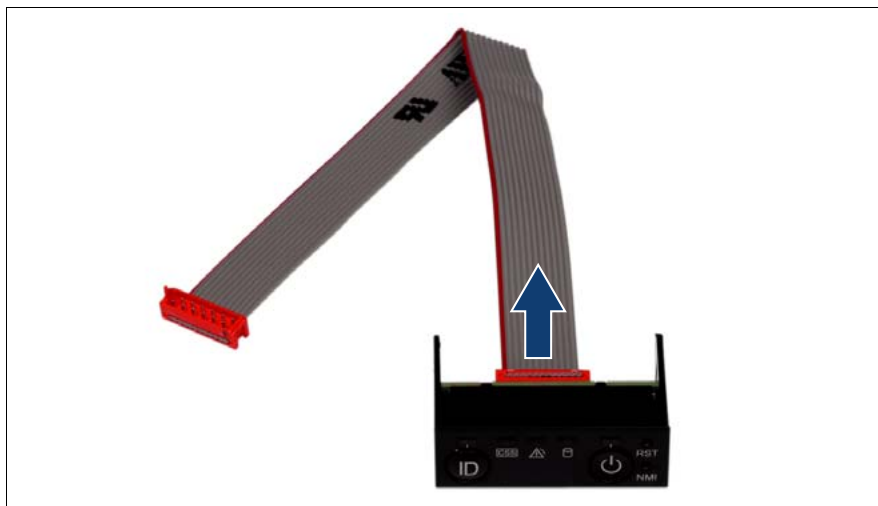

Figure 138: Disconnecting the control panel cable from the control panel

- ▶ Disconnect the control panel cable from the control panel.

### 12.1.5 Connecting the control panel cable



Figure 139: Connecting the control panel cable to the control panel

- ▶ Connect the control panel cable to the control panel.

### 12.1.6 Installing the control panel



Figure 140: Installing the control panel

- ▶ Slide the control panel into the bay until it clicks into place.

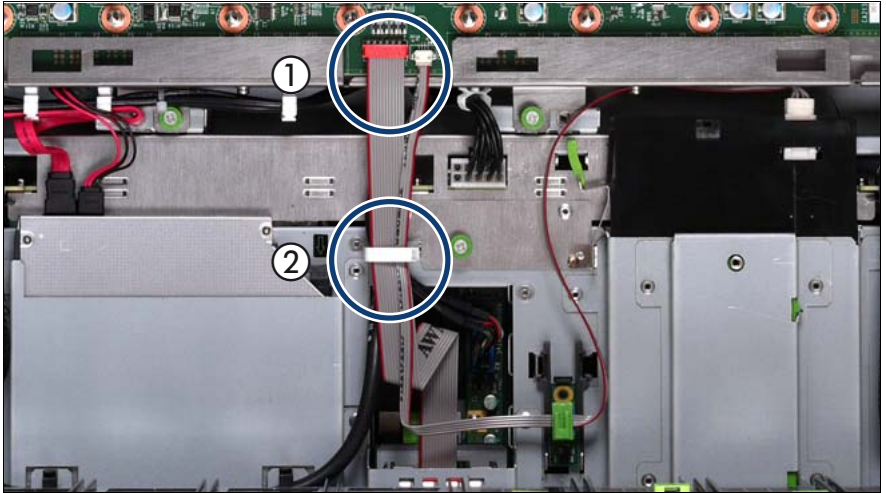

Figure 141: Connecting the control panel cable

- ▶ Connect the control panel cable to the baseboard (1).
- ▶ Close the cable clamp (2).

### 12.1.7 Completing the task

- ▶ Perform the following procedures to complete the task:
  1. ["Inserting the CPUMEMR in the slot" on page 186](#)
  2. ["Closing the server" on page 47](#)
  3. ["Mounting the server in the rack" on page 49](#)
  4. ["Bringing the server back to operation" on page 51](#)
  5. ["Closing the rack door" on page 51](#)

# 12.2 Replacing the front panel module



### Authorized personnel

Authorized specialist personnel can carry out replacement tasks for integral server components. Ask your local Fujitsu service center for more detailed information.



### CAUTION!

Procedures indicated as "Authorized personnel only" must be done by Fujitsu service personnel or technicians trained by Fujitsu for doing these tasks. Please note that unauthorized interference with the system will void the warranty and exempt the manufacturer from all liability.

## 12.2.1 Required tools

- Starting and completing the task:
  - key for the rack doors (if applicable)
  - Phillips Ph2 screw driver
- Replacing the front panel module: tool-less

## 12.2.2 Starting the task

► Perform the following procedures:

1. ["Opening the rack door" on page 40](#)
2. ["Shutting down the server" on page 41](#)
3. ["Sliding the server out of the rack" on page 42](#)
4. ["Opening the server" on page 44](#)
5. Remove all CPUMEMRs, see ["Removing the CPUMEMR" on page 190](#)



Before removing the CPUMEMRs, take a note on the installation slot number for each CPUMEMR. Make sure that you reinstall the CPUMEMR in the slot it was located before the replacement.

6. ["Removing the control panel" on page 229](#)

### 12.2.3 Removing the front panel module

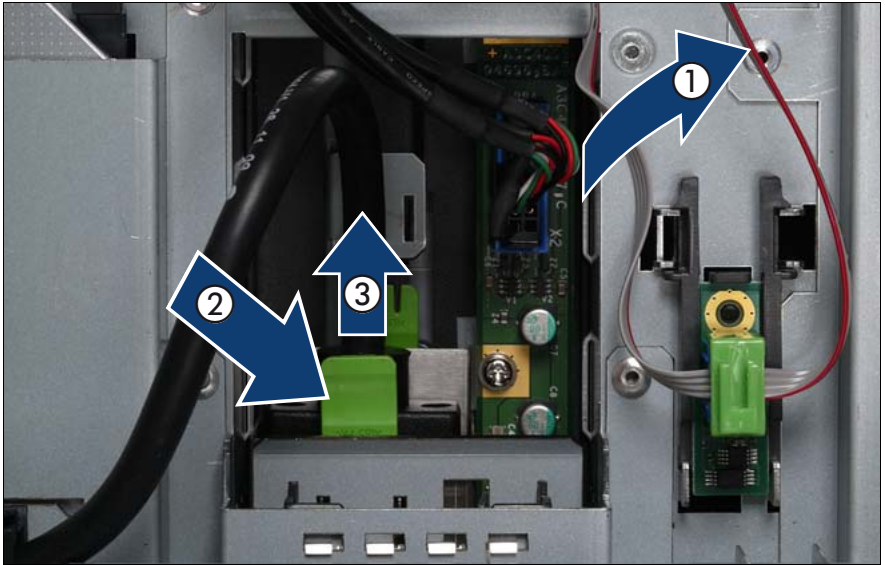

Figure 142: Disconnecting the USB cable and the video connector

- ▶ Disconnect the USB cable (1).
- ▶ Press the locking handle (2) of the video connector downward.
- ▶ Slide the video connector out of the front panel module (3).

## Front panel and external connectors

---

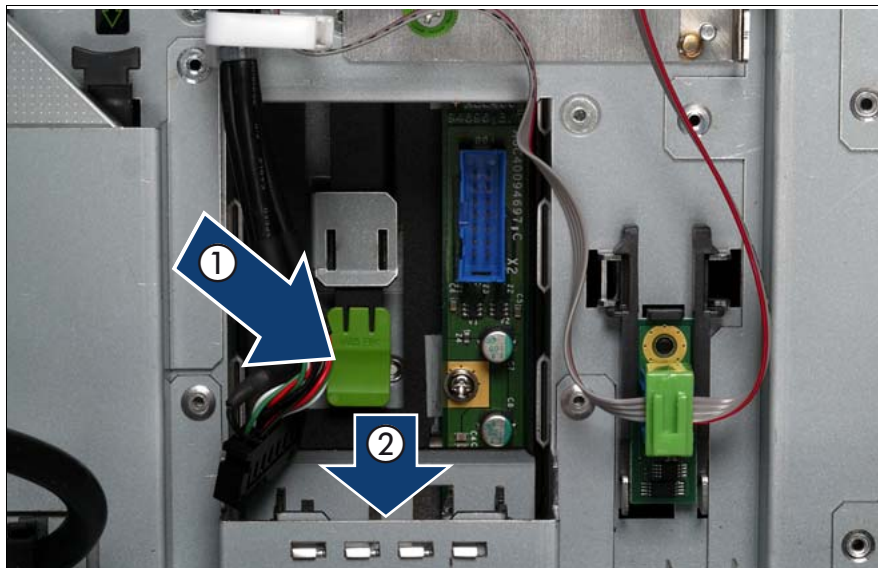

Figure 143: Removing the front panel module

- ▶ Press the locking handle (1) downward.
- ▶ Push the front panel module outward (2).



## 12.2.4 Inserting the front panel module

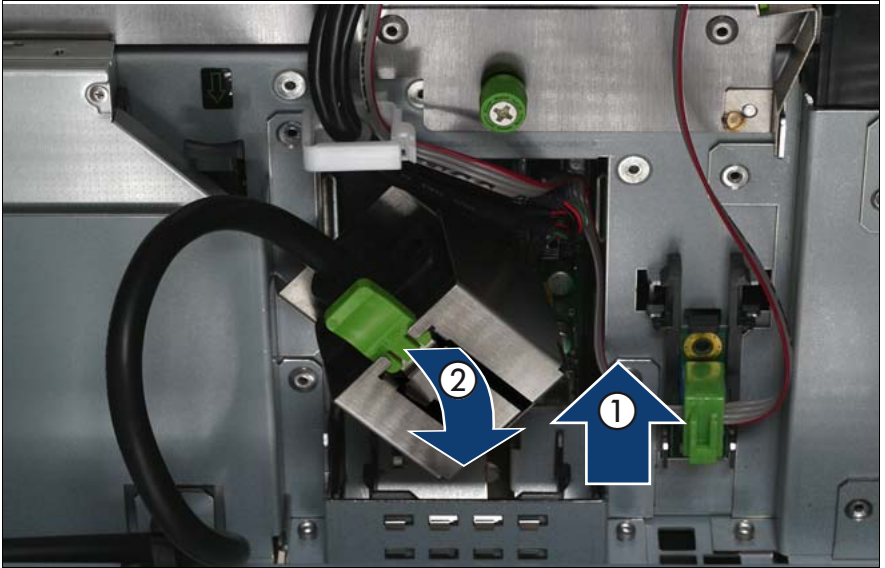

Figure 144: Inserting the front panel module

- ▶ Slide the front panel module into the bay until it clicks into place (1).
- ▶ Slide the video connector in the front panel module until it clicks into place (2).

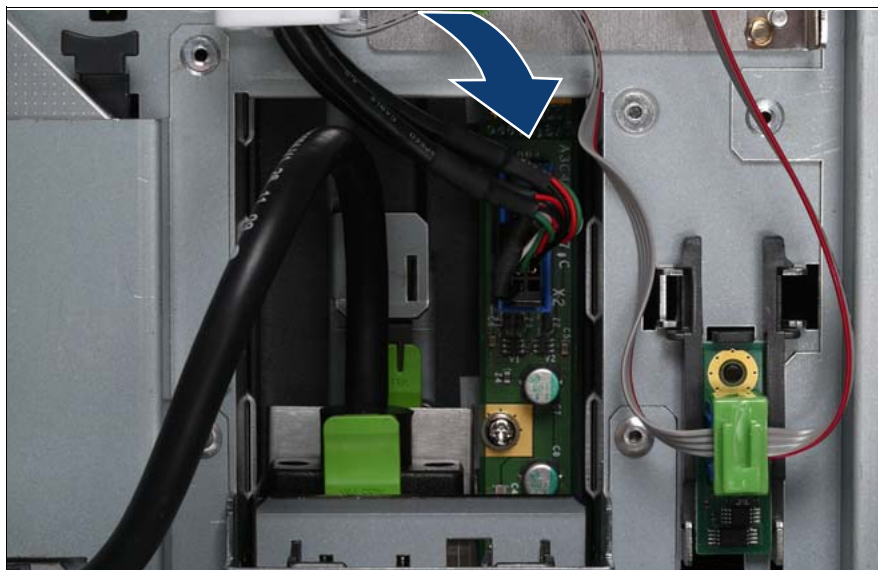

Figure 145: Connecting the USB cable

- ▶ Connect the USB cable to the front panel module.

### 12.2.5 Completing the task

- ▶ Perform the following procedures to complete the task:
  1. ["Installing the control panel" on page 232](#)
  2. ["Inserting the CPUMEMR in the slot" on page 186](#)
  3. ["Closing the server" on page 47](#)
  4. ["Mounting the server in the rack" on page 49](#)
  5. ["Bringing the server back to operation" on page 51](#)
  6. ["Closing the rack door" on page 51](#)

## 12.3 Replacing the USB board



### Authorized personnel

Authorized specialist personnel can carry out replacement tasks for integral server components. Ask your local Fujitsu service center for more detailed information.



### CAUTION!

Procedures indicated as "Authorized personnel only" must be done by Fujitsu service personnel or technicians trained by Fujitsu for doing these tasks. Please note that unauthorized interference with the system will void the warranty and exempt the manufacturer from all liability.

### 12.3.1 Required tools

- Starting and completing the task:
  - key for the rack doors (if applicable)
  - Phillips Ph2 screw driver
- Replacing the USB board:
  - Phillips Ph1 screw driver

### 12.3.2 Starting the task

- ▶ Perform the following procedures:
  1. ["Opening the rack door" on page 40](#)
  2. ["Locate the faulty server" on page 37](#)
  3. ["Shutting down the server" on page 41](#)
  4. ["Sliding the server out of the rack" on page 42](#)
  5. ["Opening the server" on page 44](#)

## Front panel and external connectors

---

6. Remove all CPUMEMRs, see ["Removing the CPUMEMR" on page 190](#)



Before removing the CPUMEMRs, take a note on the installation slot number for each CPUMEMR. Make sure that you reinstall the CPUMEMR in the slot it was located before the replacement.

7. ["Removing the control panel" on page 229](#)
8. ["Removing the front panel module" on page 235](#)

### 12.3.3 Removing the USB board

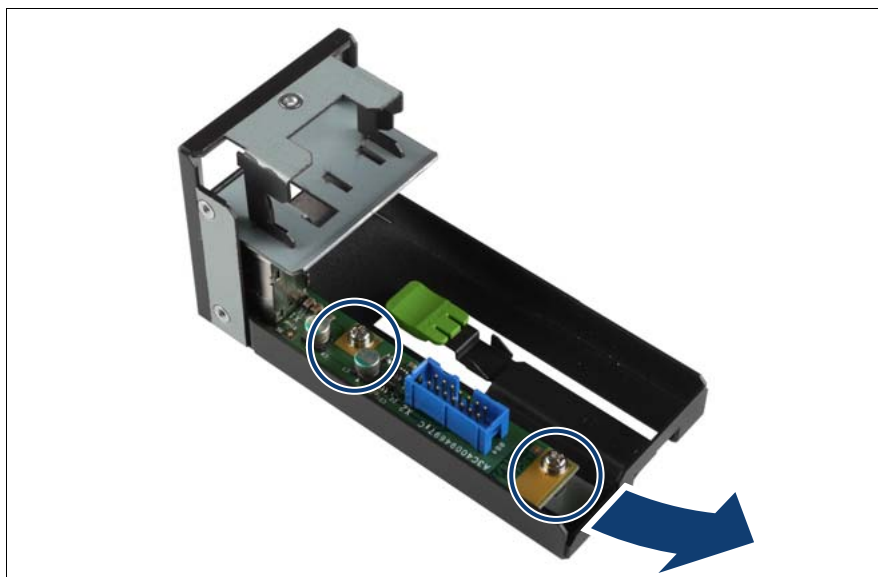

Figure 146: Removing the USB board from the front panel module

- ▶ Remove both screws (see circle).
- ▶ Push the USB board backward out.

### 12.3.4 Installing the USB board

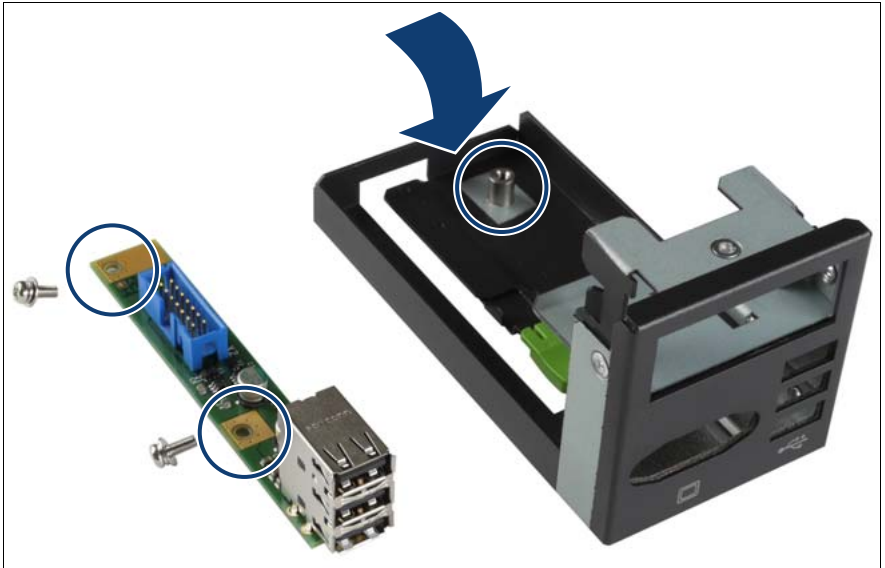

Figure 147: Installing the USB board in the front panel module

- ▶ Insert the USB board into the front panel module.
- ▶ Fasten both screws (see circles).

### 12.3.5 Completing the task

- ▶ Perform the following procedures to complete the task:
  1. ["Inserting the front panel module" on page 237](#)
  2. ["Installing the control panel" on page 232](#)
  3. ["Inserting the CPUMEMR in the slot" on page 186](#)
  4. ["Closing the server" on page 47](#)
  5. ["Mounting the server in the rack" on page 49](#)
  6. ["Bringing the server back to operation" on page 51](#)
  7. ["Closing the rack door" on page 51](#)

# 12.4 Replacing the I/O board



### Authorized personnel

Authorized specialist personnel can carry out replacement tasks for integral server components. Ask your local Fujitsu service center for more detailed information.



### CAUTION!

Procedures indicated as "Authorized personnel only" must be done by Fujitsu service personnel or technicians trained by Fujitsu for doing these tasks. Please note that unauthorized interference with the system will void the warranty and exempt the manufacturer from all liability.

## 12.4.1 Required tools

- Starting and completing the task:
  - key for the rack doors (if applicable)
  - Phillips Ph2 screw driver
- Replacing the I/O board:
  - Phillips Ph2 screw driver

## 12.4.2 Starting the task

- ▶ Perform the following procedures:
  1. ["Opening the rack door" on page 40](#)
  2. ["Shutting down the server" on page 41](#)
  3. ["Sliding the server out of the rack" on page 42](#)
  4. ["Removing the rear cover" on page 46](#)

### 12.4.3 Removing the PCI Riser

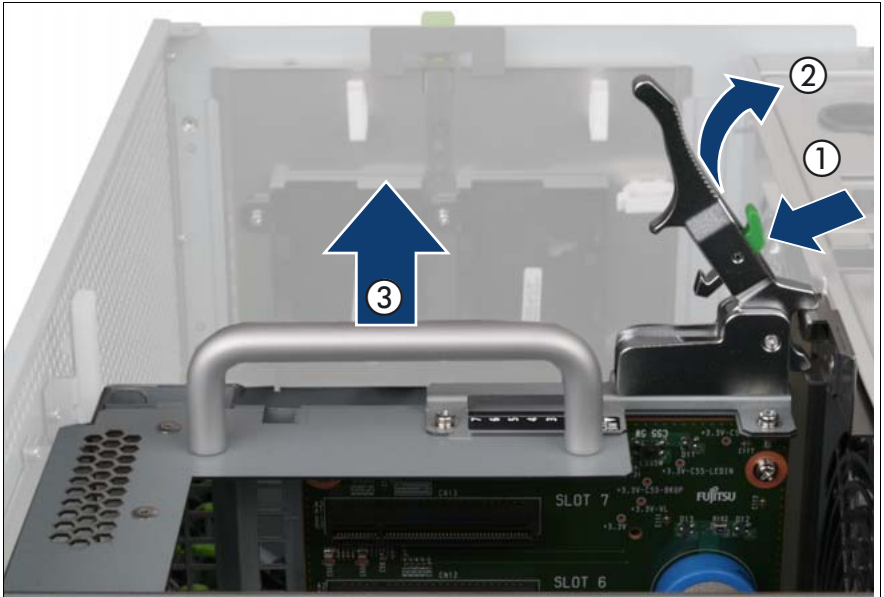

Figure 148: Removing the PCI Riser

- ▶ Press the green button (1).
- ▶ Lift the handle (2) to disconnect the PCI Riser (PCIR) from the baseboard.
- ▶ Pull the PCIR up and out by using the handle (3).

### 12.4.4 Removing the I/O board

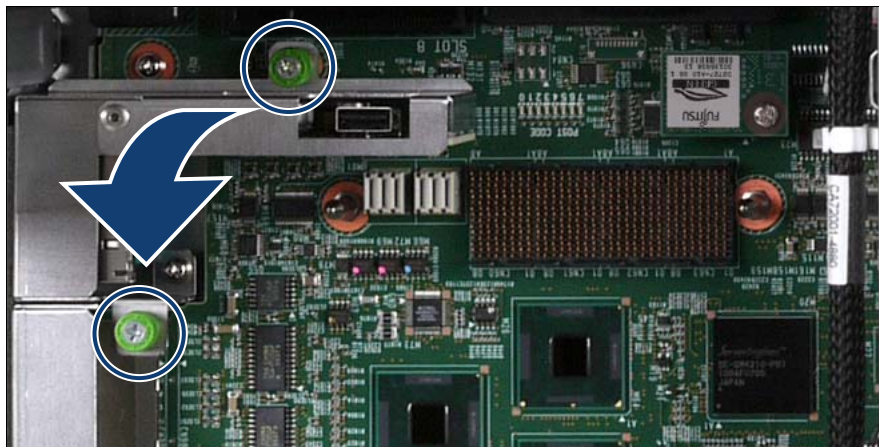

Figure 149: Removing the I/O board

- ▶ Loosen the two captive screws (see circles).
- ▶ Remove the I/O board.

### 12.4.5 Installing the I/O board

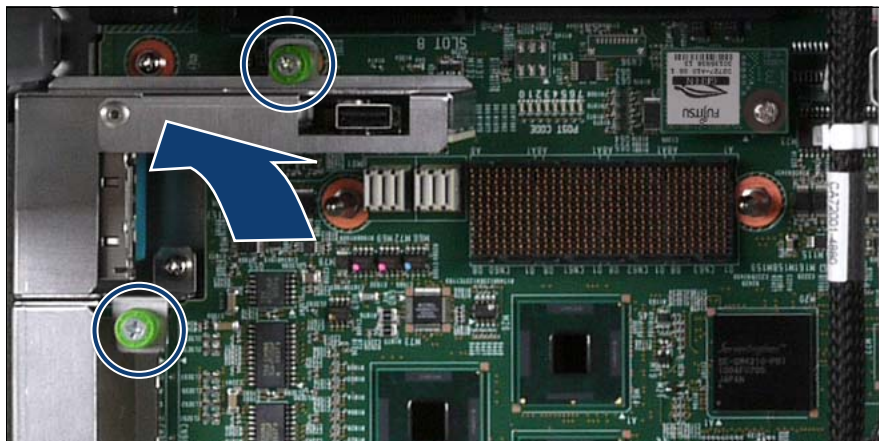

Figure 150: Installing the I/O board



- ▶ Carefully insert the I/O board in the I/O board connector.
- ▶ Fasten the two screws (see circles).

### 12.4.6 Installing the PCI Riser



Figure 151: Installing the PCI Riser

- ▶ Carefully insert the PCIR in the slot (1).
- ▶ Lock the PCIR by pushing down the handle (2).

### 12.4.7 Completing the task

- ▶ Perform the following procedures to complete the task:
  1. ["Installing the rear cover" on page 48](#)
  2. ["Mounting the server in the rack" on page 49](#)
  3. ["Bringing the server back to operation" on page 51](#)
  4. ["Closing the rack door" on page 51](#)



# 13 Management and diagnostics modules



## Authorized personnel

Authorized specialist personnel can carry out replacement tasks for integral server components. Ask your local Fujitsu service center for more detailed information.



### CAUTION!

Procedures indicated as "Authorized personnel only" must be done by Fujitsu service personnel or technicians trained by Fujitsu for doing these tasks. Please note that unauthorized interference with the system will void the warranty and exempt the manufacturer from all liability.



### CAUTION!

Follow the safety instructions in the chapter "[Safety instructions](#)" on [page 31](#).

This section provides information on:

- "[Replacing the local service display](#)" on [page 248](#)

The ServerView Local Service Display on the front panel of the server enables you to check the status of the key system components at any time without opening the housing. For information on the functions provided by the ServerView Local Service Display see the associated documentation.

- "[Replacing the chassis ID board](#)" on [page 252](#)

The chassis ID board provides two functions:

- FRU-PROM information for identification the system, that is Product Model Name, Product Part Number, and Chassis Serial Number
- Temperature sensor for monitoring the ambient temperature

The functions are essential to monitor the temperature correctly, enable ServerView to display the correct system picture, and to install the server using ServerStart. BIOS/BMC configuration data is kept on the EEPROM on the power distribution board. The data for the EEPROM and the current temperature values are transmitted to the baseboard via the I<sup>2</sup>C bus.

## 13.1 Replacing the local service display



### Authorized personnel

Authorized specialist personnel can carry out replacement tasks for integral server components. Ask your local Fujitsu service center for more detailed information.



### CAUTION!

Procedures indicated as "Authorized personnel only" must be done by Fujitsu service personnel or technicians trained by Fujitsu for doing these tasks. Please note that unauthorized interference with the system will void the warranty and exempt the manufacturer from all liability.

### 13.1.1 Required tools

- Starting and completing the task:
  - key for the rack doors (if applicable)
  - Phillips Ph2 screw driver
- Replacing the local service display: tool-less

### 13.1.2 Starting the task

- Perform the following procedures:
1. ["Opening the rack door" on page 40](#)
  2. ["Shutting down the server" on page 41](#)
  3. ["Sliding the server out of the rack" on page 42](#)
  4. ["Opening the server" on page 44](#)
  5. Remove all CPUMEMRs, see ["Removing the CPUMEMR" on page 190](#)



Before removing the CPUMEMRs, take a note on the installation slot number for each CPUMEMR. Make sure that you reinstall the CPUMEMR in the slot it was located before the replacement.

### 13.1.3 Removing the local service display

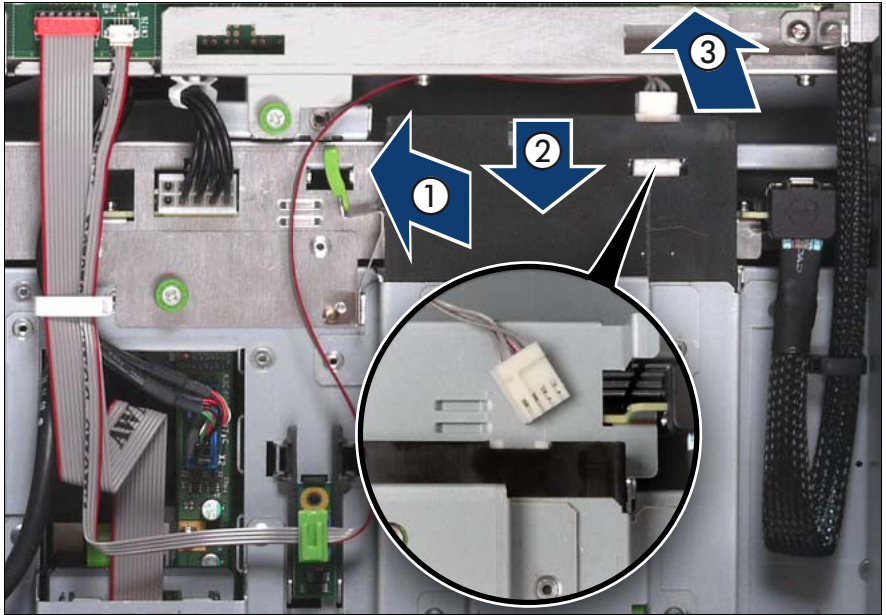

Figure 152: Removing the local service display

- ▶ Unlock the local service display (1).
- ▶ Slide the local service display outward so that you can disconnect the chassis ID board cable (2).
- ▶ Disconnect the chassis ID board cable (3).
- ▶ Slide the local service display outward.

### 13.1.4 Inserting the local service display

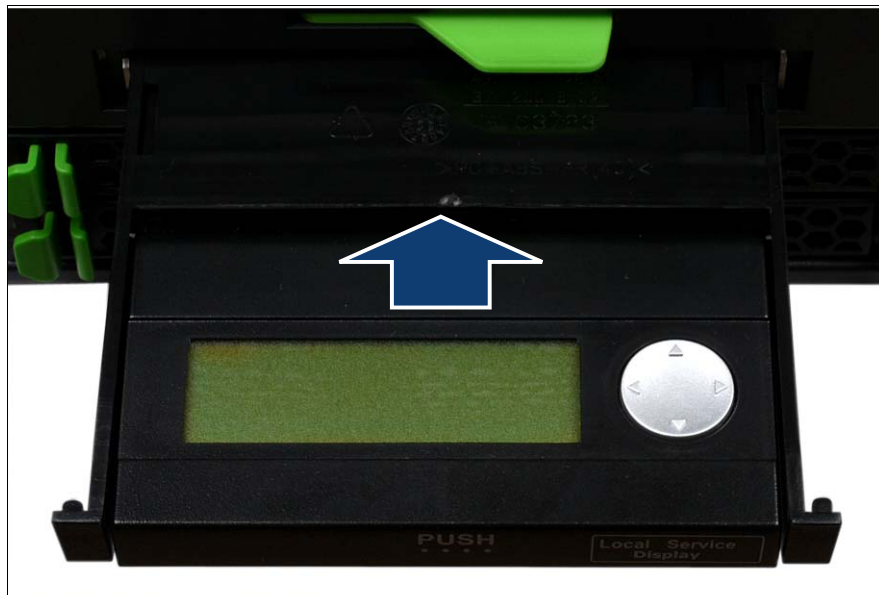

Figure 153: Inserting the local service display

- ▶ Slide the local service display in the bay so that there is enough space to connect the chassis ID board cable.

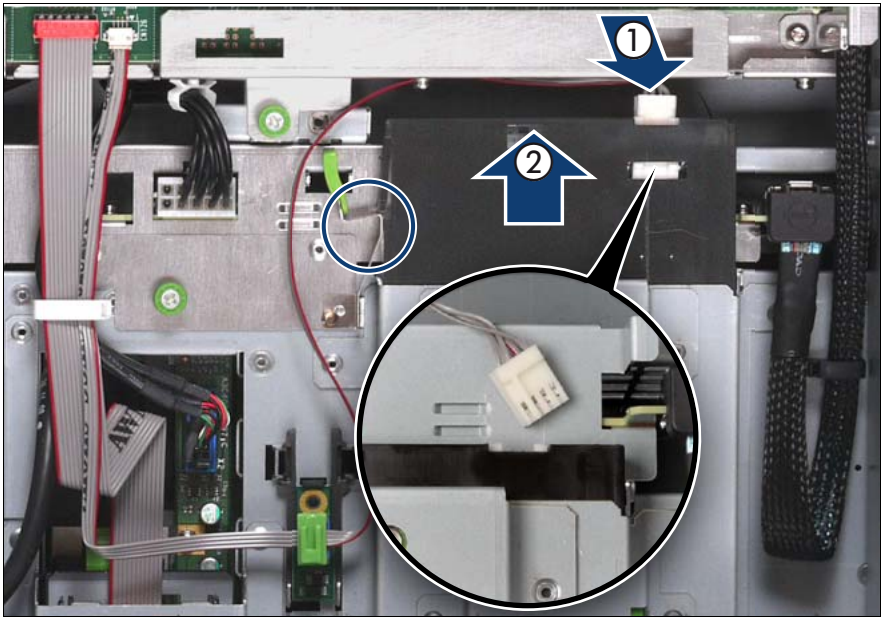

Figure 154: Connecting the chassis ID board cable

- ▶ Connect the chassis ID board cable (1).
- ▶ Slide the local service display inward until it clicks into place (2).

### 13.1.5 Completing the task

- ▶ Perform the following procedures to complete the task:
  1. ["Inserting the CPUMEMR in the slot" on page 186](#)
  2. ["Closing the server" on page 47](#)
  3. ["Mounting the server in the rack" on page 49](#)
  4. ["Bringing the server back to operation" on page 51](#)
  5. ["Closing the rack door" on page 51](#)

## 13.2 Replacing the chassis ID board



### Authorized personnel

Authorized specialist personnel can carry out replacement tasks for integral server components. Ask your local Fujitsu service center for more detailed information.



### CAUTION!

Procedures indicated as "Authorized personnel only" must be done by Fujitsu service personnel or technicians trained by Fujitsu for doing these tasks. Please note that unauthorized interference with the system will void the warranty and exempt the manufacturer from all liability.

### 13.2.1 Required tools

- Starting and completing the task:
  - key for the rack doors (if applicable)
  - Phillips Ph2 screw driver
- Replacing the chassis ID board: tool-less

### 13.2.2 Starting the task

- ▶ Perform the following procedures:
  1. ["Opening the rack door" on page 40](#)
  2. ["Shutting down the server" on page 41](#)
  3. ["Sliding the server out of the rack" on page 42](#)
  4. ["Opening the server" on page 44](#)
  5. Remove all CPUMEMRs, see ["Removing the CPUMEMR" on page 190](#)



Before removing the CPUMEMRs, take a note on the installation slot number for each CPUMEMR. Make sure that you reinstall the CPUMEMR in the slot it was located before the replacement.



### 13.2.3 Removing the chassis ID board

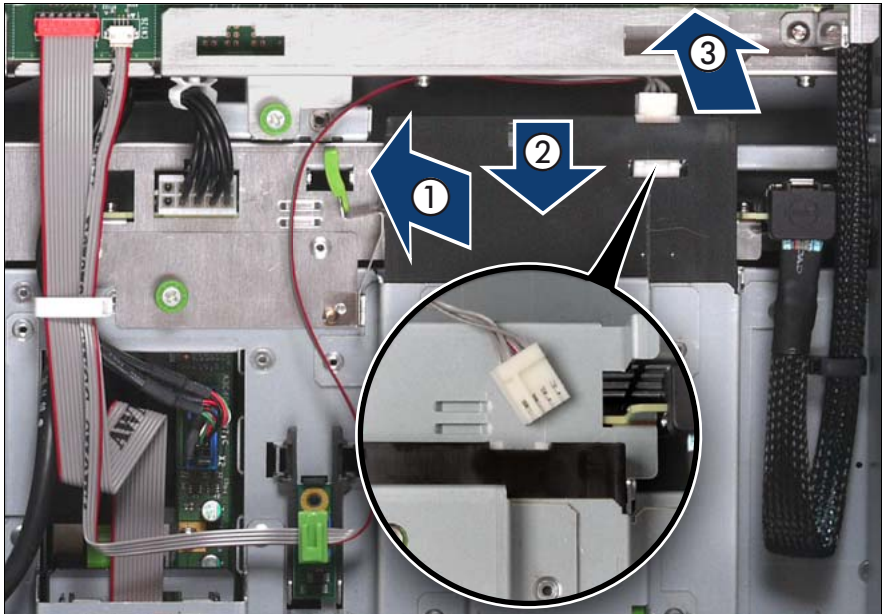

Figure 155: Removing the chassis ID board cable from the local service display

- ▶ Unlock the local service display (1).
- ▶ Slide the local service display outward so that you can disconnect the chassis ID board cable (2).
- ▶ Disconnect the chassis ID board cable (3).

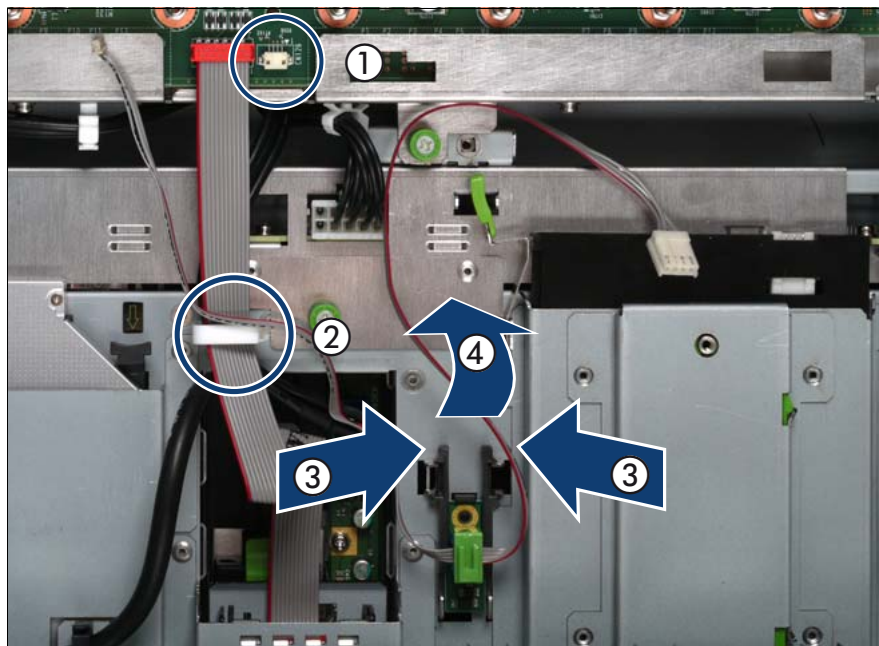

Figure 156: Removing the chassis ID board holder

- ▶ Disconnect the chassis ID board cable from the baseboard (1) and open the cable clamp (2).
- ▶ Press the plastic tongues of the chassis ID board holder slightly inward as indicated by the arrows (3).
- ▶ Slide the chassis ID board holder outward (4).

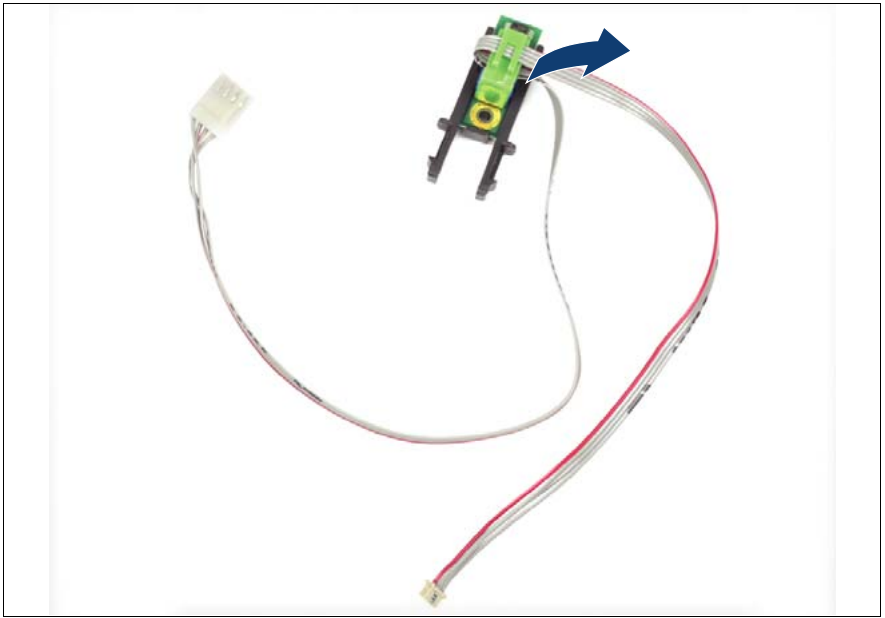

Figure 157: Removing the connector clamp

- ▶ Remove the connector clamp.

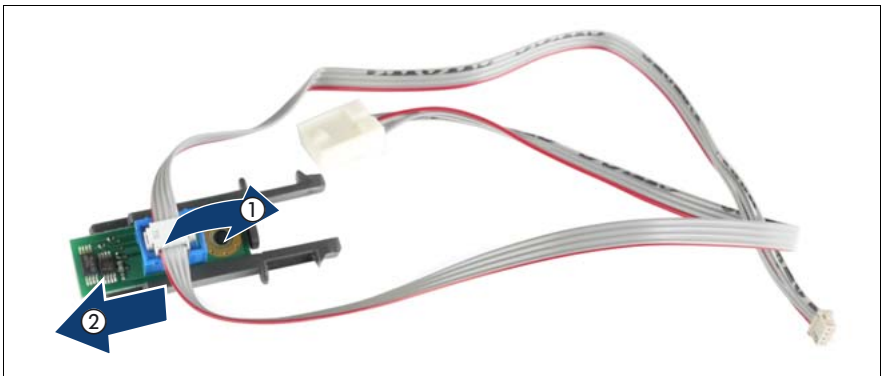

Figure 158: Disconnecting the chassis ID board cable

- ▶ Disconnect the chassis ID board cable from the chassis ID board (1).
- ▶ Slide the chassis ID board out of the holder (2).

### 13.2.4 Installing the chassis ID board

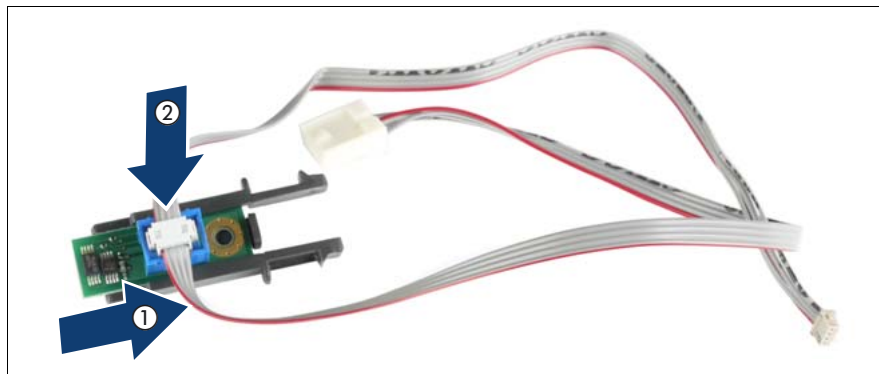

Figure 159: Installing the chassis ID board

- ▶ Slide the chassis ID board in the holder (1).
- ▶ Connect the chassis ID board cable at the chassis ID board (2).

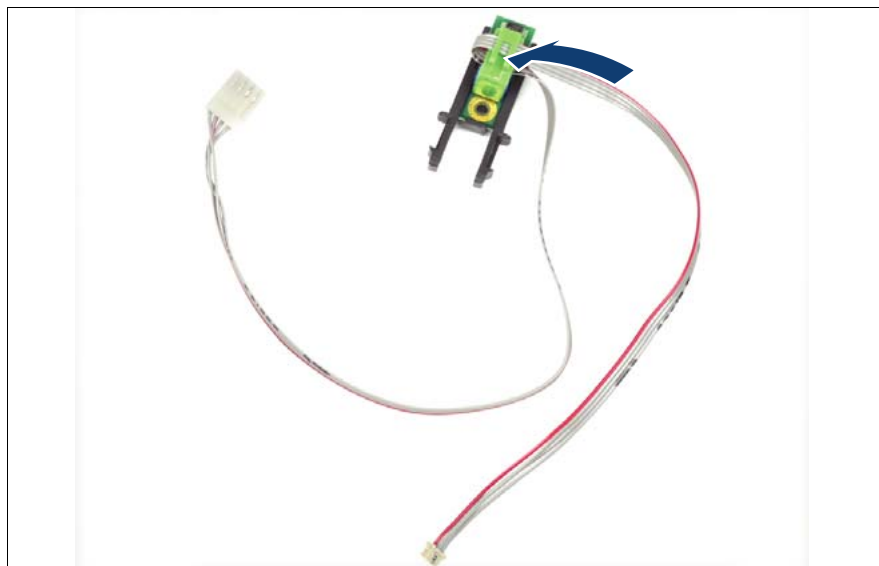

Figure 160: Installing the connector clamp

- ▶ Install the connector clamp.

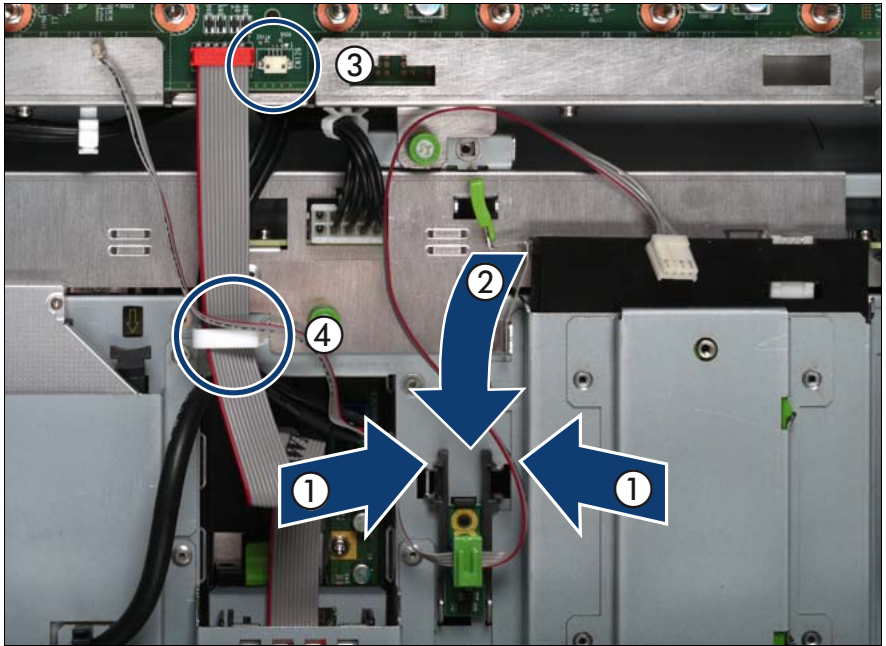

Figure 161: Installing the chassis ID board holder

- ▶ Press the plastic tongues of the chassis ID board holder slightly inward as indicated by the arrows (1) and slide the chassis ID board holder inward until it clicks into place (2).
- ▶ Connect the chassis ID board cable at the baseboard (3) and close the cable clamp (4).

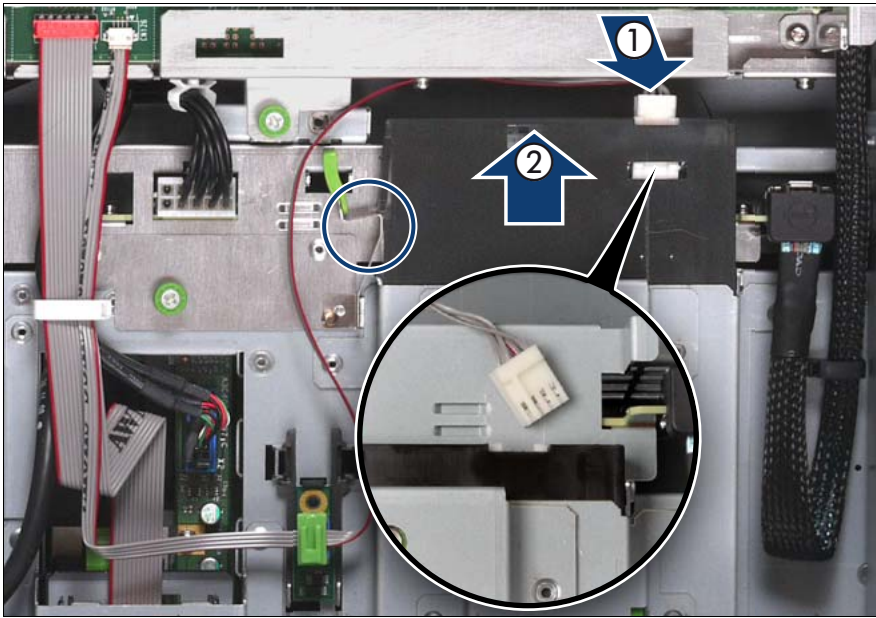

Figure 162: Connecting the chassis ID board cable

- ▶ Connect the chassis ID board cable (1).
- ▶ Slide the local service display inward until it clicks into place (2).



In order to enable ServerView Operations Manager and ServerView Installation Manager to identify the system, it is necessary to program the chassis ID prom using the "ChassisIDProm Tool" after installing the new chassis ID board. This tool is available for download from the following Fujitsu Technology Solutions support page:

<http://partners.ts.fujitsu.com/com/service/intelservers/tools>

### 13.2.5 Completing the task

- ▶ Perform the following procedures to complete the task:
  1. ["Inserting the CPUMEMR in the slot" on page 186](#)
  2. ["Closing the server" on page 47](#)
  3. ["Mounting the server in the rack" on page 49](#)
  4. ["Bringing the server back to operation" on page 51](#)
  5. ["Closing the rack door" on page 51](#)





# 14 Baseboard



## Authorized personnel

Authorized specialist personnel can carry out replacement tasks for integral server components. Ask you local Fujitsu service center for more detailed information.



### CAUTION!

Procedures indicated as "Authorized personnel only" must be done by Fujitsu service personnel or technicians trained by Fujitsu for doing these tasks. Please note that unauthorized interference with the system will void the warranty and exempt the manufacturer from all liability.



### CAUTION!

Follow the safety instructions in the chapter "[Safety instructions](#)" on [page 31](#).

This section comprises procedures on:

- "[Replacing the lithium battery](#)" on [page 262](#)
- "[Installing the UFM](#)" on [page 264](#) / "[Replacing the UFM board](#)" on [page 267](#)
- "[Installing the TPM](#)" on [page 270](#) / "[Replacing the TPM](#)" on [page 273](#)
- "[Replacing the baseboard](#)" on [page 276](#)

# 14.1 Replacing the lithium battery



### Authorized personnel

Authorized specialist personnel can carry out replacement tasks for integral server components. Ask your local Fujitsu service center for more detailed information.



### CAUTION!

Procedures indicated as "Authorized personnel only" must be done by Fujitsu service personnel or technicians trained by Fujitsu for doing these tasks. Please note that unauthorized interference with the system will void the warranty and exempt the manufacturer from all liability.

To allow permanent saving of the system information, a lithium battery is installed which supplies the CMOS memory with power. If the battery voltage is too low or the battery is empty, a corresponding error message is displayed. The lithium battery must then be replaced.



### CAUTION!

The lithium battery must be replaced with an identical battery or with a battery type recommended by the manufacturer. This information doesn't apply to the Japanese market.

Do not throw lithium batteries into the trash can. They must be disposed of in accordance with local regulations on special waste.

Make sure you insert the lithium battery the **right way round – the positive pole must be on the housing side!**

## 14.1.1 Required tools

- Starting and completing the task:
  - key for the rack doors (if applicable)
  - Phillips Ph2 screw driver
- Replacing the battery: tool-less

### 14.1.2 Starting the task

- ▶ Perform the following procedures:
  1. ["Opening the rack door" on page 40](#)
  2. ["Shutting down the server" on page 41](#)
  3. ["Sliding the server out of the rack" on page 42](#)
  4. ["Removing the rear cover" on page 46](#)
  5. Remove the PCI Riser, see ["Expansion cards and BBU" on page 105](#)

### 14.1.3 Replacing the faulty battery

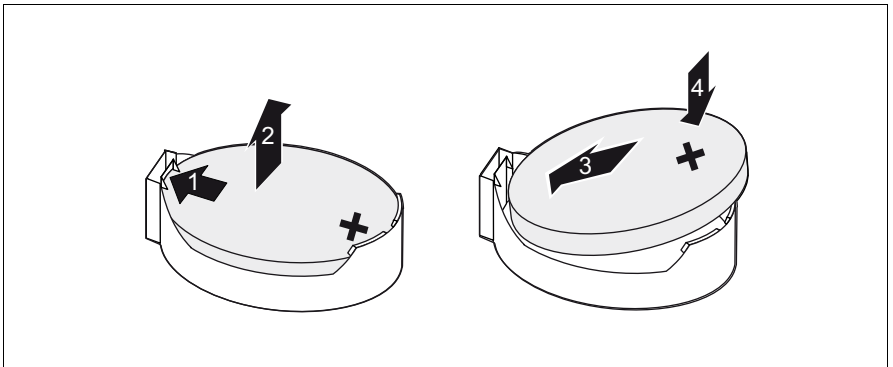

Figure 163: Replacing the lithium battery

- ▶ Press the locking spring into direction of the arrow (1), so that the lithium battery jumps out of its socket.
- ▶ Remove the battery (2).
- ▶ Insert a new lithium battery of the same type into the socket (3) and (4).
- ▶ Dispose of the waste battery as described above.

### 14.1.4 Completing the task

- ▶ Perform the following procedures to complete the task:
  1. Installing the PCI Riser, see ["Expansion cards and BBU" on page 105](#)
  2. ["Installing the rear cover" on page 48](#)
  3. ["Mounting the server in the rack" on page 49](#)
  4. ["Bringing the server back to operation" on page 51](#)
  5. ["Closing the rack door" on page 51](#)

## 14.2 Installing the UFM



### Authorized personnel

Authorized specialist personnel can carry out replacement tasks for integral server components. Ask you local Fujitsu service center for more detailed information.



### CAUTION!

Procedures indicated as "Authorized personnel only" must be done by Fujitsu service personnel or technicians trained by Fujitsu for doing these tasks. Please note that unauthorized interference with the system will void the warranty and exempt the manufacturer from all liability.

### 14.2.1 Required tools

- Starting and completing the task:
  - key for the rack doors (if applicable)
  - Phillips Ph2 screw driver
- Installing the UFM:
  - Phillips Ph1 screw driver

## 14.2.2 Starting the task

► Perform the following procedures:

1. ["Opening the rack door" on page 40](#)
2. ["Shutting down the server" on page 41](#)
3. ["Sliding the server out of the rack" on page 42](#)
4. ["Removing the rear cover" on page 46](#)
5. If required to access the installation place: Remove the expansion cards, see ["Expansion cards and BBU" on page 105](#)



Before removing the expansion cards, take a note on the installation slot number for each card. Make sure that you reinstall the card in the slot it was located before the replacement.

## 14.2.3 Inserting the UFM

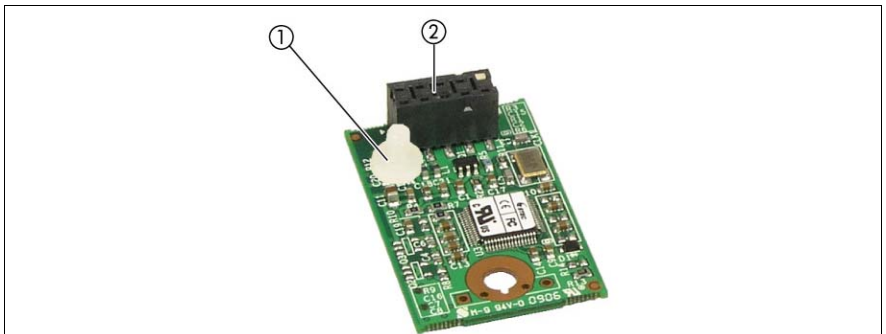

Figure 164: Preparing the UFM board

Server-specific installation rules are:

- Only the nylon screw (1) and the UFM board (2) are used from the available UFM installation kit, see [figure 164](#).
- The metal spacer is already installed in the baseboard.

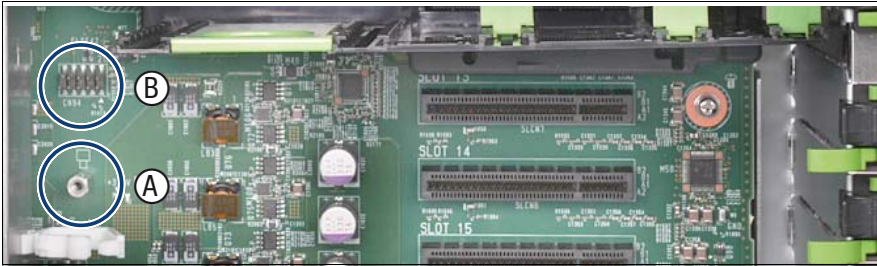

Figure 165: Checking the installation position

- ▶ Remove the SAS and BBU cable(s) for a convenient access to the mounting location of the UFM.
- ▶ Make sure that the metal spacer (A) engages properly in the baseboard.

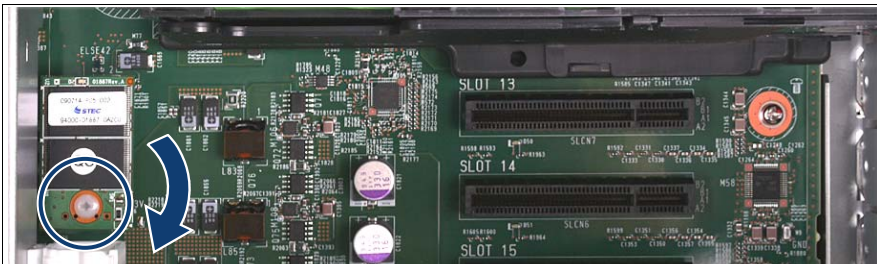

Figure 166: Installing the UFM board

- ▶ Place the UFM on the metal spacer (A) and the connector (B) in [figure 165](#) and secure it with the nylon screw.

### 14.2.4 Completing the task

- ▶ Perform the following procedures to complete the task:
  1. When expansion cards have been removed to access the installation place: Install the expansion cards, see ["Expansion cards and BBU" on page 105](#)
  2. ["Installing the rear cover" on page 48](#)
  3. ["Mounting the server in the rack" on page 49](#)
  4. ["Bringing the server back to operation" on page 51](#)
  5. ["Closing the rack door" on page 51](#)

## 14.3 Replacing the UFM board



### Authorized personnel

Authorized specialist personnel can carry out replacement tasks for integral server components. Ask your local Fujitsu service center for more detailed information.



### CAUTION!

Procedures indicated as "Authorized personnel only" must be done by Fujitsu service personnel or technicians trained by Fujitsu for doing these tasks. Please note that unauthorized interference with the system will void the warranty and exempt the manufacturer from all liability.

### 14.3.1 Required tools

- Starting and completing the task:
  - key for the rack doors (if applicable)
  - Phillips Ph2 screw driver
- Replacing the UFM:
  - Phillips Ph1 screw driver

### 14.3.2 Starting the task

- ▶ Perform the following procedures:
  1. "Opening the rack door" on page 40
  2. "Shutting down the server" on page 41
  3. "Sliding the server out of the rack" on page 42
  4. "Removing the rear cover" on page 46
  5. If required to access the installation place: Remove the expansion cards, see "Expansion cards and BBU" on page 105

**i** Before removing the expansion cards, take a note on the installation slot number for each card. Make sure that you reinstall the card in the slot it was located before the replacement.

### 14.3.3 Removing the UFM

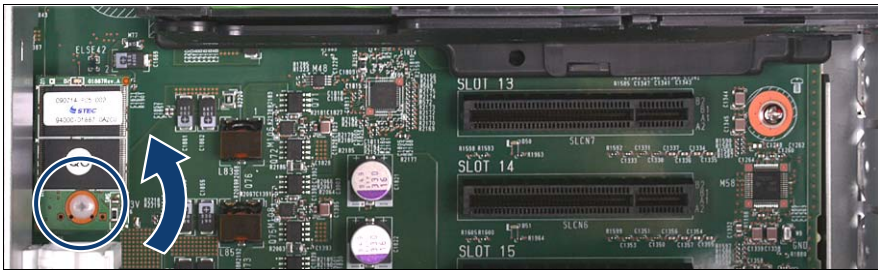

Figure 167: Removing the UFM board

- ▶ Remove the SAS and BBU cable(s) for a convenient access to the mounting location of the UFM.
- ▶ Remove the nylon screw on the defective UFM board.
- ▶ Disconnect and remove the defective UFM board.

**i** The metal spacer remains on the baseboard.



### 14.3.4 Completing the task

- ▶ Perform the following procedures to complete the task:
  1. ["Inserting the UFM" on page 265](#)
  2. When expansion cards have been removed to access the installation place: Install the expansion cards, see ["Expansion cards and BBU" on page 105](#)
  3. ["Installing the rear cover" on page 48](#)
  4. ["Mounting the server in the rack" on page 49](#)
  5. ["Bringing the server back to operation" on page 51](#)
  6. ["Closing the rack door" on page 51](#)

# 14.4 Installing the TPM



### Authorized personnel

Authorized specialist personnel can carry out replacement tasks for integral server components. Ask you local Fujitsu service center for more detailed information.



### CAUTION!

Procedures indicated as "Authorized personnel only" must be done by Fujitsu service personnel or technicians trained by Fujitsu for doing these tasks. Please note that unauthorized interference with the system will void the warranty and exempt the manufacturer from all liability.

## 14.4.1 Required tools

- Starting and completing the task:
  - key for the rack doors (if applicable)
  - Phillips Ph2 screw driver
- Installing the TPM:
  - Phillips Ph0 screw driver

## 14.4.2 Starting the task

- ▶ Perform the following procedures:
  1. ["Opening the rack door" on page 40](#)
  2. ["Shutting down the server" on page 41](#)
  3. ["Sliding the server out of the rack" on page 42](#)
  4. ["Opening the server" on page 44](#)
  5. Remove the PCI Riser, see ["Expansion cards and BBU" on page 105](#)

### 14.4.3 Inserting the TPM

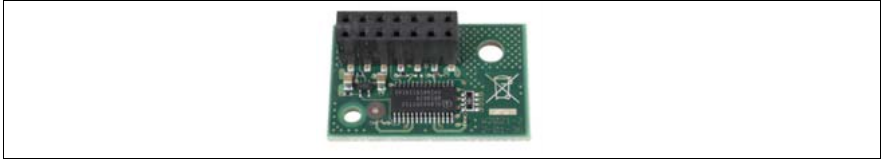

Figure 168: TPM board

Server-specific installation rules are:

- Only the TPM board is used from the available TPM installation kit, see [figure 168](#).
- The metal spacer and the Phillips screw are already installed on the baseboard.

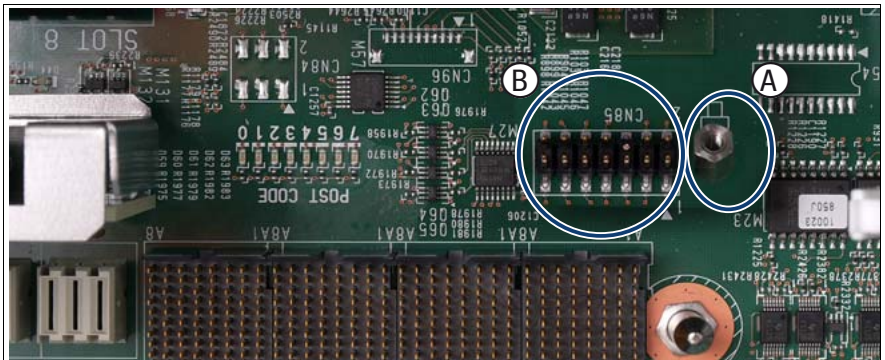

Figure 169: Checking the installation position

- ▶ Remove the Phillips screw from the metal spacer (A).
- ▶ Make sure that the metal spacer (A) engages properly in the baseboard.

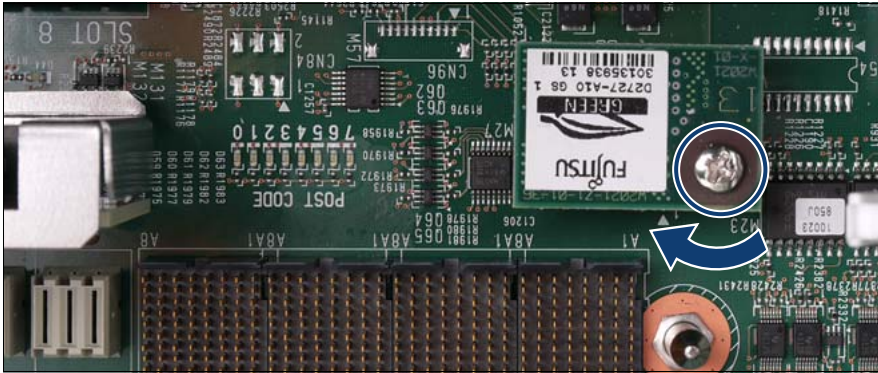

Figure 170: Installing the TPM board

- ▶ Place the TPM board on the metal spacer (A) and socket (B) in [figure 169](#) and fasten it with the Phillips screw.

### 14.4.4 Completing the task

- ▶ Perform the following procedures to complete the task:
  1. Install the PCI Riser, see ["Expansion cards and BBU" on page 105](#)
  2. ["Closing the server" on page 47](#)
  3. ["Mounting the server in the rack" on page 49](#)
  4. ["Bringing the server back to operation" on page 51](#)
  5. ["Closing the rack door" on page 51](#)

## 14.5 Replacing the TPM



### Authorized personnel

Authorized specialist personnel can carry out replacement tasks for integral server components. Ask your local Fujitsu service center for more detailed information.



### CAUTION!

Procedures indicated as "Authorized personnel only" must be done by Fujitsu service personnel or technicians trained by Fujitsu for doing these tasks. Please note that unauthorized interference with the system will void the warranty and exempt the manufacturer from all liability.



### CAUTION!

- Advise your contact persons that they must provide you with TPM backup copies. For security reasons, the TPM must be restored/removed by the customer. After installing a new baseboard the TPM must be enabled. You may not clear the TPM data.

If the contact persons **DO NOT** have a backup copy available, inform them that replacing the TPM board will cause to lose all data.

### 14.5.1 Required tools

- Starting and completing the task:
  - key for the rack doors (if applicable)
  - Phillips Ph2 screw driver
- Replacing the TPM:
  - Phillips Ph0 screw driver

### 14.5.2 Starting the task

- ▶ Perform the following procedures:
  1. "Opening the rack door" on page 40
  2. "Shutting down the server" on page 41
  3. "Sliding the server out of the rack" on page 42
  4. "Opening the server" on page 44

### 14.5.3 Removing the TPM

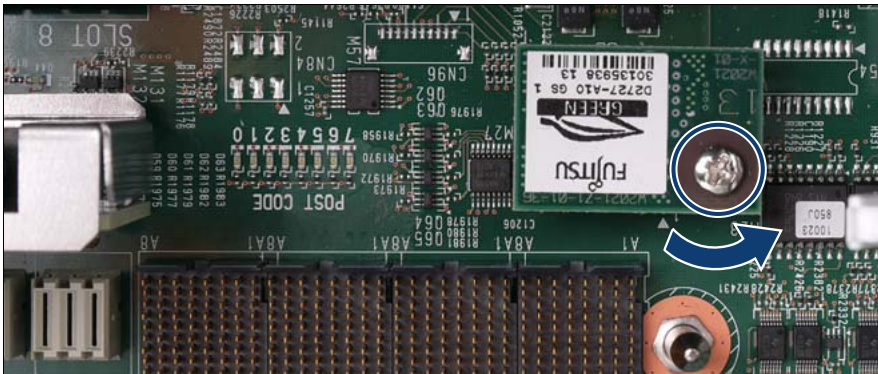



Figure 171: Removing the TPM board

- ▶ Remove the TPM screw.
  - ▶ Disconnect and remove the defective TPM board.
-  The TPM spacer remains on the baseboard.

## 14.5.4 Completing the task

- ▶ Perform the following procedures to complete the task:
  1. ["Installing the TPM" on page 270](#)
  2. ["Closing the server" on page 47](#)
  3. ["Mounting the server in the rack" on page 49](#)
  4. ["Bringing the server back to operation" on page 51](#)
  5. ["Closing the rack door" on page 51](#)

## 14.6 Replacing the baseboard



### Authorized personnel

Authorized specialist personnel can carry out replacement tasks for integral server components. Ask you local Fujitsu service center for more detailed information.



### CAUTION!

Procedures indicated as "Authorized personnel only" must be done by Fujitsu service personnel or technicians trained by Fujitsu for doing these tasks. Please note that unauthorized interference with the system will void the warranty and exempt the manufacturer from all liability.



The baseboard is optionally equipped with a Trusted Platform Module (TPM). This module enables programs from third party manufacturers to store key information, for example drive encryption using Windows Bitlocker Drive Encryption.

The TPM is activated via the BIOS system, see BIOS manual for the D3081 system.



### CAUTION!

- Before replacing the baseboard, ask the customer whether TPM functionality is used.
- If the customer is using TPM functionality, remove the TPM from the old baseboard and install it on the new baseboard. Advise the customer that he must provide you with TPM backup copies. For security reasons, the TPM must be restored/re-saved by the customer. After installing a new baseboard the TPM must be enabled. You may not clear the TPM data.



## 14.6.1 Required tools

- Starting and completing the task:
  - key for the rack doors (if applicable)
  - Phillips Ph2 screw driver
- Replacing the baseboard:
  - Phillips Ph0 screw driver
  - Phillips Ph1 screw driver
  - Phillips Ph2 screw driver

## 14.6.2 Starting the task

- ▶ Perform the following procedures:
  1. ["Opening the rack door" on page 40](#)
  2. ["Locate the faulty server" on page 37](#)
  3. ["Shutting down the server" on page 41](#)
  4. ["Sliding the server out of the rack" on page 42](#)
  5. ["Opening the server" on page 44](#)
  6. Remove all PSUs, see ["Removing the power supply unit" on page 58](#)
  7. Remove all CPUMEMRs, see ["Removing the CPUMEMR" on page 190](#)



Before removing the CPUMEMRs, take a note on the installation slot number for each CPUMEMR. Make sure that you reinstall the CPUMEMR in the slot it was located before the replacement.

8. Remove all expansion cards and dummy modules in PCIe slots #8 to #17, see ["Expansion cards and BBU" on page 105](#)



Before removing the expansion cards, take a note on the installation slot number for each card. Make sure that you reinstall the card in the slot it was located before the replacement.

## Baseboard

---

9. Remove the PCI Riser, see ["Expansion cards and BBU" on page 105](#)
10. Remove the BBU holder, see ["Expansion cards and BBU" on page 105](#)
11. ["Removing the I/O board" on page 244](#)
12. ["Removing the UFM" on page 268](#)
13. ["Removing the TPM" on page 274](#)

### 14.6.3 Sliding the local service display outward

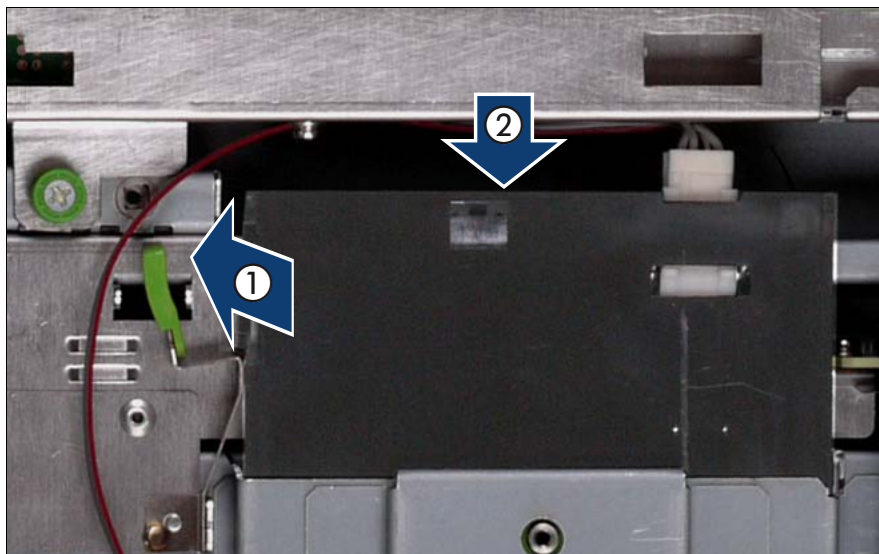

Figure 172: Sliding the local service display outward

- ▶ Unlock the local service display (1).
- ▶ Slide the local service display outward a few centimeters so that you have free access (2).

## 14.6.4 Disconnecting the cables

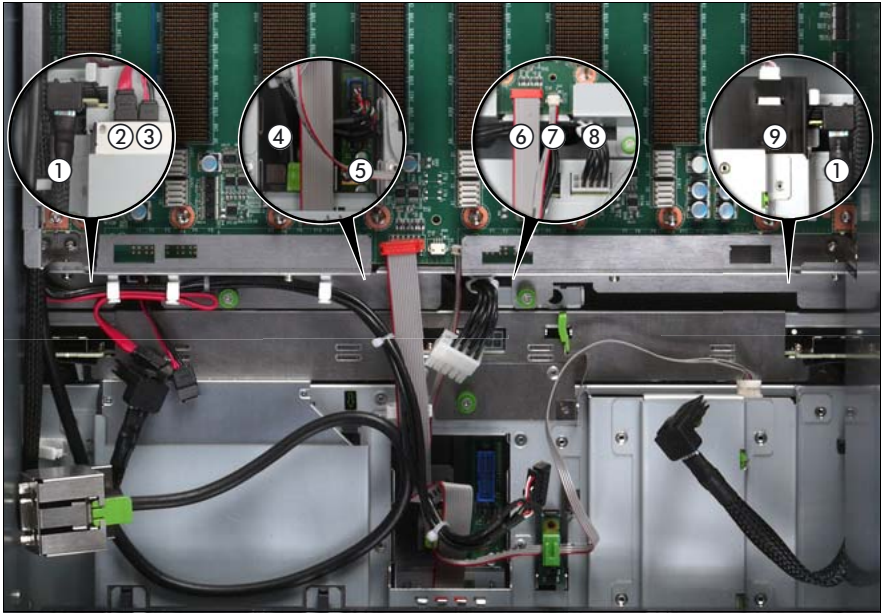

Figure 173: Disconnecting the cables from the baseboard

- ▶ Disconnect the following cables from the baseboard:
  - SAS backplane cable (1)
  - Signalling cable (2) and power cable (3) to the optical drive
  - Front video connector cable (4)
  - Front USB cable (5)
  - Control panel cable (6)
  - Chassis ID cable (7)
  - Power cable for the SAS backplane (8)

For the cable plan see "[Cabling](#)" on page 367.

### 14.6.5 Removing the fan cage

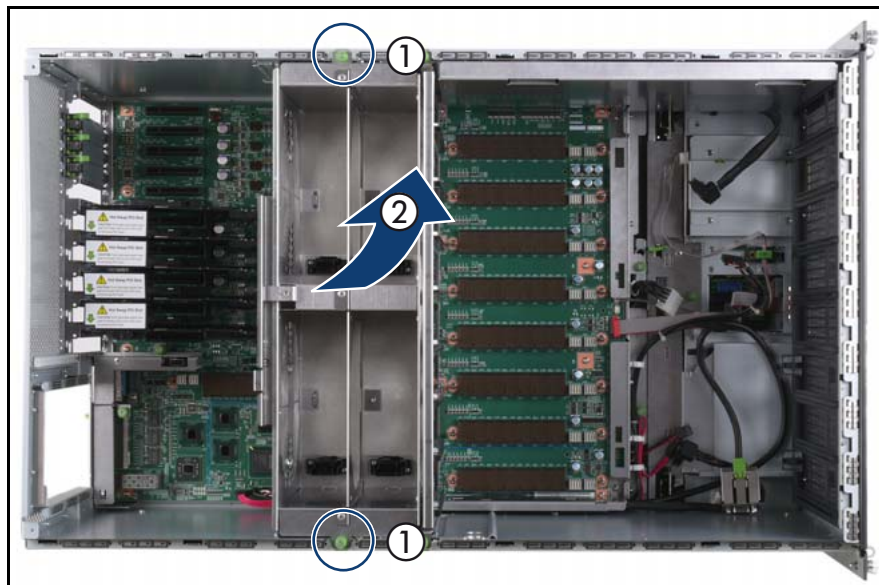

Figure 174: Removing the fan cage

- ▶ Loosen the captive screws (1).
- ▶ Lift the fan cage out of the chassis (2).

## 14.6.6 Removing the CPUMEMR guide

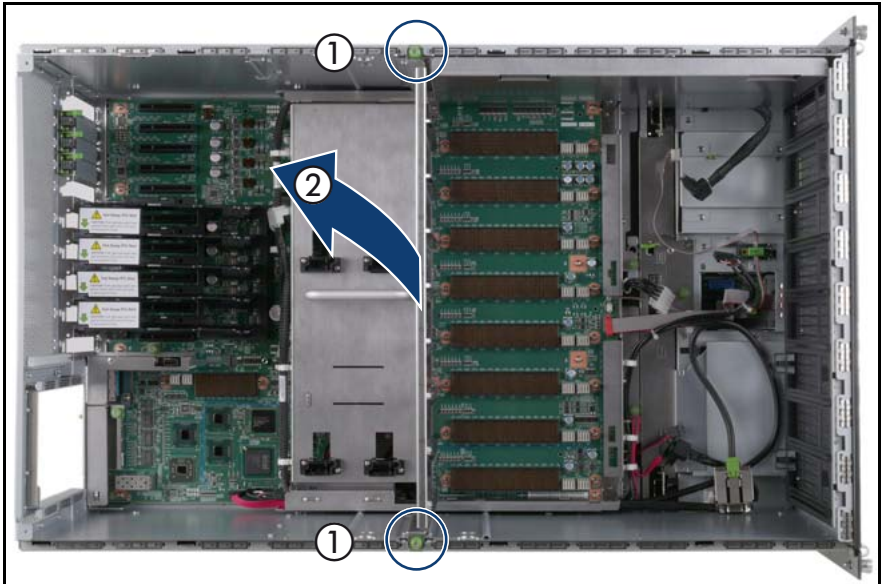

Figure 175: Removing the CPUMEMR guide

- ▶ Loosen the captive screws of the CPUMEMR guide (1).
- ▶ Lift the CPUMEMR guide out of the chassis (2).

### 14.6.7 Removing the air guide

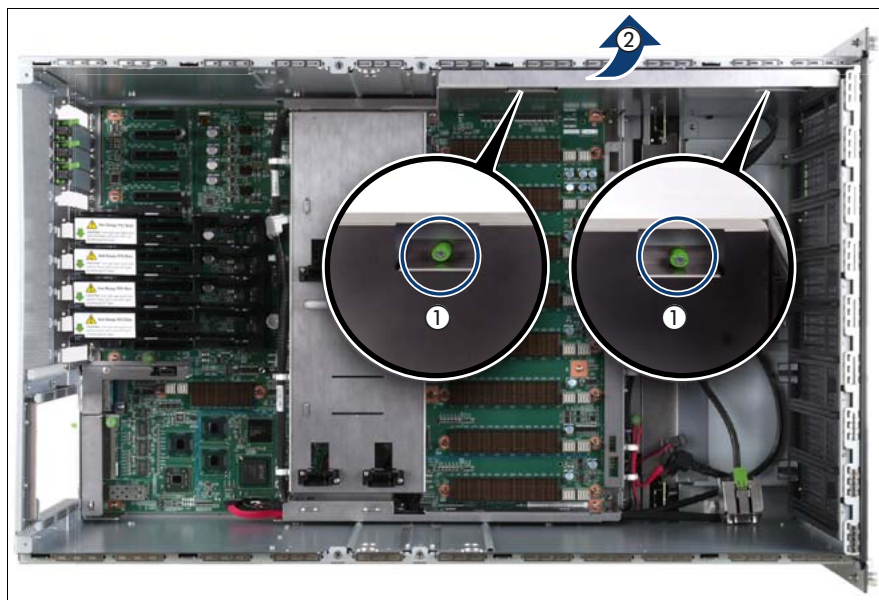

Figure 176: Removing the air guide

- ▶ Loosen the captive screws (1).
- ▶ Lift the air guide out of the chassis (2).

## 14.6.8 Removing the baseboard

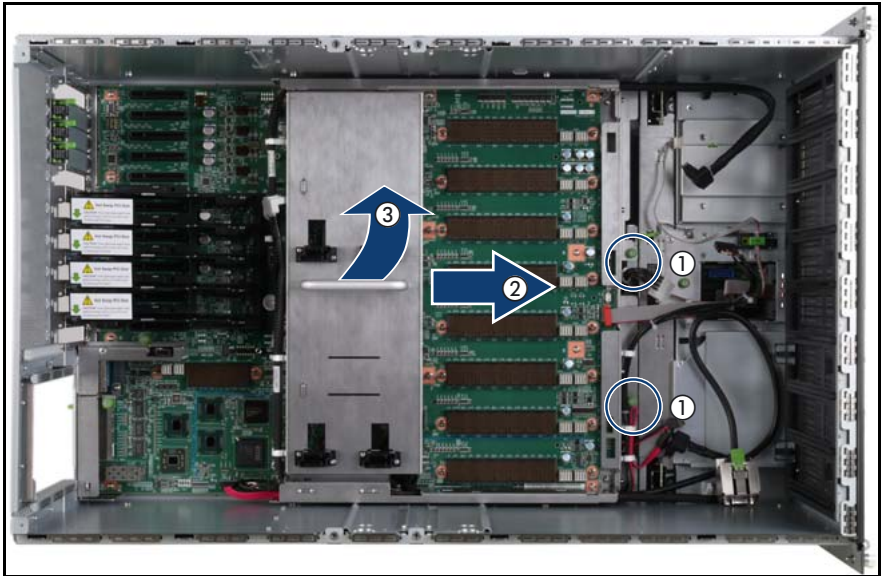

Figure 177: Removing the baseboard

- ▶ Loosen the captive screws (1).
- ▶ Slide the baseboard approximately 1 cm in the direction of the arrow (2).



### CAUTION!

Make sure that you have removed all power supply units before removing the baseboard. Otherwise, the power supply units or the power distribution board might be damaged.

- ▶ Carefully lift the baseboard out of the chassis by using the handle (3).



## 14.6.9 Inserting the baseboard

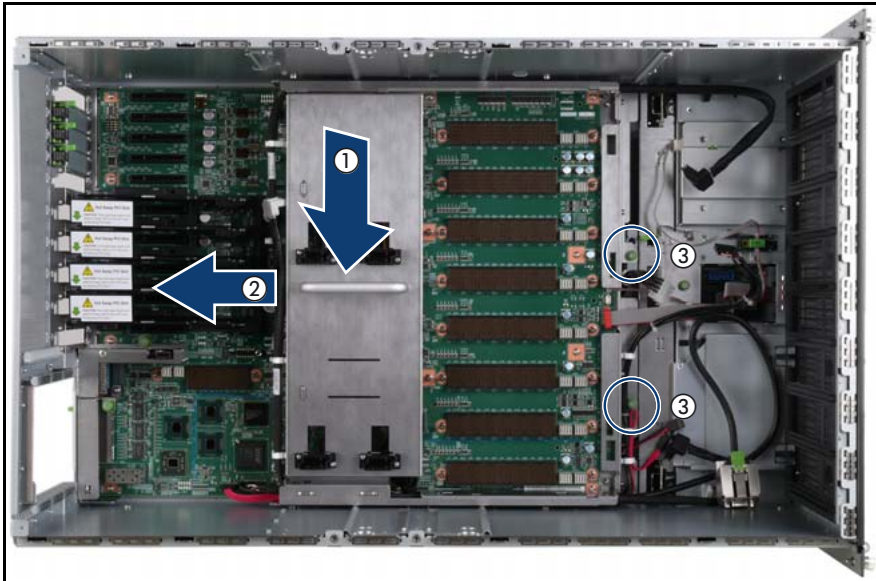

Figure 178: Inserting the baseboard

- ▶ Carefully lower the baseboard in the chassis by using the handle (1).
- ▶ Slide the baseboard in the direction of the arrow (2) until it is into place.
- ▶ Fasten the captive screws (3).



### CAUTION!

After installing the new baseboard, it is necessary to update system specific data (e.g. BIOS, iRMC S2 firmware) to ensure proper operation (BIOS flash floppy disk, BIOS flash memory stick or iRMC flash memory stick, refer to the BIOS Manual for a detailed description).



If the customer owns a license key for Advanced Video Redirection and Remote Storage (iRMC2 Advanced Pack), the license key has to be loaded onto the iRMC S2 via the iRMC S2 web interface after replacing the baseboard. In addition, the iRMC S2 requires configuration. Please refer to the "ServerView Suite iRMC S2 - integrated Remote Management Controller" manual for a detailed description.



**CAUTION!**

Ensure not to damage the EMI springs to comply with applicable EMC regulations and satisfy cooling requirements and fire protection measures.

### 14.6.10 Installing the air guide

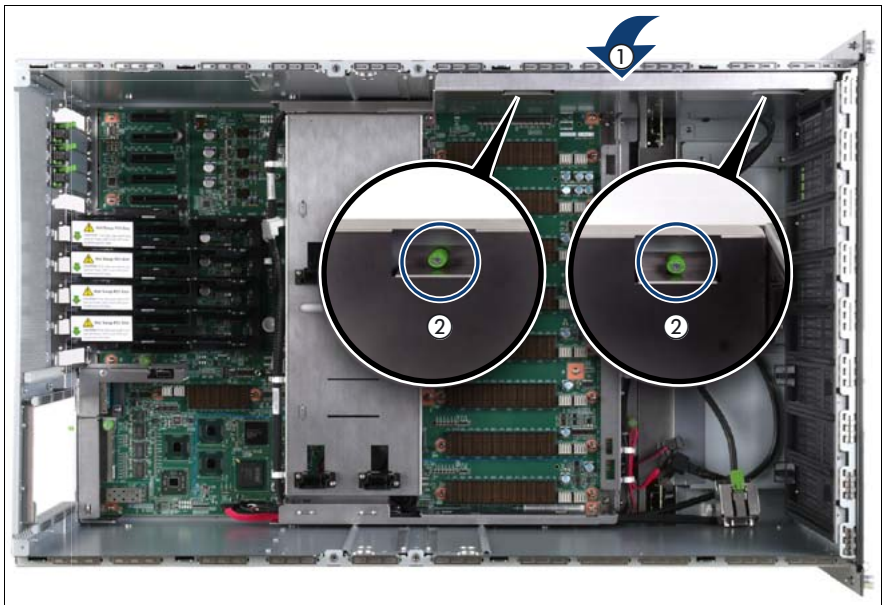

Figure 179: Installing the air guide

- ▶ Place the air guide in the chassis (1).
- ▶ Fasten the captive screws (2).

### 14.6.11 Inserting the CPUMEMR guide

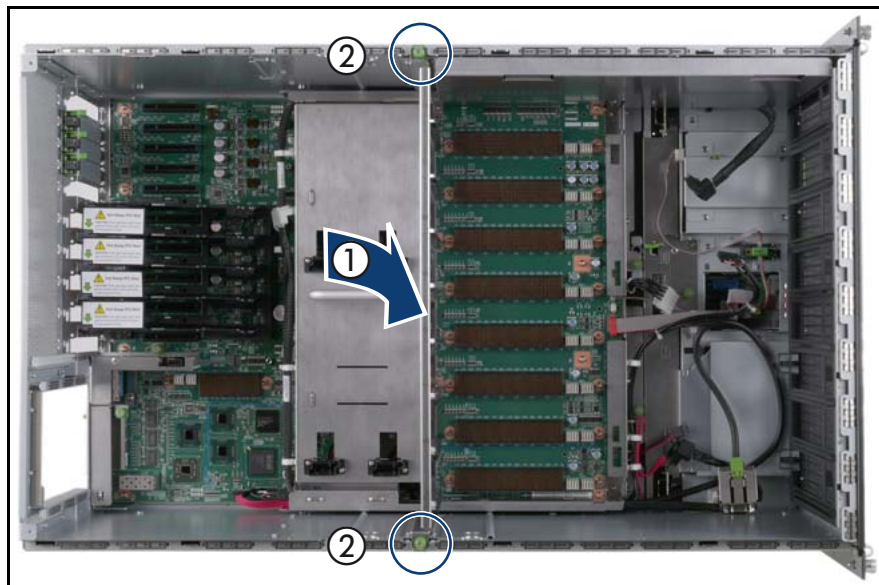

Figure 180: Inserting the CPUMEMR guide

- ▶ Insert the CPUMEMR guide in the installation slot (1).
- ▶ Fasten the captive screws of the CPUMEMR guide (2).

## 14.6.12 Inserting the fan cage

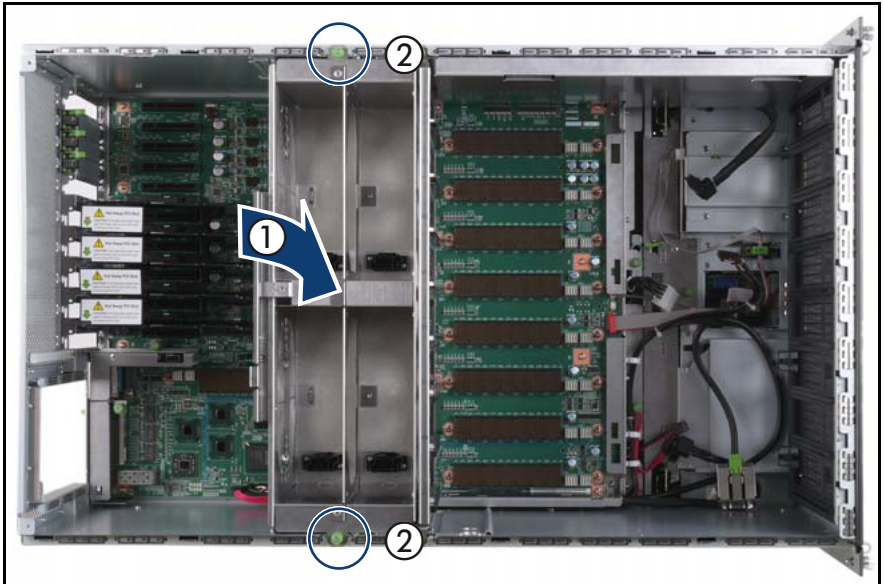

Figure 181: Inserting the fan cage

- ▶ Insert the fan cage in the bay (1).
- ▶ Fasten the captive screws (2).

### 14.6.13 Connecting the cables to the baseboard

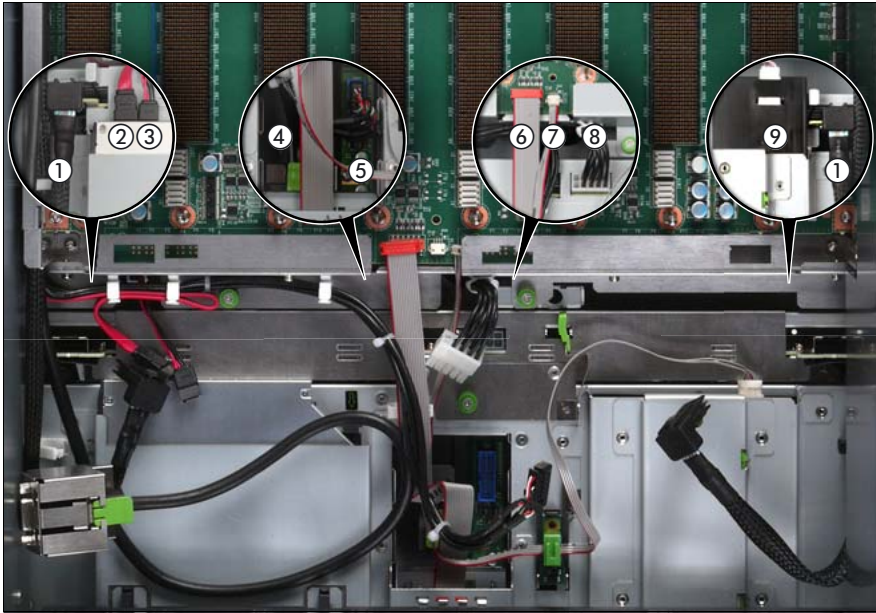

Figure 182: Connecting the cables to the baseboard

- ▶ Connect the following cables to the baseboard:
  - SAS backplane cable (1)
  - Signalling cable (2) and power cable (3) to the optical drive
  - Front video connector cable (4)
  - Front USB cable (5)
  - Control panel cable (6)
  - Chassis ID cable (7)
  - Power cable to the SAS backplane (8)

For the cable plan see "[Cabling](#)" on page 367.

### 14.6.14 Sliding the local service display inward

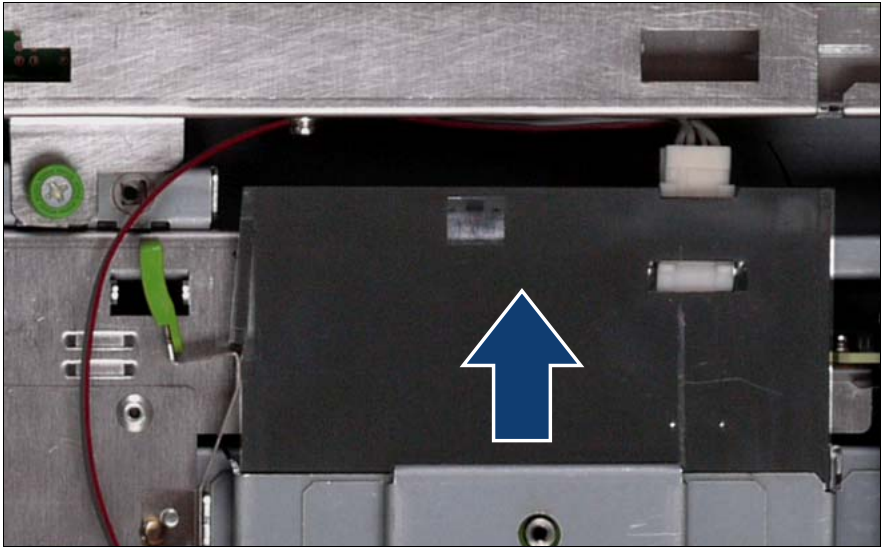

Figure 183: Sliding the local service display inward

- ▶ Slide the local service display inward until it clicks into place.

### 14.6.15 Completing the task

- ▶ Perform the following procedures to complete the task:
  1. ["Inserting the TPM" on page 271](#)
  2. ["Inserting the UFM" on page 265](#)
  3. ["Installing the I/O board" on page 244](#)
  4. Install the BBU holder, see ["Expansion cards and BBU" on page 105](#)
  5. Install the PCI Riser, see ["Expansion cards and BBU" on page 105](#)
  6. Install all expansion cards and dummy modules in PCIe slots #8 to #17, see ["Expansion cards and BBU" on page 105](#)



Make sure that you reinstall each card in the slots it was located before the replacement.

## Baseboard

---

7. Install all CPUMEMRs, see ["Removing the CPUMEMR" on page 190](#)
    -  Make sure that you reinstall each CPUMEMR in the slot it was located before the replacement.
  8. Install all PSUs, see ["Installing a power supply unit" on page 55](#)
  9. ["Closing the server" on page 47](#)
  10. ["Mounting the server in the rack" on page 49](#)
  11. ["Bringing the server back to operation" on page 51](#)
  12. ["Closing the rack door" on page 51](#)
- Verify the settings on the new baseboard, see the "Baseboard D3081, CPUMEMR D3131, PCIR D3082 for PRIMERGY RX900 S1 Technical Manual" for a detailed description.

## 15 Cables



### Authorized personnel

Authorized specialist personnel can carry out replacement tasks for integral server components. Ask you local Fujitsu service center for more detailed information.



### CAUTION!

Procedures indicated as "Authorized personnel only" must be done by Fujitsu service personnel or technicians trained by Fujitsu for doing these tasks. Please note that unauthorized interference with the system will void the warranty and exempt the manufacturer from all liability.



### CAUTION!

Follow the safety instructions in the chapter "[Safety instructions](#)" on [page 31](#).

This section comprises procedures on replacing the following cables:

- "[Replacing the control panel cable](#)" on [page 301](#)
- "[Replacing the chassis ID board cable](#)" on [page 307](#)
- "[Replacing power cables of the optical drive, the SAS backplane, or the power distribution board](#)" on [page 315](#)
- "[Replacing the SAS cable, the SATA cable, the front video connector cable, or the front USB cable](#)" on [page 333](#)

For the cable plan see "[Cabling](#)" on [page 367](#).

# 15.1 Replacing the fan cables



### Authorized personnel

Authorized specialist personnel can carry out replacement tasks for integral server components. Ask you local Fujitsu service center for more detailed information.



### CAUTION!

Procedures indicated as "Authorized personnel only" must be done by Fujitsu service personnel or technicians trained by Fujitsu for doing these tasks. Please note that unauthorized interference with the system will void the warranty and exempt the manufacturer from all liability.

## 15.1.1 Required tools

- Starting and completing the task:
  - key for the rack doors (if applicable)
  - Phillips Ph2 screw driver
- Replacing the fan cable:
  - Phillips Ph0 screw driver
  - Phillips Ph2 screw driver

## 15.1.2 Starting the task

- ▶ Perform the following procedures:
  1. ["Opening the rack door" on page 40](#)
  2. ["Locate the faulty server" on page 37](#)
  3. ["Shutting down the server" on page 41](#)
  4. ["Sliding the server out of the rack" on page 42](#)
  5. ["Opening the server" on page 44](#)



6. Remove all CPUMEMRs, see ["Removing the CPUMEMR" on page 190](#)

**i** Before removing the CPUMEMRs, take a note on the installation slot number for each CPUMEMR. Make sure that you reinstall the CPUMEMR in the slot it was located before the replacement.

7. Remove all expansion cards and dummy modules in PCIe slots #8 to #17, see ["Expansion cards and BBU" on page 105](#)

**i** Before removing the expansion cards, take a note on the installation slot number for each card. Make sure that you reinstall the card in the slot it was located before the replacement.

8. Remove the PCI Riser, see ["Expansion cards and BBU" on page 105](#)

### 15.1.3 Removing the fan cage

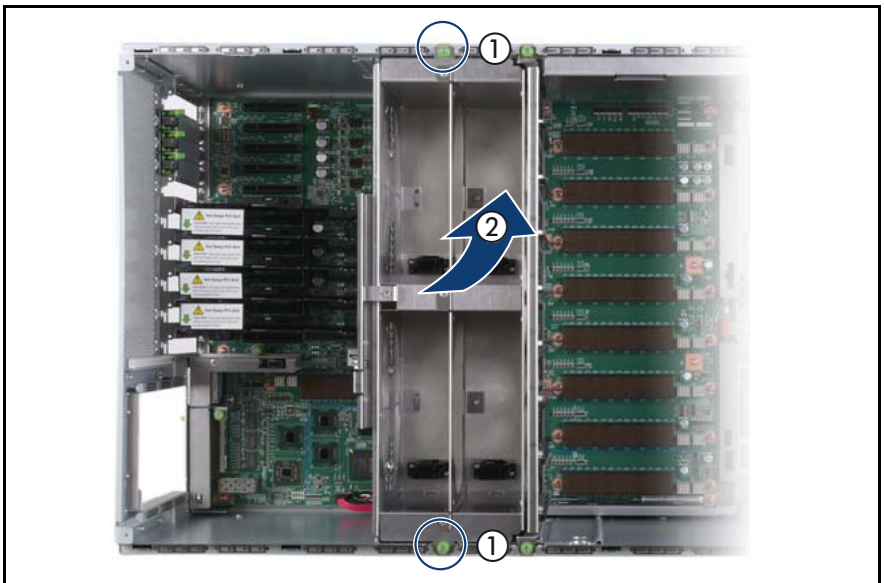

Figure 184: Removing the fan cage

- ▶ Loosen the captive screws (1).
- ▶ Lift the fan cage out of the chassis (2).

### 15.1.4 Removing the CPUMEMR guide

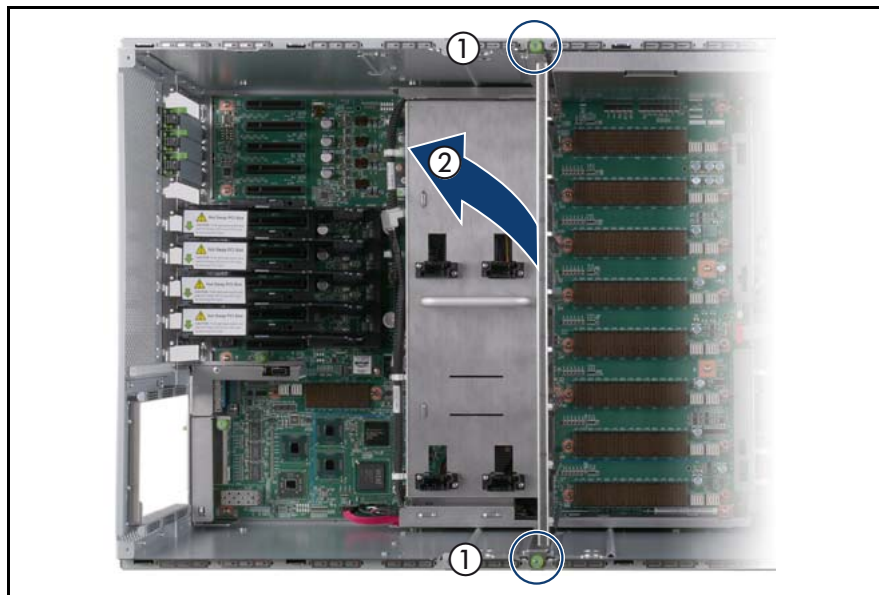

Figure 185: Removing the CPUMEMR guide

- ▶ Loosen the captive screws of the CPUMEMR guide (1).
- ▶ Lift the CPUMEMR guide out of the chassis (2).

## 15.1.5 Removing the fan cable

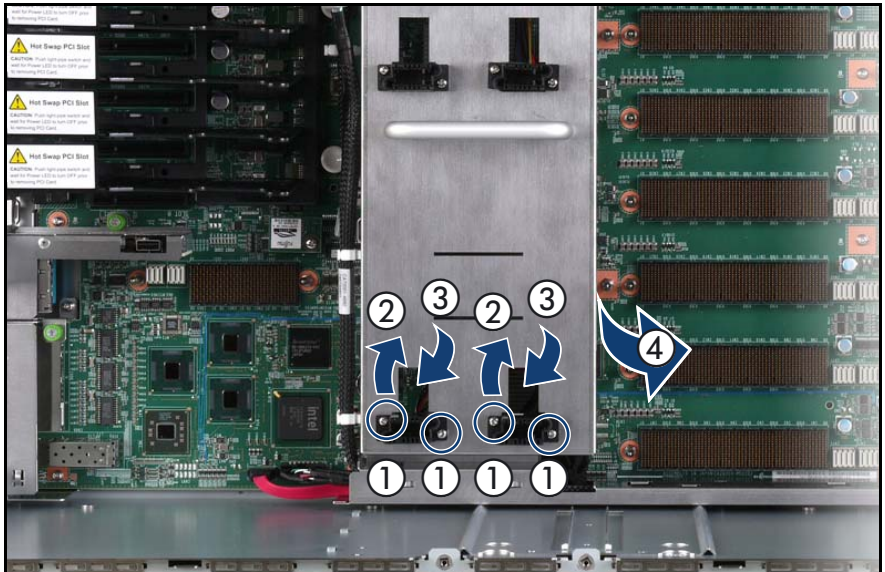

Figure 186: Removing the fan cable

- ▶ Remove the screws and the plug washers of the fan connectors (1).



Be careful while removing the screws as the plug washers might fall on the baseboard.

- ▶ Rotate each connector by 90° (2) and slide it in the cutout of the fan base (3).
- ▶ Pull the connectors out from underneath the fan base as indicated by the arrow (4).

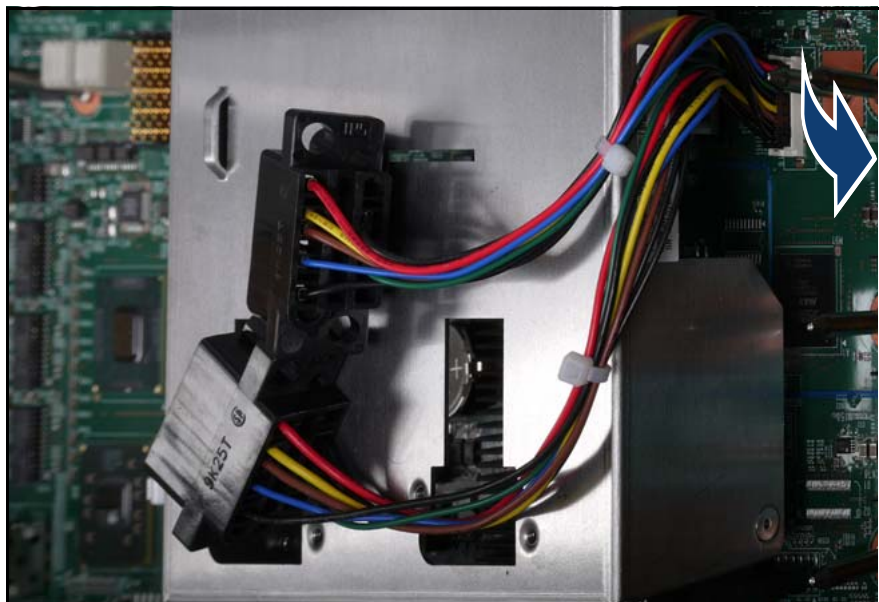

Figure 187: Disconnecting the fan cable

- ▶ Disconnect the fan cable from the baseboard.

## 15.1.6 Installing the fan cable

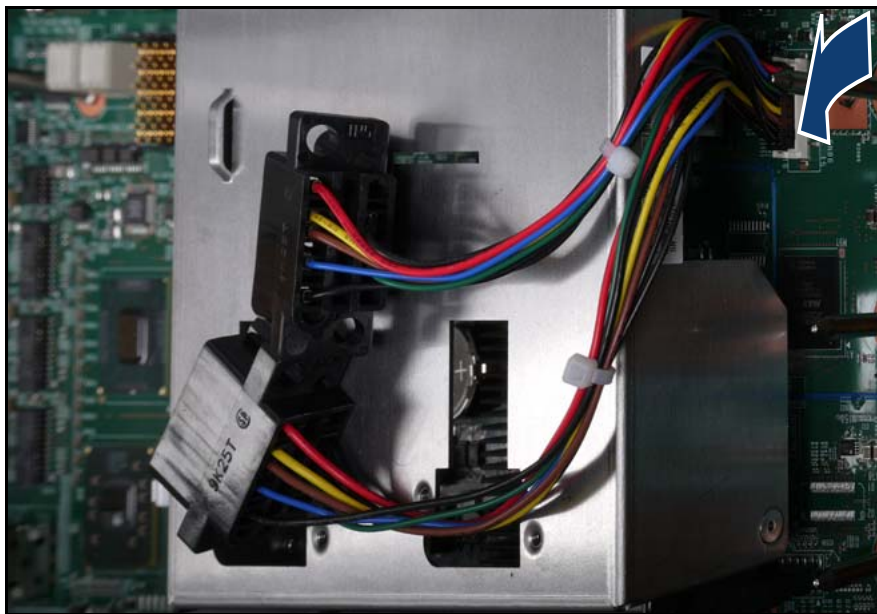

Figure 188: Connecting the fan cable

- ▶ Connect the fan cable to the baseboard.

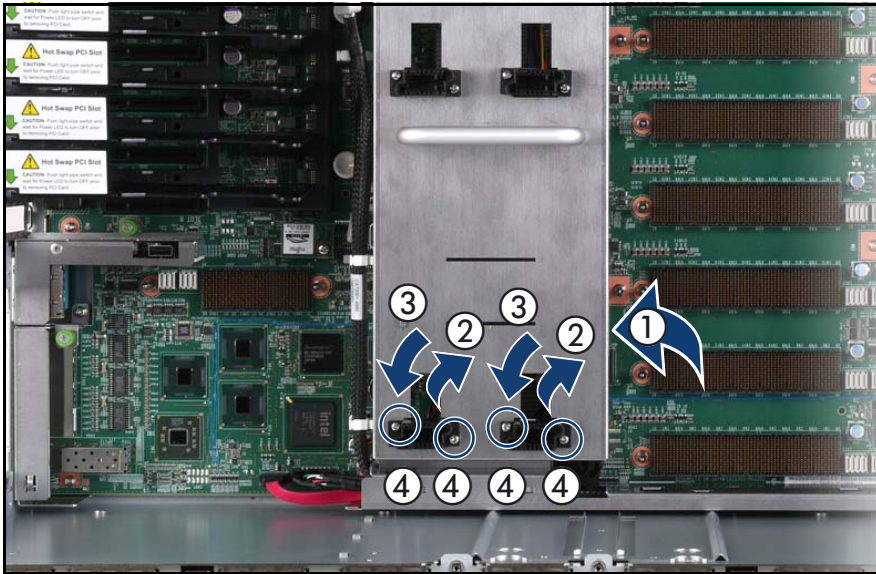

Figure 189: Installing the fan cable

- ▶ Pull the connectors underneath the fan base as indicated by the arrow (1).
- ▶ Slide each connector through the cutout of the fan base (2) and rotate it by 90° (3).
- ▶ Fasten the screws and the plug washers of the fan connectors (4).

**i** Be careful while inserting the screws as the plug washers might fall on the baseboard.



### 15.1.7 Inserting the CPUMEMR guide

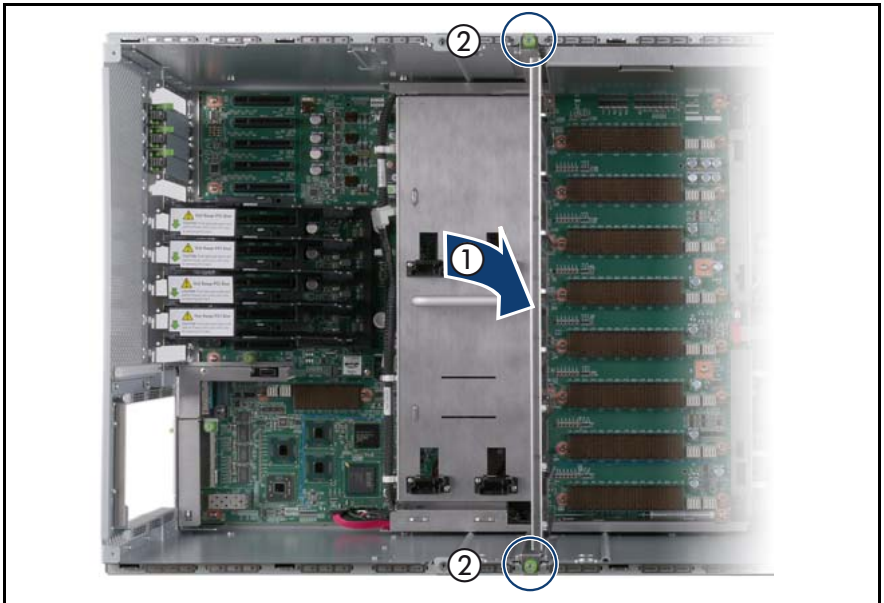

Figure 190: Inserting the CPUMEMR guide

- ▶ Insert the CPUMEMR guide in the installation slot (1).
- ▶ Fasten the captive screws of the CPUMEMR guide (2).

## 15.1.8 Inserting the fan cage



Figure 191: Inserting the fan cage

- ▶ Insert the fan cage in the bay (1).
- ▶ Fasten the captive screws (2).

## 15.1.9 Completing the task

- ▶ Perform the following procedures to complete the task:
  1. Install the PCI Riser, see ["Expansion cards and BBU" on page 105](#)
  2. Install all expansion cards and dummy modules in PCIe slots #8 to #17, see ["Expansion cards and BBU" on page 105](#)
    - i** Make sure that you reinstall each card in the slots it was located before the replacement.
  3. Install all CPUMEMRs, see ["Removing the CPUMEMR" on page 190](#)
    - i** Make sure that you reinstall each CPUMEMR in the slot it was located before the replacement.



4. "Closing the server" on page 47
5. "Mounting the server in the rack" on page 49
6. "Bringing the server back to operation" on page 51
7. "Closing the rack door" on page 51

## 15.2 Replacing the control panel cable



### Authorized personnel

Authorized specialist personnel can carry out replacement tasks for integral server components. Ask you local Fujitsu service center for more detailed information.



### CAUTION!

Procedures indicated as "Authorized personnel only" must be done by Fujitsu service personnel or technicians trained by Fujitsu for doing these tasks. Please note that unauthorized interference with the system will void the warranty and exempt the manufacturer from all liability.

### 15.2.1 Required tools

- Starting and completing the task:
  - key for the rack doors (if applicable)
  - Phillips Ph2 screw driver
- Replacing the control panel cable: tool-less

## 15.2.2 Starting the task

- ▶ Perform the following procedures:
  1. "Opening the rack door" on page 40
  2. "Shutting down the server" on page 41
  3. "Sliding the server out of the rack" on page 42
  4. "Opening the server" on page 44
  5. Remove all CPUMEMRs, see "Removing the CPUMEMR" on page 190



Before removing the CPUMEMRs, take a note on the installation slot number for each CPUMEMR. Make sure that you reinstall the CPUMEMR in the slot it was located before the replacement.

## 15.2.3 Removing the control panel

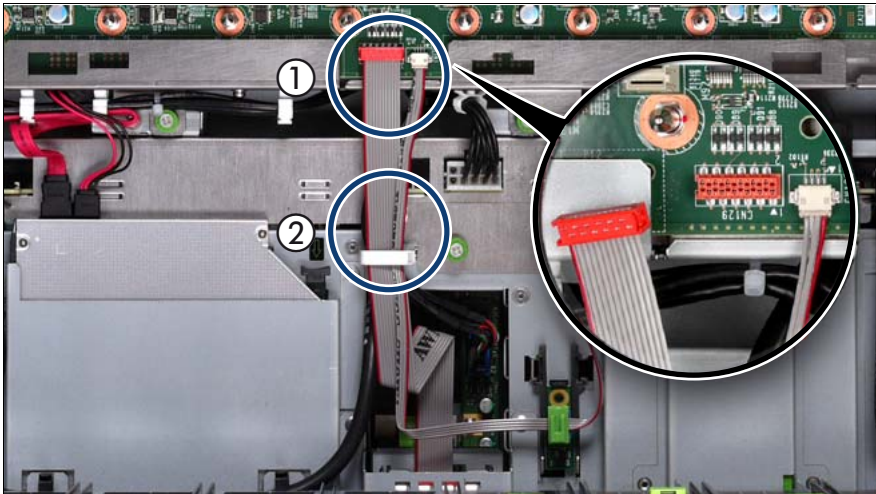

Figure 192: Disconnecting the control panel cable from the baseboard

- ▶ Disconnect the control panel cable from the baseboard (1).
- ▶ Open the cable clamp (2).

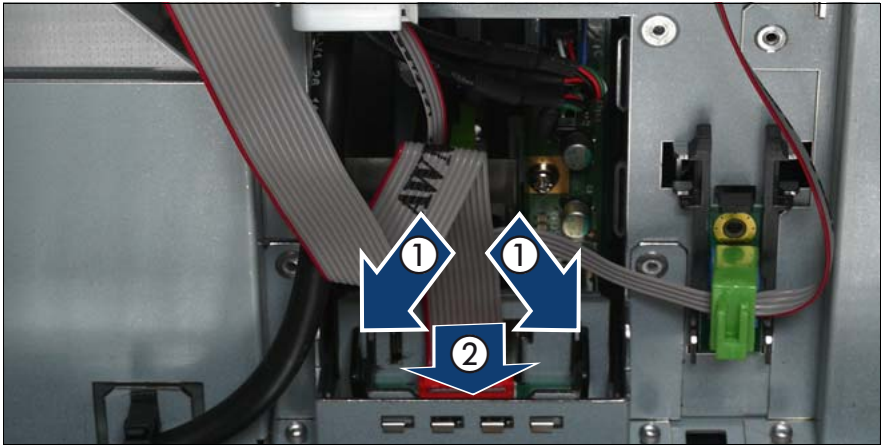

Figure 193: Removing the control panel

- ▶ Press the plastic tongues slightly outward as indicated by the arrows (1).
- ▶ Push the control panel outward (2).

## 15.2.4 Disconnecting the control panel cable

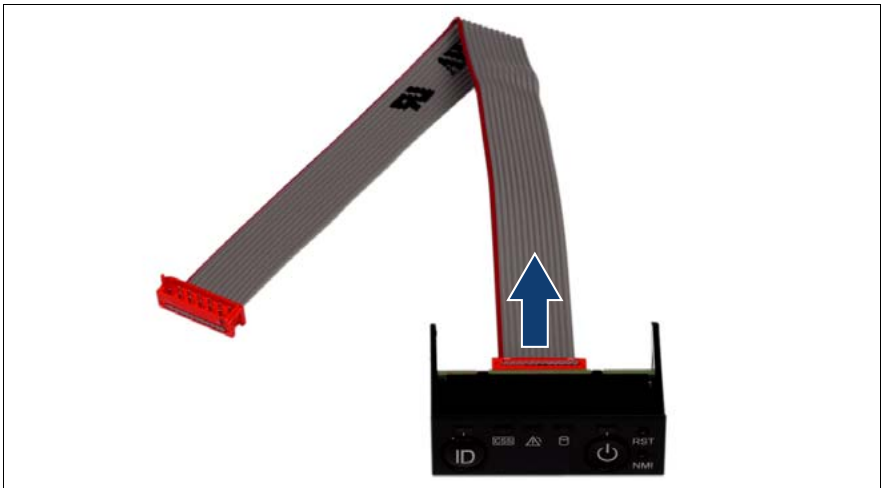

Figure 194: Disconnecting the control panel cable from the control panel

- ▶ Disconnect the control panel cable from the control panel.

### 15.2.5 Connecting the control panel cable

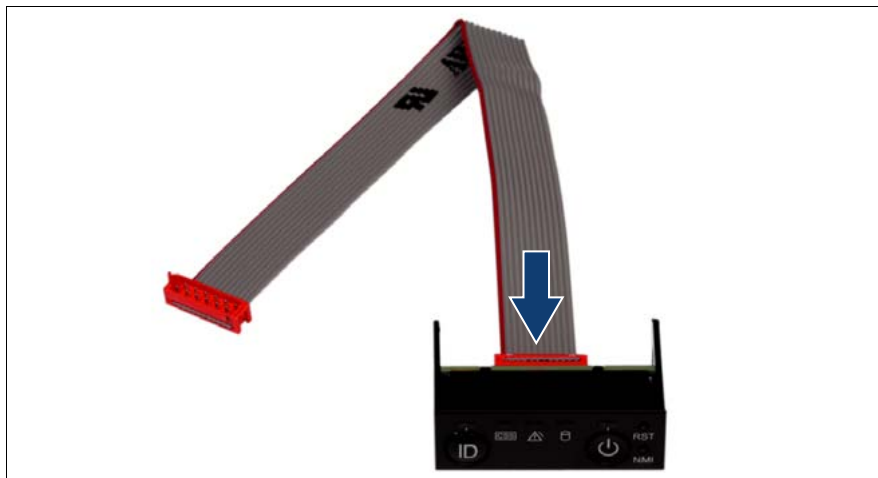

Figure 195: Connecting the control panel cable to the control panel

- ▶ Connect the control panel cable to the control panel.

## 15.2.6 Installing the control panel



Figure 196: Installing the control panel

- ▶ Slide the control panel into the bay until it clicks into place.

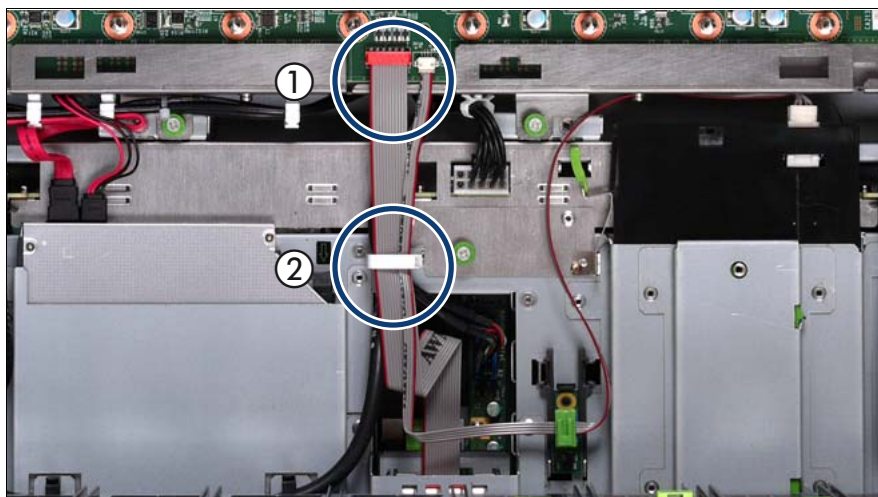

Figure 197: Connecting the control panel cable

- ▶ Connect the control panel cable to the baseboard (1).
- ▶ Close the cable clamp (2).

### 15.2.7 Completing the task

- ▶ Perform the following procedures to complete the task:
  1. ["Inserting the CPUMEMR in the slot" on page 186](#)
  2. ["Closing the server" on page 47](#)
  3. ["Mounting the server in the rack" on page 49](#)
  4. ["Bringing the server back to operation" on page 51](#)
  5. ["Closing the rack door" on page 51](#)

## 15.3 Replacing the chassis ID board cable



### Authorized personnel

Authorized specialist personnel can carry out replacement tasks for integral server components. Ask your local Fujitsu service center for more detailed information.



### CAUTION!

Procedures indicated as "Authorized personnel only" must be done by Fujitsu service personnel or technicians trained by Fujitsu for doing these tasks. Please note that unauthorized interference with the system will void the warranty and exempt the manufacturer from all liability.

### 15.3.1 Required tools

- Starting and completing the task:
  - key for the rack doors (if applicable)
  - Phillips Ph2 screw driver
- Replacing the chassis ID board cable: tool-less

### 15.3.2 Starting the task

- ▶ Perform the following procedures:
  1. ["Opening the rack door" on page 40](#)
  2. ["Shutting down the server" on page 41](#)
  3. ["Sliding the server out of the rack" on page 42](#)
  4. ["Opening the server" on page 44](#)
  5. Remove all CPUMEMRs, see ["Removing the CPUMEMR" on page 190](#)



Before removing the CPUMEMRs, take a note on the installation slot number for each CPUMEMR. Make sure that you reinstall the CPUMEMR in the slot it was located before the replacement.

### 15.3.3 Removing the chassis ID board

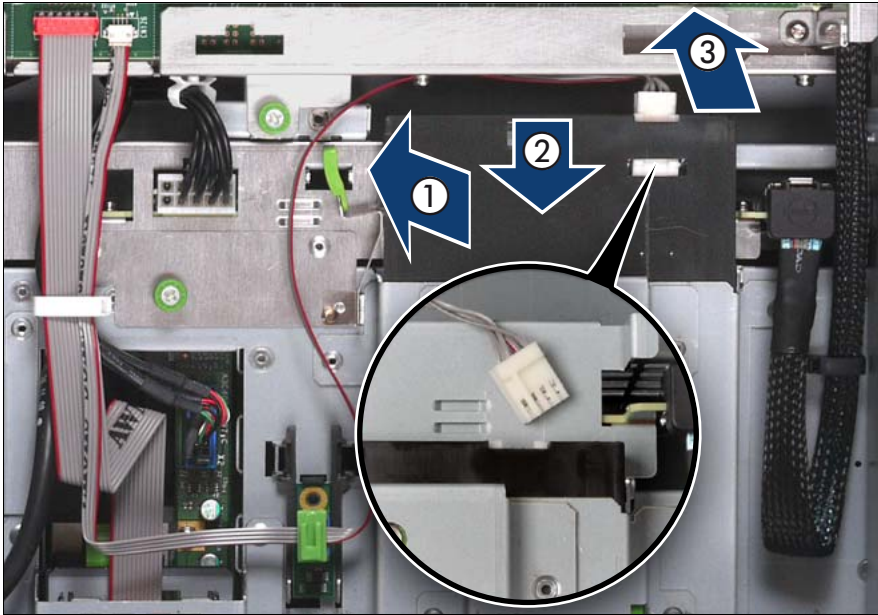

Figure 198: Removing the chassis ID board cable from the local service display

- ▶ Unlock the local service display (1).
- ▶ Slide the local service display outward so that you can disconnect the chassis ID board cable (2).
- ▶ Disconnect the chassis ID board cable (3).



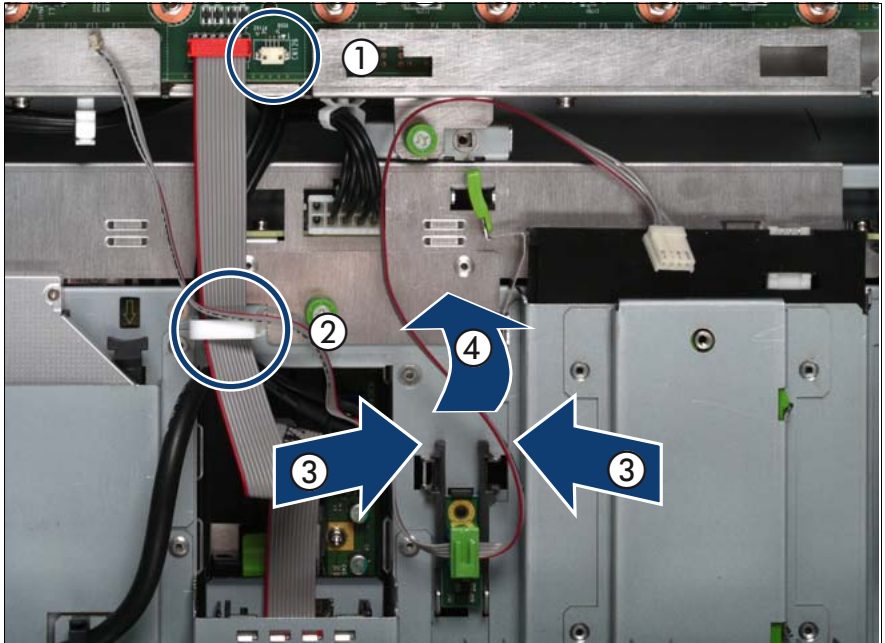

Figure 199: Removing the chassis ID board holder

- ▶ Disconnect the chassis ID board cable from the baseboard (1) and open the cable clamp (2).
- ▶ Press the plastic tongues of the chassis ID holder slightly inward as indicated by the arrows (3).
- ▶ Slide the chassis ID board holder outward (4).

### 15.3.4 Disconnecting the chassis ID board cable

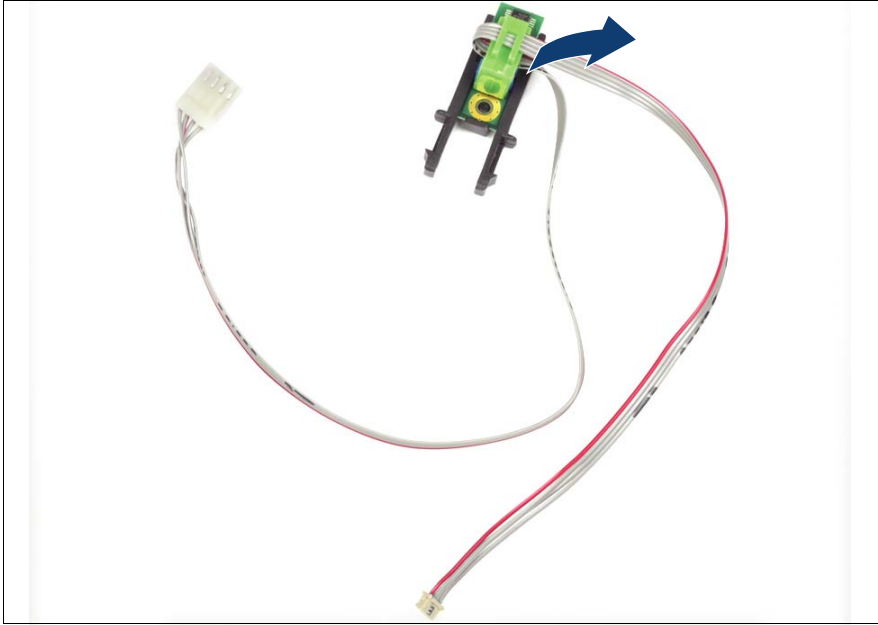

Figure 200: Removing the connector clamp

- ▶ Remove the connector clamp.

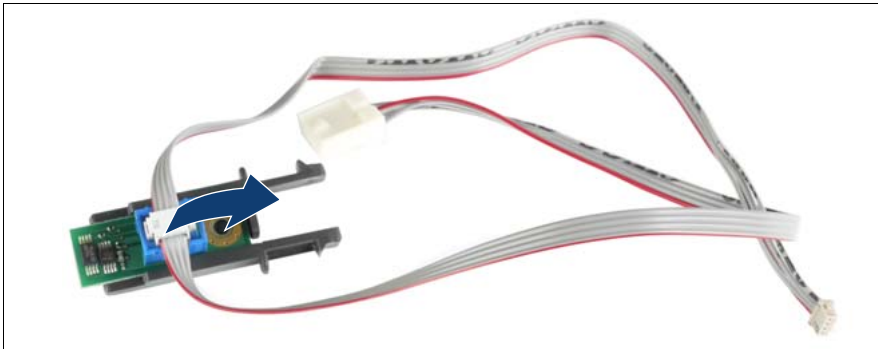

Figure 201: Disconnecting the chassis ID board cable

- ▶ Disconnect the chassis ID board cable from the chassis ID board.

### 15.3.5 Connecting the chassis ID board cable

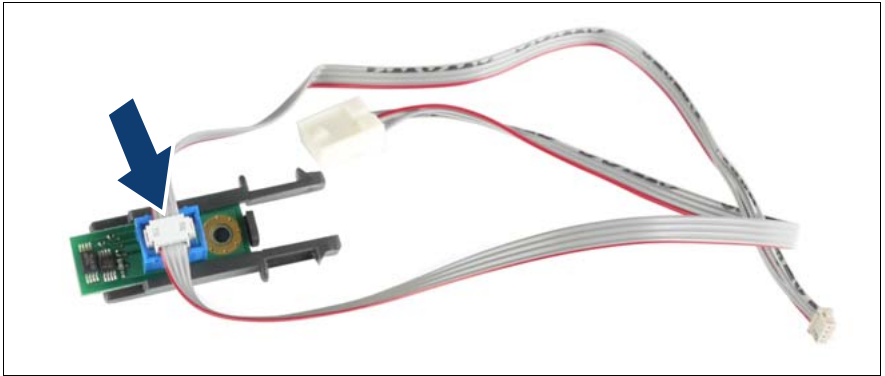

Figure 202: Connecting the chassis ID board cable

- ▶ Connect the chassis ID board cable to the chassis ID board.

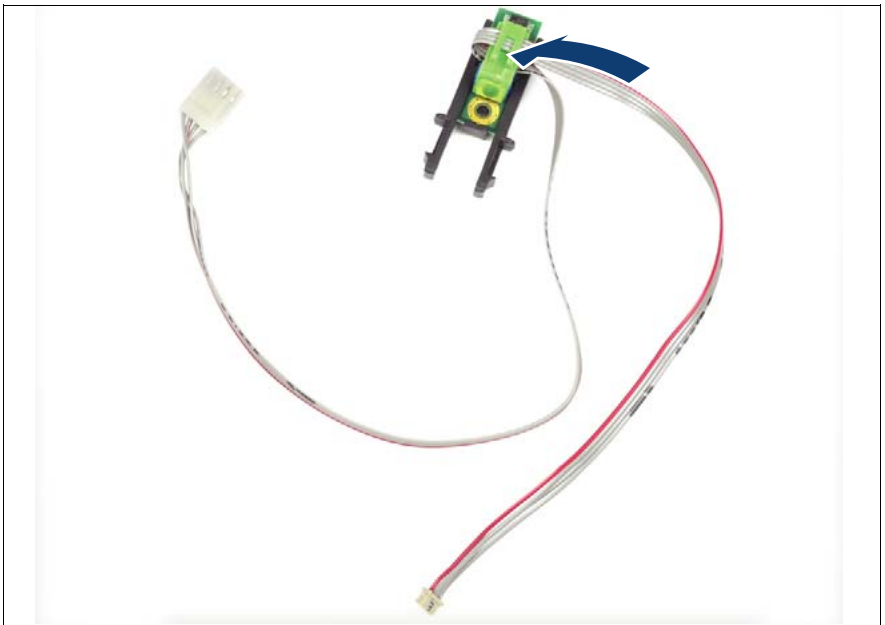

Figure 203: Installing the connector clamp

- ▶ Install the connector clamp.

### 15.3.6 Installing the chassis ID board

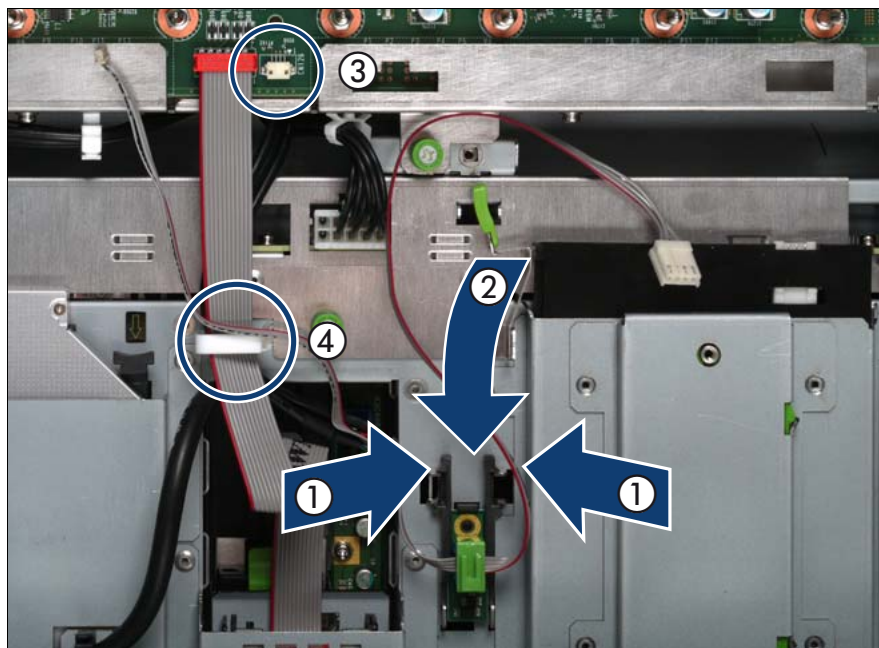

Figure 204: Installing the chassis ID board holder

- ▶ Press the plastic tongues of the chassis ID holder slightly inward as indicated by the arrows (1) and slide the chassis ID board holder inward until it clicks into place (2).
- ▶ Connect the chassis ID board cable at the baseboard (3) and close the cable clamp (4).

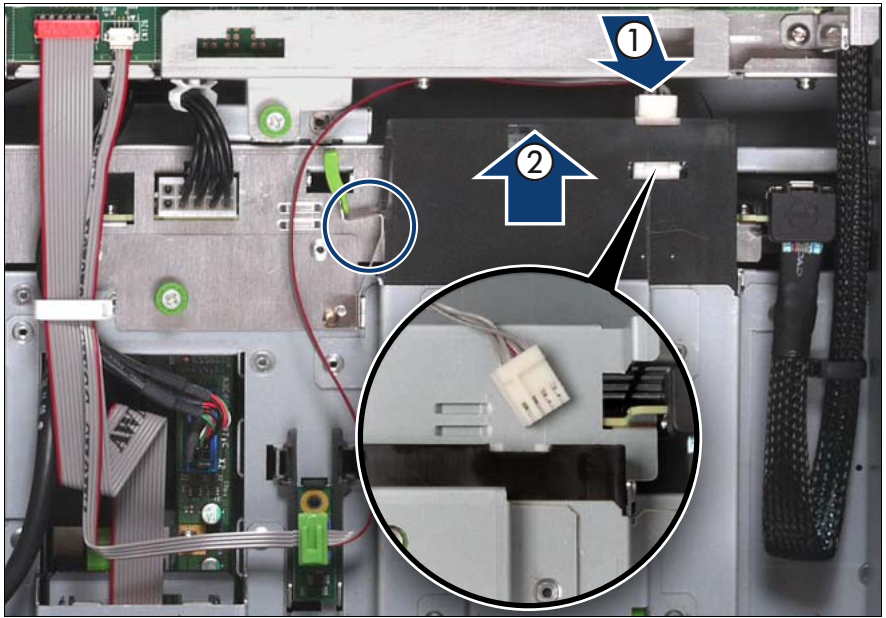

Figure 205: Connecting the chassis ID board cable

- ▶ Connect the chassis ID board cable (1).
- ▶ Slide the local service display inward until it clicks into place (2).

**i** In order to enable ServerView Operations Manager and ServerView Installation Manager to identify the system, it is necessary to program the chassis ID prom using the "ChassisIDProm Tool" after installing the new chassis ID board. This tool is available for download from the following Fujitsu Technology Solutions support page:

<http://partners.ts.fujitsu.com/com/service/intelservers/tools>

### 15.3.7 Completing the task

- ▶ Perform the following procedures to complete the task:
  1. ["Inserting the CPUMEMR in the slot" on page 186](#)
  2. ["Closing the server" on page 47](#)
  3. ["Mounting the server in the rack" on page 49](#)
  4. ["Bringing the server back to operation" on page 51](#)
  5. ["Closing the rack door" on page 51](#)

## 15.4 Replacing power cables of the optical drive, the SAS backplane, or the power distribution board



### Authorized personnel

Authorized specialist personnel can carry out replacement tasks for integral server components. Ask your local Fujitsu service center for more detailed information.



### CAUTION!

Procedures indicated as "Authorized personnel only" must be done by Fujitsu service personnel or technicians trained by Fujitsu for doing these tasks. Please note that unauthorized interference with the system will void the warranty and exempt the manufacturer from all liability.

### 15.4.1 Required tools

- Starting and completing the task:
  - key for the rack doors (if applicable)
  - Phillips Ph2 screw driver
- Replacing the power cables of the optical drive, the SAS backplane, or the power distribution board:
  - Phillips Ph2 screw driver

### 15.4.2 Starting the task

- ▶ Perform the following procedures:
  1. ["Opening the rack door" on page 40](#)
  2. ["Locate the faulty server" on page 37](#)
  3. ["Shutting down the server" on page 41](#)
  4. ["Sliding the server out of the rack" on page 42](#)
  5. ["Opening the server" on page 44](#)

## Cables

6. Remove all PSUs, see ["Removing the power supply unit" on page 58](#)
7. Remove all CPUMEMRs, see ["Removing the CPUMEMR" on page 190](#)

**i** Before removing the CPUMEMRs, take a note on the installation slot number for each CPUMEMR. Make sure that you reinstall the CPUMEMR in the slot it was located before the replacement.

8. Remove all expansion cards and dummy modules in PCIe slots #8 to #17, see ["Expansion cards and BBU" on page 105](#)

**i** Before removing the expansion cards, take a note on the installation slot number for each card. Make sure that you reinstall the card in the slot it was located before the replacement.

9. Remove the PCI Riser, see ["Expansion cards and BBU" on page 105](#)
10. Remove the BBU holder, see ["Expansion cards and BBU" on page 105](#)

### 15.4.3 Sliding the local service display outward

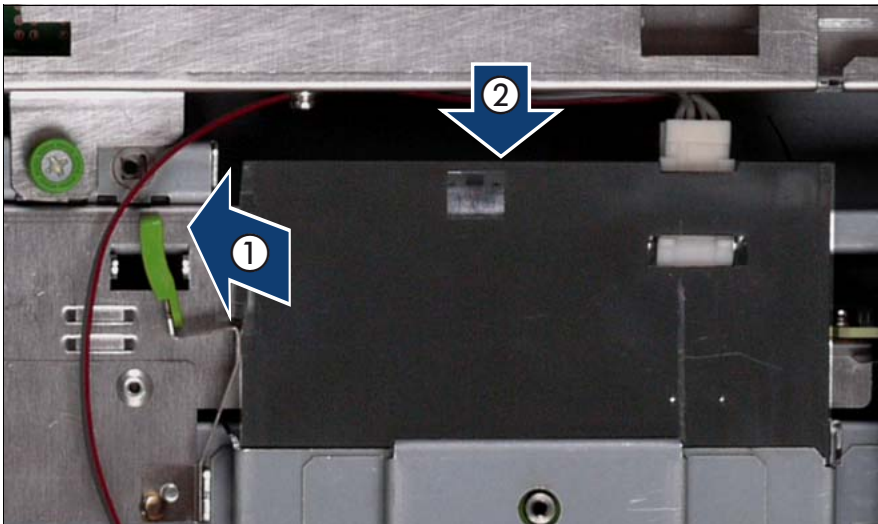

Figure 206: Sliding the local service display outward

- ▶ Unlock the local service display (1).
- ▶ Slide the local service display outward a few centimeters so that you have free access (2).



## 15.4.4 Disconnecting the cables

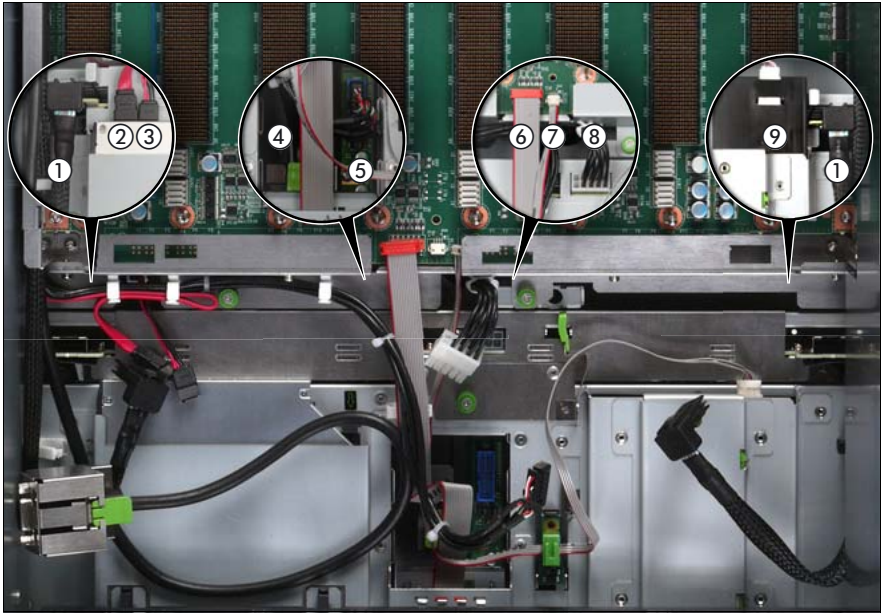

Figure 207: Disconnecting the cables from the baseboard

- ▶ Disconnect the following cables from the baseboard:
  - SAS backplane cable (1)
  - Signalling cable (2) and power cable (3) to the optical drive
  - Front video connector cable (4)
  - Front USB cable (5)
  - Control panel cable (6)
  - Chassis ID cable (7)
  - Power cable for the SAS backplane (8)

For the cable plan see "[Cabling](#)" on page 367.

### 15.4.5 Removing the fan cage

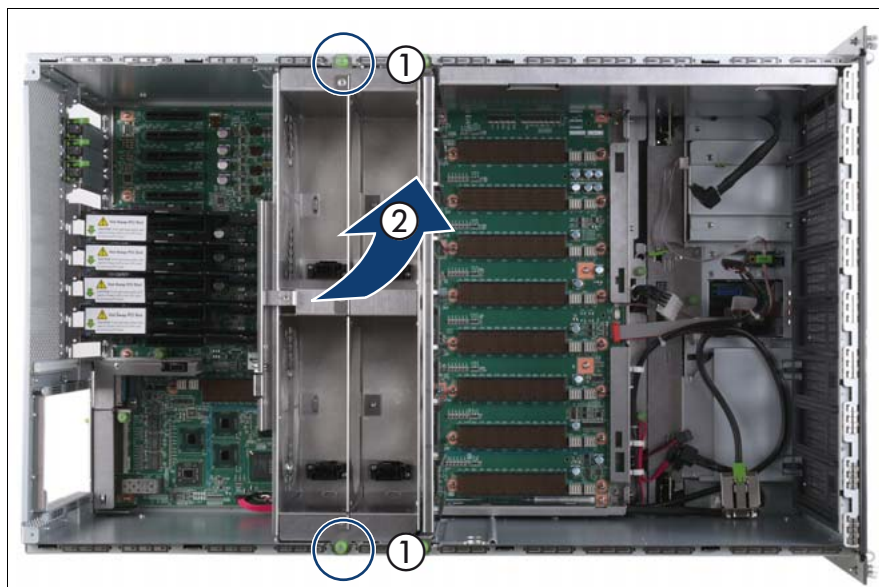

Figure 208: Removing the fan cage

- ▶ Loosen the captive screws (1).
- ▶ Lift the fan cage out of the chassis (2).

## 15.4.6 Removing the CPUMEMR guide

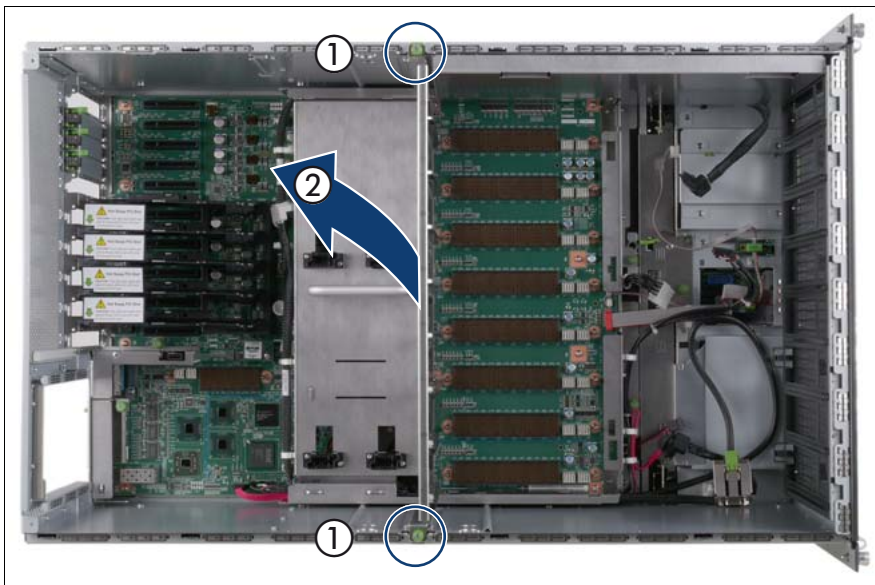

Figure 209: Removing the CPUMEMR guide

- ▶ Loosen the captive screws of the CPUMEMR guide (1).
- ▶ Lift the CPUMEMR guide out of the chassis (2).

### 15.4.7 Removing the air guide

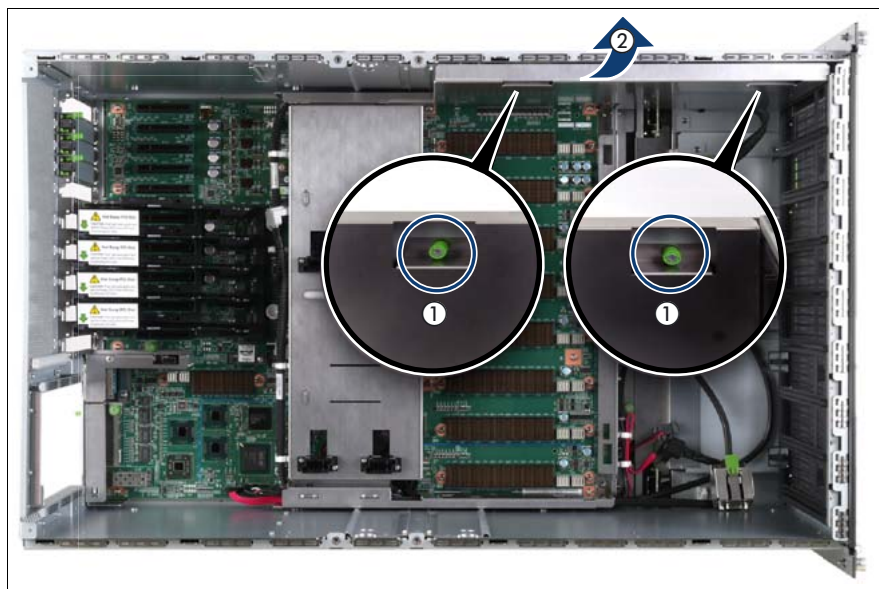

Figure 210: Removing the air guide

- ▶ Loosen the captive screws (1).
- ▶ Lift the air guide out of the chassis (2).

## 15.4.8 Removing the baseboard

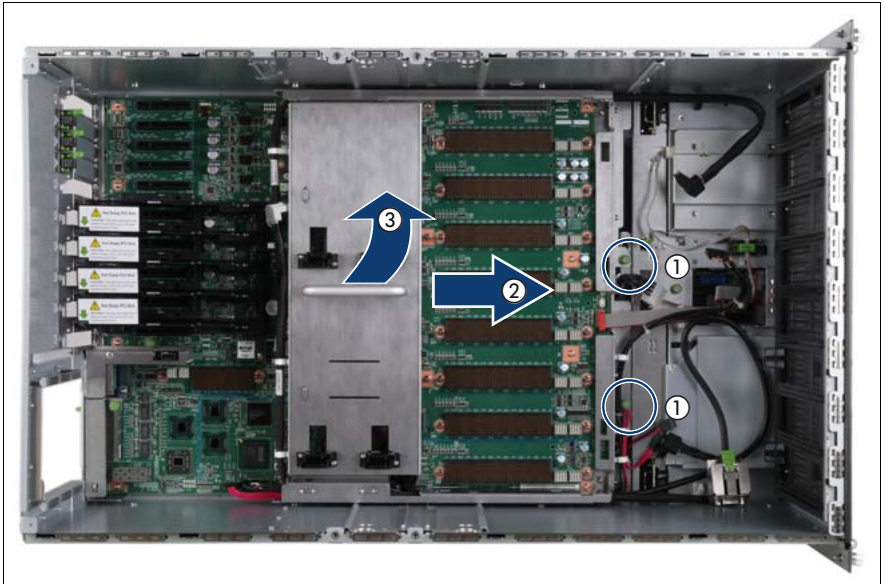

Figure 211: Removing the baseboard

- ▶ Loosen the captive screws (1).
- ▶ Slide the baseboard approximately 1 cm in the direction of the arrow (2).



### CAUTION!

Make sure that you have removed all power supply units before removing the baseboard. Otherwise, the power supply units or the power distribution board might be damaged.

- ▶ Carefully lift the baseboard out of the chassis by using the handle (3).

### 15.4.9 Removing the power distribution board

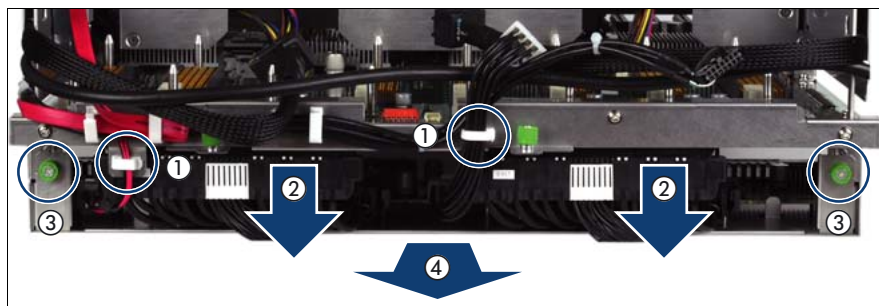

Figure 212: Removing the power distribution board

- ▶ Open the cable clamps (1).
- ▶ Disconnect the power distribution cables from the baseboard (2).
- ▶ Loosen the captive screws (3).
- ▶ Remove the power distribution board from the baseboard.

### 15.4.10 Disconnecting the defective power distribution cable(s)

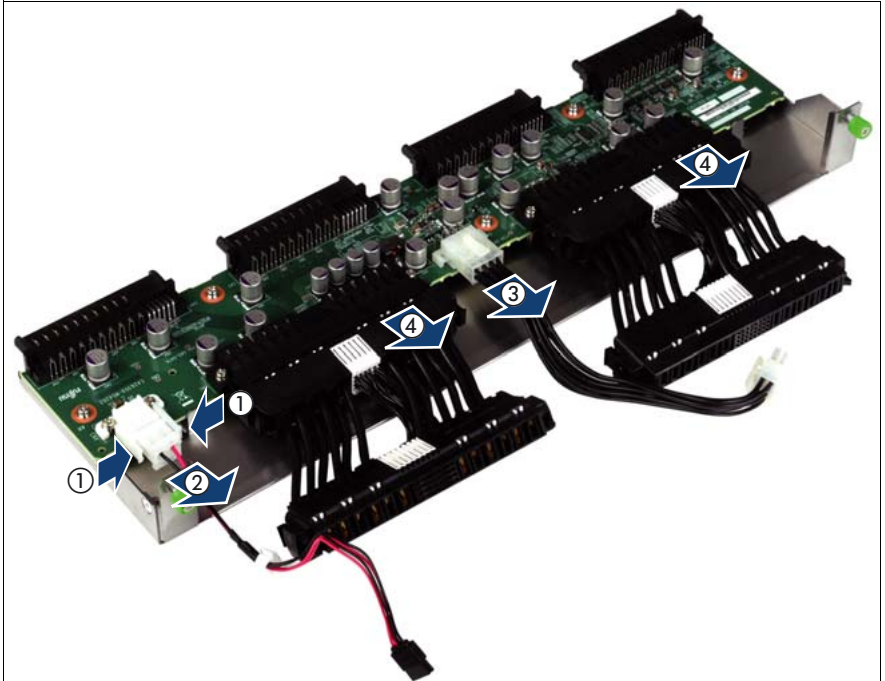

Figure 213: Disconnecting power distribution cables

- ▶ Select the defective cable(s) and disconnect it/them from the power distribution board:
  - power cable of the optical drive (1, 2)
  - power cable for the SAS backplane (3)
  - power distribution cables (4)



### 15.4.11 Connecting the new power distribution cable(s)

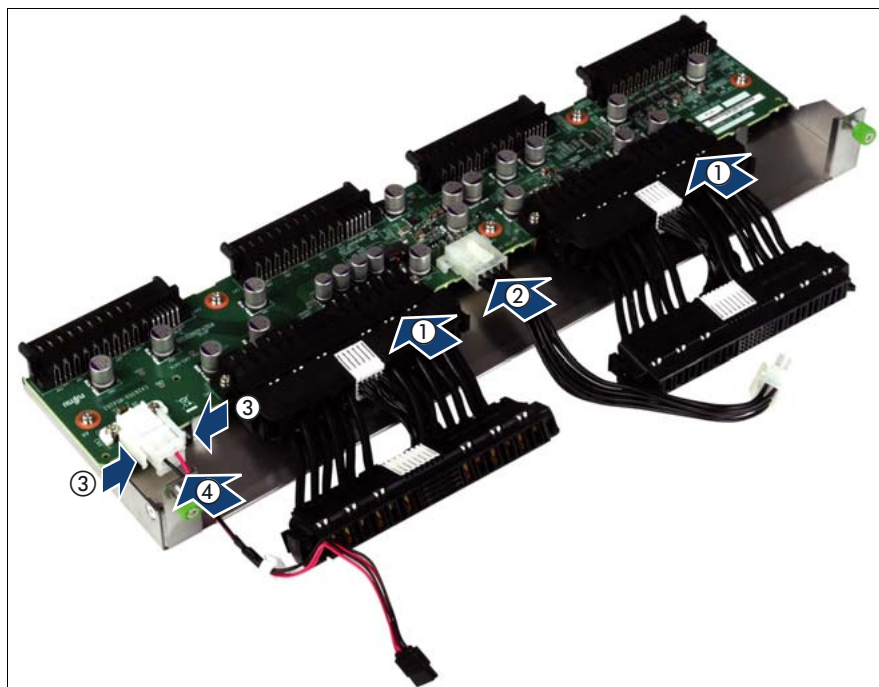

Figure 214: Connecting power distribution cables

- ▶ Connect the new cable(s) to the power distribution board:
  - power distribution cables (1)
  - power cable for the SAS backplane (2)
  - power cable of the optical drive (3, 4)



## 15.4.12 Installing the power distribution board

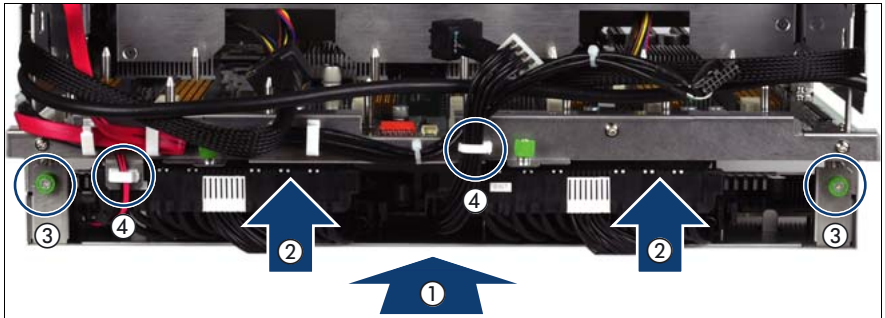

Figure 215: Installing the power distribution board

- ▶ Insert the power distribution board in the baseboard (1).
- ▶ Connect the power distribution cables to the baseboard (2).
- ▶ Fasten the captive screws (3).
- ▶ Close the cable clamps (4).

### 15.4.13 Inserting the baseboard

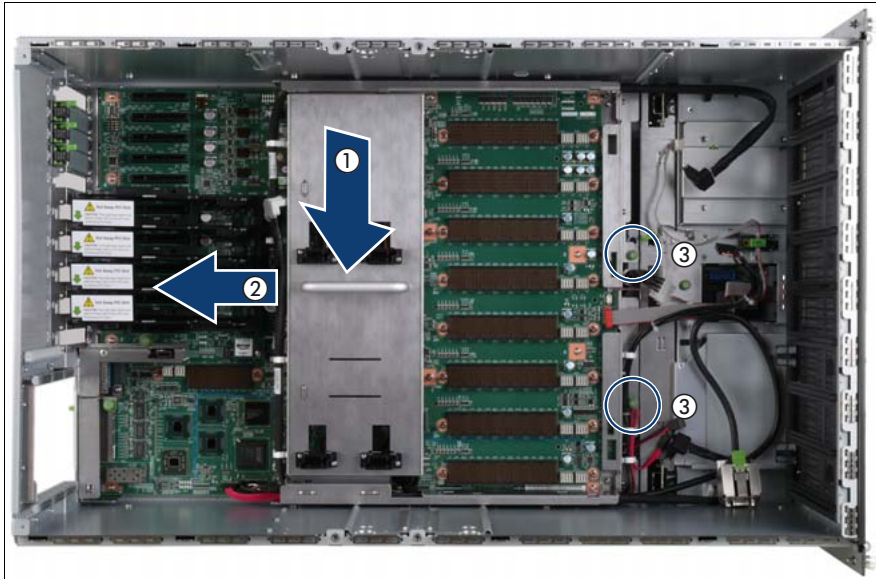

Figure 216: Inserting the baseboard

- ▶ Carefully lower the baseboard in the chassis by using the handle (1).
- ▶ Slide the baseboard in the direction of the arrow (2) until it clicks into place.
- ▶ Fasten the captive screws (3).



**CAUTION!**

Ensure not to damage the EMI springs to comply with applicable EMC regulations and satisfy cooling requirements and fire protection measures.

### 15.4.14 Installing the air guide

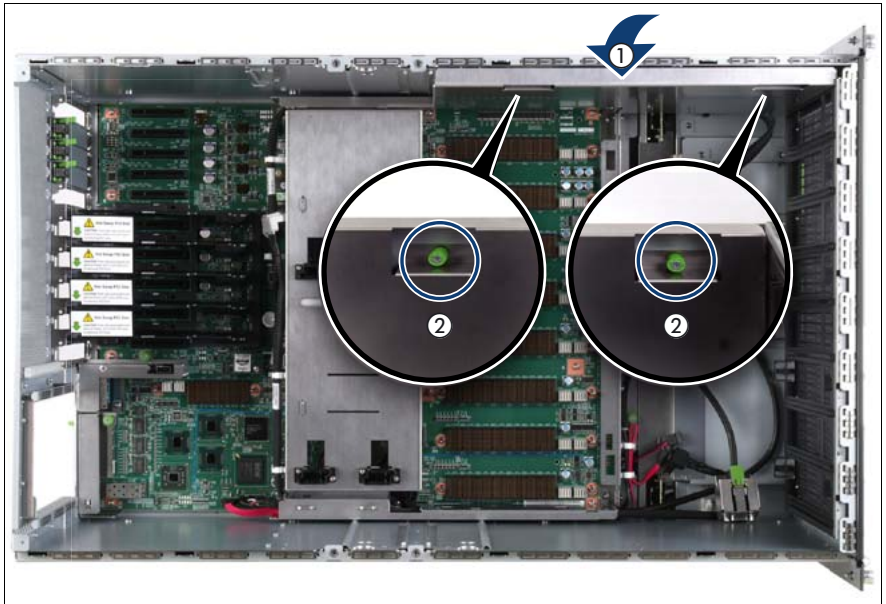

Figure 217: Installing the air guide

- ▶ Place the air guide in the chassis (1).
- ▶ Fasten the captive screws (2).

### 15.4.15 Inserting the CPUMEMR guide

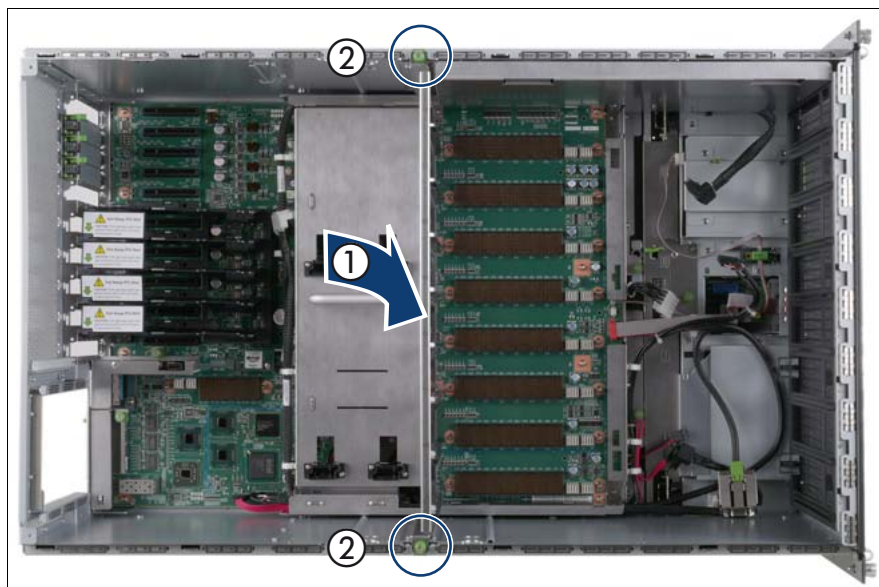

Figure 218: Inserting the CPUMEMR guide

- ▶ Insert the CPUMEMR guide in the installation slot (1).
- ▶ Fasten the captive screws of the CPUMEMR guide (2).

## 15.4.16 Inserting the fan cage

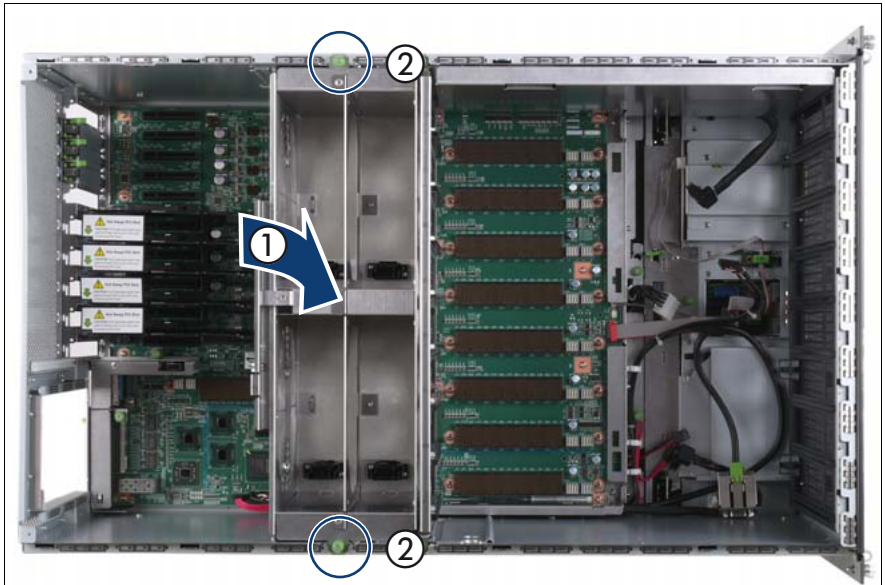

Figure 219: Inserting the fan cage

- ▶ Insert the fan cage in the mounting bay (1).
- ▶ Fasten the captive screws (2).

## 15.4.17 Connecting the cables to the baseboard

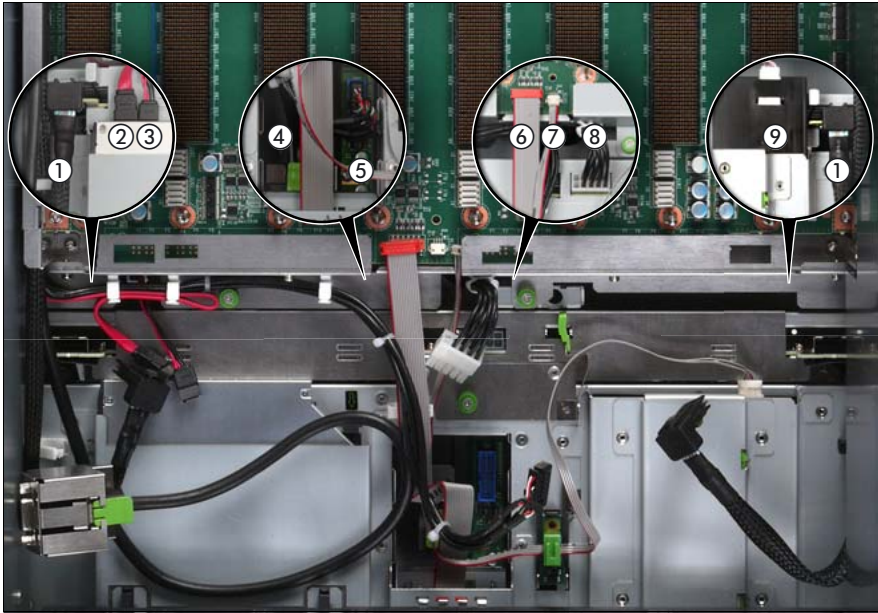

Figure 220: Connecting the cables to the baseboard

- ▶ Connect the following cables to the baseboard:
  - SAS backplane cable (1)
  - Signalling cable (2) and power cable (3) to the optical drive
  - Front video connector cable (4)
  - Front USB cable (5)
  - Control panel cable (6)
  - Chassis ID cable (7)
  - Power cable to the SAS backplane (8)

For the cable plan see ["Cabling" on page 367](#).



### 15.4.18 Sliding the local service display inward

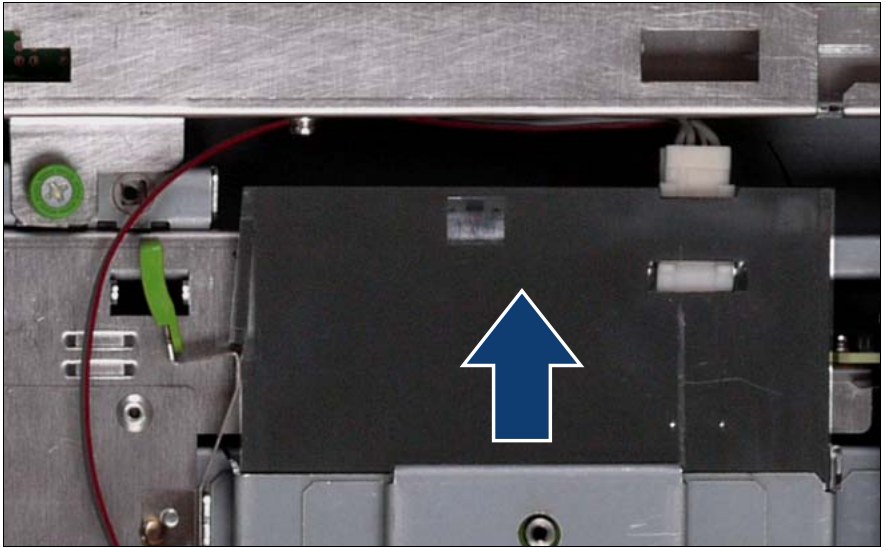

Figure 221: Sliding the local service display inward

- ▶ Slide the local service display inward until it clicks into place.

### 15.4.19 Completing the task

- ▶ Perform the following procedures to complete the task:
  1. Install the BBU holder, see ["Expansion cards and BBU" on page 105](#)
  2. Install the PCI Riser, see ["Expansion cards and BBU" on page 105](#)
  3. Install all expansion cards and dummy modules in PCIe slots #8 to #17, see ["Expansion cards and BBU" on page 105](#)
    - i** Make sure that you reinstall each card in the slots it was located before the replacement.
  4. Install all CPUMEMRs, see ["Removing the CPUMEMR" on page 190](#)
    - i** Make sure that you reinstall each CPUMEMR in the slot it was located before the replacement.
  5. Install all PSUs, see ["Installing a power supply unit" on page 55](#)

## Cables

---

6. ["Closing the server" on page 47](#)
  7. ["Mounting the server in the rack" on page 49](#)
  8. ["Bringing the server back to operation" on page 51](#)
  9. ["Closing the rack door" on page 51](#)
- ▶ Verify the settings on the baseboard, see the "Baseboard D3081, CPUMEMR D3131, PCIR D3082 for PRIMERGY RX900 S1 Technical Manual" for a detailed description.



## 15.5 Replacing the SAS cable, the SATA cable, the front video connector cable, or the front USB cable



### Authorized personnel

Authorized specialist personnel can carry out replacement tasks for integral server components. Ask you local Fujitsu service center for more detailed information.



### CAUTION!

Procedures indicated as "Authorized personnel only" must be done by Fujitsu service personnel or technicians trained by Fujitsu for doing these tasks. Please note that unauthorized interference with the system will void the warranty and exempt the manufacturer from all liability.





The baseboard is optionally equipped with a Trusted Platform Module (TPM). This module enables programs from third party manufacturers to store key information, for example drive encryption using Windows Bitlocker Drive Encryption.

The TPM is activated via the BIOS system, see BIOS manual for the D3081 system.

### 15.5.1 Required tools

- Starting and completing the task:
  - key for the rack doors (if applicable)
  - Phillips Ph2 screw driver
- Replacing the SAS cable, the SATA cable, the front video connector cable, or the front USB cable:
  - Phillips Ph0 screw driver
  - Phillips Ph2 screw driver

### 15.5.2 Starting the task

- ▶ Perform the following procedures:
  1. ["Opening the rack door" on page 40](#)
  2. ["Locate the faulty server" on page 37](#)
  3. ["Shutting down the server" on page 41](#)
  4. ["Sliding the server out of the rack" on page 42](#)
  5. ["Opening the server" on page 44](#)
  6. Remove all PSUs, see ["Removing the power supply unit" on page 58](#)
  7. Remove all CPUMEMRs, see ["Removing the CPUMEMR" on page 190](#)
    -  Before removing the CPUMEMRs, take a note on the installation slot number for each CPUMEMR. Make sure that you reinstall the CPUMEMR in the slot it was located before the replacement.
  8. Remove all expansion cards and dummy modules in PCIe slots #8 to #17, see ["Expansion cards and BBU" on page 105](#)
    -  Before removing the expansion cards, take a note on the installation slot number for each card. Make sure that you reinstall the card in the slot it was located before the replacement.
  9. Remove the PCI Riser, see ["Expansion cards and BBU" on page 105](#)
  10. Remove the BBU holder, see ["Expansion cards and BBU" on page 105](#)

### 15.5.3 Sliding the local service display outward

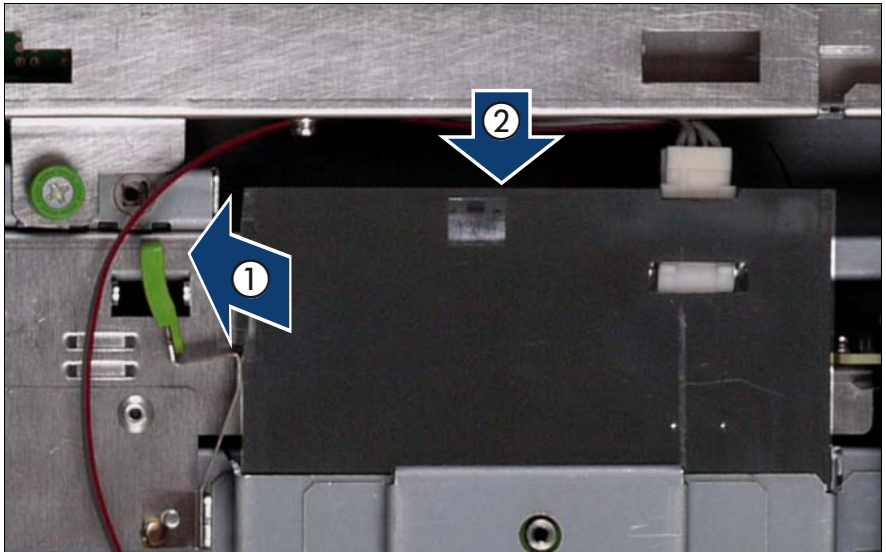

Figure 222: Sliding the local service display outward

- ▶ Unlock the local service display (1).
- ▶ Slide the local service display outward a few centimeters so that you have free access (2).

## 15.5.4 Disconnecting the cables

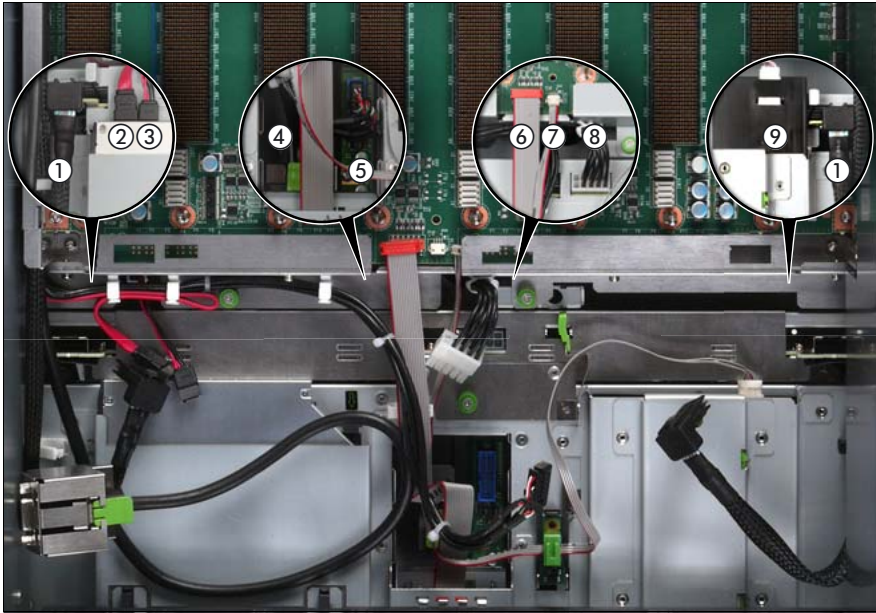

Figure 223: Disconnecting the cables from the baseboard

- ▶ Disconnect the following cables from the baseboard:
  - SAS backplane cable (1)
  - Signalling cable (2) and power cable (3) to the optical drive
  - Front video connector cable (4)
  - Front USB cable (5)
  - Control panel cable (6)
  - Chassis ID cable (7)
  - Power cable for the SAS backplane (8)

For the cable plan see ["Cabling" on page 367](#).

## 15.5.5 Removing the fan cage

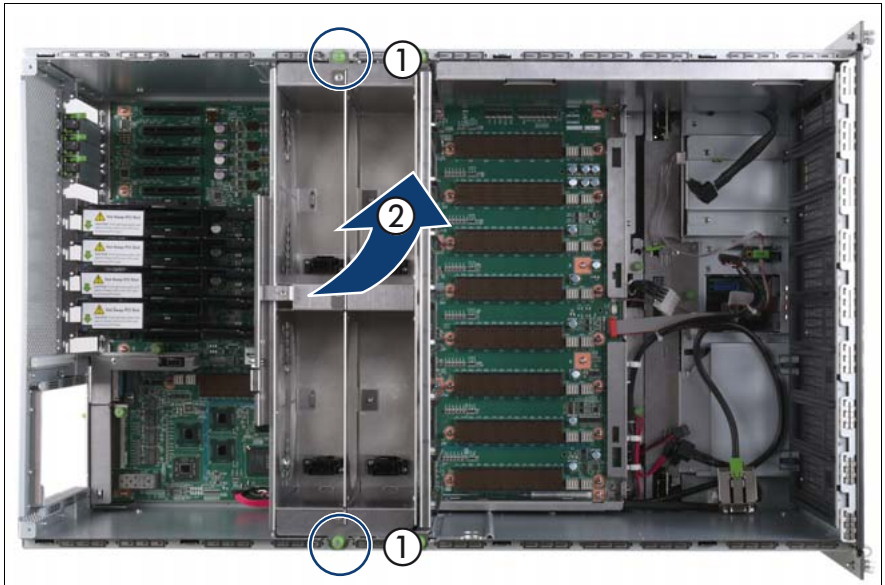

Figure 224: Removing the fan cage

- ▶ Loosen the captive screws (1).
- ▶ Lift the fan cage out of the chassis (2).

### 15.5.6 Removing the CPUMEMR guide

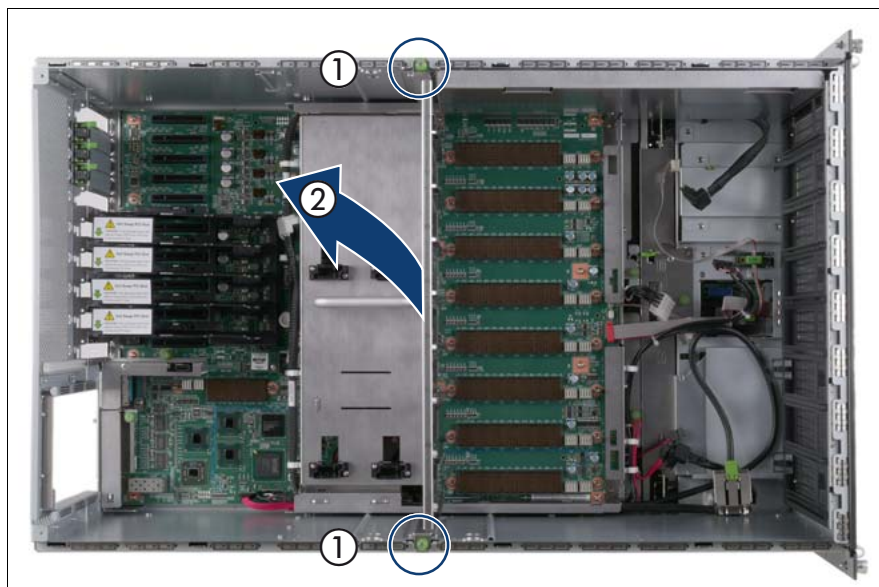

Figure 225: Removing the CPUMEMR guide

- ▶ Loosen the captive screws of the CPUMEMR guide (1).
- ▶ Lift the CPUMEMR guide out of the chassis (2).

## 15.5.7 Removing the air guide

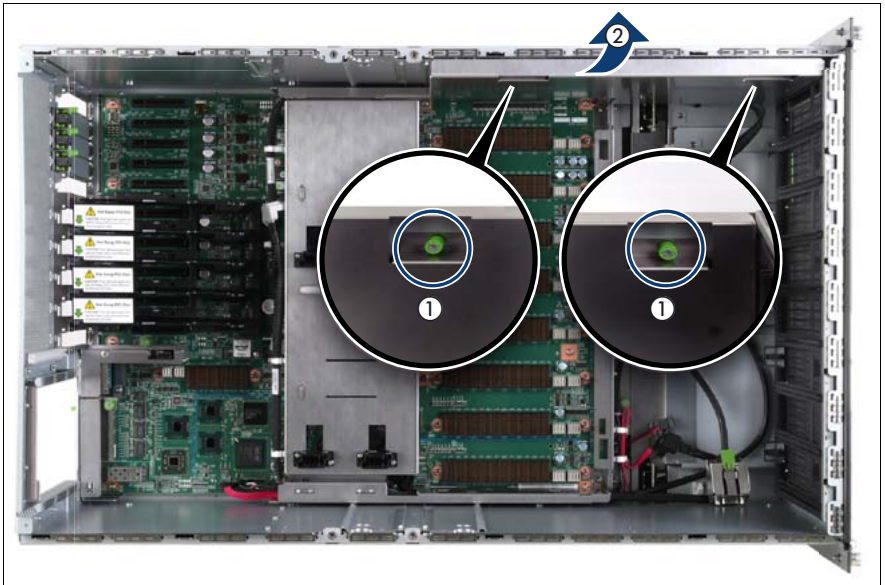

Figure 226: Removing the air guide

- ▶ Loosen the captive screws (1).
- ▶ Lift the air guide out of the chassis (2).



## 15.5.8 Removing the baseboard

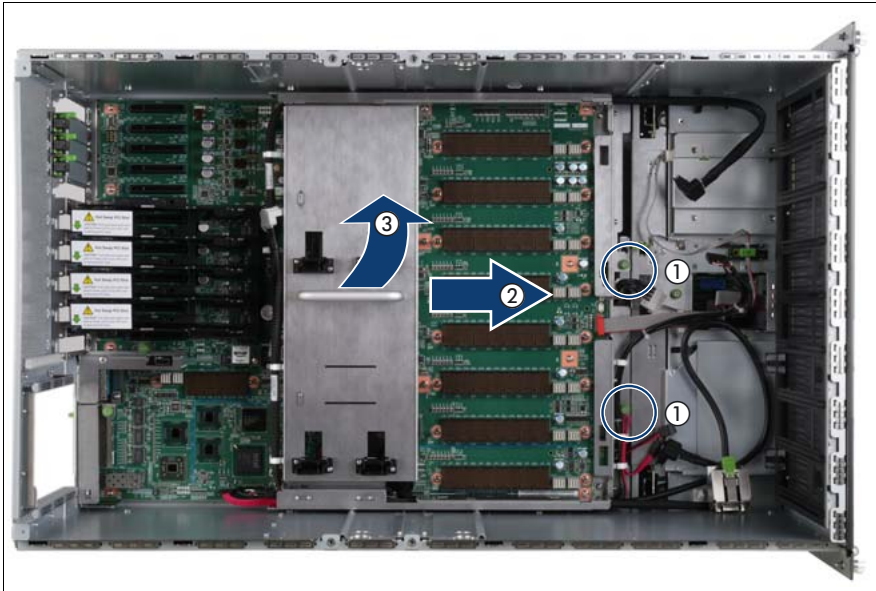

Figure 227: Removing the baseboard

- ▶ Loosen the captive screws (1).
- ▶ Slide the baseboard approximately 1 cm in the direction of the arrow (2).



### CAUTION!

Make sure that you have removed all power supply units before removing the baseboard. Otherwise, the power supply units or the power distribution board might be damaged.

- ▶ Carefully lift the baseboard out of the chassis by using the handle (3).



## 15.5.9 Opening the cable guides

For the SAS cable, the SATA cable, the front video connector cable, or the front USB cable

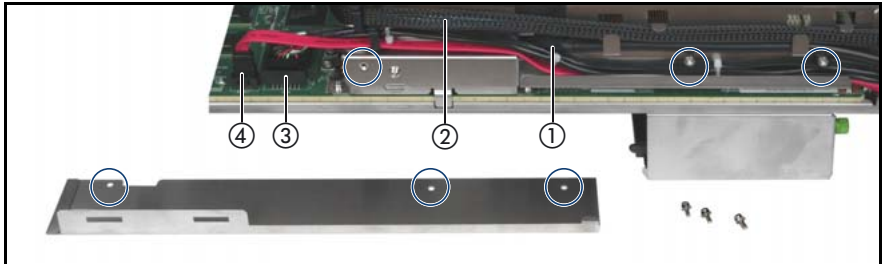

Figure 228: Opening the front connectors cable guide

- ▶ Remove the screws (see circles).
- ▶ Open the cable guide.
- ▶ Select the cable to be removed:
  - Front USB cable (1)
  - SAS backplane cable (2)
  - Front video connector cable (3)
  - Signalling cable to the optical drive (4)
- ▶ Open the corresponding cable clamps and remove the defective cable(s).

### For the SAS cable

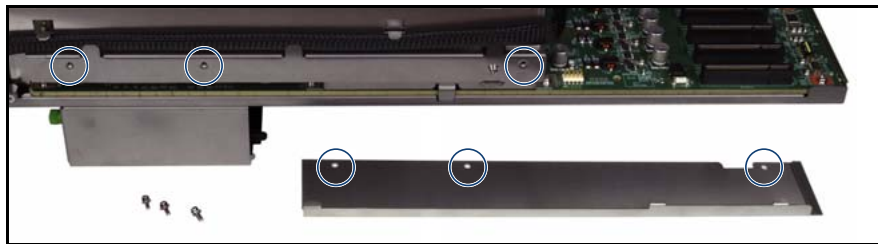

Figure 229: Opening the SAS cable guide

- ▶ Remove the screws (see circles).
- ▶ Open the cable guide.
- ▶ Open the cable clamps and remove the defective SAS cable.

### 15.5.10 Closing the cable guides

For the SAS cable, the SATA cable, the front video connector cable, or the front USB cable

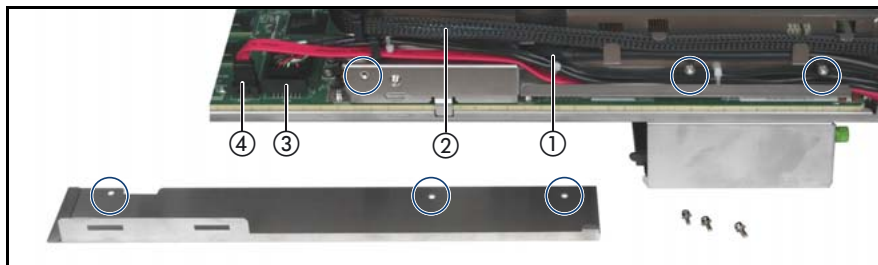

Figure 230: Closing the front connectors cable guide

- ▶ Insert the new cable(s) and close the corresponding cable clamps.
- ▶ Close the cable guide and fasten the screws (see circles).

### For the SAS cable

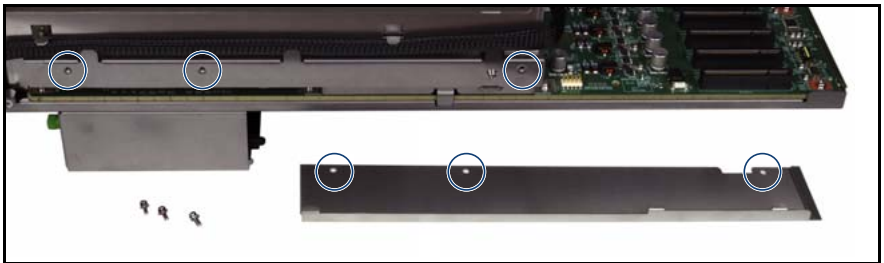

Figure 231: Closing the SAS cable guide

- ▶ Insert the new cable and close the cable clamps.
- ▶ Close the cable guide and fasten the screws (see circles).

## 15.5.11 Inserting the baseboard

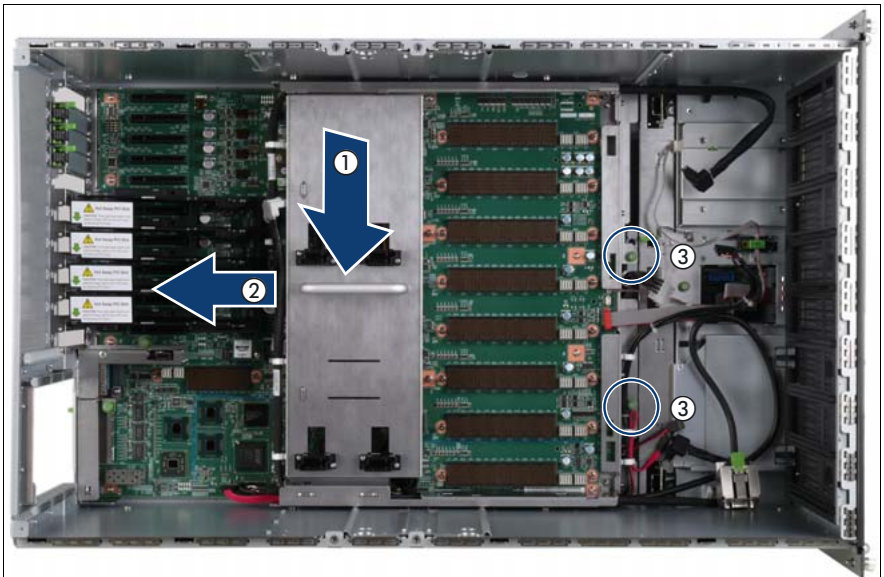

Figure 232: Inserting the baseboard

## Cables

- ▶ Carefully lower the baseboard in the chassis by using the handle (1).
- ▶ Slide the baseboard in the direction of the arrow (2) until it clicks into place.
- ▶ Fasten the captive screws (3).



### CAUTION!

Ensure not to damage the EMI springs to comply with applicable EMC regulations and satisfy cooling requirements and fire protection measures.

## 15.5.12 Installing the air guide

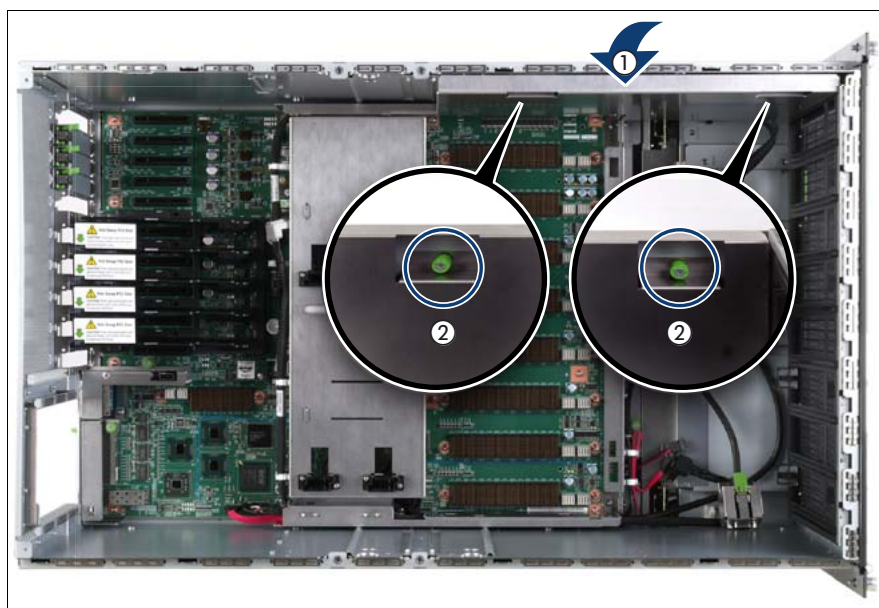

Figure 233: Installing the air guide

- ▶ Place the air guide in the chassis (1).
- ▶ Fasten the captive screws (2).

### 15.5.13 Inserting the CPUMEMR guide

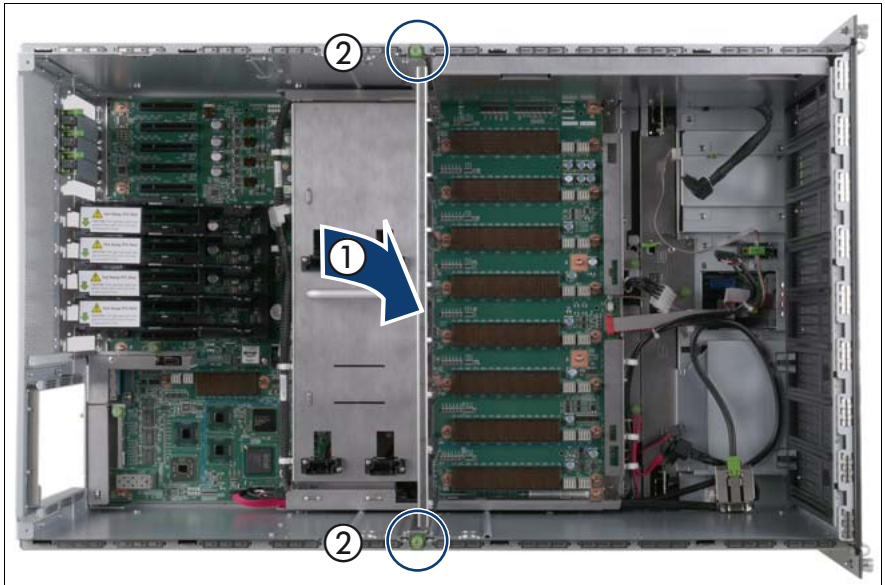

Figure 234: Inserting the CPUMEMR guide

- ▶ Insert the CPUMEMR guide in the installation slot (1).
- ▶ Fasten the captive screws of the CPUMEMR guide (2).

### 15.5.14 Inserting the fan cage

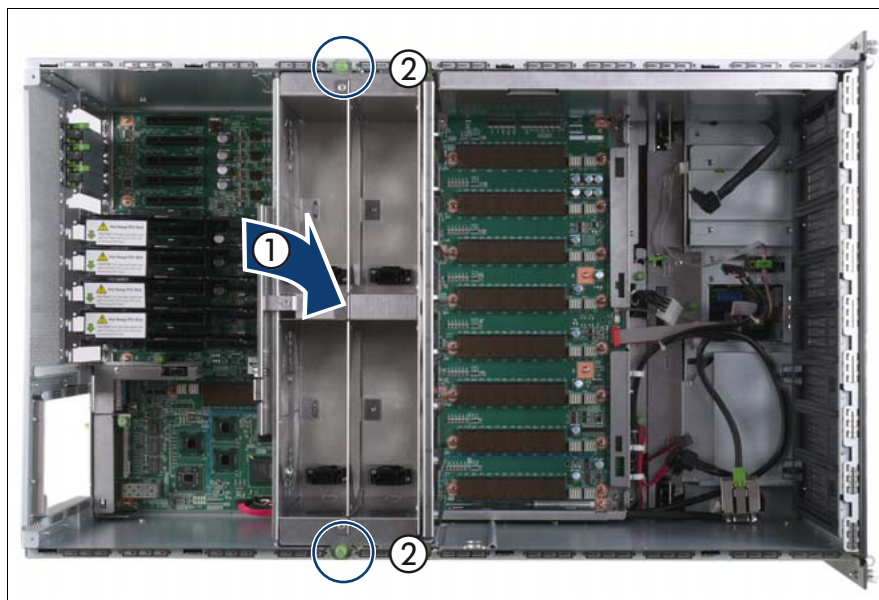

Figure 235: Inserting the fan cage

- ▶ Insert the fan cage in the mounting bay (1).
- ▶ Fasten the captive screws (2).

## 15.5.15 Connecting the cables to the baseboard

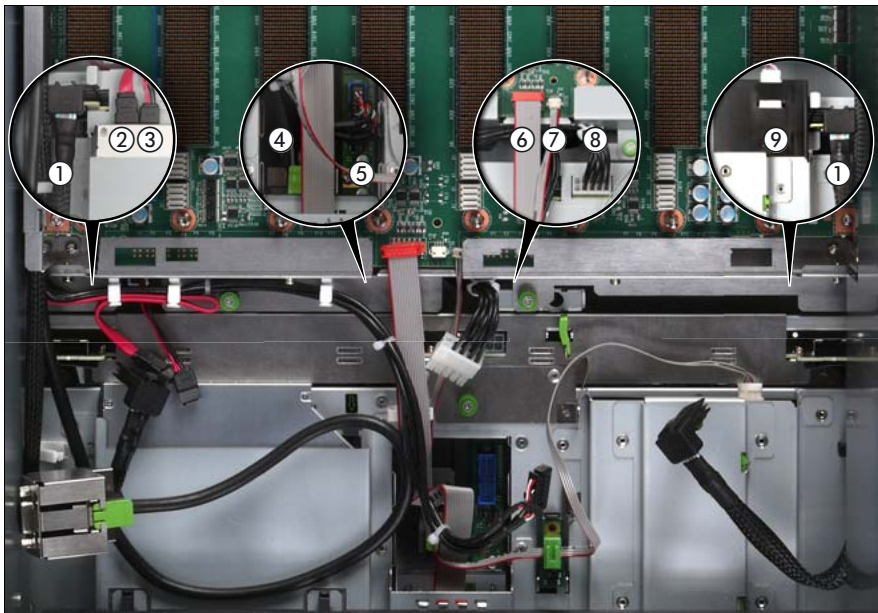

Figure 236: Connecting the cables to the baseboard

- ▶ Connect the following cables to the baseboard:
  - SAS backplane cable (1)
  - Signalling cable (2) and power cable (3) to the optical drive
  - Front video connector cable (4)
  - Front USB cable (5)
  - Control panel cable (6)
  - Chassis ID cable (7)
  - Power cable to the SAS backplane (8)

For the cable plan see "[Cabling](#)" on page 367.



### 15.5.16 Sliding the local service display inward

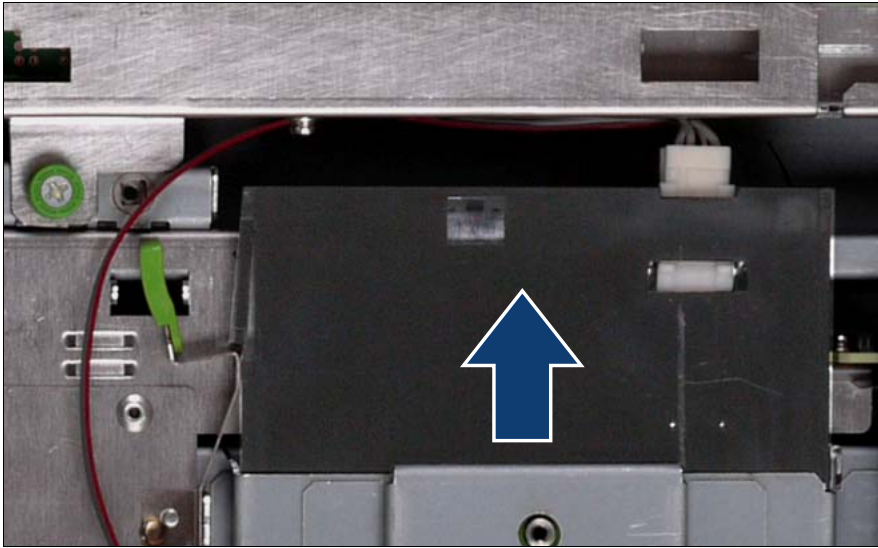

Figure 237: Sliding the local service display inward

- ▶ Slide the local service display inward until it clicks into place.

### 15.5.17 Completing the task

- ▶ Perform the following procedures to complete the task:
  1. Install the BBU holder, see ["Expansion cards and BBU" on page 105](#)
  2. Install the PCI Riser, see ["Expansion cards and BBU" on page 105](#)
  3. Install all expansion cards and dummy modules in PCIe slots #8 to #17, see ["Expansion cards and BBU" on page 105](#)
    - i** Make sure that you reinstall each card in the slots it was located before the replacement.
  4. Install all CPUMEMRs, see ["Removing the CPUMEMR" on page 190](#)
    - i** Make sure that you reinstall each CPUMEMR in the slot it was located before the replacement.
  5. Install all PSUs, see ["Installing a power supply unit" on page 55](#)



6. ["Closing the server" on page 47](#)
  7. ["Mounting the server in the rack" on page 49](#)
  8. ["Bringing the server back to operation" on page 51](#)
  9. ["Closing the rack door" on page 51](#)
- ▶ Verify the settings on the baseboard, see the "Baseboard D3081, CPUMEMR D3131, PCIR D3082 for PRIMERGY RX900 S1 Technical Manual" for a detailed description.



# 16 Appendix

## 16.1 Mechanical overview

### 16.1.1 Front side

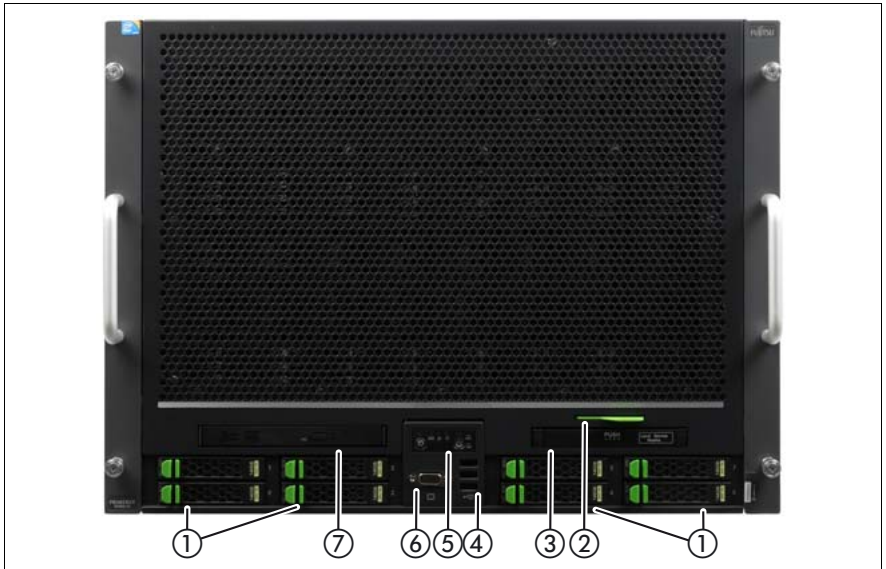

Figure 238: RX900 S1 front side

Pos.	Component	Pos.	Component
1	Hard disk drives / dummy modules #0 - #7, see <a href="#">figure 239</a>	5	Control panel
2	ID card	6	Video connector
3	Local service display	7	Optical drive
4	3x USB connectors		

For detailed information on connectors see "PRIMERGY RX900 S1 Server - Operating manual".



Figure 239: HDD/SSD bay numbering scheme

### 16.1.2 Rear side

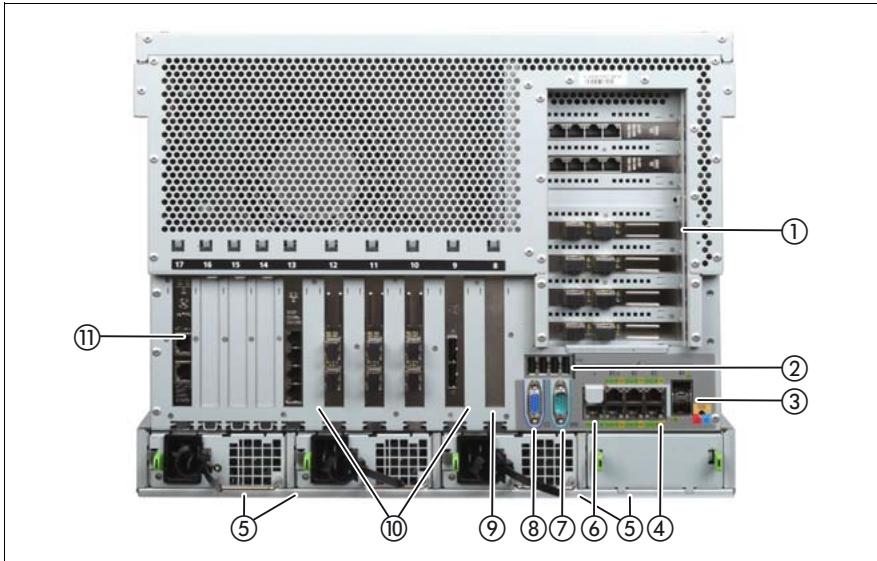

Figure 240: RX900 S1 rear side

Pos.	Component	Pos.	Component
1	PCI Riser (PCIR); PCIe slots #1 - #7, see <a href="#">figure 244</a>	7	Serial connector
2	4x USB connectors	8	Video connector
3	2x 10 Gbit/s LAN connectors	9	Modular RAID controller (PCIe slot #8), see <a href="#">figure 244</a>
4	6x 1 Gbit/s LAN connectors	10	Hot-plug PCIe slots #9 - #12, see <a href="#">figure 244</a>

Pos.	Component	Pos.	Component
5	Power Supply Units (PSU) #1 - #4, see <a href="#">figure 241</a>	11	PCIe slots #13 - #17, see <a href="#">figure 244</a>
6	Management LAN connector		

For detailed information on connectors see "PRIMERGY RX900 S1 Server - Operating manual".

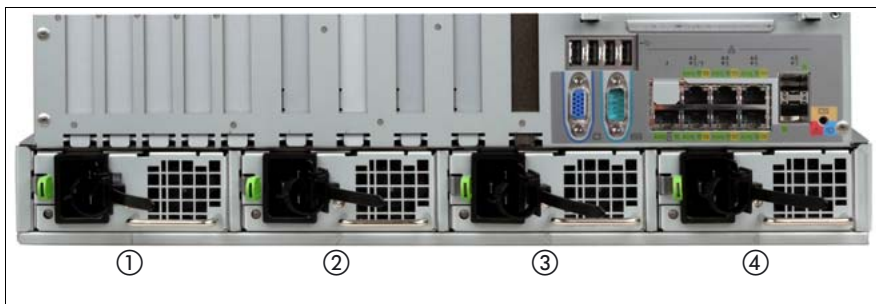

Figure 241: Power supply unit numbering scheme

### 16.1.3 Top view

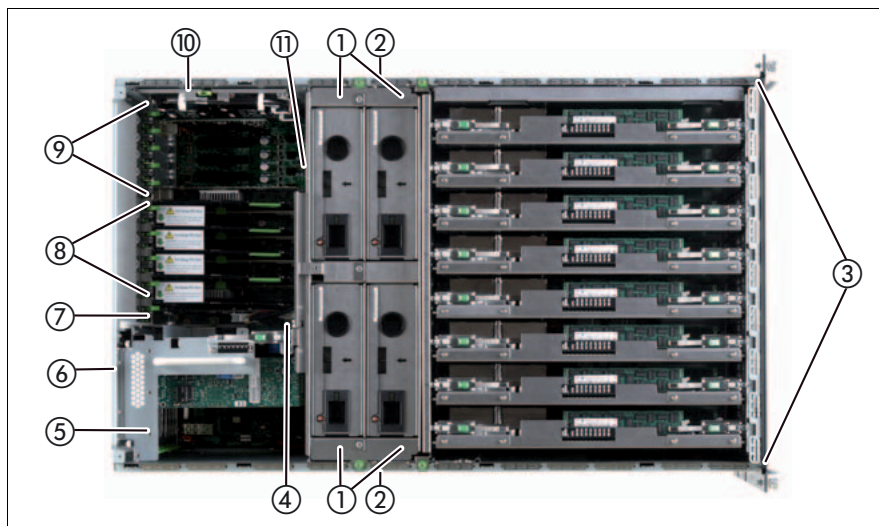

Figure 242: Top view

Pos.	Component	Pos.	Component
1	Fan #1 - #4, see <a href="#">figure 243</a>	7	Modular RAID controller (PCIe slot #8), see <a href="#">figure 244</a>
2	IOH #1 - #4 (underneath the fan)	8	Hot-plug PCIe slots #9 - #12 (from bottom to top), see <a href="#">figure 244</a>
3	CPUMEMRs #1 - #8 (from bottom to top), see <a href="#">figure 245</a> and <a href="#">figure 246</a>	9	Non-hot-plug PCIe slots #13 - #17 (from bottom to top), see <a href="#">figure 244</a>
4	TPM connector	10	2 BBUs for SAS RAID controllers
5	PCIR with non-hot-plug PCIe slots #1 - #7 (from bottom to top), see <a href="#">figure 244</a>	11	UFM connector
6	I/O board (underneath the PCIR)		

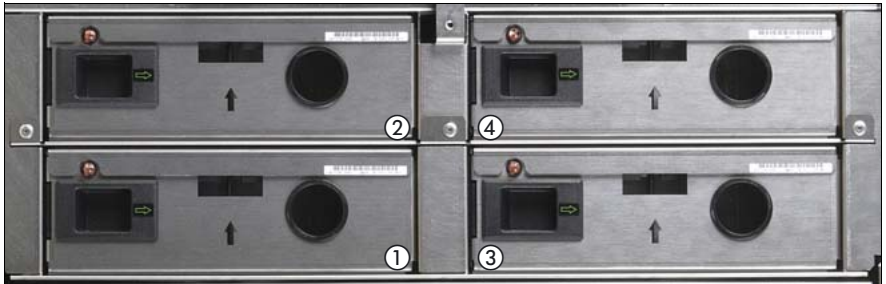

Figure 243: Fan numbering scheme

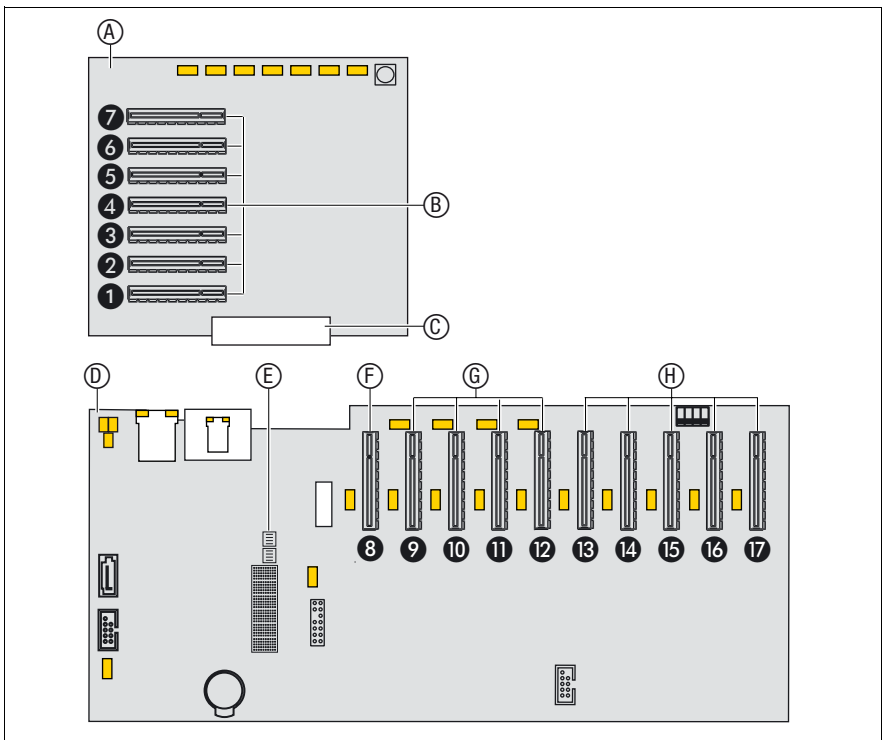

Figure 244: PCIe slot assignment

Figure 244 shows the PCIe slot configuration. Expansion cards can be installed in the PCIe slots on the PCI Riser (A) and on the baseboard (D). The PCI Riser is connected to the baseboard via the connectors C and E.

## Appendix

---

The PCIe slots are assigned as follows:

- **B:** non-hot plug PCIe slots on the PCI Riser
- **F:** non-hot plug PCIe slot for the Modular Raid controller only
- **G:** hot-plug PCIe slots
- **H:** non-hot plug PCIe slots on the baseboard



Figure 245: CPUMEMR numbering scheme



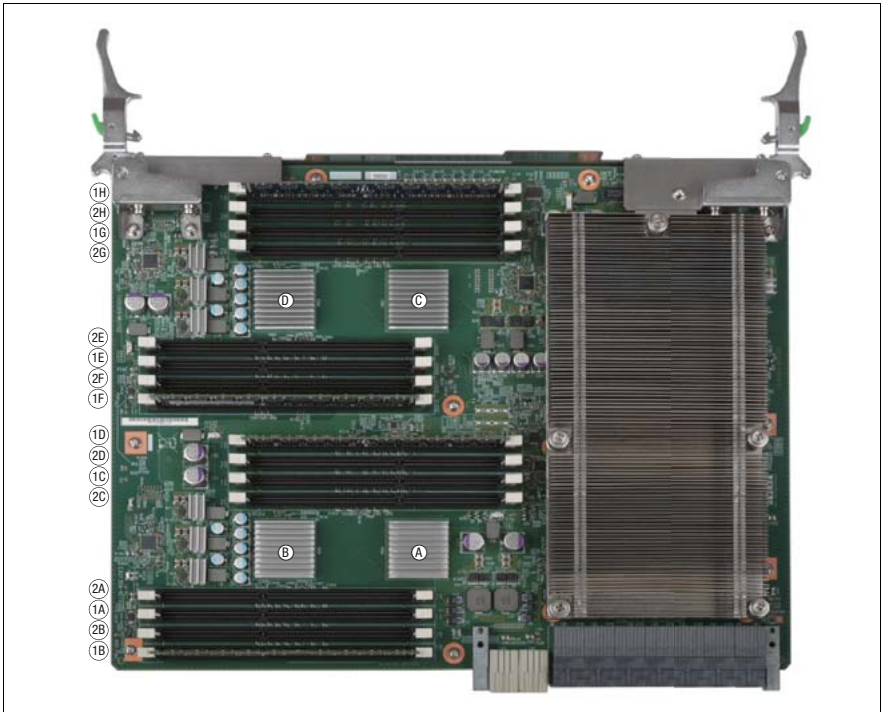

Figure 246: DIMM slot numbering scheme

## 16.2 Mounting order for SSD and HDD modules

Basic rules for the mounting order of solid state drives and hard disk drives:

1. If solid state drives and hard disk drives are to be installed, the solid state drives are installed first.
2. Solid state drives with different capacities are installed from highest to lowest capacity.
3. Hard disk drives with different capacities are installed from highest to lowest capacity.
4. Hard disk drives with different rotation speeds are installed from highest to lowest speed.
5. If drives using SAS bus technology and drives using SATA bus technology are to be installed, drives using SAS bus technology are installed first.
6. HDD/SSD modules are installed as indicated in [figure 247](#). Begin with HDD/SSD bay #0 in the left down corner.
7. Install dummy modules into unpopulated HDD/SSD bays.



Figure 247: Mounting order for HDD/SSD bays

## 16.3 Memory board configuration

Basic rules for the population order of DIMM memory modules:

- DIMM memory modules with different capacities are installed from highest to lowest capacity.
- Subdivide the total number of DIMM memory modules such that the same multiple of four modules is placed on each CPUMEMR.
- If there are DIMM memory modules left after each CPUMEMR has the same multiple of four DIMM memory modules, insert four DIMM memory modules on each CPUMEMRs, starting with CPUMEMR#1, until all DIMM memory modules are installed.
- Avoid mixing of DIMM memory modules from different supplies as much as possible. Use at least DIMM memory modules of the same supplier in the upper part (slot 1F to 2H) and the lower part (slot 1A to 2D) of an individual CPUMEMR.



Only use identical DIMM memory modules in the minimum configuration.

Table 5 shows the DIMM slot population order and the mapping of DIMM slots to CPUs and IOHs for 4, 6, and 8 CPUMEMRs.

CPU No.	DIMM slot pop. order	4 CPUMEMRs				6 CPUMEMRs				8 CPUMEMRs				IOH No.
		1B 1D 1F 1H	1A 1C 1E 1G	2B 2D 2F 2H	2A 2C 2E 2G	1B 1D 1F 1H	1A 1C 1E 1G	2B 2D 2F 2H	2A 2C 2E 2G	1B 1D 1F 1H	1A 1C 1E 1G	2B 2D 2F 2H	2A 2C 2E 2G	
CPU#1	1	x	--	--	--	x	--	--	--	x	--	--	--	#1
	2	x	x	--	--	x	x	--	--	x	x	--	--	
	3	x	x	x	--	x	x	x	--	x	x	x	--	
	4	x	x	x	x	x	x	x	x	x	x	x	x	
CPU#2	1	x	--	--	--	x	--	--	--	x	--	--	--	#1
	2	x	x	--	--	x	x	--	--	x	x	--	--	
	3	x	x	x	--	x	x	x	--	x	x	x	--	
	4	x	x	x	x	x	x	x	x	x	x	x	x	

Table 5: DIMM slot population order and mapping of DIMM slots to I/O Hubs and CPUs

## Appendix

CPU No.	DIMM slot pop. order	4 CPUMEMRs				6 CPUMEMRs				8 CPUMEMRs				IOH No.
		1B 1D 1F 1H	1A 1C 1E 1G	2B 2D 2F 2H	2A 2C 2E 2G	1B 1D 1F 1H	1A 1C 1E 1G	2B 2D 2F 2H	2A 2C 2E 2G	1B 1D 1F 1H	1A 1C 1E 1G	2B 2D 2F 2H	2A 2C 2E 2G	
CPU#3	0	--	--	--	--	--	--	--	--	--	--	--	--	#2
	1	x	--	--	--	x	--	--	--	x	--	--	--	
	2	x	x	--	--	x	x	--	--	x	x	--	--	
	3	x	x	x	--	x	x	x	--	x	x	x	--	
	4	x	x	x	x	x	x	x	x	x	x	x	x	
CPU#4	0	--	--	--	--	--	--	--	--	--	--	--	--	#2
	1	x	--	--	--	x	--	--	--	x	--	--	--	
	2	x	x	--	--	x	x	--	--	x	x	--	--	
	3	x	x	x	--	x	x	x	--	x	x	x	--	
	4	x	x	x	x	x	x	x	x	x	x	x	x	
CPU#5	0	--	--	--	--	--	--	--	--	--	--	--	--	#3
	1	--	--	--	--	x	--	--	--	x	--	--	--	
	2	--	--	--	--	x	x	--	--	x	x	--	--	
	3	--	--	--	--	x	x	x	--	x	x	x	--	
	4	--	--	--	--	x	x	x	x	x	x	x	x	
CPU#6	0	--	--	--	--	--	--	--	--	--	--	--	--	#3
	1	--	--	--	--	x	--	--	--	x	--	--	--	
	2	--	--	--	--	x	x	--	--	x	x	--	--	
	3	--	--	--	--	x	x	x	--	x	x	x	--	
	4	--	--	--	--	x	x	x	x	x	x	x	x	
CPU#7	0	--	--	--	--	--	--	--	--	--	--	--	--	#4
	1	--	--	--	--	--	--	--	--	x	--	--	--	
	2	--	--	--	--	--	--	--	--	x	x	--	--	
	3	--	--	--	--	--	--	--	--	x	x	x	--	
	4	--	--	--	--	--	--	--	--	x	x	x	x	

Table 5: DIMM slot population order and mapping of DIMM slots to I/O Hubs and CPUs

CPU No.	DIMM slot pop. order	4 CPUMEMRs				6 CPUMEMRs				8 CPUMEMRs				IOH No.
		1B	1A	2B	2A	1B	1A	2B	2A	1B	1A	2B	2A	
		1D	1C	2D	2C	1D	1C	2D	2C	1D	1C	2D	2C	
		1F	1E	2F	2E	1F	1E	2F	2E	1F	1E	2F	2E	
		1H	1G	2H	2G	1H	1G	2H	2G	1H	1G	2H	2G	
CPU#8	0	--	--	--	--	--	--	--	--	--	--	--	--	#4
	1	--	--	--	--	--	--	--	--	X	--	--	--	
	2	--	--	--	--	--	--	--	--	X	X	--	--	
	3	--	--	--	--	--	--	--	--	X	X	X	--	
	4	--	--	--	--	--	--	--	--	X	X	X	X	

Table 5: DIMM slot population order and mapping of DIMM slots to I/O Hubs and CPUs

## 16.4 PCIe slot to CPUMEMR assignment

Figure 248 shows the assignment of PCIe slots to the 4 I/O Hubs and the 4 - 8 CPUMEMRs.

**i** Before adding an expansion card, check carefully whether this PCIe slot is supported with the CPUMEMR configuration of the individual server.

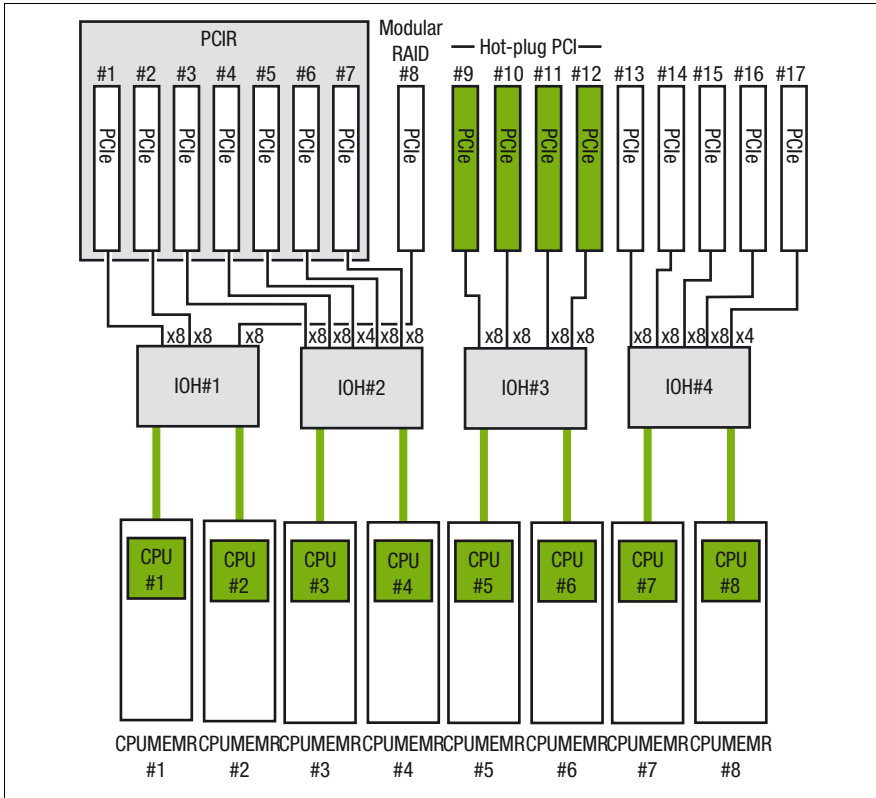

Figure 248: Assignment of PCIe slots to CPUMEMRs

Figure 248 lists the mapping of PCIe slots to I/O Hubs and CPUs.

CPU population order				CPU - IOH mapping		Connected devices	Remark
	4 CPUs	6 CPUs	8 CPUs	CPU No.	IOH No.		
CPU#1	x	x	x	#1 or #2	#1	ICH10	PCIe #5 to BMC
CPU#2	x	x	x			BMC (VGA)	
						GbE#1, GbE#2, GbE#3, 10GbE#1	
						PCIe slot #8	Modular RAID
						PCIe slot #1	PCI Riser
						PCIe slot #2	PCI Riser
CPU#3	x	x	x	#3 or #4	#2	PCIe slot #5	PCI Riser; Gen2x4
CPU#4	x	x	x			PCIe slot #3	PCI Riser
						PCIe slot #4	PCI Riser
						PCIe slot #6	PCI Riser
						PCIe slot #7	PCI Riser
CPU#5		x	x	#5 or #6	#3	PCIe slot #9	hot-plug
CPU#6		x	x			PCIe slot #10	hot-plug
						PCIe slot #11	hot-plug
						PCIe slot #12	hot-plug
CPU#7			x	#7 or #8	#4	PCIe slot #17	Gen2x4
CPU#8			x			PCIe slot #13	
						PCIe slot #14	
						PCIe slot #15	
				PCIe slot #16			

Table 6: Mapping of PCIe slots to I/O Hubs and CPUs

## 16.5 Expansion card configuration table

Expansion cards require I/O space for Legacy Booting and for OS running. Due to the limitation of I/O space, see "Baseboard D3081, CPUMEMR D3131, PCIR D3082 for PRIMERGY RX900 S1 Technical Manual", the basic rules for installing expansion cards are:

1. Begin with the installation of the SAS and SAS RAID controllers in order of I/O space assignment order.
2. Continue with the installation of the expansion cards for LAN and FC into the PCIe slots.

Chipset				IOH#1			IOH#2				
Bus scan order				3	2	1	5	6	4	7	8
I/O space assignment order within the I/O Hub (IOH)				1	2	3	4	3		2	1
Hot-plug				n	n	n	n	n	n	n	n
Gen2 width				x8	x8	x8	x8	x8	x4	x8	x8
Slot #				1	2	8	3	4	5	6	7
Vendor	Type	PCIe	Max #								
LSI	SAS 3Gb	Gen1x4	3	x	x		x	x		x	x
	Cougar2	Gen 2x8	1			x					
	SAS RAID (WASAT)	Gen 2x8	2	x (*1)	x (*1)		x (*1)	x (*1)		x (*1)	x (*1)
Emulex	4G-FCx1	Gen 1x8	8	x	x		x	x		x	x
	4G-FCx2	Gen 1x8	8	x	x		x	x		x	x
	8G-FCx1	Gen 2x8	8	x	x		x	x		x	x
	8G-FCx2	Gen 2x8	8	x	x		x	x		x	x
	FCoE	Gen 2x8	8	x	x		x	x		x	x

Table 7: Expansion card installation recommendation I/O Hubs IOH#1 and IOH#2



Chipset				IOH#1			IOH#2				
Bus scan order				3	2	1	5	6	4	7	8
I/O space assignment order within the I/O Hub (IOH)				1	2	3	4	3		2	1
Hot-plug				n	n	n	n	n	n	n	n
Gen2 width				x8	x8	x8	x8	x8	x4	x8	x8
Slot #				1	2	8	3	4	5	6	7
Vendor	Type	PCIe	Max #								
Intel	GbEx1	Gen 1x4	8	x	x		x	x		x	x
	GbEx2	Gen 1x4	8	x	x		x	x		x	x
	GbEx4	Gen 1x4	8	(*2)	(*2)		x	x		x	x
	10GbEx2	Gen 2x8	8	x	x		x	x		x	x

Table 7: Expansion card installation recommendation I/O Hubs IOH#1 and IOH#2

Chipset				IOH#3				IOH#4				
Bus scan order				12	11	10	9	17	16	15	14	13
I/O space assigning order within the I/O Hub (IOH)				1	2			1	2			
Hot-plug				y	y	y	y	n	n	n	n	n
Gen2 width				x8	x8	x8	x8	x8	x8	x8	x8	x4
Slot #				9	10	11	12	13	14	15	16	17
Vendor	Type	PCIe	Max #									
LSI	SAS 3Gb	Gen1x4	3	x	x			x	x			
	Cougar2	Gen 2x8	1									
	SAS RAID (WASAT)	Gen 2x8	2					x	x			

Table 8: Expansion card installation recommendation I/O Hubs IOH#3 and IOH#4

## Appendix

Chipset				IOH#3				IOH#4				
Bus scan order				12	11	10	9	17	16	15	14	13
I/O space assigning order within the I/O Hub (IOH)				1	2			1	2			
Hot-plug				y	y	y	y	n	n	n	n	n
Gen2 width				x8	x8	x8	x8	x8	x8	x8	x8	x4
Slot #				9	10	11	12	13	14	15	16	17
Vendor	Type	PCIe	Max #									
Emulex	4G-FCx1	Gen 1x8	8	x	x	x	x	x	x	x	x	
	4G-FCx2	Gen 1x8	8	x	x	x	x	x	x	x	x	
	8G-FCx1	Gen 2x8	8	2	2	2	2	x	x	x	x	
	8G-FCx2	Gen 2x8	8	2	2	2	2	x	x	x	x	
	FCoE	Gen 2x8	8	2	2	2	2	x	x	x	x	
Intel	GbEx1	Gen 1x4	8	x	x	x	x	x	x	x	x	x
	GbEx2	Gen 1x4	8	x	x	x	x	x	x	x	x	x
	GbEx4	Gen 1x4	8	3	3	3	3	x	x	x	x	
	10GbEx2	Gen 2x8	8	3	3	3	3	x	x	x	x	

Table 8: Expansion card installation recommendation I/O Hubs IOH#3 and IOH#4

\*1) The SAS RAID controller shall not be installed in PCIe slot #1 to #7 on the PCI Riser when a BBU is connected because of limited length of the BBU cable.

\*2) The Quad LAN card consumes twice as much I/O space as a standard expansion card because it includes a bridge within the card. If you install this card into slot#1 or slot#2, no I/O resource will be assigned to the onboard GbE controller.

## 16.6 Cabling

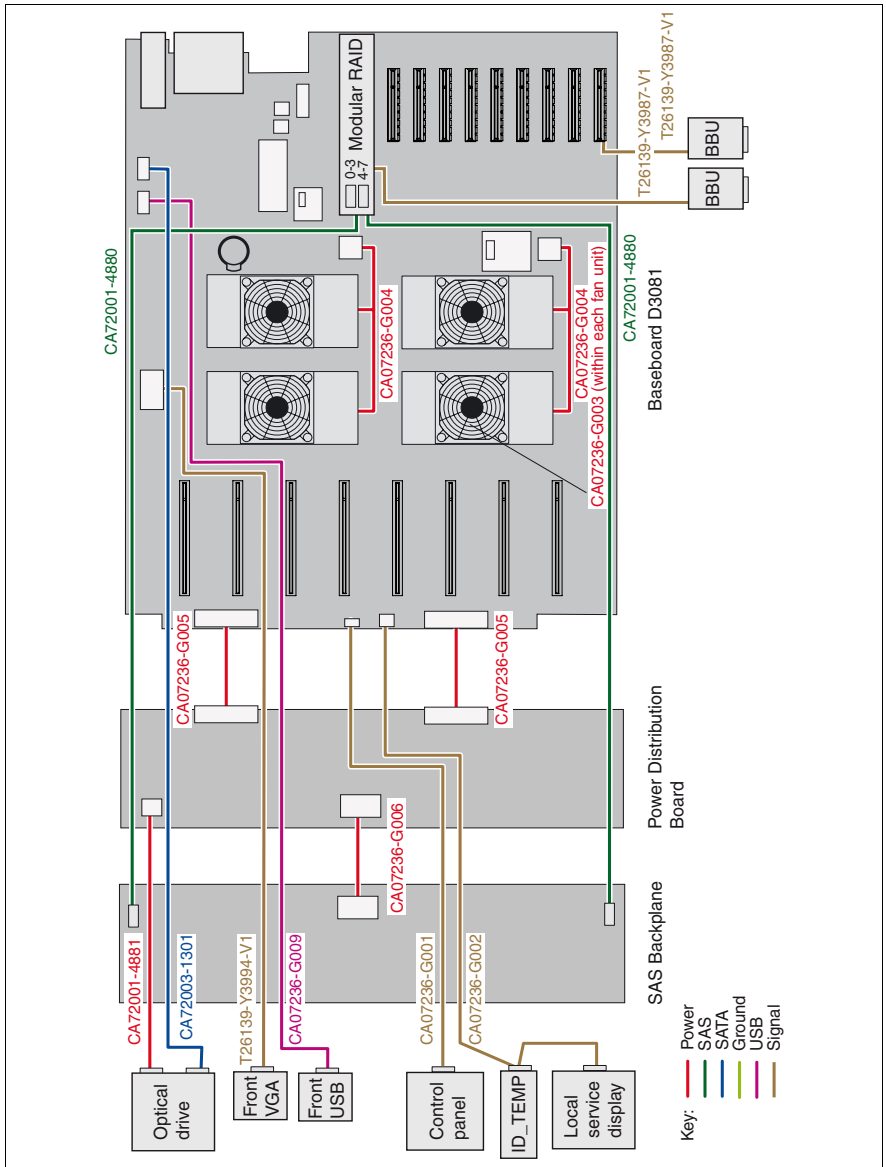

Figure 249: Cabling plan of RX900 S1



## Free Manuals Download Website

<http://myh66.com>

<http://usermanuals.us>

<http://www.somanuals.com>

<http://www.4manuals.cc>

<http://www.manual-lib.com>

<http://www.404manual.com>

<http://www.luxmanual.com>

<http://aubethermostatmanual.com>

Golf course search by state

<http://golfingnear.com>

Email search by domain

<http://emailbydomain.com>

Auto manuals search

<http://auto.somanuals.com>

TV manuals search

<http://tv.somanuals.com>