

Quick Guide

DVD Recorder with Video Cassette Recorder DVR90VG

Playable discs

This unit is compatible to play the following discs.

Disc	Logo	Disc	Logo
DVD-VIDEO		CD-DA (AUDIO CD)	
DVD-RW (VIDEO/VR mode)		CD-RW (CD-DA FORMAT, MP3/WMA files)	
DVD-R (VIDEO mode)		CD-R (CD-DA FORMAT, MP3/WMA files)	

is a trademark of DVD Format/Logo Licensing Corporation.
●DVD+R/+RW discs can be played back only on this unit.

Region codes



The number inside the globe refers to region of the world.
This unit can play DVDs that are labeled for ALL regions or for Region 1.

Recordable discs

This unit can record to DVD-R and DVD-RW discs.
DVD-R discs can only be recorded to once, and cannot be erased. DVD-RW discs can be recorded to and erased many times.
DVD-R discs can only be recorded in Video mode, while DVD-RW discs can select a recording format between Video mode and VR mode.

- We strongly recommend using any DVD-R 8x, MAXELL DVD-R 16x and DVD-RW 4x disc to assure good recording quality.
- Discs that tested and proven to be compatible with this recorder:
VERBATIM DVD-R 8x VERBATIM DVD-RW 2x
MAXELL DVD-R 16x JVC DVD-RW 4x

Disc type	Disc format	Functions	Attributes
 DVD-RW: 1-4x	Video mode 	Playing, limited recording, limited editing	8cm/12cm, single-sided, single layer disc Approx. max. recording time (SEP mode): 600 minutes (4.7GB) (for 12cm) 180 minutes (1.4GB) (for 8cm)
	VR mode 	Playing, recording, Original/Playlist editing	
 DVD-R: 2x.4x.8x	Video mode 	Playing, limited recording, limited editing	8cm/12cm, single-sided, single layer disc Approx. max. recording time (SEP mode): 600 minutes (4.7GB) (for 12cm) 180 minutes (1.4GB) (for 8cm)

1

Connections

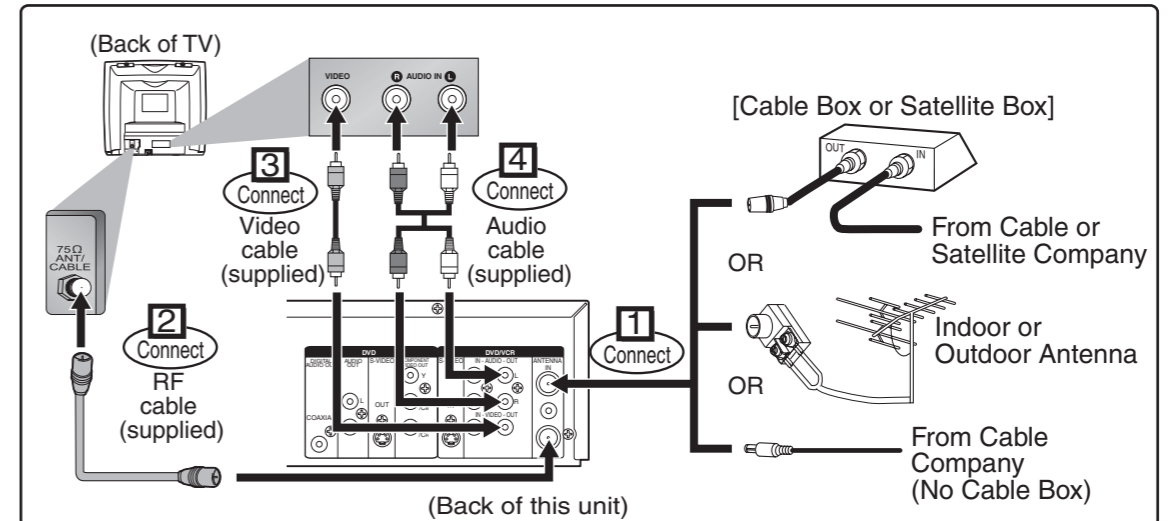

2

Watching TV/DVD

After you have completed connections;

Press the input selector button (usually TV/VIDEO, INPUT or AUX) on your TV to switch an appropriate external input channel (usually near channel 0) for viewing the picture from this unit.
Please refer to "Input Mode Names for Common TV Brands" on page 15 of the Owner's manual or the manual accompanying your TV.

2-1 Initial Setting

1. Turn on the TV and the unit in the first time. "Initial Setting" will appear. Using [▲/▼], select your desired language for the OSD. Then press [ENTER] to go to next step.
2. Press [ENTER] on Channel Preset. The unit will start getting channels available in your area.
3. Clock Setting menu will appear. Press [ENTER] twice, default date will appear.

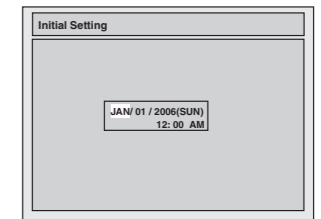
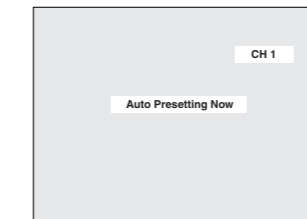
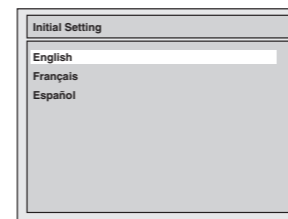

4. Using [▲/▼], enter the date (month / day / year). Press [◀/▶] to move the cursor.
5. Using [▲/▼], enter the time (hour / minute). Press [◀/▶]. A cursor will move on AM.
6. Press [▲/▼] to select "AM" or "PM". Press [ENTER].

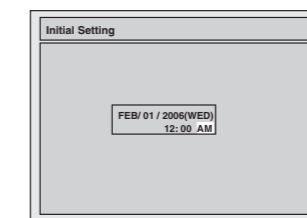
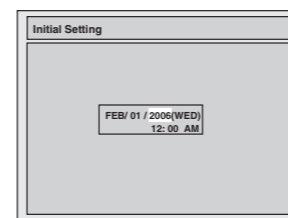

TV Program will automatically appear.
Playing, recording, and editing discs are available on this unit.

2-2 DVD Playback

Press [POWER] to turn the unit on.

Press:

Press [OPEN/CLOSE ▲] to close the disc tray.

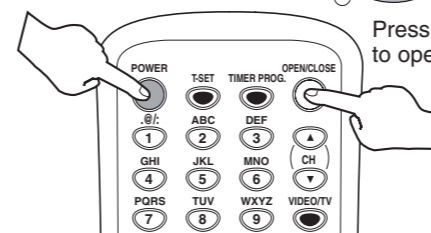

Press [OPEN/CLOSE ▲] to open the disc tray.

Insert a disc.

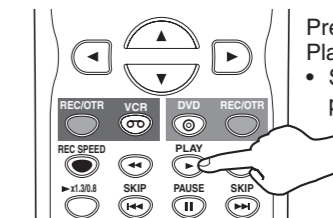
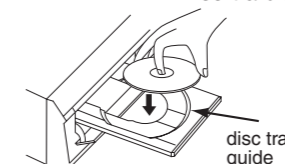

Press [PLAY ▶]. Playback will start.
• Some discs may start playback automatically.

3-1 Easy Recording

First:

Select the recording speed.

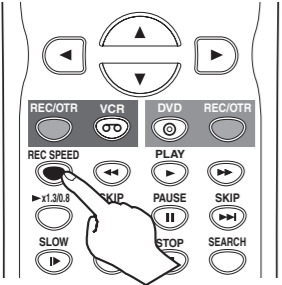

Select the desired channel.

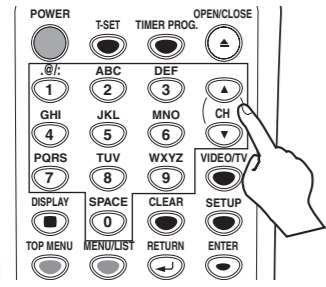

Record on DVD disc.

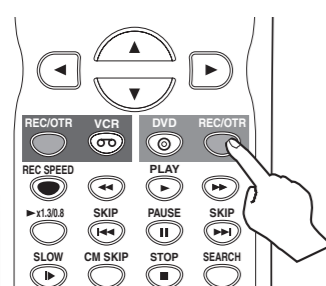

Stop the recording.

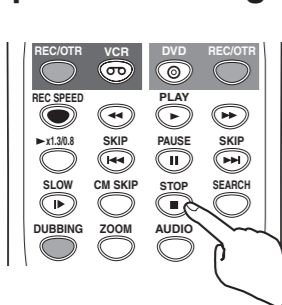

How to select the recording speed:

Disc Size	Recording speed	Recording time	Video/Sound Quality
8cm Disc	XP (1H)	18 min	☆☆☆☆☆☆ (good)
	SP (2H)	36 min	☆☆☆☆☆
	LP (4H)	72 min	☆☆☆☆
	EP (6H)	108 min	☆☆☆
	SLP (8H)	144 min	☆☆
12cm Disc	SEP (10H)	180 min	☆ (poor)
	XP (1H)	60 min	☆☆☆☆☆☆ (good)
	SP (2H)	120 min	☆☆☆☆☆
	LP (4H)	240 min	☆☆☆☆
	EP (6H)	360 min	☆☆☆
	SLP (8H)	480 min	☆☆
	SEP (10H)	600 min	☆ (poor)

Press repeatedly to select desired recording time.

Recording times appear on the TV screen (30 minutes to 8 hours). Recording will start.

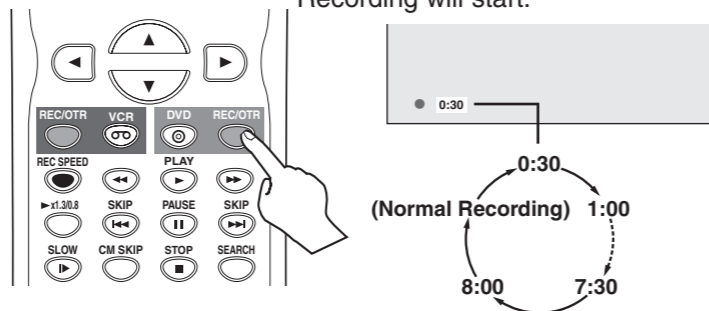

When the unit reaches the specified time, the unit will be turned off automatically.

After all recordings, finalize your disc.

After recording, you must finalize the disc in order to play on other units.

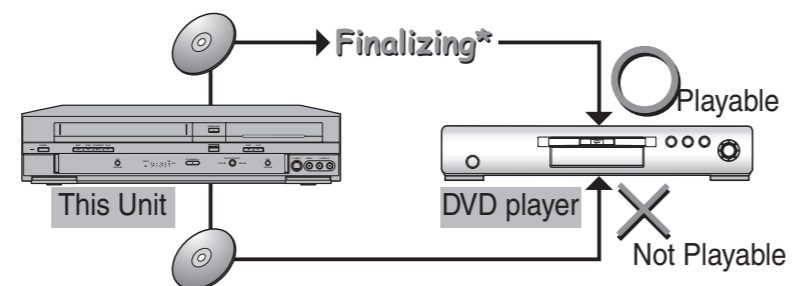

* You cannot finalize discs in other DVD recorders.

3-2 Timer Recording

- You can set up to 8 programs (once, daily or weekly).
- Be sure to set the clock before starting a timer programming.

Press [TIMER PROG.].

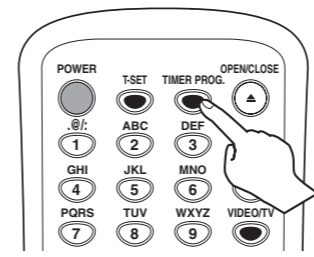

Timer Programming list appears.

Select any blank line with [▲ / ▼] and press [ENTER].

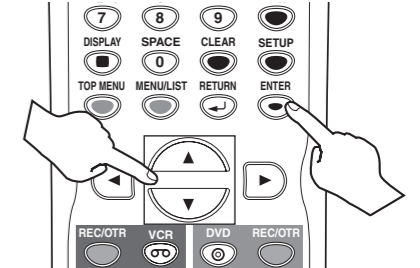
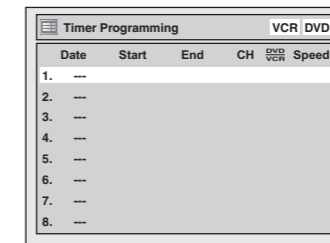

Set the date.

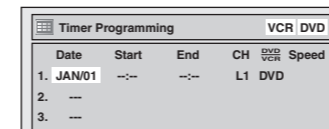

Move to next

Set start and end time.

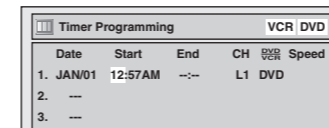

Move to next

Select the channel number to record.

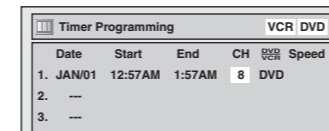

Move to next

Select the media to record.

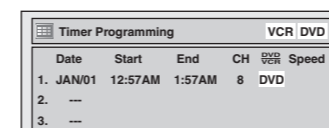

Move to next

Select the recording speed.

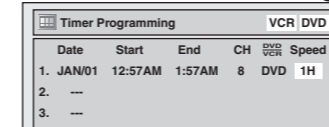

Set the Timer Program.

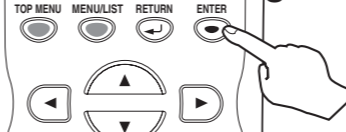

Timer Recording is now set.

When pressing [▼] at the current date, Timer Recording mode will change as follows: e.g. January 1st at present

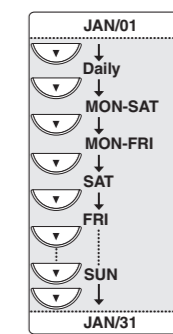

Set the Timer Standby mode
Press [T-SET] to turn the unit off.

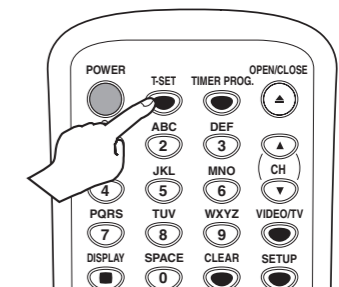

Indicator will appear on the front panel display.



Hints for DVD Recording

- Formatting is not needed when inserting a blank disc. **UNIT AUTOMATICALLY PREPARES THE DISC FOR RECORDING.**
- For playback on other DVD players, be sure to record in Video mode and to finalize the disc once recording is finished. **OTHER PLAYER MUST PLAY BACK DVD-R or DVD-RW.**

Owner's Manual

Recordable disc

- We strongly recommend using any DVD-R 8x, MAXELL DVD-R 16x and DVD-RW 4x disc to assure good recording quality.
- Discs that tested and proven to be compatible with this recorder:
VERBATIM DVD-R 8x VERBATIM DVD-RW 2x
MAXELL DVD-R 16x JVC DVD-RW 4x

DVD Recorder with Video Cassette Recorder

DVR90VG

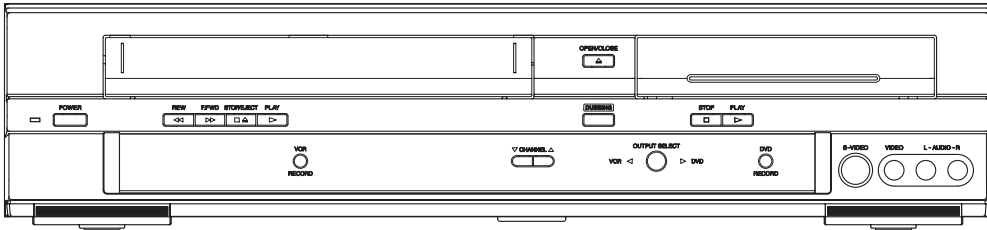

INSTRUCCIONES EN ESPAÑOL INCLUIDAS.

Supplied Accessory

- Remote control (NB197UD) with two AA batteries
- RF cable (WPZ0901TM002)
- Audio/Video cables (WPZ0102TM015 or WPZ0102LTE01)
- Owner's Manual (1VMN22013)
- Quick Use Guide (1VMN22014)

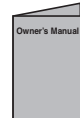
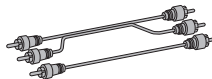
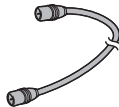
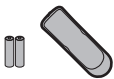

Please read before using this equipment.
If you need additional operating assistance after reading this owner's manual or to order replacement accessories, please call
TOLL FREE : 1-800-605-8453
or visit our web site at <http://www.SylvaniaConsumerElectronics.com>

Before you use this unit, you need to complete connections. Refer to "Connections" on pages 14-16.

To record a program easily, refer to "Easy DVD recording" on pages 17-18 after connections are completed.
(You CANNOT record on any copyright protected DVD disc with this unit.)

Note

- Connect this unit directly to the TV. If the A/V cables are connected to a VCR, pictures may be distorted due to the copy protection system.

Before you start

Precautions

WARNING: TO REDUCE THE RISK OF FIRE OR ELECTRIC SHOCK, DO NOT EXPOSE THIS APPLIANCE TO RAIN OR MOISTURE.



CAUTION
RISK OF ELECTRIC SHOCK
DO NOT OPEN



CAUTION:

TO REDUCE THE RISK OF ELECTRIC SHOCK, DO NOT REMOVE COVER (OR BACK). NO USER SERVICEABLE PARTS INSIDE. REFER SERVICING TO QUALIFIED SERVICE PERSONNEL.



The lightning flash with arrowhead symbol, within an equilateral triangle, is intended to alert the user to the presence of uninsulated "dangerous voltage" within the product's enclosure that may be of sufficient magnitude to constitute a risk of electric shock to persons.



The exclamation point within an equilateral triangle is intended to alert the user to the presence of important operating and maintenance (servicing) instructions in the literature accompanying the appliance.

Laser Safety

This unit employs a laser. Only a qualified service person should remove the cover or attempt to service this device, due to possible eye injury.

CAUTION: USE OF CONTROLS OR ADJUSTMENTS OR PERFORMANCE OF PROCEDURES OTHER THAN THOSE SPECIFIED HEREIN MAY RESULT IN HAZARDOUS RADIATION EXPOSURE.

CAUTION: VISIBLE AND INVISIBLE LASER RADIATION WHEN OPEN AND INTERLOCK DEFEATED. DO NOT STARE INTO BEAM.

LOCATION: INSIDE, NEAR THE DECK MECHANISM.

FCC WARNING- This equipment may generate or use radio frequency energy. Changes or modifications to this equipment may cause harmful interference unless the modifications are expressly approved in the manual. The user could lose the authority to operate this equipment if an unauthorized change or modification is made.

RADIO-TV INTERFERENCE

This equipment has been tested and found to comply with the limits for a Class B digital device, pursuant to Part 15 of the FCC Rules. These limits are designed to provide reasonable protection against harmful interference in a residential installation. This equipment generates, uses, and can radiate radio frequency energy and, if not installed and used in accordance with the instructions, may cause harmful interference to radio communications. However, there is no guarantee that interference will not occur in a particular installation. If this equipment does cause harmful interference to radio or television reception, which can be determined by turning the equipment off and on, the user is encouraged to try to correct the interference by one or more of the following measures:

- 1) Reorient or relocate the receiving antenna.
- 2) Increase the separation between the equipment and receiver.
- 3) Connect the equipment into an outlet on a circuit different from that to which the receiver is connected.
- 4) Consult the dealer or an experienced radio/TV technician for help.

This Class B digital apparatus complies with Canadian ICES-003.

Cet appareil numérique de la classe B est conforme à la norme NMB-003 du Canada.

CAUTION: TO PREVENT ELECTRIC SHOCK, MATCH WIDE BLADE OF PLUG TO WIDE SLOT, FULLY INSERT.

ATTENTION: POUR ÉVITER LES CHOC ÉLECTRIQUES, INTRODUIRE LA LAME LA PLUS LARGE DE LA FICHE DANS LA BORNE CORRESPONDANTE DE LA PRISE ET POUSSER JUSQU'AU FOND.

A NOTE ABOUT RECYCLING

This product's packaging materials are recyclable and can be reused. Please dispose of any materials in accordance with your local recycling regulations.

Batteries should never be thrown away or incinerated but disposed of in accordance with your local regulations concerning chemical wastes.

Make your contribution to the environment!!!

- Used up batteries do not belong in the dust bin.
- You can dispose of them at a collection point for used up batteries or special waste. Contact your council for details.



For Customer Use:

Read carefully the information located at the back of this unit and enter below the Model No. and Serial No. Retain this information for future reference.

Model No. _____

Serial No. _____

IMPORTANT SAFEGUARDS

1. Read Instructions - All the safety and operating instructions should be read before the appliance is operated.
2. Retain Instructions- The safety and operating instructions should be retained for future reference.
3. Heed Warnings - All warnings on the appliance and in the operating instructions should be adhered to.
4. Follow Instructions - All operating and use instructions should be followed.
5. Cleaning - Unplug this product from the wall outlet before cleaning. Do not use liquid cleaners or aerosol cleaners. Use a damp cloth for cleaning.
EXCEPTION: A product that is meant for uninterrupted service and, that for some specific reason, such as the possibility of the loss of an authorization code for a CATV converter, is not intended to be unplugged by the user for cleaning or any other purpose, may exclude the reference to unplugging the appliance in the cleaning description otherwise required in item 5.
6. Attachments - Do not use attachments not recommended by the product manufacturer as they may cause hazards.
7. Water and Moisture- Do not use this product near water, for example, near a bath tub, wash bowl, kitchen sink, or laundry tub, in a wet basement, or near a swimming pool, and the like.
8. Accessories - Do not place this product on an unstable cart, stand, tripod, bracket, or table. The product may fall, causing serious injury to a child or adult, and serious damage to the appliance. Use only with a cart, stand, tripod, bracket, or table recommended by the manufacturer, or sold with the product. Any mounting of the appliance should follow the manufacturer's instructions and should use a mounting accessory recommended by the manufacturer. An appliance and cart combination should be moved with care. Quick stops, excessive force, and uneven surfaces may cause the appliance and cart combination to overturn.
9. Ventilation - Slots and openings in the cabinet are provided for ventilation and to ensure reliable operation of the product and to protect it from overheating, and these openings must not be blocked or covered. The openings should never be blocked by placing the product on a bed, sofa, rug, or other similar surface. This product should not be placed in a built-in installation such as a bookcase or rack unless proper ventilation is provided or the manufacturer's instructions have been adhered to.
10. Power Sources - This product should be operated only from the type of power source indicated on the marking label. If you are not sure of the type of power supply to your home, consult your appliance dealer or local power company. For products intended to operate from battery power, or other sources, refer to the operating instructions.
11. Grounding or Polarization - This product is equipped with a polarized alternating-current line plug (a plug having one blade wider than the other). This plug will fit into the power outlet only one way. This is a safety feature. If you are unable to insert the plug fully into the outlet, try reversing the plug. If the plug should still fail to fit, contact your electrician to replace your obsolete outlet. Do not defeat the safety purpose of the polarized plug.
12. Power Cord Protection - Power supply cords should be routed so that they are not likely to be walked on or pinched by items placed upon or against them, paying particular attention to cords at plugs, convenience receptacles, and the point where they exit from the appliance.
13. Outdoor Antenna Grounding - If an outside antenna or cable system is connected to the product, be sure the antenna or cable system is grounded so as to provide some protection against voltage surges and built-up static charges. Article 810 of the National Electrical Code, ANSI/

NFPA No. 70, provides information with regard to proper grounding of the mast and supporting structure, grounding of the lead-in wire to an antenna discharge unit, size of grounding conductors, location of antenna-discharge unit, connection to grounding electrodes, and requirements for the grounding electrode. (Fig. A)

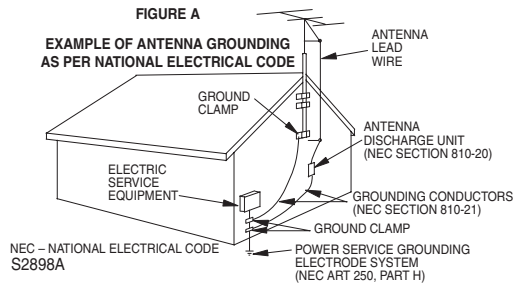

PORTABLE CART WARNING
(Symbol provided by RETAC)



14. Lightning - For added protection for this product during a lightning storm, or when it is left unattended and unused for long periods of time, unplug it from the wall outlet and disconnect the antenna or cable system. This will prevent damage to the product due to lightning and power-line surges.
15. Power Lines - An outside antenna system should not be located in the vicinity of overhead power lines or other electric light or power circuits, or where it can fall into such power lines or circuits. When installing an outside antenna system, extreme care should be taken to keep from touching such power lines or circuits as contact with them might be fatal.
16. Overloading - Do not overload wall outlets and extension cords as this can result in a risk of fire or electric shock.
17. Object and Liquid Entry - Never push objects of any kind into this product through any openings as they may touch dangerous voltage points or short-out parts that could result in a fire or electric shock. Never spill liquid of any kind on the product.
18. Servicing - Do not attempt to service this product yourself as opening or removing covers may expose you to dangerous voltage or other hazards. Refer all servicing to qualified service personnel.
19. Damage Requiring Service - Unplug this product from the wall outlet and refer servicing to qualified service personnel under the following conditions:
 - a. When the power-supply cord or plug is damaged.
 - b. If liquid has been spilled, or objects have fallen into the product.
 - c. If the product has been exposed to rain or water.
 - d. If the product does not operate normally by following the operating instructions. Adjust only those controls that are covered by the operating instructions as an improper adjustment of other controls may result in damage and will often require extensive work by a qualified technician to restore the product to its normal operation.
 - e. If the product has been dropped or damaged in any way.
 - f. When the product exhibits a distinct change in performance this indicates a need for service.
20. Replacement Parts - When replacement parts are required, be sure the service technician has used replacement parts specified by the manufacturer or have the same characteristics as the original part. Unauthorized substitutions may result in fire, electric shock or other hazards.
21. Safety Check - Upon completion of any service or repairs to this product, ask the service technician to perform safety checks to determine that the product is in proper operating condition.
22. Heat - This product should be situated away from heat sources such as radiators, heat registers, stoves, or other products (including amplifiers) that produce heat.

Before you start

Precautions (cont'd)

Installation Location

For safety and optimum performance of this unit:

- Install the unit in a horizontal and stable position. Do not place anything directly on top of the unit. Do not place the unit directly on top of the TV.
- Shield it from direct sunlight and keep it away from sources of intense heat. Avoid dusty or humid places. Avoid places with insufficient ventilation for proper heat dissipation. Do not block the ventilation holes on the sides of the unit. Avoid locations subject to strong vibration or strong magnetic fields.

Avoid the Hazards of Electrical Shock and Fire

- Do not handle the power cord with wet hands.
- Do not pull on the power cord when disconnecting it from AC wall outlet. Grasp it by the plug.
- If, by accident, water is spilled on this unit, unplug the power cord immediately and take the unit to our Authorized Service Center for servicing.

Moisture Condensation Warning

Moisture condensation may occur inside the unit when it is moved from a cold place to a warm place or after heating a cold room or under conditions of high humidity. Do not use this unit at least for 2 hours until its inside gets dry.

About Copyright

Unauthorized copying, broadcasting, public performance and lending of discs are prohibited. This product incorporates copyright protection technology that is protected by U.S. patents and other intellectual property rights. Use of this copyright protection technology must be authorized by Macrovision, and is intended for home and other limited viewing uses only unless otherwise authorized by Macrovision. Reverse engineering or disassembly is prohibited.

Notice for progressive scan output

Consumers should note that not all high definition television sets are fully compatible with this product and may cause artifacts to be displayed in the picture. In case of picture problems with 525 progressive scan output, it is recommended that the user switch the connection to the 'standard definition' output. If there are questions regarding your TV set compatibility with this 525p DVD recorder, please contact our customer service center.

Before you start

Precautions (cont'd)

Maintenance

SERVICING

- Please refer to relevant topics on Troubleshooting on pages 78-81 before returning the product.
- If this unit becomes inoperative, do not try to correct the problem by yourself. There are no user-serviceable parts inside. Turn off, unplug the power plug and please call our help line mentioned on the front page to locate an Authorized Service Center.

CLEANING THE CABINET

- Use a soft cloth slightly moistened with a mild detergent solution. Do not use a solution containing alcohol, spirits, ammonia or abrasive.

CLEANING DISCS

- When a disc becomes dirty, clean it with a cleaning cloth. Wipe the disc from the center to out. Do not wipe in a circular motion.
- Do not use solvents such as benzine, thinner, commercially available cleaners, detergent, abrasive cleaning agents or antistatic spray intended for analogue records.

CLEANING THE DISC LENS

- If this unit still does not perform properly although you refer to the relevant sections and to "Troubleshooting" in this Owner's Manual, the laser optical pickup unit may be dirty. Consult your dealer or an Authorized Service Center for inspection and cleaning of the laser optical pickup unit.

DISC HANDLING

- Handle the discs so that fingerprints and dust do not adhere to the surfaces of the discs.
- Always store the disc in its protective case when it is not used.

AUTO HEAD CLEANING

- Automatically cleans video heads as you insert or remove a cassette, so you can see a clear picture.
 - Playback picture may become blurred or interrupted while the TV program reception is clear. Dirt accumulated on the video heads after a long period of use, or the usage of rental or worn tapes can cause this problem. If a streaky or snowy picture appears during playback, the video heads in the unit may need to be cleaned.
1. Please visit your local Audio/Video store and purchase a good quality VHS Video Head Cleaner.
 2. If a Video Head Cleaner does not solve the problem, please call our help line mentioned on the front page to locate an Authorized Service Center.

NOTES:

- Remember to read the instructions along with the video head cleaner before use.
- Clean video heads only when problems occur.

IR SIGNAL CHECK

If the remote control does not work properly, you can test if the remote control sends out the infrared signal with AM radio or a digital camera (including built-in camera of cellular phone). It will help to define the cause of malfunction.

- **With an AM radio:**
Tune a AM radio to a band with no broadcasting. Press a button on remote control toward the radio. Sound will be fluttering when you press any key and the radio receives the signal. This means the remote control unit is working.
- **With a digital camera (including built-in camera of cellular phone):**
Direct a digital camera to remote control, press and hold a button on remote control. If infrared light appears through digital camera, the remote is working.

Manufactured under license from Dolby Laboratories. "Dolby" and the double-D symbol are trademarks of Dolby Laboratories.

Dolby Digital Recording

"Dolby[®] Digital Recording enables consumers to record high-quality video with stereo sound on recordable DVD discs. The technology, when utilized instead of PCM recording, also saves recordable disc space, allowing for higher video resolution or extended recording time on each DVD. DVDs created using Dolby Digital Recording will play back on all DVD-Video players."

Note: This is true when the players are compatible with actual recordable DVD discs.

Before you start

Table of contents

Before you start	2	Marker Setup	46
Precautions	2	Search	47
Table of contents	6	Title / Chapter search	47
Features	7	Track search	48
Functional overview	8	Time search	48
Installing batteries in the remote control	10	Repeat/Random/Program playback	49
Using a remote control	10	Repeat playback	49
The VCR / DVD recorder switching	10	Random play	49
Setup menus	11	Program play	50
Display menu	12	Selecting the format of audio and video	50
Connections	14	Switching subtitles	50
Connection to a TV	14	Switching audio soundtrack	51
Connection to a cable box or satellite box	15	Switching virtual surround system	51
Connection to an Audio System	16	Switching camera angles	52
Getting started	17	Visual Noise Reduction	52
Easy DVD recording	17	Editing	53
Initial setting	19	Information on disc editing	53
Channel setting	19	Guide to a title list	53
Getting channels automatically	19	Editing discs in Video mode	53
Adding / deleting channels	20	Editing discs in VR mode	53
Selecting the TV stereo or SAP	21	Editing discs in Video mode	54
Setting the clock	22	Deleting titles	54
Auto Clock Setting	22	Putting names on titles	55
Manual Clock Setting	23	Setting or clearing chapter markers	56
Setting the Daylight Saving Time	24	Editing discs in VR mode (Original)	57
Selecting the TV aspect ratio	24	Deleting titles	57
Recording	25	Setting titles to protect	58
Information on DVD recording	25	Releasing titles from protecting	59
Information	25	Editing discs in VR mode (Playlist)	60
Recordable disc	25	Deleting titles	60
Recording speed	25	Dividing a title	61
Restrictions on recording	26	Combining titles	62
Information on copy control	26	Adding titles to a Playlist	63
Making discs playable on other DVD player (Finalize)	26	Deleting a Playlist	63
Formatting a disc	27	Editing discs in VR mode (Original / Playlist) ..	64
Choosing the recording format of a blank disc	27	Deleting parts of titles	64
Reformatting a disc	28	Putting names on titles	65
Setting for Auto Chapter	28	Setting or clearing chapter markers	66
Basic recording	29	Setting pictures for thumbnails	67
One-touch Timer Recording	30	Changing the Setup menu	68
Timer Recording	31	Tour of the Setup menu	68
Hints for Timer Recording	33	Language setting	69
Settings for an external source	34	Display setting	70
Connection to an external source	34	Audio setting	71
Recording from an external source	35	Video setting	73
Setting a disc to protect	35	Settings for Parental lock level	73
Finalizing the discs	36	VCR functions	75
Auto finalize	37	Playback	75
Dubbing Mode	38	Playback	75
Playing discs	40	Recording and One-touch Timer Recording ..	75
Information on DVD playback	40	Recording	75
Basic playback	41	One-touch Timer Recording	76
Playback	41	Search	76
Playing MP3 / WMA disc	42	Index search	76
Playing discs using the Disc menu	43	Time search	77
Playing back discs using the Title menu	43	Other operations	77
Pause	43	Others	78
Special playback	44	Troubleshooting	78
Resume playback	44	RF output switch	81
Fast forward / Fast reverse	44	Glossary	82
Skipping TV commercials during playback	44	Language code	82
Rapid Play	45	Frequently Asked Questions	83
Step by step playback	45	Specifications	83
Slow forward / Slow reverse play	45	Español	84
Zoom	46	Limited Warranty	Back Cover

Before you start

Features

This unit not only plays back DVDs, CDs and VHS tapes but also offers features for you to record on DVD discs and edit them after that. The following features are offered with this unit.

Recording

DVD mode VCR mode

This unit is compatible with both DVD-RW, which is rewritable repeatedly, and DVD-R, which is available for one-time recording only. Also, this unit allows you to record to the videotape. You can choose either one for your convenience.

Recording up to 8 programs:

You can program the unit to record up to 8 programs within a month in advance. Daily or weekly program recordings are also available.

One-touch Timer Recording:

You can easily set recording time as you prefer. Every time [REC/OTR] is pressed during recording, the recording time will be increased by 30 minutes up to 8 hours. The unit will automatically turn off when it reached to the recording time you set.

Dubbing mode:

You can copy a DVD disc to a videotape or copy a videotape to a DVD disc. This function will be possible only if the DVD disc or a videotape is not copy protected. You cannot record on a videotape when its record tab is removed.

Left channel stereo recording:

This unit can record the Left channel monaural sound as Left and Right channel sound automatically.

Automatic Chapter marker setting:

You can mark each title of recording with chapter markers as you set in the Setup menu before recording.

Automatic Title menu making (Video mode):

The unit makes title menus automatically when finalizing the disc.

Automatic Playlist making (VR mode):

A Playlist will be prepared from an Original title, so that you can edit titles on a Playlist as you prefer. An Original title is kept as it is.

Automatic finalizing (Video mode):

The unit can finalize discs automatically after finishing all Timer Recordings or when the disc runs out recordable space.

Playback

DVD mode

Theater quality sound at your home:

When connecting the unit to an amplifier or a decoder which is compatible with Dolby Digital, you can experience the theater-quality sound environment.

Quick search for what you want to watch:

You can easily find the part you want to watch using title, chapter or time search functions.

Start Playback from Original and Playlist (VR mode):

You can play back titles from either an Original title or Playlist.

Virtual Surround System:

You can enjoy stereophonic space through your exciting 2 channel stereo system.

Playing back on MP3 / WMA disc:

You can enjoy MP3 / WMA files which are recorded on CD-RW/R.

Quick search for what you want to watch:

You can easily find the part you want to watch using the Index search/Time search functions. An index mark will be assigned at the beginning of each recordings you make. For Time search function, you can go to a specific point on a videotape by entering the exact amount of time you wish to skip.

Editing

DVD mode

Deleting titles:

You can delete titles which you do not need anymore.

Making your own Playlist (VR mode):

With the original remains as it is, you can edit titles on Various playlist as you prefer.

Putting names on titles.

Setting pictures for thumbnails.

Setting/clearing chapter markers.

Dividing / Combining titles.

Deleting parts of titles, etc.

Protecting titles (VR mode):

You can prevent accidental editing or title erasing, with protect function.

Compatibility

DVD mode

Playback of discs recorded in Video mode on a regular DVD player (Video mode):

Discs recorded in the Video mode can be played back on regular DVD players, including computer DVD drives compatible with DVD-Video playback*. You will need to finalize the discs recorded in Video mode to play them back on other DVD players.

* DVD-Video Format (Video mode) is a new format for recording on DVD-RW/R discs that was approved by the DVD Forum in 2000. Adoption of this format is optional for manufactures of DVD playback devices, and there are DVD-Video players, DVD-ROM drives or other DVD playback devices that do not play back DVD-RW/R discs recorded in the DVD-Video Format.

Others











Progressive Scan system

Unlike conventional interlace scanning, the progressive scan system provides less flickering and higher resolution images than the traditional scanning system does.

Symbol in this Owner's Manual

The availability of many functions of this unit depends on the disc type or the recording mode.

To specify disc type or recording mode for each function, we put the following symbols at the beginning of each function.

Symbol	Description
	Available to DVD-Video discs
	Available to DVD-RW in Video mode
	Available to DVD-RW in VR mode
	Available to DVD-R discs
	Available to Audio CDs
	Available to CD-RW/R discs with MP3 files
	Available to CD-RW/R discs with WMA files
	Available to VHS tapes Use only VHS tapes marked with this unit.
First: (Press:) 	Indicates that you need to select the DVD mode by pressing [DVD] on the remote control before proceeding next step.
First: (Press:) 	Indicates that you need to select the VCR mode by pressing [VCR] on the remote control before proceeding next step.

Before you start

Functional overview

Front Panel

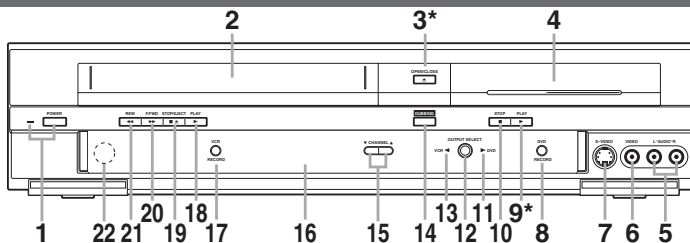

(*)The unit can also be turned on by pressing these buttons.

- 1. POWER button / indicator (DVD/VCR)**
Press to turn on and off the unit.
Red LED lights up when power is on.
- 2. Cassette compartment (VCR)**
Insert a videotape here.
- 3. OPEN/CLOSE ▲ button (DVD)***
Press to open or close the disc tray.
- 4. Disc tray (DVD)**
Place a disc when it is open.
- 5. AUDIO input jacks (LINE2) (DVD/VCR)**
Use to connect external equipment with a standard audio cable.
- 6. VIDEO input jack (LINE2) (DVD/VCR)**
Use to connect external equipment with a standard video cable.
- 7. S-VIDEO input jack (LINE2) (DVD/VCR)**
Use to connect the S-Video output of external equipment with an S-Video cable.
- 8. DVD RECORD button**
Press once to start recording.
Press repeatedly to start a One-touch Timer Recording.
- 9. PLAY ► button (DVD)***
Press to start or resume play.
- 10. STOP ■ button (DVD)**
Press to stop playback or recording.
Press to stop the proceeding Timer Recording in DVD.
- 11. DVD indicator**
Appears when the DVD output mode is selected.
- 12. OUTPUT SELECT button (DVD/VCR)**
Press to select the component you wish to operate.
- 13. VCR indicator**
Appears when the VCR output mode is selected.
- 14. DUBBING button (DVD/VCR)**
Press to start VCR to DVD (DVD to VCR) duplication which you set in the Setup menu.
- 15. CHANNEL ▼ / ▲ button (DVD/VCR)**
Press to change the channel up and down.
- 16. Display**
Shows various information and messages.
- 17. VCR RECORD button**
Press once to start a recording. Press repeatedly to start a One-touch Timer Recording.
- 18. PLAY ► button (VCR)**
Press to start playback.
- 19. STOP ■ / EJECT ▲ button (VCR)**
EJECT ▲ button
Press to remove the videotape from the cassette compartment when the power is on or off.
STOP ■ button
Press to stop videotape playback or recording.
Press to stop the proceeding Timer Recording in VCR.
- 20. F.FWD ►► button (VCR)**
Press to rapidly advance the videotape, or view the picture rapidly in forward during playback. (Forward Search)
- 21. REW ◀◀ button (VCR)**
Press to rewind the videotape, or to view the picture rapidly in reverse during the playback mode. (Rewind Search)
- 22. Remote control sensor (DVD/VCR)**
Receive signals from your remote control so that you can control the unit from a distance.

Rear Panel

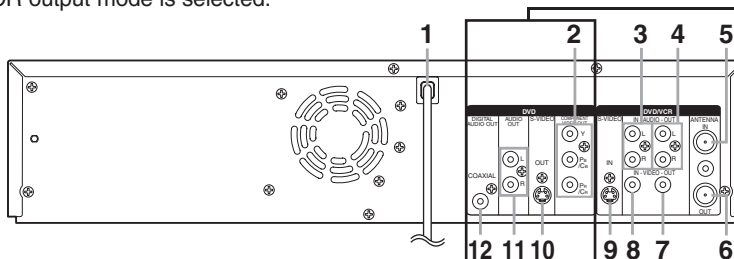

• These jacks are useful only in DVD mode.

- 1. AC Power Cord (DVD/VCR)**
Connect to a standard AC outlet to supply power to this unit.
- 2. COMPONENT VIDEO OUTPUT jacks (DVD only)**
Use to connect a TV monitor with component video inputs with a component video cable.
- 3. AUDIO IN jacks (LINE1) (DVD/VCR)**
Use to connect external equipment with a standard audio cable.
- 4. AUDIO OUT jacks (DVD/VCR)**
Use to connect a TV monitor, AV receiver or other equipment with a standard audio cable.
- 5. TV ANTENNA IN jack (DVD/VCR)**
Use to connect an antenna.
- 6. TV ANTENNA OUT jack (DVD/VCR)**
Use to connect an antenna cable to pass the signal from the TV ANTENNA IN to your TV monitor.
- 7. VIDEO OUT jack (DVD/VCR)**
Use to connect a TV monitor, AV receiver or other equipment with a standard video cable.
- 8. VIDEO IN jack (LINE1) (DVD/VCR)**
Use to connect external equipment with a standard video cable.
- 9. S-VIDEO IN jack (LINE1) (DVD/VCR)**
Use to connect the S-Video output of external equipment with an S-Video cable.
- 10. S-VIDEO OUT jack (DVD only)**
Use to connect the S-Video input of a TV monitor, AV receiver or other equipment with an S-Video cable.
- 11. AUDIO OUT jacks (DVD only)**
Use to connect a TV monitor, AV receiver or other equipment with a standard audio cable.
- 12. COAXIAL DIGITAL AUDIO OUTPUT jack (DVD only)**
Use to connect an AV receiver, Dolby Digital decoder or other equipment with a coaxial digital input jack with a digital coaxial cable.

Note

Do not touch the inner pins of the jacks on the rear panel. Electrostatic discharge may cause permanent damage to the unit.

Before you start

Functional overview (cont'd)

Remote Control

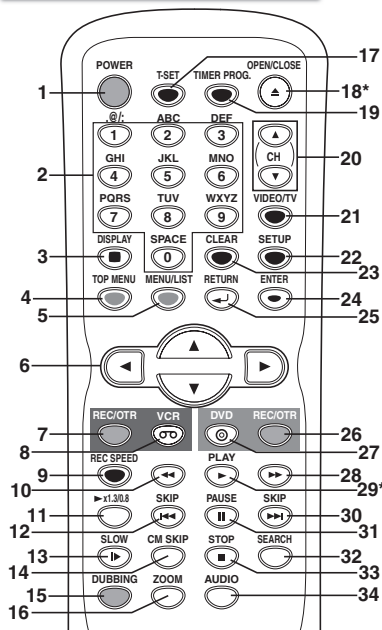

(*) In DVD mode, the unit can also be turned on by pressing these buttons.

1. **POWER button (DVD/VCR)**
Press to turn on and off the unit.
2. **Number buttons (DVD/VCR)**
Press to select channel numbers.
Press to select a title / chapter / track on display.
Also press to enter values for the settings in the Setup menu.
Also press to start the index/time search in VCR mode.
3. **DISPLAY button (DVD/VCR)**
Press to display the On Screen menu.
4. **TOP MENU button (DVD)**
Press to display the Title menu.
5. **MENU/LIST button (DVD)**
Press to display the Disc menu.
Press to change Original and Playlist on the TV screen.
(VR mode only)
6. **Cursor ▲ / ▼ / ◀ / ▶ buttons (DVD/VCR)**
Press to select items or settings.
7. **REC/OTR button (VCR)**
Press to activate the remote control in VCR mode (refer to page 10).
Press once to start a recording.
Press repeatedly to start a One-touch Timer Recording.
8. **VCR ∞ button**
Press to activate the remote control in VCR mode (refer to page 10).
Press to select the VCR output mode.
9. **REC SPEED button (DVD/VCR)**
Press to change the recording speed.
10. **◀◀ button (DVD/VCR)**
• DVD mode
During playback, press to play back in fast reverse.
Or when playback is paused, press to play back in slow reverse.
• VCR mode
Press to rewind the videotape or to view the picture rapidly in reverse during the playback mode.
11. **▶x1.3/0.8 button (DVD)**
During playback, press to playback in a slightly faster/slower speed with keeping the audio quality.
12. **SKIP ◀◀ button (DVD)**
During playback, press to skip to the previous chapter or track.
Or when playback is paused, press to play back in reverse step by step.
13. **SLOW ▶▶ button (VCR)**
During playback, press to view the videotape in slow motion.
14. **CM SKIP button (DVD)**
During playback, press to skip to the 30 second advanced point.
15. **DUBBING button (DVD/VCR)**
Press to start VCR to DVD (DVD to VCR) duplication which you set in the Setup menu.
16. **ZOOM button (DVD)**
During playback, press to enlarge the picture on the screen.
17. **T-SET button (DVD/VCR)**
Press to set the unit in the timer standby mode. In the timer standby mode, press to cancel the mode and to turn the unit on.
18. **OPEN/CLOSE ▲ button (DVD)***
Press to open or close the disc tray.
19. **TIMER PROG. button (DVD/VCR)**
Press to display the Timer Programming list.
20. **CH ▲ / ▼ buttons (DVD/VCR)**
• DVD mode
Press to change the channel up and down.
• VCR mode
Press to change the channel up and down.
Press to adjust the tracking during playback or in slow motion of the videotape. Also while playback is in Still Mode, you can adjust the picture blurred vertically.
21. **VIDEO/TV button (DVD/VCR)**
Press to select VIDEO or TV position.
22. **SETUP button (DVD/VCR)**
Press to display the Setup menu.
During DVD playback, press and hold for more than 3 seconds to switch the progressive scanning mode to the interlace mode.
23. **CLEAR button (DVD/VCR)**
• DVD mode
Press to clear the password entered, to cancel the programming for CD, to clear the highlighted marker number in the marker setup mode or to clear the program once entered in the Timer Programming list, etc.
• VCR mode
Press to reset the tape counter.
24. **ENTER button (DVD/VCR)**
Press to confirm or select menu items.
25. **RETURN ◀ button (DVD/VCR)**
Press to return to the previously displayed menu screen.
26. **REC/OTR button (DVD)**
Press to activate the remote control in DVD mode (refer to page 10).
Press once to start a recording.
Press repeatedly to start a One-touch Timer Recording.
27. **DVD ⊙ button**
Press to activate the remote control in DVD mode (refer to page 10).
Press to select the DVD output mode.
28. **▶▶ button (DVD/VCR)**
• DVD mode
During playback, press to play back in fast forward.
Or when playback is paused, press to play back in slow forward.
• VCR mode
Press to rapidly advance the videotape or view the picture rapidly in forward during playback.
29. **PLAY ▶ button* (DVD/VCR)**
Press to start or resume playback.
30. **SKIP ▶▶▶ button (DVD)**
During playback, press to skip to the next chapter or track.
Or when playback is paused, press to play back in forward step by step.
31. **PAUSE || button (DVD/VCR)**
Press to pause playback or recording.
32. **SEARCH button (VCR)**
Press to call up the index or time search menu.
33. **STOP ■ button (DVD/VCR)**
Press to stop playback or recording.
34. **AUDIO button (VCR)**
During playback a HiFi videotape, press to change the AUDIO OUT setting "HIFI" and "MONO".

Before you start

Functional overview (cont'd)

Installing batteries in the remote control

Install two "AA" size batteries (supplied), matching their polarity to those indicated inside battery compartment of the remote control.

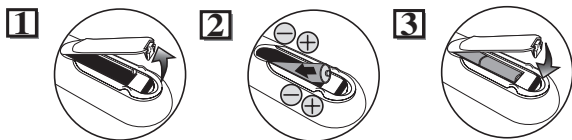

Note:

Incorrect use of batteries can result in hazards such as leakage and bursting. Please follow the instruction below:

- Do not mix new and old batteries together.
- Do not use different kinds of batteries together. Although they may look similar, different batteries may have different voltages.
- Make sure that the plus and minus ends of each battery match the indications in the battery compartment.
- Remove batteries from equipment that is not going to be used for a month or more.
- When disposing used batteries, please comply with governmental regulations or public rules for environmental protection that apply in your country or area.
- Do not recharge, short-circuit, heat, burn or disassemble batteries.

Using a remote control

Keep in mind the following when using the remote control:

- Make sure that there is no obstacle between the remote control and the remote sensor of the unit.
- Remote operation may become unreliable if strong sunlight or fluorescent light is on the remote sensor of the unit.
- Remote control for different devices can interfere with each other. Avoid using remote control for other equipment located close to the unit.
- Replace the batteries when you notice a fall-off of the operating range of the remote control.
- The maximum operable ranges from the unit are as follows.
 - **Line of sight:** approx. 23 feet (7m)
 - **Either side of the center:** approx. 16 feet (5m) within 30°
 - **Above:** approx. 16 feet (5m) within 15°
 - **Below:** approx. 10 feet (3m) within 30°

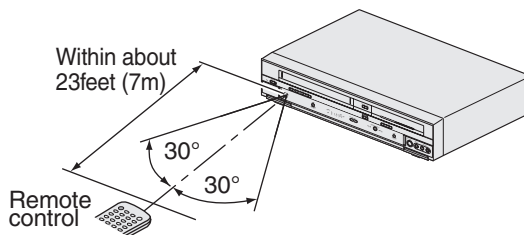

The VCR / DVD recorder switching

Because this product is a combination of a VCR and a DVD recorder, you must select first which component you wish to operate with [**OUTPUT SELECT**].

VCR MODE

Press [**VCR**] on the remote control.
(Verify that the VCR indicator is lit.)

DVD MODE

Press [**DVD**] on the remote control.
(Verify that the DVD indicator is lit.)

Note:

- Pressing only [**OUTPUT SELECT**] on the front panel **DOES NOT** switch the mode of the remote control. You **MUST** select the correct mode on the remote control.
- You cannot switch to another mode (DVD or VCR) during the timer-standby mode.
- Pressing [**REC/OTR**] (DVD) or [**REC/OTR**] (VCR) on the remote control switches immediately its respective mode so that you can start recording directly on the appropriate media.

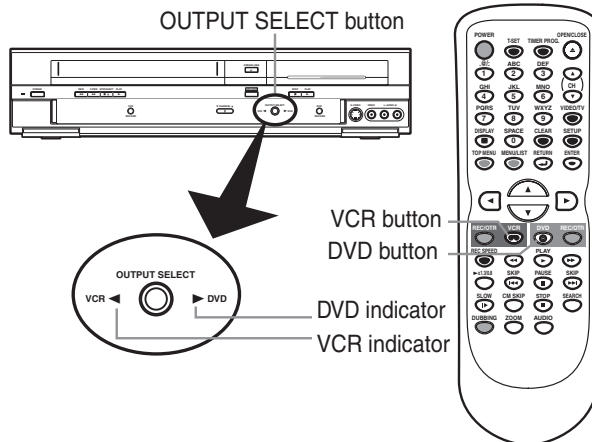

Guide to Displays the On Screen menu

This unit uses the following the On Screen menu for most operations: Setup Menu, Title list, Playlist, Original and Display menu. They allow you to change the playback status of the disc during playback. The Display menu also gives you information on the playback status of the disc or a videotape.

Setup menus

Press **[SETUP]** to display the Setup menu, then press **[ENTER]** to display each menu, using **[▲ / ▼]**. These menus provide entries to all main functions of the unit.

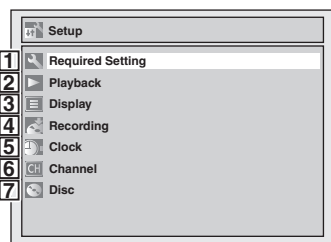

1. Required Setting:

To set up the required setting.

2. Playback:

To set up the unit to play discs as you prefer.

3. Display:

To set up the OSD screen and the front panel display of the unit as you prefer.

4. Recording:

To set up the unit to record on discs or tapes as you prefer.

5. Clock:

To set up the clock of the unit as you need.

6. Channel:

To adjust the channel setting of the unit as you prefer.

7. Disc / CD Playback Mode:

When a DVD-Video disc (commercially available) or a new DVD-R disc is inserted into the unit, you cannot select "Disc".

"CD Playback Mode" is available only when an Audio CD disc or a CD-RW/R disc with MP3 / WMA files is inserted into the unit.

<DVD-R / DVD-RW (Video mode)>

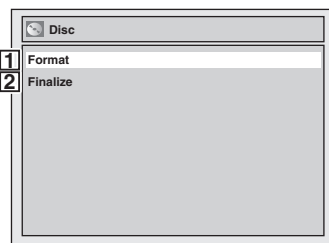

<DVD-RW (VR mode)>

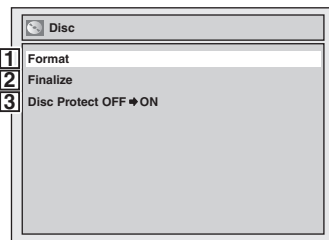

<CD / MP3 / WMA files>

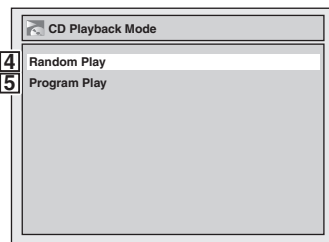

1. Format (DVD-RW only):

Allows you to erase all of the recorded content on the disc. The disc will be completely blank.

- Erased content cannot be called back.
- A DVD-RW disc formatted with this unit cannot be used in other DVD recorders without any recording using this unit.
- If you want to use a disc only formatted with this unit on another DVD recorder, you have to re-format the disc on that recorder.

2. Finalize:

Allows you to finalize a disc containing recorded titles.

3. Disc Protect (VR mode only):

Allows you to protect a disc from accidental editing or recording.

4. Random Play:

To activate the random playback feature.

5. Program Play (Audio CD only):

To activate the programmed playback feature.

Before you start

Functional overview (cont'd)

Display menu

DVD mode





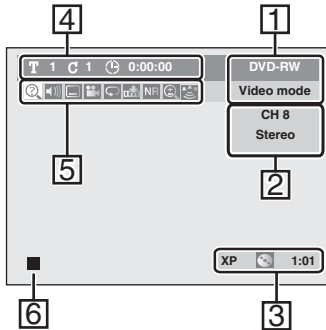



First: 

Press **[DISPLAY]** to call up the Display menu. This menu will give you the information on the disc. Some operations are available while disc is inserted in the unit.



1. Indicates a disc type and a format mode.
Note: In some descriptions on this manual, only one disc type is indicated as an example.
2. Indicates a current channel number and an audio status of the program.
3. Indicates a recording mode and possible recording time left.
4. Indicates a title number, chapter number and the time elapsed of disc play.

5. Each icon means:

-  : Search
-  : Audio
-  : Subtitle
-  : Angle (except VR mode)
-  : Repeat
-  : Marker
-  : Noise Reduction
-  : Zoom
-  : Surround

6. Indicates current disc status.

Note:

- This is an example screen only for explanation. Displayed items will change depending on the actual mode.
- DISPLAY function is not available when the disc is not inserted.

VCR mode

First: 

Press **[DISPLAY]** to display the On Screen display.

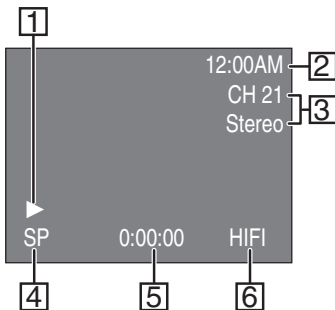

1. Indicates current video status.
2. Indicates the current time.
3. Indicates a current channel number and an audio status of the program.
4. Indicates a recording or playing speed.
5. Indicates a Tape Counter.
6. Audio status of the current videotape.

Note:

- This is an example screen only for explanation. Displayed items will change depending on the actual mode.

Before you start

Functional overview (cont'd)

Front Panel Display Guide

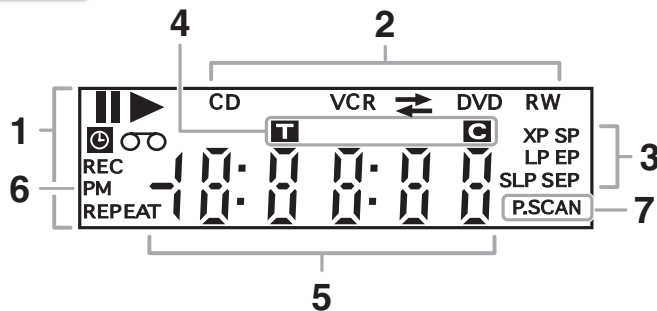

1. Current Status of the unit

|| :Appears when a disc or a videotape play is paused.

▶ :Appears when playing back a disc or a videotape.

⌚ :Appears when the timer programming or OTR has been set and is proceeding.
:Flashes when all Timer Recordings have been finished.

REC :Appears during recording process.
:Flashes when a recording pauses.

REPEAT

:Appears during repeat playback (disc playback only).

⌚ :Appears when a videotape is in the unit.

2. Disc type and Current status of the unit

CD :Appears when an Audio CD or a disc with MP3/WMA files is on the disc tray.

DVD :Appears when a DVD disc is on the disc tray.
Appears when the Timer Recording is proceeding in DVD.
Appears when DVD is in the Timer Recording standby mode.
:Flashes when a program cannot be performed for some reasons.

DVD R :Appears when a DVD-R disc is on the disc tray.

DVD RW :Appears when a DVD-RW disc is on the disc tray.

VCR :Appears when the Timer Recording is proceeding in VCR.
Appears when VCR is in the Timer Recording standby mode.
:Flashes when a program cannot be performed for some reasons.

VCR → DVD :Appears during VCR to DVD duplication process.

VCR ← DVD :Appears during DVD to VCR duplication process.

3. Recording speed

Indicates the recording speed of the disc or a videotape.

4. Title/Track and Chapter mark

T :Appears when indicating a title/track number.

G :Appears when indicating a chapter number.

5. Displays the following

- Played-back time
- Current title / chapter / track number
- Recording time / remaining time
- Clock
- Channel number
- VCR tape counter
- Remaining time for a One-touch Timer Recording

6. PM

:Appears in the afternoon with the clock display.

7. P.SCAN

:Appears when the progressive scan system is activated.

Display message



Appears when the disc tray is opening.



Appears when a disc is loaded on the disc tray.



Appears when the disc tray is closing.

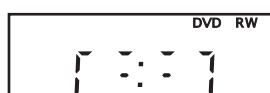

Appears when data is being recorded on a disc.

Connections

Connection to a TV

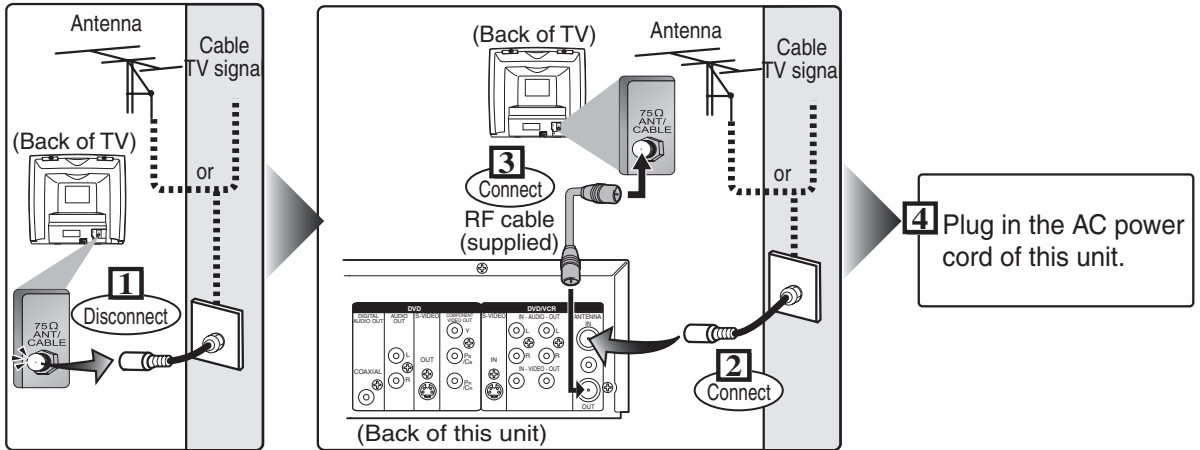

Choose one of the following connections, depending on the capabilities of the equipment you possess.

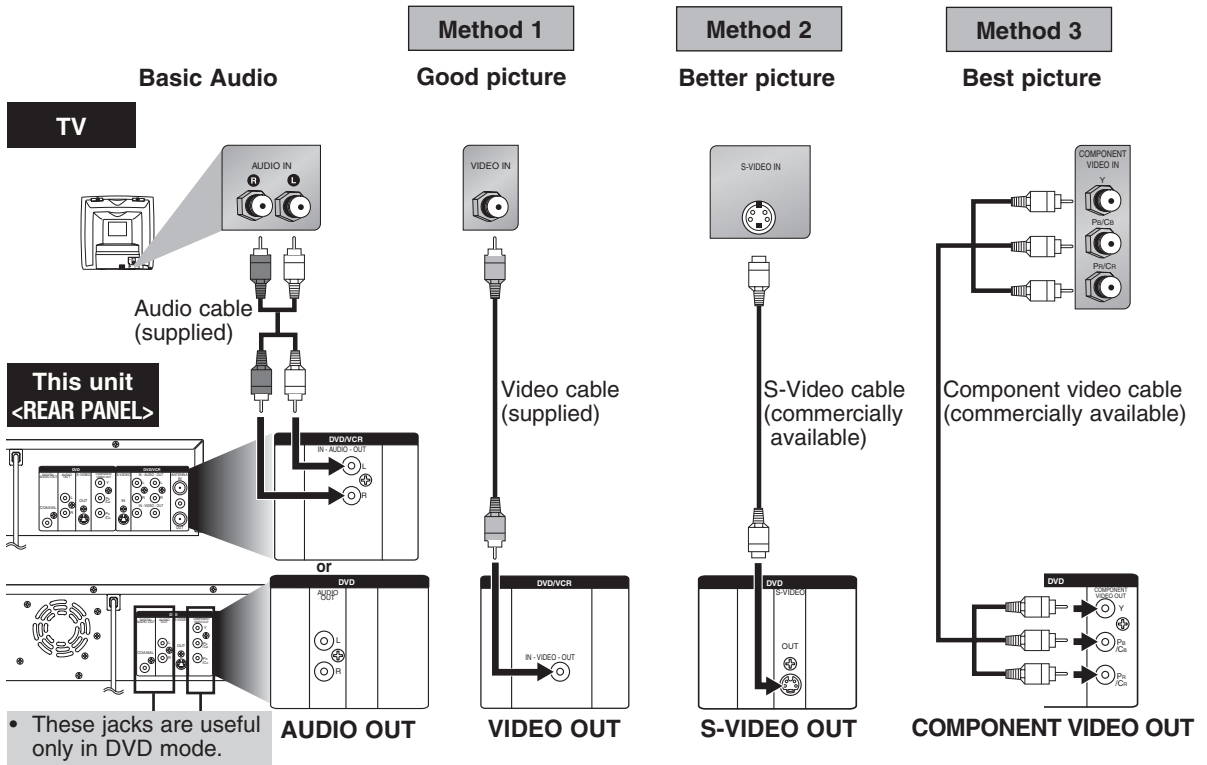

Note

- Connect this unit directly to the TV. If the A/V cables are connected to a VCR, pictures may be distorted due to the copy protection system.
- Method 2 and method 3 are only useful in DVD mode.
- Although you can view images when using the connection Method 1 and 2 while Progressive Scan is activated, they are in Interlace mode.

Connections

Connection to a TV (cont'd)

After you have completed connections

- Switch the input selector on your TV to an appropriate external input channel (usually near channel 0). Press a button on the TV's original remote control that selects an external input channel until the DVD recorder's picture appears. Check your TV owner's manual for details.

Input Mode Names for Common TV Brands (Example)

Admiral	AUX	Panasonic	TV/VIDEO
Curtis Mathis	LINE1, LINE2, 00, 90, 91, 92, 93	RCA	INPUT, TV/VCR, 00, 90, 91, 92, 93
GE	INPUT, TV/VCR, 00, 90, 91, 92, 93	Samsung	TV/VIDEO
Hitachi	INPUT, AUX	Sanyo	VIDEO
JVC	VIDEO, VIDEO 1, VIDEO 2, VIDEO 3	Sharp	00
Kenwood	AUX	Sony	VIDEO1, VIDEO2, VIDEO3
LXI-Series	00	Toshiba	TV/GAME
Magnavox	AUX CHANNEL	Zenith	00

This unit is compatible with the Progressive Scan System. The feature provides you with the higher definition images than the traditional output system does. To utilize this feature, you must set Progressive Scan mode to "ON" in the Setup menu by following the steps below.

1. Press **[SETUP]** to call up the Setup menu.
2. Select "Playback" using **[▲ / ▼]**, then press **[ENTER]**.
3. Select "Video" using **[▲ / ▼]**, then press **[ENTER]**.
4. Select "Progressive" using **[▲ / ▼]**, then press **[ENTER]**.
5. Select "ON" using **[▲ / ▼]**, then press **[ENTER]**.
6. Select "Yes" using **[◀ / ▶]**, then press **[ENTER]**.
7. Confirmation window will appear in Progressive mode. Select "Yes", using **[▲ / ▼]**, then press **[ENTER]** within 15 seconds.

- If there is no picture or picture is distorted after selecting "Yes" at step 6, wait about 15 seconds. It will go back to Video-Progressive menu automatically.

- If your TV is compatible with Progressive Scan (525p / 480p), you must use the Component Video cable (commercially available) to connect this unit to the TV. (See Method 3 on page 14.) Make sure the "P.SCAN" appears on the front panel display.

If not, use the video cable and set the Progressive mode to "OFF" or press and hold **[SETUP]** for more than 3 seconds during playback DVD disc, so that the "P.SCAN" on the front panel display disappears.

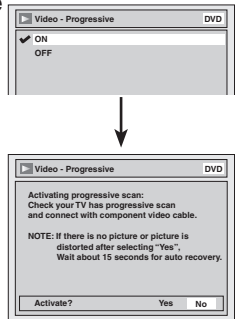

Connection to a cable box or satellite box

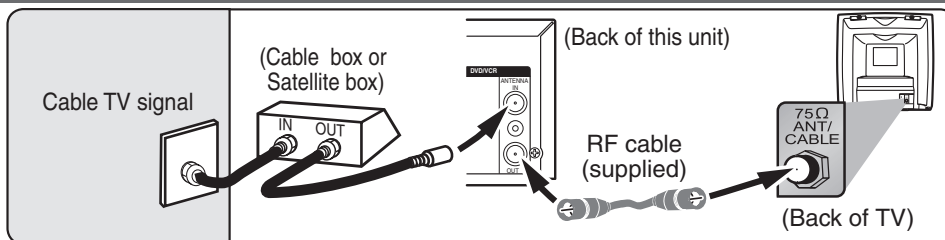

This connection allows you to view or record a scrambled channel. With this connection, channels cannot be changed on this unit. You can view or record ONLY the channels you have selected on the cable box or the satellite box.

- While you are recording, only the recorded channel can be viewed.

To select channels of the cable box or satellite box

- 1) Turn on this unit by pressing **[POWER]**. The "POWER" indicator on the front panel will appear. Then, press **[CHANNEL ▼ / ▲]** to select channel 3 or 4 (the same channel as the output channel of the cable box or satellite box).
- If noise appears on the TV screen, press **[VIDEO/TV]** on the remote control.
- If you use the channel 4, you will need to change this unit's RF output to channel 4. Refer to "RF output switch" on page 81.
- 2) At the TV, select channel 3 or 4 (the same channel as you have selected at step 1).
- 3) At the cable box or satellite box, select the channel you want to view or record.

Note to the Cable TV System Installer :

This reminder is provided to call the Cable TV system installer's attention to Article 820-40 of the National Electrical Code, which provides guidelines for proper grounding - in particular, specifying that the cable ground shall be connected to the grounding system of the building, as close to the point of cable entry as possible.

Connections

Connection to an Audio System

- When you change the connections, all devices should be turned off.
- Refer to the operation manual accompanying external devices for more information.

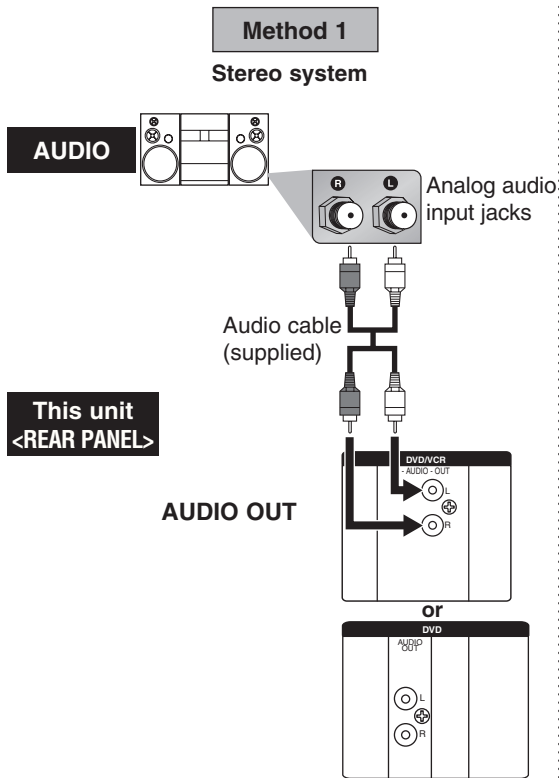

Connection	Setting	Setup > Playback > Audio > Digital Out >	
		PCM	Dolby Digital
If output is Dolby Digital encoded audio, connect to a Dolby Digital decoder.		-	STREAM
Unless connected to a Dolby Digital decoder.		-	PCM
Connecting to an MD deck or DAT deck.		-	PCM

* To complete these settings, refer to pages 71-72.

Note

- Playing back a DVD using incorrect settings may generate noise distortion and may also damage the speakers.

Note

- By connecting this unit to a Multi-channel Dolby Digital decoder, you can enjoy high-quality Dolby Digital Multi-channel surround sound as heard in the movie theaters.
- The audio source on a disc in a Dolby Digital Multi-channel surround format cannot be recorded as digital sound by an MD or DAT deck.
- Playing back a DVD using incorrect settings may generate noise distortion and may also damage the speakers.

Getting started

Easy DVD recording

The following will help you to understand easily how to record to DVD discs.

Note:

Make sure batteries are in the remote control and you have connected this unit and the TV correctly.

Step 1: Choose a disc type.

There are several types of recordable DVD discs to choose from. Choose a recordable DVD disc type based on your playing/recording/editing requirements. See "DVD disc types" at the bottom of this page for more information on the differences between the different kinds of compatible media.

This unit can record on the following type of discs.

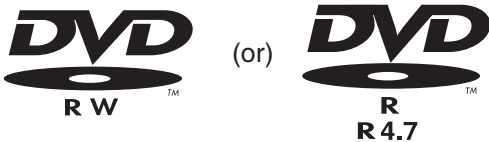

For example, when you want to record repeatedly on the same disc, or when you want to edit the disc after recording, select the rewritable DVD-RW type disc.

When you want to save recordings without any alteration, a non-rewritable DVD-R can be your choice.

Step 2: Insert a blank disc.

Remote Control

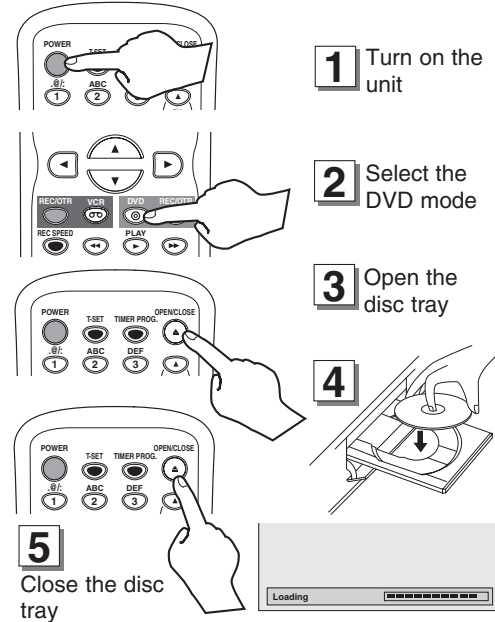

This operation may take a while to be recognized.

DVD disc types

☆☆☆ : Most suitable ☆☆☆ : Can be used ☆☆☆ : Some functions are limited — : Cannot be used

You want to	(DVD-RW VR)	(DVD-RW Video)	(DVD-R)
Record TV programs	☆☆☆	☆☆☆	☆☆
Reuse by deleting unwanted contents	☆☆☆	☆☆	—
Edit recorded contents	☆☆☆	☆☆	☆☆
Edit/Record from connected equipment	☆☆☆	☆☆☆	☆☆☆☆
Copy discs for distribution	☆☆ ¹	☆☆☆	☆☆☆☆
Play on other DVD equipment	☆☆ ¹	☆☆☆	☆☆☆☆

Features	(DVD-RW VR)	(DVD-RW Video)	(DVD-R)
Recording			
Rewritable?	Yes	Yes	No
Can create chapters at fixed intervals (auto.)	Yes	Yes	Yes
Can create chapters wherever you like (manual)	Yes	No	No
Can record 16:9 size pictures	Yes	Yes	Yes
Can record Copy-Once programs	Yes	No	No
Editing			
Can perform basic edit functions	Yes	Yes	Yes
Can perform advanced edit functions (Playlist edit)	Yes	No	No

¹ DVD-RW (VR mode) can only be played on DVD equipment that is VR compatible.

Note:
For details of the above functions and implied restrictions, see the explanations inside the manual.

Format the disc

When inserting a disc that has already been recorded on, you can delete those contents by formatting that disc.

Formatting is only necessary to prepare disc previously recorded on for recording.

Details are on pages 27-28.

When you format a disc, the entire contents on that disc will be erased.

- The unit automatically starts initializing when a brand new DVD-RW disc is inserted.

Getting started

Easy DVD recording (cont'd)

Step 3: Select the recording speed.

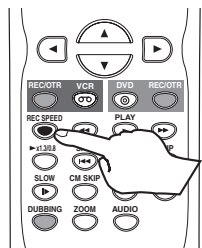

Step 4: Select the desired channel.

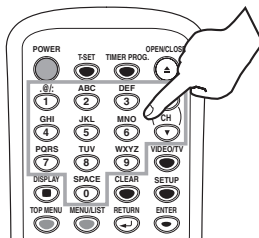

Step 5: Record on DVD disc.

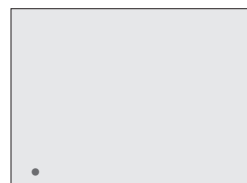
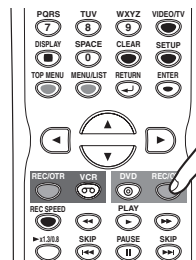

Hint 1: Play the recorded contents

You can select the title you want to play from a displayed menu, and immediately start to play. Recorded contents are easily accessible, with simple procedure of choosing a title on a chapter in the menu screen.

What are titles and chapters?

The contents of DVD disc are generally divided into titles. Titles may be further divided into chapters.

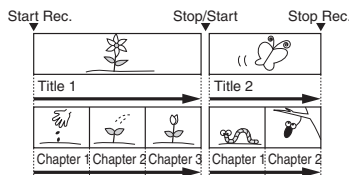

Hint 2: Edit the recorded disc

You will find editing discs is easy. This unit offers convenient edit functions which are possible only with DVD-RW/R discs.

Title list offers following editing functions.

- Putting names on titles
- Setting pictures for thumbnails
- Setting/clearing chapter markers
- Deleting titles or scenes

(Possible editing functions depend on the recording format and editing method.)

Original and Playlist (VR mode)

You can edit the recordings in Playlist without changing the original recordings. Playlist does not take up much disc space.

What "Original" or "Playlist" is for?

Throughout this manual, you will find *Original* and *Playlist* to refer to the original content and the edited version.

- **Original** content refers to what's originally recorded on the disc.
- **Playlist** content refers to the edited version of the original content.

Finalizing a Disc

- You need to record in video mode and finalize the disc to play it back on other players.
- Once you finalize a disc recorded in Video mode, you cannot record or edit any information on the disc.
- Discs recorded in VR mode can still be edited after finalization.

Step 6: Stop the recording.

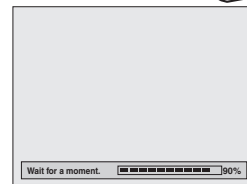
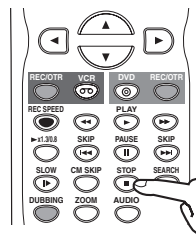

(Appears only in the VR mode)

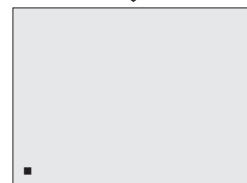

This operation may take a while to be completed.

Getting started

Initial setting

Turn on this unit for the first time, you need to follow these steps.

1
Press [POWER].

2
Turn the TV on. Select the input to which the unit is connected. Refer to the table on page 15. "Initial Setting" will automatically appear.

3
Using [▲ / ▼], select your desired language for the OSD. Then press [ENTER] to go to next step.

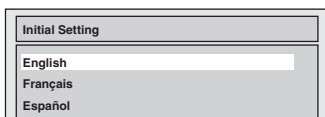

4
Press [ENTER] to start Channel Preset. The unit will start getting channels available in your area.

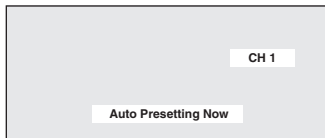

Wait for several minutes to finish channel scanning.

5
After channel setting is finished, "Clock Setting" will appear. Then press [ENTER].

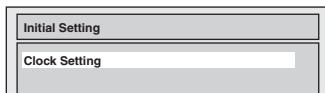

6
Follow to step 3 on page 23 to "Manual Clock Setting".

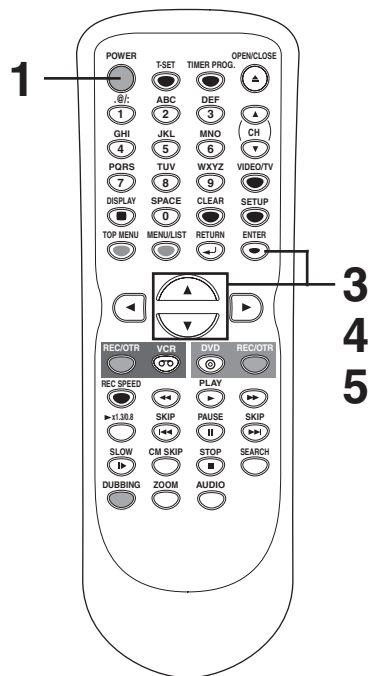

Channel setting

If you have changed antenna connection, we recommend you to program available channels in your area with the following procedures.

Getting channels automatically

1
Press [SETUP].

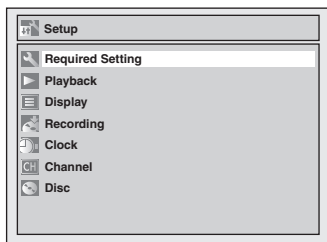

2
Using [▲ / ▼], select "Channel". Press [ENTER]. Channel menu will appear.

3
Using [▲ / ▼], select "Auto Preset". Press [ENTER]. The unit will start getting channels available in your area. Wait for several minutes to finish channel scanning.

4
Press [SETUP] to exit.
• You can select only the channels memorized in this unit by using [CHANNEL ▼ / ▲] or [CH ▲ / ▼].

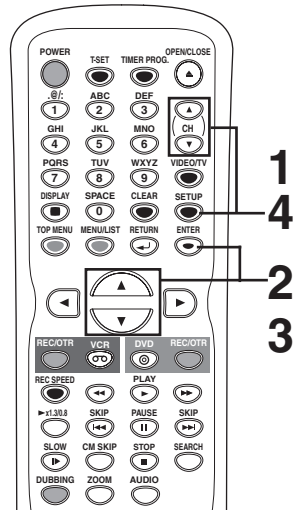

To select a channel

You can select a channel by directly entering channel using the **Number buttons** on the remote control.

Notes for using the Number buttons:

- When selecting cable channels which are higher than 99, enter channel numbers as a three-digit number. (For example: 117, press [1], [1], [7])
- You must precede single-digit channel numbers with a zero (For example: 02, 03, 04 and so on).
- You can select the line input mode ("L1" or "L2"). To select "L1" by pressing [0], [0], [1]. To select "L2" by pressing [0], [0], [2]. Details are on pages 34-35.

Note

- You cannot change the channel when one of the components of the unit (VCR or DVD) is in the recording, OTR or Timer Recording mode.
- **If the auto presetting is cancelled during presetting, some of the channels not yet preset may not be received.**
- The selection will depend on how you receive the TV channels.
Press [RETURN ↵] or [SETUP] to cancel the auto presetting during scanning.

Getting started

Channel setting (cont'd)

Adding / deleting channels

The channels you no longer receive or seldom watch can be deleted from the memory. You also may add channels into memory.

1

Press [SETUP].

2

Using [▲ / ▼], select "Channel". Press [ENTER].

Channel menu will appear.

3

Using [▲ / ▼], select "Manual Preset". Press [ENTER].

Manual Preset menu will appear.

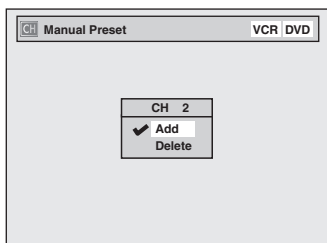

4

Select the channel number to add or delete.

Press [◀] or [CH ▼] to move to a smaller channel number.

Press [▶] or [CH ▲] to move to a larger channel number.

- Use [◀ / ▶] to move through the channels one by one, including the ones not in the channel memory, while using [CH ▲ / ▼] to move through the channels only in the channel memory.

Press the Number buttons to select a channel number directly.

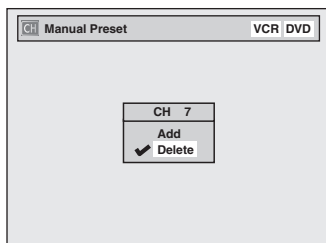

5

Using [▲ / ▼], select "Add" or "Delete". Press [ENTER].

The channel number will be added or deleted from the channel memory. Then the next channel number will appear so that you can continue adding or deleting channels.

6

Press [SETUP] to exit.

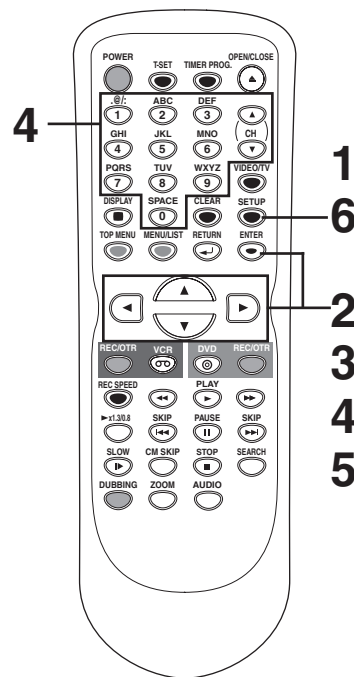

Getting started

Selecting the TV stereo or SAP

You can select an audio channel to output from TV.

1

Press [SETUP].

2

Using [▲ / ▼], select “Required Setting”. Press [ENTER]. Required Setting menu will appear.

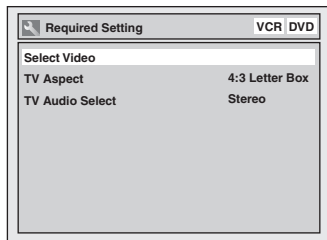

3

Using [▲ / ▼], select “TV Audio Select”. Press [ENTER]. Option window will appear.

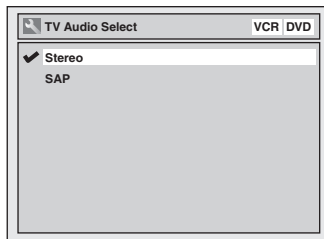

The default is set as “Stereo”.

4

Using [▲ / ▼], select “Stereo” or “SAP”. Press [ENTER].

Stereo:

Outputs main audio.

SAP (Secondary Audio Program):

Outputs sub audio.

Refer to the item in “Glossary” on page 82 for more information.

5

Press [SETUP] to exit.

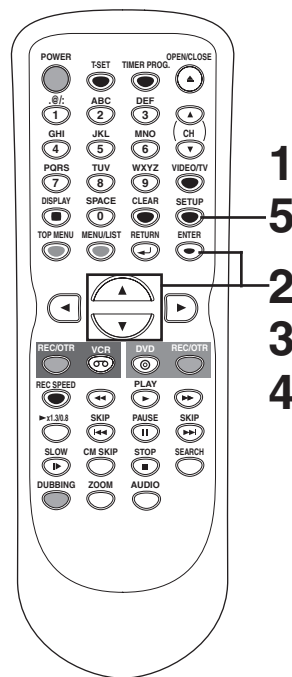

Notes on TV channel audio

- If you want to record a TV program available in second audio or stereo on a DVD-RW/R or videotape, you have to select either Stereo or SAP in the Channel Preset screen beforehand. Refer to the following table to check an appropriate setting.

Selected audio	Broadcast audio	Disc (Videotape) recording	Audio output
Stereo	STEREO+SAP	STEREO	STEREO
	STEREO	STEREO	STEREO
	MONO+SAP	MONO	MONO
	MONO	MONO	MONO
SAP	STEREO+SAP	SAP	SAP
	STEREO	STEREO	STEREO
	MONO+SAP	SAP	SAP
	MONO	MONO	MONO

- You can only play back the disc in second audio if a TV program is available in second audio and you set “TV Audio Select” to “SAP”.

Getting started

Setting the clock

Set the clock before you try the Timer Programming. If Public Broadcasting Service (PBS) is available in your area, follow the "Auto Clock Setting" below. If not, follow the "Manual Clock Setting" on page 23.

Auto Clock Setting

Make sure

- The antenna/Cable TV connections are correct.
- If this unit is connected to a Cable Box or Satellite Box, select the local PBS station on them to set the clock automatically.

1

Press [SETUP].

2

Using [▲ / ▼], select "Clock". Press [ENTER].

Clock menu will appear.

3

Using [▲ / ▼], select "Auto Clock Setting". Press [ENTER].

Option window will appear.

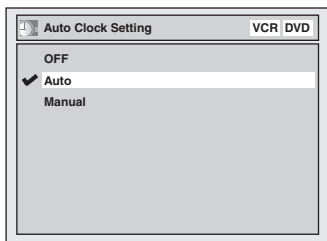

The default setting is "Auto".

4

- If you do not know your PBS channel number in your area: Using [▲ / ▼], select "Auto". Press [ENTER].

The setting will be activated.

- If you know your PBS channel number in your area: Using [▲ / ▼], select "Manual". Press [ENTER].

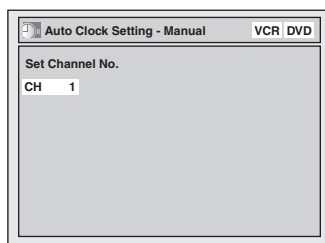

Using the Number buttons or [▲ / ▼], enter your PBS channel number with Number buttons. Press [ENTER].

The setting will be activated.

- If you want to set the clock manually and cancel the Auto Clock Setting function: Using [▲ / ▼], select "OFF". Press [ENTER].

The Auto Clock Setting function will be canceled.

5

Press [SETUP] to exit.

6

Press [POWER] to turn off the unit.

This unit will search for the clock time only when the power is off. Leave it off for several minutes to give this unit time to set the clock on the display of the front panel.

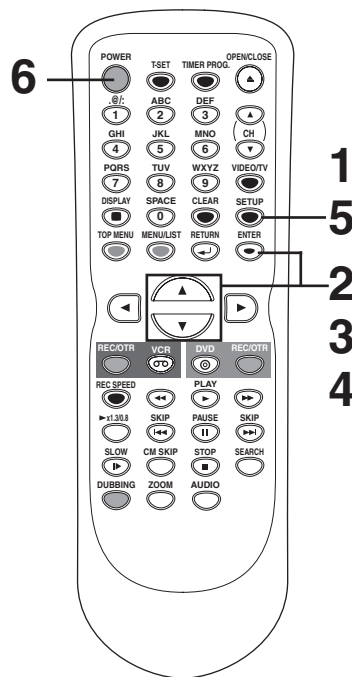

Note

- The clock may set itself automatically after you connect the antenna/cable signal to this unit and plug in the power cord. In this case, the current time will appear on the front panel display.
- If the current time is not displayed or the displayed clock time is not correct, set the clock manually.

Getting started

Setting the clock (cont'd)

Manual Clock Setting

1
Press [SETUP].

2
Using [▲ / ▼], select "Clock".
Press [ENTER].

3
Using [▲ / ▼], select "Clock Setting". Press [ENTER].
Clock Setting menu will appear.

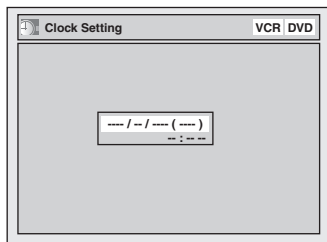

Press [ENTER] again.
Default date will appear.

4
Using [▲ / ▼], enter the date
(month / day / year).
Press [◀ / ▶] to move the cursor.

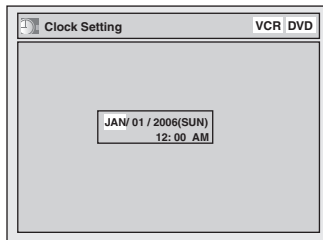

5
Using [▲ / ▼], enter the time
(hour / minute). Press [◀ / ▶].
A cursor will move on AM.

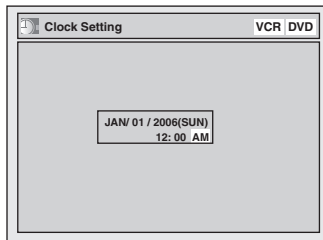

6
Press [▲ / ▼] to select "AM" or
"PM". Press [ENTER].
The settings will be activated.
Although seconds are not displayed,
they begin counting from zero.

7
Press [SETUP] to exit, if Clock
menu appears.

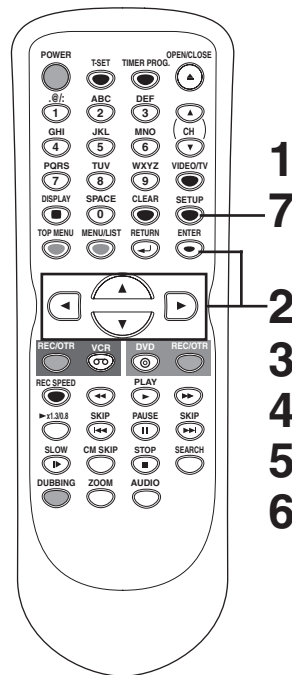

Note

- Your clock setting will be lost if either there is a power failure or this unit has been unplugged for more than 30 seconds.

Getting started

Setting the clock (cont'd)

Setting the Daylight Saving Time

When "Daylight Saving Time" is "ON", the clock will automatically move forward one hour at 2:00a.m. on the first Sunday in April and move back one hour at 2:00a.m. on the last Sunday in October. "ON" is selected as a default.

1

Press [SETUP].

2

Using [▲ / ▼], select "Clock". Press [ENTER]. Clock menu will appear.

3

Using [▲ / ▼], select "Daylight Saving Time". Press [ENTER]. Option window will appear.

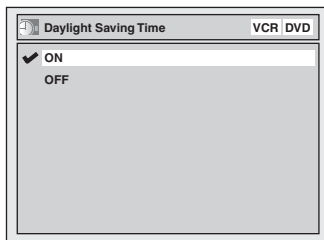

4

Using [▲ / ▼], select "ON" or "OFF". Press [ENTER]. Choose "ON" if you are currently observing the daylight saving time.

5

Press [SETUP] to exit.

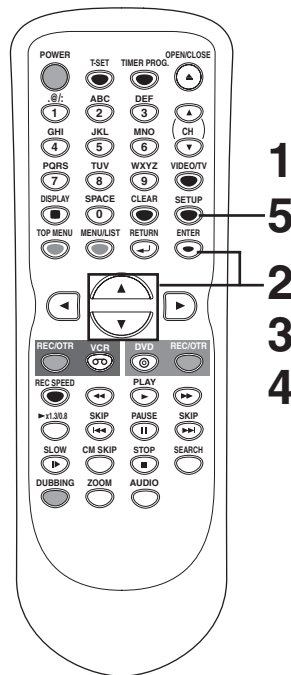

Selecting the TV aspect ratio

You can select the TV aspect ratio to match the formats of what you are playing back on the unit and your TV screen (4:3 standard or 16:9 widescreen TV). The default is set as "4:3 Letter Box".

1

Press [SETUP].

2

Using [▲ / ▼], select "Required Setting". Press [ENTER]. Required Setting menu will appear.

3

Using [▲ / ▼], select "TV Aspect". Press [ENTER]. Option window will appear.

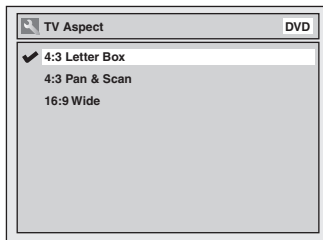

Refer to the Note on this page.

4

Using [▲ / ▼], select a desired option. Press [ENTER].

5

Press [SETUP] to exit.

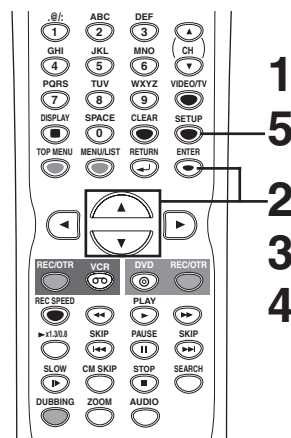

Note

If you have a standard TV:
Select "4:3 Letter Box" for full length picture with black bars on the top and bottom of the screen. Select "4:3 Pan & Scan" for a full height picture with both sides trimmed.



If you have a widescreen TV:
Select "16:9 Wide".

Recording

Information on DVD recording

Information





This unit can record on DVD-R and DVD-RW discs. DVD-R discs allow you to record programs only once, and the recorded contents cannot be erased. DVD-RW discs allow you to record programs repeatedly, and the recorded contents can be erased. You can record programs on DVD-R discs only in Video mode, while recording format for DVD-RW discs can be either Video mode or VR mode.

Logo	Attributes
	8cm/12cm, single-sided, single layer disc
DVD-RW	Approx. max. recording time (SEP mode): 600 minutes (4.7GB) (for 12cm) 180 minutes (1.4GB) (for 8cm)
	
DVD-R	

Recordable disc

- We strongly recommend using any DVD-R 8x, MAXELL DVD-R 16x and DVD-RW 4x disc to assure good recording quality.
- Discs that tested and proven to be compatible with this recorder:
VERBATIM DVD-R 8x VERBATIM DVD-RW 2x
MAXELL DVD-R 16x JVC DVD-RW 4x
- About Video mode and VR (Video Recording) mode:**
Video mode is the same recording format as DVD-Video discs purchased locally and played back on most DVD players.
To play back the disc on other DVD players, you will need to finalize the disc (see page 36).
Before finalization, you can record additionally or edit disc with this unit.
VR (Video Recording) mode is a basic recording format for DVD-RW. You can edit, record and delete repeatedly.

DVD players with **RW COMPATIBLE** are capable of playing DVD-RW recorded in VR mode.

Disc type	Disc format	Functions
	Video mode 	Playing, limited recording, limited editing
DVD-RW	VR mode 	Playing, recording, Original/Playlist editing
	Video mode 	Playing, limited recording, limited editing
DVD-R		

Recording speed

You can select a recording speed among 6 options, and the recording time will depend on the recording speed you select as follows.

* **Discs recorded in SLP or SEP on this recorder may not be played back on other DVD recorders or DVD players.**

Disc Size	Recording speed	Recording time	Video/Sound Quality
8cm Disc	XP (1H)	18 min	☆☆☆☆☆☆
	SP (2H)	36 min	☆☆☆☆☆
	LP (4H)	72 min	☆☆☆☆
	EP (6H)	108 min	☆☆☆
	SLP (8H)	144 min	☆☆
	SEP (10H)	180 min	☆
12cm Disc	XP (1H)	60 min	☆☆☆☆☆☆
	SP (2H)	120 min	☆☆☆☆☆
	LP (4H)	240 min	☆☆☆☆
	EP (6H)	360 min	☆☆☆
	SLP (8H)	480 min	☆☆
	SEP (10H)	600 min	☆

- The recording time are estimates and actual recording time may differ.
- The audio and video quality is getting poorer as the recording time becomes longer.
- Each time [REC SPEED] is pressed, recording speed and its allowed recording time will be displayed.

Note

- This recorder cannot record on CD-RW or CD-R discs.**
- DVD-RW/R and CD-RW/R discs recorded on a personal computer or a DVD or CD recorder may not be played back if the disc is damaged or dirty or if there is dirt of condensation on the player's lens.
- If you record on a disc using a personal computer, there are cases in which it may not be played back because of the settings of the application software used to create the disc, even if it is recorded in a compatible format. (Check with the software publisher for more detailed information.)
- Discs recorded in Video mode on this unit cannot record additionally using other DVD recorders.
- A DVD-RW disc formatted with this unit cannot be used on other DVD recorders.
- Since the recording is made by the variable bit rate (VBR) method, the actual remaining time for recording may be a little bit shorter than the remaining time displayed on the OSD, depending on the picture you are recording.

Recording

Information on DVD recording (cont'd)

Restrictions on recording

You cannot record copy-protected materials using this unit. Copy-protected material includes DVD-Video discs and some satellite broadcasts.

If copy-protected material is encountered during a recording, recording will be paused or stop automatically and an error message will be displayed on the screen.

Material that is “copy-once only” can only be recorded using a DVD-RW disc in VR mode with CPRM (see below).

When recording a TV broadcast or through an external input, you can display copy control information on the screen.

What is “CPRM”?

This is a format used to record copy-once programs. By recording coded data on the area of DVD discs that ordinary writing software cannot write, it prevents copy-once programs from being recorded repeatedly on different media.

This unit is CPRM compatible, which means that you can record copy-once broadcast programs, but then you cannot make a copy of those recordings. CPRM recordings can only be made on DVD-RW discs formatted in VR mode, and CPRM recordings can only be played back on DVD players that are compatible with CPRM.

Making discs playable on other DVD player (Finalize)

After recording, you must finalize the disc in order to play on other units. (Refer to page 36.)

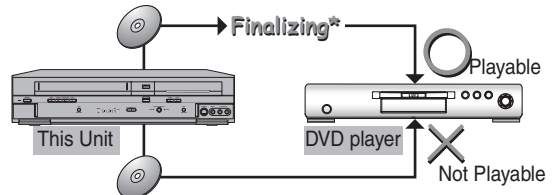

* You cannot finalize discs in other DVD recorders.

After finalizing:

- Once DVD-RW/R (Video mode) is finalized, you cannot record additionally or edit.
- DVD-RW disc recorded with VR mode can record additionally and edit contents even after you finalized the disc.
- When DVD-RW/R (Video mode) is finalized, the Title menu will be created automatically.

Finalize discs recorded on this unit in order to play them back on other DVD players.

Information on copy control

Some satellite broadcasts include copy-protected information. For their recording, refer to the following.

Disc type / format	Copy-free	Copy-once	Copy-prohibited
VR DVD-RW ver.1.1,1.2 ver.1.1,1.2 CPRM compatible	☆	—	—
	☆	☆	—
Video DVD-RW ver.1.1,1.2 ver.1.1,1.2 CPRM compatible	☆	—	—
	☆	—	—
DVD-R ver.2.0	☆	—	—

☆ Recordable

— Not Recordable

Recording

Formatting a disc

Choosing the recording format of a blank disc



When inserting a blank disc, the unit automatically starts to initialize the blank disc. You have to select your desired format before inserting the blank disc.

1

Press [SETUP].

2

Using [▲ / ▼], select “Disc”. Press [ENTER].

Disc menu will appear.
<VR mode>

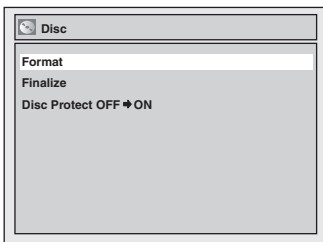

3

Using [▲ / ▼], select “Format”. Press [ENTER].

Format menu will appear.

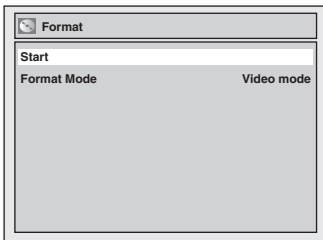

4

Using [▲ / ▼], select “Format Mode”. Press [ENTER].

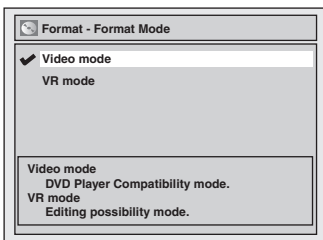

“Video mode” has been selected as the default.

5

Using [▲ / ▼], select “Video mode” or “VR mode”. Press [ENTER].

The recording format will be set.

6

Press [SETUP] to exit.

7

Insert a blank disc. Formatting will start.

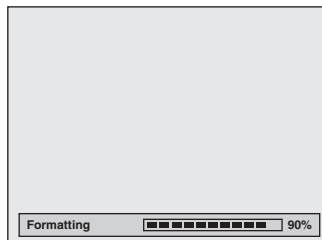

8

Formatting is completed. “100%” will be indicated.

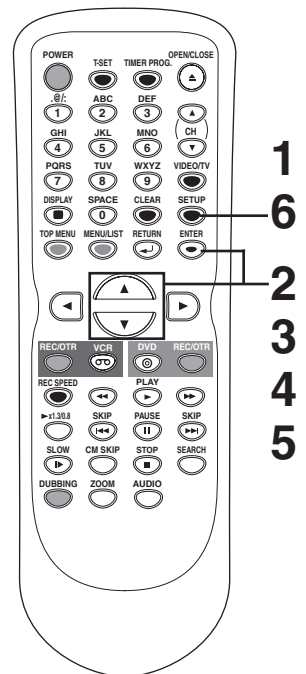

Note

- The recording format setting is effective only for DVD-RW discs. You cannot change the recording format for a DVD-R disc. DVD-R discs will always be in Video mode.
- **You cannot mix two formats on one DVD-RW disc. When you load a disc once recorded before, the recording format cannot be changed even if you change it in the Setup menu.**
- When inserting a blank DVD+RW or DVD+R disc, the error message (“Disc Error”) will appear. You cannot record on a DVD+RW/R. On this unit, DVD+RW and DVD+R are for playback only.
- Playlist will be created automatically when recording on DVD-RW in VR mode.
- In Video mode, Auto Chapter may not show up as you specified.
- A blank chapter may be created depending on the remaining time of the disc.

Recording

Formatting a disc (cont'd)

Reformatting a disc



Video mode is the default recording format for DVD-RW. You can change it to VR mode from the Setup Menu.

1
Press [SETUP].

2
Using [▲ / ▼], select "Disc".
Press [ENTER].
Disc menu will appear.

3
Using [▲ / ▼], select "Format".
Press [ENTER].
Format menu will appear.

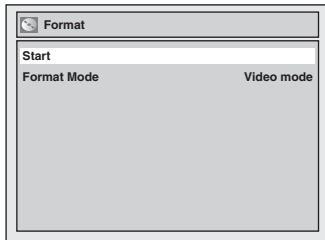

4
Using [▲ / ▼], select "Start".
Press [ENTER].
Final confirmation window will appear.

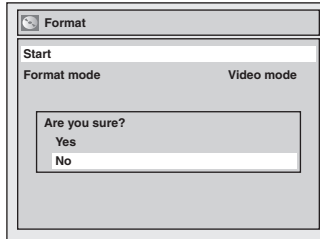

5
Using [▲ / ▼], select "Yes".
Press [ENTER].
Formatting will start.



6
Formatting is completed.
100% will be indicated.



This operation may take a while to be completed.

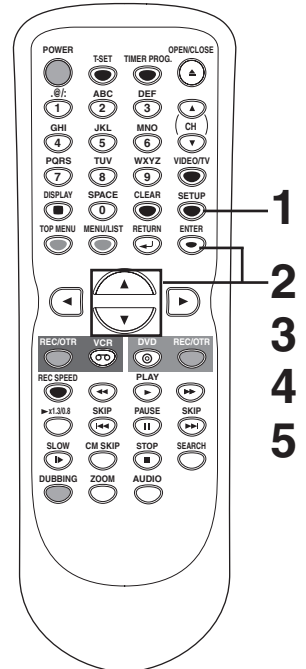

Note

- When you reformat the disc, all contents of the disc will be erased.
- If you want to cancel formatting at step 5, select "No".
- A disc once formatted with this unit cannot be used on other DVD recorders.

Setting for Auto Chapter



You can set a specified time for chapter marks.

1
Press [SETUP].

2
Using [▲ / ▼], select "Recording". Press [ENTER].

3
Using [▲ / ▼], select "Auto Chapter". Press [ENTER].

Option window will appear.

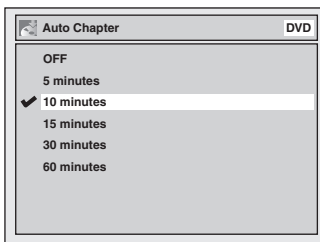

"10 minutes" has been selected as the default.

4
Using [▲ / ▼], select a desired time option. Press [ENTER].

5
Press [SETUP] to exit.

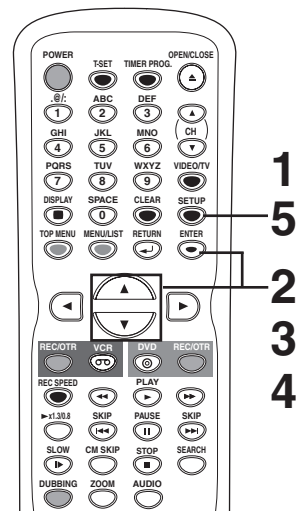

Recording

Basic recording



Follow steps below to record TV programs.

1

Press **[POWER]**. Press **[DVDⓄ]**. Turn on the TV and be sure to select the input to which the unit is connected.

2

Press **[OPEN/CLOSE ▲]**. The disc tray will open.

3

Insert your disc with its label facing up. Align the disc to the disc tray guide.

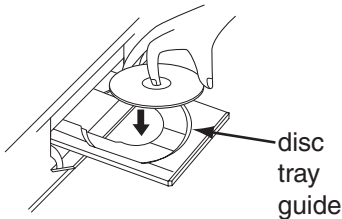

4

Press **[OPEN/CLOSE ▲]** to close the disc tray.

This operation may take a while to be recognized.

5

Using **[REC SPEED]**, select a recording speed.



Refer to "Recording speed" on page 25.

6

Using **[CH ▲ / ▼]** or the Number buttons, select a desired channel to record.



7

Press **[REC/OTR] (DVD)** to start recording.

"●" mark will be displayed for 5 seconds.



Press **[PAUSE II]** to resume. Press **[PAUSE II]** or **[REC/OTR] (DVD)** again to start recording again.

8

Press **[STOP ■]** to stop recording.

This operation may take a while to be completed.

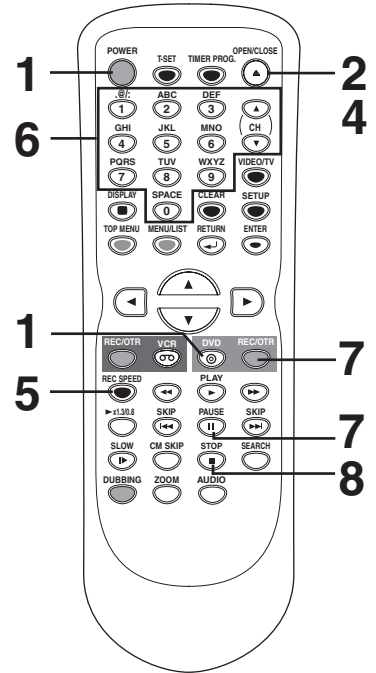

Note

- Recording starts immediately after you press **[REC/OTR] (DVD)** and continues until the disc is full or you stop recording.
- When the clock setting has not been made, the space for a date and time of title names in the Original list or Playlist will be blank.
- When you record a TV program broadcasted in both Stereo and SAP-audio on a DVD-RW/R, you have to select the TV channel audio (Stereo or SAP) beforehand. Only the selected channel audio will be recorded. Refer to "Selecting the TV stereo or SAP" on page 21 for more details.
- You cannot change the recording speed during the REC pause mode.
- You can change channels during the REC pause mode.

Recording

One-touch Timer Recording



This is a simple way to set the recording time in blocks of 30 minutes. Check that the disc has enough space for the time you set. After finishing the recording, the recorder automatically goes into standby.

First:

1

Turn on the unit and load a recordable disc.

Make sure that the TV input is set on the unit.

This operation may take a while to be recognized.

2

Using [REC SPEED], select a recording speed.

Refer to "Recording speed" on page 25.

3

Using [CH ▲ / ▼] or the Number buttons, select a desired channel to record.

4

Press [REC/OTR] (DVD) repeatedly to select desired recording time.

Recording times appear on the TV screen (30 minutes to 8 hours). Recording will start.

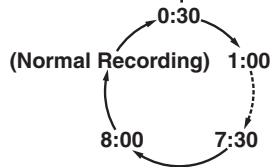

When the unit reaches the specified time, it will be turned off automatically.

To change the recording length during the One-touch Timer Recording, press [REC/OTR] (DVD) repeatedly until the desired length appear.

To cancel the One-touch Timer Recording within the specified time, press [STOP ■] .

This operation may take a while to be completed.

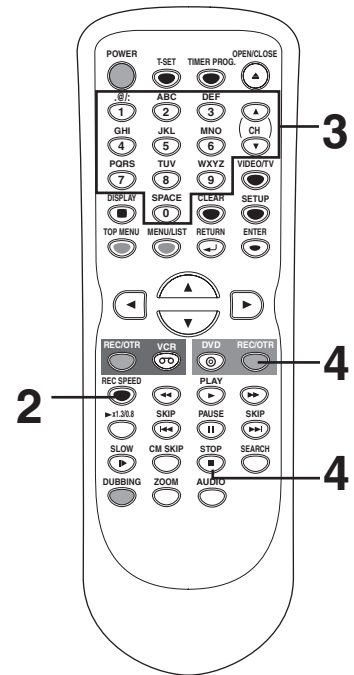

Note

- The remaining recording time will appear on the display panel during an One-touch Timer Recording. Press [DISPLAY] to see it on the TV screen.
- You cannot pause a One-touch Timer Recording.
- Unlike a Timer Recording, you can perform the following operations during a One-touch Timer Recording.
 - Turning off the power
 - Using [REC/OTR] (DVD) and [STOP ■]
- The unit will be turned off automatically under the following conditions.
 - 1) No space remained on the disc
 - 2) When a power failure occurs
- If OTR is finished in DVD during playback or REC mode in VCR, the DVD will be in STOP mode and the VCR keeps the current mode.
- When OTR is finished and the power is turned off, the unit will switch to the standby mode automatically if a Timer Recording has been programmed. Press [T-SET] to cancel the standby mode for using the unit continuously.

Recording

Timer Recording



You can program the unit to record up to 8 programs within a month in advance. Daily or weekly program recordings are also available.

- Be sure to set the clock before programming a timer recording.
- Insert a recordable disc or a videotape with a record tab.

1

Press [TIMER PROG.].

Timer Programming list will appear.

Timer Programming							VCR DVD
Date	Start	End	CH			Speed	
1. ---							
2. ---							
3. ---							
4. ---							

2

Using [▲ / ▼], select a program number. Press [ENTER].

3

Using [▲ / ▼], enter the Date. Press [▶].

Timer Programming							VCR DVD
Date	Start	End	CH			Speed	
1. JAN/01	--:--	--:--	L1	DVD			
2. ---							
3. ---							
4. ---							

When pressing [▼] at the current date, The Date will change as follows.

e.g. January 1st

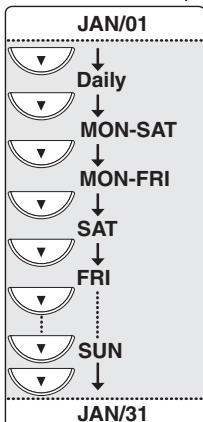

4

Using [▲ / ▼], enter the Start and End. Press [▶].

Timer Programming							VCR DVD
Date	Start	End	CH			Speed	
1. JAN/01	12:57AM	--:--	L1	DVD			
2. ---							

5

Using [▲ / ▼], select the channel number to record. Press [▶].

Timer Programming							VCR DVD
Date	Start	End	CH			Speed	
1. JAN/01	12:57AM	1:57AM	8	DVD			
2. ---							

To record from external input, select L1 or L2.

6

Using [▲ / ▼], select a recording media. Press [▶].

Timer Programming							VCR DVD
Date	Start	End	CH			Speed	
1. JAN/01	12:57AM	1:57AM	8	DVD			
2. ---							

- To record on a videotape, select VCR.
- To record on a disc, select DVD.

7

Using [▲ / ▼], select a recording speed.

Timer Programming							VCR DVD
Date	Start	End	CH			Speed	
1. JAN/01	12:57AM	1:57AM	8	DVD	1H		
2. ---							

Refer to "Recording speed" on page 25 for DVD or page 75 for VCR.

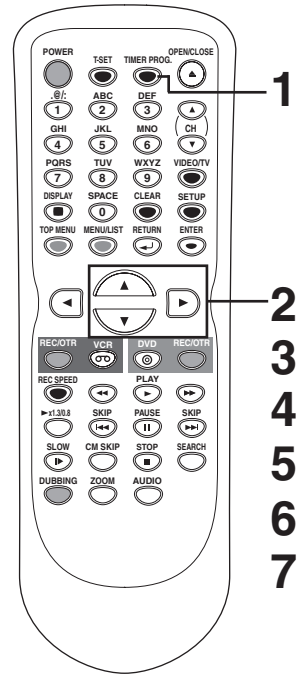

Note

- **If you have not set the clock yet:** A clock setting window will appear instead of the Timer Programming list at step 1. Continue with step 2 in "Auto Clock Setting" on page 22 or "Manual Clock Setting" on page 23 before setting a timer programming.
- Press [◀ / ▶] to move the cursor to the left and the right on the Timer Programming list.
- After step 9, you can use the other component (VCR or DVD) which is not currently programmed by turning the power on. Note that the programmed device will start to capture the selected channel 2 minutes before the start time and at the moment, if the other device still stays in recording, recording pause or OTR mode turning a different channel, the current mode will be canceled and you cannot change the channel. When both devices capture the same channel, the current mode continues to function.

Recording

Timer Recording (cont'd)

8

Press [ENTER] when information is entered.

Your program setting will be stored.

- To set another program, repeat steps 2 to 8.
- To exit, press [TIMER PROG.] or [SETUP].
- When programs are overlapped, "Overlap" and the overlapped program numbers will appear on the TV screen.

Checking, canceling, or correcting the timer programming information

1

Press [T-SET].

ⓐ disappears from the front panel display.

2

Press [TIMER PROG.].

Timer Programming list will appear.

Timer Programming						VCR DVD
Date	Start	End	CH	ⓐ	Speed	
1. JAN/01	12:57AM	1:57AM	8	DVD	1H	
2.	---					

3

Check the information on the list you will need.

9

Press [T-SET] to set a Timer Programming.

- ⓐ will appear on the front panel display.



- "VCR" will appear if VCR Timer Recording have been set.

4

To clear the timer programming: Using [▲ / ▼], select your program. Press [CLEAR].

To correct the timer programming:

Using [▲ / ▼], select the program. Press [ENTER].

Next, correct the timer programming using [▲ / ▼ / ◀ / ▶].

Finally, press [ENTER] again.

5

Press [TIMER PROG.] to exit.

6

Press [T-SET] to return to the timer standby mode.

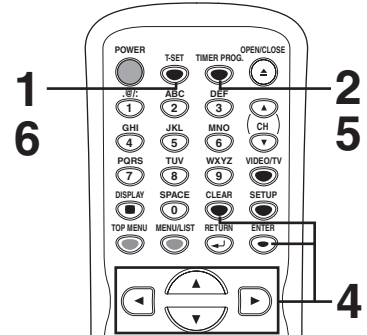
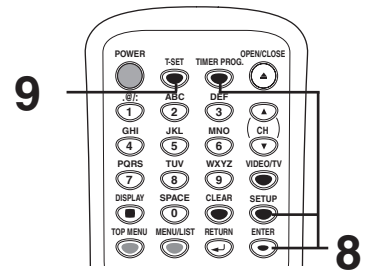

Note

- Press [TIMER PROG.] to check the timer programming in waiting.
- When the Timer Recording is in progress, that program will be highlighted in red.
- While using the side of the unit that is free from Timer Recording (either DVD or VCR) during timer standby mode, no programs will be highlighted even if you press [TIMER PROG.] to confirm the program information. In this case, you cannot select other program either for correction or add any new programs.
- The unit will be turned on automatically before the recording time.

To stop the Timer Recording in process

Press [STOP ■] to stop the disc recording or [STOP ■ / EJECT ▲] to stop the videotape recording on the front panel of the main unit. [STOP ■] on the remote control is not effective.

If the timer program did not complete correctly, the error number appears in the Timer Programming list.

Timer Programming						VCR DVD
Date	Start	End	CH	ⓐ	Speed	
* JAN/01	12:57AM	1:57AM	8	DVD	E22	
2.	---					
3.	---					
4.	---					
5.	---					
6.	---					
7.	---					
8.	---					

Press [CLEAR] to erase the selected program.

Each error number means:

E1-22 E37-39	Recording error other than below	E35	PCA full
E23-24	Unrecordable disc	E36	Already finalized Video format disc
E25-28	Copy prohibited program	E40	Some portion has not been recorded because of program overlapping. Recording did not start at the start time.
E29	Disc protected		
E30	Disc full		
E31-32	Already 99 titles recorded	E41	Power failed
E33	Already 999 chapters recorded	E42	No disc when recording
E34	No space for Control information		

- A program with the error number is grayed out and asterisked on the Timer Programming list.
- Once the Timer Programming list with error indication is displayed, the program line(s) with error will be cleared only after the programs are cancelled and reset to the timer standby mode.

Recording

Timer Recording (cont'd)

Hints for Timer Recording

- If there is a power failure or this unit has been unplugged for more than 30 seconds, the clock setting and all timer settings will be lost.
- If a recordable disc is not on the tray or an unrecordable disc is on the tray, the DVD indicator on the front panel flashes and Timer recording cannot be performed. In some cases, the DVD indicator appears momentarily around the Timer starting time as the unit attempts to record. Please insert a recordable disc.
- If a videotape with a record tab is not in the cassette compartment or there is no videotape in the compartment, the VCR indicator on the front panel flashes and timer recording cannot be performed. Please insert a recordable videotape.
- If you press **[POWER]** and turn on the unit while either DVD or VCR is in timer standby mode, **[RECORD]** disappears. In this case, you cannot change the mode between DVD and VCR. You cannot change any settings using **[SETUP]** or edit discs.
- After step 9 on page 32, you can turn on the power to use the side of the unit that is free from Timer Recording (either DVD or VCR) for another recording by pressing **[POWER]** during timer standby. During Timer Recording, press **[OUTPUT SELECT]** on the front panel, or **[DVD@]** or **[VCR∞]** on the remote control. Note that you cannot change channels after Timer Recording started. You can use all recording/recording pause/OTR functions. However, the unit will begin receiving channel signals for Timer Recording 2 minutes before the programmed starting time. Unless the program that you are currently recording using the Timer Recording free side of the unit is on the same channel with the one programmed for Timer Recording, the unit prioritizes Timer Recording and the current recording will be automatically stopped. If the channels set for Timer recording and the current recording are same, the current recording will continue without interruption.
- If both DVD and VCR are timer programmed, you cannot use any functions for either unit during timer standby or Timer Recording. If you want to use functions other than recording under such condition, cancel Timer Recording by pressing **[T-SET]** during timer standby or stop recording by pressing **[STOP]** on the front panel during Timer Recording.
- When the starting and ending time are same, the recording will be set for 24 hours. When the disc reaches the end during the recording, the unit turns itself off. If you want to continue the recording, cancel timer standby by pressing **[T-SET]**, insert a new disc, and then press **[T-SET]** again. If you are recording on a tape, the unit automatically ejects the tape when it reaches the end. You can continue the recording by inserting a new tape.
- When the programmed starting and ending time are earlier than the current time, the setting will not be accepted and be cleared for redoing.
- If the starting time is earlier and the ending time is later than the current time, the recording will start right after you press **[T-SET]**.
- The Timer Recording cannot be performed in DVD and VCR at the same time. If you set two programming with the same channel and time in both units, the program with a lower program number will be recorded.

The priority of overlapped settings

This unit prioritize recording as follows if the timer programmings are overlapped.

A Timer Recording of lower priority will be canceled, start from the middle or stop on the way.

Check the overlapped timer programmings and change the priority if necessary.

A programming with a lower program number has priority

When the starting time is same:

A program with a lower program number (PROG. 1) has priority.

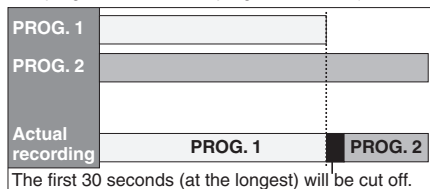

When the recording time is partially overlapped:
PROG. 1 will start after PROG. 2 recording is completed.

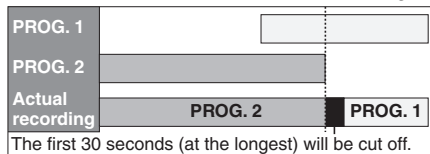

When some programming have been made around the end time of the program currently being recorded:

A program with a lower program number (PROG. 2) has priority.

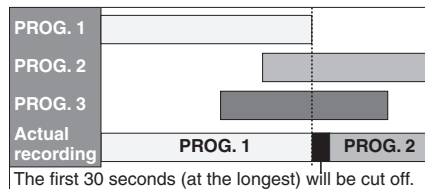

When the recording time is entirely overlapped:
PROG.1 will not be recorded at all.

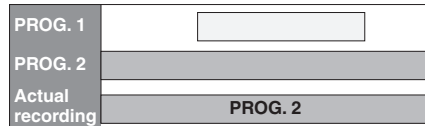

Note for DVD recording

- When the recording time of two programs are overlapped, or the End time of a program and the Start time of another are the same, the first 30 seconds (at the longest) of the subsequent program will be cut off.
- If the cut-off portion reaches one minute or more, this program will be displayed with error number E40 on the timer programming list.

When the End time of the programming currently being recorded and the Start time of the subsequent program are same:

If PROG. 1 is recorded on a DVD, the beginning of the PROG. 2 may be cut off. The amount of time cut off differs depending on the recording media. For example, if both PROG. 1 and PROG. 2 are recorded on DVD, the first 30 seconds (at the longest) of PROG. 2 will be cut off.

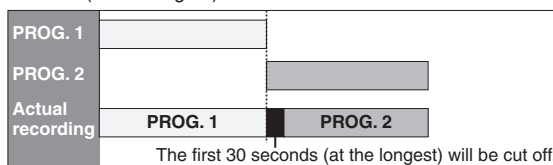

Recording

Settings for an external source

Connection to an external source



Connect the external source properly to the unit by using input jacks either LINE2 (Front) or LINE1 (Rear). When connecting an external equipment of monaural output to this unit, use AUDIO L jack of LINE 1 (Rear) or LINE 2 (Front).

Use commercially available S-Video or Video cable and an Audio cable for this type of connection.

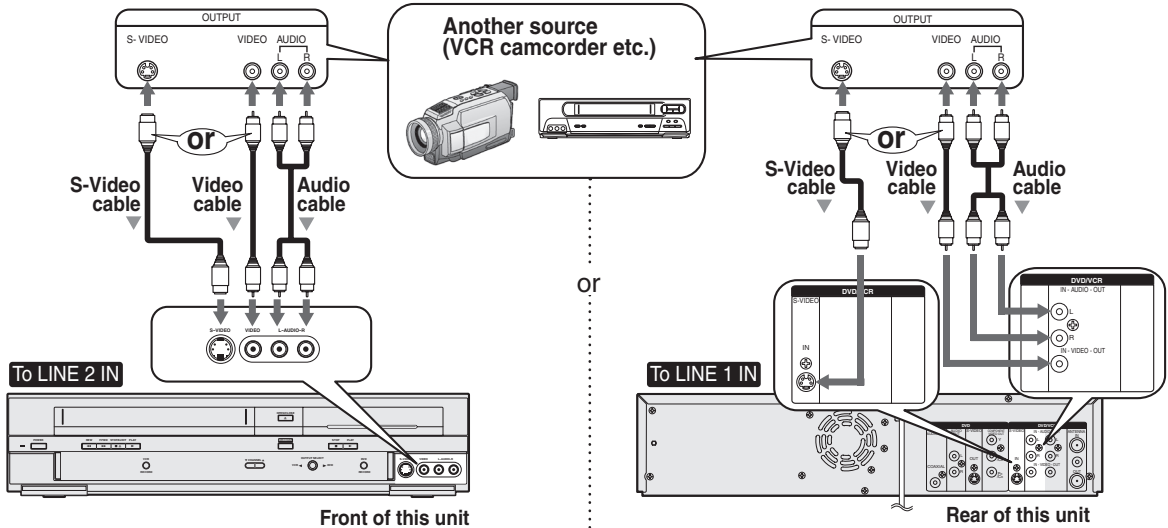

1. Press [SETUP].

2. Using [▲ / ▼], select "Required Setting" and then "Select Video". Press [ENTER].

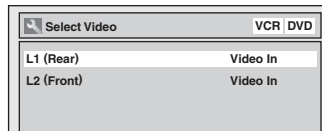

3. Using [▲ / ▼], select "L2 (Front)". Press [ENTER].

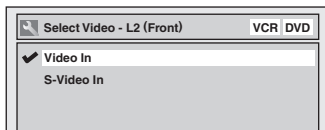

4. Using [▲ / ▼], select the input jack type to connect. Press [ENTER].

If you want to use S-VIDEO input jack, select "S-Video In".

If you want to use VIDEO input (Composite) jack, select "Video In".

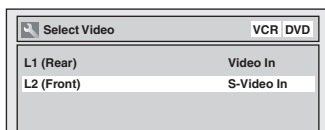

5. Press [SETUP] to exit.

3. Using [▲ / ▼], select "L1 (Rear)". Press [ENTER].

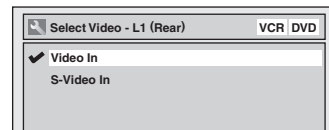

4. Using [▲ / ▼], select the input jack type to connect. Press [ENTER].

If you want to use S-VIDEO IN jack, select "S-Video In".

If you want to use VIDEO IN (Composite) jack, select "Video In".

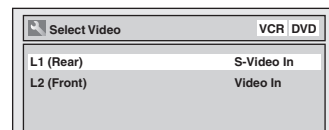

5. Press [SETUP] to exit.

Recording

Settings for an external source (cont'd)

Recording from an external source



Before recording from an external source, see the instructions for the connection on page 34.

1. Turn on the TV and this unit and be sure to select the input of the TV to which the unit is connected.

Refer to the table on page 15.

2. When you want to record to the disc: Press:

Press [OPEN/CLOSE ▲] to open the disc tray. Place the disc to record properly.

3. Press [OPEN/CLOSE ▲] to close the disc tray.

This operation may take a while to be recognized.

When you want to record to a videotape: Press:

Insert the videotape with a record tab into the cassette compartment.

4. Select the input of the unit which the external equipment is connected. (L2 or L1)

- To use the input jacks on the back of this unit, select "L1" position by pressing [0], [0], [1] on the remote control or [CHANNEL ▼ / ▲].

- To use the input jacks on the front of this unit, select "L2" position by pressing [0], [0], [2] on the remote control or [CHANNEL ▼ / ▲].

5. Select a recording speed by pressing [REC SPEED].

Refer to "Recording speed" on page 25 for DVD or page 75 for VCR.

6. Press [VCR/DVD RECORD] on the unit to start recording.

7. Press "Play" on the external source to record from.

8. For disc:

Press [STOP ■] on the unit to stop recording.

This operation may take a while to be completed.

For videotape:

Press [STOP ■ / EJECT ▲] on the unit to stop recording.

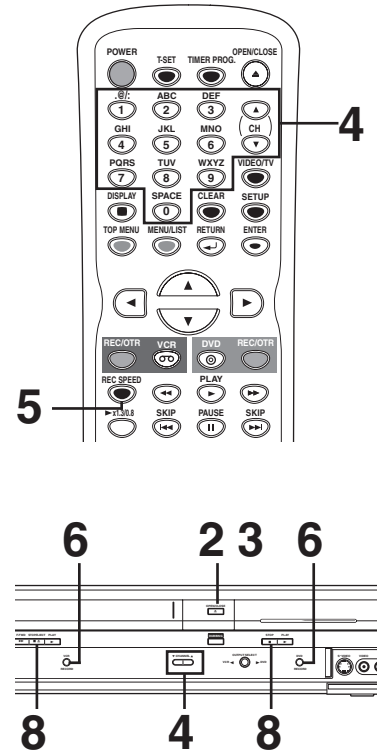

Setting a disc to protect



To prevent accidental recording, editing or erasing of the titles, you can protect them from the Setup menu.

1

Press [SETUP].

2

Using [▲ / ▼], select "Disc". Press [ENTER].

Disc menu will appear.

3

Using [▲ / ▼], select "Disc Protect OFF → ON". Press [ENTER].

Confirmation window will appear.

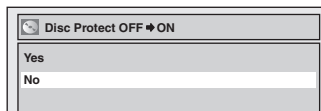

4

Using [▲ / ▼], select "Yes". Press [ENTER].

A disc will be protected.

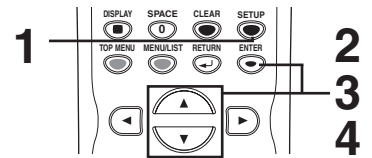

Note

- The Disc Protect setting is available only for a DVD-RW disc recorded in VR mode.
- You can select only Disc Protect OFF when a protected disc is inserted.

To cancel the disc protect:

- When you insert a disc protected in this unit, "Disc Protect ON → OFF" will appear.

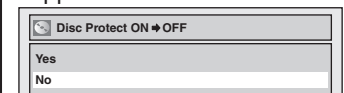

To cancel the protection setting for the disc, select "Disc Protect ON → OFF" at step 3, then select "Yes".

Recording

Finalizing the discs



You will need to finalize discs recorded in Video mode to play them back on other DVD players. Finalizing may take several minutes up to an hour. (It can take up to 15 minutes for a disc recorded in Video mode and 60 minutes for a disc recorded in VR mode.)

A shorter recording period on the disc will require a longer time period for finalization. Do not unplug the power cord during finalization.

Details are on pages 25-26.

1

Press [SETUP].

2

Using [▲ / ▼], select "Disc". Press [ENTER].

Disc menu will appear.

3

Using [▲ / ▼], select "Finalize". Press [ENTER].

Confirmation window will appear.

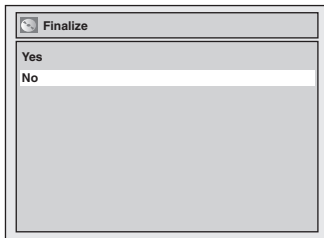

4

Using [▲ / ▼], select "Yes". Press [ENTER].

Finalizing will start.



To cancel finalizing...

(DVD-RW only)

- To cancel finalizing at step 4, press [STOP ■], select "Yes" with [◀ / ▶], then press [ENTER]. Finalizing is cancelled and the unit will be in stop mode.

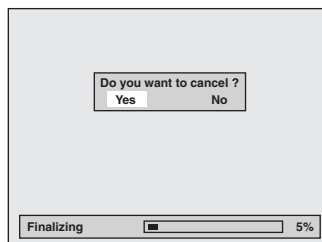

- If ⓪ appears when pressing [STOP ■], you cannot cancel finalizing because the finalizing has been in certain progress.
- When selecting "No" and press [ENTER] or [RETURN ↵], finalizing will be continued.
- You cannot cancel finalizing the DVD-R disc once it has started.

This operation may take a while to be completed.

5

Finalizing is completed.

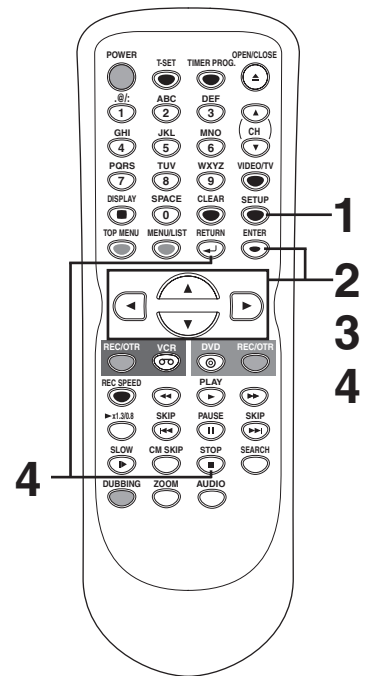
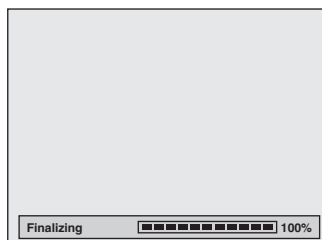

Note

- Finalizing discs in Video mode automatically creates title menus.
- Once you have finalized a disc recorded in Video mode, you cannot edit or record anything else on that disc. Discs recorded in VR mode can still be recorded and edited on this unit even after finalization.
- When you insert a DVD-RW disc finalized with this unit, "Undo Finalize" will appear instead of "Finalize".

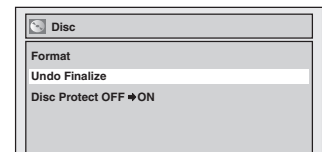

To reverse the finalization of the disc, select "Undo Finalize" at step 3.

- DO NOT power off during finalization. This will result in malfunction.

Recording

Finalizing the discs (cont'd)

Auto finalize



You can finalize discs automatically using Auto Finalize function. This function automatically finalizes discs after all Timer Recordings are completed and when the disc space runs out.

1

Press [SETUP].

2

Using [▲ / ▼], select "Recording". Press [ENTER]. Recording menu will appear.

3

Using [▲ / ▼], select "Auto Finalize". Press [ENTER]. Auto Finalize menu will appear.

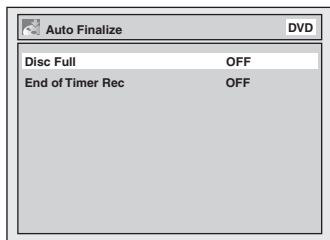

4

Using [▲ / ▼], select "Disc Full" or "End of Timer Rec". Press [ENTER].

Option window will appear.

<Example: Disc Full>

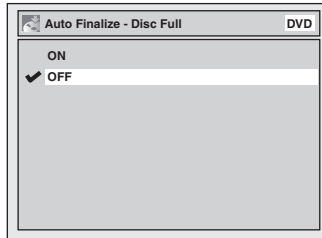

<Example: End of Timer Rec>

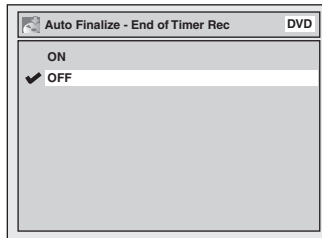

5

Using [▲ / ▼], select "ON". Press [ENTER].

Your setting will be activated.

6

Press [SETUP] to exit.

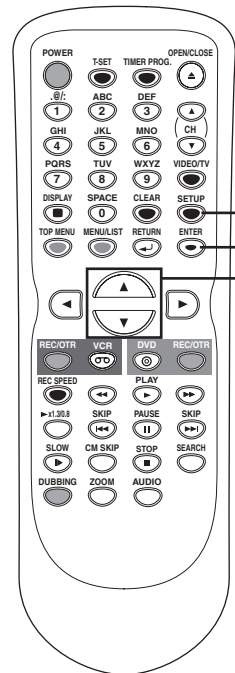

Before you start

Connections

Getting started

Recording

Playing discs

Editing

Changing the Setup menu

VCR functions

Others

Español

Note

- Auto Finalize function is not available for discs recorded in VR mode.

Recording

Dubbing Mode



You can copy a DVD disc to a videotape or copy a videotape to a DVD disc. This function will be possible only if the DVD disc or the videotape is not copy protected.

Before starting this function, prepare for the recording on the DVD-RW/R disc or the videotape. Refer to pages 29 and 75.

Make sure:

- Insert a recordable disc and a videotape with a record tab.

Note for recording to a videotape:

- The videotape's record tab is intact.
- The remaining time of the videotape is long enough.

Note for recording to a disc:

- Make sure that the disc is recordable. Refer to pages 25 and 26.

3

Using [▲ / ▼], select “Dubbing Mode”. Press [ENTER].

Option window will appear.

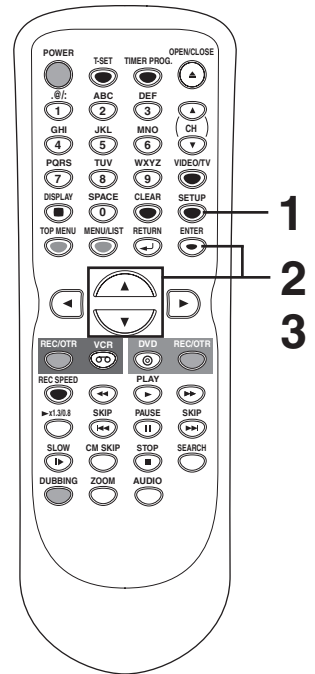
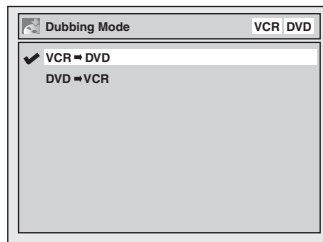

1

Press [SETUP].

2

Using [▲ / ▼], select “Recording”. Press [ENTER].

Recording menu will appear.

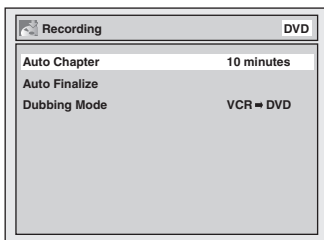

Note

For VCR to DVD duplication:

- After starting VCR to DVD duplication, the picture may be distorted because of the auto tracking function. This is not a malfunction. Be advised to playback the videotape until the picture is stabilized, then set the starting point which you wish to start recording, and start VCR to DVD duplication.

Recording

Dubbing Mode (cont'd)

VCR to DVD

4
Using [▲ / ▼], select
“VCR → DVD”. Press [ENTER].

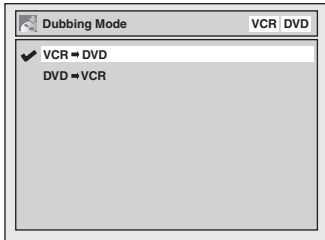

5
Press [SETUP] to exit.
Press:

Make sure to select a recording speed using [REC SPEED].

Press:

6
Press [PLAY ►]. Then press [PAUSE II] at the point you wish to start recording.

- Since it takes about a few seconds before the actual dubbing begins, please allow extra 5 seconds when selecting the starting point.

7
Press [DUBBING].
VCR to DVD duplication will start.

8
Press [STOP ■] to stop the recording.

DVD to VCR

4
Using [▲ / ▼], select
“DVD → VCR”. Press [ENTER].

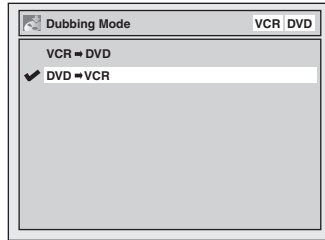

5
Press [SETUP] to exit.
Press:

Make sure to select a recording speed using [REC SPEED].

Press:

6
Press [PLAY ►]. Then press [PAUSE II] at the point you wish to start recording.

7
Press [DUBBING].
DVD to VCR duplication will start.

8
Press [STOP ■] to stop the recording.

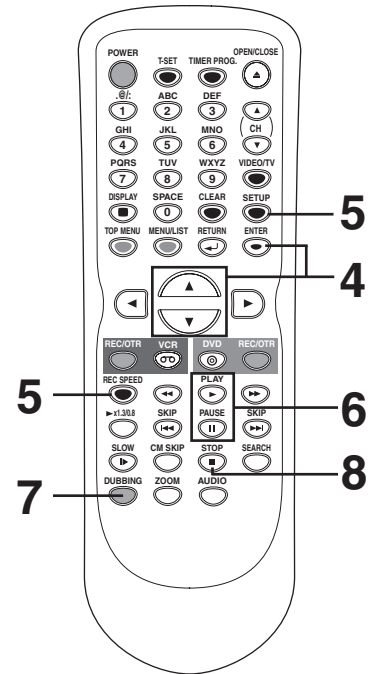

Note

- When you turn off the unit after setting the Dubbing Mode to **DVD → VCR**, the setting will be set to **VCR → DVD** automatically.
- Dubbing Mode is available only if the videotape or disc is not copy protected.
- You cannot change the output mode during VCR to DVD or DVD to VCR duplication.

For Audio CD to VCR duplication:

- This function is available on Audio CDs, not MP3 / WMA files.

For VCR to DVD duplication:

- The playback sound mode is followed by the setting of VCR playback sound mode on page 77. Set the playback sound mode to which you wish to record to the DVD.
- This unit will automatically stop the duplication if playback with no image is for more than 3 minutes during VCR to DVD duplication.



Playing discs

Information on DVD playback

Before you play DVD discs, read the following information.

Playable discs

This unit is compatible with the following discs. To play back a DVD, make sure that it meets the requirements for Region Codes and Color Systems as described below. Discs with the following logos can be played back on the unit. Other Disc types are not guaranteed to be played back.

Disc	Logo
DVD-VIDEO	
DVD-RW (VIDEO/VR mode)	
DVD-R (VIDEO mode)	
CD-DA (AUDIO CD)	
CD-RW (CD-DA FORMAT, MP3 / WMA files)	
CD-R (CD-DA FORMAT, MP3 / WMA files)	

 is a trademark of DVD Format/Logo Licensing Corporation.

Color systems

DVDs are recorded in different color systems throughout the world. The most common color system is NTSC (which are used primarily in the United States and Canada).

This unit uses NTSC, you must use DVDs recorded in the NTSC system. You cannot play back DVDs recorded in other color systems.

Region codes

This unit has been designed to play back DVD discs with Region One (1). DVDs must be labeled for ALL regions or for Region 1. You cannot play back DVDs labeled for other regions. Look for the symbols below on your DVDs. If these region symbols are not on your DVD, you cannot play back the DVD on this unit.



The number inside the globe refers to region of the world. A DVD labeled for a specific region can only be played back on the unit with the same region code.

Hint for DVD playback

The contents of DVD disc are generally divided into titles. Titles may be further subdivided into chapters.

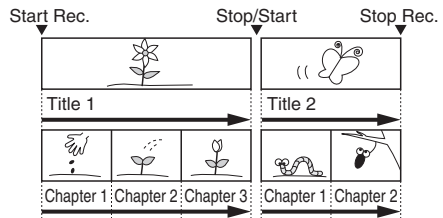

- Windows Media and the Windows logo are trademarks or registered trademarks of Microsoft Corporation in the United States and/or other countries.
- This unit is not compatible with Multiple Bit Rate (MBP: a file that contains the same content encoded at several different bit rates).

Playing discs

Basic playback

Playback



1
Press [POWER]. Press [DVDⓄ].
Turn on the TV and be sure to select the input to which the unit is connected.

2
Press [OPEN/CLOSE ▲].
The disc tray will open.

3
Insert your disc with its label facing up. Align the disc to the disc tray guide.

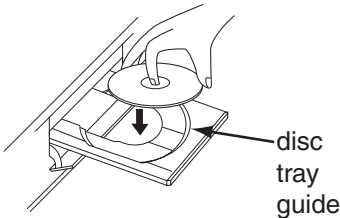

4
Press [OPEN/CLOSE ▲] to close the disc tray.

This operation may take a while to be recognized.

5
Press [TOP MENU] to display the Title menu.
You can change "Original" or "Playlist" of VR mode using [MENU / LIST].

<Video mode>

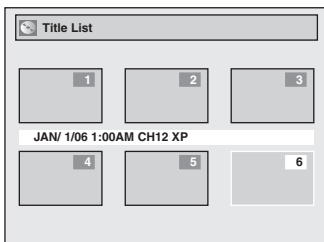

<VR mode>

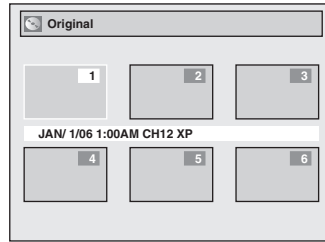

[MENU / LIST]

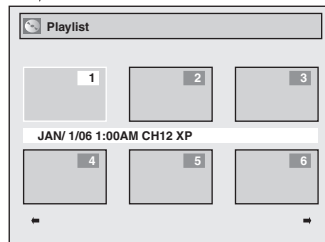

To exit the title menu, press [STOP ■] or [RETURN ↵].

6
Using [▲ / ▼ / ◀ / ▶], select a desired title. Press [ENTER].
Option window will appear.

<Video mode>

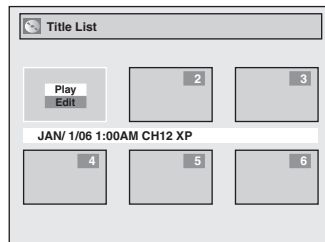

7
Using [▲ / ▼], select "Play". Press [ENTER].
Playback will start.

8
Press [STOP ■] to stop playback.

To eject the disc, press [OPEN/CLOSE ▲] to open the disc tray, then remove the disc before turning the unit off.

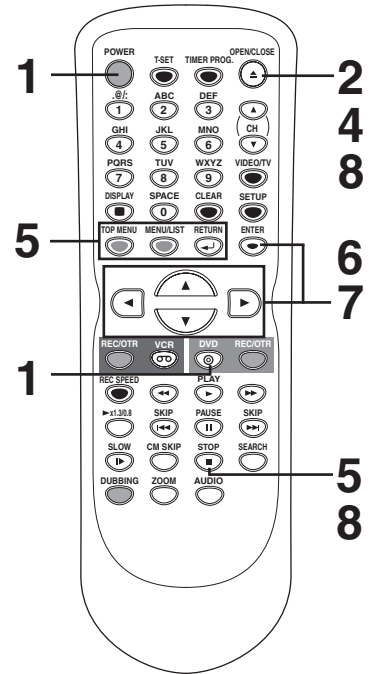

Note

- For DVD-R (Video mode) and DVD-RW (Video mode) discs which are already finalized, a title list will be displayed instead of thumbnails.

Title Menu	
1	JAN/22/06 12:55AM CH10 XP
2	JAN/30/06 11:00PM CH8 XP
3	FEB/10/06 9:00PM CH10 LP
4	FEB/28/06 11:00AM CH6 LP
5	FEB/28/06 10:00PM CH8 EP

- You can resume playback from the point you stopped playback. (Resume playback) Refer to page 44 for details about resume playback.
- Some discs may start playback automatically.
- You can also start playback by pressing [PLAY ▶] instead of [ENTER] at step 6.

Playing discs

Basic playback (cont'd)



1
Press [POWER]. Press [DVD]. Turn on the TV and be sure to select the input to which the unit is connected.

2
Press [OPEN/CLOSE ▲] to open the disc tray. The disc tray will open.

3
Insert your disc with its label facing up. Align the disc to the disc tray guide.

4
Press [PLAY ►] to start playback. Playback will start.

If you are playing back a DVD-Video disc, a menu may appear. Refer to page 43 for details about the Disc menu.

5
Press [STOP ■] to stop playback.

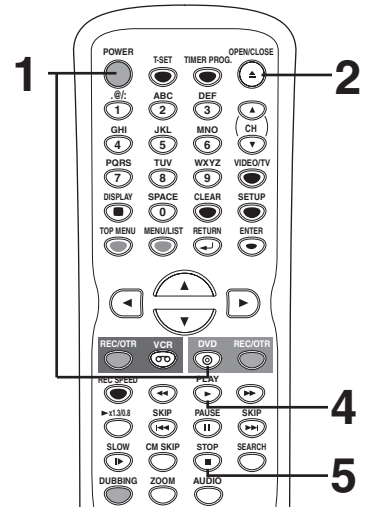

Note

- Some discs may start playback automatically.

Playing MP3 / WMA disc



First:

1
The MP3 / WMA menu will automatically appear on the TV screen after inserted the disc. In a case the MP3 / WMA menu does not appear on the TV screen, press [TOP MENU].

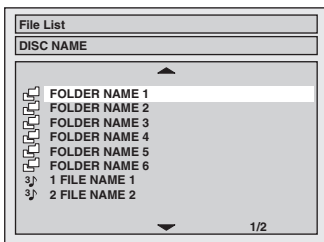

- To exit the menu, press [TOP MENU] again.

2
Using [▲ / ▼], select a desired folder (group) or track. Press [ENTER].

When selecting track:
Playback will start.

When selecting the folder:
The files in folder will appear. Press [▲ / ▼] to select the track or folder you want, then press [ENTER].

- Press [PLAY ►], [ENTER] or [►] to move to the lower hierarchies.
- Press [◀] or [RETURN ↵] to the previous hierarchy.

Hints for MP3 / WMA files:

- Folders are known as Groups, files are known as Tracks.
- Folders are accompanied by icon.
- MP3 files are accompanied by icon. Reproduction will start from the selected track and go to the next one in turn.
- WMA files are accompanied by icon. When pressing [DISPLAY] repeatedly during WMA playback, display menu, artist name, or title name will be displayed on the TV screen in order.

- The system can recognize up to 255 groups (or folders) and up to 999 tracks.
- The name of group and track can be displayed in up to 29 characters. Unrecognizable characters will be replaced with asterisks.
- If there are no files in the folder, "No Files" will be displayed.

This unit recommends the files recorded under the following circumstances:

- Sampling frequency: 44.1kHz or 48kHz.
- Constant bit rate: 112kbps - 320kbps.

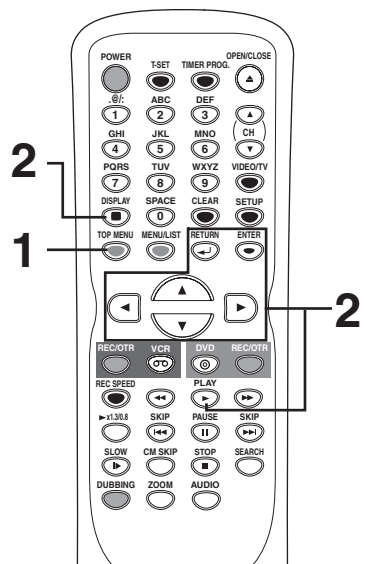

Note

- The audio source of MP3 / WMA files cannot be recorded as digital sound by an MD or DAT deck.
- Files whole extension other than ".mp3(MP3)" or ".wma(WMA)" will not appear in the MP3 / WMA menu.
- Some unplayable folders or tracks may appear in the MP3 / WMA menu due to the recording status.

Playing discs

Basic playback (cont'd)

Playing discs using the Disc menu



A DVD disc contains a Disc menu that describes the contents or allows you to customize the playback. For example, the menu may offer choices for subtitle languages, special features, or chapter selection. Some discs display them automatically when you start playback. For others, they only appear when you press [MENU / LIST].



1
Press [MENU / LIST].

The Disc menu will appear. If the feature is not available, may appear on the TV screen.

2
Using [▲ / ▼ / ◀ / ▶], select an item. Press [ENTER] to confirm. Continue this step to set up all the features you want or to start playing the disc from the menu.

MENU / LIST button:
Displays a DVD Disc menu. It may be the same with the 'Title menu.'

Cursor ▲ / ▼ / ◀ / ▶ buttons:
Moves the cursor on the screen.

ENTER button:
Selects the currently highlighted menu option.

Number buttons:
Selects a numbered menu option (some discs only). (Press [ENTER] after.)

3
Press [MENU / LIST] to exit the Disc menu.

Playing back discs using the Title menu



Some DVDs have a Title menu, which lists the titles available on them. It helps you to start playback at a specific title.



1
Press [TOP MENU].

The Title menu will appear. If the feature is not available, may appear on the TV screen.

2
Using [▲ / ▼ / ◀ / ▶], select a title to play. Press [ENTER]. Playback will begin at the title you selected.

Pause



1
During playback, press [PAUSE II].

TOP MENU button:
Displays the 'Title menu' of a DVD disc.

Cursor ▲ / ▼ / ◀ / ▶ buttons:
Moves the cursor on the screen.

ENTER button:
Selects the currently highlighted menu option.

Number buttons:
Selects a numbered menu option (some discs only). (Press [ENTER] after.)

3
Press [TOP MENU] to exit the Title menu.

Play will pause and sound will be muted.

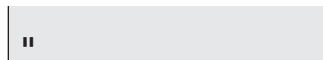

2
Press [PLAY ▶] to resume play.

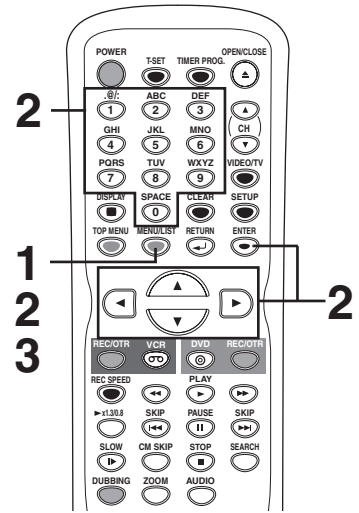

Note

- Menus vary among discs. Refer to the information accompanying the disc for details.

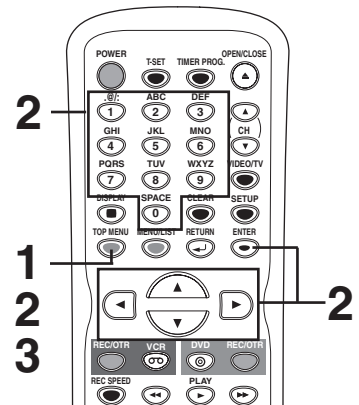

Note

- [TOP MENU] will not always be active with all DVDs.
- Menus vary among discs. Refer to the information accompanying the disc for details.

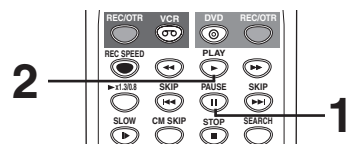

Note

- On DVDs, set "Still Mode" to "Field" in the Setup menu if pictures in the pause mode are blurred. (Refer to page 73.)

Playing discs

Special playback

Resume playback



You can resume playback from where you stopped it last time.

1

During playback, press [STOP ■]. The resume message will appear.

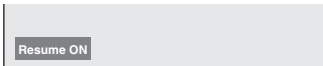

2

Press [PLAY ►].

Within a few seconds, playback will resume from the point at which it stopped last. You can resume playback at the same point even if you turn off the unit.

To cancel resuming and start disc playback from the beginning, press [STOP ■] again while the play is stopped.

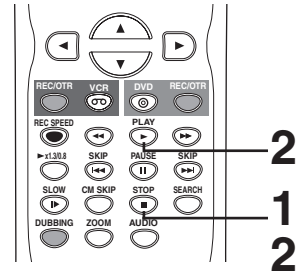

Note

- For MP3 / WMA files, playback will resume from the beginning of the track which you stopped playing back.

Fast forward / Fast reverse



1

During playback, press [FWD ►►] or [REV ◄◄].

Every time you press [FWD ►►] or [REV ◄◄], approximate speed will be changed as follows.

Fast forward or fast reverse playback across titles (for DVD discs) or tracks (for MP3 / WMA) is not possible.

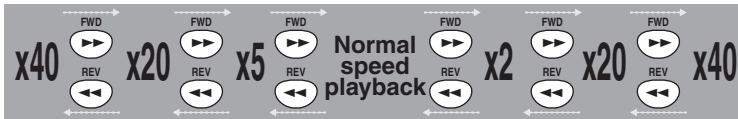

For Audio CDs, approximate speed is fixed at x8 with sound.
For MP3 / WMA files, approximate speed is fixed at x8 with sound.
To return to the normal play, press [PLAY ►].

Skipping TV commercials during playback



You can skip TV commercials by pressing [CM SKIP], in order to enjoy the recorded programs without interruption.

1

During playback, press [CM SKIP].

Normal play will start at 30 seconds ahead from the point you press [CM SKIP].

Every time you press [CM SKIP], the playback starting point will be extended by 30 seconds ahead.

You can press up to 6 times (180 seconds).

e.g. Press [CM SKIP] once.

(forwarding 30 seconds)

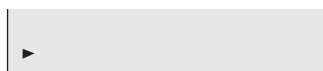
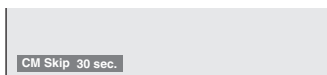

Playback will restart automatically.

Note

- Forward/reverse speed will be indicated with icons as follows.
Forward (Approx. Speed)
x2: [two right arrows]
x20: [twenty right arrows]
x40: [forty right arrows]
Reverse (Approx. Speed)
x5: [five left arrows]
x20: [twenty left arrows]
x40: [forty left arrows]

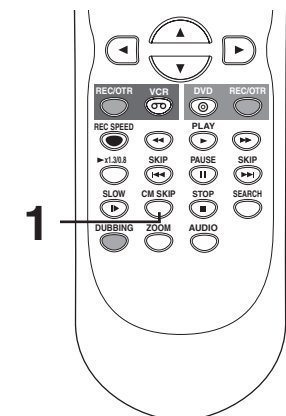

Playing discs

Special playback (cont'd)

Zoom



- 1** During playback, press [ZOOM]. Zoom menu will appear.

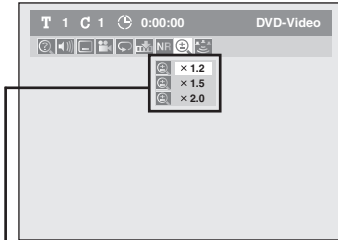

There are four options (x1.0, x1.2, x1.5 and x2.0), these are displayed excluding the current zoom rate.

- 2** Using [▲ / ▼], select a desired zoom factor to zoom. Press [ENTER]. The zoom area will be displayed.

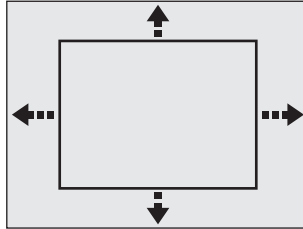

- 3** Using [▲ / ▼ / ◀ / ▶], select a desired zoom position. Press [ENTER]. The zoom play will start.

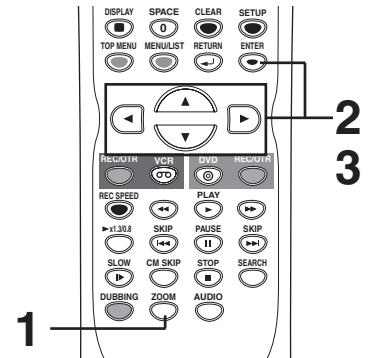

Note

- When selecting a smaller factor than the current one, the zoom area will not be displayed.
- To exit the zoom menu, press [ZOOM] again at step 1.
- To cancel the zoom function, select "x1.0" using [▲ / ▼], then press [ENTER].

Marker Setup



This feature allows you to assign a specific point on a disc to be called back later.

- 1** During playback, press [DISPLAY]. The display menu will appear.

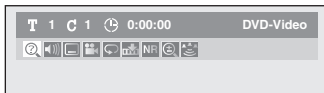

- 2** Using [◀ / ▶], select . Press [ENTER]. Marker Setup menu will appear.

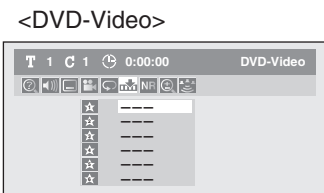

<Audio CD>

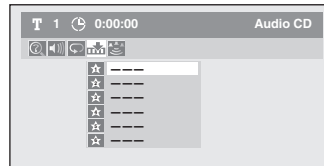

- 3** Using [▲ / ▼], select a desired marker number. When it reaches the desired point, press [ENTER]. The title (track) number and the time will be displayed.

- 4** To return to the marker later: Using [▲ / ▼], select the desired marker number. Press [ENTER].

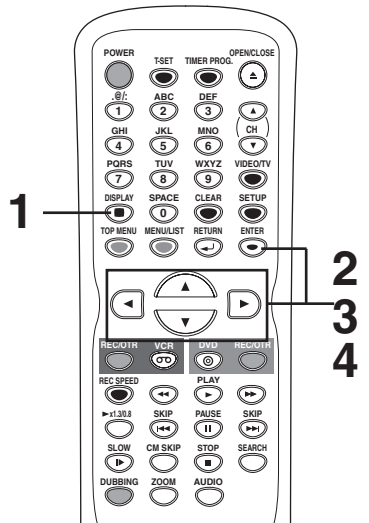

Note

- To clear a marker, select the marker number to be cleared, then press [CLEAR].
- All markers will be erased when you operate these operations listed below.
 - Opening the disc tray
 - Turning off the power
 - Recording to a recordable disc
 - Changing the mode between Original and Playlist (VR mode)
- You can mark up to 6 points.

Playing discs

Search

Title / Chapter search



Using [SKIP <<< / >>>]

1

During playback, press [SKIP >>>] to skip the current title or chapter and move to the next.

The title or chapter will move forward by one at a time.

- If there is no chapter in one title, the current title will be skipped.

To go back to the beginning of the current title or chapter, press [SKIP <<<].

Press it repeatedly to go to the previous title or chapters.

Using [DISPLAY]

1

During playback, press [DISPLAY].

The Display menu will appear.

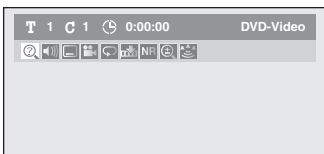

2

Using [◀ / ▶], select [?]. Press [ENTER].

The title number next to **T** will be highlighted.

Title:

Using [▲ / ▼] or the Number buttons, enter a desired title number to search. Press [ENTER].

Title search will start.

Chapter:

Press [▶] to move to the number next to **C** for chapter.

Using [▲ / ▼] or the Number buttons, enter a desired chapter number to search. Press [ENTER].

Chapter search will start.

Note

- In search mode display, total numbers of each search contents (title/chapter/time) are shown as a denominator.

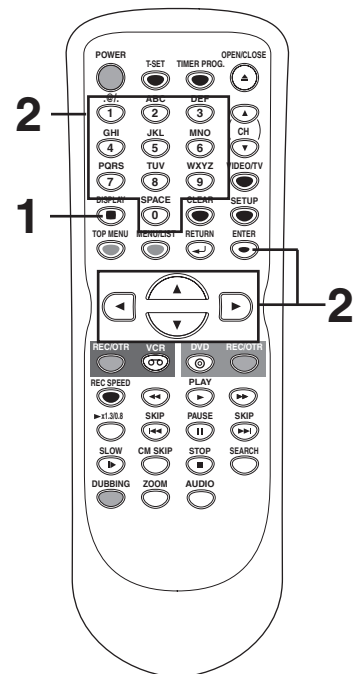
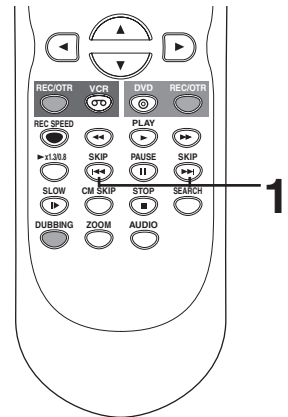
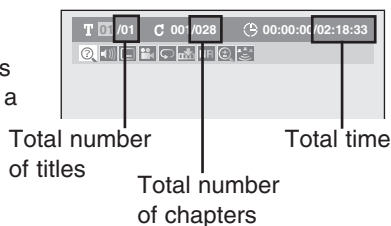

Before you start

Connections

Getting started

Recording

Playing discs

Editing

Changing the Setup menu

VCR functions

Others

Español

Playing discs

Search (cont'd)

Track search



Using [SKIP <<< / >>>]

1

During playback, press [SKIP >>>] to skip the current track and move to the next.

To go back to the beginning of the current track, press [SKIP <<<]. Press it repeatedly to go to the previous tracks.

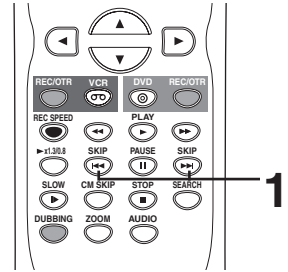

Using [DISPLAY]

1

During playback, press [DISPLAY].

The Display menu will appear.

<Audio CD>

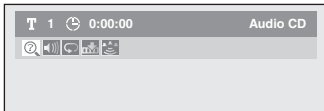

<MP3 / WMA files>

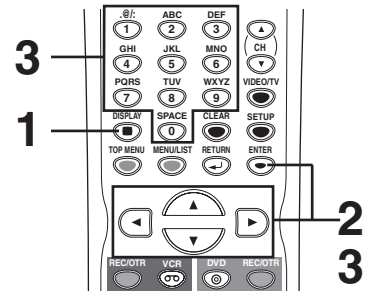
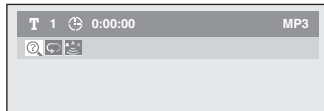

2

Using [◀ / ▶], select . Press [ENTER].

The track number next to **T** will be highlighted.

3

Using [▲ / ▼] or the Number buttons, enter a desired track number to search. Press [ENTER].

Track search will start.

Note

- During CD playback you can enter a track number directly using the **Number buttons** for track search without displaying the menu (except during random and program playback).

Time search



1

During playback, press [DISPLAY].

The display menu will appear.

<DVD-Video>

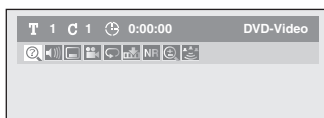

<Audio CD>

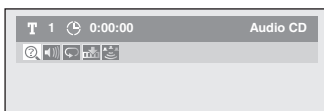

2

Using [◀ / ▶], select . Press [ENTER].

The number next to **T** will be highlighted.

To move to the clock icon , press [▶].

When time search is not available, and time count are not displayed.

3

Using [▲ / ▼] or the Number buttons, enter a desired time to search. Press [ENTER].

Time search will start.

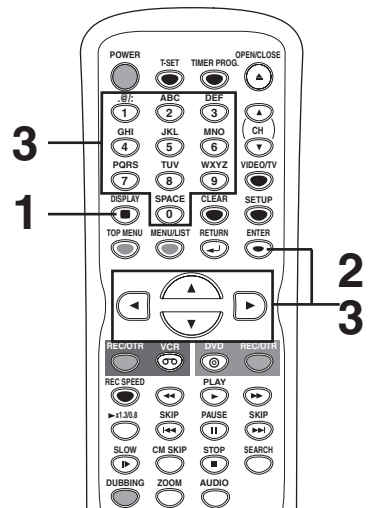

Note

- Time search function is available only within the same track or title.

Playing discs

Repeat/Random/Program playback

Repeat playback



1
During playback, press [DISPLAY].
The display menu will appear.

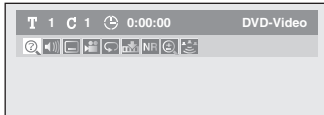

2
Using [◀/▶], select . Press [ENTER].
Repeat menu will appear.

<DVD-Video>

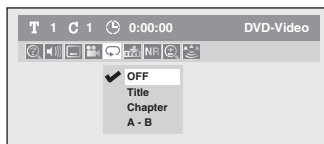

<Audio CD>

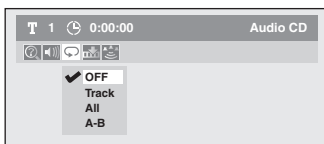

<MP3 / WMA files>

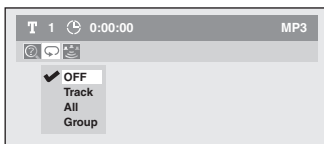

3
Using [▲ / ▼], select a desired option to repeat. Press [ENTER].
The selected repeat play will start.

Title:
The current title will be played repeatedly. (DVD only)

Chapter:
The current chapter will be played repeatedly. (DVD only)

All:
The current disc will be played repeatedly. (CD, MP3 / WMA, DVD-RW (VR mode) only)

A-B:
The A-B point will be played repeatedly.
When pressing [ENTER] while A-B is highlighted, A-B repeat is set. Press [ENTER] again to decide the starting point (A). Press [ENTER] after setting point A to select the ending point (B).

Track:
The current track will be played repeatedly. (CD, MP3 / WMA only)

Group:
The current group will be played repeatedly. (MP3 / WMA only)

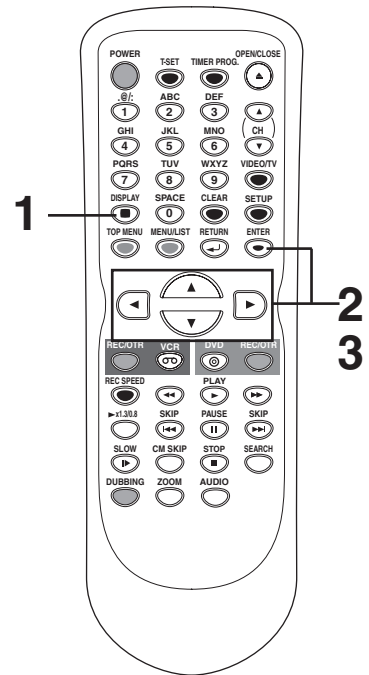

Note

- The A-B Repeat playback can only be set within the current title (for DVDs), or current track (for Audio CDs).
- To cancel the repeat playback, select "OFF" at step 2. The repeat setting will be also cleared when you stop playback.
- You cannot select "Group" for repeat playback during the random playback of MP3 / WMA files.

Random play



With this function, you can play a disc randomly instead of playing in the original order.

First:

1
Press [SETUP].

2
Using [▲ / ▼], select "CD Playback Mode". Press [ENTER].
CD Playback Mode menu will appear.

3
Using [▲ / ▼], select "Random Play". Press [ENTER].
Random play will start.

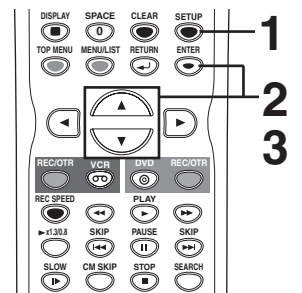

Note

- To cancel random playback, press [STOP ■] twice during random playback. "Play mode OFF" appears on the screen.

Playing discs

Repeat/Random/Program playback (cont'd)

Program play



You can program a playback sequence in your desired order.

First:

1
Press [SETUP].

2
Using [▲ / ▼], select “CD Playback Mode”. Press [ENTER].
CD Playback Mode menu will appear.

3
Using [▲ / ▼], select “Program Play”. Press [ENTER].
Program Play list will appear.

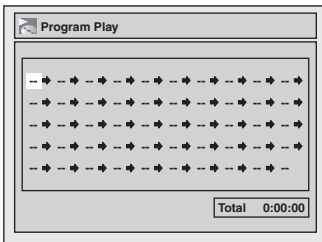

4
Using [▲ / ▼] or the Number buttons, select a desired track. Press [ENTER] or [▶].
A cursor will move to next.

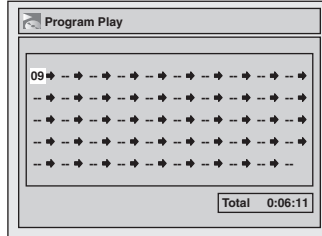

5
Press [PLAY ▶] to start program playback.
Program playback will start.

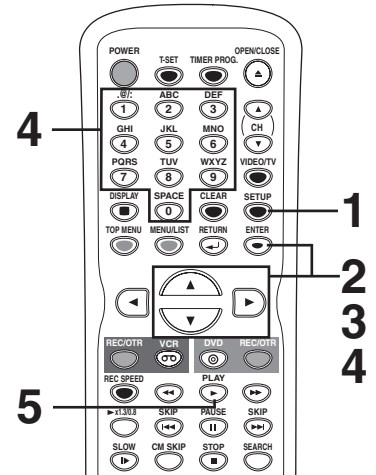

Note

- To erase tracks you selected, press [CLEAR].
- You can make program settings up to 50.
- To cancel program playback, press [STOP ■] twice during program playback.
- “Play mode OFF” appears on the screen.
- You may also select a desired track using the Number buttons at step 4.

Selecting the format of audio and video

You can select a desired audio and video format. Selections depend on the contents of the disc you are playing back.

Switching subtitles



Many DVD-Video discs have subtitles in one or more languages – they usually tell you which subtitle languages are available. You can switch subtitle languages anytime during playback.

1
During playback, press [DISPLAY].
The Display menu will appear.

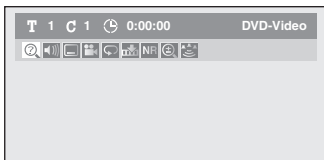

2
Using [◀ / ▶], select . Press [ENTER].
Subtitle menu will appear.

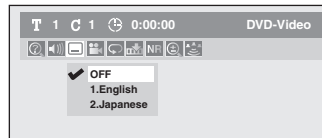

3
Using [▲ / ▼], select a desired subtitle language. Press [ENTER].
Subtitle will be displayed in the selected language.
When selecting “OFF”, subtitle will disappear.

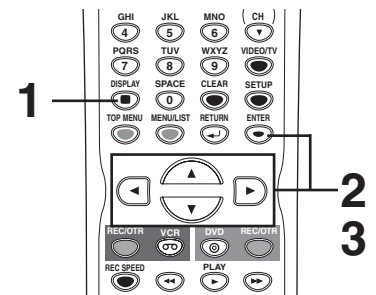

Note

- Some discs will only allow you to change subtitles from the Disc menu. Press [TOP MENU] or [MENU/LIST] to display the Disc menu.
- If a 4-digit language code appears in the subtitle menu at step 2, refer to the “Language code” on page 82.

Playing discs

Selecting a format of audio and video (cont'd)

Switching audio soundtrack



When playing back a DVD-Video disc recorded with two or more soundtracks (these are often in different languages), you can switch between them during playback.

On DVD-RW discs recorded in VR mode, you can switch to main (L), sub audio (R) or a mix of both (L/R). When playing back Audio CDs files, you can switch among stereo, the left channel only and the right channel only.

1 During playback, press [DISPLAY]. The Display menu will appear.

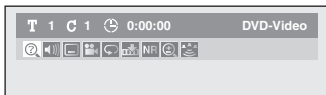

2 Using [◀/▶], select . Press [ENTER]. Audio menu will appear.



<DVD-RW VR mode>

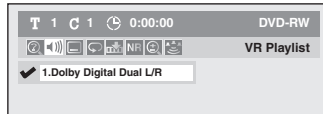

<Audio CD>

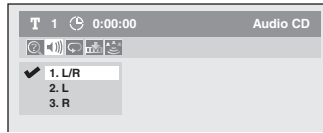

3 Using [▲/▼], select a desired audio soundtrack or audio channel. Press [ENTER].

<DVD-Video>
Audio soundtrack will switch.

<DVD-RW VR mode>

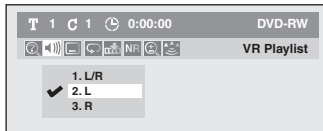

Audio channel menu will appear. Follow step 3.

<Audio CD>
Audio channel will change.

4 Using [▲/▼], select a desired audio channel. Press [ENTER]. Audio channel will change.

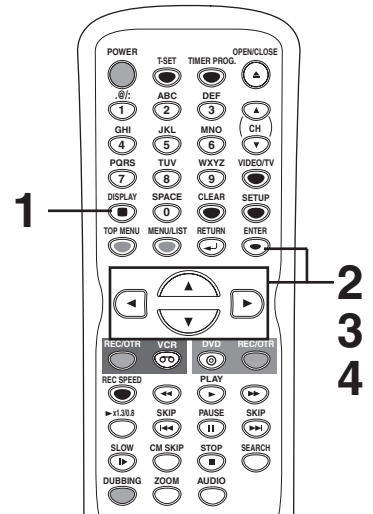

Note

- Some discs will only allow you to change the soundtrack from the Disc menu. Press [TOP MENU] or [MENU/LIST] to display the Disc menu.
- On DVD-RW discs recorded in VR mode with both main and sub audio, you can switch to main (L), sub audio (R) or a mix of both (L/R).
- This unit CANNOT record in both stereo and SAP (Secondary Audio Program) at the same time.

Switching virtual surround system



You can enjoy stereophonic virtual space through your exciting 2 channel stereo system.

1 During playback, press [DISPLAY]. The Display menu will appear.

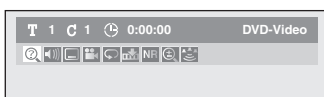

2 Using [◀/▶], select . Press [ENTER]. Virtual Surround menu will appear.

<DVD-Video>

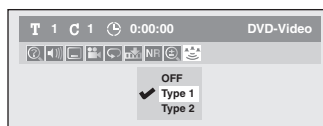

<DVD-RW VR mode>

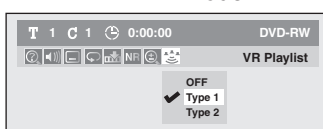

<Audio CD>

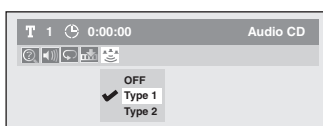

<MP3 / WMA files>

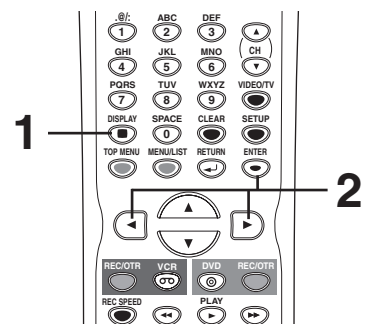
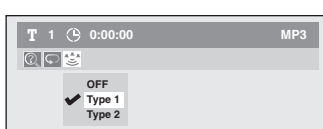

Note

- Select Virtual Surround OFF in a case sound is dissorted.
- The setting will be kept OFF when the unit is turned off.

Playing discs

Selecting a format of audio and video (cont'd)

3

Using [▲ / ▼], select “OFF”, “Type1” or “Type2”. Press [ENTER].

- OFF: no effect
- Type1: Natural effect
- Type2: Emphasised effect

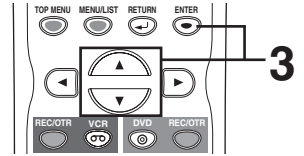

Switching camera angles



Some DVD-Video discs feature scenes shot from two or more angles. The disc package should be marked with an angle icon if it contains multi-angle scenes.

1

During playback, press [DISPLAY].

The Display menu will appear.

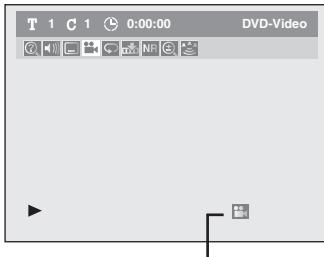

Angle icon appears when different camera angles are available.

2

Using [◀ / ▶], select . Press [ENTER].

Angle will switch each time you press [ENTER].

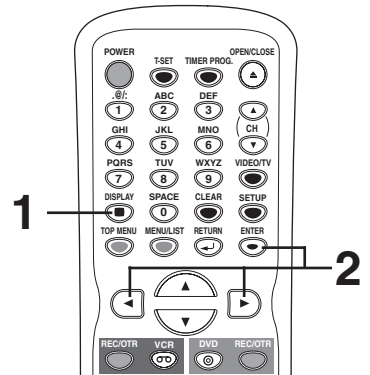

Note

Angle icon does not appear on the screen in a case you have selected Angle as “OFF” in the Display setting. Refer to pages 70-71.

Visual Noise Reduction



Noise Reduction menu will appear.

1

During playback, press [DISPLAY].

The Display menu will appear.

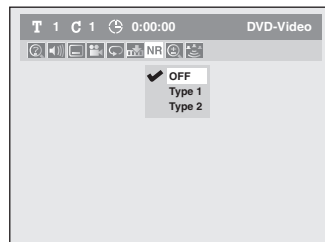
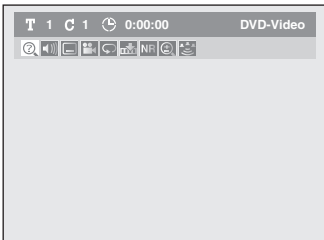

2

Using [◀ / ▶], select . Press [ENTER].

3

Using [▲ / ▼], select a desired option. Press [ENTER]. Your setting will be activated.

This function reduces visual noise. When playing back discs recorded in long time mode such as SLP or SEP mode, select “Type 1” or “Type 2”. (“Type 2” is more effective.) When playing back discs with a few noises such as DVD-Video discs, select “OFF”.

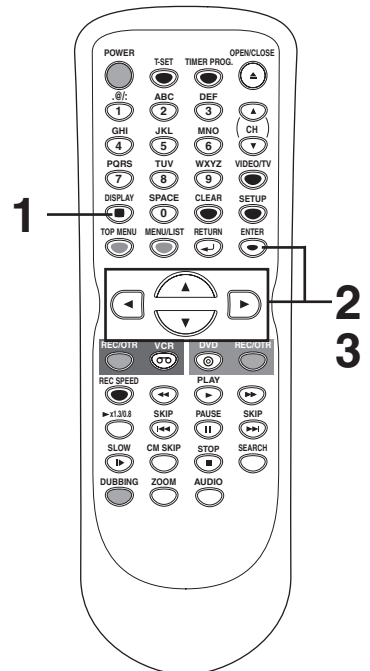

Guide to a title list

Title list allows you to check the titles recorded on the disc easily. You can choose a title to play it back from this screen and easily edit the titles as you prefer.

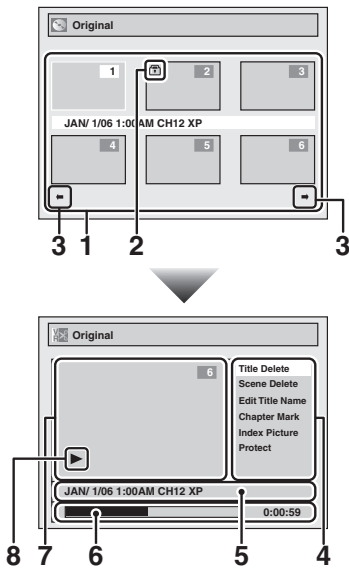

1. Titles recorded on the disc can be selected for editing or playing by pressing **[ENTER]** with the cursor on the title.
2. The protect icon, which appears when the title has been protected (Original titles only).
3. The arrow icon, which means the Title list has a next or a previous page. Press **[◀/▶]** or **[SKIP ◀◀/▶▶]** by following direction of the icon.
4. The menus for selecting a function for editing titles. The available menus depend on the disc type and the format type. An unavailable item is grayed out.
5. The details of the title. Title name can be changed on the Playlist.
6. Time status bar of the title.
After exiting the edit mode, you can resume playback from the point you stopped for editing.
7. The thumbnail of the title selected from the title list.
•The selected title will be played back automatically.
8. Playback status of the current disc.

Editing discs in Video mode

You can edit discs in Video mode for the following items. Be sure that once you edit titles, you cannot change them back to the original ones.

- Deleting titles (Refer to page 54)
- Putting names on titles (Refer to page 55)
- Setting or clearing chapter markers (Refer to page 56)

Note

- Once a disc is finalized, editing the disc or recording to the disc will not be available. (Except DVD-RW discs in VR mode.)
- A playlist is not available with the DVD-R discs and DVD-RW discs in Video mode.

Editing discs in VR mode

For discs in VR mode, you can edit from Original menu or Playlist menu, which is created from the original.

Editing Original titles

The following items can be used to edit the Original titles.

- Deleting titles (Refer to page 57)
- Setting titles to protect (Refer to page 58)
- Releasing titles from protecting (Refer to page 59)

Editing Playlists

You can create a Playlist from Original titles, so that you can edit as you prefer without losing Original titles.

The following items you can edit with a playlist.

- Deleting titles (Refer to page 60)
- Dividing a title (Refer to page 61)
- Combining titles (Refer to page 62)
- Adding titles to a Playlist (Refer to page 63)
- Deleting a Playlist (Refer to page 63)

Editing Original titles / Playlists

The following items can be used to edit both the Original titles and the Playlists.

- Deleting parts of titles (Refer to page 64)
- Putting names on titles (Refer to page 65)
- Setting or clearing chapter markers (Refer to page 66)
- Setting pictures for thumbnails (Refer to page 67)

Note

- Original titles once edited will not remain as recorded originally. When you want to leave the original as it is, edit the Playlist as you prefer.

After you finish all editing, press **[SETUP]** to exit the editing mode. "Writing to Disc" appears momentarily. If you open the disc tray, or press **[POWER]** to turn off the unit, or when a recording error occurs after editing, "Writing to Disc" also appears.

Editing

Editing discs in Video mode

Deleting titles



You can delete titles which you do not need anymore.

Be advised that the titles once deleted cannot be recovered.

In Video mode, recordable disc space of DVD-RW disc will increase when the last title on the title list is deleted. However, deleting the last title will not change recordable disc space of DVD-R discs.

For DVD-R or DVD-RW (in Video mode) discs once finalized, the title list cannot be selected for editing.



1
Press [TOP MENU].
Title List will appear.

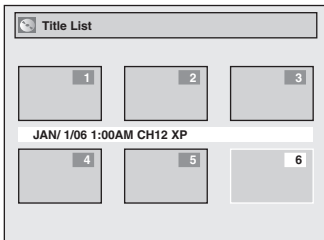

2
Using [▲ / ▼ / ◀ / ▶], select the desired title. Press [ENTER].
Option window will appear.

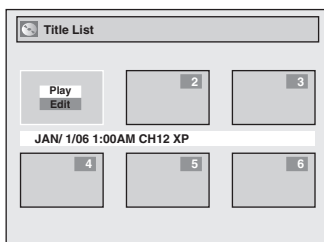

3
Using [▲ / ▼], select "Edit".
Press [ENTER].
Edit menu will appear.

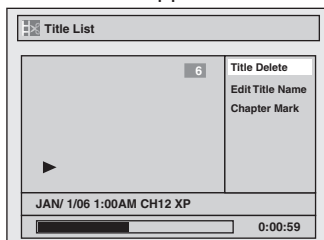

You cannot select "Chapter Mark" when a DVD-R disc is inserted into the unit.

"Chapter Mark" does not work on the title less than 5 minutes.

4
Using [▲ / ▼], select "Title Delete". Press [ENTER].
Confirmation window will appear.

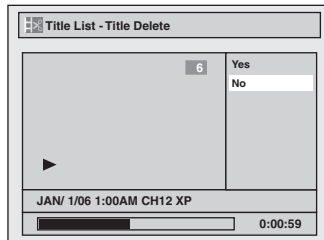

5
Using [▲ / ▼], select "Yes".
Press [ENTER].
After that, "Are you sure?" will appear, so that select "Yes" with [▲ / ▼] and then press [ENTER].

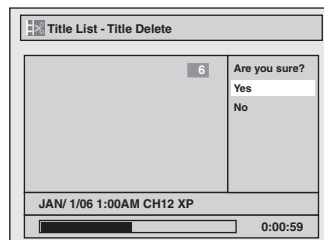

Title will be deleted.

6
Press [RETURN ←] or [STOP ■] to exit.
Data will be written onto the disc momentarily.

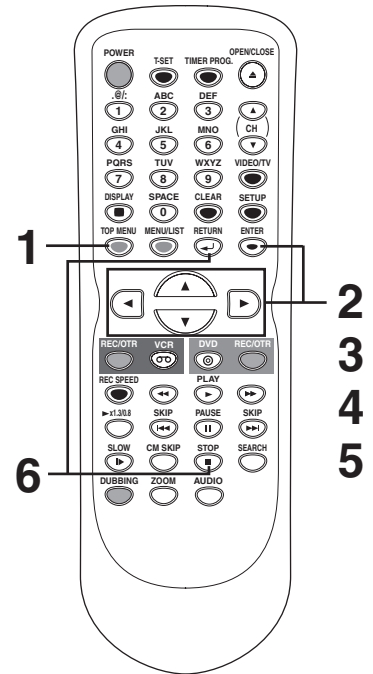
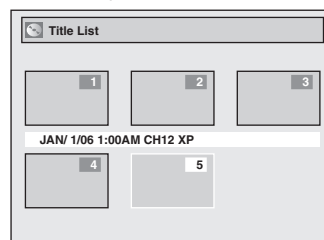

Putting names on titles



You can name titles and change the names from this menu.

The names you put on the titles will be displayed on a Title List.

First:

1

Follow steps 1 to 3 on page 54 to display the Edit menu.

Using [▲ / ▼], select “Edit Title Name”. Press [ENTER].

A window for entering a title name will appear.

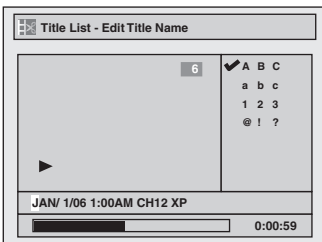

2

To enter a title name, follow the steps for “Guide to edit title name” on this page.

character set

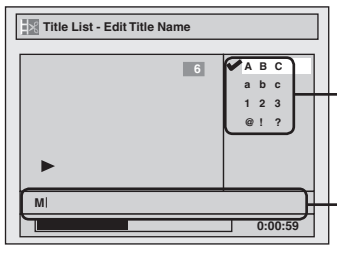

area for entering title names

When you finish entering a title name, press [ENTER]. Confirmation window will appear.

3

Using [▲ / ▼], select “Yes”. Press [ENTER].

The name you entered will be activated for the title.



4

Press [RETURN ←] and then [RETURN ←] or [STOP ■] to exit.

Data will be written onto the disc momentarily.

This operation may take a while to be completed.

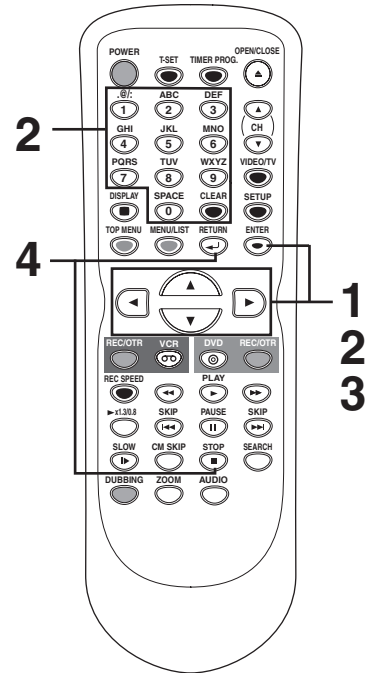

[Guide to edit title name]

[Step1]: Select a desired character set using [▲/▼], then press [ENTER].

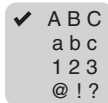

[Step2]: Follow the list below, press the **Number buttons** repeatedly until the desired letter appears. e.g. character set : A B C

Select	ABC	abc	123	@!?
0	<space>	<space>	0	<space>
1	(*1)	(*1)	1	! " # \$ % & ' () * + , - . / : ; < = > ? @ [] ^ _ { }
2	ABC	abc	2	(*2)
3	DEF	def	3	(*2)
4	GHI	ghi	4	(*2)
5	JKL	jkl	5	(*2)
6	MNO	mno	6	(*2)
7	PQRS	pqrs	7	(*2)
8	TUV	tuv	8	(*2)
9	WXYZ	wxyz	9	(*2)

Note: Undefined letters in a title name are shown by “*”. If you delete them, adjoining letters may change to “*” or other.

*1 Press (1), character set will be changed to the “ @!?” mode automatically.

*2 Press (2) to (9), character set will be changed to the previous input mode automatically.

- To delete letters, press [CLEAR] repeatedly. Holding [CLEAR] to delete all letters.
- Press [◀ / ▶] to move the cursor to the left or right.
- You can enter up to 30 letters.

Editing

Editing discs in Video mode (cont'd)

Setting or clearing chapter markers



You can put chapter markers on each title and use them for the chapter search feature.

You can specify time interval for chapter markers for titles last more than 5 minutes.

First:

1

Follow steps 1 to 3 on page 54 to display the Edit menu.

Using [**▲** / **▼**], select “Chapter Mark”. Press [**ENTER**].

Option window will appear.

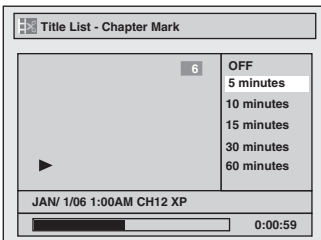

2

Using [**▲** / **▼**], select a desired time period. Press [**ENTER**].

Confirmation window will appear.

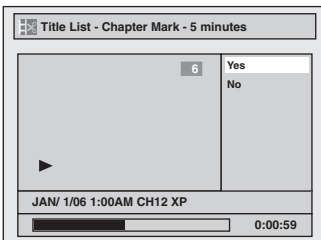

3

Using [**▲** / **▼**], select “Yes”. Press [**ENTER**].

The marker will be added or deleting.

This operation may take a while to be completed.

4

After this operation is completed, press [**RETURN** **↵**] and then [**RETURN** **↵**] or [**STOP** **■**] to exit.

Data will be written onto the disc momentarily.

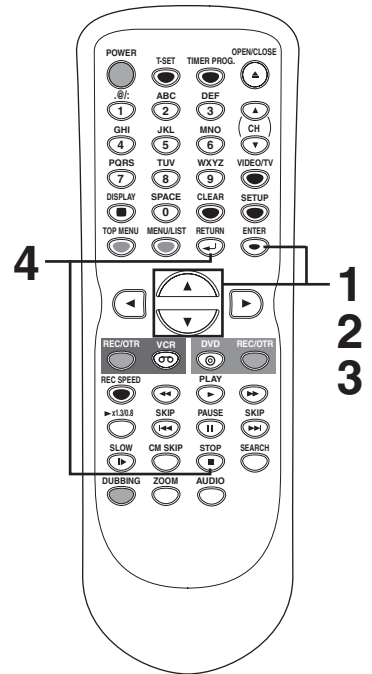

Note

- You cannot select a chapter mark interval that exceeds the length of a title.
- The interval of chapter marks may be slightly longer or shorter than the one specified at step 2.
- A chapter marker may be delayed according to the recording content.

Deleting titles



When a title is deleted from an original list in VR mode, the recordable disc space will increase.

Be advised that the titles once deleted cannot be recovered.

First:

1

Press [TOP MENU], and then press [MENU / LIST] to change "Playlist" to "Original".

Original list will appear.

2

Using [▲ / ▼ / ◀ / ▶], select the desired title. Press [ENTER].

Option window will appear.

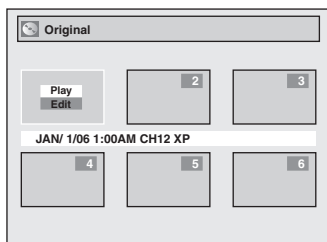

3

Using [▲ / ▼], select "Edit". Press [ENTER].

Original menu will appear.

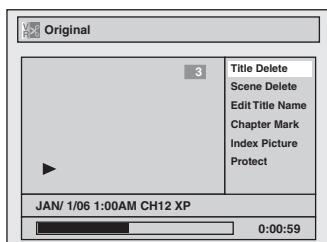

4

Using [▲ / ▼], select "Title Delete". Press [ENTER].

Confirmation window will appear.

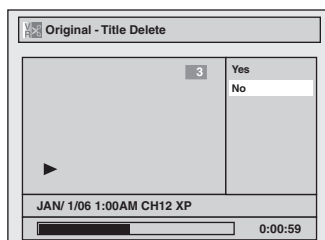

5

Using [▲ / ▼], select "Yes". Press [ENTER].

After that, "Are you sure?" will appear, so that select "Yes" with [▲ / ▼] and then press [ENTER].

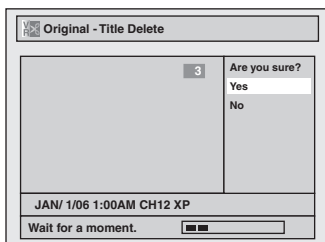

Title will be deleted.

This operation may take a while to be completed.

6

After this operation is completed, press [RETURN ↵] or [STOP ■] to exit.

Data will be written onto the disc momentarily.

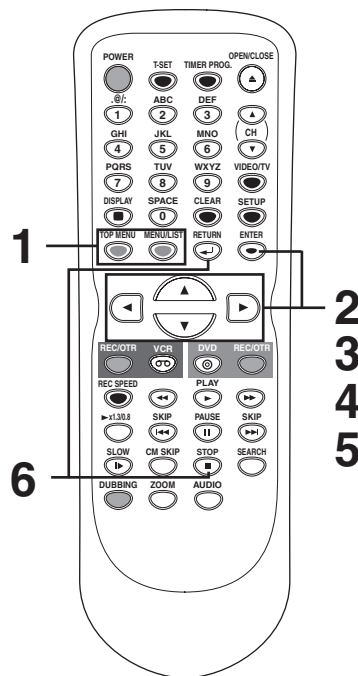

Note

- When a title is deleted from an Original, the title on the Playlist will be also deleted.
- Original titles once edited will not remain as recorded originally. When you want to leave the original as it is, edit the Playlist as you prefer.

Editing

Editing discs in VR mode (Original) (cont'd)

Setting titles to protect



To prevent accidental editing or title erasing, you can protect the contents in the original menu.

First:

1

Follow steps 1 to 3 on page 57 to display the Original menu.

Using [\blacktriangle / \blacktriangledown], select "Protect". Press [ENTER].

Option window will appear.

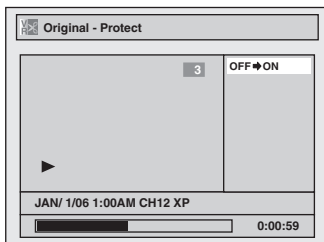

2

Confirm the indication

"OFF \rightarrow ON". Press [ENTER].

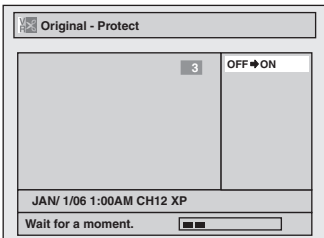

This operation may take a while to be completed.

The protect icon will appear on the title in the Original list.

3

After this operation is completed, press [RETURN \leftarrow] and then [RETURN \leftarrow] or [STOP \blacksquare] to exit.

Data will be written onto the disc momentarily.

To protect a whole disc (DVD-RW VR mode Only):

Select "Disc Protect ON \rightarrow OFF" from the Disc menu, then select "Yes". Refer to "Setting a disc to protect" on page 35.

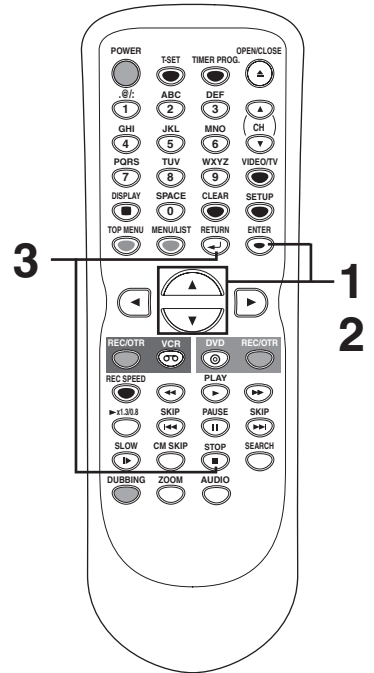

Releasing titles from protecting



You can cancel the title-protecting feature.

First:

1

Follow steps 1 to 3 on page 57 to display the Original menu.

A “” icon is shown on the protected titles.

“Protect” is already highlighted.

Press [ENTER].

Option window will appear.

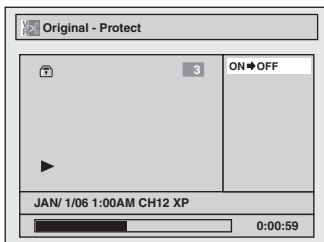

2

Confirm the indication

“ON → OFF”. Press [ENTER].

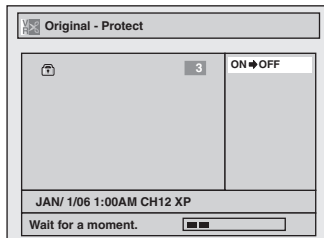

This operation may take a while to be completed.

The protect icon will disappear from the title in the Original list.

3

After this operation is completed, press [RETURN ↵] and then [RETURN ↵] or [STOP ■] to exit.

Data will be written onto the disc momentarily.

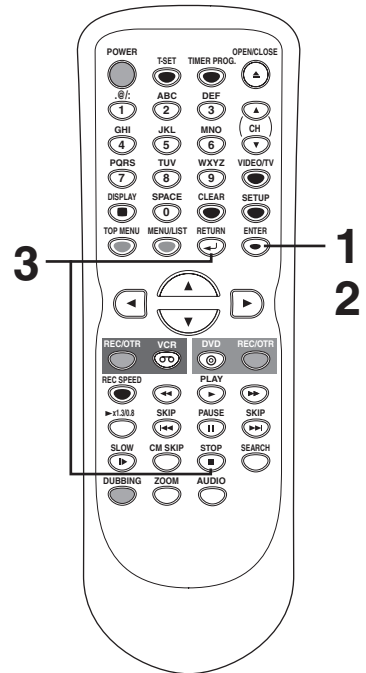

Editing

Editing discs in VR mode (Playlist)

Deleting titles



In VR mode, even if a title is deleted from a Playlist, the original title will remain on the Original list, and recordable disc space will not increase.

First:

1

Press [TOP MENU], and then press [MENU / LIST] to change "Original" to "Playlist". Playlist will appear.

2

Using [▲ / ▼ / ◀ / ▶], select the desired title. Press [ENTER]. Option window will appear.

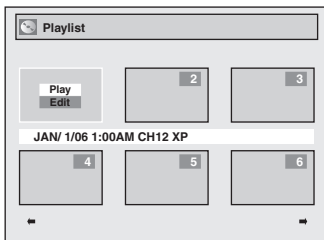

3

Using [▲ / ▼], select "Edit". Press [ENTER]. Playlist menu will appear.

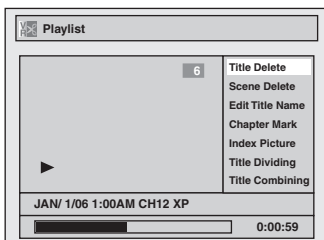

4

Using [▲ / ▼], select "Title Delete". Press [ENTER]. Confirmation window will appear.

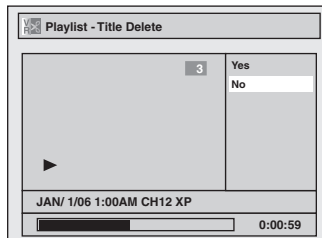

5

Using [▲ / ▼], select "Yes". Press [ENTER]. After that, "Are you sure?" will appear, so that select "Yes" with [▲ / ▼] and then press [ENTER].

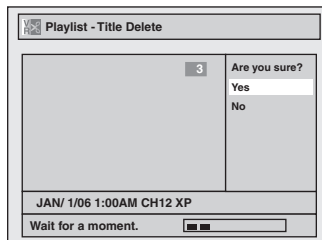

Title will be deleted.

This operation may take a while to be completed.

6

After this operation is completed, press [RETURN ↵] or [STOP ■] to exit. Data will be written onto the disc momentarily.

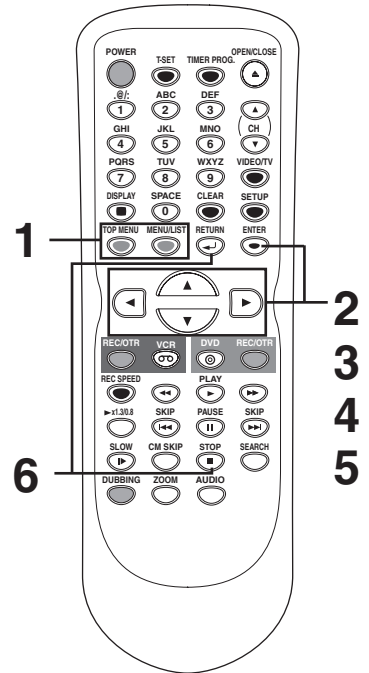

Dividing a title



You can divide a title into two new titles.

First:

1

Follow steps 1 to 3 on page 60 to display the Playlist menu.

Using [**▲** / **▼**], select "Title Dividing". Use [**SKIP** **◀◀** / **▶▶**], [**◀◀**], [**▶▶**], [**PLAY** **▶**] and [**PAUSE** **||**] to decide the point at which you will divide the title. Press [**ENTER**].

Confirmation window will appear.

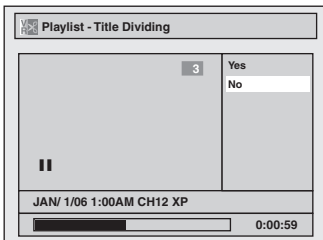

2

Using [**▲** / **▼**], select "Yes". Press [**ENTER**].

The title will be divided into two new titles.

Both title names are identical, and index pictures are reset to first scene at this point.

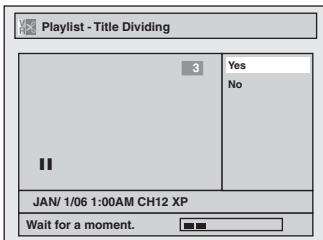

This operation may take a while to be completed.

3

After this operation is completed, press [**RETURN** **↵**] or [**STOP** **■**] to exit.

Data will be written onto the disc momentarily.

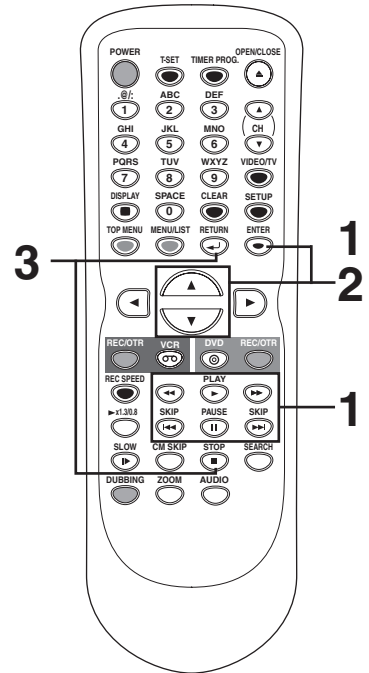

3

2

1

Note

- If a disc contains the maximum number of recordings (99), you cannot divide any titles.
- You cannot divide the titles if the total number of the chapters have already reached 999.

Editing

Editing discs in VR mode (Playlist) (cont'd)

Combining titles



You can combine two titles into a single title.

First:

1

Follow steps 1 to 3 on page 60 to display the Playlist menu.

Using [**▲** / **▼**], select “Title Combining”. Press [**ENTER**].

Title Combining setting window will appear.

Selected title grays out, and the frame of the next title becomes yellow.

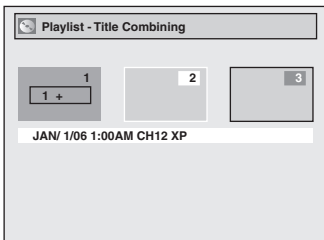

2

Using [**▲** / **▼** / **◀** / **▶**], select another title to combine. Press [**ENTER**].

Confirmation window will appear.

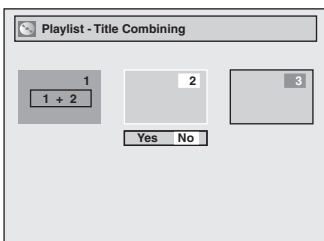

3

Using [**◀** / **▶**], select “Yes”. Press [**ENTER**].

Two titles will combine into a single title.

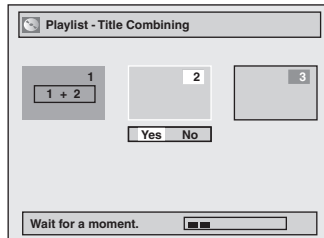

This operation may take a while to be completed.

4

After this operation is completed, press [**RETURN** **↵**] or [**STOP** **■**] to exit.

Data will be written onto the disc momentarily.

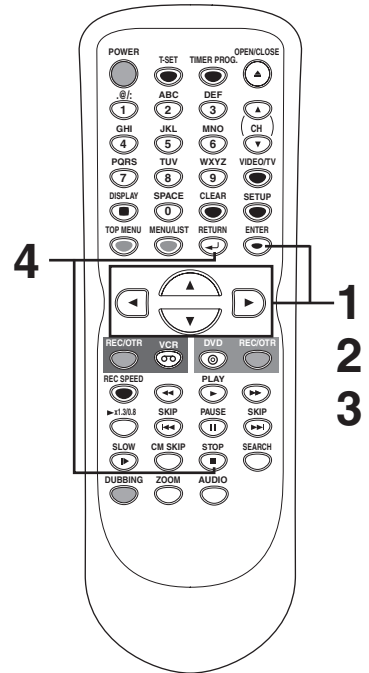

Note

- If the number of chapter markers in the combined title exceeds 999, the combination will be rejected.
- If one of two titles in the original is deleted, the combined new title will be deleted.
- The name of the title selected first will become the name of the combined title.
- The title selected first will be the first point of the combined title.

Editing

Editing discs in VR mode (Playlist) (cont'd)

Adding titles to a Playlist



You can add or delete a title on the playlist as you prefer. You can add up to 99 titles to a Playlist.

First:

1

Follow step 1 on page 60 to display the Playlist. Next to the final title, "Add New Title" "Delete Playlist" menu is shown.

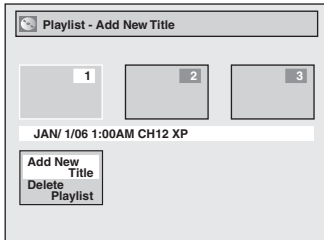

Using $[\Delta / \nabla / \blacktriangleleft / \blacktriangleright]$, select "Add New Title". Press [ENTER].

Deleting a Playlist



A Playlist can be deleted if it is no longer needed.

First:

1

Follow step 1 on page 60 to display the Playlist. Next to the final title, "Add New Title" "Delete Playlist" menu is shown.

Using $[\Delta / \nabla / \blacktriangleleft / \blacktriangleright]$, select "Delete Playlist". Press [ENTER]. Confirmation window will appear.

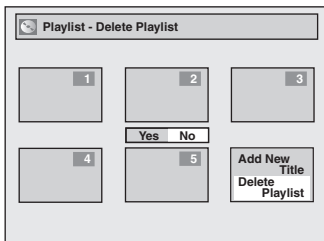

2

Using $[\blacktriangleleft / \blacktriangleright]$, select "Yes". Press [ENTER].

2

Using $[\Delta / \nabla / \blacktriangleleft / \blacktriangleright]$, select a desired title. Press [ENTER]. The added title will appear as the final title.

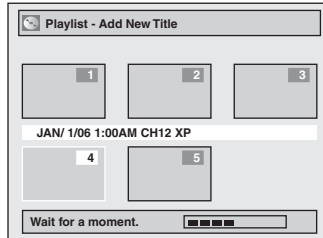

This operation may take a while to be completed.

3

After this operation is completed, press [RETURN \rightarrow] or [STOP \blacksquare] to exit.

Data will be written onto the disc momentarily.

3

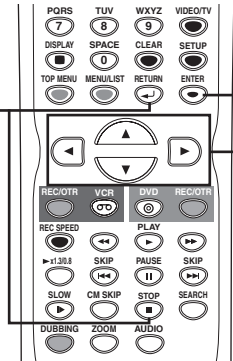

Note

- When a Playlist contains 99 titles or more or 999 chapters or more, "Add New Title" cannot be selected.
- To delete a title from Playlist, refer to "Deleting titles" on page 60.
- To delete a Playlist, refer to "Deleting a Playlist" on this page.

Final confirmation window will appear.

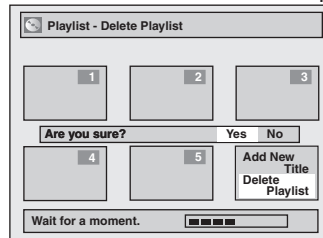

3

Using $[\blacktriangleleft / \blacktriangleright]$, select "Yes". Press [ENTER].

A Playlist will be erased.

4

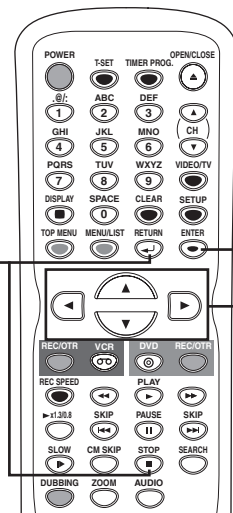

This operation may take a while to be completed.

4

After this operation is completed, press [RETURN \rightarrow] or [STOP \blacksquare] to exit.

Data will be written onto the disc momentarily.

Note

- Deleting a Playlist will not increase the recordable disc space.

Editing

Editing discs in VR mode (Original / Playlist)

Deleting parts of titles



You can delete a specific part of a title.

Even if parts of title are deleted from the Playlist, the original title will remain as it was, and recordable disc space will not increase.

First:

1 Press [TOP MENU], and then press [MENU / LIST] to select "Original" or "Playlist".

2 Using [▲ / ▼ / ◀ / ▶], select the desired title. Press [ENTER]. Option window will appear. <Playlist>

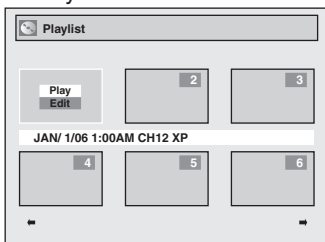

3 Using [▲ / ▼], select "Edit". Press [ENTER]. Original or Playlist menu will appear. <Playlist>

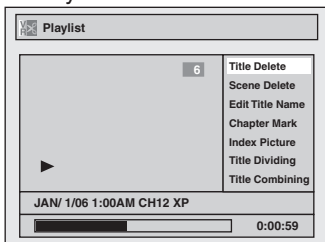

4 Using [▲ / ▼], select "Scene Delete". Press [ENTER]. Option window will appear. <Playlist>

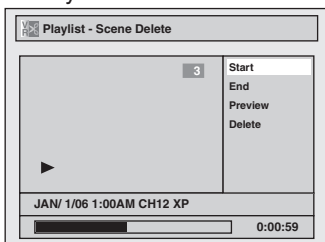

5 Use [SKIP ◀◀ / ▶▶], [◀◀], [▶▶], [PLAY ▶] and [PAUSE II] to decide the start point, then press [ENTER]. Then use [SKIP ◀◀ / ▶▶], [◀◀], [▶▶], [PLAY ▶] and [PAUSE II] again to move to the end point, and press [ENTER].

A cursor will move to "Preview". The bar at the bottom of the screen indicates the total and the elapsed time of the title, and the area selected for deletion will be indicated in red.

Press [ENTER] again to start the preview. You can check the result of deletion by "Preview".

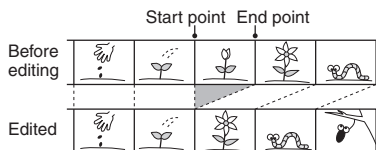

6 Using [▲ / ▼], select "Delete". Press [ENTER]. Confirmation window will appear. <Playlist>

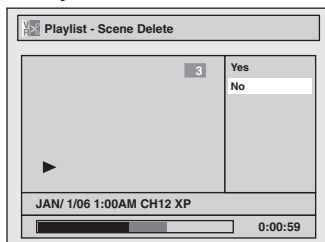

7 Using [▲ / ▼], select "Yes". Press [ENTER]. After that, "Are you sure?" will appear, so that select "Yes" with [▲ / ▼] and then press [ENTER]. <Playlist>

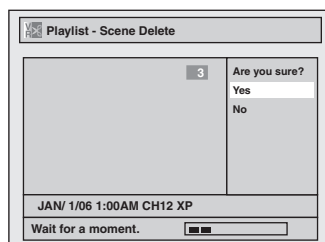

Part of a title will be deleted.

This operation may take a while to be completed.

8 After this operation is completed, press [RETURN ↵] and then [RETURN ↵] or [STOP ■] to exit. Data will be written onto the disc momentarily.

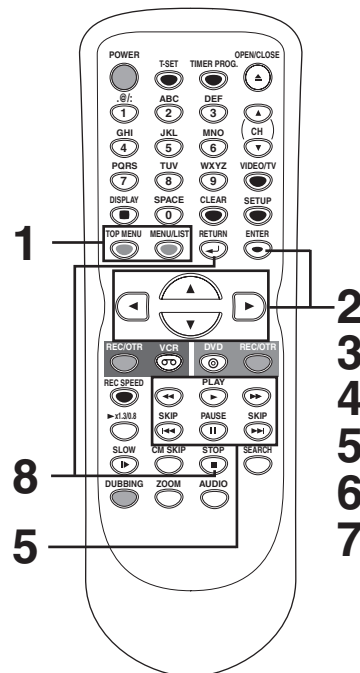

Note

- When a scene is deleted from an Original, the scene on the Playlist will be also deleted.
- Original titles once edited will not remain as recorded originally. When you want to leave the original as it is, edit the Playlist as you prefer.
- You cannot select "Scene Delete" when the number of chapter markers is more than 900.

Putting names on titles



You can name titles and change the names in this menu.

The names you put on the titles will be displayed on a Title List.

First:

1

Follow steps 1 to 3 on page 64 to display Original or Playlist menu.

2

Using [▲ / ▼], select “Edit Title Name”. Press [ENTER].

A window for entering a title name will appear.

<Playlist>

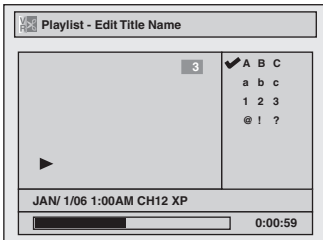

3

To enter a title name, follow the steps for “Guide to edit title name” on this page.

character set

<Playlist>

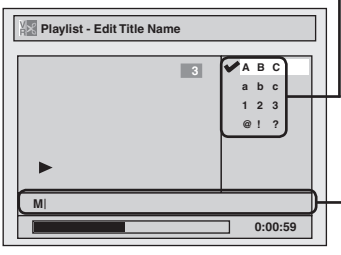

area for entering title names

When you finish entering a title name, press [ENTER].

Confirmation window will appear.

4

Using [▲ / ▼], select “Yes”. Press [ENTER].

The name you entered will be activated for the title.

<Playlist>

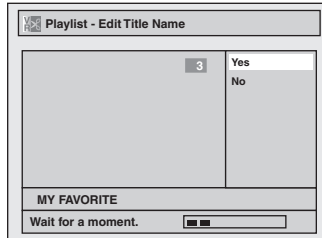

5

Press [RETURN ←] and then [RETURN ←] or [STOP ■] to exit.

Data will be written onto the disc momentarily.

This operation may take a while to be completed.

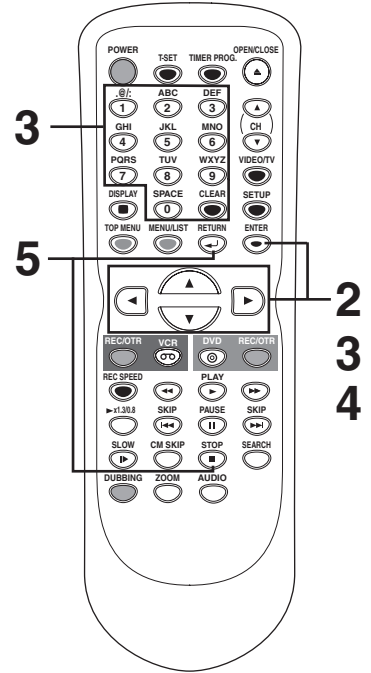

[Guide to edit title name]

[Step1]: Select a desired character set using [▲/▼], then press [ENTER].

✓ A B C
a b c
1 2 3
@ ! ?

[Step2]: Follow the list below, press the **Number buttons** repeatedly until the desired letter appears.
e.g. character set : A B C

Select Press	ABC	abc	123	@ ! ?
0	<space>	<space>	0	<space>
1	(*1)	(*1)	1	! " # \$ % & ' () * + , - . / : ; < = > ? @ [] ^ _ { }
2	ABC	abc	2	(*2)
3	DEF	def	3	(*2)
4	GHI	ghi	4	(*2)
5	JKL	jkl	5	(*2)
6	MNO	mno	6	(*2)
7	PQRS	pqrs	7	(*2)
8	TUV	tuv	8	(*2)
9	WXYZ	wxyz	9	(*2)

Note:

Undefined letters in a title name are shown by “*”. If you delete them, adjoining letters may change to “*” or other.

*1 Press (1), character set will be changed to the “@!?” mode automatically.

*2 Press (2) to (9), character set will be changed to the previous input mode automatically.

- To delete letters, press [CLEAR] repeatedly. Holding [CLEAR] to delete all letters.
- Press [◀ / ▶] to move the cursor to the left or right.
- You can enter up to 30 letters.

Editing

Editing discs in VR mode (Original / Playlist) (cont'd)

Setting or clearing chapter markers



You can put chapter markers on each title and can use them for the chapter search feature.

You can put a chapter marker anywhere you want until the total number of the markers reaches 999.

First:

1

Follow steps 1 to 3 on page 64 to display Original or Playlist menu.

2

Using [\blacktriangle / \blacktriangledown], select "Chapter Mark". Press [ENTER].

Option window will appear.

<Playlist>

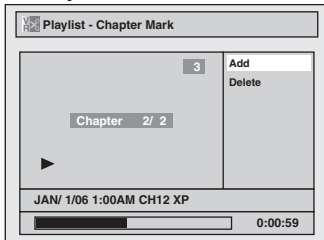

3

Use [SKIP $\blacktriangleleft\blacktriangleleft$ / $\blacktriangleright\blacktriangleright$], [\blacktriangleleft], [\blacktriangleright], [PLAY \blacktriangleright] and [PAUSE \parallel] to decide the point at which you will create a new chapter marker.

Or, use [SKIP $\blacktriangleleft\blacktriangleleft$ / $\blacktriangleright\blacktriangleright$] to decide a chapter marker that you will delete. Select "Add" or "Delete" accordingly using [\blacktriangle / \blacktriangledown]. Press [ENTER].

Confirmation window will appear.

<Playlist :Add>

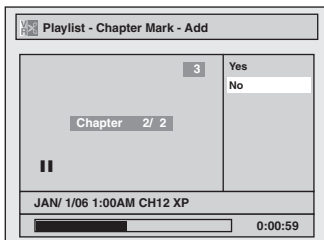

<Playlist :Delete>

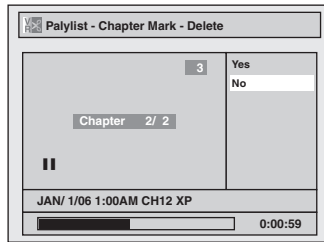

- You cannot delete the first chapter of each title.

4

Using [\blacktriangle / \blacktriangledown], select "Yes".

Press [ENTER].

When you select "Add" at step 3, a new chapter marker will be created at the point you have decided.

<Playlist :Add>

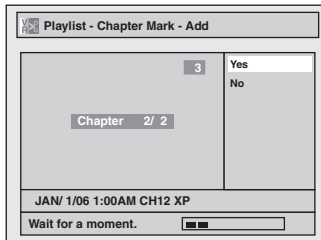

This operation may take a while to be completed.

When you select "Delete" at step 3, the chapter marker you have selected will be deleted.

<Playlist :Delete>

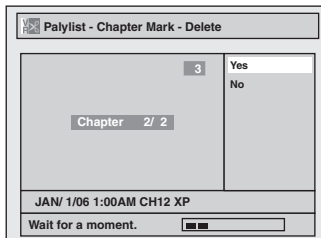

This operation may take a while to be completed.

5

After this operation is completed, press [RETURN \blacktriangleleft] twice and then [RETURN \blacktriangleleft] or [STOP \blacksquare] to exit.

Data will be written onto the disc momentarily.

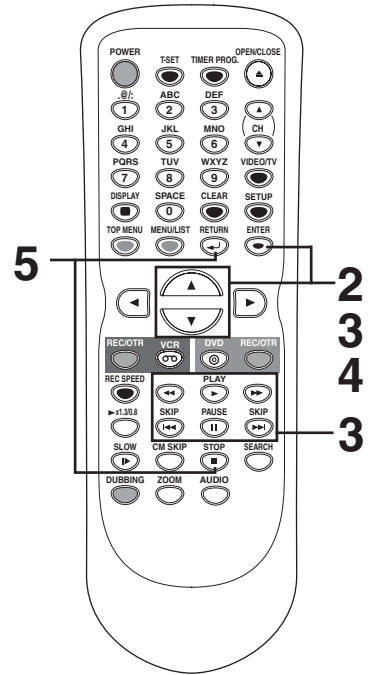

Editing discs in VR mode (Original / Playlist) (cont'd)

Setting pictures for thumbnails



You can set an image picture for each title as a thumbnail. It helps you remember the contents of the title during playback. The default setting chooses the first scene of each title as the thumbnail.

First:

1

Follow steps 1 to 3 on page 64 to display Original or Playlist menu.

2

Use [SKIP ◀◀ / ▶▶], [◀◀], [▶▶], [PLAY ▶] and [PAUSE II] to decide the picture you want to select as a thumbnail.

Using [▲ / ▼], select "Index Picture". Press [ENTER].

Confirmation window will appear.

<Playlist>

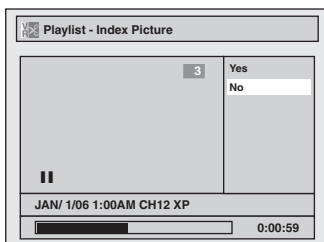

3

Using [▲ / ▼], select "Yes".

Press [ENTER].

A picture for thumbnail will be set.

<Playlist>

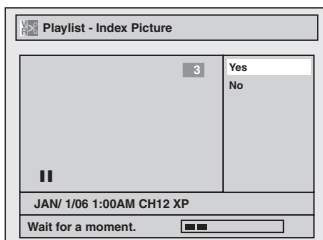

This operation may take a while to be completed.

4

After this operation is completed, press [RETURN ↵] and then [RETURN ↵] or [STOP ■] to exit.

Data will be written onto the disc momentarily.

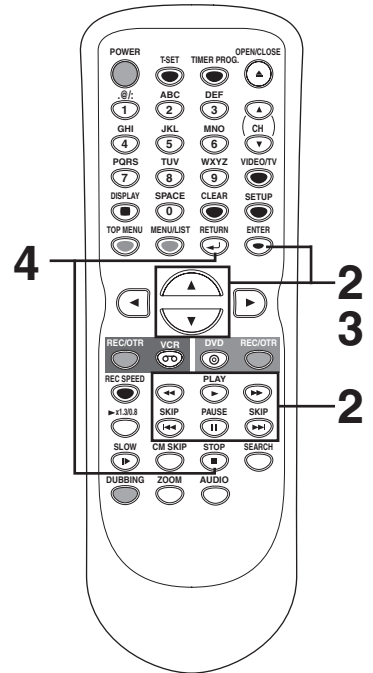

4

2

3

2

Note

- If a selected picture as thumbnail is deleted by deleting a part of a title, a default picture will automatically replace it.

Changing the Setup menu

Tour of the Setup menu

The following table shows the items which you can change the setting and their default settings. Refer to the following table for your convenience.

Setup	Items (highlight is the default)	Contents	
1. Language setting ➔ Pages 69-70	Disc Menu Language	English French Spanish ⋮	Set the language for the Disc menu.
	Audio Language	Original English French ⋮	Set the language for audio.
	Subtitle Language	OFF English French ⋮	Set the language for subtitle.
2. Display setting ➔ Pages 70-71	OSD Language	English Français Español	Set the language for OSD (On Screen Display).
	Angle Icon	ON OFF	Set the display or undisplay of multi-angle icon in a case the DVD in playback mode contains multi-angle scene.
	Screen Saver	OFF 5 minutes 10 minutes ⋮	Set the time to work the screen saver on the screen.
	FL Dimmer	Auto Bright Dark	Set the brightness of the front panel display.
3. Audio setting ➔ Pages 71-72	Digital Out	PCM 48kHz 96kHz	Set whether the sound recorded in 96kHz will be down sampled in 48kHz.
		Dolby Digital PCM Stream	Set the type of sound signal which outputs from the digital audio output jack.
	Dynamic Range Control	ON OFF	Compressing the range of sound volume.
4. Video setting ➔ Page 73	Still Mode	Auto Field Frame	Set the type of still image in pausing playback.
5. Parental setting ➔ Pages 73-74	Parental Lock	All level 8 to 1	Set the parental level of your DVD discs.
	(Change password)	Enter the current four-digit password	Set and change the password.

Note

- If you change the settings in the Setup menu, the information of contents stays on even after the power is switched off or the disc tray is opened or closed.
- An item which is not currently available is grayed out in Setup menus.

Changing the Setup menu

Language setting

Press [STOP ■] if you are playing a disc.

1

Press [SETUP].

2

Using [▲ / ▼], select "Playback". Press [ENTER].
Playback menu will appear.

3

Using [▲ / ▼], select "Language". Press [ENTER].
Language menu will appear.

4

Using [▲ / ▼], select a desired item. Press [ENTER].

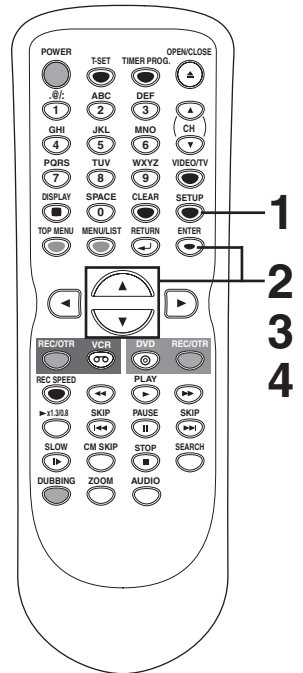

Disc Menu Language (Default : English)

Set the language for Disc Menu.

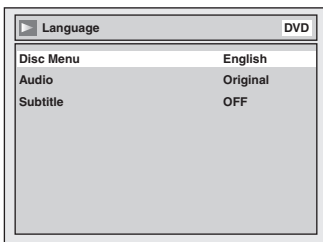

- Using [▲ / ▼], select a language. Press [ENTER]. Your setting will be activated.
- When Original is selected, the audio language will be the disc's default language.

Audio Language (Default : Original)

Set the Audio language.

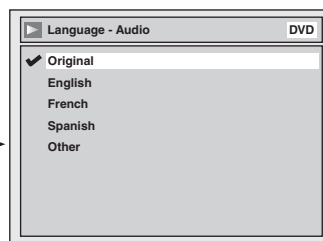
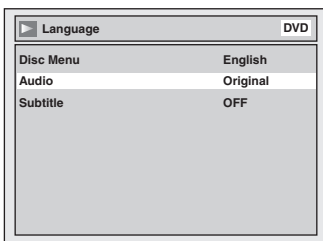

- Using [▲ / ▼], select a setting. Press [ENTER]. Your setting will be activated.
- When Original is selected, the audio language will be the disc's default language.

Before you start

Connections

Getting started

Recording

Playing discs

Editing

Changing the Setup menu

VCR functions

Others

Español

Changing the Setup menu

Language setting (cont'd)

Subtitle Language (Default : OFF)

Set the Subtitle language.

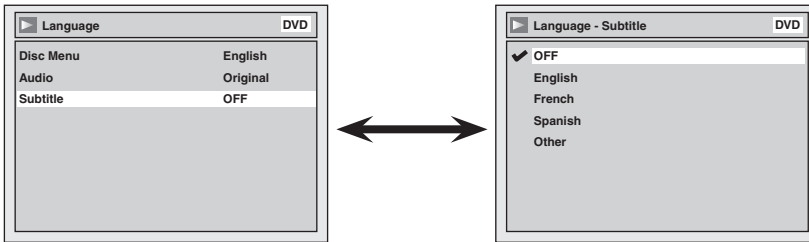

- Using [**▲** / **▼**], select a setting. Press [**ENTER**]. Your setting will be activated.

If "Other" is selected, press 4-digit code using the Number buttons.

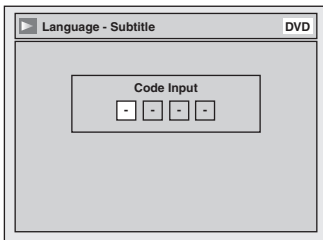

- When you finish entering the code, press [**ENTER**]. Refer to "Language code" on page 82.

Note

- Only the languages supported by the disc can be selected.
- Audio Language setting may not be available on some discs.
- You can also change or switch off the subtitles on a DVD disc also from the Disc menu if it is available.
- Press [**CLEAR**] or [**◀**] to erase numbers entered incorrectly.

5

Press [**SETUP**] to exit.

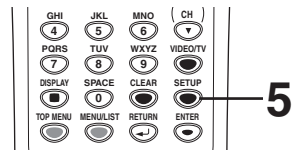

Display setting

Press [**STOP ■**] if you are playing back a disc.

1

Press [**SETUP**].

2

Using [**▲** / **▼**], select "Display". Press [**ENTER**].

Display menu will appear.

3

Using [**▲** / **▼**], select a desired item. Press [**ENTER**].

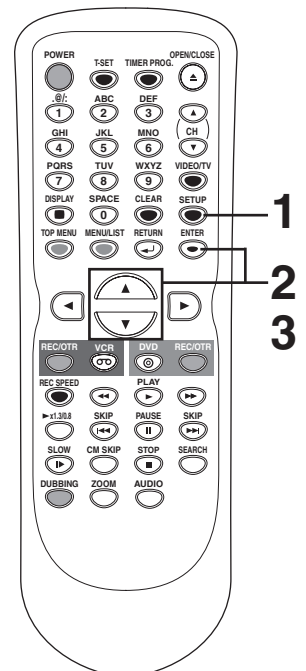

Changing the Setup menu

Display setting (cont'd)

OSD Language (Default : English)

Set the language for OSD.

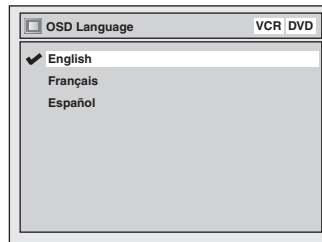
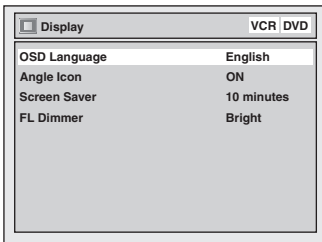

- Using [▲ / ▼], select a language. Press [ENTER]. Your setting will be activated.

Angle Icon (Default : ON)

Set to ON or OFF.

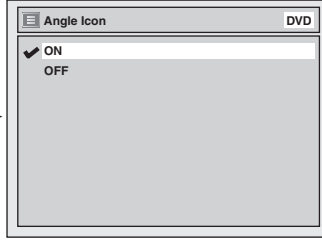
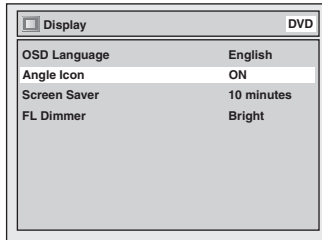

- Using [▲ / ▼], select a setting. Press [ENTER]. Your setting will be activated.

Screen Saver (Default : 10 minutes)

Set the time to work the screen saver function on the screen.

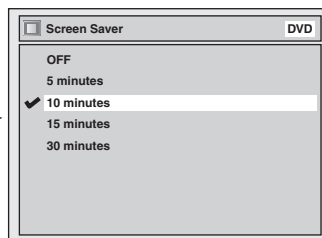
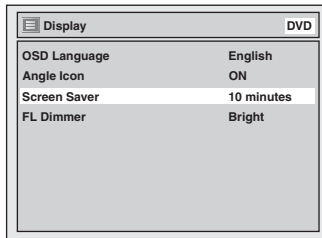

- Using [▲ / ▼], select a setting. Press [ENTER]. Your setting will be activated.

FL Dimmer (Default : Bright)

Set the brightness of front panel display.

You can choose one among "Auto", "Bright" and "Dark".

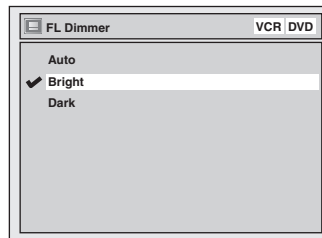
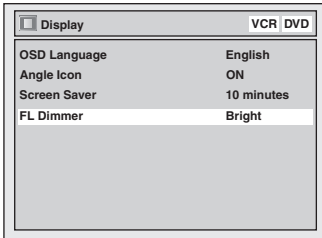

- Using [▲ / ▼], select a setting. Press [ENTER]. Your setting will be activated.
- If "Auto" is selected, the display is shown brighter when the power is on, darker when the power is off.

4

Press [SETUP] to exit.



Audio setting

Choose the appropriate Audio settings for your equipment.

It will only affect DVD discs during playback.

Press [STOP ■] if you are playing back a disc.

1

Press [SETUP].

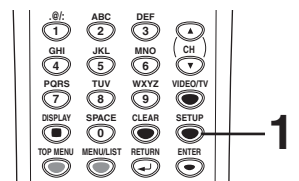

Changing the Setup menu

Audio setting (cont'd)

2

Using [▲ / ▼], select "Playback". Press [ENTER].

Playback menu will appear.

3

Using [▲ / ▼], select "Audio". Press [ENTER].

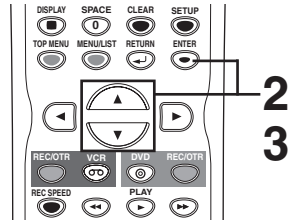

Note

- Dynamic Range Control function is available only on the discs which are recorded in the Dolby Digital format.

Digital Out

Set the digital audio output.

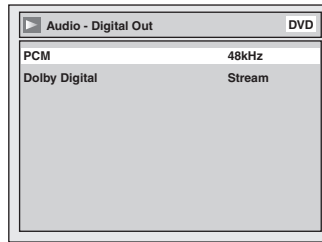
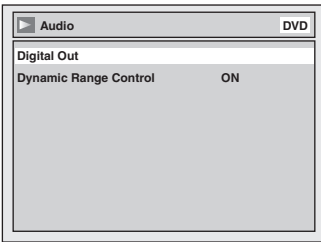

- Using [▲ / ▼], select a setting. Press [ENTER]. Option window will appear. Proceed to step A or B.

A

Settings for PCM (Default : 48kHz)

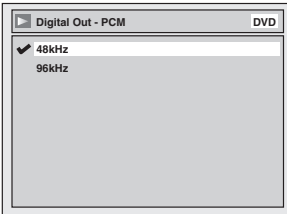

- Using [▲ / ▼], select a setting. Press [ENTER].

Your setting will be activated.

48kHz :If your amplifier/decoder is NOT compatible with 96kHz PCM, select "48kHz". 96kHz sound will be output in 48kHz.

96kHz :If your amplifier/decoder is compatible with 96kHz PCM, select "96kHz". 96kHz sound will be output.

Note

When playing disc with copyright protection

- Even if you select "96kHz", the sound will be down sampled at 48kHz.

B

Settings for Dolby Digital (Default : Stream)

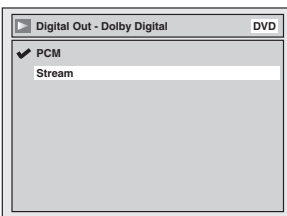

- Using [▲ / ▼], select a setting. Press [ENTER].

Your setting will be activated.

PCM :Convert the Dolby Digital into PCM(2 channel).

When your amplifier/decoder is NOT compatible with Dolby Digital, set to "PCM".

Stream :Outputs Dolby Digital signals.

When your amplifier/decoder is compatible with Dolby Digital, set to "Stream".

Note

When playing a DVD-RW disc recorded in VR mode

- If the audio source on a disc is Dolby Digital format, set "Dolby Digital" to "PCM" so that you can switch to main (L), sub audio (R), or a mix of both (L/R) with your amplifier/decoder.

Dynamic Range Control (Default : ON)

Set to ON to compress the range between soft and loud sounds.

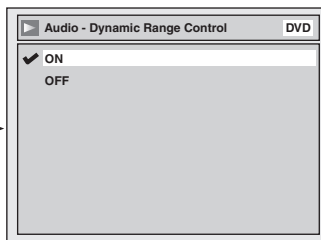
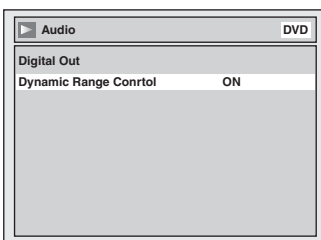

- Using [▲ / ▼], select a setting. Press [ENTER]. Your setting will be activated.

4

Press [SETUP] to exit.

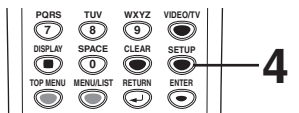

Changing the Setup menu

Video setting

Still Mode (Default : Auto)

Set the type of still image in pausing playback.

Press [STOP ■] if you are playing a disc.

1

Press [SETUP].

2

Using [▲ / ▼], select "Playback". Press [ENTER].

Your setting will be activated.

3

Using [▲ / ▼], select "Video". Press [ENTER].

4

Using [▲ / ▼], select "Still Mode". Press [ENTER].

5

Using [▲ / ▼], select a setting. Press [ENTER].

Your setting will be activated.

Auto : Optimun setting is selected.

Field : Flicker-free images are played back in pause playback mode.

Frame : Higher- resolution images are played back in pause playback mode.

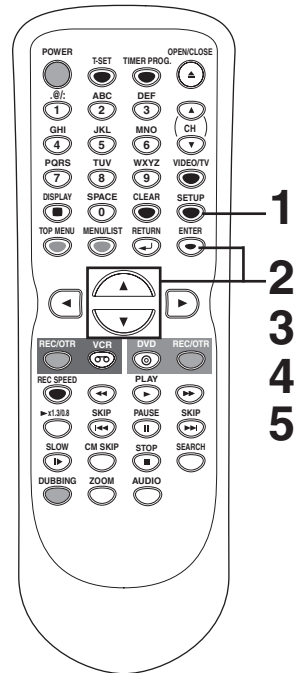

Note

- Frame is 1 completed video image made up of 2 fields (There are 30 frame per second of NTSC video).

Settings for Parental lock level

Some DVD-Video discs feature a Parental Lock level. Playback will stop if the disc's general rating exceeds the level you set. It will require you to enter a password before the disc will be played back. This feature prevents your children from viewing inappropriate materials.

Press [STOP ■] if you are playing a disc.

1

Press [SETUP].

2

Using [▲ / ▼], select "Playback". Press [ENTER].

Playback menu will appear.

3

Using [▲ / ▼], select "Parental Lock". Press [ENTER].

4

Using [▲ / ▼], select the desired level. Press [ENTER].

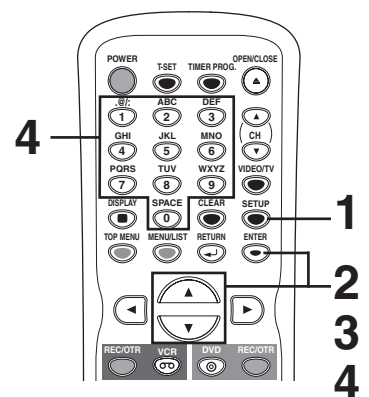

Note

- Parental lock function may not be available on some discs.
- For some DVDs, it may be difficult to find if they are compatible with parental lock. Be sure to check if the parental lock function operates in the way that you have set.
- Record the password in case you forget it.

Changing the Setup menu

Settings for Parental lock level (cont'd)

Parental Lock (Default : All)

Set the Parental Lock level.

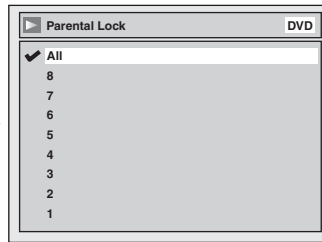
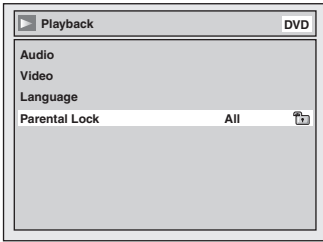

- Using [**▲** / **▼**], change the parental level. Press [**ENTER**].
Option window will appear
Proceed to step A or B.

A A password has not been set yet

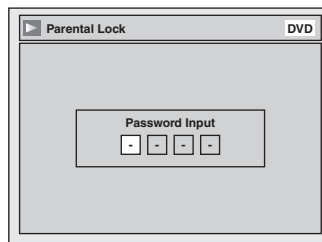
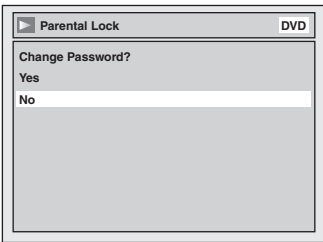

- Using [**▲** / **▼**], select “Yes”. Press [**ENTER**]. If you select “No”, proceed to step 5.
- Using the Number buttons, enter a new password. Press [**ENTER**].
Your setting will be activated.

B A password has been set already

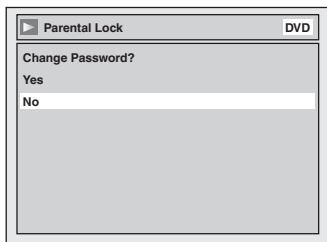
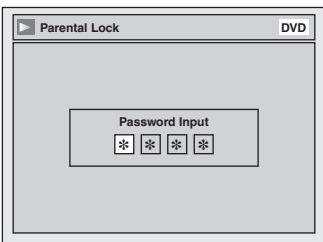

<Change the password>

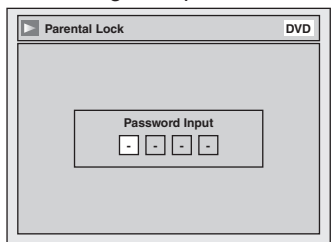

- Using the Number buttons, enter the current password.
- Using [**▲** / **▼**], select “Yes”. Press [**ENTER**]. If you select “No”, proceed to step 5.
- Using the Number buttons, enter a new password. Press [**ENTER**].
Your setting will be activated.

5
Press [**SETUP**] to exit.

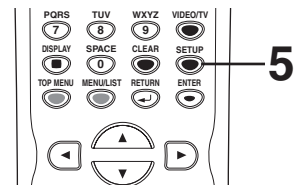

Note

- Press [**CLEAR**] to erase numbers entered incorrectly.
- Do not use 4, 7, 3, 7 as password.
- When you forget the password or you want to clear all settings in Parental lock, enter 4,7,3,7 using the **Number buttons** in input window at step B. Password will be cleared and parental levels will be set to “All”.

VCR functions

Playback

Playback



1 Press [POWER] on the remote control or the front panel of the unit.

When you are playing a videotape, turn the TV on and be sure to select the input to which the unit is connected.

Press:

2 Insert a prerecorded videotape. Press [PLAY ►] to begin playback.

3 During playback, press [PAUSE II].

Playback will pause and sound will be muted.

4 Press [PLAY ►] to resume play.

5 Press [STOP ■] to stop playback.

6 Press [STOP ■ / EJECT ▲] on the front panel of the unit to eject the videotape.

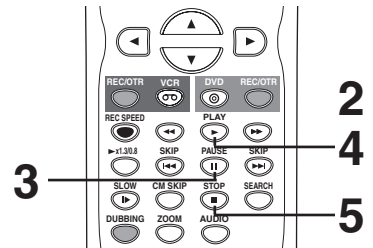
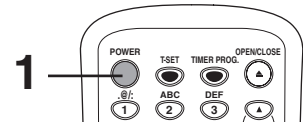

Note

- When a videotape without record tab is inserted, the unit will start playback automatically.
- Tracking will be automatically adjusted upon playback. To adjust the tracking manually, press [CHANNEL ▼ / ▲] on the front panel of the unit or [CH ▲ / ▼] on the remote control.

Recording and One-touch Timer Recording

Recording



First:

Before recording, make sure:

- The desired channel is selected by pressing the **Number buttons** or [CH ▲ / ▼] on the remote control or [CHANNEL ▼ / ▲] on the front panel of the unit.
- There is a videotape with a record tab in the unit.
- The desired recording speed is selected in SP (standard play) or SLP (super long play) mode by pressing [REC SPEED] on the remote control.

Recording speed:

Tape speed Type of tape	Recording/Playback Time		
	T60	T120	T160
SP mode	1hour	2hours	2-2/3hours
SLP mode	3hours	6hours	8hours

- Stereo or SAP is selected. Refer to page 21.
- Refer to page 31 for instructions on Timer Recording.

1 Press [REC/OTR] (VCR) to begin the recording.

To temporarily stop recording or to resume it, press [PAUSE II]. After the unit has been in Pause mode for 5 minutes, it will stop automatically to protect the videotape and the video head from damage.

2 Press [STOP ■] when the recording is completed.

Accidental erasure prevention

To prevent accidental recording on a recorded videotape, remove its record tab. To record on it later, cover the hole with cellophane tape.

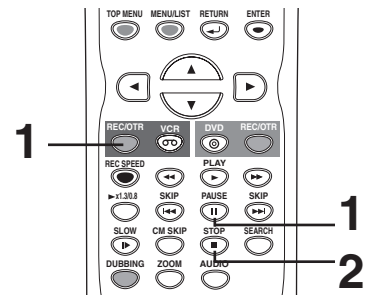
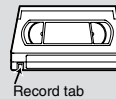

Note

- To view one channel while recording another
 - 1) While you are recording on the unit, press [VIDEO/TV].
 - 2) At the cable box or satellite box, select the channel you want to view.
 If you have connected the unit to a cable box or satellite box, refer to "Connection to a Cable Box or Satellite Box" section on page 15.

VCR functions

Recording and One-touch Timer Recording (cont'd)

One-touch Timer Recording



This feature allows you to set the recording length simply by pressing [REC/OTR] (VCR) on the remote control or [VCR RECORD] on the front panel of the unit.

1 During normal recording, press [REC/OTR] to begin One-touch Timer Recording.

You can select a fixed recording time by pressing [REC/OTR] (VCR) repeatedly.



When One-touch Timer Recording is finished, the unit will turn off automatically.

To change the recording length during the One-touch Timer Recording, press [REC/OTR] (VCR) repeatedly until the desired length appear.

To cancel the One-touch Timer Recording within the specified time, press [STOP ■].

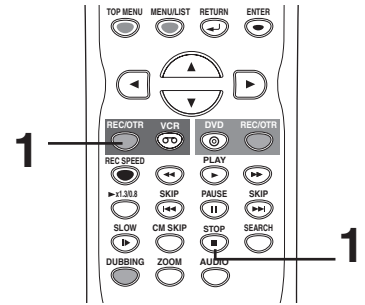

Note

- The remaining recording time will appear on the display panel during an One-touch Timer Recording. Press [DISPLAY] to see it on the TV screen.
- You cannot pause a One-touch Timer Recording.
- If OTR is finished in VCR during playback or REC mode in DVD, the VCR will be in STOP mode and the DVD keeps the current mode.
- Unlike a Timer Recording, you can perform the following operations during a One-touch Timer Recording.
 - Turning the power off - Using [REC/OTR] (VCR) or [STOP ■].
 - When OTR is finished and the power is turned off, the unit will switch to the standby mode automatically if a Timer Recording has been programmed. Press [T-SET] to cancel the standby mode for using the unit continuously.

Search

Index search



An index mark will be assigned at the beginning of each recording you make. You may skip to a specific marked point by following the steps below.

First:

1 Press [SEARCH] so that the index search menu appears.

2 Using the Number buttons, enter the number of recordings you wish to skip within 30 seconds.

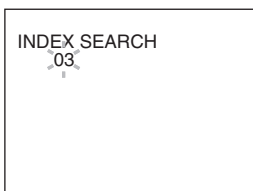

3 Press [◀◀], [▶▶] to start index search.

If you want to go in the forward direction, press [▶▶].

If you want to go in the reverse direction, press [◀◀].

After index search, the VCR will play the videotape automatically.

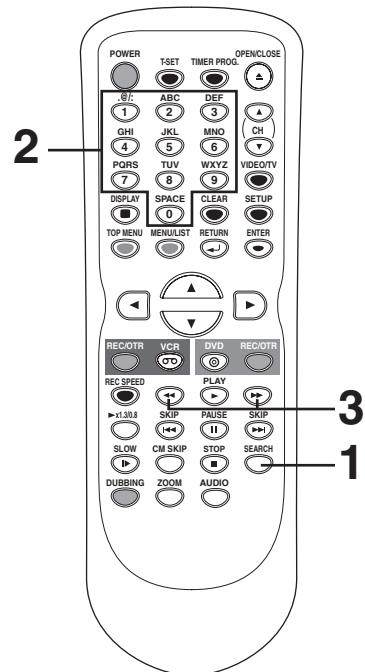
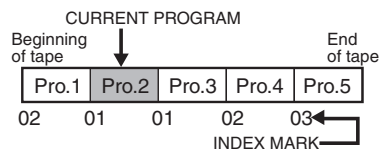

Note

- Every time a videotape is recorded, an index mark is written on the videotape.
- You can make the index mark up to 20.

VCR functions

Search (cont'd)

Time search



This feature allows you to go to a specific point on a videotape by entering the exact amount of time you wish to skip in order to reach the point.

First:

TIME SEARCH
2:50

1
Press [SEARCH] repeatedly so that the TIME SEARCH menu appears.

2
Using the Number buttons, enter your desired time to skip within 30 seconds.
You can set the time up to 9:59.

3
Press [◀], [▶] to start time search.

If you want to go in the forward direction, press [▶].

If you want to go in the reverse direction, press [◀].

After time search, the unit will play the videotape automatically.

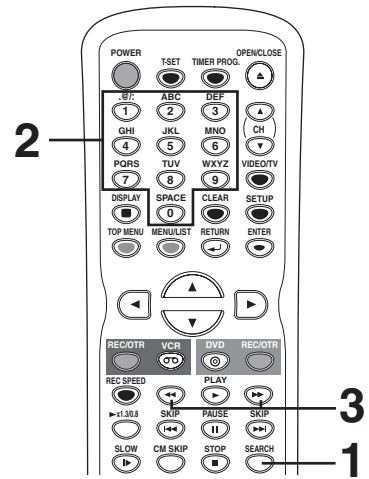

Note

- These functions are not available during recording.
- Press [STOP ■] to stop the search.
- If the end of the videotape is reached during Search, this unit will cancel the search and rewind the videotape.

Other operations



First:

Fast forward:

When the unit is in stop mode, press [▶▶] to fast forward the videotape.

Rewind:

When the unit is in stop mode, press [◀◀] to rewind the videotape.

To cue or review picture during playback (Picture Search):

Press [◀◀], [▶▶] during playback.

Press it again and the unit will search in super high speed. (in the SLP mode only)

To freeze the picture on TV screen during playback (Still Mode):

Press [PAUSE ||]. Each time you press the button, the picture will be forwarded by one frame.

If the picture begins to vibrate vertically during the Still Mode, stabilize the picture by pressing [CHANNEL ▼ / ▲] or [CH ▲ / ▼].

If the picture is distorted or rolling vertically, adjust the vertical hold control on your TV, if equipped.

Counter Reset:

Press [CLEAR].

To playback in slow motion:

Press [SLOW ▶] during playback or the Still Mode.

If the noise bars appear on the TV screen, you can reduce it by pressing [CHANNEL ▼ / ▲] or [CH ▲ / ▼].

Automatic Rewind

When a videotape is played or fast forwarded to its end, the videotape will rewind to the beginning, stop and eject itself.

When you playback a videotape recorded in Hi-Fi stereo:

Press [AUDIO] on the remote control to select Hi-Fi or MONO for playback sound mode.

- If you have connected a stereo TV to this unit, select "HIFI".
- If you have connected a monaural TV to this unit, select "MONO".

Your Selection Type of recorded tape	HIFI		MONO
	L-channel	R-channel	
non Hi-Fi tapes	Monaural	Monaural	Monaural
Hi-Fi tapes recorded in Hi-Fi stereo	L	R	L+R
Hi-Fi tapes recorded main audio program	Main audio program	Main audio program	Main audio program
Hi-Fi tapes recorded second audio program	Second audio program	Second audio program	Second audio program

Note

- Still/Slow/Pause mode will be automatically cancelled after 5 minutes to prevent damage to the videotape and the video head.
- To return to playback from the Picture Search/Still/Slow mode, press [PLAY ▶].

Others

Troubleshooting

Before requesting service for this unit, check the table below for a possible cause of the problem you are experiencing. Some simple checks or a minor adjustment on your part may eliminate the problem and restore proper performance.

Symptom	Remedy
The power does not turn on.	<ul style="list-style-type: none"> • Check that the AC power cord is connected securely. • (In case of power failure) Check the breaker. • Press [T-SET] to cancel the timer standby mode.
There is no picture.	<ul style="list-style-type: none"> • Re-connect the connecting cord securely. • The connecting cords are damaged. • Check the connection to your TV (page 14). • Check the RF output channel when you view a TV program using RF connection. • Switch the input selector on your TV (such as to "LINE1") so that the signal from this unit appears on the TV screen.
TV program reception does not fill the screen.	<ul style="list-style-type: none"> • Try to set the channels with "Auto Preset" in the Setup menu (page 19). • Select a channel of any TV program using the [CH ▲ / ▼]. • Press [VIDEO/TV] if necessary.
TV program pictures are distorted.	<ul style="list-style-type: none"> • Adjust TV antenna. • Adjust the picture (see the TV's instruction manual). • Place the unit and TV farther apart. • Place the TV and any bunched antenna cables farther apart.
TV channels cannot be changed.	<ul style="list-style-type: none"> • Switch the input to TV. • Connect the antenna cable correctly (page 14).
Playback picture is distorted.	<ul style="list-style-type: none"> • Keep the equipment which may cause electrical disturbances, such as a cellular phone, away.
The playback picture or TV program from the equipment connected through the unit is distorted.	<ul style="list-style-type: none"> • If the playback picture output from a DVD player, VCR or tuner goes through the unit before reaching your TV, the copy-protection signal applied to some programs could affect picture quality. Disconnect the playback equipment in question and connect it directly to your TV.
There is no sound.	<ul style="list-style-type: none"> • Re-connect all connections securely. • The connecting cord is damaged. • Check the connections to the amplifier input. • The input source setting on the amplifier is incorrect. • The unit is in pause mode or in Slow forward / Slow reverse play. • The unit is in fast forward or fast reverse mode.
The channel cannot be changed from the channel you are recording.	<ul style="list-style-type: none"> • Set the TV's input to "TV".
Nothing was recorded even though you set the timer setting correctly.	<ul style="list-style-type: none"> • There was a power failure during recording. • The internal clock of the unit stopped due to a power failure that lasted for more than 30 seconds. Reset the clock (pages 22-24). • Disconnect the AC power cord from the AC outlet, and connect it again. • The program contains copy protection signals that restricts copying. • The timer setting overlapped with another setting that was set later or has priority.
Timer Recording is not completed or did not start from the beginning.	<ul style="list-style-type: none"> • The timer setting overlapped with another setting that has priority (page 33). • Disc space was not enough.
Timer Recording is impossible.	<ul style="list-style-type: none"> • Make sure Ⓢ appears on the front panel display of this unit. If not, press [T-SET].
The remote control does not work.	<ul style="list-style-type: none"> • Check the antenna or cable connection to the main unit. • Check the battery life of the remote control. • Check if there is an obstacle between the sensor and the remote control. • Test the signal output. If OK, then possible remote sensor trouble. (Refer to "IR SIGNAL CHECK" on page 5.) • Press [DVDⓈ] or [VCRⓈ], whichever you need. Then, try again. • Press [T-SET] to cancel the timer standby mode. • If above remedies do not solve the problem, please call an Authorized Service Center for help.
The unit does not operate properly.	<ul style="list-style-type: none"> • When static electricity, etc., causes the unit to operate abnormally, unplug the unit and then plug it again.

D
V
D
•
V
C
R

Troubleshooting (cont'd)

Symptom	Remedy
There is no picture.	<ul style="list-style-type: none"> •The Setup Display appears. Press [RETURN ↵] (or [SETUP]) to turn off the display. •Check if the INTERLACE/PROGRESSIVE mode is set correctly according to your TV. See page 14.
Picture noise appears.	<ul style="list-style-type: none"> •The disc is dirty or flawed. •If the picture output signal from the unit passes through your VCR before reaching your TV, or if you are connected to a combination TV/VIDEO player, the copy-protection signal applied to some DVD programs could affect picture quality. If you still experience this problem even when you connect the unit directly to your TV, try connecting the unit to your TV's S-VIDEO input.
There is no sound.	<ul style="list-style-type: none"> •If the audio signal does not come through the DIGITAL OUT (COAXIAL) jack, check the Audio settings (pages 71-72). •The disc is dirty or flawed.
Sound is noisy.	<ul style="list-style-type: none"> •The disc is dirty or flawed.
No DTS sound is output.	<ul style="list-style-type: none"> •This unit is not compatible with DTS sound.
The unit does not play back the disc.	<ul style="list-style-type: none"> •No disc is inserted. •A blank disc is inserted. •The disc is upside down. Insert the disc with the labeled side facing up. •The disc is not correctly inserted. •The unit cannot playback certain discs (such as a CD-ROM) (page 40). •The region code on the DVD-Video does not match the ones on the unit (page 40). •Moisture has condensed inside the unit. Remove the disc and leave the unit turned on for about two hours until the moisture evaporates (page 4). •If the disc was recorded on another recorder, the unit cannot play back the disc unless it is finalized (page 36).
Playback image freezes for a second.	<ul style="list-style-type: none"> •During the playback of two layered disc, picture may freeze for a moment when the 1st layer switches to the 2nd layer. This is not a malfunction.
The disc does not start playback from the beginning.	<ul style="list-style-type: none"> •Resume play was activated (page 44). Press [STOP ■] twice. •You have inserted a disc whose Title menu or DVD menu automatically appears on the TV screen when it is first insert.
The unit starts playing back the disc automatically.	<ul style="list-style-type: none"> •The DVD-Video features an auto playback function.
Some functions such as Stop, Search, or Slow-motion Play cannot be performed.	<ul style="list-style-type: none"> •Depending on the disc, you may not be able to do some of those operations. See the instruction manual supplied with the disc.
The language for the sound track cannot be changed.	<ul style="list-style-type: none"> •Multilingual tracks are not recorded on the DVD-Video, DVD-R or DVD-RW being played back. •The DVD-Video prohibits the changing of the language for the sound track. •Try changing the language using the DVD-Video's menu.
The subtitle language cannot be changed or turned off.	<ul style="list-style-type: none"> •Multilingual subtitle are not recorded on the DVD-Video. •The DVD-Video prohibits changing of the subtitles. •Try changing the subtitles using the DVD-Video's menu.
The angles cannot be changed.	<ul style="list-style-type: none"> •Multi-angles are not recorded on the DVD-Video being played back. •The angle-change operation is possible as long as the disc contains a multi-angle portion. Actual change can be performed when the portion has come up. •The DVD-Video prohibits changing angles. •Try changing the angles using the DVD-Video's menu.
Recording does not stop immediately after you press [STOP ■] .	<ul style="list-style-type: none"> •It will take a few seconds for the unit to input disc data before recording can stop.
Recording does not start immediately after you press [REC/OTR] (DVD).	<ul style="list-style-type: none"> •An unused DVD-R or DVD-RW was inserted. It takes a while for the unit to automatically format a DVD-RW.
The disc tray does not open when you press [OPEN/CLOSE ▲] .	<ul style="list-style-type: none"> •It may take a few seconds for the disc tray to open after you have recorded or edited a disc. This is because the unit is adding disc data to the disc.

Troubleshooting (cont'd)

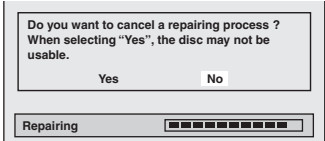
	Symptom	Remedy
D V D	<p>"Repairing" appears on the TV screen.</p>  <p>In a case you intend to cancel the Repairing process.</p> 	<ul style="list-style-type: none"> • If there is a power failure or unplugging during recording, finalizing, formatting or editing (even after "Wait for a moment." message is disappeared), a Repairing process will begin automatically just after turning the unit on again. It may take several minutes up to about four hours. • If you intend to cancel the Repairing process, press [OPEN/CLOSE ▲] on the front panel, then select "Yes" with [◀ / ▶] and press [ENTER]. After that, the disc tray will automatically open. In case the Repairing process is canceled, the disc MAY NOT work.

V C R	Picture noise appears.	<ul style="list-style-type: none"> • Head cleaning for VCR may be necessary. Refer to "AUTO HEAD CLEANING". • Adjust tracking control for better picture by pressing [CHANNEL ▼ / ▲] on this unit or [CH ▲ / ▼] while you are playing a videotape.
	The tape does not play.	<ul style="list-style-type: none"> • No videotape is inserted.
	Recording does not start immediately after you press [REC/OTR] (VCR).	<ul style="list-style-type: none"> • Make sure the videotape has a record tab when you record to a videotape. If needed, cover the hole with cellophane tape.
	The remote control does not function.	<ul style="list-style-type: none"> • Check if a videotape is in this unit.
	The motor rotates even when playback / recording is stopped.	<ul style="list-style-type: none"> • The motor may rotate for the duration of approximately 5 minutes for efficient operation. This is not a malfunction.

Error message	Cause	Solution
<div style="border: 1px solid black; padding: 2px; width: fit-content; margin-bottom: 5px;">Disc Error</div> <p>--- Please eject the disc. --- Playback feature may not be available on this Disc.</p>	<ul style="list-style-type: none"> • Unplayable disc is inserted in the unit. • The disc is upside down. 	<ul style="list-style-type: none"> • Insert the standardized disc which bear the marks on page 40. • Insert the disc with the labeled side facing up.
<div style="border: 1px solid black; padding: 2px; width: fit-content; margin-bottom: 5px;">Region Error</div> <p>--- Please eject the disc. --- Playback is not authorized in your region.</p>	<ul style="list-style-type: none"> • The region of the DVD-Video disc does not match the ones on the unit. 	<ul style="list-style-type: none"> • Insert the DVD-Video disc with region codes 1 or ALL.
<div style="border: 1px solid black; padding: 2px; width: fit-content; margin-bottom: 5px;">Parental Lock On</div> <p>The current selected parental level prohibits playback.</p>	<ul style="list-style-type: none"> • The current selected parental level in the Setup menu prohibits playback. 	<ul style="list-style-type: none"> • Check the "Parental Lock" setting (pages 73-74).
<div style="border: 1px solid black; padding: 2px; width: fit-content; margin-bottom: 5px;">Recording Error</div> <p>This program is not allowed to be recorded.</p>	<ul style="list-style-type: none"> • The recording function encountered the copy prohibited program. 	<ul style="list-style-type: none"> • You cannot record copy prohibited programs.
<div style="border: 1px solid black; padding: 2px; width: fit-content; margin-bottom: 5px;">Recording Error</div> <p>This program is not recordable in Video mode.</p>	<ul style="list-style-type: none"> • You are trying to record the copy-once program onto the DVD-RW disc in Video mode. 	<ul style="list-style-type: none"> • Set "Format mode" to "VR mode" (pages 27-28).
<div style="border: 1px solid black; padding: 2px; width: fit-content; margin-bottom: 5px;">Recording Error</div> <p>Can not record on this disc.</p>	<ul style="list-style-type: none"> • You are trying to record onto the disc which is unrecordable, or the disc status is unable to record. • The disc is dirty. • The disc is damaged. 	<ul style="list-style-type: none"> • Insert the recordable disc, and ensure the disc status satisfies the recording requirements (pages 25-26). • Clean the disc with a cleaning cloth. • Replace the disc.
<div style="border: 1px solid black; padding: 2px; width: fit-content; margin-bottom: 5px;">Recording Error</div> <p>This program is not allowed to be recorded on this disc.</p>	<ul style="list-style-type: none"> • You are trying to record the copy-once program onto the DVD-RW disc which is not compatible with CPRM. 	<ul style="list-style-type: none"> • Insert the DVD-RW disc in VR mode (ver.1.1 or 1.2 compatible with CPRM).
<div style="border: 1px solid black; padding: 2px; width: fit-content; margin-bottom: 5px;">Recording Error</div> <p>This disc is protected and not recordable.</p>	<ul style="list-style-type: none"> • You are trying to record on to the protected disc which is set in the Disc menu. 	<ul style="list-style-type: none"> • Release the disc protect setting in the Disc menu (page 35).
<div style="border: 1px solid black; padding: 2px; width: fit-content; margin-bottom: 5px;">Recording Error</div> <p>Disc is full. (No area for new recording)</p>	<ul style="list-style-type: none"> • You are trying to record onto the disc which has no space for recording. 	<ul style="list-style-type: none"> • Insert the recordable disc with enough recording space.

Troubleshooting (cont'd)

Error message	Cause	Solution
<p>Recording Error</p> <p>You cannot record more than 99 titles on one disc. (The maximum is 99)</p>	You are trying to record onto the disc on which the number of recording titles comes up to the maximum (99).	Delete unnecessary titles (pages 54, 57).
<p>Recording Error</p> <p>You cannot record more than 999 chapters on one disc. (The maximum is 999)</p>	You are trying to record onto the VR mode DVD-RW disc on which the number of recording chapters comes up to the maximum (999).	This unit cannot delete the original chapter. Delete unnecessary chapter marker using other DVD recorders. Delete unnecessary chapter markers (page 56).
<p>Recording Error</p> <p>You cannot record on this disc as Control Information is full.</p>	This disc has no space to write the Control Information when recording or deleting contents. When editing has been repeatedly performed, the control Information area may come up to be full even the recording area has enough space.	Delete unnecessary titles (pages 54, 57).
<p>Recording Error</p> <p>You cannot record on this disc as Power Calibration Area is full.</p>	When recordings are performed repeatedly onto an unstable disc, this area may come up to be full. Every time you insert a disc for recording, the disc's working area will be taken up. And if you repeat this frequently, it will be used up sooner and you may not be able to record full 99 titles.	Insert a new disc.
<p>Recording Error</p> <p>This disc is already finalized.</p>	You are trying to record onto the disc already finalized.	Release the finalizing for this disc (page 36).

* If you are still having trouble with this unit after checking Troubleshooting, write down the error code and the error description, and call our helpline mentioned on the front page to locate an Authorized Service Center.

RF output switch

You can watch the TV programs with the tuner of the unit. (Usually channel 3 or 4 of the TV is available for the RF converter setting.) Be sure to connect the unit to a TV using the RF cable. Refer to page 14.

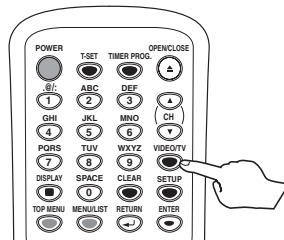

- Each time the RF output channel is changed, CH3 or CH4 will appear on the front panel display.

1
Select channel 3 on your TV.

2
Press [VIDEO/TV] on the remote control.

- If noise appears, change the RF output channel of the unit to CH 4 by pressing [VIDEO/TV] for 3 seconds. The RF output channel will alternate between CH3 and CH4 as follows.

for more than
3 seconds

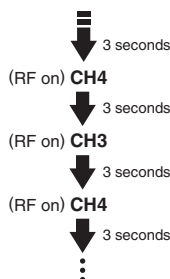

Glossary

Analog audio

An electrical signal that directly represents sound. In contrast, digital audio which can be an electrical signal, but is an indirect representation of sound. See also Digital audio.

Aspect ratio

The width of a TV screen relative to its height. Conventional TVs are 4:3 (in other words, the screen is almost square); widescreen models are 16:9 (the screen is almost twice as wide as it is high).

Chapter

Just as a book is split up into several chapters, a title on a DVD disc is usually divided into chapters. See also Title.

Component video output

This is a video signal format that conveys each of three principal colors of light (red, blue and green) through different signal lines. This allows the viewers to experience picture colors as original as it is. There are several signal formats, including Y/PB/PR and Y/CB/CR.

CPRM (Content Protection for Recordable Media)

This is a format used to record copy-once programs. By recording coded data on the area of DVD discs that ordinary writing software cannot write on, it prevents copy-once programs from being recorded repeatedly on different media.

Digital audio

An indirect representation of sound by numbers. During recording, the sound is measured at discrete intervals (44, 100 times a second for CD audio) by an analog-to-digital converter, generating a stream of numbers. On playback, a digital-to-analog converter generates

an analog signal based on these numbers. See also Sampling frequency and Analog audio.

Dolby Digital

The system developed by Dolby Laboratories to compress digital sound. It offers you sound of stereo(2ch) or multi-channel audio (up to 5.1ch).

Finalize

To make recorded contents on DVD discs possible to be played back on DVD players. With this unit, it is possible to finalize DVD-RW/DVD-R discs.

MP3 (MPEG Audio Layer 3)

MP3 is a method of compressing files. You can copy MP3 files on CD-RW/R discs from the computer and play back the files on this unit.

PCM (Pulse Code Modulation)

PCM is a format that converts audio into digital data. It is mainly used for Audio CDs and DAT. This unit can play back sounds as realistic as possible by converting even compressed Dolby Digital and MPEG audio to PCM.

Playlist

From this list you can play back contents of a disc in your desired order or sequence. Also it allows to search a specific scene directly.

Progressive Scan (525p/480p)

A type of display that does not split each frame into fields, and instead scans directly through all the scanlines of each frame in order. Progressive Scan provides less flickering and higher image resolution than traditional (525i/480i) TV signals. Refer to page 15 for instructions on selective Progressive Scan mode.

Regions code

Regions associate discs and players with particular areas of the world. This unit will only play back discs that have compatible region codes. You can find the region code of your unit by looking at the rear panel. Some discs are compatible with more than one region (or all regions).

Sampling frequency

The rate which sound is measured by a specified interval to turn it into digital audio data. The numbers of sampling in one second defines as sampling frequency. The higher the rate, the better the sound quality is.

SAP (Secondary Audio Program)

Sub audio channel which is delivered separately from main-audio channel. This audio channel is used as an alternate in bilingual broadcasting.

S-Video output

It delivers independently each signal of color(C) and luminance(Y) to TV as video signals, so that higher-quality picture will be materialized.

Title (DVD only)

A collection of chapters on DVD disc. See also chapter.

Track

Audio CDs use tracks to divide the content of a disc. The DVD equivalent is called a chapter. See also Chapter.

Language code

Language	Code	Language	Code	Language	Code	Language	Code
Abkhazian	4748	French	5264	Lithuanian	5866	Sindhi	6550
Afar	4747	Frisian	5271	Macedonian	5957	Singhalese	6555
Afrikaans	4752	Galician	5358	Malagasy	5953	Siswat	6565
Albanian	6563	Georgian	5747	Malay	5965	Slovak	6557
Amharic	4759	German	5051	Malayalam	5958	Slovenian	6558
Arabic	4764	Greek	5158	Maltese	5966	Somali	6561
Armenian	5471	Greenlandic	5758	Maori	5955	Spanish	5165
Assamese	4765	Guarani	5360	Marathi	5964	Sundanese	6567
Aymara	4771	Guiarati	5367	Moldavian	5961	Swahili	6569
Azerbaijani	4772	Hausa	5447	Mongolian	5960	Swedish	6568
Bashkir	4847	Hebrew	5569	Nauru	6047	Tagalog	6658
Basque	5167	Hindi	5455	Nepali	6051	Taiik	6653
Bengali; Bangla	4860	Hungarian	5467	Norwegian	6061	Tamil	6647
Bhutani	5072	Icelandic	5565	Occitan	6149	Tatar	6666
Bihari	4854	Indonesian	5560	Oriya	6164	Telugu	6651
Bislama	4855	Interlingua	5547	Oromo (Afan)	6159	Thai	6654
Breton	4864	Interlingue	5551	Paniabi	6247	Tibetan	4861
Bulgarian	4853	Inupiak	5557	Pashoti; Pushto	6265	Tigrinya	6655
Burmese	5971	Irish	5347	Persian	5247	Tonga	6661
Byelorussian	4851	Italian	5566	Polish	6258	Tsonga	6665
Cambodian	5759	Japanese	5647	Portuguese	6266	Turkish	6664
Catalan	4947	Javanese	5669	Quechua	6367	Turkmen	6657
Chinese	7254	Kannada	5760	Rhaeto-Romance	6459	Twi	6669
Corsican	4961	Kashmiri	5765	Romanian	6461	Ukrainian	6757
Croatian	5464	Kazakh	5757	Russian	6467	Urdu	6764
Czech	4965	Kinyarwanda	6469	Samoan	6559	Uzbek	6772
Danish	5047	Kirghiz	5771	Sango	6553	Vietnamese	6855
Dutch	6058	Kirundi	6460	Sanskrit	6547	Volapuk	6861
English	5160	Korean	5761	Scots Gaelic	6350	Welsh	4971
Esperanto	5161	Kurdish	5767	Serbian	6564	Wolof	6961
Estonian	5166	Laothian	5861	Serbo-Croatian	6554	Xhosa	7054
Faroese	5261	Latin	5847	Sesotho	6566	Yiddish	5655
Fiji	5256	Latvian; Lettish	5868	Setswana	6660	Yoruba	7161
Finnish	5255	Lingala	5860	Shona	6560	Zulu	7267

Frequently Asked Questions

- Can I record on CD-RW/R?
No, this unit records only DVDs.
- Can I play back DVD-Video that is bought in another country?
Possible only if the region code of the disc is 1 and ALL.
- Is this unit JPEG compatible?
No.
- Can I connect the unit to my PC?
No, you cannot control the unit by PCs.

Specifications

General			
System	DVD-Video, DVD-RW/R, CD-DA, CD-RW/R, Video Cassette Tape	Dimensions (width x height x depth)	17 3/16" x 3 15/16" x 10 5/16" (435 x 99.5 x 261 mm)
VCR video heads	Four heads	Operating temperature	41F° to 104F° (5°C to 40°C)
Power requirements	AC120 V, 60 Hz	Operating humidity	Less than 80% (no condensation)
Power consumption	30 W (standby: 3.0 W)	TV format	NTSC
Weight	9.5 lbs (4.3 kg)		
Recording			
Recording format	Video Recording format (DVD-RW only), Video format (DVD-RW, DVD-R)	Video recording format	
		Sampling frequency	13.5MHz
		Compression format	MPEG
Recordable discs	DVD-Rewritable, DVD-Recordable	Audio recording format	
		Sampling frequency	48kHz
		Compression format	Dolby Digital
Tuner			
Receivable channels		RF Converter	Built-in VHF converter
VHF	2-13ch	Converter output	VHF channel 3 or 4
UHF	14-69ch		
CATV	C1-C125ch		
Input / Output			
Video input	Input 1 (rear), 2 (front)	Video output	
Output level	1 Vp-p (75Ω)	Output level	1 Vp-p (75Ω)
Jacks	RCA jacks	Jack	RCA jack
S-Video input	Input 1 (rear), 2 (front)	S-Video output	
Y (luminance)		Y (luminance)	
- Input level	1 Vp-p (75Ω)	- Output level	1 Vp-p (75Ω)
C (color)		C (color)	
- Input level	286 mVp-p (75Ω)	- Output level	286 mVp-p (75Ω)
Jacks	4 pin mini DIN	Jack	4 pin mini DIN
Audio input	Input 1 (rear), 2 (front) L/R	Audio output	Output 1, 2 L/R
During audio input	2V rms (47kΩ)	During audio output	2V rms (47kΩ)
Jacks	RCA jacks	Jacks	RCA jacks
Component video output		Digital audio output	
Output level	Y: 1.0 Vp-p (75Ω), PB/CB, PR/CR: 0.7 Vp-p (75Ω)	Output level	500 mVp-p (75Ω)
Jacks	RCA jacks	Jack	RCA jack
		VHF/UHF antenna input/output terminal	VHF/UHF set 75Ω

Note:

The specifications and design of this product are subject to change without notice.

Fácil grabación de DVD

Estas instrucciones le ayudarán a entender fácilmente cómo grabar discos DVD.

Nota:

Asegúrese que las pilas están en el mando a distancia y que ha conectado correctamente esta unidad y el TV.

Paso 1: Elija un tipo de disco.

Puede elegir entre distintos tipos de discos DVD grabables. Elija un tipo de disco DVD grabable de acuerdo con sus necesidades de reproducción/grabación. Vea los "Tipos de discos DVD" en la parte inferior de esta página para más detalles sobre las diferencias entre los distintos medios compatibles.

Este grabador de DVD puede grabar los siguientes tipos de discos.

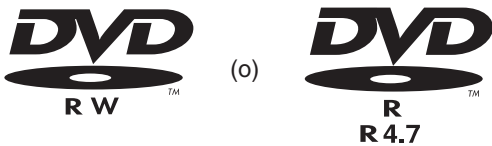

Por ejemplo, cuando desea grabar repetidamente en el mismo disco o cuando desea editar el disco después de grabar, seleccione el disco de tipo regrabable DVD-RW.

Cuando desea guardar grabaciones sin alterarlas, un DVD no regrabable DVD-R puede ser más conveniente.

Paso 2: Coloque un disco en blanco.

Mando a distancia

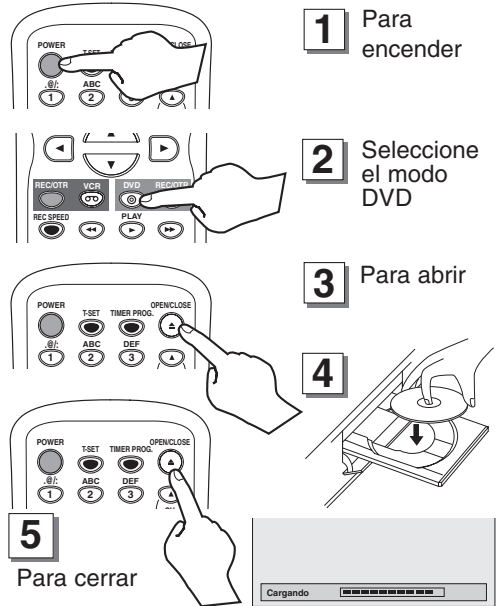

Esta operación puede demorar en reconocerse.

Tipos de discos DVD

☆☆☆ : Más adecuado ☆☆☆ : Puede utilizar ☆ : Algunas funciones son limitadas — : No puede utilizar

Desea	DVD-RW VR	DVD-RW Video	DVD-R
Grabar programas de TV	☆☆☆	☆☆☆	☆☆
Volver a utilizar borrando partes no deseadas	☆☆☆	☆☆	—
Editar las grabaciones	☆☆☆	☆	☆
Editar/grabar de equipos conectados	☆☆☆	☆☆☆	☆☆☆
Copiar discos para distribución	☆☆ ¹	☆☆☆	☆☆☆
Reproducir en otro equipo de DVD	☆☆ ¹	☆☆☆	☆☆☆

Detalles	DVD-RW VR	DVD-RW Video	DVD-R
Grabación			
¿Regrabable?	Sí	Sí	No
Puede crear capítulos a intervalos fijos (auto.)	Sí	Sí	Sí
Puede crear capítulos donde desee (manual)	Sí	No	No
Puede grabar imágenes de tamaño 16:9	Sí	Sí	Sí
Puede grabar un programa de Copia-una-vez	Sí	No	No
Edición			
Puede hacer funciones de edición básica	Sí	Sí	Sí
Puede hacer funciones de edición avanzadas (edición de lista a reproducir)	Sí	No	No

¹ El DVD-RW (modo VR) sólo puede reproducirse en equipos de DVD compatibles con VR.

Nota:
Para más detalles sobre las funciones anteriores y las limitaciones implícitas, lea las explicaciones en este manual.

Formato del disco

Cuando coloque un disco que fue grabado, puede borrar todo el contenido formateando el disco.

El formato es necesario para preparar el disco grabado previamente para grabar. Vea los detalles en las páginas 27-28.

Al formatear, todo el contenido de ese disco se borra.

- La unidad empieza a iniciar automáticamente cuando se inserta un disco DVD-RW no usado.

Fácil grabación de DVD (cont.)

Paso 3: Seleccione la velocidad de grabación.

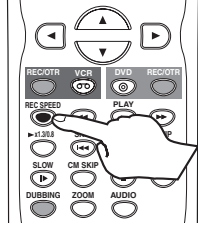

Paso 4: Seleccione el canal deseado.

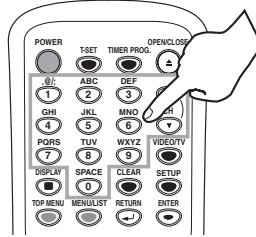

Paso 5: Grabe en discos DVD.

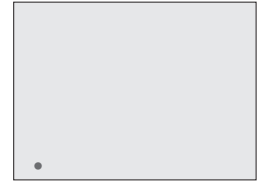
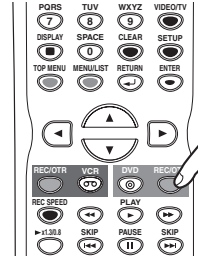

Sugerencia 1: Reproduzca el contenido grabado

Puede seleccionar el título que desea reproducir de un menú indicado y empiece a reproducir inmediatamente. El contenido grabado se puede acceder fácilmente con un simple procedimiento de elegir un título en un capítulo en la pantalla del menú.

¿Qué son títulos y capítulos?

El contenido de un disco DVD se divide generalmente en títulos. Los títulos pueden dividirse a su vez en capítulos.

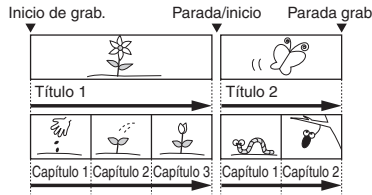

Sugerencia 2: Edite el disco grabado

La edición de discos es fácil. Esta unidad ofrece convenientes funciones de edición que sólo son posibles con discos DVD-RW/R.

Puede editar lo siguiente de la lista de títulos.

- Poniendo nombres en títulos
- Seleccionando imágenes para índices
- Seleccionando/borrando marcadores de capítulos
- Borrado de títulos o escenas

(Las funciones editables dependen del modo de grabación y forma de edición.)

Original y Playlist (modo VR)

Puede editar las grabaciones en la lista a reproducir sin cambiar las grabaciones originales. Cualquier lista a reproducir no ocupa mucho espacio en el disco.

¿Qué significa "Original" o "Playlist"?

A lo largo de este manual encontrará Original y Playlist que se refieren a las grabaciones reales y la versión editada.

- La grabación **Original** se refiere a la grabación real en el disco.
- El **Playlist** se refiere a la versión editada del disco; cómo se va a reproducir la versión Original.

Finalización de un disco

- Para reproducir el disco en un reproductor DVD diferente, grabe el disco en el modo de vídeo y finalícelo.
- Después de finalizar un disco grabado en el modo de vídeo, usted no podrá editar ninguna información que se encuentre en este disco.
- Para un disco grabado en el modo VR, la edición podrá realizarse incluso después de la finalización.

Paso 6: Pare la grabación.

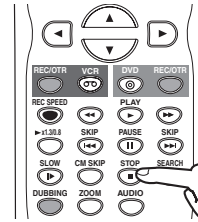

(Aparece sólo en el modo VR)

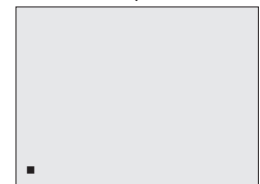

Esta operación puede demorar en completarse.



1

Presione [POWER] en el mando a distancia o el panel frontal de la unidad.

Cuando reproduzca una cinta, conecte el TV y asegúrese de seleccionar la entrada donde se conecta la unidad.

Presione: 

2

Coloque una cinta pregrabada y presione [PLAY ►] para empezar la reproducción.

3

Durante la reproducción, presione [PAUSE II].

Se hará una pausa de reproducción y se silenciará el sonido.

4

Presione [PLAY ►] para continuar la reproducción.

5

Presione [STOP ■] para detener la reproducción.

6

Presione [STOP ■ / EJECT ▲] en el panel frontal de la unidad para expulsar la cinta.

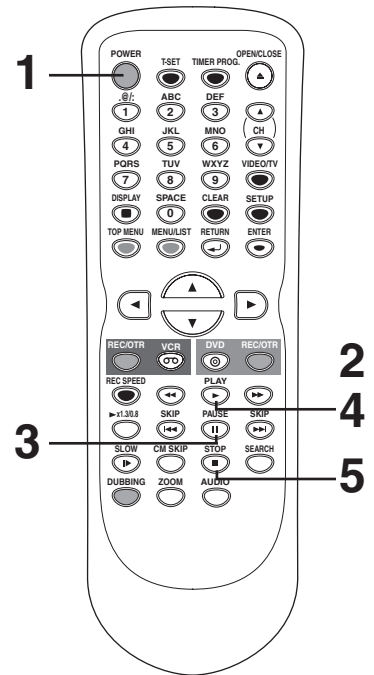

Nota

- Cuando se coloca una cinta sin la lengüeta de grabación, la unidad empezará a reproducir automáticamente.
- El seguimiento se ajustará automáticamente para la reproducción. Para ajustar manualmente el seguimiento, presione [CHANNEL ▼ / ▲] en el panel frontal de la unidad o los botones [CH ▲ / ▼] en el mando a distancia.

Grabación y grabación con temporizador de un toque (VCR)

Grabación



Antes de grabar, asegúrese de que:

- Se seleccionó el canal deseado presionando los botones numéricos en el mando a distancia o [CHANNEL ▼ / ▲] en el panel frontal de la unidad.
- Hay una cinta con la lengüeta para grabación intacta en la unidad.
- Se seleccionó la velocidad de grabación deseada en SP (reproducción estándar) o SLP (reproducción de super larga duración) presionando [REC SPEED] en el mando a distancia.

Velocidad de grabación:

Velocidad de la cinta	Tiempo de grabación/reproducción		
	T60	T120	T160
Tipo de cinta			
Modo SP	1 hora	2 horas	2-2/3 horas
Modo SLP	3 horas	6 horas	8 horas

- Se selecciona Estéreo o SAP.

1 Presione [REC/OTR] (VCR) para empezar la grabación.

Para detener temporalmente la grabación o continuarla, presione [PAUSE III]. Después de que la unidad haya estado en el modo de pausa durante 5 minutos, se detendrá automáticamente para proteger al cinta y el cabezal de video contra cambios.

2 Presione [STOP ■] cuando se complete la grabación.

Prevención contra borrado accidental

Para evitar una grabación por accidente en un casete grabado, rompa la lengüeta de grabación. Para volver a grabar posteriormente, cubra el orificio con cinta adhesiva.

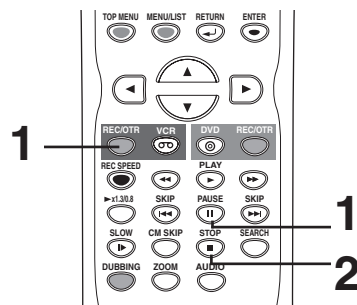

Nota

- Para ver un canal mientras graba en otro
 - 1) Mientras está grabando en la unidad, presione [VIDEO/TV].
 - 2) En la caja de cable o caja de satélite, seleccione el canal que desea ver.
 Si se conectó la unidad a una caja de cable o caja de satélite, consulte la sección de "Connection to a cable box or satellite box" en la página 15.

Grabación con temporizador de un toque (OTR)



Esta función permite seleccionar la longitud de la grabación simplemente presionando [REC/OTR] (VCR) en el mando a distancia o [VCR RECORD] en el panel frontal de la unidad.

1

Durante la grabación normal, presione [REC/OTR] (VCR) para empezar la grabación con temporizador de un toque.

Puede seleccionar un tiempo de grabación determinado presionando repetidamente [REC/OTR] (VCR).

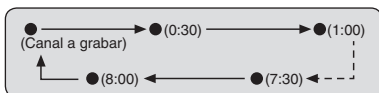

Cuando termina la grabación con temporizador de un toque, la unidad se desconectará automáticamente.

Para cambiar la longitud de tiempo durante la grabación con temporizador de un toque, presione repetidamente [REC/OTR] (VCR) hasta que aparezca la longitud deseada.

Para cancelar la grabación con temporizador de un toque dentro del tiempo especificado, presione [STOP ■].

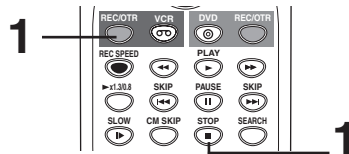

Nota

- El tiempo de grabación remanente aparecerá en la pantalla durante una grabación con temporizador de un toque. Presione [DISPLAY] para que aparezca en la pantalla de TV.
- No puede hacer una pausa en una grabación con temporizador de un toque.
- Si se termina el OTR en la videograbadora durante el modo de reproducción o REC en DVD, la videograbadora estará en el modo STOP y la DVD se mantiene en el modo actual.
- A diferencia de una grabación con temporizador, durante una grabación con temporizador de un toque usted puede realizar las operaciones siguientes.
 - Desconectar la alimentación
 - Utilizar [REC/OTR] (VCR) o [STOP ■].

SYLVANIA

LIMITED WARRANTY

FUNAI CORP. will repair this product, free of charge in the USA in the event of defect in materials or workmanship as follows:

DURATION:

PARTS: FUNAI CORP. will provide parts to replace defective parts without charge for one (1) year from the date of original retail purchase. Certain parts are excluded from this warranty.

LABOR: FUNAI CORP. will provide the labor without charge for a period of ninety (90) days from the date of original retail purchase.

LIMITS AND EXCLUSIONS:

This warranty is extended only to the original retail purchaser. A purchase receipt or other proof of original retail purchase will be required together with the product to obtain service under this warranty.

This warranty shall not be extended to any other person or transferee.

This warranty is void and of no effect if any serial numbers on the product are altered, replaced, defaced, missing or if service was attempted by an unauthorized service center. This limited warranty does not apply to any product not purchased and used in the United States.

This product is produced for home use and this warranty only covers failures due to defects in material or workmanship which occurs during normal use. It does not cover damage which occurs in shipment, or failures which are caused by repairs, alterations or product not supplied by FUNAI CORP, or damage which results from accident, misuse, abuse, mishandling, misapplication, alteration, faulty installation, improper maintenance, commercial use such as hotel, rental or office use of this product or damage which results from fire, flood, lightning or other acts of God.

THIS WARRANTY DOES NOT COVER PACKING MATERIALS, ANY ACCESSORIES (EXCEPT REMOTE CONTROL), ANY COSMETIC PARTS, COMPLETE ASSEMBLY PARTS, DEMO OR FLOOR MODELS.

FUNAI CORP. AND ITS REPRESENTATIVES OR AGENTS SHALL IN NO EVENT BE LIABLE FOR ANY GENERAL, INDIRECT OR CONSEQUENTIAL DAMAGES ARISING OUT OF OR OCCASIONED BY THE USE OF OR THE INABILITY TO USE THIS PRODUCT. THIS WARRANTY IS MADE IN LIEU OF ALL OTHER WARRANTIES, EX OR IMPLIED, AND OF ALL OTHER LIABILITIES ON THE PART OF FUNAI, ALL OTHER WARRANTIES INCLUDING THE WARRANTY OF MERCHANTABILITY AND FITNESS FOR A PARTICULAR PURPOSE, ARE HEREBY DISCLAIMED BY FUNAI AND ITS REPRESENTATIVES IN THE UNITED STATES. ALL WARRANTY INSPECTIONS AND REPAIRS MUST BE PERFORMED BY AN AUTHORIZED SERVICE CENTER. THIS WARRANTY IS ONLY VALID WHEN THE UNIT IS CARRIED-IN TO AN AUTHORIZED SERVICE CENTER.

IMPORTANT:

THIS LIMITED WARRANTY GIVES YOU SPECIFIC LEGAL RIGHTS. YOU MAY HAVE OTHER RIGHTS THAT VARY FROM STATE TO STATE. IF, AT ANY TIME DURING THE WARRANTY PERIOD, YOU ARE UNABLE TO OBTAIN SATISFACTION WITH THE REPAIR OF THIS PRODUCT, PLEASE CONTACT FUNAI CORP.

ATTENTION:

FUNAI CORP. RESERVES THE RIGHT TO MODIFY ANY DESIGN OF THIS PRODUCT WITHOUT PRIOR NOTICE.

To locate your nearest AUTHORIZED SERVICE CENTER or for general service inquiries, please contact us at:

FUNAI CORPORATION
Customer Service

Tel :1-800-605-8453

<http://www.SylvaniaConsumerElectronics.com>

19900 Van Ness Avenue, Torrance, CA 90501

Free Manuals Download Website

<http://myh66.com>

<http://usermanuals.us>

<http://www.somanuals.com>

<http://www.4manuals.cc>

<http://www.manual-lib.com>

<http://www.404manual.com>

<http://www.luxmanual.com>

<http://aubethermostatmanual.com>

Golf course search by state

<http://golfingnear.com>

Email search by domain

<http://emailbydomain.com>

Auto manuals search

<http://auto.somanuals.com>

TV manuals search

<http://tv.somanuals.com>