

Owner's Manual

Please read before using this unit.

DVD/CD Player with Video Cassette Recorder MSD805

MAGNAVOX
SMART. VERY SMART.

INSTRUCCIONES EN ESPAÑOL INCLUIDAS.

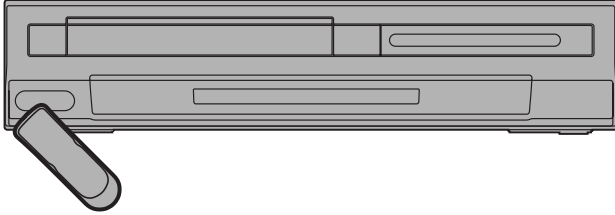

If you need additional operating assistance after reading this owner's manual, please call
TOLL FREE : 1-800-605-8610
or visit our web site at <http://www.funai-corp.com>

Table of Contents

Precautions

Laser Safety	2
■ IMPORTANT SAFEGUARDS	3
Installation Location	4
Avoid the Hazards of Electrical Shock and Fire	4
Moisture Condensation Warning	4
About Copyright	4
Notice for Progressive Scan Outputs	4
Symbols Used in This Manual	4
Maintenance	4
■ About the Video Cassettes and Discs	5
Playable Video Cassettes	5
Playable Discs	5
Unplayable Discs	5

Setup

■ Connections	6
RF Output Channel	6
Hint for Cable Box or Satellite Box	6
Connection to an Audio System	6
Connection to a TV	7
Front & Rear Terminals	7
■ Preparation for Use	8
Turn On the Unit for the First Time	8
To Add/Delete Channels	8
Clock Setup	8
■ Function Overview	9
Front Panel Indicator	9
VCR/DVD Switching	9
Remote Control	10
Installing the Batteries for the Remote Control	10

VCR Functions

■ Playback	11
■ Other Operations	11
Index Search	11
Time Search	11
Auto Repeat	12

Supplied Accessory

- Remote control (NB183UD) with two AA batteries
- RF cable (WPZ0901TM002)

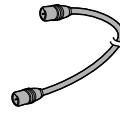

- Audio/Video cables (WPZ0102TM015 or WPZ0102LTE01)

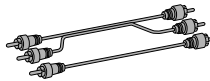

- Owner's Manual (1VMN20455)

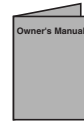

■ Recording	12
Recording & OTR (One Touch Recording)	12
Timer Recording	12
Hints for OTR and Timer Recording	13
Copying a Video Tape	14

DVD Functions

■ Playback	15
■ On-Screen Display	16
■ Search Function	17
Track Search / Title/Chapter Search / Time Search	17
■ Marker Setup	17
■ Repeat / Random / Programmed Playback	18
Repeat Playback / Repeat A-B Playback / Random Playback / Programmed Playback	18
■ Special Settings	19
Subtitle Language / Audio Language / Camera Angle / Black Level Setting / Stereo Sound Mode / Virtual Surround	19
■ DVD Setup	20
LANGUAGE Setting	20
DISPLAY Setting	21
AUDIO Setting	21
PARENTAL Setting	22
OTHERS Setting	22
Reset to the Default Setting (Except for PARENTAL Setting)	23

Information

■ Troubleshooting Guide	23
■ Specifications	24
■ Language List	24
■ Limited Warranty	24
Español	25
Quick Use Guide	27

Basic TV Connection

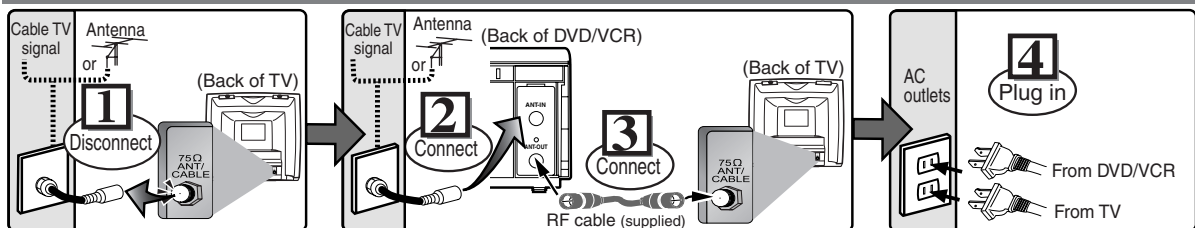

5 Please refer to "Connections" on page 6.

Precautions

Setup

VCR Functions

DVD Functions

Information

Español

Precautions

WARNING: TO REDUCE THE RISK OF FIRE OR ELECTRIC SHOCK, DO NOT EXPOSE THIS APPLIANCE TO RAIN OR MOISTURE.



CAUTION

**RISK OF ELECTRIC SHOCK
DO NOT OPEN**



The lightning flash with arrowhead symbol, within an equilateral triangle, is intended to alert the user to the presence of uninsulated "dangerous voltage" within the product's enclosure that may be of sufficient magnitude to constitute a risk of electric shock to persons.



The exclamation point within an equilateral triangle is intended to alert the user to the presence of important operating and maintenance (servicing) instructions in the literature accompanying the appliance.

CAUTION:

TO REDUCE THE RISK OF ELECTRIC SHOCK, DO NOT REMOVE COVER (OR BACK). NO USER SERVICEABLE PARTS INSIDE. REFER SERVICING TO QUALIFIED SERVICE PERSONNEL.

Laser Safety

This unit employs a laser. Only a qualified service person should remove the cover or attempt to service this device, due to possible eye injury.

CAUTION: USE OF CONTROLS OR ADJUSTMENTS OR PERFORMANCE OF PROCEDURES OTHER THAN THOSE SPECIFIED HEREIN MAY RESULT IN HAZARDOUS RADIATION EXPOSURE.

CAUTION: VISIBLE AND INVISIBLE LASER RADIATION WHEN OPEN AND INTERLOCK DEFEATED. DO NOT STARE INTO BEAM.

LOCATION: INSIDE, NEAR THE DECK MECHANISM.

FCC WARNING- This equipment may generate or use radio frequency energy. Changes or modifications to this equipment may cause harmful interference unless the modifications are expressly approved in the manual. The user could lose the authority to operate this equipment if an unauthorized change or modification is made.

RADIO-TV INTERFERENCE

This equipment has been tested and found to comply with the limits for a Class B digital device, pursuant to Part 15 of the FCC Rules. These limits are designed to provide reasonable protection against harmful interference in a residential installation. This equipment generates, uses, and can radiate radio frequency energy and, if not installed and used in accordance with the instructions, may cause harmful interference to radio communications. However, there is no guarantee that interference will not occur in a particular installation. If this equipment does cause harmful interference to radio or television reception, which can be determined by turning the equipment off and on, the user is encouraged to try to correct the interference by one or more of the following measures:

- 1) Reorient or relocate the receiving antenna.
- 2) Increase the separation between the equipment and receiver.
- 3) Connect the equipment into an outlet on a circuit different from that to which the receiver is connected.
- 4) Consult the dealer or an experienced radio/TV technician for help.

This Class B digital apparatus complies with Canadian ICES-003.

Cet appareil numérique de la classe B est conforme à la norme NMB-003 du Canada.

CAUTION: TO PREVENT ELECTRIC SHOCK, MATCH WIDE BLADE OF PLUG TO WIDE SLOT, FULLY INSERT.

ATTENTION: POUR ÉVITER LES CHOC ÉLECTRIQUES, INTRODUIRE LA LAME LA PLUS LARGE DE LA FICHE DANS LA BORNE CORRESPONDANTE DE LA PRISE ET POUSSER JUSQU'AU FOND.

A NOTE ABOUT RECYCLING

This product's packaging materials are recyclable and can be reused. Please dispose of any materials in accordance with your local recycling regulations.

Batteries should never be thrown away or incinerated but disposed of in accordance with your local regulations concerning chemical wastes.

Make your contribution to the environment!!!

- Used up batteries do not belong in the dust bin.
- You can dispose of them at a collection point for used up batteries or special waste. Contact your council for details.



For Customer Use:

Read carefully the information located at the back of this unit and enter below the Serial No. Retain this information for future reference.

Model No. _____

Serial No. _____

IMPORTANT SAFEGUARDS

1. Read Instructions - All the safety and operating instructions should be read before the appliance is operated.
2. Retain Instructions- The safety and operating instructions should be retained for future reference.
3. Heed Warnings - All warnings on the appliance and in the operating instructions should be adhered to.
4. Follow Instructions - All operating and use instructions should be followed.
5. Cleaning - Unplug this video product from the wall outlet before cleaning. Do not use liquid cleaners or aerosol cleaners. Use a damp cloth for cleaning. **EXCEPTION:** A product that is meant for uninterrupted service and, that for some specific reason, such as the possibility of the loss of an authorization code for a CATV converter, is not intended to be unplugged by the user for cleaning or any other purpose, may exclude the reference to unplugging the appliance in the cleaning description otherwise required in item 5.
6. Attachments - Do not use attachments not recommended by the video product manufacturer as they may cause hazards.
7. Water and Moisture- Do not use this video product near water, for example, near a bath tub, wash bowl, kitchen sink, or laundry tub, in a wet basement, or near a swimming pool, and the like.
8. Accessories - Do not place this video product on an unstable cart, stand, tripod, bracket, or table. The video product may fall, causing serious injury to a child or adult, and serious damage to the appliance. Use only with a cart, stand, tripod, bracket, or table recommended by the manufacturer, or sold with the video product. Any mounting of the appliance should follow the manufacturer's instructions and should use a mounting accessory recommended by the manufacturer. An appliance and cart combination should be moved with care. Quick stops, excessive force, and uneven surfaces may cause the appliance and cart combination to overturn.

PORTABLE CART WARNING
(Symbol provided by RETAC)



S3125A
9. Ventilation - Slots and openings in the cabinet are provided for ventilation and to ensure reliable operation of the video product and to protect it from overheating, and these openings must not be blocked or covered. The openings should never be blocked by placing the video product on a bed, sofa, rug, or other similar surface. This video product should not be placed in a built-in installation such as a bookcase or rack unless proper ventilation is provided or the manufacturer's instructions have been adhered to.
10. Power Sources - This video product should be operated only from the type of power source indicated on the marking label. If you are not sure of the type of power supply to your home, consult your appliance dealer or local power company. For products intended to operate from battery power, or other sources, refer to the operating instructions.
11. Grounding or Polarization - This video product is equipped with a polarized alternating-current line plug (a plug having one blade wider than the other). This plug will fit into the power outlet only one way. This is a safety feature. If you are unable to insert the plug fully into the outlet, try reversing the plug. If the plug should still fail to fit, contact your electrician to replace your obsolete outlet. Do not defeat the safety purpose of the polarized plug.
12. Power Cord Protection - Power supply cords should be routed so that they are not likely to be walked on or pinched by items placed upon or against them, paying particular attention to cords at plugs, convenience receptacles, and the point where they exit from the appliance.
13. Outdoor Antenna Grounding - If an outside antenna or cable system is connected to the video product, be sure the antenna or cable system is grounded so as to provide some protection against voltage surges and built-up static charges. Article 810 of the National Electrical Code, ANSI/NFPA No. 70, provides information with regard to

proper grounding of the mast and supporting structure, grounding of the lead-in wire to an antenna discharge unit, size of grounding conductors, location of antenna-discharge unit, connection to grounding electrodes, and requirements for the grounding electrode. (Fig. A)

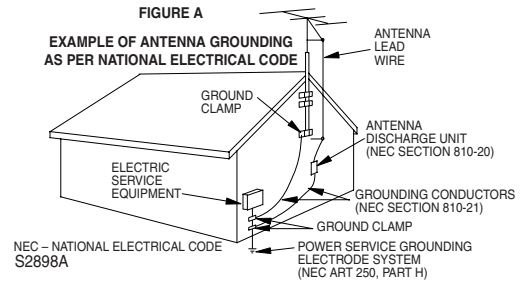

14. Lightning - For added protection for this video product during a lightning storm, or when it is left unattended and unused for long periods of time, unplug it from the wall outlet and disconnect the antenna or cable system. This will prevent damage to the video product due to lightning and power-line surges.
15. Power Lines - An outside antenna system should not be located in the vicinity of overhead power lines or other electric light or power circuits, or where it can fall into such power lines or circuits. When installing an outside antenna system, extreme care should be taken to keep from touching such power lines or circuits as contact with them might be fatal.
16. Overloading - Do not overload wall outlets and extension cords as this can result in a risk of fire or electric shock.
17. Object and Liquid Entry - Never push objects of any kind into this video product through any openings as they may touch dangerous voltage points or short-out parts that could result in a fire or electric shock. Never spill liquid of any kind on the video product.
18. Servicing - Do not attempt to service this video product yourself as opening or removing covers may expose you to dangerous voltage or other hazards. Refer all servicing to qualified service personnel.
19. Damage Requiring Service - Unplug this video product from the wall outlet and refer servicing to qualified service personnel under the following conditions:
 - a. When the power-supply cord or plug is damaged.
 - b. If liquid has been spilled, or objects have fallen into the video product.
 - c. If the video product has been exposed to rain or water.
 - d. If the video product does not operate normally by following the operating instructions. Adjust only those controls that are covered by the operating instructions as an improper adjustment of other controls may result in damage and will often require extensive work by a qualified technician to restore the video product to its normal operation.
 - e. If the video product has been dropped or damaged in any way.
 - f. When the video product exhibits a distinct change in performance this indicates a need for service.
20. Replacement Parts - When replacement parts are required, be sure the service technician has used replacement parts specified by the manufacturer or have the same characteristics as the original part. Unauthorized substitutions may result in fire, electric shock or other hazards.
21. Safety Check - Upon completion of any service or repairs to this video product, ask the service technician to perform safety checks to determine that the video product is in proper operating condition.
22. Heat - This video product should be situated away from heat sources such as radiators, heat registers, stoves, or other products (including amplifiers) that produce heat.

Installation Location

For safety and optimum performance of this unit:

- Do not stand the unit up vertically. Install the unit in a horizontal and stable position. Do not place anything directly on top of the unit. Do not place the unit directly on top of the TV.
- Shield it from direct sunlight and keep it away from sources of intense heat. Avoid dusty or humid places. Avoid places with insufficient ventilation for proper heat dissipation. Do not block the ventilation holes on the sides of the unit. Avoid locations subject to strong vibration or strong magnetic fields.
- Be sure to remove a disc and unplug the AC power cord from the outlet before carrying the unit.

Avoid the Hazards of Electrical Shock and Fire

- Do not handle the power cord with wet hands.
- Do not pull on the power cord when disconnecting it from AC wall outlet. Grasp it by the plug.
- If, by accident, water is spilled on this unit, unplug the power cord immediately and take the unit to our Authorized Service Center for servicing.
- Do not put your fingers or objects into the unit cassette holder.

Moisture Condensation Warning

Moisture condensation may occur inside the unit when it is moved from a cold place to a warm place, or after heating a cold room or under conditions of high humidity. Do not use this unit at least for 2 hours until its inside gets dry.

About Copyright

Unauthorized copying, broadcasting, public performance and lending of discs are prohibited. This product incorporates copyright protection technology that is protected by U.S. patents and other intellectual property rights. Use of this copyright protection technology must be authorized by Macrovision, and is intended for home and other limited viewing uses only unless otherwise authorized by Macrovision. Reverse engineering or disassembly is prohibited.

Notice for Progressive Scan Outputs

Consumers should note that not all high definition television sets are fully compatible with this product and may cause artifacts to be displayed in the picture. In case of picture problems with 525 progressive scan output, it is recommended that the user switch the connection to the 'standard definition' output. If there are questions regarding your TV set compatibility with this 525p DVD player, please contact our customer service center.

Symbols Used in This Manual

The following symbols appear in some headings in this manual.



: Description refers to playback or recording of video cassette tapes.



: Description refers to playback of DVD-Video discs.



: Description refers to playback of Audio CDs.

Maintenance

SERVICING

- Please refer to relevant topics on the "Troubleshooting Guide" on page 23 before returning the product.
- If this unit becomes inoperative, do not try to correct the problem by yourself. There are no user-serviceable parts inside. Turn off, unplug the power plug, and please call our help line mentioned on the front page to locate an Authorized Service Center.

CLEANING THE CABINET

- Use a soft cloth slightly moistened with a mild detergent solution. Do not use a solution containing alcohol, spirits, ammonia or abrasive.

CLEANING DISCS

- When a disc becomes dirty, clean it with a cleaning cloth. Wipe the disc from the center out. Do not wipe in a circular motion.
- Do not use solvents such as benzene, thinner, commercially available cleaners, detergent, abrasive cleaning agents or antistatic spray intended for analog records.

CLEANING THE DISC LENS

- If this unit still does not perform properly although you refer to the relevant sections and to "Troubleshooting Guide" in this Owner's Manual, the laser optical pickup unit may be dirty. Consult your dealer or an Authorized Service Center for inspection and cleaning of the laser optical pickup unit.

DISC HANDLING

- When you handle a disc, hold it by its edge and try not to touch the surface of the disc.
- Always store the disc in its protective case when it is not used.

AUTO HEAD CLEANING

- Automatically cleans video heads as you insert or remove a cassette, so you can see a clear picture.
- Playback picture may become blurred or interrupted while the TV program reception is clear. Dirt accumulated on the video heads after a long period of use, or the usage of rental or worn tapes can cause this problem. If a streaky or snowy picture appears during playback, the video heads in your unit may need to be cleaned.

1. Please visit your local Audio/Video store and purchase a good quality VHS Video Head Cleaner.
2. If a Video Head Cleaner does not solve the problem, please call our help line mentioned on the front page to locate an Authorized Service Center.

Hint

- Remember to read the instructions along with the video head cleaner before use.
- Clean video heads only when problems occur.

Note to CATV system installer

This reminder is provided to call the CATV system installer's attention to Article 820-40 of the NEC that provides guidelines for proper grounding and, in particular, specifies that the cable ground should be connected to the grounding system of the building, as close to the point of cable entry as practical.

Manufactured under license from Dolby Laboratories. "Dolby" and the double-D symbol are trademarks of Dolby Laboratories.

About the Video Cassettes and Discs

Playable Video Cassettes

Use only cassettes marked **VHS** with this unit.

Playable Discs

Playable discs	Mark (logo)	Region code	Recorded signals	Disc size	Disc types
DVD-Video * 1, 2, 4, 6		or	Digital video (MPEG2)	12 cm or 8cm	<p>Example</p> <p>Title 1 Chapter 1 Chapter 2 Chapter 3 Chapter 4 Title 2 Chapter 1 Chapter 2</p>
DVD-RW DVD-R * 1, 3, 4, 5, 6, 7, 9, 10	 	-			
DVD+RW DVD+R * 1, 3, 4, 5, 6, 8	 	-			
Audio CD * 4, 6		-	Digital audio	12 cm or 8cm	<p>Example</p> <p>Track 1 Track 2 Track 3 Track 4 Track 5 Track 6</p>
CD-RW CD-R * 4, 5, 6, 9, 10	 	-			

DVD is a trademark of DVD Format/Logo Licensing Corporation.

If you cannot play back a disc which bears one of the marks above, check the following notes.

- *1: This unit conforms to the NTSC color system. Discs recorded in other color systems such as PAL cannot be played back.
- *2: Certain DVD-Video discs do not operate as described in this manual due to the intentions of the disc's producers.
- *3: Discs recorded in the VR (Video Recording) format cannot be played back.
- *4: Scratched or stained discs may not be played back.
- *5: Some discs cannot be played back because of incompatible recording conditions, characteristics of the recorder or special properties of discs.
- *6: You can play back discs which bear the marks above. If you use nonstandardized discs, this unit may not play them back. Even if they are played back, the sound or video quality will be compromised.
- *7: You may play back the unfinalized DVD-R/RW disc recorded in the video format on our brand's DVD recorder. However, depending on the recording status of a disc, the disc may not be played back at all or normally (the picture or sound may not be smooth, etc.). In this case, you need to finalize the disc with the DVD recorder. Refer to the manual accompanying the DVD recorder.
- *8: Only the discs recorded in the video format and finalized can be played back. Unfinalized discs cannot be played back. Depending on the recording status of a disc, the disc may not be played back at all or normally (the picture or sound may not be smooth, etc.).
- *9: If there is too much recording space left on a disc (the used portion is less than 55 mm across), it may not play back properly.
- *10: Do not glue paper or put stickers on to the disc. These may damage the disc, and the unit may not read it correctly.

Unplayable Discs

- **NEVER play back the following discs. Otherwise, malfunction may result!**
DVD-RAM / CD-I / Photo CD / Video CD / DVD with region codes other than 1 or ALL / DTS-CD / DVD-ROM for personal computers / CD-ROM for personal computers
- **On the following disc, the sound MAY NOT be heard.**
Super Audio CD
NOTE: Only the sound recorded on the normal CD layer can be delivered.
The sound recorded on the high density Super Audio CD layer cannot be delivered.
- *Any other discs without compatibility indications.*

Setup

Connections

Please refer to "Basic TV Connection" on the front page before you use this unit.

RF Output Channel

If channel 3 is already occupied for broadcasting,

- 1) Set your TV to channel 4.
- 2) Insert a pre-recorded tape into this unit.
- 3) Hit [SOURCE] on the unit so that the VCR OUTPUT light is lit.
 - If noise appears on the TV screen, hit [VCR/TV] on the remote control.
- 4) Hit [PLAY ►] once.
- 5) After a few seconds, hit [PLAY ►] on the unit for 3 seconds.
 - The RF output channel will change to channel 4 from channel 3 and you will see a playback picture.
 - When a picture does not appear on the TV screen, repeat step 4).
- 6) Hit [STOP ■] to stop playback.

Hint

- The RF output channel may not change when you adjust tracking during playback. In this case, stop the playback, and start the playback again. After that, hit [PLAY ►] on the unit for 3 seconds again.

Hint for Cable Box or Satellite Box

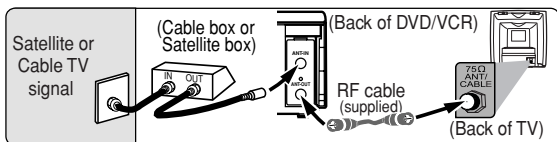

Select this connection when you want to view or record a scrambled channel. With this connection, channels cannot be changed on the unit. You can view or record ONLY the channels you have selected on the cable box or the satellite box.

- While you are recording, only the recorded channel can be viewed.

To select channels of the cable box or satellite box

- 1) Turn on the unit by hitting [STANDBY-ON], then hit [VCR/TV]. The "POWER-ON" light on the front panel will appear, then pressing [SKIP/CH. ►/▲ ◀/▼] to select channel 3 or 4 (the same channel as the output channel of the cable box or satellite box).
 - If you use the channel 4, you need to change the unit's RF output to channel 4. Refer to "RF Output Channel".
- 2) At the TV, select channel 3 or 4 (the same channel as you have selected at step 1).
- 3) On the cable box or satellite box, select the channel you want to view or record.

Connection to an Audio System

Method 1

Stereo system

AUDIO

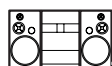

Analog audio input jacks

Audio cable (supplied)

(Analog) AUDIO OUT

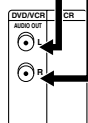

DVD/VCR

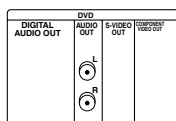

(DVD mode only)

Method 2

Dolby Digital decoder, MD deck or DAT deck



Digital audio input jack

Audio Coaxial Digital cable (commercially available)

DIGITAL AUDIO OUT

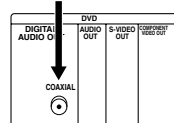

Connection	Setting	SETUP > AUDIO menu >
Connecting to Stereo System.		DOLBY DIGITAL PCM

* To complete these settings, refer to pages 20-21.

Hint

- Playing a DVD using incorrect settings may generate noise distortion and may also damage the speakers.

Connection	Setting	SETUP > AUDIO menu >
Connecting to a Dolby Digital decoder for Dolby Digital audio output.		DOLBY DIGITAL BITSTREAM
Connecting to the other equipment (an MD deck or DAT deck etc.) without Dolby Digital decoder.		PCM

* To complete these settings, refer to pages 20-21.

Hint

- The audio source on a disc in a Dolby Digital 5.1 channel surround format cannot be recorded as digital sound by an MD or DAT deck.
- By hooking this unit up to a Multi-channel Dolby Digital decoder, you can enjoy high-quality Dolby Digital 5.1 channel surround sound as heard in the movie theaters.
- Playing a DVD using incorrect settings may generate noise distortion and may also damage the speakers.

Connection to a TV

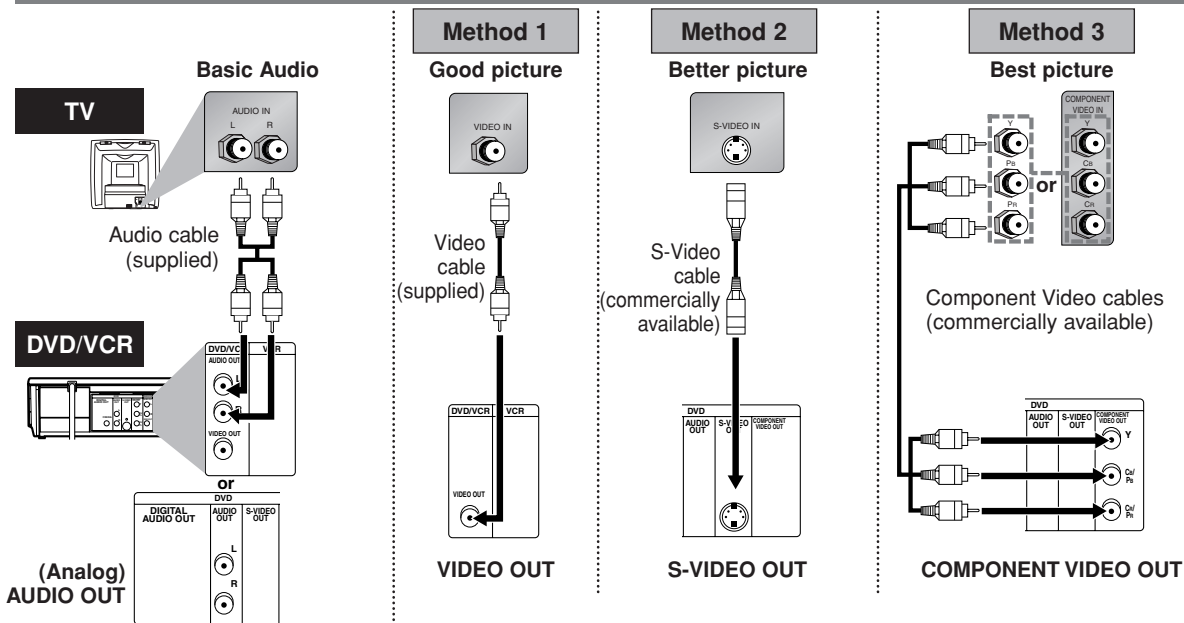

Hint

- Connect this unit directly to the TV. If the Audio/Video cables are connected to a VCR, pictures may be distorted due to the copy protection system.
- When progressive scanning mode is selected, no video signal will be output from the VIDEO OUT or S-VIDEO OUT jack.
- **The COAXIAL, DVD AUDIO OUT, S-VIDEO OUT and COMPONENT VIDEO OUT jacks are only useful in DVD mode.**

If your TV is compatible with 525p (480p) progressive scanning and you want to enjoy that high quality picture:

You must select the connection Method 3 above and progressive scanning mode. To set the mode, press and hold **[PLAY ▶]** on the front panel for more than 5 seconds, so that the P.SCAN indicator will appear on the display of this unit. (The progressive scanning is not available in the VCR mode.)

If your TV is not compatible with progressive scanning:

Use this unit in interlace mode. Make sure that no P.SCAN indicator is on the display of this unit. If not, press and hold **[PLAY ▶]** on this unit for more than 5 seconds, so that the P.SCAN indicator on the display of this unit will disappear.

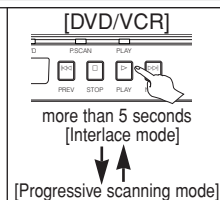

After you have completed connections

- Hit the input selector button (usually TV/VIDEO, INPUT or AUX) on your TV to switch an appropriate external input channel (usually near channel 0) for viewing the picture from this unit.
- If the picture does not appear, also refer to the manual accompanying your TV.

Input modes for common TV brands (Example)

- Listed below are inputs for common brand name TV's.

Admiral:	AUX
Curtis Mathis:	LINE1, LINE2, 00, 90, 91, 92, 93
GE:	INPUT, TV/VCR, 00, 90, 91, 92, 93
Hitachi:	INPUT, AUX
JVC:	A/V CHANNEL, INPUT1, SVIDEO, INPUT2
Kenwood:	AUX
LXI-Series:	00
Magnavox:	AUX CHANNEL

Panasonic:	TV/VIDEO
RCA:	INPUT, TV/VCR, 00, 90, 91, 92, 93
Samsung:	TV/VIDEO
Sanyo:	VIDEO
Sharp:	00
Sony:	VIDEO1, VIDEO2, VIDEO3
Toshiba:	TV/GAME
Zenith:	00

Front & Rear Terminals

DVD AUDIO OUT (analog) jacks

Connect the supplied audio cables here through the audio input jacks of a television or other audio equipment. (DVD only)

DVD/VCR AUDIO OUT jacks

Connect the supplied audio cable here through the audio input jacks of a television or other audio equipment.

AUDIO IN jack

Connect an audio cable coming from the audio output jack of a camcorder, another VCR or an audio source here.

ANT-IN jack

Connect your antenna or cable box here.

DIGITAL AUDIO OUT COAXIAL jack

Connect an optional coaxial digital audio cable here through the coaxial digital audio input jack of a decoder or audio receiver. (DVD only)

S-VIDEO OUT jack

Connect an optional S-Video cable here through the S-video input jack of a television. (DVD only)

COMPONENT VIDEO OUT jacks

Connect optional component video cables here through the component video input jacks of a television. (DVD only)

DVD/VCR VIDEO OUT jack

Connect the supplied video cable here through the TV's video input jack.

VIDEO IN jack

Connect a cable coming from the video output jack of a camcorder, another VCR or an audio-visual source (laser disc player, video disc player, etc.) here.

ANT-OUT jack

Connect the supplied RF cable to the antenna input jack on your TV.

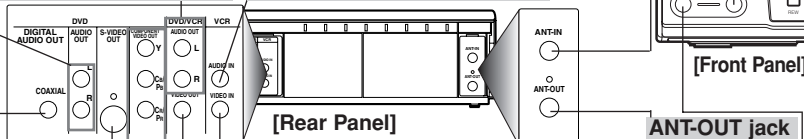

Preparation for Use

Turn On the Unit for the First Time



1 Turn on the TV and set it to channel 3.

- If channel 3 is already occupied for broadcasting, see "RF Output Channel" section.

2 STANDBY-ON (Remote Control) TV Screen

LANGUAGE SELECT

- ▶ ENGLISH [ON]
- FRANCAIS
- ESPAÑOL

3 CH 01

AUTO SET UP

Do you connect the cable from the cable box or the satellite box to the unit's ANT-IN jack?

Yes Hit [MENU] to exit.

- Refer to "Hint for Cable Box or Satellite Box" section on page 6.

No Please wait for a few minutes. After scanning...

- The tuner stops on the lowest memorized channel.
- You can select only the channels memorized in this unit by using [SKIP/CH. ►►/◄◄] or [CHANNEL ▲/▼].
- If "AUTO SET UP" appears on the TV screen again, check the cable connections. Then, hit [▶] once again.

Hint

- Repeat these steps only if either there was a power failure or this unit has been unplugged for more than 30 seconds.

To Select a Channel

You can select a channel using the **Number buttons** or [SKIP/CH. ►►/◄◄] on the remote control.

Notes for using the Number buttons:

- When selecting cable channels which are higher than 99, enter channel numbers as a three-digit number. (For example: 117, hit [1], [1], [7])
- You must precede single-digit channel numbers with a zero (for example: 02, 03, 04 and so on).

To Add/Delete Channels

1 MENU

- MENU -

- TIMER PROGRAMMING
- AUTO REPEAT [OFF]
- ▶ CHANNEL SET UP
- CLOCK SET
- LANGUAGE SELECT

• If the clock is not set, the CLOCK SET screen appears when you hit [MENU]. In this case, hit [MENU] again.

2 CHANNEL SET UP

- AUTO SET UP
- ▶ MANUAL SET UP

3 MANUAL SET UP

CHANNEL 30 (CATV)

ADD

Select the channel to be added or deleted.

4 MANUAL SET UP

CHANNEL 30 (CATV)

DELETE

Select "ADD" or "DELETE".

5 To exit the menu

CLEAR/C.RESET

To Preset the Channel Again

- 1) Hit [MENU] until the main menu appears.
- 2) Select "CHANNEL SET UP" by pressing [▲/▼], then hit [▶].
- 3) Select "AUTO SET UP" by pressing [▲/▼], then hit [▶]. After scanning, the tuner stops on the lowest memorized channel.

To Change the On-Screen Language

- 1) Hit [MENU] until the main menu appears.
- 2) Select "LANGUAGE SELECT" by pressing [▲/▼], then hit [▶].
- 3) Select "ENGLISH", "FRANCAIS" or "ESPAÑOL" by pressing [▲/▼], then hit [CLEAR/C.RESET].

Hint

- If you accidentally select Spanish or French and need English: hit [MENU] and choose SELEC. IDIOMA or SELECTION LANGUE. Hit [▶] and select ENGLISH. Finally, hit [CLEAR/C.RESET].

Clock Set Up



1 MENU

- MENU -

- TIMER PROGRAMMING
- AUTO REPEAT [OFF]
- ▶ CHANNEL SET UP
- CLOCK SET
- LANGUAGE SELECT

• If the clock is not set, the CLOCK SET screen appears when you hit [MENU]. In this case, go to step 2).

2 CLOCK SET

MONTH	DAY	YEAR
01	--	--
HOUR	MINUTE	AM/PM
--	--	--

Select the current month.

3 CLOCK SET

MONTH	DAY	YEAR
10	03	--
HOUR	MINUTE	AM/PM
--	--	--

Select the current day.

4 CLOCK SET

MONTH	DAY	YEAR
10	03	2005
HOUR	MINUTE	AM/PM
--	--	--

Select the current year.

5 CLOCK SET

MONTH	DAY	YEAR
10	03	MON 2005
HOUR	MINUTE	AM/PM
05	--	--

Select the current hour.

6

CLOCK SET
MONTH DAY YEAR
10 / 03 MON 2005
HOUR MINUTE AM/PM
05 : 40

Select the current minute.

7

CLOCK SET
MONTH DAY YEAR
10 / 03 MON 2005
HOUR MINUTE AM/PM
05 : 40

Select "AM" or "PM".

8 To exit the CLOCK SET screen

Hint

- To go back one step, hit [◀] (during steps 2) to 7)).
- Your clock setting will be lost if either there is a power failure or this unit has been unplugged for more than 30 seconds.

Function Overview

Front Panel Indicator

Lights up when power is on.

Lights up during a recording.
Flashes when a recording is paused.

Lights up when the inserted disc is being played back.
Flashes when an unacceptable disc is installed.

Lights up when the Timer Recording or an OTR recording has been set.

Lights up when the progressive scan system is activated.

VCR/DVD Switching

Because this product is a combination of a VCR and a DVD player, you must select first which component you wish to operate with **[SOURCE]**.

VCR MODE

Hit **[VCR]** on the remote control.
(Verify that the VCR OUTPUT light is lit.)

DVD MODE

Hit **[DVD]** on the remote control.
(Verify that the DVD OUTPUT light is lit.)

Hint

- Hitting only **[SOURCE]** on the front panel DOES NOT switch the mode of the remote control. You MUST select the correct mode on the remote control.

VCR button

DVD button

VCR OUTPUT light

DVD OUTPUT light

SOURCE button

Remote Control

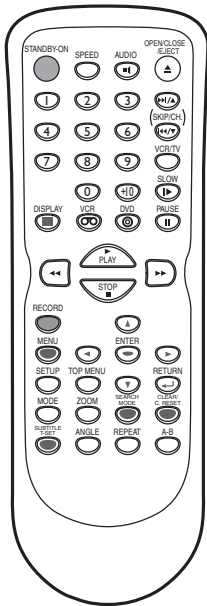

Setup

Installing the Batteries for the Remote Control

Install two AA batteries (supplied) matching the polarity indicated inside battery compartment of the remote control.

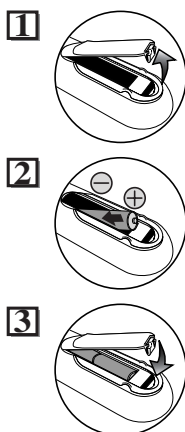

Keep in mind the following when using the remote control:

- Make sure that there is no obstacle between the remote control and the remote sensor on the unit.
- The maximum operable ranges from the unit are as follows.
 - **Beeline:** approx. 23 feet (7m)
 - **Either side of the center:** approx. 16 feet (5m) within 30°
 - **Above:** approx. 16 feet (5m) within 15°
 - **Below:** approx. 10 feet (3m) within 30°

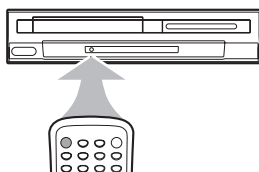

Button (Alphabetical order)	DVD mode		VCR mode
1 2 3 4 5 6 7 8 9 0	• To select chapter or title directly.	• To select track directly.	• To select channel. • The +10 button has no effect in VCR mode.
	• To search forward/backward through a disc. • To begin slow forward/reverse playback during the pause mode.	• To search forward/backward through a disc.	• To forward/backward a tape.
	• To move the cursor and determine its position.	• To move the cursor and determine its position.	<ul style="list-style-type: none"> • To select an item on the VCR Menu. • To advance to the next VCR Menu. • To go back one step during clock and timer setting.
A-B	• To repeat between your chosen point A and B.	• To repeat between your chosen point A and B.	—
ANGLE	• To select camera angles on a disc.	—	—
AUDIO	• To select audio languages on a disc.	• To select STEREO, L-ch or R-ch.	—
CLEAR/C.RESET	<ul style="list-style-type: none"> • To clear the markers. • To clear the numbers entered incorrectly. • To cancel the point for A-B repeat. 	<ul style="list-style-type: none"> • To clear the markers. • To remove status number in program input. • To clear the numbers entered incorrectly. • To cancel the point for A-B repeat. 	<ul style="list-style-type: none"> • To exit the VCR Menu. • To reset the tape counter.
DISPLAY	• To display the current disc mode.	• To display the current disc mode.	• To display the current time, tape counter, and channel.
DVD	<ul style="list-style-type: none"> • To select the DVD output mode. • To activate the remote control in DVD mode. 	<ul style="list-style-type: none"> • To select the DVD output mode. • To activate the remote control in DVD mode. 	—
MENU	• To call up the Menu on a disc.	—	• To call up the VCR Menu.
MODE	<ul style="list-style-type: none"> • To set black level on/off. • To set virtual surround on/off. 	<ul style="list-style-type: none"> • To arrange the playing order or play randomly. • To set virtual surround on/off. 	—
OPEN/CLOSE EJECT	• To open or close the disc tray.	• To open or close the disc tray.	• To eject the video cassette from the VCR.
PAUSE	<ul style="list-style-type: none"> • To pause disc playback. • To advance playback one frame at a time. 	• To pause disc playback.	<ul style="list-style-type: none"> • To pause tape playback or recording. • To advance playback one frame at a time.
PLAY	• To begin disc playback.	• To begin disc playback.	• To begin tape playback.
RECORD	—	—	• To start a recording or One Touch Recording.
REPEAT	• To play a chapter or title repeatedly.	• To play a track or disc repeatedly.	—
RETURN	• To return to the previous operation in menu.	• To return to the previous operation in menu.	—
SEARCH MODE	<ul style="list-style-type: none"> • To search chapter, title or time. • To set or search the markers. 	<ul style="list-style-type: none"> • To search track. • To search time. • To set or search the markers. 	• To call up the index or time search menu.
SETUP	• To call up the DVD setup menu.	• To call up the DVD setup menu.	—
SKIP/CH.	• To skip chapters.	• To skip tracks.	<ul style="list-style-type: none"> • To change channels. • To adjust the tracking manually during playback.
SLOW	—	—	• To view the tape in slow motion.
SPEED	—	—	• To select the recording speed.
STANDBY-ON	• To turn the unit on or off.	• To turn the unit on or off.	• To turn the unit on or off.
STOP	• To stop playback.	• To stop playback.	• To stop playback or recording.
SUBTITLE Y.SET	• To select subtitles on a disc.	—	• To put the VCR into standby mode for a Timer Recording.
TOP MENU	• To call up the Top Menu on a disc.	—	—
VCR	—	—	<ul style="list-style-type: none"> • To select the VCR output mode. • To activate the remote control in VCR mode.
VCR/TV	• To select DVD position or TV position.	• To select CD position or TV position.	• To select VCR position or TV position.
ZOOM	• To magnify part of a picture. (x2/x4)	—	—

Playback

Before:

Turn on the TV and set it to channel 3.

- If channel 3 is already occupied for broadcasting, see "RF Output Channel" section.



1 	2 To start playback
3 To stop playback 	4 To eject

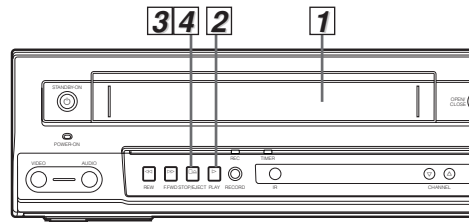
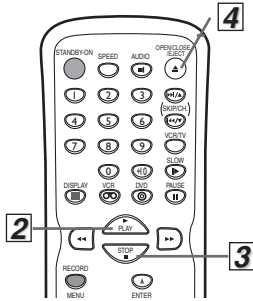

Hint

- When a tape without record tab is inserted, the unit will start playback automatically.
- Tracking will be automatically adjusted upon playback. To adjust the tracking manually, press [SKIP/CH. ►►/▲ ◄◄▼▼] (or [CHANNEL ▲/▼]).

Other Operations

To cue or review picture during playback (Picture Search)

Press [►►] or [◄◄] ([F.FWD ►►] or [REW ◄◄]).
• Press it again and the unit will search in super high speed. (in the SLP mode only)

To freeze the picture on TV screen during playback (Still mode)

- Hit [PAUSE ■■]. Each time you hit the button, the picture will be forwarded by one frame.
- If the picture begins to vibrate vertically during the still mode, stabilize the picture by pressing [SKIP/CH. ►►/▲ ◄◄▼▼] (or [CHANNEL ▲/▼]).
 - If the picture is distorted or rolling vertically, adjust the vertical hold control on your TV if equipped.

Counter Reset

Hit [CLEAR/C.RESET].

To play back in slow motion

- Hit [SLOW] during playback or the still mode.
- If the noise bars appear on the TV screen, you can reduce it by pressing [SKIP/CH. ►►/▲ ◄◄▼▼] (or [CHANNEL ▲/▼]).

Auto Rewind

When a tape reaches its end during playback, fast-forward or recording (except Timer Recording and One Touch Recording), the tape will automatically rewind to the beginning. After rewinding finishes, the unit will eject the tape.

Hint

- Still/Slow mode will be automatically cancelled after 5 minutes to prevent damage to the tape and the video head.
- To return to playback from the Picture Search/Still/Slow mode, hit [PLAY ▶].

Index Search

You can skip the program backward and forward by the Index Mark.



- Insert a tape into this unit.

1 SEARCH MODE
Hit once.

2 INDEX SEARCH 03

01 ~ 20

CURRENT PROGRAM

Beginning of the tape

End of the tape

INDEX MARK

3 To rewind
To fast forward

After searching,

4 PLAY ▶

Hint

- The Index Mark will be made automatically at the beginning of each recording.
- The time gap between Index Marks should be greater than 1 minute for SP mode, 2 minutes for LP mode and 3 minutes for SLP mode.

Time Search

You can search backward and forward a specific length of time on a tape.



- Insert a tape into this unit.

Hint for Index Search & Time Search

- These functions are not available during recording.
- Hit [STOP ■] to stop the search.
- If a tape ends during a search, your search will be cancelled and the tape will rewind to the beginning.

1 SEARCH MODE
Hit twice.

2 Select the desired length of time for fast forwarding or rewinding.

0:01 ~ 9:59
(1 minute~9 hours and 59 minutes)

3 To rewind
To fast forward

After searching,

4 PLAY ▶

Auto Repeat

This function will playback a tape repeatedly from the beginning when the tape reaches to the end.



1

MENU

- MENU -

- TIMER PROGRAMMING
- AUTO REPEAT [OFF]
- CHANNEL SET UP
- CLOCK SET
- LANGUAGE SELECT

2

- MENU -

- TIMER PROGRAMMING
- AUTO REPEAT [ON]
- CHANNEL SET UP
- CLOCK SET
- LANGUAGE SELECT

Hint

- To cancel Auto Repeat, follow steps 1)-2) above. Then, hit [▶], so that [OFF] appears beside AUTO REPEAT. Hit [CLEAR/C.RESET] to exit.
- If menu remains on the TV screen at step 3), hit [CLEAR/C.RESET] to exit.

Recording

Recording & OTR (One Touch Recording)

Before:

Turn on the TV and set it to channel 3.

- If channel 3 is already occupied for broadcasting, see "RF Output Channel" section.



1

with tab

2

1 2 3 or 4 5 6 or 7 8 9

- Select the channel to record.

3

Tape Speed	Recording/Playback Time		
Type of tape	T60	T120	T160
SP mode	1hour	2hours	2-2/3hours
SLP mode	3hour	6hours	8hour

SP

- Select the desired tape speed.

4

REC

Hit [RECORD] repeatedly to select the desired recording length.

REC (Normal recording) → OTR(0:30) → OTR(1:00).....

← OTR(8:00) ← OTR(7:30) ←

5

STOP

6

OPEN/CLOSE REJECT

5 6 4 1 2

Accidental erasure prevention

To prevent accidental recording on a recorded cassette, remove its record tab. To record on it later, cover the hole with adhesive tape.

Record tab

You **CAN NOT** copy a DVD to a videotape.

To stop recording temporarily (Pause mode)

Hit [PAUSE ■■].

- During the rec-pause mode, five ■ marks appear on the TV screen. Each ■ mark represents one minute.
- Hit it again to resume recording.
- Pause mode will be automatically cancelled after 5 minutes to prevent damage to the tape and the video head.

Hint

If you want to watch one channel while recording another.

- Hit [VCR/TV] to put the unit in TV position.
- Select a channel you want to watch with the TV, the cable box or the satellite box.

Timer Recording

Insert a tape with its record tab into the unit.



1

MENU

- MENU -

- TIMER PROGRAMMING
- AUTO REPEAT [OFF]
- CHANNEL SET UP
- CLOCK SET

TIMER PROGRAMMING

PROG 12345678

DATE

START TIME

Available program number flashes.

2

PROGRAM NUMBER 4

DATE ---/---/---

START TIME ---:--:--

END TIME ---:--:--

CHANNEL ---

REC SPEED --

Select an empty program number.

3

PROGRAM NUMBER 1

- ONCE
- DAILY
- WEEKLY

Select "ONCE", "DAILY" (Mon-Fri), or "WEEKLY".

4

Select the desired month.

ONE TIME PROGRAM

PROGRAM NUMBER 1

DATE 1 0 20 3-MON

START TIME ---:--:--

END TIME ---:--:--

CHANNEL ---

REC SPEED --

Select the desired day.

- You can program one year in advance.

5 Select the desired start time (hour).

ONE TIME PROGRAM
PROGRAM NUMBER 1
DATE 10/24 MON
START TIME 07:30
END TIME ---:--
CHANNEL ---
REC SPEED ---

Select the minute.

6

ONE TIME PROGRAM
PROGRAM NUMBER 1
DATE 10/24 MON
START TIME 07:30 PM
END TIME ---:--
CHANNEL ---
REC SPEED ---

Select "AM" or "PM".

7 Repeat the procedure in steps 5) and 6) to set the end time.

8

ONE TIME PROGRAM
PROGRAM NUMBER 1
DATE 10/24 MON
START TIME 07:30 PM
END TIME 08:30 PM
CHANNEL 3
REC SPEED ---

Select the desired channel.

- If you have connected the unit to a cable box or satellite box as the Connection on page 6, select the VCR to channel 3 or 4 (the RF output channel of the VCR). Then, select the desired channel at the cable box or satellite box. Leave the cable box or satellite box on for Timer Recording.

9

ONE TIME PROGRAM
PROGRAM NUMBER 1
DATE 10/24 MON
START TIME 07:30 PM
END TIME 08:30 PM
CHANNEL 3
REC SPEED SP
SLP

Select the desired recording speed.

- To set another program after step 9), hit [▶]. Then, continue with step 2).

10

SUBTITLE TSET

- The TIMER light on the front panel appears. The unit will change to the DVD mode.

Hint

- To go back one step, hit [◀] (during steps 3) to 9)).

To Check, Correct or Cancel a Timer Program

- 1) Hit [SUBTITLE/T-SET] then, [VCR] on the remote control.
- 2) Select main menu by hitting [MENU].
- 3) Select "TIMER PROGRAMMING" by pressing [▲/▼]. Then, hit [▶].
- 4) Select the program number which you want to check by pressing [▲/▼]. The details of the program you selected will appear on the TV screen.
 - Go to the digit you want to change by pressing [◀▶]. Then, enter correct numbers by pressing [▲/▼].
 - You may cancel the entire program by hitting [◀] while the program number flashes.
- 5) Hit [CLEAR/C.RESET] to exit.
- 6) Hit [SUBTITLE/T-SET] to return to timer stand-by mode.

To cancel a Timer Recording in progress

- Hit [STOP/EJECT ■▲] on the unit.

Hints for OTR and Timer Recording

- Hit [VCR] on the remote control before you set Timer Recording. Make sure the remote control is in the VCR mode, then hit [SUBTITLE/T-SET].
- If a tape is not in the unit or does not have the record tab, the TIMER light flashes and Timer Recording cannot be performed. Please insert a recordable tape.
- When Timer Recordings are set, the TIMER light will appear. To use the VCR as usual until the time for the recording, hit [SUBTITLE/T-SET] so that the TIMER light disappears. Hit [VCR/TV] to choose the VCR position. Select either VCR or DVD mode, then continue with the other features as described in this manual.

After an OTR or a Timer Recording has been set, this unit operates as follows:

- If a tape runs out before an OTR or a Timer Recording is finished, the unit ejects the tape and switches to the DVD mode automatically. If the DVD power is off, the unit does not switch to the DVD mode but goes into the timer standby mode. Press [SUBTITLE/T-SET] on the remote control or [STOP/EJECT ■▲] on the unit, then hit [VCR] to activate the VCR function again.
- Once the unit turns to the timer standby mode, no VCR functions are available until [SUBTITLE/T-SET] is hit. ([SOURCE] on the front panel and [VCR] on the remote control will not function.)
- To cancel the timer standby mode, press [SUBTITLE/T-SET] on the remote control or [STOP/EJECT ■▲] on the unit, then hit [VCR] to activate the VCR function again.
- The mode of the unit and the remote control may differ (VCR mode or DVD mode) when you set Timer Recording or after you cancelled Timer Recording. Press [VCR] or [DVD] on the remote control to select your desired mode before you operate.

When an OTR or a Timer Recording is completed...

- If Auto Power Off for DVD has been activated and there are Timer Recordings on standby, the unit turns off automatically, and the TIMER light appears to indicate the unit is in the timer standby mode.
- The TIMER light flashes if there are no more Timer Recordings on standby.
- If Auto Power Off for DVD has NOT been activated, the unit switches to the DVD mode and all the VCR function will be unavailable. The TIMER light will not appear as long as the DVD is in use. All the DVD functions are available during OTR, timer standby mode and Timer Recording.

If you want to use the DVD player during a Timer Recording or while the TIMER light appears or flashes.

- Hit [STANDBY-ON] to turn on the unit. Hit [DVD] on the remote control to choose DVD mode, then continue with the other DVD features as described in this manual. You don't need to set the TIMER off to use the DVD player.

NOTE (for Timer Recording) :

- If there is a power failure or the unit is unplugged for more than 30 seconds, clock and all timer settings will be lost.

Copying a Video Tape

Warning: Unauthorized recordings of copyrighted video tapes may be an infringement of copyright laws.

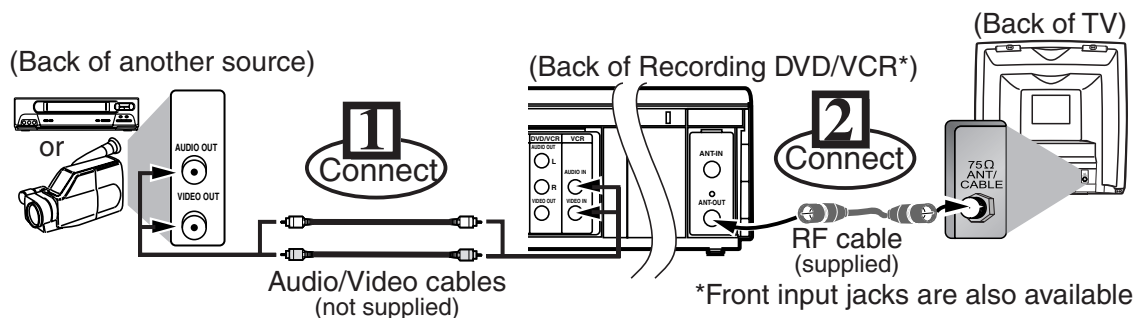

- 1) Insert a pre-recorded tape into the playing VCR.
- 2) Insert a tape with its record tab into the recording unit.
- 3) Hit **[SPEED]** on the remote control of the recording unit to select the desired recording speed (SP/SLP).
- 4) Select the "L1" or "L2" position on the recording unit.
 - To use the input jacks on the back of this unit, select "L1" position by pressing **[0], [0], [1]** on the remote control or **[CHANNEL ▲/▼]**.
 - To use the input jacks on the front of this unit, select "L2" position by pressing **[0], [0], [2]** on the remote control or **[CHANNEL ▲/▼]**.
- 5) Hit **[RECORD]** on the recording unit.
- 6) Begin playback of the tape in another source.
- 7) To stop recording, hit **[STOP/EJECT ■▲]** on the recording unit, then stop playback of the tape in another source.

Hint

- For best results during dubbing, use the front panel controls whenever possible. The remote control might affect another source's operation.
- Always use video-quality shielded cables with RCA-type connectors. Standard audio cables are not recommended.
- You can use a video disc player, satellite receiver or other audio/video component with A/V outputs.
- "L1" or "L2" is found before the lowest memorized channel. (Example: CH02)
- "L2" input jacks are on the front of this unit.

DVD Functions

Playback

Before: Turn on the TV, amplifier and any other components which are connected to this unit. Make sure the TV and audio receiver (commercially available) are set to the correct channel.

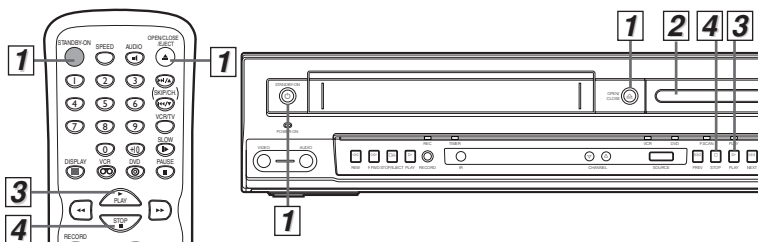
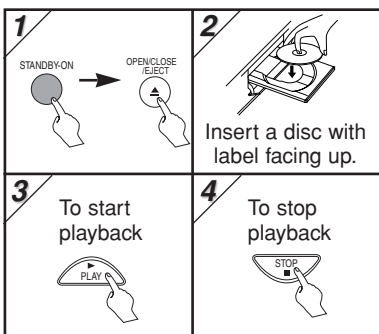

Hint

- A "prohibited icon" may appear at the top-right on the TV screen when the operation is prohibited by the disc or this unit.
- Some DVDs may be played from title 2 or 3 due to specific programs.
- During the playback of a two-layered disc, pictures may stop for a moment. This happens while the 1st layer is being switched to the 2nd layer. This is not a malfunction.

TIP:

You can change the on-screen language for DVD function in "PLAYER MENU" setting (Refer to page 20).

DVD menu

Some discs contain menus which allow you to customize DVD playback. Press [**▲** / **▼** / **◀** / **▶**] to select an item, then press [**ENTER**] (or [**PLAY ▶**]), to select.

Calling up a Menu Screen during Playback

- Hit [**MENU**] to call up the DVD menu.
- Hit [**TOP MENU**] to call up the title menu.

Hint

- Menu operations may vary depending on the disc. Refer to the manual accompanying the disc for details.

Resume



Hit [**STOP ■**] during playback. Resume message will appear on the TV screen.

Hit [**PLAY ▶**], playback will resume from the point at which playback was stopped.

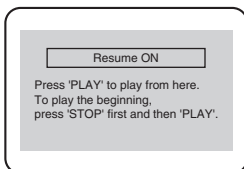

Hint

- To cancel resume, hit [**STOP ■**] one more time during the Stop mode.
- The resume information stays on even when the power is turned off.

Paused and Step-by-Step Playback



Hit [**PAUSE ■■**] during playback. To continue playback, hit [**PLAY ▶**].



The disc goes forward by one frame each time [**PAUSE ■■**] is hit during the pause mode. To continue playback, hit [**PLAY ▶**].

Hint

- On DVDs, set "STILL MODE" to "FIELD" in the Display menu if pictures in the pause mode are blurred. (Refer to pages 20-21.)

To use [**PREV ◀◀**], [**NEXT ▶▶**] on the Main Unit



Hit once to skip chapters or tracks to a desired point. Press and hold to change forward or reverse playback speed.

Fast Forward/Reverse Search



Press [**◀◀**] or [**▶▶**] repeatedly during playback to select the required forward or reverse speed. To continue playback, hit [**PLAY ▶**].

Hint

- For DVDs, fast forward or reverse search speed is different depending on the disc. Approximate speed is 1(x2), 2(x8), 3(x20), 4(x50), 5(x100).
- For Audio CDs, approximate speed is 1(x2), 2(x8), 3(x30).

Slow Forward/Slow Reverse



Press [**◀◀**] or [**▶▶**] repeatedly during the pause mode to select the required forward or reverse speed. To continue playback, hit [**PLAY ▶**].

Hint

- Slow forward or reverse speed is different depending on the disc. Approximate speed is 1(1/16), 2(1/8), 3(1/2).
- Set "STILL MODE" to "FIELD" in the Display menu if pictures in the slow playback mode are blurred. (Refer to pages 20-21.)

Zoom



- 1) Hit [**ZOOM**] during playback.
- 2) Hit [**ZOOM**] repeatedly to select the required zoom factor: x2, x4 or OFF.



- 3) Press [**▲** / **▼** / **◀** / **▶**] to slide the zoomed picture across the screen.
- 4) To exit zoom mode, hit [**ZOOM**] to select OFF.

Hint

- Zooming function does not work while the disc menu is showing up.
- x4 zoom is not available on some discs.
- The picture may be distorted when you press [**PAUSE ■■**] or [**◀◀**] repeatedly in the zoom mode.
- It may take several seconds to slide the zoomed picture.

On-Screen Display

You can check the information about the current disc by hitting **[DISPLAY]** on the remote control.

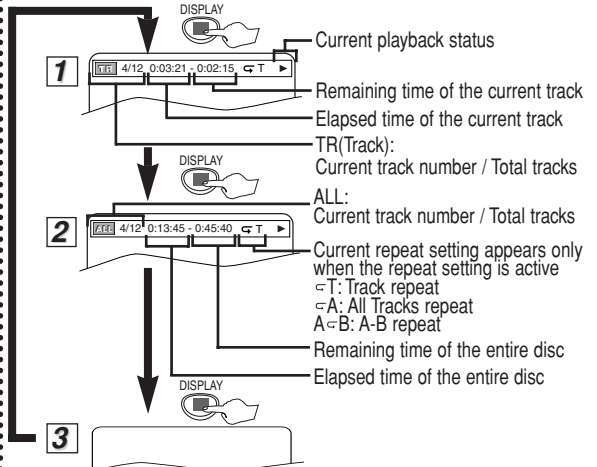
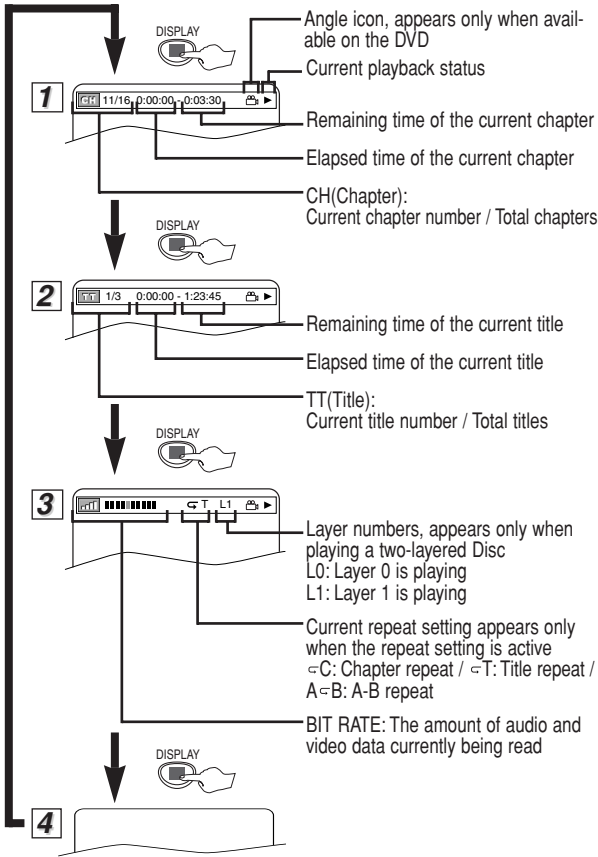

Hint

- When you are playing a disc in PROGRAM or RANDOM mode, **[TR]** PROGRAM (or RANDOM) will be displayed instead of **2**.

Search Function

Track Search



Using [SEARCH MODE]

1 SEARCH MODE

2 Within 30 seconds

- For the disc with less than 10 tracks, hit the track number directly.
- For discs with more than 10 but less than 99 tracks, to play single-digit track, hit [0] first, then the track number (e.g. for track 3, hit [0], [3]). To play a double-digit track, hit the track number.

Using [SKIP <<, >>]

1 Current Track (TR)

SKIP << SKIP >>

Hint

- [+10] button can also bring the Track Search display, except for the disc with less than 10 tracks. For such a disc, track search can be done by just hitting the track number.

Title / Chapter Search



Using [SEARCH MODE]

1 Hit once for the Chapter Search.
Hit twice for the Title Search.

2 Within 30 seconds

Using [SKIP <<, >>]

1 Current Chapter (CH)

SKIP << SKIP >>

or

Current Title (TT)

SKIP << SKIP >>

(If the disc has no chapters)

Hint

- Depending on the disc being played, this function can also be performed by directly entering the desired chapter number with the **Number buttons**. Refer to the manual accompanying the disc.
- For CDs, Track Search is not available for Programmed or Random Playback.

Time Search



1 Hit repeatedly until the Time Search display appears.

2 Within 30 seconds

Hint

- When there is no need to enter a number, "0" appears automatically. For example, "0:0:_" appears in the Time Search display if the total time of the title or track is less than 10 minutes.
- Hit [CLEAR/C.RESET] to erase the incorrect input at step 2).

Marker Setup



This feature allows you to assign a specific point on a disc to be called back later.

To set a marker

1 Hit repeatedly until this marker display appears.

2 or

3 at the desired marker

To return to the marker later

1 Hit repeatedly until this marker display appears.

2 or

3 at the desired marker

- Playback will restart from the specific point which you set.

To exit the marker screen

1

Hint

- The Marker display will disappear in about 30 seconds when there is no output.
- To clear a marker, select the marker to be cleared at step 2) in the section "To set a marker" or "To return to the marker later" and then hit [CLEAR/C.RESET].
- Opening the disc tray or turning off the power will erase all markers.
- Selecting "AC" at step 2) in the section "To set a marker" or "To return to the marker later" will also erase all markers.

Special Settings

Subtitle Language



This unit allows you to select a subtitle language (if available) during DVD playback.

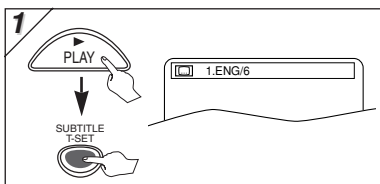

Each time you hit [SUBTITLE/T-SET], subtitle language changes as example below.

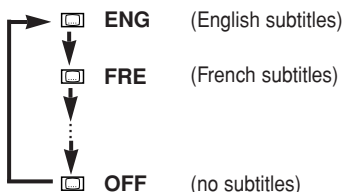

To set subtitle ON/OFF

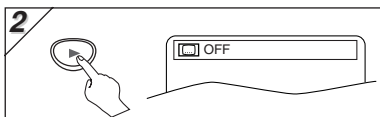
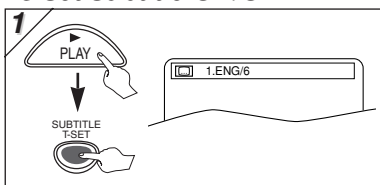

Hint

- If your language is not shown after pressing [AUDIO] or [SUBTITLE/T-SET] several times, the disc may not have that language. However, some discs allow audio language or subtitle language setting on the disc menu. (Operation varies depending on the discs, so refer to the manual along with the disc.)
- When "NOT AVAILABLE" appears on the TV screen, it means no subtitle is recorded on the scene.
- If you choose a language that has three-letter-language code, the code will be displayed every time you change the subtitle language setting. If you choose any other languages, '---' will be displayed instead. (Refer to page 24.)

Audio Language



This unit allows you to select an audio language (if multiple languages are available) during DVD playback.

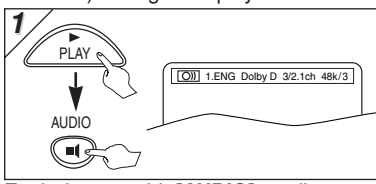

Each time you hit [AUDIO], audio language changes as example below.

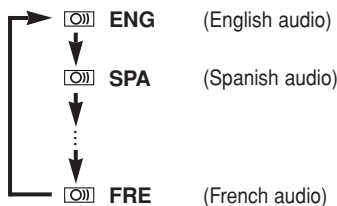

Camera Angle



Some DVD discs may contain scenes which have been shot simultaneously from various angles. You can change the camera angle if the icon appears on the screen. If the "ANGLE ICON" setting is "OFF" in the OTHERS menu, the icon will not appear. (Refer to pages 20-22.)

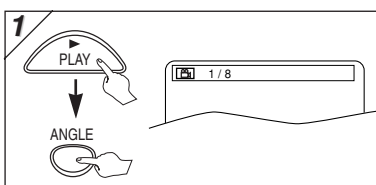

Black Level Setting



Adjust the Black Level Setting to make the dark areas of the TV picture brighter.

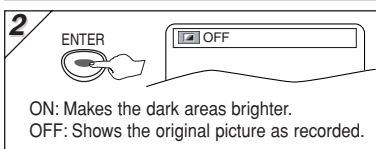
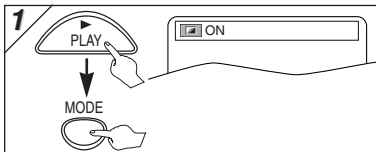

Stereo Sound Mode



This unit allows you to select a sound mode during CD playback.

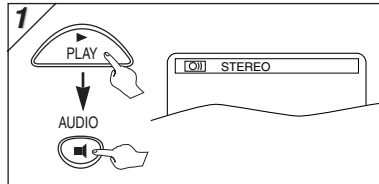

Each time you hit [AUDIO], sound mode changes as example below.

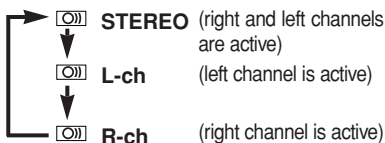

Virtual Surround



You can enjoy stereophonic virtual world on your existing 2 channel stereo system.

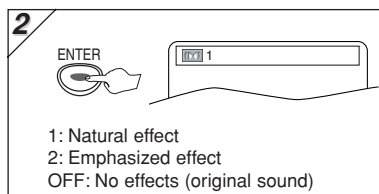
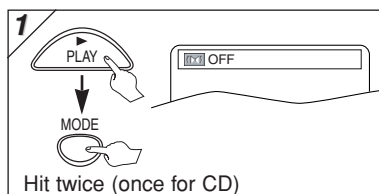



Hint

For CD play back only



- Virtual Surround will not be effective if the sound mode is set to something other than STEREO. Refer to "Stereo Sound mode".

QUICK SETUP Menu

You can select the "PLAYER MENU", "TV ASPECT", or "DOLBY DIGITAL" from the QUICK SETUP menu quickly.

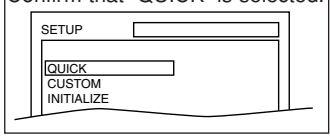
1  → 
 <SETUP MENU>
 Confirm that "QUICK" is selected.



2  or 
 Select the desired item.

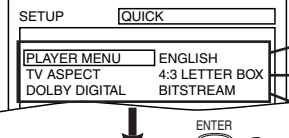



→ P20 **A** Step 5)
 → P21 **B** Step 5)
 → P21 **C** Step 5)

• Refer to the sections "PLAYER MENU", "TV ASPECT", or "DOLBY DIGITAL" section on page 20 or 21.



CUSTOM Menu

You can change the settings of the unit.

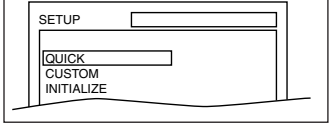

• **QUICK** on pages 20-22 indicates DVD Setup menus also accessible from the QUICK SETUP menu.

1  → 
 <SETUP MENU>

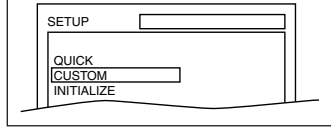

2  or 
 Select "CUSTOM".



3  or  → 
 Select the desired item.

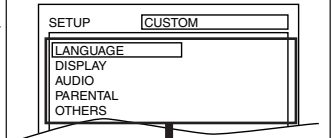

LANGUAGE menu **DISPLAY menu** **AUDIO menu** **PARENTAL menu** **OTHERS menu**

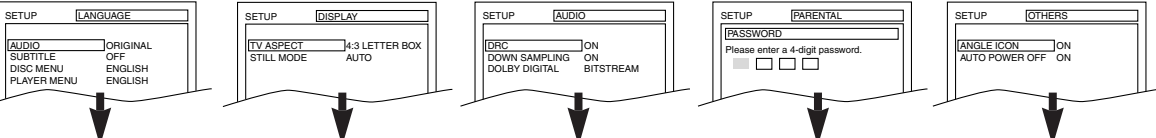

page 20 **A** page 21 **B** page 21 **C** page 22 **D** page 22 **E**

A LANGUAGE Setting

Follow step 1) to 3) in the "CUSTOM Menu" section on above.

4 Select the desired item.

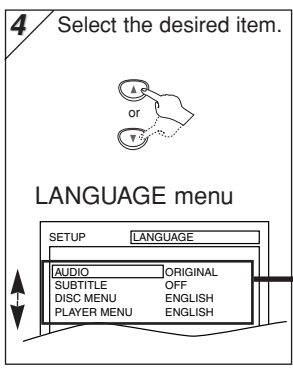

5 Select the desired language.

AUDIO: #1 #2 (Default: ORIGINAL)
 Sets the audio language.

SUBTITLE: #1 #2 (Default: OFF)
 Sets the subtitle language.

DISC MENU: #1 (Default: ENGLISH)
 Sets the language for DVD menu.

PLAYER MENU: QUICK (Default: ENGLISH)
 Sets the language for the On-screen display.

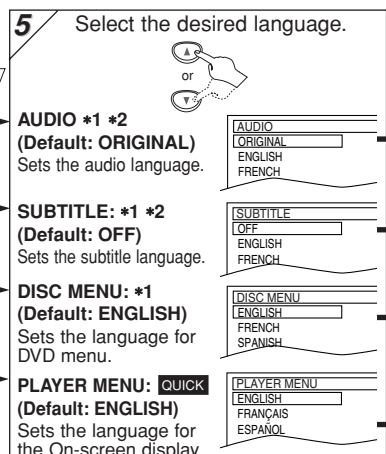

6 To exit the menu



Hint

- *1
 - Language options are not available with some discs.
 - If OTHER is selected on the AUDIO, SUBTITLE or DISC MENU screen, press four-digit number to enter the code for the desired language. (Refer to the language code list on page 24.)
 - Only the languages supported by the disc can be selected.
- *2
 - Language Setting for Audio and Subtitle are not available with some discs. Then use [AUDIO] and [SUBTITLE/T-SET]. Details are on page 19.

B DISPLAY Setting

You can change the display functions. Follow step 1) to 3) in the "CUSTOM Menu" section on page 20.

4 Select the desired item.

5

TV ASPECT: QUICK
(Default: 4:3 LETTER BOX)
See Hint to the right.

TV ASPECT 4:3 LETTERBOX
STILL MODE AUTO

TV ASPECT 4:3 LETTER BOX
4:3 PAN & SCAN
16:9 WIDE

Select the desired setting.

ENTER

STILL MODE:
(Default: AUTO)
See Hint to the right.

TV ASPECT 4:3 LETTERBOX
STILL MODE AUTO

STILL MODE AUTO
FIELD
FRAME

Select the desired setting.

ENTER

6 To exit the menu
SETUP

Hint

TV ASPECT:

- Select "4:3 LETTER BOX", so that black bars may appear on the top and bottom of the screen.
- Select "4:3 PAN & SCAN" for a full height picture with both sides adjusted.
- Select "16:9 WIDE" if a wide-screen TV is connected to this unit.

STILL MODE:

- Select "AUTO" usually.
- If you select AUTO, automatically select the best resolution setting (FRAME or FIELD) based on the data characteristics of the pictures. (default).
- If you select "FIELD", the picture in the still mode will be stabilized.
- If you select "FRAME", the picture in the still mode will be highly defined.
- An individual picture on TV screen is called as "frame", which consists of two separate images called as "field". Some pictures may be blurred at the AUTO setting in still mode due to their data characteristics.

C AUDIO Setting

Choose the appropriate audio settings for your equipment. It only affects during the playback of DVD discs. Follow step 1) to 3) in the "CUSTOM Menu" section on page 20.

4 Select the desired item.

5

DRC (Dynamic Range Control):
(Default: ON)
Set to "ON" to compress the range between soft and loud sounds.

DRC ON OFF
DOWN SAMPLING ON BITSTREAM BITSTREAM
DOLBY DIGITAL BITSTREAM

DOWN SAMPLING:
(Default: ON)
Set to "ON" when outputting in 48kHz.
Set to "OFF" when outputting the original sound.

DRC ON ON
DOWN SAMPLING ON BITSTREAM BITSTREAM
DOLBY DIGITAL BITSTREAM

DOLBY DIGITAL: QUICK
(Default: BITSTREAM)
Set to "BITSTREAM" when the unit is connected to a Dolby Digital receiver.

- BITSTREAM: Outputs a Dolby Digital Signals.
- PCM: Convert the Dolby Digital into PCM (2 channel).

DRC ON ON
DOWN SAMPLING ON BITSTREAM BITSTREAM
DOLBY DIGITAL BITSTREAM PCM

6 To exit the menu
SETUP

Hint

DRC:

- This function is available only on the discs which are recorded in the Dolby Digital format.

DOWN SAMPLING:

- When playing disc with copyright Protection, the sound will be down sampled at 48kHz, even if you set to "OFF".
- This function is available only on digital outputting of a disc recorded in 96kHz.

DVD Functions

D PARENTAL Setting

Parental Control limits the disc viewing that exceed your settings. (An incorrect password will not play.) This feature prevents your children from viewing inappropriate materials.

Parental Levels

Parental Level allows you to set the rating levels of your DVD discs. Playback will stop if the ratings exceed the levels you set. Follow steps 1) to 3) in the "CUSTOM Menu" section on page 20.

4 Enter your desired four-digit password (except for 4737).

5 Select "PARENTAL LEVEL".

6 Select the desired level.

7 To exit the menu

CONTROL LEVELS

- ALL: All parental locks are cancelled.
- Level 8: DVD softwares of any grades (adult/general/children) can be played back.
- Levels 7 to 2: Only DVD softwares intended for general use and children can be played back.
- Level 1: Only DVD softwares intended for children can be played back, with those intended for adult and general use prohibited.

TIPS FOR LEVELS

- 7 [NC-17]: No one under 17 admitted
- 6 [R]: Restricted; under 17 requires accompanying parent or adult guardian
- 4 [PG13]: Unsuitable for children under 13
- 3 [PG]: Parental Guidance suggested
- 1 [G]: General Audience

Hint

- DVD-Video discs may not respond to the parental lock settings. Make sure this function works with your DVD-Video discs.

If you have set a password already, enter the current four-digit password.

To Change the Password for Parental Controls

You can change your password for parental controls. Follow steps 1) to 3) in the "CUSTOM Menu" section on page 20.

4 Enter your desired four-digit password (except for 4737).

5 Select "PASSWORD CHANGE".

6 Enter your new four-digit password (except for 4737).

7 To exit the menu

Hint

- Record the password in case you forget it.
- If you forget the password, hit [4], [7], [3], [7] at step 4), then enter your new password.
- Password will be cleared and parental levels will be set to "ALL".

E OTHERS Setting

You can change the other functions. Follow steps 1) to 3) in the "CUSTOM Menu" section on page 20.

4 Select the desired item.

5

ANGLE ICON: (Default: ON)
Set to "ON" to show the angle icon when multiple camera angles are available during DVD playback.

AUTO POWER OFF: (Default: ON)
Set to "ON" to turn this unit off automatically after 30 minutes of no use.

6 To exit the menu

Reset to the Default Setting (Except for PARENTAL Setting)

1 Press the **STOP** button on the remote control, then the **SETUP** button.

2 Press the **ENTER** button.

3 Press the **ENTER** button.

4 Press the **ENTER** button twice.

Hint
• When you cancel to initialize at step 3), select "NO".

Information

Troubleshooting Guide

If this unit does not perform properly when operated as instructed in this Owner's Manual, check this unit consulting the following checklist.

	PROBLEM	CORRECTIVE ACTION
D V D	No power.	<ul style="list-style-type: none"> • Make sure the power plug is connected to an AC outlet. • Make sure the power is turned on.
	This unit does not respond to the remote control.	<ul style="list-style-type: none"> • Check if the power plug is connected to an AC outlet. • Check the batteries in the remote control. • Aim the remote control directly at the remote sensor. If necessary, remove all the obstacles between the sensor and the remote control. • You have to be within 23 feet of this unit. • Check if the right mode is selected. If it's not in the right mode, press [DVD] or [VCR], whichever you need, on the remote control. • Check if a cassette tape is in this unit. • Tune your radio to an empty AM station so that you hear a lot of noises. Turn the volume up, then if you hear some signal sound from the radio in response to your pressing buttons on the remote control, the remote control is working.
	Poor picture or noise.	<ul style="list-style-type: none"> • Interference signal may be received. Change the position and orientation of the unit.
V C R	Timer Recording is impossible.	<ul style="list-style-type: none"> • Make sure the Timer Recording is set correctly. • Make sure the TIMER light appears on the unit. If not, hit [SUBTITLE/T-SET]. • Make sure the VCR clock is set correctly.
	Cannot go into record mode.	<ul style="list-style-type: none"> • Make sure the tape has a record tab. If needed, cover the hole with adhesive tape. • Activate this unit in VCR mode. Hit [VCR] on the remote control so that the VCR OUTPUT light is lit.
	Playback picture is partially noisy.	<ul style="list-style-type: none"> • Adjust tracking control for a better picture by pressing [CHANNEL ▼/▲] on the unit or [SKIP/CH.▶▶/▲◀◀/▼] on the remote control.
	Cannot view a tape but the audio is OK.	<ul style="list-style-type: none"> • Head cleaning may be necessary. Refer to "AUTO HEAD CLEANING". • Make sure the VCR is not in the Menu mode.
	No or poor, playback picture.	<ul style="list-style-type: none"> • Change the RF output channel to CH4. Then select the same channel on the TV. • Fine tune your TV.
	TV programs cannot be seen normally.	<ul style="list-style-type: none"> • Re-check the ANT-IN and ANT-OUT connections. See pages 1 and 6. • Hit [VCR/TV]. • Hit [VCR] on the remote control to activate it in the VCR mode. Check if the VCR OUTPUT light is lit, then set it to the TV position by hitting [VCR/TV].
	Video or color fades in and out when making a copy of a video tape.	<ul style="list-style-type: none"> • You cannot copy a copyrighted video tape. You are experiencing copy guard protection.
Cannot remove the tape.	<ul style="list-style-type: none"> • Check if this unit is in the VCR mode. If not, hit [VCR] on the remote control to switch the mode. 	
D V D	No picture.	<ul style="list-style-type: none"> • Connect the video cables firmly. • Insert a correct video disc that plays on this unit. • Hit [DVD] on the remote control. Check if the DVD OUTPUT light is lit. Then try other DVD features. • Set PROGRESSIVE correctly. Turn it on only if your TV has Progressive Scan and you are using the Component Video connections between the unit and the TV. Disable Progressive Scan for all other connections. (See page 7.)
	Disc cannot be played.	<ul style="list-style-type: none"> • Insert the disc. • Clean the disc. • Place the disc correctly with the label side up. • Cancel the parental lock or change the control levels. • Handle a disc with special care so that it does not have fingerprints, scratches, or dusts on its surface.
	No sound.	<ul style="list-style-type: none"> • Connect the audio cables firmly. • Turn the power of the audio component on. • Correct the audio output settings. • Correct the input settings on the audio component.
	No DTS audio is output.	<ul style="list-style-type: none"> • This unit does not support DTS audio. This is not a malfunction.
	Distorted picture.	<ul style="list-style-type: none"> • Connect this unit directly to the TV. • There are some cases where pictures may be slightly distorted, and those are not a sign of a malfunction. • Although pictures may stop for a moment, this is not a malfunction. • Check if the INTERLACE/PROGRESSIVE mode is set correctly. See page 7.
	Audio or subtitle language does not match the setup.	<ul style="list-style-type: none"> • The selected language is not available for audio or subtitles on the DVD. • This is not a malfunction.
	The camera angle cannot be changed.	<ul style="list-style-type: none"> • The DVD does not contain sequences recorded from different camera angles. This is not a malfunction.
	Audio or subtitle language cannot be changed.	<ul style="list-style-type: none"> • The DVD does not contain audio source or subtitles in the selected language. • This is not a malfunction.
	"Prohibited icon" appears on the screen, prohibiting an operation.	<ul style="list-style-type: none"> • That operation is prohibited by this unit or the disc. • This is not a malfunction.

- Some functions are not available in specific modes, but this is not a malfunction. Read the description in this Owner's Manual for details on correct operations.
- Playback from a desired track and random playback are not available during program playback.
- Some functions are prohibited on some discs.

Specifications

Video Heads :
 Four Heads
 Output signal format :
 NTSC color
 Power source :
 120 V AC +/- 10%, 60 Hz +/- 0.5%
 Power consumption :
 21W (standby: 3.8W)

Operating temperature :
 41°F (5°C) to 104°F (40°C)
 Dimensions :
 W : 17-3/16" (435mm)
 H : 3-3/4" (94mm)
 D : 9-3/16" (233mm)
 Weight :
 Approx 6lbs (2.7kg)

- Designs and specifications are subject to change without notice.
- If there is a discrepancy between languages, the default language will be English.

Language List

Language	Code	Language	Code	Language	Code	Language	Code
A-B		French [FRE]	5264	Macedonian	5957	Siswat	6565
Abkhazian	4748	Frisian	5271	Malagasy	5953	Slovak	6557
Afar	4747	Galician	5358	Malay	5965	Slovenian	6558
Afrikaans	4752	Georgian	5747	Malayalam	5958	Somali	6561
Albanian	6563	German [GER]	5051	Maltese	5966	Spanish [SPA]	5165
Amharic	4759	Greek [GRE]	5158	Maori	5955	Sundanese	6567
Arabic	4764	Greenlandic	5758	Marathi	5964	Swahili	6569
Armenian	5471	Guarani	5360	Moldavian	5961	Swedish [SWE]	6568
Assamese	4765	Gujarati	5367	Mongolian	5960		
Aymara	4771	Hausa	5447	Nauru	6047	Tagalog	6658
Azerbaijani	4772	Hebrew	5569	Nepali	6051	Tajik	6653
Bashkir	4847	Hindi	5455	Norwegian [NOR]	6061	Tamil	6647
Basque	5167	Hungarian [HUN]	5467			Tatar	6666
Bengali; Bangla	4860					Telugu	6651
Bhutani	5072	I-K		Occitan	6149	Thai	6654
Bihari	4854	Icelandic [ICE]	5565	Oriya	6164	Tibetan	4861
Bislama	4855	Indonesian	5560	Oromo (Afan)	6159	Tigrinya	6655
Breton	4864	Interlingua	5547	Panjabi	6247	Tonga	6661
Bulgarian	4853	Interlingue	5551	Pashto; Pushto	6265	Tsonga	6665
Burmese	5971	Inupiak	5557	Persian	5247	Turkish [TUR]	6664
Byelorussian	4851	Irish [IRI]	5347	Polish	6268	Turkmen	6657
		Italian [ITA]	5566	Portuguese [POR]	6367	Twi	6669
C-E		Japanese [JPN]	5647	Quechua	6459		
Cambodian	5759	Javanese	5669	Rhaeto-Romance	6461	U-Z	
Catalan	4947	Kannada	5760	Romanian [RUM]	6467	Ukrainian	6757
Chinese [CHI]	7254	Kashmiri	5765	Russian [RUS]	6467	Urdu	6764
Corsican	4961	Kazakh	5757			Uzbek	6772
Croatian	5464	Kinyarwanda	6469	S		Vietnamese	6855
Czech	4965	Kirghiz	5771	Samoa	6559	Volapuk	6861
Danish [DAN]	5047	Kirundi	6470	Sangho	6553	Welsh	4971
Dutch [DUT]	6058	Korean [KOR]	5761	Sanskrit	6547	Wolof	6961
English [ENG]	5160	Kurdish	5767	Scots Gaelic	5350	Xhosa	7054
Esperanto	5161			Serbian	6564	Yiddish	5655
Estonian	5166	L-N		Serbo-Croatian	6554	Yoruba	7161
		Laothian	5861	Sesotho	6566	Zulu	7267
F-H		Latin	5847	Setswana	6660		
Faroese	5261	Latvian; Lettish	5868	Shona	6560		
Fiji	5256	Lingala	5860	Sindhi	6550		
Finnish [FIN]	5255	Lithuanian	5866	Singhalese	6555		

If you choose a Language that has a 3 letter language code, the code will be displayed every time you change the Audio or Subtitle language setting on page 19. If you choose any other languages, '---' will be displayed instead. (3 letter language code is written in bracket.)

MAGNAVOX LIMITED WARRANTY

FUNAI CORP. will repair this MAGNAVOX product, free of charge in the USA in the event of defect in materials or workmanship as follows:

DURATION:

PARTS: FUNAI CORP. will provide parts to replace defective parts without charge for one (1) year from the date of original retail purchase. Certain parts are excluded from this warranty.

LABOR: FUNAI CORP. will provide the labor without charge for a period of ninety (90) days from the date of original retail purchase.

LIMITS AND EXCLUSIONS:

This warranty is extended only to the original retail purchaser. A purchase receipt or other proof of original retail purchase will be required together with the product to obtain service under this warranty.

This warranty shall not be extended to any other person or transferee.

This warranty is void and of no effect if any serial numbers on the product are altered, replaced, defaced, missing or if service was attempted by an unauthorized service center. This MAGNAVOX Limited warranty does not apply to any product not purchased and used in the United States.

This product is produced for home use and this warranty only covers failures due to defects in material or workmanship which occurs during normal use. It does not cover damage which occurs in shipment, or failures which are caused by repairs, alterations or product not supplied by FUNAI CORP., or damage which results from accident, misuse, abuse, mishandling, misapplication, alteration, faulty installation, improper maintenance, commercial use such as hotel, rental or office use of this product or damage which results from fire, flood, lightning or other acts of God.

THIS WARRANTY DOES NOT COVER PACKING MATERIALS, ANY ACCESSORIES (EXCEPT REMOTE CONTROL), ANY COSMETIC PARTS, COMPLETE ASSEMBLY PARTS, DEMO OR FLOOR MODELS.

FUNAI CORP. AND ITS REPRESENTATIVES OR AGENTS SHALL IN NO EVENT BE LIABLE FOR ANY GENERAL, INDIRECT OR CONSEQUENTIAL DAMAGES ARISING OUT OF OR OCCASIONED BY THE USE OF OR THE INABILITY TO USE THIS PRODUCT. THIS WARRANTY IS MADE IN LIEU OF ALL OTHER WARRANTIES, EXPRESS OR IMPLIED, AND OF ALL OTHER LIABILITIES ON THE PART OF FUNAI, ALL OTHER WARRANTIES INCLUDING THE WARRANTY OF MERCHANTABILITY, AND FITNESS FOR A PARTICULAR PURPOSE, ARE HEREBY DISCLAIMED BY FUNAI AND ITS REPRESENTATIVES IN THE UNITED STATES. ALL WARRANTY INSPECTIONS AND REPAIRS MUST BE PERFORMED BY A FUNAI AUTHORIZED SERVICE CENTER. THIS WARRANTY IS VALID WHEN THE UNIT IS CARRIED-IN TO FUNAI AUTHORIZED SERVICE FACILITY.

IMPORTANT:

THIS LIMITED WARRANTY GIVES YOU SPECIFIC LEGAL RIGHTS. YOU MAY HAVE OTHER RIGHTS THAT VARY FROM STATE TO STATE. IF, AT ANY TIME DURING THE WARRANTY PERIOD, YOU ARE UNABLE TO OBTAIN SATISFACTION WITH THE REPAIR OF THIS PRODUCT, PLEASE CONTACT FUNAI CORP.

ATTENTION:

FUNAI CORP. RESERVES THE RIGHT TO MODIFY ANY DESIGN OF THIS PRODUCT WITHOUT PRIOR NOTICE.

To locate your nearest Funai Authorized Service Center or for general service procedure, please call or write to the following:

FUNAI CORPORATION, INC. SERVICE CENTER

19900 Van Ness Avenue, Torrance, CA 90501

Tel: 1-800-605-8610

<http://www.funai-corp.com>

Head Office: 100 North Street, Teterboro, NJ 07608

PLEASE DO NOT SHIP YOUR UNIT TO THE TETERBORO ADDRESS.

6 Reproducción de la grabadora de vídeo

Antes: Encienda el televisor y cambie al canal 3.

• Si el canal 3 se está utilizando para una transmisión, vea la sección "Canal de salida RF".

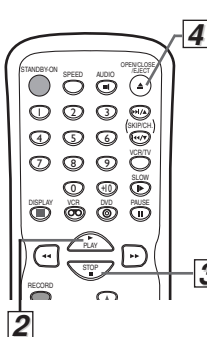

7 Reproducción de DVD/CD

Antes: Encienda el televisor, amplificador y otros equipos que puedan estar conectados a esta unidad. Asegúrese que el televisor y el sintonizador de audio (de venta en los comercios) están en el canal correcto.

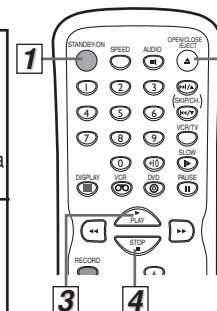
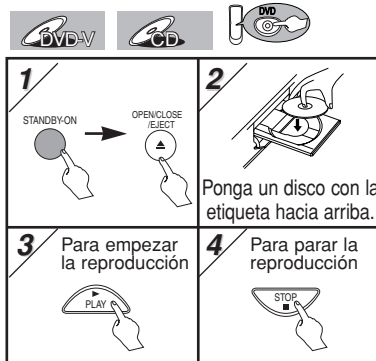

8 Control remoto

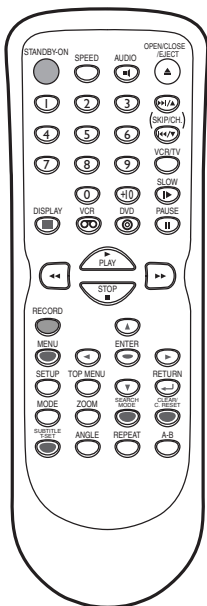

Botón (Orden alfabético)	Disco/cinta	Modo DVD	Modo de grabadora de vídeo
	• Para seleccionar directamente el capítulo o el título.	• Para seleccionar directamente la canción.	• Para seleccionar el canal. • El botón +10 no tiene efecto en el modo de grabadora de vídeo.
	• Para buscar en avance/retroceso en un disco. • Para empezar la reproducción en avance/retroceso lento durante el modo de pausa.	• Para buscar en avance/retroceso en un disco.	• Para el avance/retroceso de una cinta.
	• Para mover el cursor y determinar su posición.	• Para mover el curso y determinar su posición.	• Para seleccionar un ítem en el menú de la grabadora de vídeo. • Para avanzar el siguiente menú de la grabadora de vídeo. • Para volver un paso durante el ajuste del reloj y temporizador.
	• Para repetir entre los puntos A y B elegidos.	• Para repetir entre los puntos A y B elegidos.	—
	• Para seleccionar los ángulos de la cámara en un disco.	—	—
	• Para seleccionar el idioma de audio en un disco.	• Para seleccionar ESTÉREO, L-ch o R-ch.	—
	• Para borrar los marcadores. • Para borrar los números entrados incorrectamente. • Para borrar el punt para la repetición A-B.	• Para borrar los marcadores. • Para retirar el Nº de estado en la entrada de programa. • Para borrar los números entrados incorrectamente. • Para borrar el punt para la repetición A-B.	• Para salir del menú de la grabadora de vídeo. • Para reponer el contador de cinta.
	• Para indicar el modo de disco actual.	• Para indicar el modo de disco actual.	• Para indicar la hora actual, contador de cinta y canal.
	• Para seleccionar el modo de salida de DVD. • Para activar el mando a distancia en el modo DVD.	• Para seleccionar el modo de salida de DVD. • Para activar el mando a distancia en el modo DVD.	—
	• Para llamar el menú en un disco.	—	• Para llamar el menú de la grabadora de vídeo.
	• Para activar/desactivar el nivel del negro. • Para activar/desactivar el envolvente virtual.	• Para disponer el orden de reproducción o la reproducción aleatoria. • Para activar/desactivar el envolvente virtual.	—
	• Para abrir o cerrar la bandeja del disco.	• Para abrir o cerrar la bandeja del disco.	• Para expulsar el videocasete de la grabadora de vídeo.
	• Para hacer una pausa de reproducción del disco. • Para avanzar la reproducción un cuadro a la vez.	• Para hacer una pausa en la reproducción del disco.	• Para hacer una pausa de la reproducción o grabación de la cinta. • Para avanzar la reproducción un cuadro a la vez.
	• Para empezar la reproducción del disco.	• Para empezar la reproducción del disco.	• Para empezar la reproducción de la cinta.
	—	—	• Para empezar una grabación o una grabación de un toque.
	• Para reproducir repetidamente un capítulo o título.	• Para reproducir repetidamente una canción o disco.	—
	• Para volver a la operación previa en el menú.	• Para volver a la operación previa en el menú.	—
	• Para buscar un capítulo, título u hora. • Para colocar o buscar los marcadores.	• Para buscar una canción. • Para buscar la hora. • Para colocar o buscar los marcadores.	• Para llamar el menú de búsqueda de índice u hora.
	• Para llamar el menú de programación de DVD.	• Para llamar el menú de programación de DVD.	—
	• Para saltar capítulos.	• Para saltar canciones.	• Para cambiar de canal. • Para ajustar manualmente el seguimiento durante la reproducción. • Para ver la cinta en cámara lenta.
	—	—	• Para seleccionar la velocidad de grabación.
	—	—	• Para encender o apagar la unidad.
	• Para encender o apagar la unidad.	• Para encender o apagar la unidad.	• Para encender o apagar la unidad.
	• Para parar la reproducción.	• Para parar la reproducción.	• Para parar la reproducción o grabación.
	• Para seleccionar subtítulos en un disco.	—	• Para poner la grabadora de vídeo en el modo de espera para una grabación con temporizador.
	• Para llamar el menú superior en un disco.	—	—
	• Para seleccionar la posición de DVD o posición del televisor.	• Para seleccionar la posición de CD o la posición del televisor.	• Para seleccionar el modo de salida de la grabadora de vídeo. • Para activar el mando a distancia en el modo de la grabadora de vídeo.
	• Para ampliar parte de la imagen. (x2/x4)	—	—



Quick Use Guide

1 Connections

Please refer to "Basic TV Connection" on the front page before you use this unit.

RF Output Channel

If channel 3 is already occupied for broadcasting,

- 1) Set your TV to channel 4.
- 2) Insert a pre-recorded tape into this unit.
- 3) Hit **[SOURCE]** on the unit so that the VCR OUTPUT light is lit.
 - If noise appears on the TV screen, hit **[VCR/TV]** on the remote control.
- 4) Hit **[PLAY ►]** once.
- 5) After a few seconds, hit **[PLAY ►]** on the unit for 3 seconds.
 - The RF output channel will change to channel 4 from channel 3 and you will see a playback picture.
 - When a picture does not appear on the TV screen, repeat step 4).
- 6) Hit **[STOP ■]** to stop playback.

2 Installing the Batteries for the Remote Control



3 VCR/DVD Switching

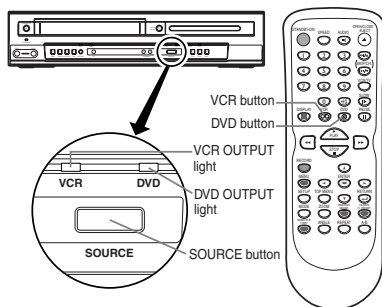

VCR MODE

Hit **[VCR]** on the remote control. (Verify that the VCR OUTPUT light is lit.)

DVD MODE

Hit **[DVD]** on the remote control. (Verify that the DVD OUTPUT light is lit.)

Hint

- Hitting only **[SOURCE]** on the front panel DOES NOT switch the mode of the remote control. You MUST select the correct mode on the remote control.

4 Turn on the unit for the first time

1 Turn on the TV and set it to channel 3.

- If channel 3 is already occupied for broadcasting, see "RF Output Channel" section.

2

STANDBY-ON Remote Control TV Screen

LANGUAGE SELECT

► ENGLISH [ON]
FRANCAIS
ESPAÑOL

3

CH 01

AUTO SET UP

Do you connect the cable from the cable box or the satellite box to the unit's ANT-IN jack?

Yes Hit **MENU** to exit.

No Please wait for a few minutes. After scanning...

- The tuner stops on the lowest memorized channel.
- You can select only the channels memorized in this unit by using **[SKIP/CH. ►►/◄◄]** (or **[CHANNEL ▲/▼]**).
- If "AUTO SET UP" appears on the TV screen again, check the cable connections. Then, hit **[►]** once again.

5 Clock Set Up

1

MENU

- MENU -

TIMER PROGRAMMING
AUTO REPEAT [OFF]
CHANNEL SET UP
CLOCK SET
LANGUAGE SELECT

• If the clock is not set, the CLOCK SET screen appears when you hit **[MENU]**. In this case, go to step 2).

2

CLOCK SET

MONTH DAY YEAR
: : :
HOUR MINUTE AM/PM
: : :
Select the current month.

3

CLOCK SET

MONTH DAY YEAR
10 / 03 : :
HOUR MINUTE AM/PM
: : :
Select the current day.

4

CLOCK SET

MONTH DAY YEAR
10 / 03 : 00 :
HOUR MINUTE AM/PM
: : :
Select the current year.

5

CLOCK SET

MONTH DAY YEAR
10 / 03 MON 2005
HOUR MINUTE AM/PM
05 : : :
Select the current hour.

6

CLOCK SET

MONTH DAY YEAR
10 / 03 MON 2005
HOUR MINUTE AM/PM
05 : 40 : :
Select the current minute.

7

CLOCK SET

MONTH DAY YEAR
10 / 03 MON 2005
HOUR MINUTE AM/PM
05 : 40 : :
Select "AM" or "PM".

8 To exit the CLOCK SET screen

Quick Use Guide

6 VCR Playback

Before: Turn on the TV and set it to channel 3.
 • If channel 3 is already occupied for broadcasting, see "RF Output Channel" section.

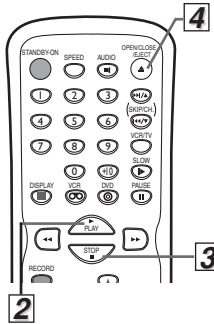
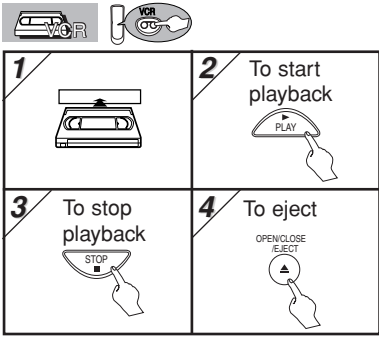

7 DVD/CD Playback

Before: Turn on the TV, amplifier and any other components which are connected to this unit. Make sure the TV and audio receiver (commercially available) are set to the correct channel.

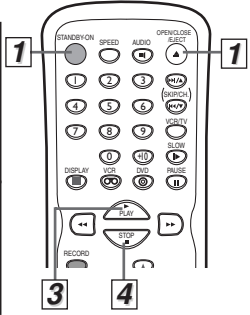
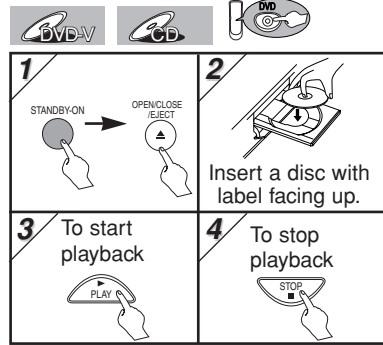

8 Remote Control

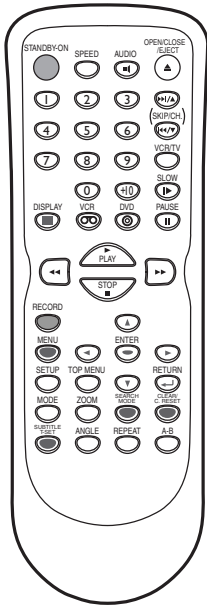

Button (Alphabetical order)	DVD mode		VCR mode
	DVD mode	CD mode	VCR mode
1 2 3 4 5 6 7 8 9 0	• To select chapter or title directly.	• To select track directly.	• To select channel. • The +10 button has no effect in VCR mode.
← →	• To search forward/backward through a disc.	• To search forward/backward through a disc.	• To forward/backward a tape.
ENTER	• To move the cursor and determine its position.	• To move the cursor and determine its position.	• To select an item on the VCR Menu. • To advance to the next VCR Menu. • To go back one step during clock and timer setting.
A-B	• To repeat between your chosen point A and B.	• To repeat between your chosen point A and B.	—
ANGLE	• To select camera angles on a disc.	—	—
AUDIO	• To select audio languages on a disc.	• To select STEREO, L-ch or R-ch.	—
CLEAR/—	• To clear the markers. • To clear the numbers entered incorrectly. • To cancel the point for A-B repeat.	• To clear the markers. • To remove status number in program input. • To clear the numbers entered incorrectly. • To cancel the point for A-B repeat.	• To exit the VCR Menu. • To reset the tape counter.
DISPLAY	• To display the current disc mode.	• To display the current disc mode.	• To display the current time, tape counter, and channel.
DVD	• To select the DVD output mode. • To activate the remote control in DVD mode.	• To select the DVD output mode. • To activate the remote control in DVD mode.	—
MENU	• To call up the Menu on a disc.	—	• To call up the VCR Menu.
MODE	• To set black level on/off. • To set virtual surround on/off.	• To arrange the playing order or play randomly. • To set virtual surround on/off.	—
OPEN/CLOSE EJECT	• To open or close the disc tray.	• To open or close the disc tray.	• To eject the video cassette from the VCR.
PAUSE	• To pause disc playback. • To advance playback one frame at a time.	• To pause disc playback.	• To pause tape playback or recording. • To advance playback one frame at a time.
PLAY	• To begin disc playback.	• To begin disc playback.	• To begin tape playback.
RECORD	—	—	• To start a recording or One Touch Recording.
REPEAT	• To play a chapter or title repeatedly.	• To play a track or disc repeatedly.	—
RETURN	• To return to the previous operation in menu.	• To return to the previous operation in menu.	—
SEARCH	• To search chapter, title or time. • To set or search the markers.	• To search track. • To search time. • To set or search the markers.	• To call up the index or time search menu.
SETUP	• To call up the DVD setup menu.	• To call up the DVD setup menu.	—
SKIP/CH.	• To skip chapters.	• To skip tracks.	• To change channels. • To adjust the tracking manually during playback.
SLOW	—	—	• To view the tape in slow motion.
SPEED	—	—	• To select the recording speed.
STANDBY-ON	• To turn the unit on or off.	• To turn the unit on or off.	• To turn the unit on or off.
STOP	• To stop playback.	• To stop playback.	• To stop playback or recording.
SUBTITLE	• To select subtitles on a disc.	—	• To put the VCR into standby mode for a Timer Recording.
TOP MENU	• To call up the Top Menu on a disc.	—	—
VCR	—	—	• To select the VCR output mode. • To activate the remote control in VCR mode.
VCR/TV	• To select DVD position or TV position.	• To select CD position or TV position.	• To select VCR position or TV position.
ZOOM	• To magnify part of a picture. (x2/x4)	—	—

Free Manuals Download Website

<http://myh66.com>

<http://usermanuals.us>

<http://www.somanuals.com>

<http://www.4manuals.cc>

<http://www.manual-lib.com>

<http://www.404manual.com>

<http://www.luxmanual.com>

<http://aubethermostatmanual.com>

Golf course search by state

<http://golfingnear.com>

Email search by domain

<http://emailbydomain.com>

Auto manuals search

<http://auto.somanuals.com>

TV manuals search

<http://tv.somanuals.com>