

OWNER'S MANUAL

9-INCH COLOR TV/VCR

F9TRF1

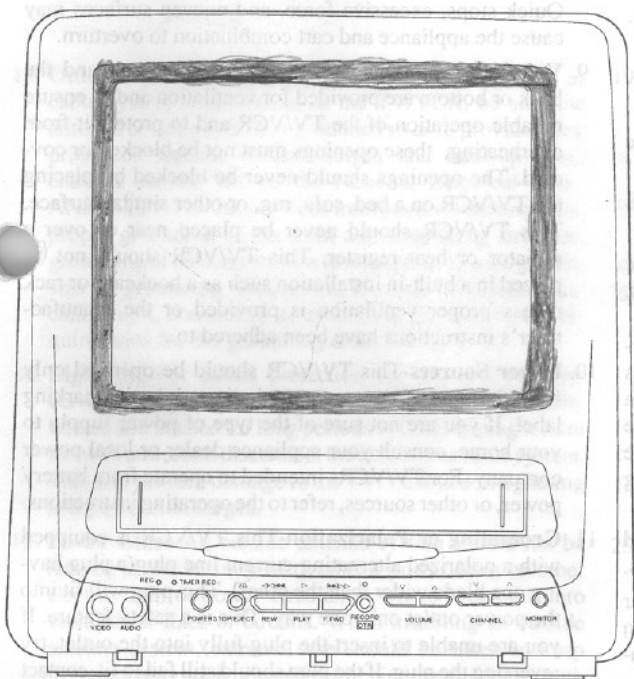

TABLE OF CONTENTS

IMPORTANT SAFEGUARDS	2
PRECAUTIONS.....	4
FEATURES	5
SUPPLIED ACCESSORIES.....	5
OPERATING CONTROLS AND FUNCTIONS.....	6
REMOTE CONTROL OPERATION.....	8
INSTALLING THE BATTERIES.....	9
ANTENNA CONNECTIONS	10
DIPOLE ANTENNA HOOK UP.....	10
OUTDOOR VHF/UHF SEPARATE ANTENNA HOOK UP.....	10
VHF/UHF COMBINED ANTENNA.....	10
CABLE WITHOUT CONVERTER/DESCRAMBLER BOX.....	11
EXTERNAL INPUT MODE.....	11
CABLE WITH CONVERTER/DESCRAMBLER BOX.....	12
MOBILE CONNECTION.....	12
TV/CATV CHANNEL MEMORY PROGRAMMING.....	13
SETTING THE CLOCK.....	15
CHECKING THE COUNT, CLOCK AND CHANNEL NUMBER.....	16
TV OPERATION.....	17
GAME MODE.....	17
PICTURE CONTROL.....	17
PLAYBACK.....	18
SPECIAL PLAYBACK.....	19
RENTAL PLAY.....	19
AUTO REPEAT PLAYBACK.....	19
COUNTER MEMORY.....	20
TIME SEARCH.....	21
VIEWING AND RECORDING THE SAME PROGRAM.....	22
OTR (ONE TOUCH RECORDING).....	23
AUTOMATIC TIMER RECORDING.....	24
TODAY TIMER RECORDING.....	26
SPECIAL FEATURES.....	28
DEGAUSSING.....	28
AUTO REWIND-EJECT.....	28
TRACKING ADJUSTMENT.....	28
TO CHANGE THE LANGUAGE.....	28
SETTING THE SLEEP TIMER.....	28
VIDEO CASSETTE.....	29
TROUBLESHOOTING GUIDE.....	30
MAINTENANCE.....	31
SPECIFICATIONS.....	32
CABLE CHANNEL DESIGNATIONS.....	33
SPANISH(ESPAÑOL).....	35

IF YOU NEED ADDITIONAL ASSISTANCE FOR SET-UP OR OPERATING AFTER READING OWNER'S MANUAL, PLEASE CALL TOLL FREE 1-800-242-7158 (EASTERN TIME 9:00AM ~ 4:30PM)



Please read before using this equipment

WARNING:

TO REDUCE THE RISK OF FIRE OR ELECTRIC SHOCK, DO NOT EXPOSE THIS APPLIANCE TO RAIN OR MOISTURE.

**CAUTION**

**RISK OF ELECTRIC SHOCK
DO NOT OPEN**



CAUTION: TO REDUCE THE RISK OF ELECTRIC SHOCK, DO NOT REMOVE COVER (OR BACK) NO USER SERVICEABLE PARTS INSIDE. REFER SERVICING TO QUALIFIED SERVICE PERSONNEL.



THIS SYMBOL INDICATES THAT DANGEROUS VOLTAGE CONSTITUTING A RISK OF ELECTRIC SHOCK IS PRESENT WITHIN THIS UNIT.



THIS SYMBOL INDICATES THAT THERE ARE IMPORTANT OPERATING AND MAINTENANCE INSTRUCTIONS IN THE LITERATURE ACCOMPANYING THE APPLIANCE.

The important note is located on the rear of the cabinet.

IMPORTANT SAFEGUARDS

- 1. Read instructions**-All the safety and operating instructions should be read before the appliance is operated.
- 2. Retain Instructions**-The safety and operating instructions should be retained for future reference.
- 3. Heed Warnings**-All warnings on the appliance and in the operating instructions should be adhered to.
- 4. Follow Instructions**-All operating and use instructions should be followed.
- 5. Cleaning**-Unplug TV/VCR from the wall outlet before cleaning. Do not use liquid cleaners or aerosol cleaners. Use a damp cloth for cleaning.
EXCEPTION: A product that is meant for uninterrupted service and, that for some specific reason, such as the possibility of the loss of an authorization code for a CATV converter, is not intended to be unplugged by the user for cleaning or any other purpose, may exclude the reference to unplugging the appliance in the cleaning description otherwise required in item 5.
- 6. Attachments**-Do not use attachments not recommended by the TV/VCR manufacturer as they may cause hazards.
- 7. Water and Moisture**-Do not use this TV/VCR near water-for example, near a bath tub, wash bowl, kitchen sink, or laundry tub, in a wet basement, or near a swimming pool, and the like.
- 8. Accessories**-Do not place this TV/VCR on an unstable cart, stand, tripod, bracket, or table. The TV/VCR may fall, causing serious injury to someone, and serious damage to the appliance. Use only with a cart, stand, tripod, bracket, or table recommended by the manufacturer, or sold with the TV/VCR. Any mounting of the appliance should follow the manufacturer's instructions and should use a mounting accessory recommended by the manufacturer. An appliance and cart combination should be moved with care.
- 9. Ventilation**-Slots and openings in the cabinet and the back or bottom are provided for ventilation and to ensure reliable operation of the TV/VCR and to protect it from overheating, these openings must not be blocked or covered. The openings should never be blocked by placing the TV/VCR on a bed, sofa, rug, or other similar surface. This TV/VCR should never be placed near or over a radiator or heat register. This TV/VCR should not be placed in a built-in installation such as a bookcase or rack unless proper ventilation is provided or the manufacturer's instructions have been adhered to.
- 10. Power Sources**-This TV/VCR should be operated only from the type of power source indicated on the marking label. If you are not sure of the type of power supply to your home, consult your appliance dealer or local power company. For TV/VCRs intended to operate from battery power, or other sources, refer to the operating instructions.
- 11. Grounding or Polarization**-This TV/VCR is equipped with a polarized alternating-current line plug (a plug having one blade wider than the other). This plug will fit into the power outlet only one way. This is a safety feature. If you are unable to insert the plug fully into the outlet, try reversing the plug. If the plug should still fail to fit, contact your electrician to replace your obsolete outlet. Do not defeat the safety purpose of the polarized plug.
- 12. Power-Cord Protection**-Power-supply cords should be routed so that they are not likely to be walked on or pinched by items placed upon or against them, paying particular attention to cords at plugs, convenience receptacles, and the point where they exit from the appliance.

PORTABLE CART WARNING



S5T26A

FIGURE A
EXAMPLE OF ANTENNA GROUNDING AS PER
NATIONAL ELECTRICAL CODE

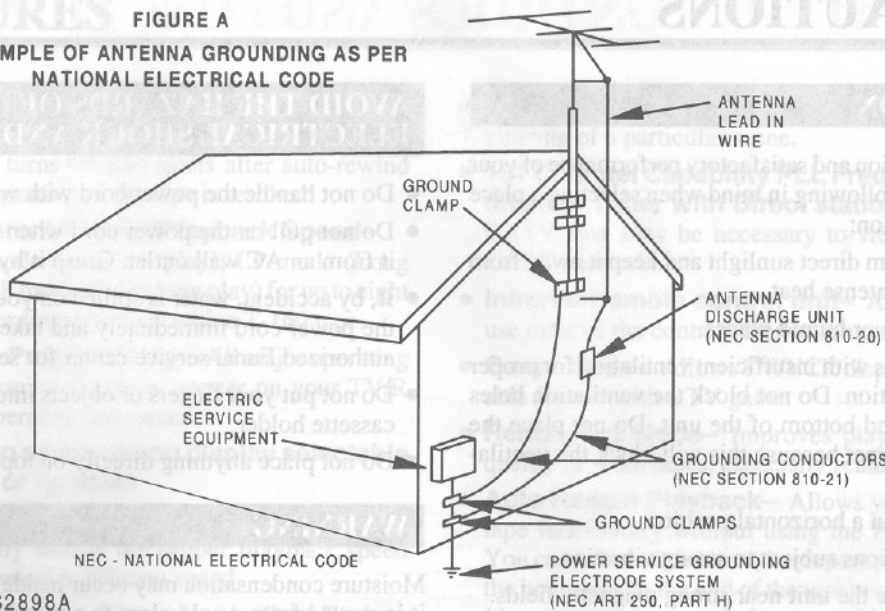

NEC - NATIONAL ELECTRICAL CODE

S2898A

13. **Outdoor Antenna grounding**-If an outside antenna or cable system is connected to the TV/VCR, be sure the antenna or cable system is grounded so as to provide some protection against voltage surges and built-up static charges. Article 810 of the National Electrical Code, ANSI/NFPA No. 70, provides information with respect to proper grounding of the mast and supporting structure, grounding of the lead-in wire to an antenna discharge unit, size of grounding conductors, location of antenna-discharge unit, connection to grounding electrodes, and requirements for the grounding electrode. (Fig. A)
14. **Lightning**-For added protection for this TV/VCR receiver during a lightning storm, or when it is left unattended and unused for long periods of time, unplug it from the wall outlet and disconnect the antenna or cable system. This will prevent damage to the TV/VCR due to lightning and power-line surges.
15. **Power Lines**-An outside antenna system should not be located in the vicinity of overhead power lines or other electric light or power circuits, or where it can fall into such power lines or circuits. When installing an outside antenna system, extreme care should be taken to keep from touching such power lines or circuits as contact with them might be fatal.
16. **Overloading**-Do not overload wall outlets and extension cords as this can result in a risk of fire or electric shock.
17. **Object and Liquid Entry**-Never push objects of any kind into this TV/VCR through openings as they may touch dangerous voltage points or short out parts that could result in a fire or electric shock. Never spill liquid of any kind on the TV/VCR.
18. **Servicing**-Do not attempt to service this TV/VCR yourself as opening or removing covers may expose you to dangerous voltage or other hazards. Refer all servicing to qualified service personnel.
19. **Damage Requiring Service**-Unplug this TV/VCR from the wall outlet and refer servicing to qualified service personnel under the following conditions:
 - a. When the power-supply cord or plug is damaged or frayed.
 - b. If liquid has been spilled, or objects have fallen into the TV/VCR.
 - c. If the TV/VCR has been exposed to rain or water.
 - d. If the TV/VCR does not operate normally by following the operating instructions. Adjust only those controls that are covered by the operating instructions, as improper adjustment of other controls may result in damage and will often require extensive work by a qualified technician to restore the TV/VCR to its normal operation.
 - e. If the TV/VCR has been dropped or damaged in any way.
 - f. When the TV/VCR exhibits a distinct change in performance-this indicates a need for service.
20. **Replacement Parts**-When replacement parts are required, be sure the service technician has used replacement parts specified by the manufacturer that have the same characteristics as the original part. Unauthorized substitutions may result in fire, electric shock, injury to persons or other hazards.
21. **Safety Check**-Upon completion of any service or repairs to this TV/VCR, ask the service technician to perform routine safety checks to determine that the TV/VCR is in proper operating condition.
22. **Heat**-This TV/VCR product should be situated away from heat sources such as radiators, heat registers, stoves, or other products (including amplifiers) that produce heat.

PRECAUTIONS

LOCATION

For safe operation and satisfactory performance of your unit, keep the following in mind when selecting a place for its installation:

- Shield it from direct sunlight and keep it away from sources of intense heat.
- Avoid dusty or humid places.
- Avoid places with insufficient ventilation for proper heat dissipation. Do not block the ventilation holes at the top and bottom of the unit. Do not place the unit on a carpet because this will block the ventilation holes.
- Install unit in a horizontal position.
- Avoid locations subject to strong vibration.
- Do not place the unit near strong magnetic fields.
- Do not move the unit from a cold to a hot place or vice versa.

AVOID THE HAZARDS OF ELECTRICAL SHOCK AND FIRE

- Do not handle the power cord with wet hands.
- Do not pull on the power cord when disconnecting it from an AC wall outlet. Grasp it by the plug.
- If, by accident, water is spilled on your unit, unplug the power cord immediately and take the unit to an authorized Funai service center for servicing.
- Do not put your fingers or objects into the TV/VCR cassette holder.
- Do not place anything directly on top of the unit.

WARNING

Moisture condensation may occur inside the unit when it is moved from a cold place to a warm place, or after heating a cold room or under conditions of high humidity. If a tape is played in a TV/VCR which has moisture, it may damage the tape and TV/VCR. Therefore when the condensation occurs inside the unit turn the POWER button on and allow at least 2 hours for the unit to dry out.

FCC WARNING- This equipment may generate or use radio frequency energy. Changes or modifications to this equipment may cause harmful interference unless the modifications are expressly approved in the instruction manual. The user could lose the authority to operate this equipment if an unauthorized change or modification is made.

IMPORTANT COPYRIGHT INFORMATION

Unauthorized recording or use of broadcast television programming, video tape, film or other copyrighted material may violate applicable copyright laws. We assume no responsibility for the unauthorized duplication, use or other acts which infringe upon the rights of copyright owners.





The serial number of this product may be found on the back of the unit. No others have the same serial number as yours. You should record the number and other vital information here and retain this book as a permanent record of your purchase to aid identification in case of theft.

Date of Purchase	
Dealer Purchased from	
Dealer Address	
Dealer Phone No.	
Model No.	
Serial No.	

FEATURES

- **Auto Power On and Off system**— Automatically turns the TV/VCR on as you insert the cassette, turns off and ejects after auto-rewind when the beginning of the tape is reached.
- **Three Different Record/Playback Speed**— Select SP mode (Standard play), LP mode (Long play) and SLP mode (Super long play) for up to eight hours of recording/playback with a T-160 tape.
- **On Screen Programming**— All major operating and programming functions appear on your TV/R screen for operating convenience.
- **Bilingual on screen menu display selectable in English or Spanish**
- **Automatic Playback Speed Selection**— Automatically selects the proper playback speed even if you select a different speed.
- **1 Year, 8 Events Timer (including Today, Daily and Weekly Timer Recording)**— The built-in timer allows you to record up to 7 programs at different times on different channels up to 1 year in advance. The Today Timer Recording feature uses program number 8. The daily timer will allow recordings to be made of daily broadcasts and the weekly timer will allow recording to be made once a week up to the end of the tape.
- **Today Timer Recording**— Allows you to easily record one program within 24 hours.
- **Visual Search**— Allows you to view a video tape at a high speed in either a forward or reverse direction.
- **STILL**— "Freeze" the picture at any time, for close viewing of a particular scene.
- **181 Channel Capability PLL Frequency Synthesizer Tuner with Direct station Call**— (A CATV Box may be necessary to view scrambled CATV channels.)
- **Infrared Remote control unit**— Allows you to use most of the controls from a remote location.
- **Game Mode**— Allows TV/VCR display to be suitable for use with a TV game.
- **Rental Play Mode**— Improves playback picture quality of worn tapes, especially rental tapes.
- **Auto Repeat Playback**— Allows you to repeat a tape indefinitely without using the PLAY button. You can select all feature (that repeat playback from the beginning to the end of the tape) or blank feature (that repeat only recorded part, not blank part).
- **OTR (One Touch Recording)**— Automatic timed recording from 30 to 480 minutes is possible at the push of OTR button. (Timer adjustments for recording are not required.)
- **Time Search**— Allows you to set the TV/VCR to advance the tape by entering the desired playback time you want to skip.
- **Sleep Timer**— Allows you to turn off the TV/VCR without using the POWER button after a desired time period.
- **Two-Way Power**— Allows you to power the TV/VCR with standard household AC or your vehicle's battery, using the supplied car-battery cord.

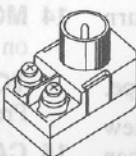
SUPPLIED ACCESSORIES

<p>Remote Control Unit (UREMT32SR007) With 2 AA Batteries</p> 	<p>VHF/UHF Rod Antenna</p>  <p>(OEMN00723)</p>	<p>Matching Adapter (300ohm-75ohm)</p>  <p>(1813641/1780103)</p>	<p>Car Battery Cord</p>  <p>(WPZ0202GA004)</p>	<p>AC Cord</p>  <p>(WAV0182NW001) (WAV0182LW001)</p>
--	---	---	---	---

- If you need to replace these accessories, please refer to the PART NO. under the illustrations and contact the FUNAI parts department for ordering.

OPERATING CONTROLS AND FUNCTIONS

— FRONT VIEW —

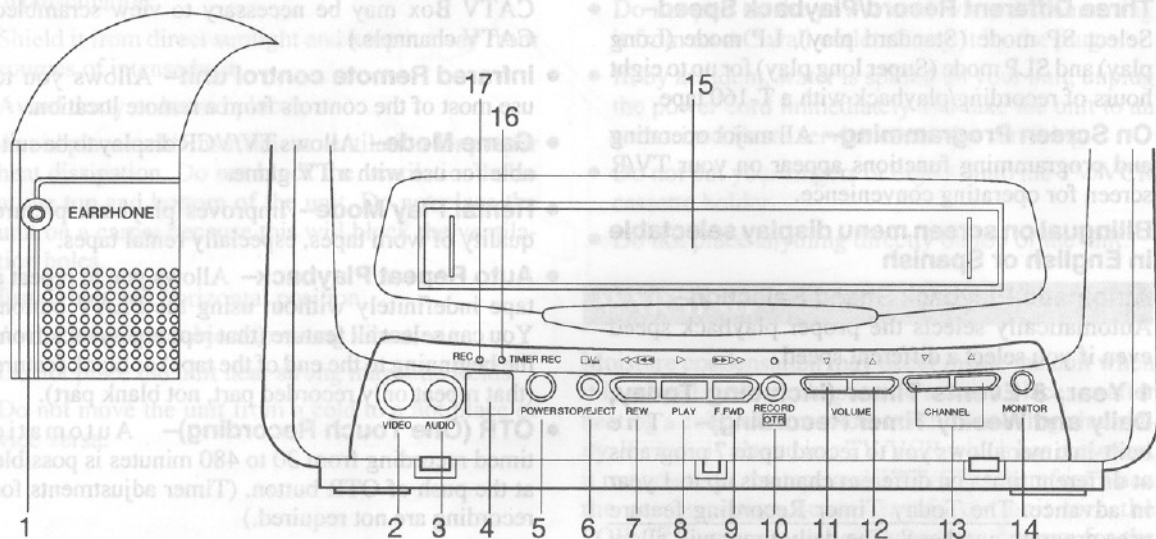

- 1 EARPHONE jack**— Connect to earphone (not supplied) for personal listening. The size of jack is 1/8" monaural (3.5mm).
- 2 VIDEO IN jack**— Connect to video output jack of your video camera or another VCR.
- 3 AUDIO IN jack**— Connect to audio output jack of your audio equipment or another VCR.
- 4 Remote Sensor**— Receives the infrared control signals from the handheld remote control unit.
- 5 POWER button**— Press to turn TV/VCR on and off. Press to activate the automatic timer recording.
- 6 STOP/EJECT button**— Press to stop tape motion. Press to remove tape from TV/VCR.
- 7 REW button**— Press to rewind tape, or to view video in reverse during the Play mode at a faster than normal speed. Press PLAY button to return TV/VCR to normal playback speed.
- 8 PLAY button**— Press to begin playback of a tape.
- 9 F.FWD button**— Press to advance tape, or to view video in forward during Play mode at a faster than normal speed. Press PLAY button to return TV/VCR to normal playback speed.
- 10 RECORD/OTR button**— Press to begin manual recording. Press to activate One Touch Recording.
- 11 VOLUME "∇" button**— Press to decrease the volume level.
CLEAR function— Press to cancel Today Timer Recording.
- 12 VOLUME "▲" button**— Press to increase the volume level.
SELECT function— Press to select the next step when setting Today Timer Recording.
- 13 CHANNEL "∇"/"▲" buttons**— Press to select the channel for viewing or recording.
TRACKING +/- function— Press to minimize video 'noise' (lines or dots on screen) during the Play mode.
SET function— Press to adjust time using ∇ or ▲ button in the Today Timer Recording.
- 14 MONITOR button**— Press to turn the TV screen on and off when in the Recording mode.
TODAY TIMER RECORDING function— Press to set Today Timer Recording.
- 15 CASSETTE COMPARTMENT**
- 16 TIMER REC indicator**— Lights up in the Timer Recording mode.
- 17 REC indicator**— Lights up in the Recording mode.

— REAR VIEW —

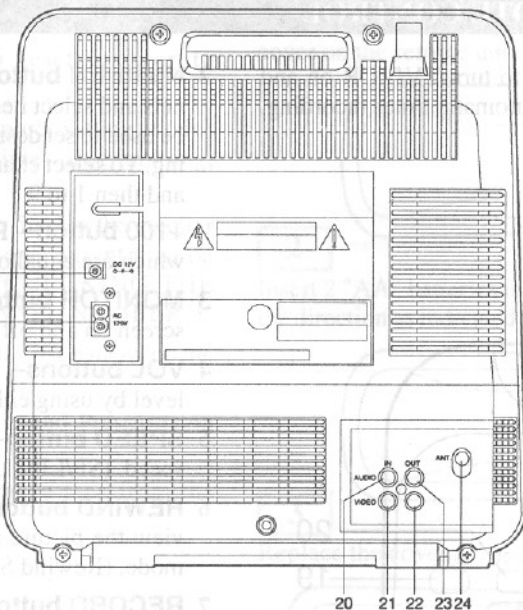

- 18** DC 12V jack— Connect to the Car Battery Cord.
- 19** AC120V jack— Connect to the AC cord.
- 20** AUDIO IN jack- Connect to audio output jack of your audio equipment or another VCR.
- 21** VIDEO IN jack- Connect to video output jack of your video camera or another VCR.
- 22** VIDEO OUT jack— Connect to the video in jack of video processor or another VCR.
- 23** AUDIO OUT jack— Connect to the audio in jack of your audio equipment or another VCR.
- 24** ANT. terminal- Connect to an antenna or CATV.

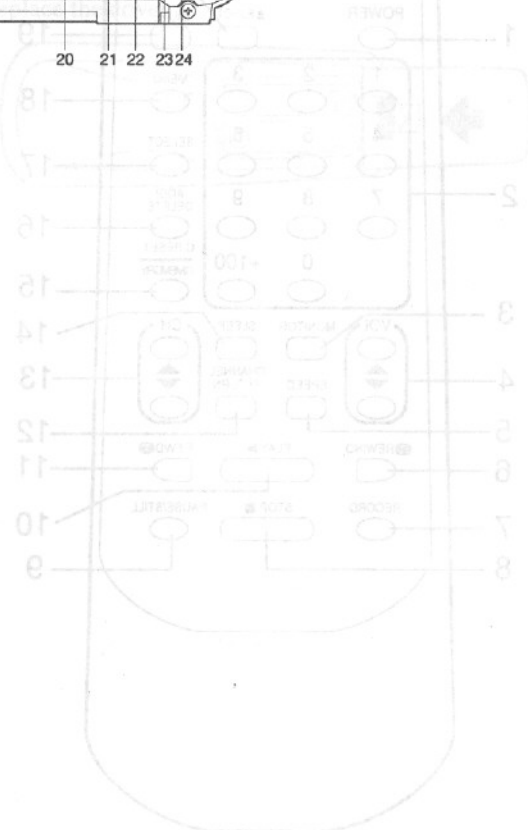

REMOTE CONTROL OPERATION

You can operate most of functions from the Remote Control (included). The buttons on the Remote Control have the same functions as the corresponding buttons on the unit.

HOW TO USE REMOTE CONTROL

1 POWER button— Press to turn TV/VCR on and off. Press to activate the automatic timer recording.

2 NUMBER buttons— Press to select desired channels and select item in the Menu mode. They cannot be used to set desired channel during Timer Recording. To select channels 1 to 9, first press the 0 button and then 1 to 9.

+100 button— Press to select cable channels which are equal or greater than number 100.

3 MONITOR button— Press to turn the TV/VCR screen on and off in the Recording mode.

4 VOL buttons— Press to adjust desired volume level by using either ▲ or ▼ button.

5 SPEED button— Press to set desired recording speed. (SP/LP/SLP)

6 REWIND button— Press to rewind the tape, or to view the picture rapidly in reverse during the Play mode. (Rewind Search)

7 RECORD button— Press to begin manual recording.

8 STOP button— Press to stop the tape motion.

9 PAUSE/STILL button— Press to temporarily stop the tape during the Recording mode or to view a still picture during the Play mode.

10 PLAY button— Press to playback the tape.

11 F.FWD button— Press to rapidly advance the tape, or to view the picture rapidly in forward during the Play mode. (Forward Search)

12 CHANNEL RETURN BUTTON— Press to go back to the previously viewed channel. For example, pressing this button once will change channel display from 3 (present channel) to 10 (previously viewed channel), and pressing it a second time will return from 10 to 3.

13 CH buttons— Press to select desired channel by using either ▲ or ▼ button. They may also be used to adjust the picture control. (See page 17.)

TRACKING function— Press ▲ or ▼ button to minimize video 'noise' (lines or dots on screen) during the Play mode. (See page 28.)

14 SLEEP button— Press to activate the sleep timer function. (See page 28.)

15 C.MEMORY button— Press to use the Counter Memory mode. (See page 20.)

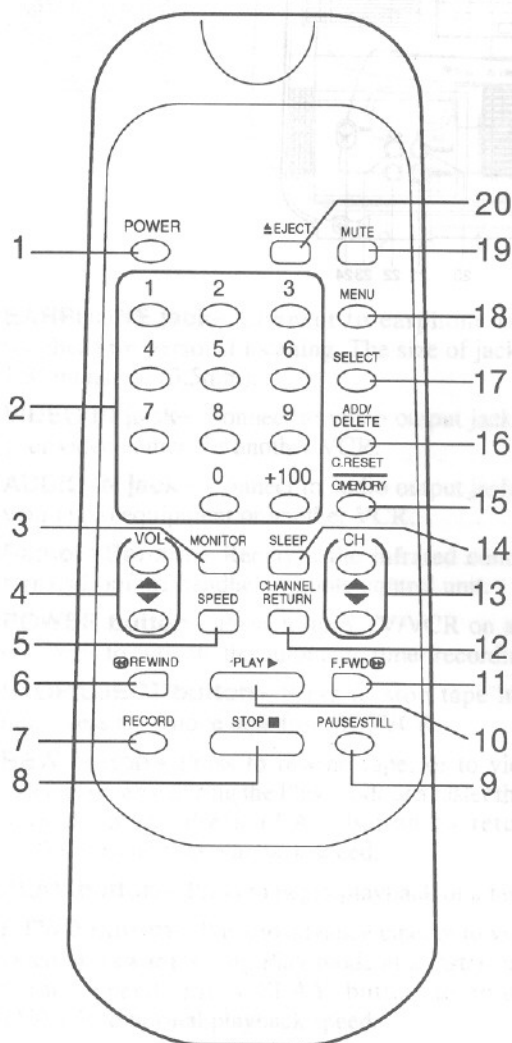

16 ADD/DELETE button— Press to add or delete channel numbers. Press to cancel a timer program. (This function is operative only in the Menu mode.) (See pages 14 and 25.)

C.RESET button— Press to reset counter to 0:00:00.

17 SELECT button— Press to select setting modes (clock, counter, tape speed, timer programming, channel preset, etc.).

DISPLAY function— Press to display the counter or the current channel number and current time on the TV/VCR screen. (See "CHECKING THE COUNT, CLOCK AND CHANNEL NUMBER")

18 MENU button— Press to display main menu on the TV/VCR screen.

19 MUTE button— Press to mute sound. Press it again to resume sound.

20 EJECT button— Press to remove tape from the TV/VCR.

INSTALLING THE BATTERIES

1
Slide the battery compartment cover by pressing the cover on the remote unit in the direction of the arrow.

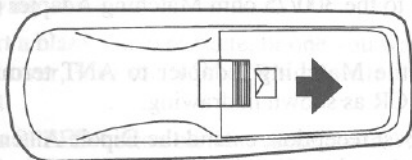

2
Insert 2 "AA" batteries into the battery compartment in the direction as indicated by the polarity (+/-) markings.

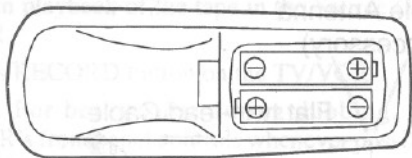

3
Replace the cover.

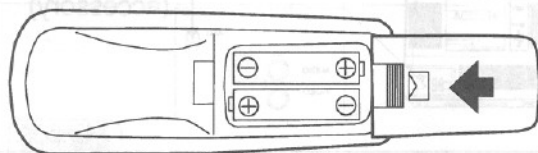

INTERNAL CONNECTIONS

ANTENNA CONNECTIONS

A VCR/TV flat twin lead antenna can be connected to the VIDEO IN jacks of the TV/VCR.



Note to CATV system installer: This remote is provided to call the CATV system installer's attention to Article 820-40 of the NEC that provides guidelines for proper grounding and, in particular, specifies that the cable ground shall be connected to the grounding system of the building as close to the point of cable entry as practical.

ANTENNA CONNECTIONS

DIPOLE ANTENNA HOOK UP

1. Push the stem of the Dipole Antenna (accessory) into the hole for antenna at the back of TV/VCR.
2. Connect the flat twin-lead cable from the Dipole Antenna to the 300/75 ohm Matching Adapter (accessory).
3. Plug the Matching Adapter to ANT terminal of TV/VCR as shown in drawing.

For the best reception, extend the Dipole Antenna and adjust its length and position. (Avoid handling the top section when making adjustments).

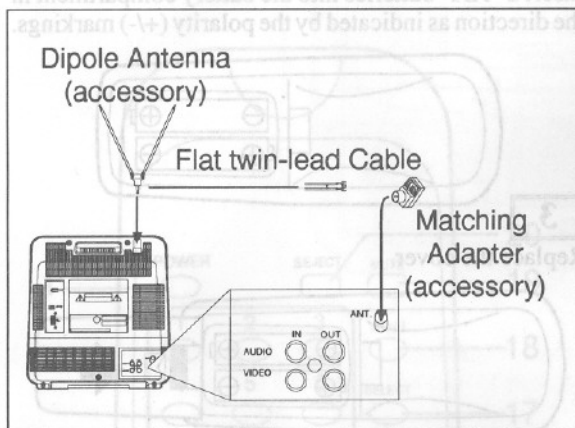

NOTES:

- 1) If it is difficult to get good reception with the indoor antenna, the use of an outdoor antenna is recommended. Before an outdoor antenna is connected to the set, the indoor antenna should be disconnected.

OUTDOOR VHF/UHF SEPARATE ANTENNA HOOK UP

1. Connect the 300-ohm flat twin-lead cable from an outdoor UHF antenna to the VHF/UHF Combiner (not supplied).
2. Connect a round type 75 ohm coaxial cable from an outdoor VHF antenna to the VHF/UHF Combiner (not supplied).
3. Plug the VHF/UHF combiner to ANT terminal of TV/VCR as shown in drawing.

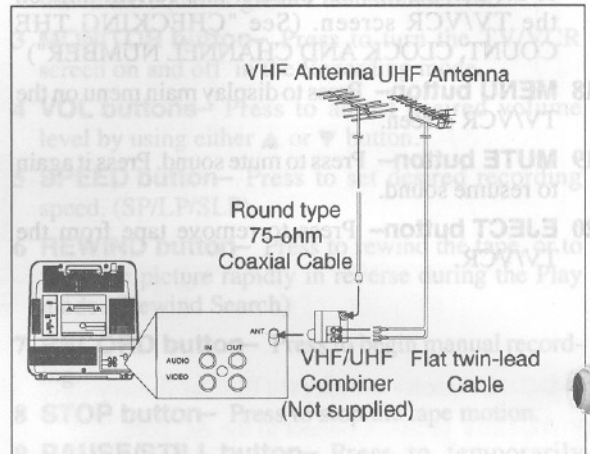

VHF/UHF COMBINED ANTENNA

A VHF UHF 75 ohm combination antenna can be connected to ANT terminal.

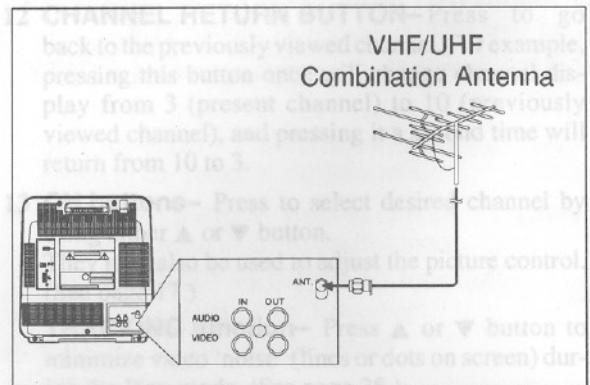

Note to CATV system installer

This reminder is provided to call the CATV system installer's attention to Article 820-40 of the NEC that provides guidelines for proper grounding and, in particular, specifies that the cable ground shall be connected to the grounding system of the building as close to the point of cable entry as practical.

CABLE WITHOUT CONVERTER/DESCRAMBLER BOX

Use this connection if your cable system connects directly to your TV/VCR without a converter box.

With this connection you, 1) can use your TV/VCR Remote Control to select channels, 2) program one or more unscrambled channels for automatic timer recording.

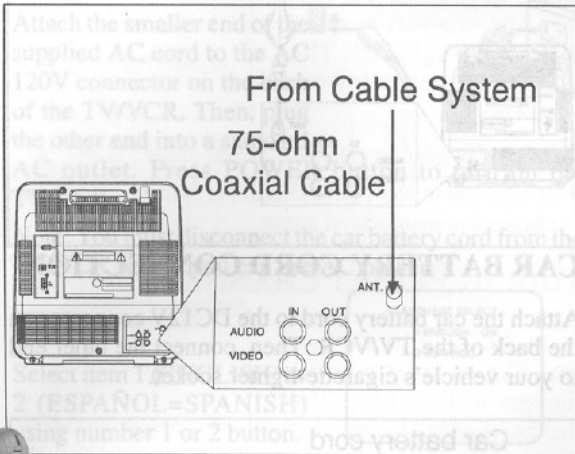

EXTERNAL INPUT MODE

When using an external input signal (another VCR or video camera), connect the player's audio/video output cables to the AUDIO IN, VIDEO IN jacks of your TV/VCR. Then press CH. "▲" or "▼" button or enter "00" with number button so that AUX appears on the screen.

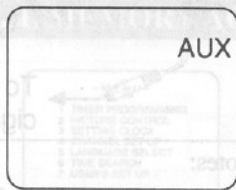

TO COPY A VIDEO CASSETTE
(Requires another VCR)

Connect your TV/VCR and a Source (Playing) VCR using the following diagram:

1. Insert a pre-recorded video cassette into the Source (Playing) VCR.
2. Insert a blank video cassette, or one you want to record over, into the TV/VCR's cassette compartment.
3. Press SPEED button on the remote control to select the desired recording speed (SP, LP or SLP).
4. Press CHANNEL ▲ or ▼ button repeatedly so that "AUX" appears on the screen.
5. Begin playback of the tape in the Source (Playing) VCR.
6. Press RECORD button on the TV/VCR.

NOTE: For best results during dubbing, use the TV/VCR's front panel controls whenever possible. The remote control might affect the Source (Playing) VCR's playback operation.

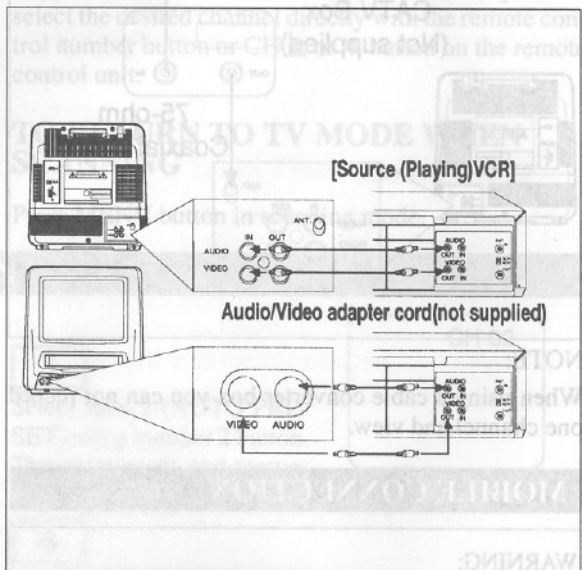

CAUTION
If you use the TV/VCR with the vehicle's engine off, recharge the vehicle's battery after about every 4 hours of use to prevent it from draining down. After you finish using the TV/VCR be sure you unplug the car-battery cord from the cigarette-lighter socket.

TO RETURN TV TO CHANNEL SCANNING

Press MENU button in scanning mode.



CABLE WITH CONVERTER/DESCRAMBLER BOX

If your cable service supplies you with a converter box you can use the basic connection shown here.

With this connection you can record and view any channel, including scrambled channels. However channel selection must be made with the converter box. This means that channels cannot be changed using the TV/VCR Remote Control. Unattended recording is limited to one channel at a time.

TO RECORD AND VIEW A SCRAMBLED/UNSCRAMBLED CHANNEL

1. Set the TV/VCR channel to the output channel of the Cable Converter Box. (Ex. CH3)
2. Select the channel to be recorded or viewed on the Cable Converter Box.

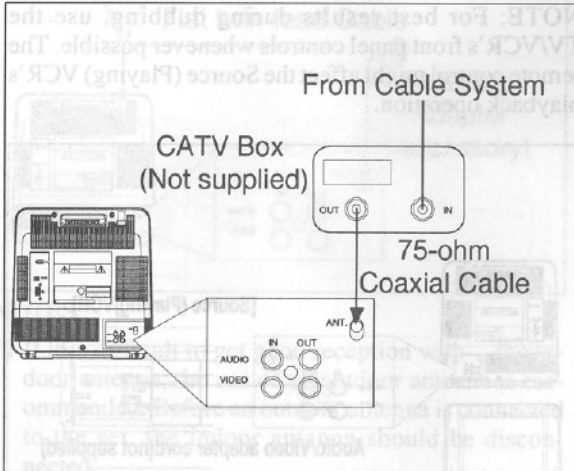

NOTE:

When using a cable converter box you can not record one channel and view.

MOBILE CONNECTION

WARNING:

never watch the TV/VCR while driving.

CAUTION

If you use the TV/VCR with the vehicle's engine off, recharge the vehicle's battery after about every 4 hours of use to prevent it from running down. After you finish using the TV/VCR be sure you unplug the car-battery cord from the cigarette-lighter socket.

ANTENNA CONNECTION

The supplied indoor antenna is adequate when your vehicle is stationary. For best reception on the road, use a high-quality VHF/UHF mobile TV antenna.

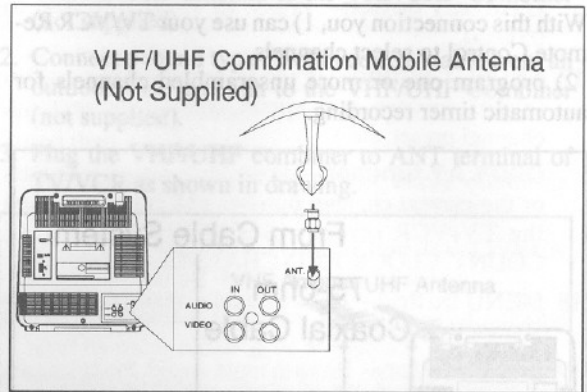

CAR BATTERY CORD CONNECTION

Attach the car battery cord to the DC12V connector on the back of the TV/VCR. Then, connect the other end to your vehicle's cigarette-lighter socket.

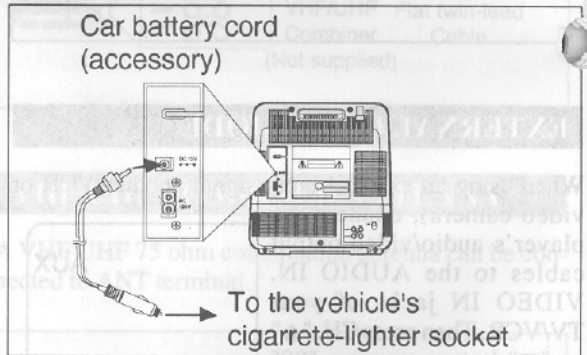

Notes:

- Be sure your vehicle has a 12-volt, negative-ground electrical system.
- Be sure you use only the supplied car battery cord. Using another cord could damage the TV/VCR.
- Be sure the socket is free of ashes and other debris.
- Be sure to push the car battery cord's plug completely into the cigarette-lighter socket.
- Always unplug the car battery from the cigarette-lighter socket before you unplug it from the TV/VCR.
- You must disconnect the car battery cord from the TV/VCR before you can use AC power.
- Be sure to replace fuse with only same type, 5A, 250V.

TV/CATV CHANNEL MEMORY PROGRAMMING

You can program the tuner to scan only the channels you receive in your area.

AUTOMATIC CHANNEL MEMORY

NOTE: Channel memory programming is not needed when using a converter/descrambler box.

You must use the remote control unit for the following steps:

1

Attach the smaller end of the supplied AC cord to the AC 120V connector on the back of the TV/VCR. Then, plug the other end into a standard AC outlet. Press POWER button to turn on the TV/VCR.



Note: You must disconnect the car battery cord from the TV/VCR before you can use AC power.

2

Select item 1 (ENGLISH) or 2 (ESPAÑOL=SPANISH) using number 1 or 2 button.

-- LANGUAGE SELECT --
1 ENGLISH ON
2 ESPAÑOL

3

Press SELECT button on the remote control unit. The tuner scans and memorizes all the active channels in your area.

- The TV/VCR distinguishes between standard TV channels and CATV automatically.

4

After scanning, the tuner stops on the lowest memorized channel.

(TV mode: from CH 02/ CATV mode: from CH 01)

If you want to recall the selected channels, you can select the desired channel directly with the remote control number button or CH ▲ or ▼ button on the remote control unit.

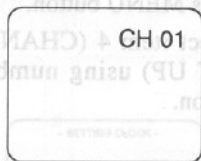

TO RETURN TO TV MODE WHEN SCANNING

Press MENU button in scanning mode.

TO PRESET CHANNEL MEMORY AGAIN

1

Press MENU button.

Select item 4 (CHANNEL SET UP) using number 4 button.

-- MENU --
1 TIMER PROGRAMMING
2 PICTURE CONTROL
3 SETTING CLOCK
4 CHANNEL SET UP
5 LANGUAGE SELECT
6 TIME SEARCH
7 USER'S SET UP

2

Press number 1 button repeatedly to select [TV] or [CATV].

-- CHANNEL SET UP --
1 TV/CATV [TV]
2 AUTO PRESET
3 ADD/DELETE CH

3

Select item 2 (AUTO PRESET) using number 2 button. The tuner scans and memorizes all the active channels in your area.

4

After scanning, the tuner stops on the lowest memorized channel.

(TV mode: from CH02 / CATV mode: from CH01)

If you want to recall the selected channels, you can select the desired channel directly by number button or CH ▲ or ▼ button on the remote control unit.

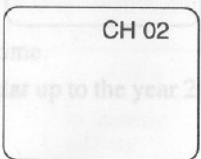

TO RETURN TO TV MODE WHEN SCANNING

Press MENU button in scanning mode.

TO DELETE OR ADD PRESET CHANNEL

To add or delete the desired channels.

1

Press MENU button.

Select item 4 (CHANNEL SET UP) using number 4 button.



2

Select item 3 (ADD/DELETE CH) using number 3 button.

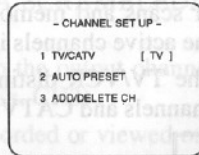

3

Enter the desired channel number using the number button or the CH ▲ or ▼ button.

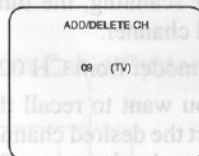

4

DELETING PRESET CHANNEL

Press ADD/DELETE button. The channel number changes to light red. The channel is deleted from memory.

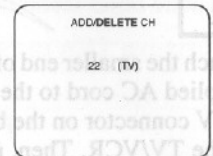

- To delete another channel, repeat steps [3] and [4].
- If you press the ADD/DELETE button again, the channel is memorized again.

ADDING PRESET CHANNEL

Press ADD/DELETE button. The channel number changes to light blue. The channel is added to memory.

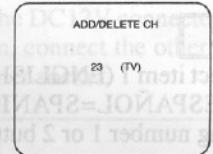

- To add another channel, repeat steps [3] and [4].
- If you press the ADD/DELETE button again, the channel is deleted again.

**Added channel is in light blue.
Deleted channel is in light red.**

5

Press MENU button. The TV/VCR screen returns to TV mode.

NOTE: To confirm that channel(s) has been deleted or added, press CH ▲ or ▼ button.

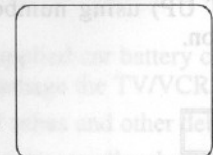

SETTING THE CLOCK

Set the clock accurately for proper automatic timer recording.

- You must use the remote control unit for the following steps:
- Power must be turned on.

In the example below, the clock is to be set to:

DATE March 1st, 1995
SETTING TIME 5:40PM

1

Press MENU button.

Select item 3 (SETTING CLOCK) using number 3 button.

2

Enter the desired month using number button.

(Ex. March - enter 03)

3

Enter the desired day using number button.

(Ex. March 1st - enter 01)

4

Enter the desired year using number button.

(Ex. 1995 - enter 1995)

5

Enter the desired hour using number button.

(Ex. 5:40pm - enter 05)

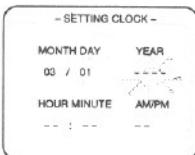
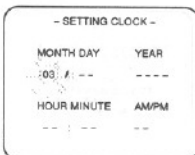
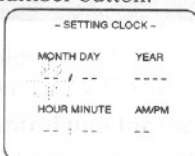
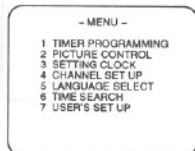

6

Enter the desired minute using number button.

(Ex. 5:40pm - enter 40)

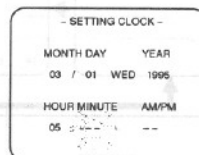

7

Enter 1 to select "AM" or enter 2 to select "PM" using number button.

(Ex. 5:40pm - enter 2)

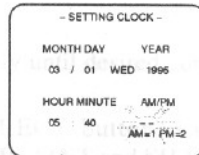

8

Press MENU or SELECT button to start the clock.

Although seconds are not displayed, they begin counting from 00 when you press MENU or SELECT button. Use this feature to synchronize the clock with the correct time.

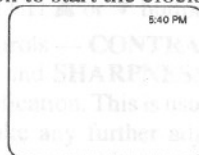

- This unit has a built in calendar up to the year 2008.

TO CHANGE CLOCK SETTING

If you want to change the clock,

- 1) Follow step [1].
- 2) Select desired digit using SELECT button or ADD/DELETE button.
- 3) Enter correct numbers using number button.
- 4) Press MENU button to return to TV mode.

CHECKING THE COUNT, CLOCK AND CHANNEL NUMBER

To check the Count, Clock and Channel number on the TV/VCR screen, press SELECT button on the remote control.

Each time you press SELECT button on the remote control, the TV/VCR screen will change as follows:

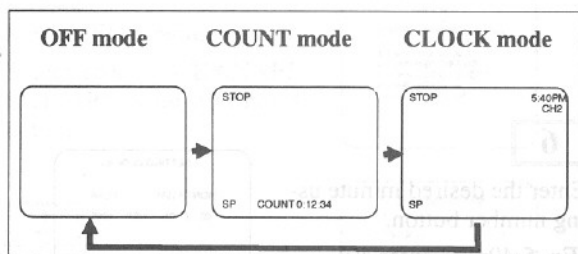

TV OPERATION

1

Press **POWER** button to turn on the TV/VCR.

2

Select the desired channel using number button or **CH ▲** or **▼** button.

3

Adjust the **VOLUME** to desired listening level using the **VOLUME ▲** or **▼** button.

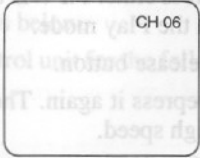

GAME MODE

This function enables you to adjust the TV/VCR display making it suitable for use with a TV GAME.

- You must use the remote control unit for the following steps:

1

Press **MENU** button.
Select item 7 (**USER'S SET UP**) using number 7 button.

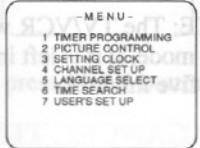

2

Press number 1 button to select (**GAME MODE [ON]**).

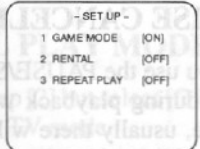

3

Press **MENU** button to return to TV mode.

TO CANCEL THE GAME MODE

- Repeat steps [1] and [2]. Then, follow step [3] to select [OFF]. Press **MENU** button to return to TV mode.
- OR*
- Set the **PICTURE CONTROL**. The **GAME MODE** will then automatically be turned [OFF].

PICTURE CONTROL

Adjust picture controls for a natural looking image.

- You must use the remote control unit for the following steps:

1

Press **MENU** button.

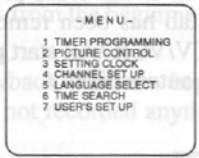

2

Select item 2 (**PICTURE CONTROL**) using number 2 button.

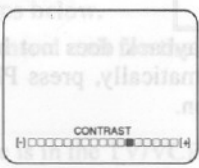

3

Press **SELECT** button repeatedly until desired control is displayed.

Each time you press **SELECT** button, **CONTRAST**, **BRIGHT**, **COLOR**, **TINT** and **SHARPNESS** will appear on the screen in sequence.

4

Adjust the picture control using **CH ▲** or **▼** button.

- Your TV/VCR's picture controls — **CONTRAST**, **BRIGHT**, **COLOR**, **TINT** and **SHARPNESS** — are preset to the factory specification. This is usually best, but if you need to make any further adjustments, use the following chart as a guide.

	CH ▼	CH ▲
CONTRAST	to decrease contrast	to increase contrast
BRIGHT	to decrease brightness	to increase brightness
COLOR	to pale	to brilliant
TINT	to purple	to green
SHARPNESS	to soft	to clear

NOTE: When setting the **PICTURE CONTROL**, the **GAME MODE** will be automatically set to [OFF].

TO EXIT THE REPEAT PLAY MODE

Press **STOP** button to stop playback. And repeat steps [1], then follow step [2] but select [OFF]. Press **MENU** button to return to TV mode.

PLAYBACK

Power must be turned on.

1

Insert a cassette into the cassette compartment.

NOTE: If the erase-protection tab has been removed, the TV/VCR will start playback automatically.

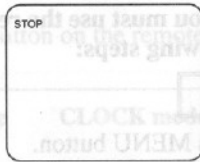

2

If playback does not begin automatically, press PLAY button.



3

Press STOP button when playback is completed.

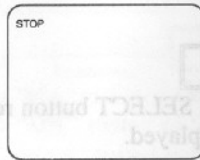

VISUAL SEARCH (SP/LP/SLP MODE)

You may view a video tape at a high speed in either a forward or reverse direction. This feature is useful in finding or skipping over a particular scene on a tape.

Forward Direction:

When in the Play mode, press F.FWD button to view the tape at a fast speed in the forward direction. The sound will be muted.

Reverse Direction:

To view the tape at a fast speed in the reverse direction, press REW button. The sound will be muted.

Press PLAY button to return to normal playback.

NOTE: The picture will not be as good as in normal playback during Visual Search.

SHARPNESS	to soft	to clear
TINT	to purple	to green
COLOR		

SUPER HIGH SPEED SEARCH (LP/SLP MODE)

For Visual Search in super high speed:

- 1) Press either F.FWD or REW button while the unit is in the Play mode.
- 2) Release button.
- 3) Depress it again. The unit will now search in super high speed.

Press PLAY button to return to normal playback.

NOTE: Tapes recorded in the SP or LP mode will display a noise bar on the TV/VCR screen and the picture may revert to Black and White. This is normal.

STILL PICTURE DURING PLAYBACK

If you press PAUSE/STILL button during the Play mode, the picture will "freeze" on the TV/VCR screen. You may use this feature to study a particular scene. (Only tapes recorded in the SLP mode will show the least amount of lines.)

Press PLAY button to continue playback.

NOTE: The TV/VCR will automatically switch to the Stop mode, if it is left in the Pause/Still mode for more than five minutes.

NOISE CANCELLING

If you use the PAUSE/STILL button to freeze the picture during playback with tapes recorded in the SLP mode, usually there will be video "noise bars" on the TV/VCR screen.

This is normal, however, this TV/VCR has a special feature that allows you to reposition or reduce the lines. Each time you press PAUSE/STILL button the lines will change position on the TV/VCR screen. This enables you to see the picture in its entirety without distracting noise lines.

If the tape was originally recorded in the SP or LP mode, the still picture may, in addition to the "noise bars", revert to black and white. This is normal.

SPECIAL PLAYBACK

COUNTER MEMORY

RENTAL PLAY

This function enables you to improve the picture quality when playing back worn cassettes such as those rented from a video shop.

- Before playback, follow steps below.
- You must use the remote control unit for the following steps:
- Power must be turned on.
- Make sure that a cassette tape is in the TV/VCR.

1

Press MENU button.

Select item 7 (USER'S SET UP) using number 7 button.

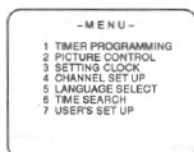

2

Press number 2 button to select (RENTAL [ON]).

- Once you select the Rental Play mode, it stays in effect even after you turn off the TV/VCR.

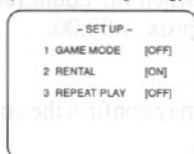

3

First press MENU button, then press PLAY button to start the Rental play.

TO EXIT THE RENTAL PLAY MODE

Repeat steps [1]. Then, follow step [2] but select [OFF]. Press MENU button to return to TV mode.

AUTO REPEAT PLAYBACK

The TV/VCR has an auto repeat function that allows you to repeat a tape indefinitely without using the PLAY button. There are two selections for Auto Repeat Playback;

ALL REPEAT: repeat playback from the beginning to the end of the tape.

BLANK REPEAT: repeat playback from the beginning to the blank part, which is not recorded anything for more than 10 seconds.

- Before playback, follow steps below.
- You must use the remote control unit for the following steps:
- Power must be turned on.
- Make sure that a cassette tape is in the TV/VCR.

1

Press MENU button.

Select item 7 (USER'S SET UP) using number 7 button.

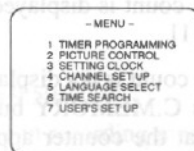

2

Press number 3 button repeatedly to select [ALL] or [BLANK]. [ALL] or [BLANK] appears besides the "REPEAT PLAY".

- Once you select the Repeat Play mode, it stays in effect even after you turn off the TV/VCR.

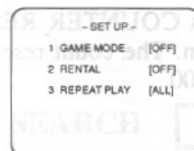

3

First press MENU button, then press PLAY button to start the Repeat Play. "REPEAT PLAY ▶" is displayed on the screen.

- If the rental play function is set ON, the "RENTAL PLAY ▶" display has priority.

NOTES:

- 1) All buttons except POWER and STOP buttons do not work during Auto Repeat Playback. Always set the Auto Repeat Playback function to [OFF] when not in use.
- 2) If the Counter Memory (See page 20) is activated, the tape will automatically stop when the count returns to approx. 0:00:00 during Auto Rewind.

TO EXIT THE REPEAT PLAY MODE

Press STOP button to stop playback. And repeat steps [1], then follow step [2] but select [OFF]. Press MENU button to return to TV mode.

COUNTER MEMORY

The Counter Memory can be used during rewind or fast forward to automatically stop the tape when the count reaches a preset memory position of approx. 0:00:00 reading.

For example, this feature can be used to return the tape to a pre-selected position immediately after recording, or to repeatedly playback a certain portion of a tape.

- You must use the remote control unit for the following steps:
- Power must be turned on.
- Make sure that a cassette tape is in the TV/VCR.

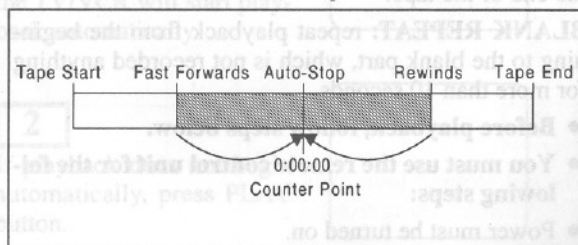

1

If the count is displayed on the TV/VCR screen, skip step [1].

If the count is not displayed, press C.MEMORY button so that the counter appears on the TV/VCR screen.

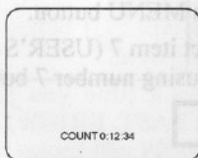

2

Press COUNTER RESET button. The count resets to 0:00:00.

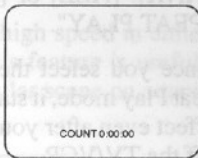

3

Press COUNTER MEMORY button. "MEMORY" appears on the screen.

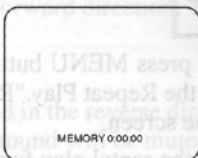

4

Press RECORD or PLAY button.

5

Press STOP button when recording or playback is completed.

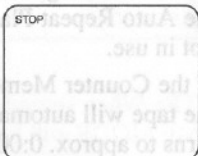

6

Press REWIND button.

The tape will automatically stop when the count returns to approx. 0:00:00.

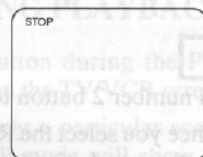

You may confirm the counter by pressing SELECT button.

TO CANCEL THE COUNTER MEMORY

1

Press C.MEMORY button so that the counter appears.

2

Press C.MEMORY button so that "COUNT" appears on the TV/VCR screen.

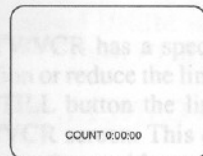

TIME SEARCH

The Time Search function makes it possible to quickly advance the tape from any position by entering the exact desired amount of playback time of the part that you want to skip.

- You must use the remote control unit for the following steps:
- Power must be turned on.
- Make sure that a cassette tape is in the TV/VCR.

In the example below, search the position after 2 hours 53 minutes from now.

1

Press MENU button.

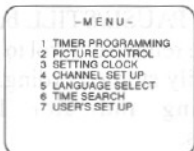

2

Select item 6 (TIME SEARCH) using number 6 button. The hour digit flashes.

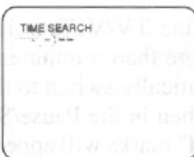

3

Enter the desired hour with number button.

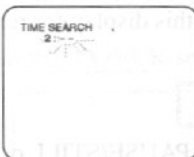

4

Enter the desired minutes with number button.

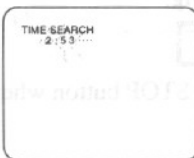

- To correct the hour, press DELETE button and repeat steps [3] and [4].
- To correct the minute, enter correct numbers using number button.
- To cancel the Time search function, press MENU button.

5

Press F.FWD or REWIND button. The tape will move to the specified point.

The time counts down as the searching progresses. When 0:00 is reached, the tape will start playback automatically.

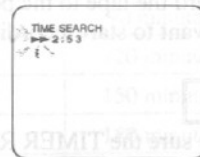

NOTES:

- Time search can be set up to 9:59.
- This function is not operative in recording mode.
- Counter Memory function is not operative in this mode.
- This function is not operative when a cassette tape is not inserted in the TV/VCR.

TO FINISH THE TIME SEARCH MODE

Press STOP button on the TV/VCR or remote control unit.

This will delete the selected time.

VIEWING AND RECORDING THE SAME PROGRAM

You can only watch the same TV program that is being recorded.

NOTE: You may not have good results when you record a TV game software etc.

1

Insert a blank cassette, or one that you want to record over, into the cassette compartment.

If necessary, rewind or fast forward the tape to the point you want to start recording.

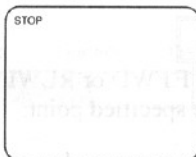

2

Make sure the TIMER REC. indicator is off. If it lights up, press POWER button to turn on the TV/VCR.

3

Press SPEED button on the remote control repeatedly until the desired recording speed is displayed (SP/LP/SLP).

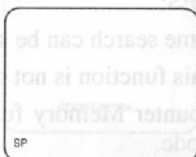

4

Select the channel to be recorded by using the number button or the CH ▲ or ▼ button.

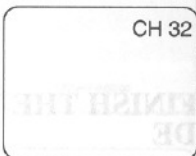

5

Press RECORD button. Recording indicator lights up.

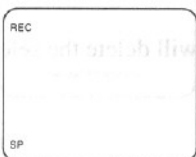

To skip some material while you are recording:

6

Press PAUSE/STILL button on the remote control to temporarily stop recording. Recording indicator light blinks.



NOTES:

- If the TV/VCR is left in the Pause/Still mode for more than 5 minutes while Recording, it will automatically switch to the Recording mode. When in the Pause/Still mode, a display showing 5 "■" marks will appear on the screen. Each "■" mark represents one minute of Pause time. You may refer to this display for remaining pause time available.

7

Press PAUSE/STILL or RECORD button to resume recording.

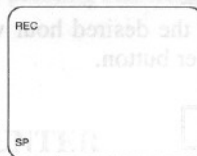

8

Press STOP button when recording is completed.

OTR (ONE TOUCH RECORDING)

The One Touch Recording function enables you to record a program simply by using the OTR button on the TV/VCR.

According to the table, simply press OTR button as many times as needed to set the desired recording length. The channel number to be recorded and recording length will be shown on the TV/VCR screen.

- This function is not operative using the remote control.

1

Insert a blank cassette, or one that you want to record over, into the cassette compartment.

If necessary, rewind or fast forward the tape to the point you want to start recording.

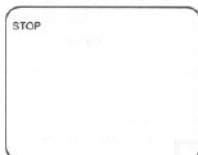

2

Select the channel to be recorded.

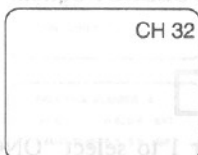

3

Press RECORD/OTR button on the TV/VCR several times.

Recording starts immediately when the RECORD/OTR button is pressed, even if you are watching a TV program.

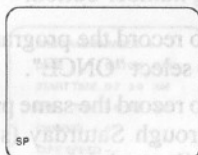

TO STOP THE OTR OPERATION

Press STOP button on the TV/VCR or remote control.

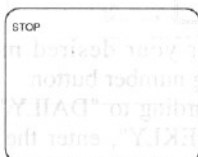

Push(es)	DISPLAY	LENGTH
1 push	NORMAL REC MODE	
2 pushes	0:30	30 minutes
3 pushes	1:00	60 minutes
4 pushes	1:30	90 minutes
5 pushes	2:00	120 minutes
6 pushes	2:30	150 minutes
7 pushes	3:00	180 minutes
8 pushes	3:30	210 minutes
9 pushes	4:00	240 minutes
10 pushes	4:30	270 minutes
11 pushes	5:00	300 minutes
12 pushes	5:30	330 minutes
13 pushes	6:00	360 minutes
14 pushes	6:30	390 minutes
15 pushes	7:00	420 minutes
16 pushes	7:30	450 minutes
17 pushes	8:00	480 minutes
18 pushes	NORMAL REC MODE	

The timer on the TV/VCR screen counts down as the recording progresses.

NOTES:

- Each time you press OTR button, you will extend the recording time by 30 minutes at a time up to 8-hours (or to the end of the tape).
- When the OTR button is pushed 18 times, the TV/VCR will record continuously until the end of the tape.
- The recording length time remaining will be displayed on the TV/VCR screen as the recording is started.
- Recording stops when 0:00 is reached.
- Please note that in the SLP mode maximum recording time, assuming the tape is started of the beginning, is 8 hours using T-160 (or 6 hours using T-120).

AUTOMATIC TIMER RECORDING

You may set the TV/VCR to record while you are away. You can set seven events to record on a specific day, daily or weekly within a 1 year period.

- You must use the remote control unit for the following steps:
- Be sure the clock is set to the correct time and date before setting the timer.
- Power must be turned on to set automatic timer recording.

In the example below, the timer is being set to record:

PROGRAM NUMBER 4
 DATE MAY 6th, 1995
 SETTING TIME from 7:30AM to 8:50AM
 CHANNEL CH61
 TAPE SPEED LP

1

Insert a blank cassette, or one that you want to record over, into the cassette compartment.

If necessary, rewind or fast forward the tape to the point you want to start recording.

2

Press MENU button.

Select item 1 (TIMER PROGRAMMING) using number 1 button.

```

    -MENU-
    1 TIMER PROGRAMMING
    2 PICTURE CONTROL
    3 SETTING CLOCK
    4 CHANNEL SET UP
    5 LANGUAGE SELECT
    6 TIME SEARCH
    7 USER'S SET UP
    
```

3

The program number which is not set up flashes.

- When Timer Recording has already been filled, "PROG. 12345678" appears. If so, press MENU button to return the TV mode.
- When you did not set the clock, "SETTING CLOCK" appears. If so, follow page 14 to set the clock and repeat from step [2].

```

    PROG. 12345678
    DATE
    START TIME
    END TIME
    CHANNEL
    TAPE SPEED
    
```

4

Enter your desired program number using number button.

```

    PROGRAM NUMBER 4
    DATE
    START TIME
    END TIME
    CHANNEL
    TAPE SPEED
    
```

- The program number 8 is used for setting Today Timer Recording only. You cannot select number 8 in the procedure of Automatic Timer Recording.
- When a Timer Recording is being carried out, you cannot set or change any programming of Timer Recording.

5

Press SELECT button.

```

    PROGRAM NUMBER 4
    DATE 05/06 1995
    ONCE-1 DAILY-2 WEEKLY-3
    START TIME
    END TIME
    CHANNEL
    TAPE SPEED
    
```

6

Enter 1 to select "ONCE", enter 2 to select "DAILY" or enter 3 to select "WEEKLY" using number button.

```

    PROGRAM NUMBER 4
    DATE 05/06 ONCE
    START TIME
    END TIME
    CHANNEL
    TAPE SPEED
    
```

- To record the program once, press number 1 button to select "ONCE".
- To record the same program every day from Sunday through Saturday (such as soap operas and other daily serials), press number 2 button to select "DAILY".
- To record the same program every week on the same day (such as every Saturday), press number 3 button to select "WEEKLY".

7

Enter your desired month using number button. Regarding to "DAILY" and "WEEKLY", enter the date you want to start it.

```

    PROGRAM NUMBER 4
    DATE 05/06 ONCE
    START TIME
    END TIME
    CHANNEL
    TAPE SPEED
    
```

8

Enter your desired day using number button. The day of the week changes automatically.

```

    PROGRAM NUMBER 4
    DATE 05/06 SAT
    START TIME
    END TIME
    CHANNEL
    TAPE SPEED
    
```

9

Enter your desired hour using number button.

```

PROGRAM NUMBER 4
DATE 05/06 SAT
START TIME 07:--:--
END TIME --:--:--
CHANNEL --
TAPE SPEED --

```

10

Enter your desired minute using number button.

```

PROGRAM NUMBER 4
DATE 05/06 SAT
START TIME 07:30
END TIME --:--:--
CHANNEL --
TAPE SPEED --

```

11

Enter 1 to select "AM" or enter 2 to select "PM" using number button.

```

PROGRAM NUMBER 4
DATE 05/06 SAT
START TIME 07:30 AM
END TIME --:--:--
CHANNEL --
TAPE SPEED --

```

12

Repeat steps [9]-[11] to set the end time.

```

PROGRAM NUMBER 4
DATE 05/06 SAT
START TIME 07:30 AM
END TIME 08:50 AM
CHANNEL 61
TAPE SPEED --

```

13

Enter your desired channel using number button.

```

PROGRAM NUMBER 4
DATE 05/06 SAT
START TIME 07:30 AM
END TIME 08:50 AM
CHANNEL 61
TAPE SPEED --

```

14

Enter 1 to select "SP", enter 2 to select "LP" or enter 3 to select "SLP" using number button.

```

PROGRAM NUMBER 4
DATE 05/06 SAT
START TIME 07:30 AM
END TIME 08:50 AM
CHANNEL 61
TAPE SPEED LP

```

15

Press MENU or SELECT button on the remote control unit. Program 4 is now completed.

To set another program, repeat steps [2] to [15].

16

Press POWER button to set automatic timer recording. The TIMER REC indicator lights up.

- While watching TV, "TIMER REC STANDBY" starts flashing on the TV/VCR screen 2 minutes before the programmed start time.

You must turn off the TV/VCR to activate automatic timer recording.

TO CORRECT A PROGRAM

- While setting a program; press DELETE button to go back one step, and enter correct numbers using number button.
- After setting a program;
 - Press POWER button.
 - Repeat steps [2] - [4].
 - Press SELECT button repeatedly (or press DELETE button to go back one step) until your desired digit flashes and make changes.
 - Repeat steps [15] and [16].

TO CANCEL AN AUTOMATIC TIMER RECORDING

- While setting or after setting a program; press POWER button and repeat steps [2] ~ [4] and press DELETE button.
- While recording is in progress; press MONITOR button, then press STOP/ EJECT button on the TV/VCR. If you press POWER button to turn off before the end time, timer recording will continued. Repeat steps [2] ~ [4] and press DELETE button.

WHEN THE PROGRAMS OVERLAP

The earlier program has priority.

If you programmed as per the illustration the timer recording would be carried out as follows:

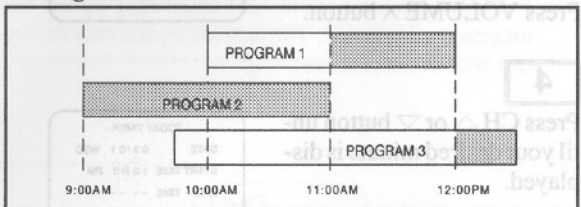

9:00AM - 11:00AM for PROGRAM 2
 11:00AM - 12:00PM for PROGRAM 1
 12:00PM - for PROGRAM 3

TODAY TIMER RECORDING

You may set the TV/VCR to record one program within 24 hours by simply pressing MONITOR button on the TV/VCR. It is easy for you to record today's TV program.

- TODAY TIMER RECORDING can not be programmed by the remote control. This function can only be programmed from the TV/VCR.
- Power must be on to program Today Timer Recording.
- Clock must be set to the correct time before setting the timer.
- Today Timer Recording is memorized to program number 8.

In the example below, the Today Timer Recording is being set to record. (Current time is 8:00PM):

SETTING TIME from 10:00PM to 11:00PM
 CHANNEL CH10
 TAPE SPEED SP

1

Insert a blank cassette, or one that you want to record over, into the cassette compartment.

If necessary, rewind or fast forward the tape to the point you want to start recording.

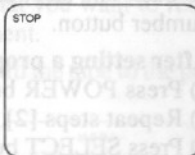

2

Press MONITOR button on the TV/VCR.

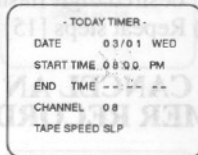

NOTES:

- You may forward to the next step by pressing VOLUME Δ button on the TV/VCR.
- When you press VOLUME ∇ button on the TV/VCR, all selections will be erased and the TV/VCR screen will return to the initial display (step [2]).

3

Press CH Δ or ∇ button until your desired hour is displayed.

Press VOLUME \wedge button.

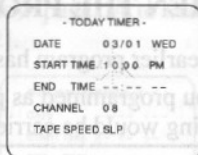

4

Press CH Δ or ∇ button until your desired minute is displayed.

Press VOLUME Δ button.

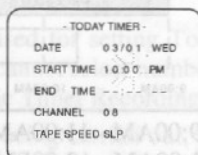

5

Press CH Δ or ∇ button until AM or PM is displayed.

Press VOLUME Δ button.

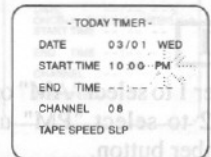

6

Repeat steps [3] - [5] to set the end time.

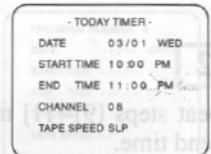

7

Press CH Δ or ∇ button until your desired channel number is displayed.

Press VOLUME Δ button.



8

Press CH Δ or ∇ button until your desired tape speed is displayed.



9

Press MONITOR button.

10

Press POWER button to set Today Timer Recording. The TIMER REC indicator lights up.

- If power is not turned off and you continue watching TV, "TIMER REC STANDBY" starts flashing on the TV/VCR screen 2 minutes before the programmed start time.

You must turn off the TV/VCR to activate Today Timer Recording.

TO CORRECT A PROGRAM

- **While setting a program;** Press VOLUME ∇ button on the TV/VCR and re-set program.
- **After setting a program;**
 - 1) Press POWER button.
 - 2) Press MONITOR button.
 - 3) Press VOLUME \wedge button until desired digit flashes.
 - 4) Press CH \wedge or ∇ button to make desired change.
 - 5) Repeat steps [9] and [10].

TO CANCEL A TODAY TIMER RECORDING

- While setting or after setting a program; 1) press POWER button. 2) press MONITOR button, then, press VOLUME ∇ button.
- While recording is in progress; 1) press MONITOR button. 2) press STOP/ EJECT button on the TV/VCR. If you press POWER button to turn off before the end time, timer recording will continued.

HINTS ON AUTOMATIC TIMER RECORDING AND TODAY TIMER RECORDING

- Make sure the channel you want to record is properly set in advance.
- It is not necessary to press RECORD button for timer recording.
- Recording begins automatically at the set of the Start time.
- If you are recording using a Timer mode, you may not operate the unit manually.
- The erase-prevention tab on the cassette must be in place (or you must put tape over the hole).
- If the erasure protection tab is removed, the cassette will be ejected when the POWER button is pressed to off, and the TIMER REC indicator flashes.
- If the POWER button is pressed to off with no cassette loaded, the TIMER REC indicator flashes.
- If the TIMER REC indicator flashes, insert a tape with the erase-prevention tab intact. The TIMER REC indicator will illuminate.
- If the tape runs out before the end time, the TV/VCR will switch to the Stop mode immediately, and the tape will be ejected.
- If there is a power failure or if the TV/VCR is unplugged for more than a few seconds, the clock and timer settings will be lost. At this time, the TV/VCR

WHEN THE PROGRAMS OVERLAP

Today Timer Recording has priority. However, if another program has been activated before the start of the Today Timer Recording, the Today Timer Recording will begin after the other program has finished.

If you programmed as per the illustration the timer recording would be carried out as follows:

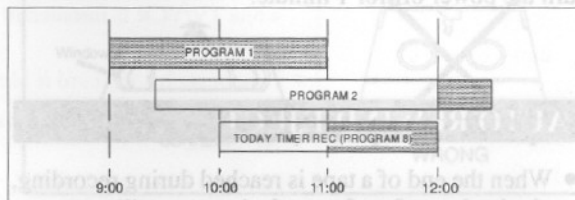

9:00PM - 11:00PM

for PROGRAM 1

11:00PM - 12:00AM

for PROGRAM 8

(Today Timer Recording)

for PROGRAM 2

12:00AM -

TO CHECK THE START/END TIME

- 1) Press POWER button so that the TIMER REC indicator goes off.
- 2) Press MENU button on the remote control.
- 3) Select item 1 (TIMER PROGRAMMING) using number 1 button.
- 4) Enter your desired program number using number button. The details of selected program appears on the TV/VCR screen.
- 5) Press MENU button. The TV/VCR screen returns to the TV mode.



SPECIAL FEATURES

DEGAUSSING

Magnetism from nearby appliances might affect the color of the TV picture.

If this happens, move this unit away from the appliance. In this TV/VCR, each time power is off, automatic degauss circuit functions. If the color is still not correct, turn the power off for 1 minute.

AUTO REWIND-EJECT

- When the end of a tape is reached during recording, playback, or fast-forward, the tape will automatically rewind to the beginning (or to the 0:00:00 count reading if the memory function is activated), power off and tape ejects.
- This function is operative when Auto Repeat is set to the [OFF] position.
- The tape will not auto-rewind during timer recording or One Touch Recording.
- When the tape is rewound to the preset memory position or the REW button is pressed during Auto Rewind, the tape will not eject and TV/VCR will not turn off.

TRACKING ADJUSTMENT

- Tracking adjustment will be set automatically (Digital Tracking function) when you start playback.
- When playing pre-recorded tapes or tapes recorded on units other than your own, noise lines (black and white streaks) may appear on the playback picture. If this occurs, adjust the tracking control by pressing CH Δ or ∇ button until the streaks disappear. To return to the DTR function, stop the tape once and start playback again.

NOTE: This function is controlled only by the buttons on the TV/VCR. The buttons on the remote control will not adjust tracking.

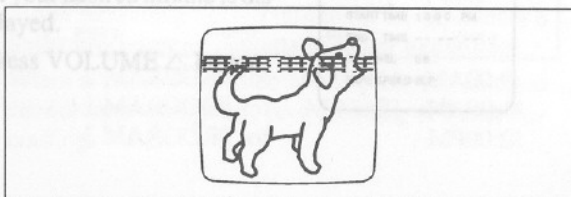

TO CHANGE THE LANGUAGE

You can change the language of the change to on screen display. Follow the steps below:

- 1) Press MENU button on the remote control.
- 2) Select item 5 (LANGUAGE SELECT) using number button.
- 3) Select item 1 (ENGLISH) or 2 (ESPAÑOL= SPANISH) using number button.
- 4) Press MENU button to return to TV mode.

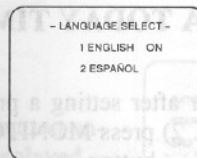

SETTING THE SLEEP TIMER

The sleep timer function enables you to turn off the TV/VCR without using the POWER button after a desired time period.

Press SLEEP button on the remote control repeatedly until desired SLEEP time is displayed

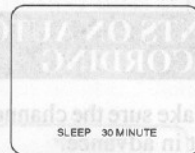

	SLEEP TIME	DISPLAY
1 push	0 minute	0 MINUTE
2 pushes	30 minutes	30 MINUTE
3 pushes	60 minutes	60 MINUTE
4 pushes	90 minutes	90 MINUTE
5 pushes	120 minutes	120 MINUTE
6 pushes	0 minute	0 MINUTE

TO CANCEL THE SLEEP TIMER

The turn off time can be determined by the number of times you press the SLEEP button. Press SLEEP button on the remote control repeatedly until "SLEEP 0 MINUTE" is displayed.

VIDEO CASSETTE TROUBLESHOOTING GUIDE

This TV/VCR will operate with any cassette that has the VHS mark. For best results we recommend the use of high-quality tapes.

- Do not use poor quality or damaged tapes.

The table below shows the recording/playback time using a T-60, T-120 or T-160 tape in the SP, LP or SLP mode.

MODE	CASSETTE		
	T-60	T-120	T-160
SP Mode	1 hour	2 hours	2-2/3 hours
LP Mode	2 hours	4 hours	5-1/3 hours
SLP Mode	3 hours	6 hours	8 hours

When handling video tapes, take the following precautions:

- Avoid moisture, which can condense on the tape if it is moved from a cold place to a warm place. Playing a tape that has moisture in it will damage the tape and your TV/VCR. Before using a tape with these conditions, wait until the tape has warmed to room temperature and the moisture has evaporated.
- Avoid extreme heat, high humidity and magnetic fields.
- Do not tamper with the cassette mechanism.
- Do not touch the tape with your fingers.

ERASE PREVENTION

You may prevent accidental erasing of a tape by breaking off the tab on the back edge of the cassette. If you decide to record on the tape again, cover the hole with transparent tape.

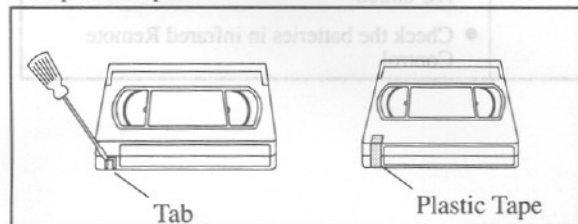

INSERTING A CASSETTE

Insert the cassette in the direction as shown. Push in gently, but continuously, on the center-back of the cassette until it is drawn completely into the TV/VCR.

The TV/VCR will automatically turn on when the cassette is properly inserted.

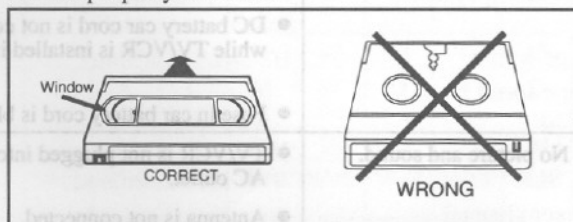

REMOVING A CASSETTE

1

Press STOP/EJECT button on the TV/VCR or EJECT button on the remote control unit in the stop mode.

2

When the cassette stops moving, pull the cassette out of the cassette compartment and store it properly.

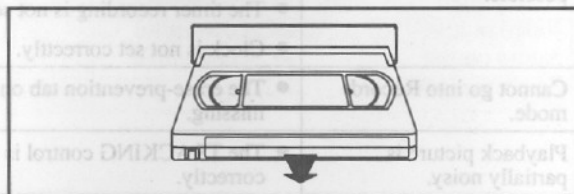

3

Store the cassette in its case as shown.

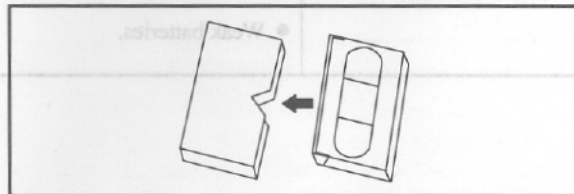

TROUBLESHOOTING GUIDE

If you have followed the instructions contained in this manual and have difficulty in operating your TV/VCR, locate the SYMPTOM in the left column below. Check the corresponding POSSIBLE CAUSE and CORRECTIVE ACTION columns to remedy the problem.

SYMPTOM	POSSIBLE CAUSE	CORRECTIVE ACTION
No power.	<ul style="list-style-type: none"> ● AC Power cord is not connected. ● DC battery car cord is not connected while TV/VCR is installed in vehicle. ● Fuse in car battery cord is blown. 	<ul style="list-style-type: none"> ● Connect AC power cord to AC outlet. ● Connect battery cord to vehicle's cigarette lighter socket and to 12V DC jack on back of TV/VCR. ● Replace with 5A, 250V fuse.
No picture and sound.	<ul style="list-style-type: none"> ● TV/VCR is not plugged into an active AC outlet. ● Antenna is not connected. ● No channel in memory. 	<ul style="list-style-type: none"> ● Plug power cord into an active AC outlet. ● Check antenna connection. ● Program tuner's memory.
No picture or poor picture on TV/VCR.	<ul style="list-style-type: none"> ● Direction or condition of antenna is not adequate. ● Picture control is not adequate. ● No channel in memory. 	<ul style="list-style-type: none"> ● Adjust direction or replace antenna. ● Adjust picture controls. ● Program tuner's memory.
No sound or poor sound.	<ul style="list-style-type: none"> ● Volume control on remote control unit or main unit is in minimum position. ● MUTE button on the remote control unit is in the ON position. 	<ul style="list-style-type: none"> ● Adjust volume control on remote control unit or set. ● Press MUTE button.
Timer recording is not possible.	<ul style="list-style-type: none"> ● The timer recording is set incorrectly. ● The timer recording is not set to ON. ● Clock is not set correctly. 	<ul style="list-style-type: none"> ● Set the timer recording correctly. ● Set the timer recording to ON. ● Follow directions for setting clock.
Cannot go into Record mode.	<ul style="list-style-type: none"> ● The erase-prevention tab on cassette is missing. 	<ul style="list-style-type: none"> ● Place transparent tape over missing erase-prevention tab.
Playback picture is partially noisy.	<ul style="list-style-type: none"> ● The TRACKING control is not set correctly. 	<ul style="list-style-type: none"> ● Adjust TRACKING control for better picture.
Noise in picture on playback.	<ul style="list-style-type: none"> ● Video heads are dirty. 	<ul style="list-style-type: none"> ● Head cleaning is necessary, consult the nearest Funai Service Center.
No operation by infrared Remote Control.	<ul style="list-style-type: none"> ● No power to TV/VCR. ● Weak batteries. 	<ul style="list-style-type: none"> ● Make sure the AC cord is connected to an AC outlet. ● Check the batteries in infrared Remote Control.

CABINET CLEANING

- Wipe the front panel and other exterior surfaces of the TV/VCR with a soft cloth immersed in lukewarm water and wrung dry.
- Never use a solvent or alcohol. Do not spray insecticide liquid near the TV/VCR. Such chemicals may cause damage and discoloration to the exposed surfaces.

HEAD CLEANING

- Picture playback may become blurred or interrupted while the TV program reception is clear. This does not mean that the recorded program has been erased. Dirt accumulated on the video heads after long periods of tape playback, or the usage of rental or worn tapes can cause this problem. In this case, video head cleaning requires highly technical attention, therefore consult the nearest Funai Service Center. Clean heads only when problems occur.

SERVICING

- Should your TV/VCR become inoperative, do not try to correct the problem by yourself. There are no user-serviceable parts inside. Turn off, unplug the power cord, and take the unit to the nearest Funai Service Center for servicing.

SPECIFICATIONS

GENERAL SPECIFICATIONS

CRT	: 9 inch in-line gun, 90° deflection tube
Television system	: NTSC-M
Closed Caption System	: §15.119/FCC
Recording system	: Rotary two-head helical scan system
Tape width	: 1/2 inch (12.65mm)
Tape speed	
SP	: 1-5/16" (33.35mm)/sec.
LP	: 21/32" (16.67mm)/sec.
SLP	: 7/16" (11.12mm)/sec.
Tuner channel	
TV VHF Low	: #2~#6
TV VHF High	: #7~#13
TV UHF	: #14~#69
CATV	
VHF	: 5A
MID band	: A5~A1, A~I
SUPER band	: J~W
HYPER band	: W+1~W+84
Terminals:	
Antenna input	VHF/UHF 75 ohms unbalanced
Video input	RCA connector
Audio input	RCA connector
Video output	RCA connector
Audio output	RCA connector
Earphone jack	Ø3.5

ELECTRICAL SPECIFICATIONS

Video input level	: 0.5~2.0V _{p-p}
Audio input level	: -15dBs
Video S/N ratio	: More than 46dB
Audio S/N ratio	: More than 43dB

OTHER SPECIFICATIONS

Power requirement	: AC 120V/60Hz, DC 12V
Power consumption	: AC 70W, DC 65W
Dimensions	H : 12-1/4" (320mm) W : 11 15/16" (292mm) D : 12-7/8" (335mm)
Weight	: 20.9 lbs (9.5 kg)
Accessories	: Remote Control 2 "AA" Batteries Dipole Antenna Matching Adaptor Car Battery Cord AC Cord Owner's Manual

• Design and specifications are subject to change without notice.

CABLE CHANNEL DESIGNATIONS

If you subscribe to cable TV, the channels are displayed as 1 ~ 125.

Cable companies often designate the other channels with letters or letter-number combinations. Please check with your local cable company.

The following is a chart of common cable channel designations.

CATV Channel	5A	2	3	4	5	6	7	8	9	10	11	12	13	A	B
TV Display	1	2	3	4	5	6	7	8	9	10	11	12	13	14	15
CATV Channel	C	D	E	F	G	H	I	J	K	L	M	N	O	P	Q
TV Display	16	17	18	19	20	21	22	23	24	25	26	27	28	29	30
CATV Channel	R	S	T	U	V	W	W+1	W+2	W+3	W+4	W+5	W+6	W+7	W+8	W+9
TV Display	31	32	33	34	35	36	37	38	39	40	41	42	43	44	45
CATV Channel	W+10	W+11	W+12	W+13	W+14	W+15	W+16	W+17	W+18	W+19	W+20	W+21	W+22	W+23	W+24
TV Display	46	47	48	49	50	51	52	53	54	55	56	57	58	59	60
CATV Channel	W+25	W+26	W+27	W+28	W+29	W+30	W+31	W+32	W+33	W+34	W+35	W+36	W+37	W+38	W+39
TV Display	61	62	63	64	65	66	67	68	69	70	71	72	73	74	75
CATV Channel	W+40	W+41	W+42	W+43	W+44	W+45	W+46	W+47	W+48	W+49	W+50	W+51	W+52	W+53	W+54
TV Display	76	77	78	79	80	81	82	83	84	85	86	87	88	89	90
CATV Channel	W+55	W+56	W+57	W+58	A-5	A-4	A-3	A-2	A-1	W+59	W+60	W+61	W+62	W+63	W+64
TV Display	91	92	93	94	95	96	97	98	99	100	101	102	103	104	105
CATV Channel	W+65	W+66	W+67	W+68	W+69	W+70	W+71	W+72	W+73	W+74	W+75	W+76	W+77	W+78	W+79
TV Display	106	107	108	109	110	111	112	113	114	115	116	117	118	119	120
CATV Channel	W+80	W+81	W+82	W+83	W+84										
TV Display	121	122	123	124	125										

Free Manuals Download Website

<http://myh66.com>

<http://usermanuals.us>

<http://www.somanuals.com>

<http://www.4manuals.cc>

<http://www.manual-lib.com>

<http://www.404manual.com>

<http://www.luxmanual.com>

<http://aubethermostatmanual.com>

Golf course search by state

<http://golfingnear.com>

Email search by domain

<http://emailbydomain.com>

Auto manuals search

<http://auto.somanuals.com>

TV manuals search

<http://tv.somanuals.com>