

XG0224

Hardware Guide



Preface

You have purchased the XG0224, a compact, 24 port 1 Gigabit Ethernet layer 2 switch that achieves unsurpassed standards of high throughput and low-latency performance.

This manual explains the procedures required to install your XG0224 and should be read and understood before you start using your XG0224.

First edition: June 2009

Second edition: November 2009

This manual contains the technology regulated by "Foreign Exchange and Foreign Trade Control Law."

Therefore when this manual is exported or provided to a nonresident, the appropriate permission based on this law is required.

Screenshots are used according to the guidelines provided by Microsoft Corporation.

Copyright FUJITSU LIMITED 2009

LICENSE AGREEMENT

Product Name	XG Series Basic Software
Total number of licenses	1

Thank you for purchasing the XG Series switch product ("Hardware") and accompanying software ("Software," together with Hardware, collectively, referred to as "Product") manufactured by Fujitsu Limited ("Fujitsu"). The use of the Product is subject to Customer's acceptance of the terms and conditions of the following requirements ("Use Requirements"). Please note that Customer's use, installation or backup of the Product constitutes your acceptance of the following Use Requirements. Please keep this License Agreement in a secure location as it will not be re-issued.

1. Use and Copyright of the Software

Customer may use the Software solely in connection with the single Hardware that Customer has purchased. The total number of Hardware that Customer can use in connection with the Software is limited to the number of license specified above. Customer needs to purchase an additional license from Fujitsu in order to use the Software in connection with additional unit of the XG Series switch product or other functions. Customer acquires only right to use the Software by purchasing, this Software is copyrighted by Fujitsu or the third party that developed the software used in the Software.

2. Transfer

Customer may not assign, transfer, lease, sublicense or sublicense the Software or any rights in or to the Software to third parties. Customer further agrees to keep the Software free and clear of any and all claims, liens, security interests and other encumbrances.

3. Modification

Customer may not modify, disassemble, decompile or reverse engineer the Software.

4. Scope of Warranty

- 1) If Customer notifies Fujitsu of any discrepancy between the manual, user guides or other related documents ("Documentation") and the Software, Fujitsu shall, at its sole discretion, correct or provide information relating to such correction free of charge within ninety (90) days of Customer's purchase of the Product ("Warranty Period").
- 2) During the Warranty Period, if the said discrepancy between the Documentation and the Software cannot be corrected despite Fujitsu's repeated corrections or provision of information within reasonable limits as set forth in subsection (1) above, Fujitsu shall be liable for damages incurred to Customer by reason of such discrepancy. Fujitsu's aggregate liability for such damages shall not exceed the amount equal to the total price of the Product. Further, Fujitsu shall not be liable for (i) damages to the extent they are caused by conditions not attributable to Fujitsu, or (ii) any damages caused by special conditions such as indirect, incidental, special, consequential or punitive damages, or damages for loss of profits, revenue, business, savings, data, use or cost of substitute procurement, incurred by Customer or any third party, even if Fujitsu has been advised of the possibility of such damages or even if such damages are foreseeable.
- 3) In the event a third party files a lawsuit, an appeal, a claim, or similar action ("Claim") against Customer alleging that the Software infringes any patent, copyright, trademark, trade secret or any other intellectual property right ("Intellectual Property Rights") of such third party, upon Customer's request and Customer's delegation of its rights to Fujitsu, Fujitsu shall assume control of the defense and settlement of any such Claim at its sole cost and responsibility. In such event, Fujitsu will pay for damages and expenses attributable to such Claim.
- 4) If it is determined in a final judgment or settlement that the Software infringes Intellectual Property Rights of a third party as described in subsection (3) above, Fujitsu shall take any one of the measures described below at its sole discretion:
 - a. modify the Software to be non-infringing;
 - b. obtain permission from third parties so that the Customer can use the Software; or

- c. if in Fujitsu's sole judgment it is not commercially reasonable to perform either of the above options, subject to the limitation of liability set forth in subsection (2) above, Fujitsu shall pay for any damages Customer has incurred due to nonuse of the Software.
- 5) If the Claim described in subsection (3) above is withdrawn based on the determination that the Software does not infringe the Intellectual Property Rights of a third party, or that the Intellectual Property Rights of a third party are invalid, the expenses incurred by the Customer or Fujitsu in dealing with such Claim shall be equally divided between Customer and Fujitsu.
- 6) Except as otherwise expressly set forth above, Fujitsu shall not be liable for any damages (including, but not limited to, loss of profits, suspension of operations, loss of business-related information, or other monetary damages) arising out of the use or nonuse of the Product, even if Fujitsu has been advised of the possibility of such damages in advance.
- 7) If the Software contains software developed by a third party vendor, the warranty with respect to such third party software is limited to those warranties provided by Fujitsu hereunder, and the third party vendor does not provide any further warranties with respect to such third party software.

5. High Safety Required Use

The Customer acknowledges and agrees that the Software is designed, developed and manufactured as contemplated for general use, including without limitation, general office use, personal use, household use, and ordinary industrial uses, but is not designed, developed and manufactured as contemplated for use accompanying fatal risks or dangers that, unless extremely high safety is secured, could lead directly to death, personal injury, severe physical damage or other loss (hereinafter "High Safety Required Use"), including without limitation, nuclear reaction control in nuclear facility, aircraft flight control, air traffic control, mass transport control, medical life support system, and missile launch control in weapon system.

The Customer shall not use the Software without securing the sufficient safety required for the High Safety Required Use. In addition, Fujitsu shall not be liable against the Customer and/or any third party for any claim or damages arising in connection with the High Safety Required Use of the Software.

FUJITSU LIMITED

Contents

Preface	2
LICENSE AGREEMENT	3
Organization and Usage of This Manual	7
About This Manual	7
Target Readers and Required Knowledge	7
Areas Covered	7
Trademark Notification in This Manual	8
How the Manuals for This Device Are Organized	9
Safety Precautions	10
About Warning Descriptions	10
Notes on Maintenance	13
Precautions for Use	13
Eliminating Static Electricity from Twisted Pair Cables (Grounding)	13
Ensuring Security	13
Cleaning	13
Electromagnetic Compatibility (USA)	14
Electromagnetic Compatibility (CANADA)	14
Electromagnetic Compatibility (EU)	14
Safety	14
High safety	14
Laser Safety	15
Notes on Rack Mounting and Connecting a Powerstrip	15
About Fujitsu's Green Products	15
Notes on Use	16
Chapter 1 Getting Started	17
1.1 Items in the Package, Descriptions and Functions	18
1.1.1 Parts List	18
1.1.2 Port Side	19
1.1.3 Power Inlet Side	22
1.1.4 Top Surface	23
1.2 Options	24
1.2.1 SFP Modules	24
1.2.2 SFP+ Modules	24
1.2.3 Compact Flash	24
1.2.4 Expansion Card	25
Chapter 2 Installation	27
2.1 Requirements for Installation Environment	28
2.1.1 Installation Requirements	28
2.1.2 Space Requirements	30
2.2 Installation	31
2.2.1 Installation of the Switch	31
2.2.2 Installation of Extension Card	33
2.3 Connecting the Equipment	35
2.3.1 Discharging Twisted Pair Cable	35
2.3.2 Cleaning SFP Module / SFP+ Module / Optical Connector	35
2.3.3 Connecting Twisted Pair Cable / SFP Module / SFP+ Module / CX4 Cable	37
2.3.4 Installing Compact Flash Card	40

2.4	Connecting to a Setup PC	41
2.5	Time Setting	44
2.6	Set up IP address	45
Index		46

Organization and Usage of This Manual

This manual explains what you need to know before using this device.

In addition, the README file on CD-ROM contains important information. You will also need to read the file.

About This Manual

This manual contains important information required to use this device safely.

Read this manual thoroughly before using this device. In particular, you must read and fully understand the "Safety Precautions" described in this manual before using this device. Furthermore, this manual should be kept in an easy-to-access location for quick reference while using this device.

Fujitsu takes the utmost care to insure that our products can be used safely without causing injury to the customer or damage to their property. Please follow the instructions for using this device set forth in this manual.

Target Readers and Required Knowledge

This manual is intended for persons who perform network management.

To use this manual, basic knowledge of network and the Internet is required.

Areas Covered

The organization of this manual and the contents of each chapter are shown as follows.

Chapter Titles	Contents
Chapter 1 Getting Started	This chapter lists the items that should be in the product package, and describes the names and functions of the various components.
Chapter 2 Installation	This chapter describes how to install the switch and connect it to Console PC.

About the Symbols

The symbols used in this manual have the following meanings.

 **Hint** Indicates useful information for using this device.

Precautions Indicates precautions that must be taken when using this device.

 **Note** Indicates additional information to complement operating instructions.

 **Reference** Indicates related matters such as operation procedures, etc.

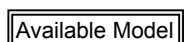
 **Available Model** Indicates the available model name when using functions of this device.

 **Warning** Indicates warning matters related to the Product Liability (P.L.) Law. Please follow them when using this device.

 **Caution** Indicates cautionary notes related to the Product Liability (P.L.) Law. Please follow them when using this device.

Trademark Notification in This Manual

Microsoft, MS-DOS, Windows, Windows NT, Windows Server and Windows Vista are registered trademarks of the Microsoft Corporation in the USA and other countries.

Adobe and Reader are trademarks or registered trademarks of Adobe Systems Incorporated in the USA and other countries.

Netscape is a trademark of Netscape Communications Corporation in the USA.

UNIX is a registered trademark of Open Group in the USA and other countries.

Other company names and product names in this manual are trademarks or registered trademarks of their respective companies.

Abbreviated Product Names

The product names used in this manual are abbreviated as follows.

Product name	Description in this manual
Microsoft® Windows® XP Professional operating system	Windows® XP
Microsoft® Windows® XP Home Edition operating system	
Microsoft® Windows® Millennium Edition operating system	Windows® Me
Microsoft® Windows® 98 operating system	Windows® 98
Microsoft® Windows® 95 operating system	Windows® 95
Microsoft® Windows® 2000 Server Network operating system	Windows® 2000
Microsoft® Windows® 2000 Professional operating system	
Microsoft® Windows NT® Server network operating system Version 4.0	Windows NT® 4.0
Microsoft® Windows NT® Workstation operating system Version 4.0	
Microsoft® Windows Server® 2003, Standard Edition	Windows Server® 2003
Microsoft® Windows Server® 2003 R2, Standard Edition	
Microsoft® Windows Server® 2003, Enterprise Edition	
Microsoft® Windows Server® 2003 R2, Enterprise Edition	
Microsoft® Windows Server® 2003, Datacenter Edition	
Microsoft® Windows Server® 2003 R2, Datacenter Edition	
Microsoft® Windows Server® 2003, Web Edition	
Microsoft® Windows Server® 2003, Standard x64 Edition	
Microsoft® Windows Server® 2003 R2, Standard x64 Edition	
Microsoft® Windows Server® 2003, Enterprise x64 Edition	
Microsoft® Windows Server® 2003 R2, Enterprise x64 Edition	
Microsoft® Windows Server® 2003, Enterprise Edition for Itanium-based systems	
Microsoft® Windows Server® 2003, Datacenter x64 Edition	
Microsoft® Windows Server® 2003 R2, Datacenter x64 Edition	
Microsoft® Windows Vista® Ultimate operating system	Windows Vista®
Microsoft® Windows Vista® Business operating system	
Microsoft® Windows Vista® Home Premium operating system	
Microsoft® Windows Vista® Home Basic operating system	
Microsoft® Windows Vista® Enterprise operating system	

How the Manuals for This Device Are Organized

The manuals for this device are organized as follows. Use these manuals as necessary.

Manual Name	Description
Safety and Installation Guide	This manual describes the safety and installation.
XG0224 Hardware Guide (This manual)	This manual describes the hardware of the XG0224.
User's Guide	This manual describes a variety of operations and procedures, including the installation and maintenance of the XG Series.

Safety Precautions



About Warning Descriptions

This manual contains precautions that must be taken in order to use this device safely and prevent personal injury or property damage. Please fully understand the meanings and contents of the following descriptions and symbols when reading this manual.

 **Warning** Indicates that improper use can cause severe damage to person, resulting in serious injury or death.

 **Caution** Indicates that improper use can cause light or moderate injury.
In addition, this symbol indicates a chance of damage to this device and other connected equipment.

The following symbols are used to indicate the type of warning or caution.

Symbols	Definitions
	The symbol in \triangle form indicates a warning or cautionary note. Specific information is shown inside or next to the symbol.
	The symbol in \circ form indicates a prohibited (Do Not) action. Specific information is shown inside or next to the symbol.
	The symbol in \bullet form indicates actions or instructions that must be followed. Specific information is shown inside or next to the symbol.



Always follow the instructions for safe use of this device. Indicates that improper use can cause severe damage to person, resulting in serious injury or death.

Warnings			
	<p>Do not disassemble, dismantle, modify or reproduce this device. Failure to follow this may result in electric shock, fire or failure.</p>		<p>Make sure to ground. Failure to do so before use may result in electric shock. Always ground before inserting the power plug into the socket. Always unplug the power plug from the socket before disconnecting the ground.</p>
	<p>Do not score, cut, or rework the power cable. Do not put any objects on the power cable. The power cable should not be pulled, bent forcibly, twisted or heated. These actions may damage the cable. Do not use the power cable while it is bundled together. Otherwise electric shock or fire may occur. The same applies to other cables.</p>		<p>You cannot use this device at a voltage other than the indicated supply voltage. Do not overload the electric outlet. Failure to follow these warnings may result in electric shock or fire.</p>
	<p>If there is lightning near the location, do not touch this device, the power cable or other cables. Failure to follow this may result in electric shock.</p>		<p>Do not use this device when the power cable or plug is damaged or the socket is loose. Continuing to use the device in this condition may result electric shock or fire.</p>
	<p>Do not connect or disconnect the power plug with wet hands. Failure to follow this may result in electric shock.</p>		<p>If you notice abnormal conditions such as overheating, smoke emission, or odor, stop using this device immediately, and pull the power cable plug from the socket. Make sure that abnormal conditions such as smoke no longer exist and contact our engineer or an engineer certified by Fujitsu. Continuing to use the device in this condition may result in electric shock or fire.</p>
 	<p>Do not insert or drop any foreign objects into the device through the vent. Also, prevent liquid such as water from entering it. In case a foreign object or liquid enters the device, you must first unplug the power plug from the socket and contact our engineer or an engineer certified by Fujitsu. Continuing to use the device in this condition may result in electric shock, fire accident or failure.</p>		<p>For interface connectors, do not insert a connector other than the appropriate connector for a specific line. Failure to follow this may result in electric shock or failure.</p>
	<p>The cover must only be opened by qualified service personnel. Also, the power cable must be unplugged during maintenance. Failure to follow this may result in electric shock.</p>		<p>The plastic sheets used for packaging must be kept out of reach of children so that they cannot put the sheets in their mouths or put their heads into them. Failure to follow this may result in suffocation.</p>
	<p>Also, keep removed screws out of reach of children so that they cannot put the screws into their mouths accidentally. In the event they put the screws into their mouths, consult a doctor immediately.</p>		<p>When cleaning, do not use cleaning sprays (that includes inflammable material) because it may cause device breakdown or fire.</p>



Caution

Indicates that improper use can cause light or moderate injury.

In addition, this symbol indicates a chance of damage to this device and other connected equipment.

Cautions	
	Do not touch this device for more than one minute while it is turned on. Failure to follow this may cause low-temperature burns.
	Do not stand this device vertically or stack it. Failure to follow this may cause the device to fall over causing injury, damage, or failure.
	Do not install this device on shaky stands, unlevel surfaces, or other unstable places. In addition, do not use this device in a location where impact or vibration occurs. Failure to follow this may result in the device falling over, causing injury, damage, or failure.
	See "Safety and Installation Guide" before rack-mounting.
	Do not use this device in places where the temperature is extremely high/low or fluctuates greatly. Failure to follow this may cause system failure. Follow the operating temperature limit for this device.
	Do not use the device in a corrosive gas environments or other places where it may be exposed to chemical substances. Failure to follow this may cause damage or failure.
	Do not use this device near a microwave oven or other equipment that emits strong magnetic fields. Failure to follow this may cause system failure.
	Ensure enough space for access to, and cabling of, the device. For multiple devices ensure adequate service areas, front and back, for both devices. Failure to follow this may cause cable failures.
	Make sure to unplug the power cable when transporting this device. Failure to follow this may cause system fault.
	Do not use any extension card other than the ones supported by this device. Failure to follow this may cause system failure.
	Make sure to connect cables correctly. Improper cabling hinders reliable communications and may cause failure of the device.
	Do not insert or remove the extension card when the device is powered on. Failure to do so may result in damage to the extension card or the device.
	Do not obstruct the device's air vents to avoid higher operating temperatures. Failure to follow this may result in fire.
	Do not install this device near heaters or at places subject to direct sunlight, humidity, and dust. Electric shock or fire may occur.
	Insert the plug into the socket completely. Not completely inserting the plug may result in electric shock, smoke emitting or fire.
	Unplug the power cable by pulling the plug with your hand. Electric shock or fire may occur due to a damaged plug.
	When using this device, do not cover it, or wrap it with anything. Otherwise overheating may result in fire .
	If dust or dirt accumulate on the metal contacts of the power plug or device receptacle, wipe it clean with a dry cloth Continuing to use the device in this condition may result in fire.
	Do not use this device near a radio or a TV set. The device may generate noise in a radio or TV set.
	Risk of explosion if battery is replaced by an incorrect type. Display of used batteries according to the instructions.

Notes on Maintenance

- Customers should not repair this device. In the event of failure, consult with a Fujitsu service engineer or an engineer certified by Fujitsu for maintenance.
- Do not dismantle or modify this device in any manner. This device contains high voltage and high temperature parts that can be dangerous.

Precautions for Use

- As a guideline, the expected life of the device is approximately five years, assuming use at an ambient temperature of 25°C.
- Use of this hardware guide, the device, its firmware, and the management software are the responsibility of the user and is undertaken at their own risk.
- Fujitsu and its partners accept no responsibility for any errors or data loss arising from use of the product. Before using the product, it should be understood that the device is not guaranteed against failure for any more than the original purchase price.
- Fujitsu and its partners do not approve of any use of the firmware provided with the device, or of any authorized firmware upgrades, for any purpose other than installation in the intended device. Modification and disassembly are not permitted under any circumstances. Use of the device or upgrading the device firmware implies acceptance of the End User License Agreement stipulated within the User's Guide.

Eliminating Static Electricity from Twisted Pair Cables (Grounding)

Under certain conditions, twisted pair cables can become charged with static electricity. Connecting a statically charged twisted pair cable to the XG0224 can cause the device or its LAN port to operate falsely or to become damaged.

Use a static removal tool to discharge twisted pair cables to ground prior to connecting them to the XG0224.

Note that a discharged twisted pair cable that has been left unconnected for a long time may become statically charged again.

 **Reference** "2.3.1 Discharging Twisted Pair Cable" (pg.35)

Ensuring Security

If no password is set, any users on the network can configure this device. In that situation, you cannot ensure security against unauthorized use. Therefore we strongly recommend that you set a password.

 **Reference** User's Guide "5.14 Password Information" (pg.252)

Cleaning

If cleaning the device while in service, use a damp soft cloth. Only use water or a mild detergent to dampen the cloth. Avoid moisture entering vents or crevices in the chassis of the device.

Electromagnetic Compatibility (USA)

FCC Part-15 Class A



Warning

FCC WARNING:

Changes or modifications not expressly approved by the party responsible for compliance could void the user's authority to operate the equipment.



This equipment has been tested and found to comply with the limits for a Class A digital device, pursuant to Part 15 of the FCC Rules. These limits are designed to provide reasonable protection against harmful interference when the equipment is operated in a commercial environment. This equipment generates, uses, and can radiate radio frequency energy and, if not installed and used in accordance with the instruction manual, may cause harmful interference to radio communications. Operation of this equipment in a residential area is likely to cause harmful interference in which case the user will be required to correct the interference at his own expense.

Electromagnetic Compatibility (CANADA)

Industry Canada Interference-Causing Equipment Standard ICES-003 Class A.

This Class A digital apparatus complies with Canadian ICES-003.

Cet appareil numérique de la classe A est conforme à la norme NMB-003 du Canada.

Electromagnetic Compatibility (EU)

EN55022(2006) Class A

EN61000-3-2(2000)

EN61000-3-3(1995)+A1(2001)

EN55024(1998) + A1(2001) + A2(2003)



Warning

This product meets the Class A requirements of EN55022. In a domestic environment this product may cause radio interference in which case the user may be required to take adequate measures.

Safety

CAN/CSA C22.2 No. 60950-1, UL60950-1 and EN60950-1

High safety

High Safety Required Applications

The XG0224 is designed, developed and manufactured for general use, including, without limitation, general office use, personal use, household use, and ordinary industrial use, but is not designed, developed and manufactured for use in situations wherein failure of the XG0224 may result in death, personal injury, severe physical damage or other loss (herein after referred to as "High Safety Required"), including, without limitation, nuclear reaction control systems in a nuclear facility, aircraft flight control systems, air traffic control systems, mass transport control systems, medical life support systems, and missile launch control weapons systems.

Do not use the XG0224 for High Safety Required applications without otherwise ensuring the safety level required. Fujitsu and its related companies assume no liability whatsoever for damages arising from use of the XG0224 by the user in High Safety Required applications, and for any claims or compensation for damages by the user or a third party.

Laser Safety

The XG0224 may be installed with optical transceiver modules (SFP and/or SFP+ modules), which emit invisible laser light.

In the USA, these optical modules are certified as Class 1 laser products that conform to the requirements of the Department of Health and Human Services (DHHS) regulation 21 CFR, Subchapter J. This certification is indicated by a label attached to each optical module.

Outside the USA, these SFP+ modules are certified as Class 1 laser products that conform to the requirements of IEC825-1 (1993) and Amendment11 (1996) of EN60825-1 (1994).

Even when cables are not connected, invisible laser light may still be emitted from the optical module's port openings. To avoid possible injury, do not look directly into the optical module's port openings.

Optical transceiver modules intended for use in the XG0224 must be selected from the Optical Transceiver Approved Vendor List (obtainable from the vendor's service department).

Notes on Rack Mounting and Connecting a Powerstrip



Warning

If mounting this device in a rack, assure device operational temperature specification compliance, mechanical stability of the rack, and proper electrical grounding of the device.

This device must only be mounted in a rack by a qualified engineer with the required training and knowledge. Failure to do so may result in property damage, electric shock, or fire.

- Monitor and control the internal and external temperature and humidity of the rack, so that it does not exceed the range of guaranteed operation temperature and humidity.
- The device uses a side inlet and side exhaust ventilation design. Install the device not to obstruct the inlet and exhaust ventilation surfaces.
- Make sure to check the maximum loading capacity of the rack to be used for mounting.
- Check the power supply capability of the installation location.
- When connecting the power cable of the device to a powerstrip within a rack, a large amount of current leakage may occur through the ground line of the powerstrip. Assure a good ground connection exists before connecting power to the device. Assure power sourcing and leakage current carrying capabilities for the power strip are not exceeded. The maximum current leakage for the device is 3.5 mA.

About Fujitsu's Green Products

"Green Products" that have passed Fujitsu's strict environmental assessment standards are earth-friendly and environment-conscious products.



- Main Features
 - Small size/resource saving
 - Power saving function
 - High rate of recycling

This symbol is attached to the Green Products that passed the Green Product Assessment Standard of Fujitsu.

For Fujitsu's environment protection efforts, refer to the following Fujitsu Web site.

URL : <http://www.fujitsu.com/global/about/environment/> "Environment Protection Efforts"

Notes on Use

Before using this device, please read the following.

- Customers are required to store and maintain configuration information for the device, after the configuration is complete.
The configuration information can be used by Fujitsu or Fujitsu's certified support engineer to restore configurations in case of failure.
Unless the configuration information is available, it may cause difficulties and delays for the support engineer to restore the device, Please backup the configuration information on a timely manner and always maintain it up to date.
- This device contains a protection circuit against lightning and electrostatic discharge.
Therefore, some of the functions may not work when lightning or static electricity enters the device.
In such case, the device can be restored to its normal condition by power cycling the device.
If the functions are still not available after power-on, or if the power itself cannot be turned on, the device may have been destroyed due to lightning or electrostatic discharge beyond the threshold of the protection circuit.
In this case, contact Fujitsu or Fujitsu's certified support engineer for further instruction.
- Do not turn the power off or reset the system during a firmware update, or the device cannot be enabled.
- A User's Guide for this product is provided on the accompanied CD-ROM in PDF format.
Adobe Reader is required for viewing the manual.

Chapter 1 Getting Started



This chapter lists the items that should be in the product package, and describes the names and functions of the various components.

1.1	Items in the Package, Descriptions and Functions	18
1.1.1	Parts List	18
1.1.2	Port Side	19
1.1.3	Power Inlet Side	22
1.1.4	Top Surface	23
1.2	Options	24
1.2.1	SFP Modules	24
1.2.2	SFP+ Modules	24
1.2.3	Compact Flash	24
1.2.4	Expansion Card	25

1.1 Items in the Package, Descriptions and Functions

Before proceeding, check all the items described below.

1.1.1 Parts List

Please check that all of the following parts are included in the package.

XG0224

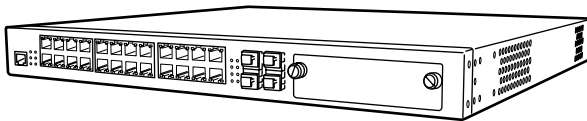

Power Cable

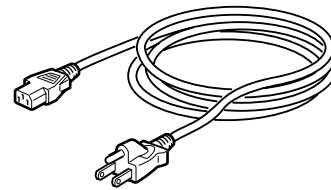

Console Cable

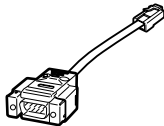

Rack Mounting Brackets (Qty 2)



M3 Countersunk Screws (Qty 8)



CD-ROM

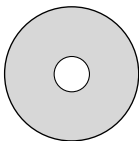

Safety and Installation Guide

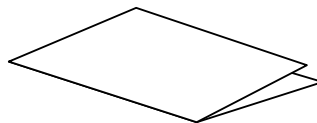

XG0224 Hardware Guide (with Licence Agreement)

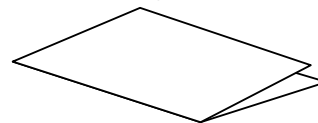

- XG0224 The XG0224 Secure Switch.
- Power Cable Cable to connect the XG0224 to an AC power source.
- Console Cable (RJ45 to Serial Adapter) Straight cable with RJ-45 to D-SUB9 Converter Adapter.
- Rack Mounting Brackets (Qty 2) A metal fitting which attaches to the back side of the rack to fix the switch onto the rack.
- M3 Countersunk Screws (Qty 8) Screws for fastening the switch on to the rack rails.
- CD-ROM Contains the User Guide (in a PDF format). Adobe Reader is required for viewing.
- Safety and Installation Guide This manual describes the safety and installation.
- XG0224 Hardware Guide (with Licence Agreement) This manual describes the hardware of the XG0224.



- RS232C Cable is not included in the product package
- Compact flash is not included in the product package

1.1.2 Port Side

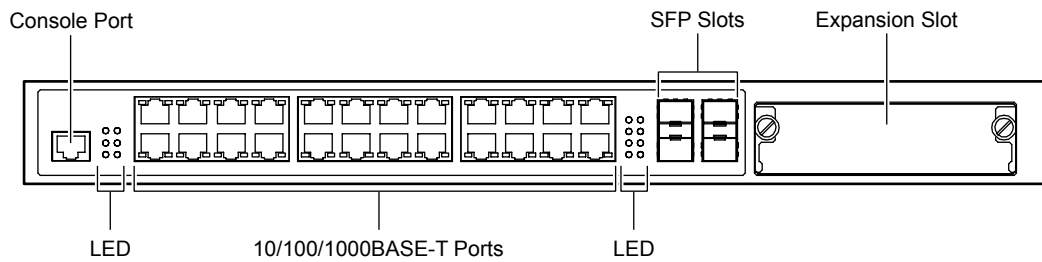

- **Console Port** In order to set and operate the switch, use the console cable and D-SUB9pin cross cable included in this package to connect to the PC.

Caution

The RJ45 Console Port jack is an RS-232 serial interface. Do not plug any other interface types (Ethernet) into this jack. It may cause failure of the device.

 **Reference** User's Guide "1.1.5 Console Port Specifications" (pg.28)

- **10/100/1000BASE-T Ports** 10/100/1000BASE-T Ports. These ports for connecting to Ethernet (10/100/1000BASE-T) Network Equipment.
Please use Category 5 LAN cable (if 1000BASE-T, use Category 5E or above) for cabling.

Precautions

RJ45 ports 21 through 24 are combination ports that are associated with the four SFP ports. Their use is mutually exclusive. If the RJ45 port 21 is cabled then the associated SFP slot cannot be used.

- **SFP Slots** Installing an SFP module in a SFP slot will allow connection to a 100BASE-FX/1000BASE-SX/1000BASE-LX/1000BASE-ZX/1000BASE-BX-D/1000BASE-BX-U optical cable. Its associated RJ45 port can no longer be used.
- **Expansion Slot** This slot is provided for the addition of an optional 10 GbE expansion card.

 **Reference** "1.2.4 Expansion Card" (pg.25)

LED Details

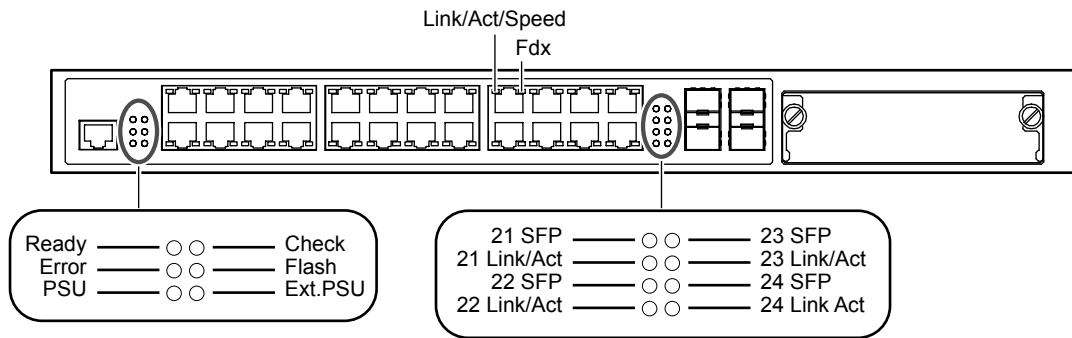

- Ready LED Indicates the operational state of the switch.
- Error LED Indicates a compact flash mount/access error occurred.
- PSU LED Indicates the switch power supply status.
- Check LED Lights orange when there is a problem. In such case, consult with the vendor's service representative immediately.
- Flash LED Indicates the read/write status of the compact flash inserted into the switch.

Precautions

When the Flash LED is lit green, do NOT turn off power or reset the switch. The configuration being read or written may be corrupted.

- Ext.PSU LED Indicates the status of the redundant power supply. Not supported.
- SFP LED Indicates the link up/down status of the SFP module.
- SFP Link/Act LED Indicates the link status and communication speed/status of the SFP module.
- Link/Act/Speed LED Indicates the link status and communication speed/status of the RJ45 port.
- Fdx LED Indicates whether the RJ45 port is operating in half or full duplex mode.

LED Functions / Behaviors

LED Name	State	Status
Ready	Green	Switch has started up correctly
	Green Blinking	Switch is running a Power On Self Test (POST) or running from the backup firmware image (*)
	Off	A problem has occurred
Error	Orange	Indicates a compact flash mount/access error
	Off	If a compact flash is installed, indicates no mount/access error
PSU	Green	PSU is operating correctly
	Orange	A problem occurred with the PSU
	Off	Power is off
Check	Orange	A problem occurred that requires the switch be replaced
	Off	The switch is operating normally
Flash	Green	Compact Flash Card is inserted correctly
	Green Blinking	A compact flash read/write operation is occurring
	Off	Compact Flash Card is not inserted
Ext.PSU	Off	Not supported
SFP	Green	SFP link is established
	Off	SFP link is not established
SFP Link/Act	Green	Established 1000M SFP link
	Green Blinking	1000M SFP data traffic activity
	Orange	Established 100M SFP link
	Orange Blinking	100M SFP data traffic activity
	Off	Link is not established
Link/Act/Speed	Green	Established 1000M link
	Green Blinking	1000M data traffic activity
	Orange	Established 100M or 10M link
	Orange Blinking	100M or 10M data traffic activity
	Off	Link is not established
Fdx	Green	Duplex
	Off	Half Duplex

*) During system POST, the Ready LED blinks green at a 0.5 second interval. When the switch is operating from the backup firmware image, the Ready LED blinks at a 1 second interval.

1.1.3 Power Inlet Side

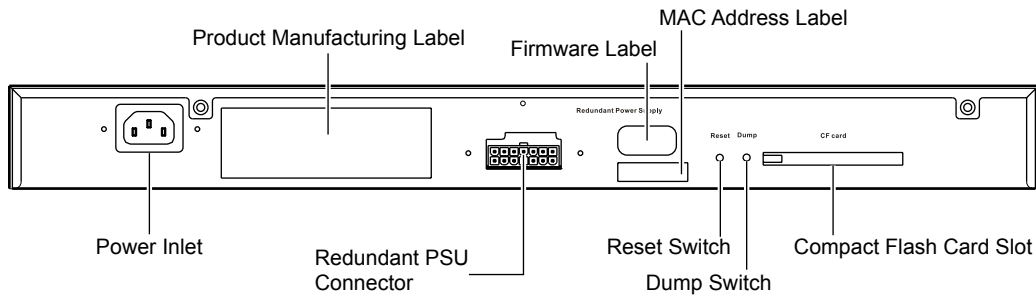

- **Power Inlet** AC power inlet for the power cable provided.
- **Product Manufacturing Label** This indicates the model name, serial number, manufacturing date and Class 1 Laser Product, etc..
- **Redundant PSU Connector** Connector for an external redundant power supply. Not supported.
- **Firmware Label** This indicates the firmware version.
- **MAC Address Label** This indicates the MAC address of the switch.



- **Reset Switch** Press to reboot
- **Dump Switch** Press the dump switch to copy the following switch files to an installed compact flash card.

Information	File Name
Configuration Definition 1	/cf0/config1
Configuration Definition 2	/cf0/config2
Firmware	/cf0/firmware
Error Log	/cf0/eelog

The switch default configuration disables the dump switch. To activate the dump switch use the `dumps witch` command.

- **Compact Flash Card Slot** Insert a compact flash card to load/save configuration files or update firmware.

1.1.4 Top Surface

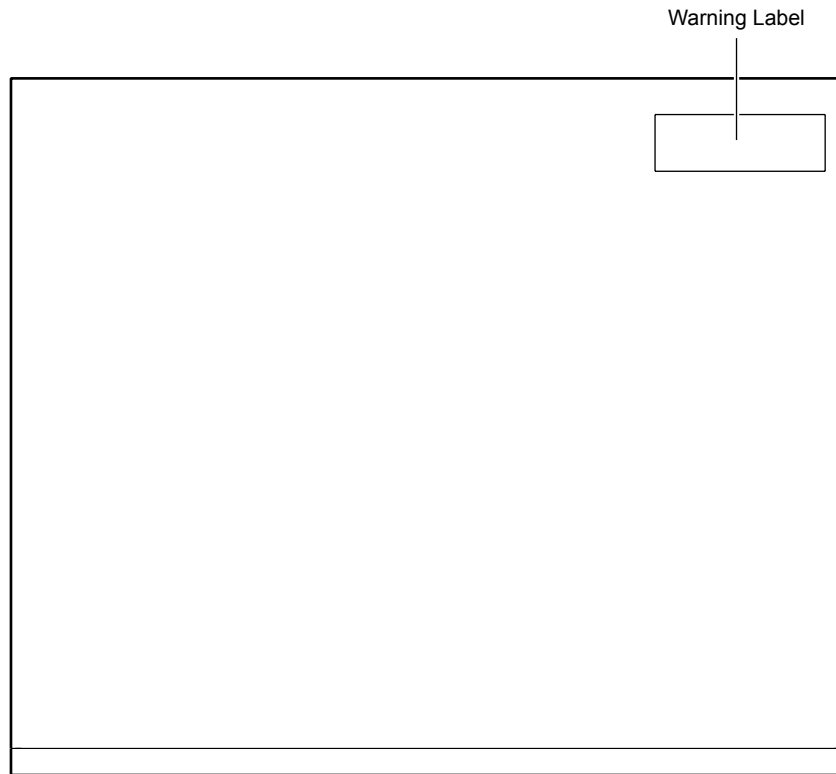

- Warning Label This label describes the safety measures you should take when using this product.

1.2 Options

1.2.1 SFP Modules

SFP modules (100BASE-FX/1000BASE-SX/1000BASE-LX/1000BASE-ZX/1000BASE-BX-D/1000BASE-BX-U) can be used.

Precautions

- Turn the switch power off to install a SFP module.
 - SFP modules can not be installed in the optional SFP+ extension card.
 - 1000BASE-BX-D and 1000BASE-BX-U SFP modules must be used in pairs.
 - RJ45 ports 21 through 24 are 'combination' ports that are associated with the 4 SFP ports. Their use is mutually exclusive. If the RJ45 port 21 is cabled then the associated SFP slot cannot be used.
-

Reference

"2.3.3 Connecting Twisted Pair Cable / SFP Module / SFP+ Module / CX4 Cable" (pg.37)
User's Guide " SFP Module" (pg.24)

1.2.2 SFP+ Modules

SFP+ modules (10GBASE-SR/10GBASE-LR) are intended for use in the optional extension card.

Precautions

- Turn the switch power off to install a SFP+ module.
 - SFP+ modules can not be installed in an SFP slot.
-

Reference

"2.3.3 Connecting Twisted Pair Cable / SFP Module / SFP+ Module / CX4 Cable" (pg.37)
User's Guide " SFP+ Module" (pg.25)

1.2.3 Compact Flash

SANDISK SDCFJ-256-388 256 MB compact flash card is the only part approved for use in the switch compact flash slot. Compact flash cards are installed into the compact flash slot on the power inlet side of the switch.

Reference

"2.3.4 Installing Compact Flash Card" (pg.40)
User's Guide " Compact Flash Card" (pg.26)

1.2.4 Expansion Card

The following describes the available expansion card options.

The optional expansion card is installed in the expansion slot on the port side of the switch. The following details the functions/behaviors of each type of expansion card.

SFP+ Expansion Card

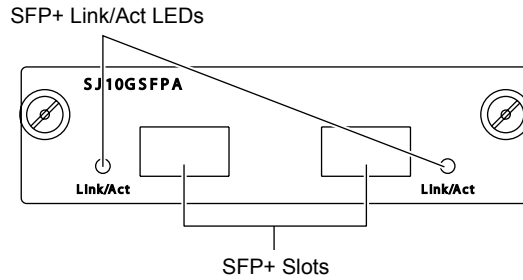

- SFP+ Link/Act LEDs Indicated the link status / communication status of the SFP+ Slots.
- SFP+ Slots Installing an SFP+ module in either SFP+ slot will allow connection to a 10GBASE-SR or 10GBASE-LR optical cable.

LED Display Content

LED Name	State	Status
SFP+ Link/Act	Green	Link is established with SFP+
	Green Blinking	10GBASE SFP+ data traffic activity
	Off	Link is not established

Reference

"2.2.2 Installation of Extension Card" (pg.33)

User's Guide " SFP+ Expansion Card" (pg.26)

CX4 Expansion Card

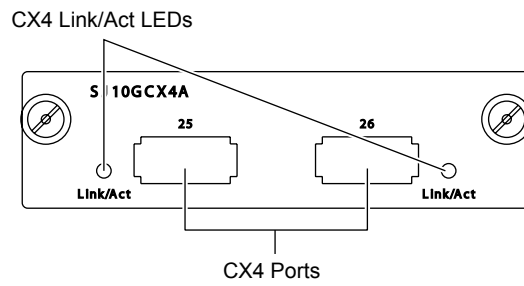

- CX4 Link/Act LEDs Indicates CX4 port link status / communication status.
- CX4 Ports Connect to 10G Ethernet NW equipment using CX4 cable.

LED Display Content

LED Name	State	Status
CX4 Link/Act	Green	Link is established with CX4
	Green Blinking	10G CX4 data traffic activity
	Off	Link is not established

Chapter 2 Installation



This chapter describes how to install the switch and connect it to Console PC.

2.1	Requirements for Installation Environment	28
2.1.1	Installation Requirements	28
2.1.2	Space Requirements	30
2.2	Installation	31
2.2.1	Installation of the Switch	31
2.2.2	Installation of Extension Card	33
2.3	Connecting the Equipment	35
2.3.1	Discharging Twisted Pair Cable	35
2.3.2	Cleaning SFP Module / SFP+ Module / Optical Connector	35
2.3.3	Connecting Twisted Pair Cable / SFP Module / SFP+ Module / CX4 Cable	37
2.3.4	Installing Compact Flash Card	40
2.4	Connecting to a Setup PC	41
2.5	Time Setting	44
2.6	Set up IP address	45

2.1 Requirements for Installation Environment

Before installing the switch, please check the following:

- Make sure that the switch and all the other options shown in this document are available for installation.
- All the cables comply with the specifications of the interface connectors.



Warning

Do not connect cables to interface connectors other than those adaptable to the connector's specifications.



Reference "1.1.1 Parts List" (pg.18)

Install the product under the following environmental conditions

2.1.1 Installation Requirements



Caution

Install the product under the following conditions. Using the product outside the required environment may cause failure of the product.

Temperature and Humidity Requirements

	Temperature (degrees C)	Humidity (%RH)
Operation	0 to 40	15 to 85
Non-operation	0 to 50	8 to 90

Power Requirements

Item	Requirements
Voltage	AC90V-264V
Frequency	50Hz / 60Hz +2%, -4%
Ground	Separate ground wire from air conditioners and building, and D-class grounding with ground resistance of 100 Ω or less.
Electricity	80W
Inrush Current	Maximum30A Ensure installation environment that avoids lowering voltage to power supply equipment at the time of power-on due to the inrush current, although there's no impact from the inrush current in normal use.

Installation Condition

Check List

Check the following items.

Check Item	Check Result
Nothing is put on the switch.	
Vents are not obstructed.	
The switch is not located on the table or not stuck on another switch.	
The switch is not located under direct sunshine, near heating appliance, under high humidity or in a dusty area.	
The switch is not located on unstable places where vibrating, or tilting.	
"About Warning Descriptions" has been thoroughly read.  Reference (pg.10)	

2.1.2 Space Requirements

When installing the switch and providing maintenance, ensure the space below is maintained.

Ensuring the Space for Installation (Maintenance) of the Switch

When installing the switch and providing maintenance, ensure the space below is maintained.

Internal cooling fans of the switch allow the air intake from the left hand side and exhaust at the right hand side.

Ensure the indicated space below and do not put anything which avoids airflow.

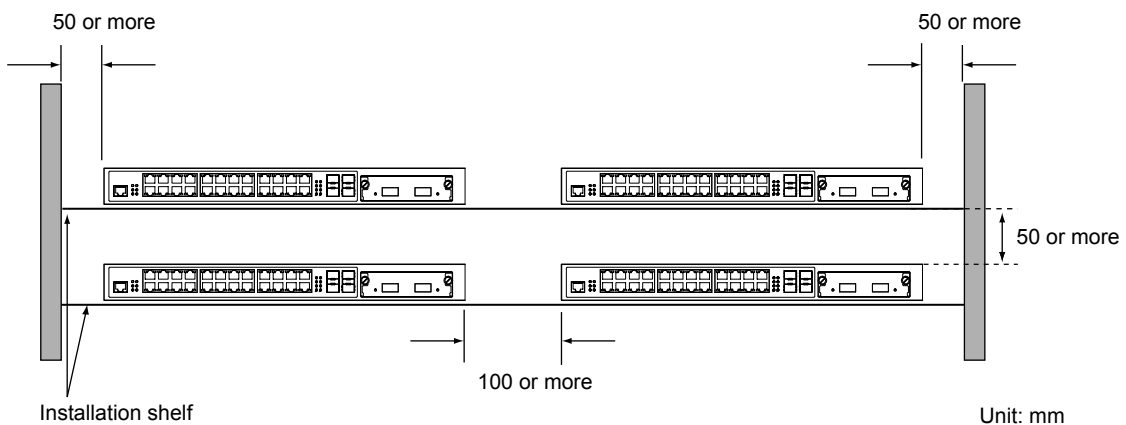
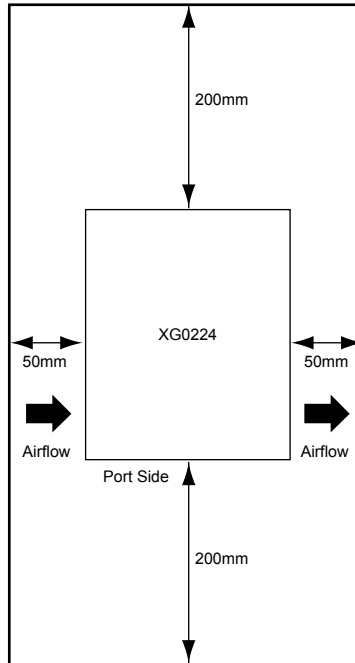

2.2 Installation

This section describes how to install the switch.

2.2.1 Installation of the Switch

The following describes how to install.

Installation on 19" Rack

The switch can be installed and operated in the EIA standard 19" rack.

Prepare the following rack mounting components attached.

- Rack Mounting Brackets (Qty 2)
- M3 Countersunk Screws (Qty 8)

 Reference "1.1.1 Parts List" (pg.18)

Precautions

- Do not put rubber feet on when installing on the rack.
 - Please set the switch (product) to a place near the electrical outlet which the power cable will be connected and secure a space for the power cable to be pulled off easily.
 - When installing the switch in the rack, separately procure screws according to the specifications of the rack.
 - Pay attention to control temperature inside and outside of the rack so that guaranteed operating temperature can be maintained properly for the switch.
 - Reserve certain space for air cooling in accordance with the cooling structure of the switch.
 - Reserve certain space for air cooling in accordance with the cooling structure of the switch.
 - Check if power supply capacity (Rated Current) is sufficient from the power supply equipment such as power strip, service outlet from other devices or rack.
 - When rack mounted devices with multiple power cables are connected to one single service outlet, or multiple rack mounted devices with single power cable are connected to one single service outlet, there's a risk that total ground leakage current may exceed the power specifications. Pay special attention to the ground leakage current.
-

Installation procedure is described below.

1. Place the switch on the flat place.

2. Put rack mounting brackets on the switch using M3 Countersunk Screws (Qty 8).

Two ways below are possible for putting on rack mounting brackets.

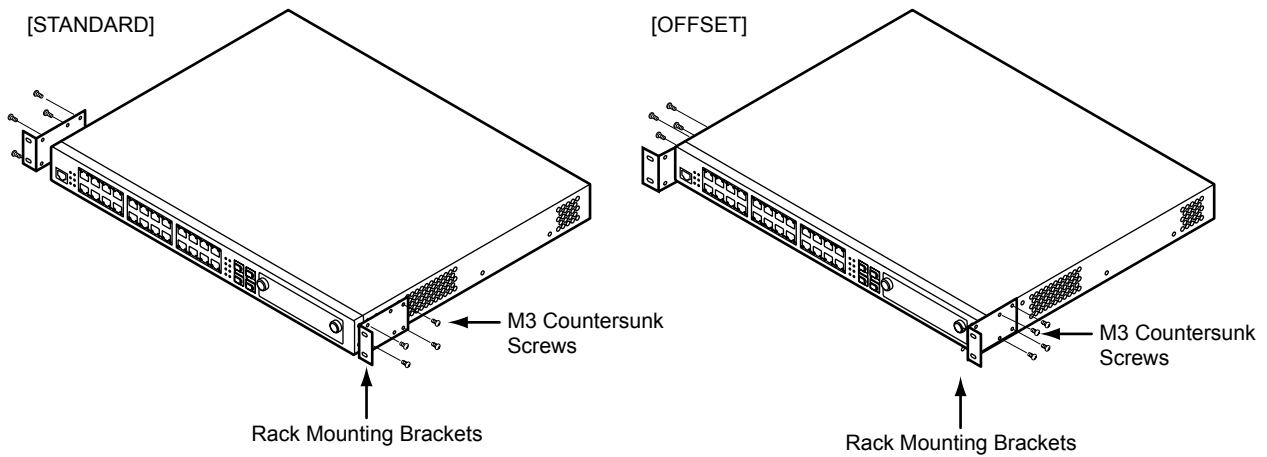

Precautions

When putting on rack mounting brackets, make sure to use special screws included in the 19" rack brackets set. If other screws are used, it may break. Also, make sure to use cross slot screwdriver corresponding to the screw thread.

3. Fix the switch that rack mounting brackets are put at the procedure 2.

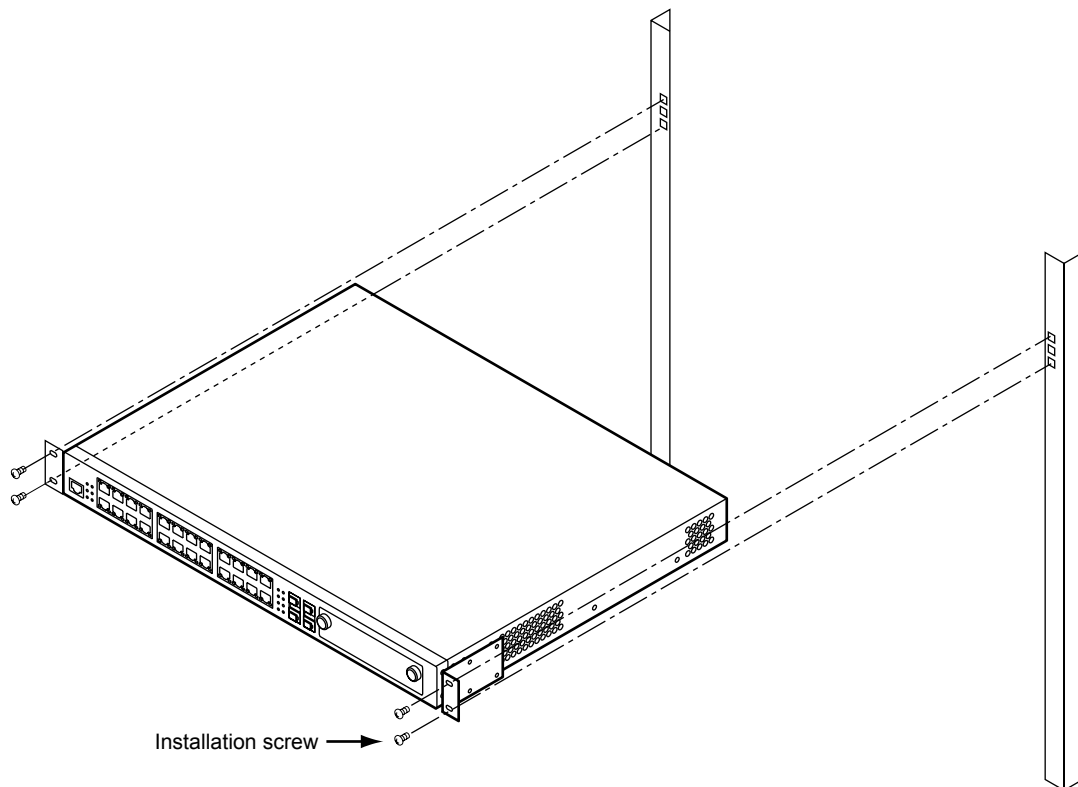

Precautions

Pre-occupied devices in the upper and/or lower row of the rack may interfere with the power cable of the switch from being properly installed. In that case, plug the power cable to the switch before install it in the rack.

2.2.2 Installation of Extension Card

The extension cards can be installed to the switch as optional.

Below describes how to install each extension card.

Installation of SFP+ Extension Card / CX4 Extension Card

Below describes the case of SFP+ Extension card.

1. Turn off the power of the switch.



Caution

Do not install/uninstall the extension cards with the power on. It may cause trouble.

2. Loosen the screws on the extension slot and remove the cover panel.
3. Install the extension card slowly sliding on the guide rail inside the extension slot.

Precautions

Rightly install the extension card on the guide rail. If not, the connection pin may break.

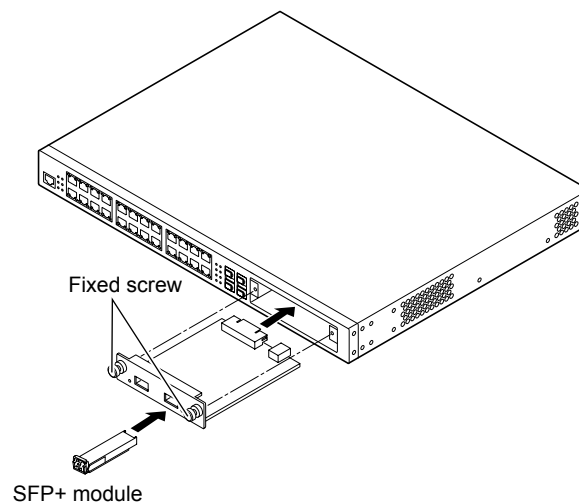

4. Firmly fix the extension card in the switch with the screw.
5. In case of the SFP+ card, plug in the SFP+ module.

Removing SFP+ Extension Card / CX4 Extension Card

1. Turn off the power of the switch.



Caution

If the extension card is removed when the power is on, the Check LED will light up and the switch will go into trouble state.

2. Loosen the screws on the extension slot and remove the extension card.
3. Put the cover panel on the extension slot, and fix it on the switch with the screws.

Precautions

When the switch is operated without the extension card, make sure to put the cover panel on the switch.

2.3 Connecting the Equipment

We recommend discharging static electricity of twisted pair cable before connecting it to the switch.

Also see below for how to install the compact flash card.

2.3.1 Discharging Twisted Pair Cable

Discharge static electricity of the twisted pair cable through the ground wire cable (ground wire for power supply, buildings, etc.) using static electricity removal tool, before connecting twisted pair cable to the switch.

Precautions

- Unplug both ends of the twisted pair cable from equipments (HUB, router, and workstation) during discharging operation.
- Do not use ground wire of electronic devices. Use grounded cable for power supply or buildings.
- Do not short circuit with AC power supply when using ground wire for power suppl.

2.3.2 Cleaning SFP Module / SFP+ Module / Optical Connector

When invisible small dust is adhered to SFP module / SFP+ module / optical connector, optical signal will be shut or space caused by dust will impede transmission of optical signal.

Therefore, clean up SFP module / SFP+ module / optical connector before connection.

Cleaning of SFP Module / SFP+ Module

1. Blow dust away with cleanly dry air or nitrogen.
Check end face, and conduct operation below if dust is left.
2. Lightly dampen a cleaning stick (1.25mm across, for LC/MU) with isopropyl alcohol. After wiping off dust, slowly and carefully wipe off alcohol with a new and dry cleaning stick.
3. Insert a cleaning stick to the optical connector insertion part of SFP module / SFP+ module, and slowly wheel it.

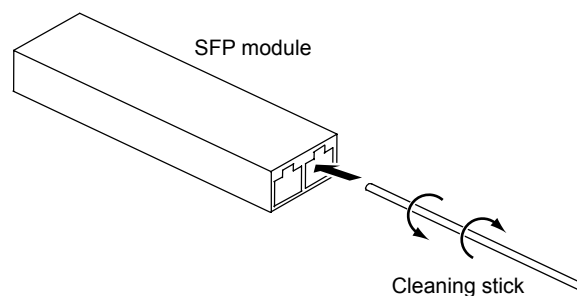

4. Insert and slowly wheel a new cleaning stick, and dry the SFP module.
5. Check if the dust is removed with 200-fold magnification fiber scope.

Cleaning of Optical Connector

1. Remove the connector guard cap of optical fiber part, and check the connector end face.
If the end face is not clean, clean it with a reel type fiber cleaner.
2. Push thumb holder of a fiber cleaner and open a cap of the fiber cleaner.
3. When a cap slides and a new cleaning tape comes out, lightly apply the end face to a cleaning tape.
4. Apply the end face of the connector and rotate it (quarter turn four times).
5. Apply the end face to the cleaning tape, and move it to forward direction of a fiber cleaner.



Caution

Do not friction the end face to the cleaning tape. It will cause micro dust or scratch.

6. Take thumb holder off, and close a cap of a fiber cleaner.
7. Check the end face and continue cleaning if necessary.

Removal of Micro Dust

Remove micro dust on the optical fiber part following the method below if necessary.

1. Wipe the optical fiber part with ethanol or cleaning fluid.
2. Softly and slowly wipe the optical fiber part with cleaning fabric.
3. Wipe with a new cleaning stick in the same fashion, and dry the optical connector.



Caution

- **Do not use fluid such as bleach because it will damage optical coupling.**
 - **Use ionizer when cleaning in order to avoid the ESD damage to SFP module / SFP+ module.**
 - **SFP module cannot be washed with water. Do not use or clean SFP module / SFP+ module in a wet space such as bathroom or kitchen.**
 - **Carefully treat SFP module / SFP+ module as it sometimes becomes very hot.**
-

Precautions

- Do not use alcohol, spray, and cotton swab for cleaning of optical connector other than special optical connector cleaner because dust on the end face of the optical connector plug may not be completely wiped off and more dust may adhere.
 - Immediately connect optical connector to the switch after cleaning. Dust will adhere when the optical connector is left unconnected.
 - Keep the connector guard cap fixed before using SFP module / SFP+ module in order to avoid contamination.
 - When SFP module / SFP+ module is contaminated, check end face and clean only if necessary.
 - If a lot of fluid is used, it will possibly be accumulated or leak out because SFP module / SFP+ module is not hermetically closed.
-

2.3.3 Connecting Twisted Pair Cable / SFP Module / SFP+ Module / CX4 Cable

The following describes how to connect twisted pair cable, SFP module, SFP+ module, and CX4 cable.

Use straight cable when connecting with routers and terminals. Use crossing cable in case of cascading connection with other switching HUBs with transmission mode at fixed setting other than auto negotiation.

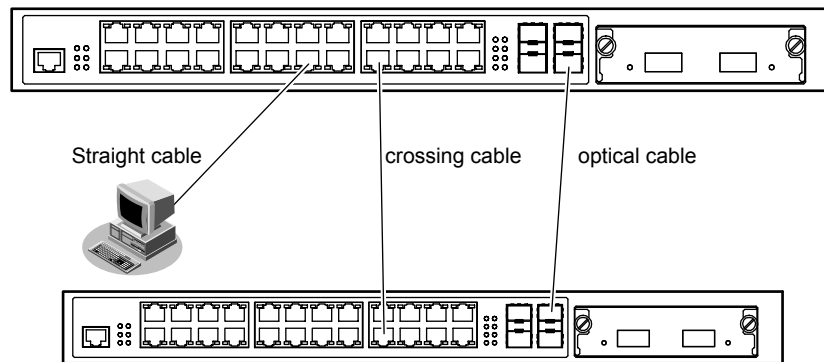

Port of the switch is set auto negotiation enable by default.

(However, SFP+ Slots and CX4 port only support 10Gbps full duplex mode fixed setting.)

Ports automatically apply to the maximum speed that plugged equipment supports by the auto negotiation function.

- 10/100/1000BASE-T port : Up to maximum 1000Mbps full duplex mode
- SFP slot : Up to maximum 1000Mbps full duplex mode

Connecting Twisted Pair Cable

Insert twisted pair cable to 10/100/1000BASE-T port until it clicks.

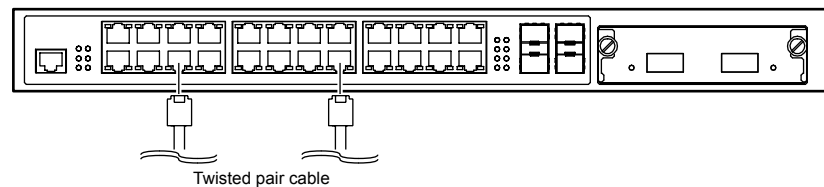

Precautions

- In case of 1000BASE-T, usable twisted pair cables are unshielded twisted pair cable (UTP) over category 5E and shielded twisted pair cable (STP).
- RJ45 ports 21 through 24 are combination ports that are associated with the four SFP ports. Their use is mutually exclusive. If the RJ45 port 21 is cabled then the associated SFP slot cannot be used.
- Discharge twisted pair cable before connecting as twisted pair cable may be charged static electricity. Refer "2.3.1 Discharging Twisted Pair Cable" (pg.35) for discharging method.

Connecting SFP Module

Firmly install SFP module to SFP slot and lock module to the switch.

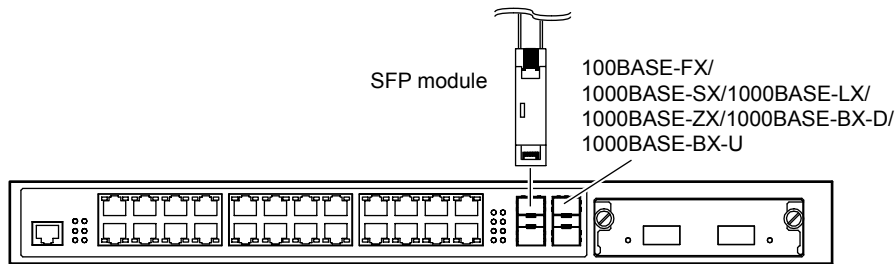

Caution

Make sure to turn off the power when inserting and pulling out the SFP module.

Precautions

- Port 21 to 24 of 10/100/1000 BASE-T port and the same number ports of SFP port cannot be used at the same time. Connect only ports that will be used with twist pair cable or optical cable with SFP module.
- Make sure use 1000BASE-BX-D SFP module and 1000BASE-BX-U SFP modules in pairs.
- Safely keep a guard cap of SFP module.
- Make sure to clean the end face of SFP module / optical cable before connecting optical connector because the end face may possibly be contaminated. Please refer to "2.3.2 Cleaning SFP Module / SFP+ Module / Optical Connector" (pg.35) for cleaning.
- Do not directly touch the contact part of SFP module by hands. Use wristbands when touching SFP module.
- Connecting part to the optical cable of SFP module is the laser opening.

There are two types of SFP modules, veil latch type and standard latch type.

Below describes how to connect these modules.

- Veil Latch Type

Insert SFP module to the SFP slot with a lever locked, and lock the module and the switch.

Connect optical cable (connector shape: LC) after inserting SFP module to the SFP slot.

When removing SFP module, unlock the lever, module and the switch, and remove the module after unplug the optical fiber.

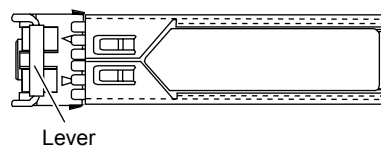

- Standard Latch Type

Insert SFP module to the SFP slot, and lock the module and the switch.

Connect optical cable (connector shape: LC) after inserting SFP module to the SFP slot.

When removing SFP module, remove the module after pressing a tab to unlock the module and the switch.

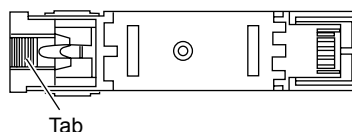

Connecting SFP+ Module

Firmly install SFP+ module to SFP+ slot and lock module to the switch.

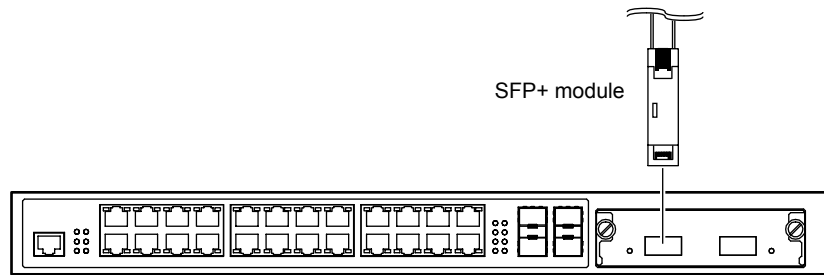

Caution

Make sure to turn off the power when inserting and pulling out the SFP+ module.

Precautions

- Safely keep a guard cap of SFP+ module.
- Make sure to clean the end face of SFP+ module / optical cable before connecting optical connector because the end face may possibly be contaminated. Please refer to "2.3.2 Cleaning SFP Module / SFP+ Module / Optical Connector" (pg.35) for cleaning.
- Do not directly touch the contact part of SFP+ module by hands. Use wristbands when touching SFP+ module.
- Connecting part to the optical cable of SFP+ module is the laser opening.

Insert SFP+ module to the SFP+ slot with a lever locked, and lock the module and the switch.

Connect optical cable (connector shape: DLC) after inserting SFP+ module to the SFP+ slot.

When removing SFP+ module, unlock the lever, module and the switch, and remove the module after unplug the optical fiber.

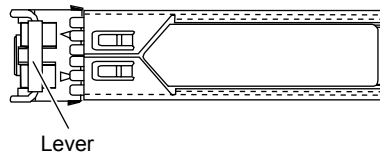

Precautions

Cable length will be as below based on the specification of the optical fiber cable

Type	Core/Cladding Diameter	Minimum Transimission Band	Cable Length (m)
MMF	62.5/125 μ m	160MHz/km	26
		200MHz/km	33
	50/125 μ m	400MHz/km	66
		500MHz/km	82
		2000MHz/km	300

Use the appropriate cable according to the installation place.

Connecting CX4 Cable

Firmly install CX4 cable to CX4 expansion card port and lock the cable.

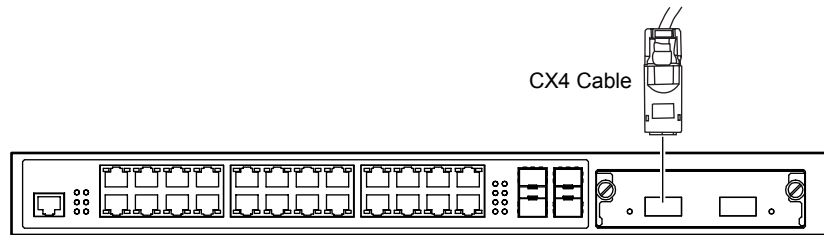

Precautions

- Make sure to firmly insert the cable straight from behind.
- When bending the cable, make sure that the diameter of the bent cable does not become smaller than 10cm.
- When pulling out the cable, make sure to pull the pull tab of the cable connector. The cable may disconnect if you pull the cable itself.

2.3.4 Installing Compact Flash Card

Compact Flash Card shall be installed in the power inlet side of the switch.

⚠ Caution

- **Do NOT unplug during access. It may result in crashing setting data.**
- **Please refer to the following instructions, for installing the compact flash card. When installed in a wrong direction, it may cause trouble to the switch.**

Precautions

Make sure to use the specified product (SANDISK SDCFJ-256-388 256 MB).

1. Firmly insert and lock the Compact Flash Card to Compact Flash Card Slot on the power inlet side of the switch.

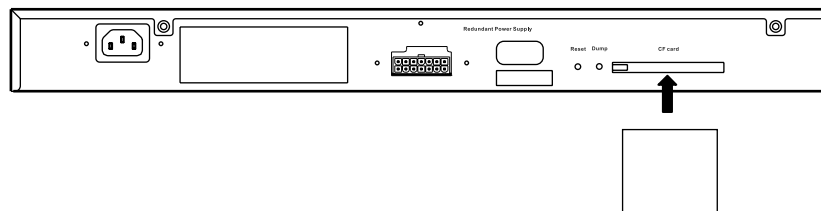

Precautions

Please be careful of the direction when inserting Compact Flash Card.

2.4 Connecting to a Setup PC

This is to connect a set up PC to the console port of the switch using RS232C cable.

Necessary Hardware / Software

Please prepare the hardware & software specified below to connect to the switch.

- Personal Computer
1 unit of personal computer for setting up configuration is required.
- RS232C cable(Cross, D-SUB9 pin)
RS232C cable is required to connect the set up PC to the switch.
Also, please use the console cable which is included in this product for connection.

 **Reference** User's Guide "1.1.5 Console Port Specifications" (pg.28)

- Communication Software
Terminal software is required.

Connect RS232C Cable

1. Confirm power of both the PC and the switch are off.
2. Connect the RS232C cable and the console cable which is included in this product, and firmly fix them with the screw.

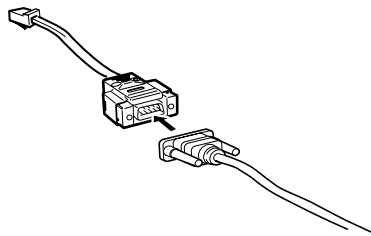

3. Plug in the RJ45 plug of the console cable to the console port of the switch.

Turn on the Power

Caution

- Please use the power cable included in this product. Also, please do NOT use this power cable on other products.
- If the power outlet does not match with the power cable plug, please use the change plug adapter.
As a safety measure to prevent electrical shocks, please make sure to connect the ground wire of the change plug.

Precautions

Please set the switch (product) to a place near the electrical outlet which the power cable will be connected and secure a space for the power cable to be pulled off easily.

1. Connect the power cable to the electrical outlet.

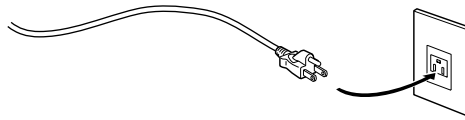

2. Plug in the power cable to the power connector of switch power inlet side.
Power will turn on.

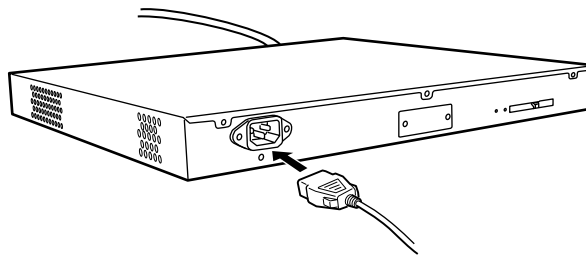

3. The PSU lamp on the front panel of the device lights up in green.

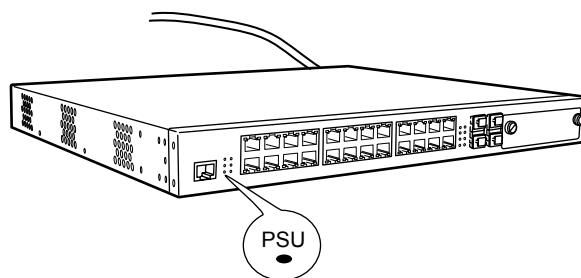

Prepare a Setup PC

Log on using the terminal software.

1. Start up the terminal software by using the set up PC.
2. Set the setting conditions to the following;

Item	Setting
Start Bit	1
Data Bit	8
Parity Bit	n/a
Stop Bit	1
Synchronous System	Asynchronous Communication System (Start-Stop Communication System)
Communication Speed	9600
Flow Control	None
Number of digits on screen	80 (If other than 80 digits, set it through terminal command)
Number of rows on screen	24

Please refer to the terminal software manual for instructions on setting conditions.

3. Press [Return] key or [Enter] key.

Precautions

The following message may appear When pressing the [Return] key or [Enter] key. In such case, the switch is processing another job, and waiting for such process to finish. Please wait for a moment until it finishes such process. Waiting for completion of the other operation...

4. Confirm "Login :." on screen.
5. Key in "admin" and press [Return] key or [Enter] key.
6. Confirm "Password:." on screen.
7. Key in password, then press the [Return] key or [Enter] key.
 Since password is not set at the initial state, simply press [Return] key or [Enter] key without keying in the password.
 If the password is already set, key in the password. Then press [Return] key or [Enter] key.
8. Confirm "#" is shown on screen
 If the key in the wrong password, "invalid password." will be displayed, then the "Login :." will be displayed again. Please repeat your process from item 5.

2.5 Time Setting

Make sure to set up the time before you do other settings of the switch. The time is not set at the initial timing of purchase. Please refer below command for setting up time manually using console or telnet.

● Command

When setting time and date to be "Jan 1, 2009 12:30:00am" type in command	
# date 2009/01/01.12:30:00	
XG0224# configure	Switch to Configuration mode.
XG0224(config)# time zone -0500	When setting time zone to be "-0500".
XG0224(config)# commit	Apply the configuration.
XG0224(config)# save	Save the configuration.
XG0224(config)# exit	Switch to Operation mode.
XG0224# date 2009/01/01.12:30:00	Set time and date to be "Jan 1, 2009 12:30:00am".

2.6 Set up IP address

Please set the IP address at times when it is required.

Eg. When setting the switch through www browser or installing a firmware from the initial state of the purchase.

The following commands show how to set up the IP address (ex. 192.168.1.1).

● Command

```
XG0224# configure
XG0224(config)# lan 0 ip address 192.168.1.1/24 3
XG0224(config)# lan 0 vlan 1
XG0224(config)# commit
XG0224(config)# exit
XG0224#
```

Precautions

- The IP address is not set at the initial state of the purchase. Please set the IP address through console.
- When logging in by console, you will not be able to log in from the www browser. Please make sure to log off from the console after setting up the IP address.

Index

Number

10/100/1000BASE-T Port 19

C

CD-ROM 18

Check LED 20

Communication Software 41

Compact Flash 24

Compact Flash Card 40

Compact Flash Card Slot
..... 22

Connecting 35

Console Cable 18

Console Port 19

CX4 Expansion Card 26

D

Dump Switch 22

E

Error LED 20

Expansion Card 25

Expansion Slot 19

Ext.PSU LED 20

F

Fdx LED 20

Firmware Label 22

Flash LED 20

H

Hardware 41

I

Installation 31

Installation Condition 29

Installation on 19" Rack 31

Installation Requirements 28

Items in the Package 18

L

Link/Act/Speed LED 20

M

M3 Countersunk Screws 18

MAC Address Label 22

O

Options 24

P

Port Side 19

Power Cable 18

Power Inlet 22

Power Inlet Side 22

Power Requirements 28

Prepare a Setup PC 43

Product Manufacturing Label 22

PSU LED 20

R

Rack Mounting Brackets 18

Ready LED 20

Redundant PSU Connector 22

Reset Switch 22

RS232C cable 41

S

Safety and Installation Guide 18

SFP LED 20

SFP Link/Act LED 20

SFP Modules 24

SFP Slots 19

SFP+ Expansion Card 25

SFP+ Modules 24

Software 41

Space for Installation 30

T

Temperature and Humidity Requirements 28

Terminal software 43

Top Surface 23

Turn on the Power 42

Twisted Pair Cable 35

W

Warning Label 23

XG0224 Hardware Guide

TA41001-6348

Issued on November, 2009

Issued by FUJITSU LIMITED

-
- The contents may be revised without prior notice.
 - Fujitsu assumes no liability for damages to third party copyrights or other rights arising from the use of any information in this manual.
 - No part of this manual may be reproduced in any form without the prior written permission of Fujitsu.
 - EC declaration of conformity and the technical documentation are kept at the following
Fujitsu Europe Limited
Hayes Park Central, Hayes End Road, Hayes, Middlesex,
UB4 8FE, England, UK
+44-20-8573-4444

Free Manuals Download Website

<http://myh66.com>

<http://usermanuals.us>

<http://www.somanuals.com>

<http://www.4manuals.cc>

<http://www.manual-lib.com>

<http://www.404manual.com>

<http://www.luxmanual.com>

<http://aubethermostatmanual.com>

Golf course search by state

<http://golfingnear.com>

Email search by domain

<http://emailbydomain.com>

Auto manuals search

<http://auto.somanuals.com>

TV manuals search

<http://tv.somanuals.com>