

Fujitsu PC Corporation has made every effort to ensure the accuracy and completeness of this document. Because ongoing development efforts are made to continually improve the capabilities of our products, however, the data contained herein represents Fujitsu design objectives and is provided for comparative purposes; actual results may vary based on a variety of factors. This product data does not constitute a warranty. Specifications are subject to change without knowledge.

Fujitsu and the Fujitsu logo are registered trademarks of Fujitsu Limited. Stylistic is a registered trademark of Fujitsu PC Corporation.

IBM, IBM PC AT, and IBM PS/2 are registered trademarks of IBM Corporation.

Kensington and MicroSaver are registered trademarks of the Kensington Technology Group.

PCMCIA and CardBus are registered trademarks of the Personal Computer Memory Card International Association.

Intel and Pentium are registered trademarks of Intel Corporation.

Microsoft and Windows are registered trademarks of Microsoft Corporation.

All other trademarks mentioned herein are the property of their respective owners.

Copyright 2003 - Fujitsu PC Corporation. All rights reserved. No part of this publication may be copied, reproduced, or translated, without the prior written consent of Fujitsu PC Corporation. No part of this publication may be stored or transmitted in any electronic form without the prior consent of Fujitsu PC Corporation. Stylistic LT800P User's Guide - FPC58-0847-01



**DECLARATION OF CONFORMITY  
according to FCC Part 15**

Responsible Party Name: **Fujitsu PC Corporation**  
Address: **5200 Patrick Henry Drive, Santa Clara, CA 95054**  
Telephone: **408-982-9500**  
Declares that product: **Models: Stylistic LT860P, Stylistic LT867P**  
**Complies with part 15 of the FCC Rules**

This device complies with Part 15 of the FCC rules. Operation is subject to the following two conditions: (1) This device may not cause harmful interference, and (2) This device must accept any interference received, including interference that may cause undesired operation.



# Table of Contents

## Preface

About This Guide .....	5
Fujitsu Contact Information .....	6
Warranty Information .....	6

## Getting Started

In-box Items .....	9
Optional Accessories .....	10
Stylistic LT800P Tablet Features .....	11
Status Display .....	15
Connectors and Peripheral Interfaces .....	19

## Using the Stylistic LT800P Tablet

System States .....	25
Powering Up the Tablet .....	27
Shutting Down the System .....	27
Suspending System Operation .....	27
Resuming System Operation .....	30
Using Hotpads .....	31
Using the Pen .....	34
Using Hovering Mode .....	36
Charging the Battery Pack .....	36
Removing and Installing the Battery Pack .....	37
Tips for Conserving Battery Power .....	39
Modem Connection .....	40
PC Card Slot .....	40
LAN Port (RJ-45) .....	40
Changing the BIOS Settings .....	40

## Care and Maintenance

Protecting the Display Screen . . . . .	45
Storing the Stylistic LT800P Tablet . . . . .	46
Avoiding Overheating . . . . .	46

## Troubleshooting

System Will Not Resume Operation . . . . .	49
Display Screen Is Blank or Difficult to Read . . . . .	49
Infrared Data Transfer Is Not Working . . . . .	49
Cursor Is Not Tracking Pen . . . . .	50
Tablet Is Not Responding to the Pen . . . . .	50
Audio Volume Too Low . . . . .	50
Configuring Peripherals Interfaces . . . . .	50

## Hardware Specifications

Stylistic LT800P Tablet Specifications . . . . .	53
--	----

## Using the Integrated Wireless LAN

FCC Regulatory Information . . . . .	67
Before Using This Device . . . . .	69
Connecting Windows 2000 Systems . . . . .	71
Network Connection: Windows 2000 . . . . .	74
Connecting Windows XP Systems . . . . .	81
Troubleshooting . . . . .	88
About IP Addresses . . . . .	94
Specifications . . . . .	95

## Index

Index . . . . .	97
-----------------	----

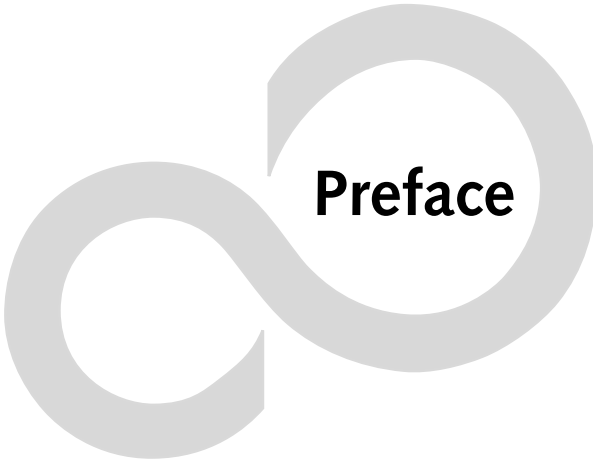



# Preface

## About This Guide

The Stylistic® LT800P Series tablet is a high-performance, pen-based computer that has been designed to support Microsoft® Windows® XP Professional or Windows 2000.

This manual explains how to operate your tablet's hardware and built-in system software.

The Stylistic LT800P tablet is a completely self-contained unit with an active-matrix (TFT) color LCD display and a resistive digitizer. It has a powerful interface that enables it to support a variety of optional features.

## Conventions Used in the Guide

Keyboard keys appear in brackets.

Example: [Fn], [F1], [ESC], [ENTER] and [CTRL].

Pages with additional information about a specific topic are cross-referenced within the text. Example: (See page xx.)

On screen buttons or menu items appear in bold Example: Click **OK** to restart your tablet.

DOS commands you enter appear in Courier type.

Example: Shut down the computer?



The **Information** icon highlights information that will enhance your understanding of the subject material.



The **Caution** icon highlights information that is important for the safe operation of your computer, or to the integrity of your files. Please read all caution information carefully.



The **Warning** icon highlights information that can be hazardous to either you, your tablet or your files. Please read all warning information carefully.

---

## Fujitsu Contact Information

### Service and Support

You can contact Fujitsu Service and Support in the following ways:

- Toll free: 1-800-8Fujitsu (1-800-838-5487)
- Fax: 1-901-259-5700
- E-mail: [8fujitsu@fujitsupc.com](mailto:8fujitsu@fujitsupc.com)
- Web site: <http://www.fujitsupc.com>

Before you place the call, you should have the following information ready so the customer support representative can provide you with the fastest possible solution:

- Product name
- Product configuration number
- Product serial number
- Purchase date
- Conditions under which the problem occurred
- Any error messages that have occurred
- Hardware configuration
- Type of device connected, if any

### Fujitsu Online

You can go directly to the online Fujitsu product catalog for your tablet by going to the Fujitsu Web site at: <http://www.fujitsupc.com>



You must have an active internet connection to use the online URL links.

---

## Limited Warranty Information

Your Stylistic LT800P tablet is backed by a standard three-year International Limited Warranty. Check the service kit that came with your system for Limited Warranty terms and conditions.





# 1 Getting Started



# Getting to Know Your Tablet

The Stylistic LT800P tablet is a high-performance, pen-based computer that is designed to work with Microsoft Windows 2000 or Windows XP Professional. This chapter provides an overview of the Stylistic LT800P tablet and its features.

## In-box Items

The following items are included with the Stylistic LT800P tablet:

- Stylistic LT800P tablet
- Stylistic LT800P pen
- Stylistic LT800P battery pack
- AC adapter (with country-specific power cord)
- Screen protectors (quantity: 2)
- Certificate of Authenticity for operating system software
- Stylistic LT800P Limited Warranty Card

## Optional Accessories

The following optional accessories can be used with the Stylistic LT800P tablet. Refer to the instructions provided with these accessories for details on their use.

Peripheral/Accessory	Fujitsu Part Number
Stylistic LT800P mini-dock	FPCPR25
Stylistic LT800P portfolio case	FMWCC45
Stylistic LT Series slipcase	FPCCC14
External USB floppy disk drive	FPCFDD12
External CD-ROM Drive	FPCCD19
Mobile USB keyboard	FMWKB5A
Infrared keyboard	FMWKB4A
Wireless Mouse	FPCMO07
Auto adapter	FPCAA02
VGA Out Adapter	FMW43VA01
Serial Adapter	FMW43SA01
Folding Desk Stand	FMWDS4
AC adapter	FPCAC23
Stylistic LT Series battery pack (spare, 6-cell)	FPCBP48
Stylistic LT Series external battery charger	FMW51BC2
Screen protectors (package of 12)	FPCSP01
Stylistic pens (package of 5)	FMW29PN1

## Stylish LT800P Tablet Features

Features and controls that you use to operate the Stylish LT800P tablet are described briefly below and illustrated in Figures 1-1 and 1-2. Details on using these features and controls are provided later in this manual.

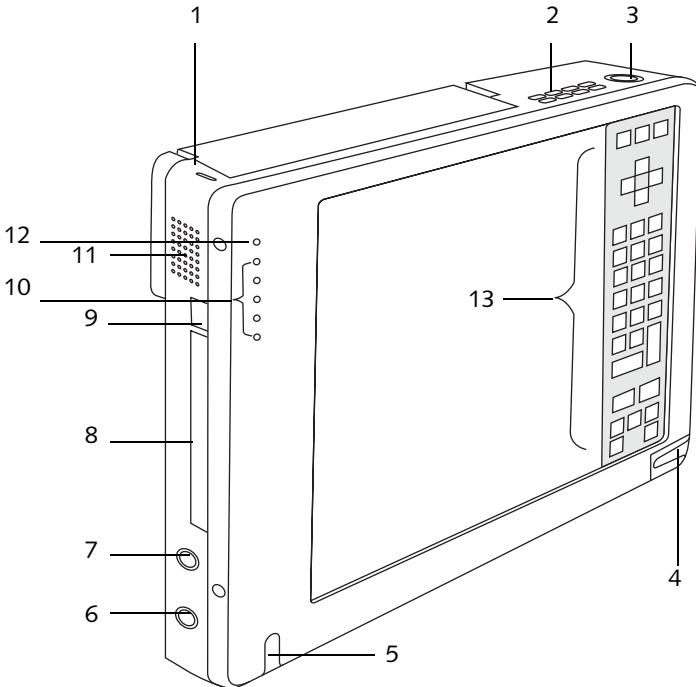

1	Kensington lock slot	8	PC Card slot
2	Air flow vents	9	PC Card Eject button
3	Suspend/Resume/Power button	10	System status LEDs
4	Pen holder	11	Speaker
5	Infrared keyboard port	12	Microphone
6	Microphone jack	13	Hotpad area
7	Headphone jack		

*Figure 1-1 Stylish LT800P Tablet Features (Front View)*

## Front / Top / Left Features:

- **Infrared keyboard port:** The infrared port wraps around the front and bottom left of the display, and is used for communicating with a proprietary infrared keyboard.<sup>†</sup>
- **System status LEDs:** Indicate the operational status of the tablet, including hard disk drive, the charge level of the battery, and the status of the hovering mode.
- **Microphone:** Allows you to record voice memos.
- **Hotpad:** This contains a numeric keypad along with several keys that allow you to change settings for the display brightness and speaker volume, and to allow emulation of a right mouse button. The hotpad also lets you select hovering mode, external monitor mode, and numlock mode by tapping with the pen.
- **Pen:** The main pointing device that you use to execute programs and enter data. A pen holder is built into the tablet to store the pen when not in use.
- **PC Card Slot:** Allows you to install PC Cards in the system.<sup>†</sup>
- **PC Card eject button:** Allows you to eject a PC Card from the PC Card slot.
- **Kensington™ lock slot:** Allows you to attach a Kensington MicroSaver™ compatible security cable.<sup>†</sup>
- **Speaker:** Allows you to play back audio files without external hardware.
- **Headphone Jack:** Allows you to connect a set of headphones.
- **Microphone Jack:** Allows you to connect an external microphone.
- **Suspend/Resume/Power button:** Allows you to suspend and resume tablet operation in order to optimize battery life. It also acts as a power on/off and hibernate/wake button.
- **Air flow vents:** Provides secondary cooling for processor. (These vents should not be obstructed.)

<sup>†</sup> These peripherals and accessories are sold separately.

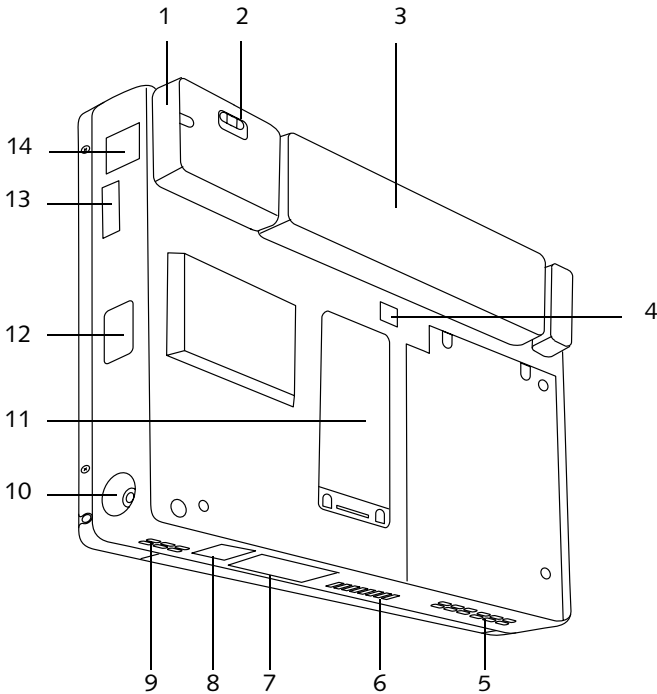

1	Wireless LAN module cover	8	LAN jack (RJ-45)
2	Wireless LAN On/Off switch	9	Air flow vents
3	Battery Pack	10	DC input connector
4	Battery Release Switch	11	Memory cover
5	Air flow vents	12	Infrared port
6	Charging contacts	13	USB port
7	Mini-dock interface (under cover)	14	Modem jack

Figure 1-2 Stylistic LT800P Tablet Features (Rear View)

## Rear / Bottom / Right Features:

- **Wireless LAN module cover:** This is an integral part of the back cover, and provides protection for the optional wireless LAN radio solution.<sup>†</sup>
- **Wireless LAN On/Off switch:** For systems with a wireless device installed, this switch turns the device on and off. You should switch the device off when it is not in use in order to maximize battery life.
- **Removable battery pack:** Can be removed and charged in an optional external charger.<sup>†</sup>
- **Battery release switch:** Used to release the removable battery pack.
- **Air flow vents:** Provide secondary cooling for processor. (Do not obstruct the vents.)
- **Charging contacts:** Allows you to charge the battery pack and supply power to the Stylistic LT800P in an optional mini-dock.<sup>†</sup>
- **Mini-dock interface:** Allows you to install the Stylistic LT800P in an optional mini-dock<sup>†</sup> for enhanced connectivity.
- **LAN jack:** Allows you to connect a standard RJ-45 connector to the tablet's internal local area network (LAN) module.
- **DC input connector:** Allows you to connect the AC adapter or auto/airline adapter.<sup>†</sup>
- **Memory cover:** Removable cover over the RAM chips.
- **Infrared I/O port:** Provides an infrared interface for communication with devices compliant with IrDA Standard Revision 1.1.
- **Modem jack:** Allows you to connect a standard RJ-11 connector to the tablet's internal 56 Kbps modem.
- **USB port:** Allows you to connect Universal Serial Bus-compliant devices (version 1.1) to the tablet.<sup>†</sup>

<sup>†</sup> These peripherals and accessories are sold separately.



## Status Display

Icons appear in the Status display indicating the status of system functions such as system power and battery charge level. The location of icons in the Status display is shown in Figure 1-3

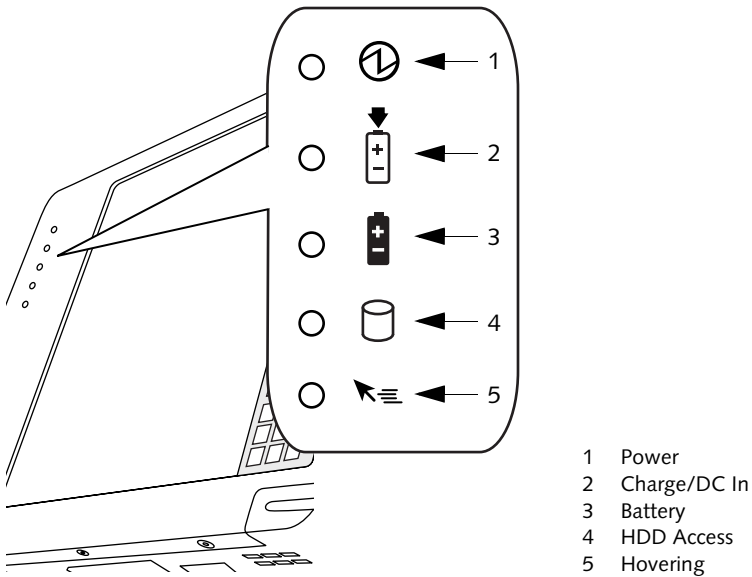

Figure 1-3 Status Display Icons

Table 1-1. explains how individual icons are displayed, and describes what the variations of that display indicate. (If an icon is not displayed, it indicates that the related system function is off or inactive.)

**Note:** In the following table, a “blinking” LED flashes at the rate of once per second; an LED that is “blinking, slow” flashes at the rate of one second on, five seconds off.

Table 1-1. System Status Indicators



Icon	Mode/State	LED State	Remarks
	<ul style="list-style-type: none"> <li>• On State</li> <li>• Idle Mode</li> </ul>	Green (continuous)	
	<ul style="list-style-type: none"> <li>• Suspend-to-RAM</li> </ul>	Green (blinking)	
	<ul style="list-style-type: none"> <li>• Off State</li> <li>• Save-to-Disk</li> </ul>	Off	
<b>Charge/ DC Input</b>  	<ul style="list-style-type: none"> <li>• On State</li> <li>• Idle Mode</li> <li>• Suspend-to-RAM</li> <li>• Save-to-Disk</li> <li>• Off State</li> </ul>	Green	<ul style="list-style-type: none"> <li>• AC adapter and battery pack are available and system is not charging (battery fully charged).</li> <li>• AC adapter is available but battery pack is not present.</li> </ul>
		Amber	AC adapter and battery pack are available and system is charging.
		Amber (blinking)	AC adapter and battery pack are available and waiting to charge (battery pack is out of thermal range).
		Off	AC adapter is not available.

Table 1-1. System Status Indicators



<b>Battery</b>  	<ul style="list-style-type: none"> <li>• On State</li> <li>• Idle Mode</li> <li>• Suspend-to-RAM with AC adapter</li> <li>• Save-to-Disk, with AC adapter</li> <li>• Off State</li> </ul>	Green (continuous)	Battery pack charge is between 100%-50%
		Amber (continuous)	Battery pack charge is between 49%-13%
		Red (continuous)	Battery pack charge is between 12%-0%
		Red (blinking)	There is a battery error.
		Off	Battery pack is not installed.
	<ul style="list-style-type: none"> <li>• Suspend-to-RAM, without AC adapter</li> </ul>	Green (blinking slow)	Battery pack charge is between 100%-50%.
		Amber (blinking slow)	Battery pack charge is between 49%-13%.
		Red (blinking slow)	Battery pack charge is between 12%-0%.
	<ul style="list-style-type: none"> <li>• Save-to-Disk, without AC adapter</li> <li>• Off State</li> </ul>	Off	If battery is inserted during power off, LED blinks amber for 4 seconds to detect battery. Battery status is displayed for 5 seconds after that.
	<b>HDD Access</b>  	<ul style="list-style-type: none"> <li>• On State</li> </ul>	Green
<ul style="list-style-type: none"> <li>• Suspend-to-RAM</li> <li>• Save-to-Disk</li> <li>• Idle Mode</li> <li>• Off State</li> </ul>		Off	Hard disk drive is not being accessed.

Table 1-1. System Status Indicators

<b>Hovering</b> 	<ul style="list-style-type: none"> <li>• On State (Hovering enabled)</li> </ul>	Green	Hovering mode is enabled. (Note that Hovering mode should be disabled when activating desktop icons).
	<ul style="list-style-type: none"> <li>• On State (Hovering disabled)</li> </ul>	Off	Hovering mode is disabled.
	<ul style="list-style-type: none"> <li>• Suspend-to-RAM</li> <li>• Save-to-Disk</li> <li>• Off State</li> </ul>	Off	Not available when system is in Suspend-to-RAM, Save-to-Disk, or Off state.

## Connectors and Peripheral Interfaces

Connectors and peripheral interfaces on the Stylistic LT800P tablet allow you to connect a variety of devices. Specific interface locations are illustrated in Figure 1-4, Figure 1-5, and Figure 1-6.

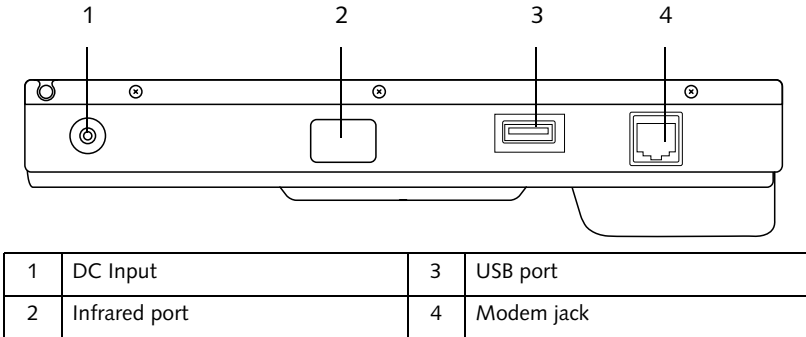

Figure 1-4 Right-Side Connectors and Interfaces

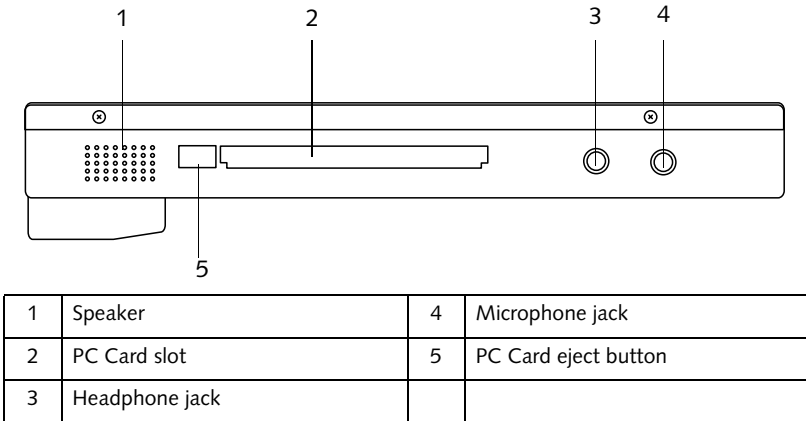
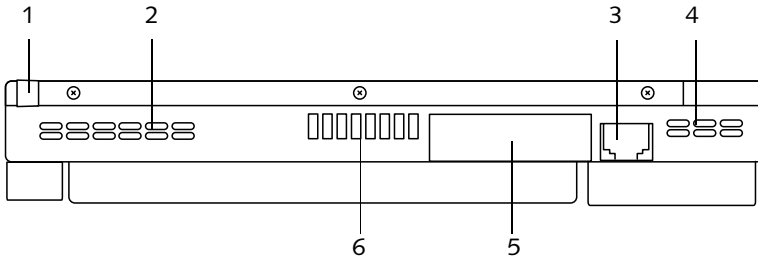

Figure 1-5 Left-Side Connectors and Interfaces



1	Infrared keyboard port	4	Air flow vents
2	Air flow vents	5	Mini-dock interface cover
3	LAN port (RJ-45)	6	Charging contacts

Figure 1-6 Bottom Connectors and Interfaces

Table 1-2 provides a description of each peripheral connector on the Stylistic LT800P tablet. Each of the illustrated icons is printed on the tablet case.

Table 1-2. Peripheral Connectors/Interfaces















Connector/ Peripheral	Fig. Ref.	Tablet Icon	Purpose
DC input connector	1-4		Connect an external power source such as the AC adapter or auto adapter.
USB Port	1-4		Connect Universal Serial Bus-compliant devices to the tablet.
PCMCIA CardBus slot	1-5		Install a Type I or Type II PC Card.
Microphone jack	1-5		Connect an external microphone. The internal microphone is disabled when you plug in an external microphone.
Headphone jack	1-5		Connect stereo headphones or powered external speakers. The internal speaker is disabled when you plug in external headphones or speakers.

Table 1-2. Peripheral Connectors/Interfaces

Connector/ Peripheral	Fig. Ref.	Tablet Icon	Purpose
IrDA/FIR port	1-4		An infrared transceiver built into the tablet allows you to communicate with other devices that are compliant with the IrDA Standard Rev. 1.1. Effective range for infrared communication is about 3 feet, and within 15 degrees off of center. A clear line-of-sight path must exist between the IrDA port on the tablet and the IrDA transceiver on the other device.
Modem	1-4		Connect a telephone line to the optional internal modem using a standard RJ-11 telephone plug.
Charging Contacts	1-6		Install the tablet in an approved docking device. The contacts provide DC input.
Mini-dock port <sup>†</sup>	1-6		Connect the Stylistic LT800P mini-dock. Refer to the documentation accompanying the docking device for more information.
LAN Port (RJ-45)	1-6		The LAN (RJ-45) is used to connect the internal Ethernet device to a LAN or broadband devices such as a cable modem, DSL, or satellite internet.
Infrared keyboard port	1-6		An infrared receiver built into the tablet allows you to communicate with a wireless infrared keyboard or wireless infrared mouse. The infrared port on the keyboard or mouse works optimally between 10 to 30 cm (approximately 4 in. to 12 in.) from the keyboard infrared port, located on the bottom-left edge of the tablet. Ensure that a clear line-of-sight path exists between the infrared receiver on the tablet and the infrared transmitter on the keyboard.
† Remove the mini-dock interface cover to access this port.			

In addition to the connector and interface icons, there are several icons that illustrate component orientation and buttons. These icons are illustrated in Table 1-3..

*Table 1-3. Additional System Icons*

Icon Description	Icon Illustration	Purpose
Battery Release Switch		Indicates the battery release button.
Suspend/Resume /Power Button		Indicates the Suspend/Resume/Power button. (This button can be configured as a Power Off button through the BIOS. When configured to act as a Power Off button, press and hold the button for approximately five seconds to power down the system.)
Wireless LAN On/Off Switch		The wireless LAN switch allows you to turn power to the optional wireless LAN device on and off.



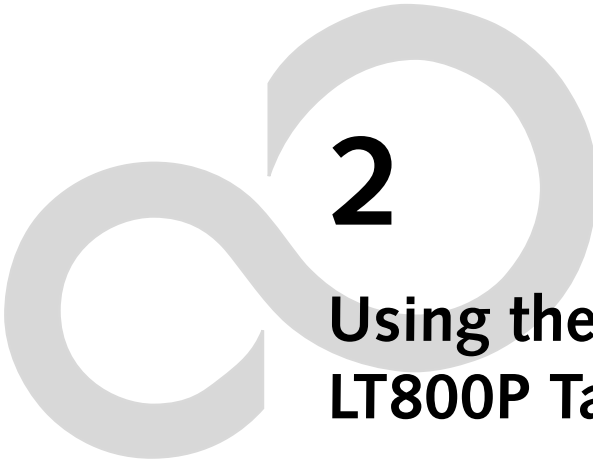

**2**

## **Using the Stylistic LT800P Tablet**



# Using Your Stylistic LT800P

This chapter covers the fundamental concepts, basic system operation and use, and system functions of the Stylistic LT800P tablet. You should familiarize yourself with this information before you attempt to operate the system.

## System States

Before you begin using the Stylistic LT800P tablet, review the different system states (or modes) that the tablet can use. Being familiar with these system states will help you to determine whether it is appropriate to turn on, resume, suspend, or shut down the system when you begin a new session or end your current session. System behavior for each system state is described briefly in the following, with each system state listed in decreasing order of power usage:

- **On state**  
The system is running and the display screen is on.
- **Idle state**  
Some system functions are regulated or turned off to conserve power. The display screen may be turned off. The system returns to the On state when pen activity or other input is detected.
- **Suspend-to-RAM mode**  
System operation is suspended. Most system functions are turned off to conserve power. Power to memory is on, maintaining data in programs that were running before system operation was suspended. The system does not respond to the pen or other input when in Suspend-to-RAM mode. Refer to the “Resuming System Operation” section later in this chapter for information on returning the system to the On state.
- **Save-to-Disk mode**  
System operation is suspended. All system functions are turned off to conserve power. Active data in programs that were running before suspending system operation is stored on the hard disk drive. The system does not respond to the pen or other input. Refer to the “Resuming System Operation” section later in this chapter for information on returning the system to the On state.
- **Off state**  
All system functions are turned off to conserve power. The system does not respond to the pen or other input. The system boots at the next system power-on.

**Note:** The system consumes the same amount of power whether it is in Save-to-Disk mode or the Off state.

Your system may be configured to enter some of these states automatically after a period of inactivity to conserve battery power.

When you use the Stylistic LT800P tablet, you can change the current system state in a number of ways, depending on which state the system is in. To determine the current system state, observe the Power icon in the Status display. Table 2-1, “Changing System States,” on page 26 gives the different system states represented by the Power icon and describes how you can change the system state from the current state.

*Table 2-1 Changing System States*

<b>Power Icon Appearance</b>	<b>Current State</b>	<b>To Change State *</b>
Power icon displayed continuously	On State or Idle State	To enter the Off state, shut down the system using the Start menu on your system.
		To enter Suspend-to-RAM or Save-to-Disk <sup>†</sup> state, suspend system operation using either a hardware or software suspend.
Power icon blinking	Suspend-to-RAM <sup>†</sup> or Standby	To enter the On state, resume system operation by pressing the Suspend/Resume button.
		To enter the Off state, resume system by pressing the Suspend/Resume button, then shut down your system.
Power icon not displayed	Off State or Save-to-Disk <sup>†</sup>	To enter the On state, start your system, or resume system operation by pressing the Suspend/Resume button.

\* Information in Table 2-1 is supplied to help you understand which system states your system can enter from the current system state. Refer to the procedures on starting the system, shutting down the system, suspending system operation, and resuming system operation given later in this chapter.

<sup>†</sup> Your system may be configured to use either Suspend-to-RAM mode or Save-to-Disk mode.

## Powering Up the Tablet

Follow the procedure below to start the Stylistic LT800P tablet. Before you begin, confirm that the system is in the Off state. To do so, observe the Status display. If the Power icon is not visible in the Status display, the system is in the Off state or in Save-to-Disk mode and it is safe to perform this procedure. If the Power icon is visible (either blinking or on continuously), do not perform this procedure. See “System States” earlier in this chapter for details on operational modes represented by the Power icon.

1. Ensure that the battery pack in your tablet is sufficiently charged, or connect an external power source such as the AC adapter or auto adapter to your tablet. See “Status Display” in Chapter 1 to determine the percentage of charge represented by the Battery Gauge icon in the Status display.
2. Press the Suspend/Resume button to start the system.

After performing system initialization, the system starts the operating system installed on the hard disk drive. Once the operating system is running, you can use the system.

## Shutting Down the System

Follow these steps to shut down and turn off your system:

**Note:** *Always use the following procedure unless your system has frozen up and will not allow normal shutdown. If you need to shut down after your system freezes up, hold the power button down for approximately five seconds.*

1. If system operation has been suspended, resume system operation. (See Table 2-1 and “Resuming System Operation” later in this chapter for details.)
2. Save your work and close all running programs.
3. Choose Shut Down from the Windows Start menu and carry out the Shut Down command. The system is now in the Off state.

## Suspending System Operation

The Stylistic LT800P tablet allows you to suspend the system operation without closing programs or exiting the operating system. Use this feature to conserve battery power when a system shutdown is not practical or when the battery needs to be changed.

To suspend system operation:

1. Press the Suspend/Resume button, or carry out the Standby command from your operating system or power management program. (If your system is configured to suspend operation using Save-to-Disk mode, which is explained later in this procedure, a message is displayed while data is saved to your hard disk.)



If you are replacing the battery pack, wait until system is off or system operation is suspended and the power icon is flashing before you remove the battery pack. Failure to do so could result in loss of your unsaved data.

---

The Power icon either flashes (Suspend-to-RAM) or is not displayed (Save-to-Disk) when system operation is suspended, depending on how your system is configured. At this point, programs that were running are stopped, active data is saved, and the system enters one of two different low-power states, or suspend modes, as explained in the following paragraphs.

2. Observe the Power icon in the Status display to determine which suspend mode your system is using.
  - **Power icon is blinking:** *Suspend-to-RAM* mode  
In this mode, active data is saved by maintaining power to RAM while most other system components are powered off. The Battery Gauge icon in the Status display indicates the battery charge level.
  - **Power icon is not displayed:** *Save-to-Disk* mode  
In this mode, active data is stored on the hard disk drive and power usage is reduced to the same level used in the Off state. When the system is in *Save-to-Disk* mode, the Battery Gauge icon is not visible in the Status display. In this mode, there is no danger of losing data if battery power is lost.

If you have successfully performed this procedure, system operation is now suspended. Refer to “Resuming System Operation” later in this chapter to resume system operation. Also, note the following with regard to suspending system operation:



- If the battery goes dead while the system is in Suspend-to-RAM mode, data loss could occur. If the system will be in Suspend-to-RAM mode for an extended period of time, be sure to have a fully charged battery installed.
- The system is supported by a bridge battery for approximately five minutes while the main battery is being replaced. Be sure to replace the main battery quickly or use the AC Adapter when replacing the battery.

- You can remove the battery pack while the system is in Suspend-to-RAM or Save-to-Disk modes in order to install a charged battery pack. To prevent losing unsaved data, wait until system operation has suspended before you remove the battery pack.
- Your system may be configured to suspend operation automatically after a period of inactivity.
- Your system may be configured to enter Save-to-Disk mode automatically after a period of time in Suspend-to-RAM mode.
- The system uses a small amount of battery power when in Suspend-to-RAM mode. Eventually, the battery will become fully discharged.

**Note:** *If you will not be using the system for an extended period of time, shut down the system rather than using Suspend-to-RAM mode.*

- If the battery pack charge drops to a Low-Battery Warning level while the system is running, the system will beep periodically. If this occurs, suspend system operation, shut down the system, or attach an external power source, such as the AC adapter, to the tablet.
- If the battery charge drops to a Critically Low level while the system is running, the system is forced into a pre-selected mode (Suspend-to-RAM or Save-to-Disk). If this occurs, you must either install a charged battery pack, or connect an appropriate external power source such as the AC adapter before you can resume system operation. (If the battery charge drops to a Critically Low level while the system is *in* Suspend-to-RAM mode, the system stays in Suspend-to-RAM mode until power is restored or totally dissipated.)

- Suspending system operation interrupts data communications; therefore, some programs may block the system from suspending to prevent an interruption.
- The suspend action of the Suspend/Resume button may be disabled to prevent accidental interruption. If this is the case, pressing the Suspend/Resume button will not suspend system operation as described here. (In this case, suspend mode can only be achieved using the system software). Contact your local help desk or reseller if your system configuration is not suitable.
- If your system is equipped with a PC Card that allows you to connect to a wired or wireless network, you may be logged off the network after a period of inactivity while system operation is suspended. Contact your network administrator or local help desk for details on log-off parameters for your network.

## Resuming System Operation

To resume system operation, (from either Suspend-to-RAM or Save-to-Disk modes), press the Suspend/Resume button.

- From Suspend-to-RAM mode  
Status lights indicate that the system state is changing. It may take up to a minute before the system returns to the On state and system operation resumes. Note that the display turns on shortly before the pen becomes active due to the power-up sequences observed by the system.
- From Save-to-Disk mode  
Active data is read from the hard disk drive, and the system returns to the On state after a short period of time.

Note that power to several system components must be restored before system operation resumes. Allow sufficient time for system operation to resume before attempting to use the system. If your system uses Save-to-Disk mode, it will take longer to resume operation as compared to using Suspend-to-RAM mode. Time is needed to read data from the hard disk drive.

- Use the system as you normally would once system operation resumes.

All programs resume at the point where execution stopped when system operation was suspended.



## Using Hotpads

The Hotpad area consists of several pen-active “keys” on the right side of the system display that you can use to change several settings. The hotpads allow you to:

- Adjust the display and speaker settings
- Invoke right mouse button
- Invoke hovering capability
- Use as a numeric pad
- Use as a NumLock key

To use a hotpad key, tap directly on it with the pen. You can also press and hold the pen tip against the Volume and Brightness hotpad keys to automatically repeat the hotpad function. The location of each hotpad key is shown in Table 2-1, “Stylistic Hotpad Arrays,” on page 31.

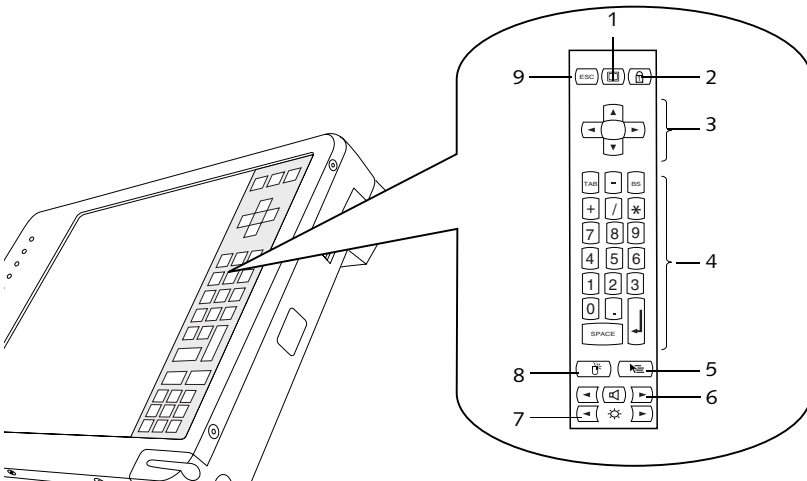

1	Display key	4	Numeric keys	7	Brightness keys
2	NumLock key	5	Hovering key	8	Mouse right button key
3	Cursor keys	6	Speaker keys	9	Escape key

Figure 2-1 Stylistic Hotpad Arrays

A summary of each hotpad's function is given below.

**Note:** *Equivalent key codes are included for applicable hotpad keys. These can be used when a keyboard is connected.*

Table 2-2 Hotpad Keys













Icon	Name	Description
	Escape	Functions the same as the [Esc] key on a typical keyboard.
	Display	Each time the Display Device hotpad key is tapped, the display unit is switched (in the following order): LCD -> CRT -> both LCD and CRT -> LCD... External video is available from the docking station.
	NumLock	Acts in the same way as the NumLock key on the keyboard. (The default is On on the keypad).
	Cursor Control	Acts in the same way as the cursor keys on a keyboard. (Up, Down, Left, and Right).
	Numeric Keypad	Acts in the same way as the numeric keypad on a keyboard. ("BS" signifies "Backspace"). Note that when NumLock is off, the numeric keys act as cursor keys.
	Right Mouse Button	Switches the pen function from left mouse button to right mouse button emulation for a single mouse event after tapping the hotpad.

Table 2-2 Hotpad Keys

Icon	Name	Description
	Pen Hovering	Switches the hovering mode on or off. Throughout the hovering mode, the hovering status indicator is lit green. Refer to the section of this chapter entitled "Using Hovering Mode" for additional information.
	Speaker Volume Down	Decreases the speaker volume.
	Speaker Volume Up	Increases the speaker volume.
	Speaker Volume Mute	Toggles the speaker off and on.
	Brightness Down	Decreases the luminance of the display backlight.
	Brightness Up	Increases the luminance of the display backlight.

## Using the Pen

You can use the Stylistic LT800P pen to generate and create electronic “ink”, to select items, and to navigate through programs on the tablet. The pen can be used like a two button mouse when used in conjunction with the right-mouse button hotpad. Programs which support handwriting recognition allow you to write characters directly on the screen with the pen and then translate your printed text into keyboard-style input.



- Ensure that a screen protector is installed on the tablet screen before you use the pen. The Limited Warranty does not cover a screen that is scratched as a result of not using a screen protector.
- Use only the pen stylus provided with your tablet. Do not use substitutes that were not designed for the Stylistic LT800P.

To toggle between using the pen for inking and using it as a mouse, click on the small pen icon in the system tray at the bottom right of the screen.

Here are some hints on using the pen like a two-button mouse on a desktop system:

- **To select an object**, tap the mouse tip on the object once. This functions like a mouse button click with the left mouse button.
- **To “double-click” an object**, tap twice on the object quickly.
- **To generate a “right mouse button single-click”**, tap on the hotpad icon once and then tap once on the display. To generate a **“right mouse button double click”**, tap on the hotpad icon once and then double tap on the display.
- **To move, or “drag”, an object on the screen**, place the pen tip directly over the object, then as you hold the pen tip against the screen, move the pen.

## Calibrating the pen

Calibration of the pen adjusts the cursor position on the screen relative to the position of the pen tip. You calibrate the pen to adjust the distance error between where the pen actually touches the screen and where the system “thinks” the pen is touching. If the event you wish to invoke is not displayed under the pen tip when you use the pen, you should calibrate the pen.

Pen calibration may be required due to the following situations:

- The pen is being used for the first time.
- The previous user of the Stylistic LT800P tablet writes with the opposite hand or at a different pen angle.
- The system has been in use for some time and the pen has not been recalibrated.
- The original system image has been restored.

### To Calibrate the Pen

1. Open the Control Panel from the Start|Settings menu, and double-tap the Pen Configuration icon. Select the Calibration property sheet, then click on Pen Calibration.
2. Position the Stylistic LT800P tablet as you normally would during use. Be sure to hold the pen at the angle that you regularly use. Touch the screen only with the pen tip; if you inadvertently touch the screen with your finger or hand during the calibration process, faulty calibration may result.
3. Perform the calibration steps according to the instructions on the screen. The calibration utility displays a cross-hair symbol in the middle and corners of the screen, one corner at a time. Hold the pen as you normally would while using the system and, as accurately as possible, tap the center of each crosshair as it is displayed.

A dialog box is displayed after you tap the last of the four cross-hair symbols. Tap the screen within 20 seconds if you wish to save your new calibration settings. If you don't tap the screen within 20 seconds, the default calibration settings will be used.

4. When the Verify New Pen Calibration Settings window appears, choose one of the following steps.
  - If you are satisfied that you tapped the cross-hairs accurately, tap Yes. The taps that you performed in step 3 are then used to calibrate the screen.
  - If you do not want to use the new calibration, tap No.
  - If you want to enter a new calibration, tap Recalibrate. The calibration instructions reappear.

If you have successfully performed the procedure above, the pen is now recalibrated, and you can use the system as you normally would.

## Replacing the Pen

With use, the pen tip may become worn or may pick up foreign particles that can scratch the screen. A damaged or worn tip may not move freely, causing unpredictable results when using the pen. If your pen exhibits these problems, replace the pen by contacting your reseller.

## Using Hovering Mode

Selecting the Pen Hovering icon on the Stylistic LT800P hotpad provides the user with better cursor control. When the hovering option is enabled, the cursor can be positioned over an icon without activating it. This is useful when you are performing procedures that require accurate cursor positioning, such as when simulating mouse rollover, selecting a small icon, or beginning a paint session.

- To enable hovering, tap the Pen Hovering icon on the hotpad. The Hovering system status indicator light illuminates green when hovering is selected.
- To disable hovering, tap the Pen Hovering icon again. The Hovering system indicator light is off when hovering is not selected.

## Charging the Battery Pack

The Stylistic LT800P battery pack can be charged while it is installed in the tablet.

To do so:

1. Connect an AC adapter to the DC input connector on the tablet. The DC Input icon appears in the Status display. If the battery pack charge level is below 90%, the battery pack begins charging and the Charging icon appears in the Status display. If the battery pack charge is 90% or higher *when you connect* DC power, the battery pack will not charge, preventing overcharging the battery pack.
2. Look at the Battery Gauge icon in the Status display to determine the percent of charge in the battery pack. See “Status Display” in Chapter 1 of this manual for a description of the Battery Gauge icon.

As long as DC power *remains connected* to the tablet, the charging process continues until the battery pack charge reaches 100%. Charge times shown in Table 2-3, “Battery Pack Charging Time,” on page 37 are for a fully discharged battery pack charging both while the tablet is and is not in use.

Table 2-3 Battery Pack Charging Time

Battery Pack Charge Level Reached	Approximate Charge Time (tablet not in use)	Approximate Charge Time (tablet in use)
90%	3 hours	6 hours*
100%	4 hours	8 hours*

\* Actual charge time will be determined by the applications in use.

Also note the following with respect to charging the battery pack:

- You can use the system, suspend system operation, or shut down and turn off the system without interrupting the charging process; however, using the system while the battery pack is charging will cause the battery pack to charge at a slower rate, as noted in Table 2-3, “Battery Pack Charging Time,” on page 37.
- As noted in the procedure above, the system will not begin charging the battery pack if the battery pack charge level is 90% or higher when the system is *initially connected* to external DC power. (This prevents the battery pack from being overcharged.)
- The Stylistic LT800P battery pack uses Lithium ion battery cells which have no “memory effect.” You do not need to discharge the battery pack before you begin charging.

## Removing and Installing the Battery Pack

The battery pack can be removed from the tablet and swapped with a charged battery pack. The battery pack can then be charged in an external charger if one is available.

To remove the battery pack from the tablet:

1. Choose one of the following:
  - If a charged battery pack is available, you can suspend system operation. A built-in “bridge” battery will maintain the system in Suspend-to-RAM mode for about 5 minutes while the battery pack is removed; this allows time for replacement with a charged battery pack.
  - If a charged battery pack is not available, save your work and close all running programs, then shut down the system or Save-to-Disk.
  - Plug in an external AC/DC power source.

2. Slide the spring-loaded battery release switch in the direction indicated in .
3. While holding the switch, slide the battery pack away from the top of the system, as indicated in .

If you are using an external battery charger, refer to the instructions provided with the battery charger.

To install the battery pack:

Orient the battery so the grooves on the sides of the battery align with the slides inside of the battery tray. Slide the battery pack into the tray and press it firmly into the tray until it is seated. When it is properly seated, the battery release switch will automatically latch the battery pack into place.

Once the battery pack is installed, you can resume system operation or start your system and use the system normally.

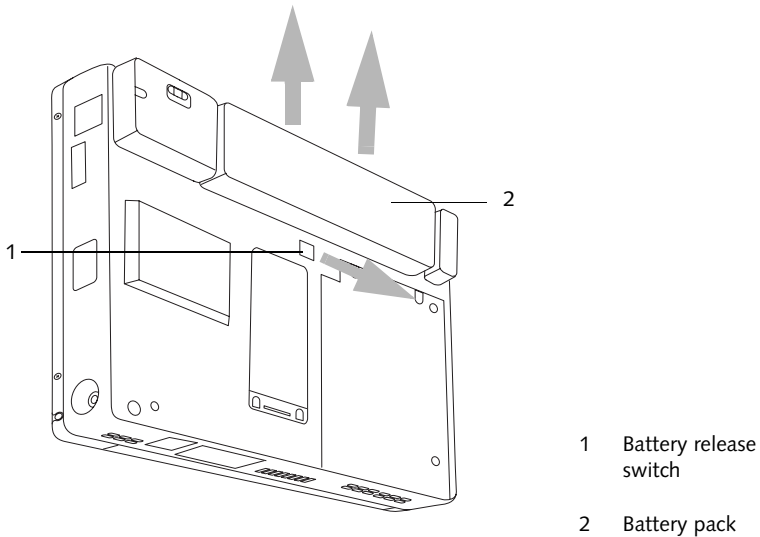

Figure 2-2 Removing the Battery Pack



## Tips for Conserving Battery Power

You can extend the charge life of your battery pack by conserving battery power. Battery life is dependent upon a number of factors: operating system, power settings, and applications or peripherals in use. Here are some suggestions to help you conserve battery power:

- Use an external power source such as the AC adapter to power the system when possible.
- Suspend system operation if you won't be using the system for a while.
- Shut down the system if you won't be using the system for an extended period of time.
- Use power management timeouts (accessible through the BIOS setup) to help conserve power automatically. Contact your reseller before modifying the BIOS.

## Operation of the Bridge Battery

When installed in the tablet, the battery pack provides power to some system components—even when the system is in the Off state. When the battery pack is removed, power is supplied to these components by a “bridge” battery that is built into the tablet.

The bridge battery is not designed for long-term operation (it will support a suspended system for between five and ten minutes). To maintain the bridge battery properly, observe the following measures:

*Note:* The system arrives with the bridge battery in a discharged state.

- To prevent draining the bridge battery, always store the tablet with a charged battery pack installed.
- If the bridge battery becomes drained, it takes approximately 11 hours for it to be fully recharged.
- The bridge battery charges from the AC Adapter when the adapter is connected and the system is in On or Off states or Suspend mode. It charges from the battery only when the system is in the On state.

## Modem Connection

---



- Actual speeds over U.S. telephone lines vary, and are less than 56Kbp due to the current FCC regulations and line conditions. The internal modems on all Fujitsu tablets from Fujitsu PC Corporation are only qualified for use with telephone systems in selected countries, including the United States and Canada. For a full list of certified countries, check [www.fujitsupc.com/modems](http://www.fujitsupc.com/modems).
  - The LAN portion of the internal LAN/modem module can only be used when the system is used with the optional mini-dock; there is no LAN port on the system itself.
- 

The Stylistic LT800P tablet is designed to accept a standard RJ-11 telephone plug. Connect the plug to the modem jack located on the right-hand side of the tablet, to the left of the DC Input jack (reference Figure 1-1). The telephone plug can be installed whether or not the tablet has power applied.

If you need assistance configuring the Stylistic LT800P tablet modem or LAN, contact your local help desk or your reseller.

## PC Card Slot

The Stylistic LT800P tablet PC Card slot allows you to install a Type II PCMCIA CardBus card.

To install a PC card, position the side with the arrow facing up (i.e., when looking at the tablet's display side, the arrow on the card should be visible.) Slide the card into the PC Card slot, and press it firmly to ensure proper seating.

## LAN Port (RJ-45)

The LAN port allows you to connect the internal Fast Ethernet (10/100 Base-T/Tx) to a Local Area Network (LAN), or to broadband devices. To connect a LAN plug, insert the plug into the LAN jack located on the bottom edge of the tablet, to the right of the mini-dock interface (See Figure 1-2 for location).

## Changing the BIOS Settings

Your tablet's BIOS (Basic Input-Output System) contains a program and a set of default parameters stored in ROM which tests and operates your tablet when you turn it on until the installed operating system is loaded from the hard disk.

The BIOS Setup utility is a program that allows you to change your system's BIOS settings. The BIOS Setup application is stored in the system's CMOS memory. The BIOS Setup utility configures device control parameters (such as changing I/O addresses and boot devices) and system data security parameters such as passwords.

## Starting BIOS Setup

To start BIOS Setup,

1. Shut down your computer if it is running.
2. Start your system. When the following message appears,  
<F2>, Double tap the pen+: BIOS Setup  
double tap the pen on the display screen or press F2 on your external keyboard.
3. The system starts BIOS Setup and the BIOS Setup **Main** menu is displayed.  
Note that the system can be configured to start without displaying the message above. If this is the case, you must attach an external keyboard and hold down the F2 key while you start your system until the BIOS Setup screen is displayed.

Once BIOS Setup is started, you can use it to change your system's BIOS settings. Use the information at the bottom of the screen to navigate through the various screens.





**3**  
**Care and  
Maintenance**



# Caring for Your Stylistic LT800P

This chapter gives you pointers on how to care for and maintain your tablet.

## Protecting the Display Screen

The Stylistic LT800P tablet is designed to provide you with years of service. Using a screen protector will help ensure that the screen remains as clear as possible. When installed, the screen protector becomes a durable, replaceable writing surface that protects the display screen from abrasion.

To obtain additional screen protectors use Fujitsu part number FMWSP11 (12-pack) when ordering. (These and other accessories can be ordered from the FPC Web site at [www.fujitsupc.com](http://www.fujitsupc.com).) Additional information about installation is included with the screen protectors.



During normal use of the tablet, small particles from the environment can become embedded in the pen tip and scratch the screen. To prevent scratching the screen, ensure that a screen protector is installed before using your tablet. The Limited Warranty does not cover a screen that is scratched as a result of not using a screen protector.

---

To install a new screen protector on your tablet:

1. If a screen protector is already installed on the display screen, remove it before installing the new screen protector.

The screen protector is held onto the display screen surface by a thin strip of adhesive around the edges. A notch in one corner of the screen protector allows you to slide your fingernail under the screen protector for easy removal.

2. Clean the display by wiping the screen surface gently using a soft cotton cloth dampened with denatured alcohol. Ensure that all residue has been removed from the screen before applying a new screen protector. Remove the protective coating from the adhesive side of the screen protector first.



The Stylistic LT800P tablet is **not waterproof**. Do not pour liquids on the system or wash it with a heavily soaked cloth. Doing so could result in electrical shock and/or damage to the equipment. In the event that liquids are spilled on the unit, immediately turn off and unplug the system.

---

3. Apply the screen protector to the display screen surface. When doing so, orient the screen protector with the adhesive side of the screen protector facing the display screen and the notched corner of the screen protector toward the lower left corner of the display screen.

4. Apply pressure to the screen protector with your finger using a continuous wiping motion along the edges. The adhesive sets completely within 48 hours. To ensure a good seal between the screen protector and the display, do not lift the screen protector from the display once it has been applied.
5. Remove the protective plastic cover from the face of the screen protector.
6. Clean any residue left behind by the protective coating from the exposed surface of the screen protector by wiping gently with a soft cotton cloth dampened with denatured alcohol. Wipe the screen protector with a soft dry cloth to remove any low-tack adhesive; this will help prevent the pen tip from squeaking.

## Storing the Stylistic LT800P Tablet

---



Be sure not to store your Stylistic LT800P with the screen side down, otherwise damage to the display may occur.

---

Store your tablet in the Off state with a fully charged battery pack installed. The battery pack always provides power to some system components, even when the system is in Off state. If the system is stored with the battery pack removed, these components are powered by the system's internal bridge battery. The bridge battery is not designed for extended use and will discharge in a short period of time; this could result in damage to the batteries. You can store the tablet in the Off state for about 30 days with a fully charged battery pack installed. After this period, the battery pack should be recharged or replaced with a charged battery pack.

## Avoiding Overheating

The Stylistic LT800P tablet monitors its internal temperature. As the internal temperature approaches the tolerable limits of heat-sensitive components, system functions are automatically limited or turned off to prevent damage.

---



To avoid overheating the tablet, do not obstruct the air vents on the top and bottom edges of the tablet.

---





**4**  
**Troubleshooting**



# Troubleshooting Your Stylistic LT800P

Solutions to some common problems are described in the following sections. If you are experiencing a problem with your tablet that you cannot solve by taking the actions described, contact your local help desk or your reseller for further assistance.

## System Will Not Resume Operation

If the system will not resume operation after system operation has been suspended, check the following possible causes:

- The battery pack may either be defective, or discharged to the critically low level. When the battery pack reaches the critically low level, the system is forced into Suspend-to-RAM mode to avoid a total system power failure. To correct this problem, either connect an external power supply (such as the AC adapter), or install a charged battery pack in the tablet.
- The system may be at the critical thermal limit. To avoid damage to heat-sensitive components, the system enters Suspend-to-RAM mode when it gets too hot. System operation cannot be resumed until the tablet cools off to a tolerable temperature. Move the tablet to a cooler location.

## Display Screen Is Blank or Difficult to Read

If the display screen on your Stylistic LT800P tablet appears blank or is unreadable, confirm that the system is running (the Power icon is displayed continuously on the Status display), and check the following:

- The system brightness may be set too low, causing the screen to appear too dark. Use the brightness hotpad to adjust the screen brightness.
- An external monitor may be selected. Tap on the Display Select hotpad to determine whether the tablet display screen is selected.
- The video timeout may have expired. Tap on the display screen to reactivate the display. Note that this is a normal, power-saving feature.

## Infrared Data Transfer Is Not Working

If you are experiencing problems transferring data over the system's infrared interface, note the following:

- Can the IrDA port on the tablet "see" the IrDA port on the other device? A direct line-of-sight path must exist between the IrDA port on the tablet and the IrDA port on the other device.

- The distance between the two devices must not be more than approximately 3 feet or 1 meter.
- The viewing angle from the IrDA port on the tablet must not be more than 15 degrees from a center line between the IrDA port on the tablet and the IrDA port on the other device.
- The device with which you are trying to communicate must be compliant with the IrDA Standard Revision 1.1 (or 1.0).

## Cursor Is Not Tracking Pen

If the cursor on the screen appears to be misaligned with the pen or is not accurately tracking the pen, calibrate the pen. See “Calibrating the Pen” in Chapter 2 for details.

## Tablet Is Not Responding to the Pen

If your tablet is not responding to the pen, connect an external keyboard to the system to see if it responds to keyboard commands. If the system doesn’t respond to the keyboard, the application or system may have crashed, and it may be necessary to reset the system.

## Audio Volume Too Low

If the audio volume on your tablet speaker or external headphones is too low, check the following:

- Ensure that the speaker (or headphone output if using headphones) is enabled. To do so, tap the Speaker Mute hotpad. The system beeps when the speaker or headphone output is turned on using the hotpad.
- Ensure that the volume level set with Volume hotpads is set to an audible level.
- Ensure that the mute box in the system volume control (accessible from the system tray) is not set.
- Ensure that any volume control in the audio software is set to an audible level.

## Configuring Peripherals Interfaces

Certain peripheral devices can be disabled during the BIOS Setup. If the peripheral interface you want to use does not appear to be working with your peripheral device, ensure that it is enabled in the BIOS. Contact your local help desk or reseller if you need assistance using BIOS Setup.



**5**  
**Hardware  
Specifications**



## Stylistic LT800P Hardware Specifications

The following table provides general hardware specifications of the Stylistic LT800P by category.

Stylistic LT800P Tablet Specifications	
<b>Physical Specifications</b>	
Dimensions	9.6" w x 6.3" d x 1.1" h (244mm x 160mm x 28mm)
Weight	2.70 lb. (1.22 kg) with 6 cell battery
<b>Processing Specifications</b>	
CPU	Ultra low voltage (ULV) Mobile Intel Pentium III processor - M with enhanced SpeedStep technology, 866/400 MHz
Chip set	Intel 830MG
<b>Memory/Storage Specifications</b>	
Main RAM	256MB or 512MB, single slot, 3.3V SDRAM
L1 cache (CPU)	32 KB on die
L2 cache (CPU)	512 KB on die
BIOS ROM	1 MB (FWH - firmware hub)
Hard disk drive	<ul style="list-style-type: none"> <li>• 2.5" HDD</li> <li>• 40GB IDE HDD</li> <li>• Shock-mounted</li> </ul>
<b>Input/Output Specifications</b>	
Digitizer	Resistive, with palm rejection
VRAM	Intel 830MG chipset with 8MB shared memory using Unified Memory Architecture (UMA) delivers low-power, high-performance 3D/2D graphics, video, and display capabilities. Dynamic Video Memory Technology (DVMT) dynamically responds to application requirements and efficiently allocates the proper amount of memory (48MB max.) for optimal graphics and system performance.

<b>Stylistic LT800P Tablet Specifications (Continued)</b>	
Display	8.4" SVGA TFT Color (800 x 600 dot) 256K colors. Brightness: 8 levels
<b>Interface Specifications</b>	
PC Card Slot	<ul style="list-style-type: none"> <li>• One Type-I or Type-II</li> <li>• PCMCIA CardBus version 3.0</li> </ul>
Integrated Interfaces	<ul style="list-style-type: none"> <li>• RJ-11 (modem)</li> <li>• RJ-45 (LAN)</li> <li>• USB 1.1</li> <li>• DC-In</li> <li>• Expansion connector</li> <li>• Mono Microphone In</li> <li>• Stereo Headphone Out</li> <li>• IrDA 1.1</li> <li>• IR Keyboard</li> </ul>
Modem/LAN	Internal combination Modem/LAN module <ul style="list-style-type: none"> <li>• LAN: 10/100BaseT</li> <li>• Modem: 56 Kbps (V.90), 53 Kbps receive/33.6 Kbps send/14.4 Kbps fax</li> </ul>
Infrared	IrDA version 1.1 (FIR, 4Mbps)
Audio	<ul style="list-style-type: none"> <li>• SigmaTel STAC9767 codec</li> <li>• Internal mono microphone and speaker</li> <li>• Mono microphone and stereo headphone jacks</li> </ul>
User Controls	<ul style="list-style-type: none"> <li>• Hotpads: escape, volume, NumLk, arrow keys, display, brightness, right button, hovering, numeric keypad</li> <li>• Suspend/Resume button</li> <li>• Reset button (Power Off switch)</li> </ul>
Status Indicators (LEDs)	<ul style="list-style-type: none"> <li>• Power</li> <li>• Charge/DC-In</li> <li>• Battery level</li> <li>• HDD</li> <li>• Hovering</li> </ul>



<b>Stylistic LT800P Tablet Specifications (Continued)</b>	
<b>Power Specifications</b>	
Main Battery	<ul style="list-style-type: none"> <li>• 6-cell</li> <li>• Removable, Lithium ion</li> <li>• 10.8 V @ 3400 mAh</li> <li>• Warm-swappable</li> <li>• Recharge Time: Suspend/Off: 3 hours (90%), 4 hours (100%) Operating (slow charge): 8 hours (100%)</li> <li>• Suspend Life: Minimum 5 days Off State: Approximately 20 days from full charge</li> </ul>
<b>Environmental Specifications</b>	
Temperature	Operating: 5° - 35° C (41° - 95° F) Non-operational: -20° - 60° C (-4° - 140° F)
Humidity	Operating: 20 - 80% non-condensing Non-operating: 20 - 80% non-condensing
<b>Agency Approval Specifications</b>	
Emissions	<ul style="list-style-type: none"> <li>• EN55022, Class B:1998</li> <li>• FCC Part 15, Subpart 15, Class B</li> <li>• CISPR 22: 1997, Class B</li> <li>• EN50081-1: 1992</li> </ul>
Immunity	<ul style="list-style-type: none"> <li>• EN55024</li> <li>• EN61000-4-2, 3, 4, 5, 8, 11</li> <li>• EN61000-3-2, 3</li> </ul>
Safety	<ul style="list-style-type: none"> <li>• UL/cUL: UL1950, 3rd Ed.</li> <li>• TUV T-Mark: EN60950</li> </ul>
Modem	<ul style="list-style-type: none"> <li>• FCC Part 68, IC CS03, Issue 8</li> </ul>
<b>Additional Specifications</b>	
Operating systems	Windows 2000, Windows XP Professional
Logo	PC2001-compliant





**6**  
**Agency Notices**



# Agency Notices

## NOTICE

Changes or modifications not expressly approved by Fujitsu could void this user's authority to operate the equipment.

## FCC NOTICES

### Notice to Users of Radios and Television

These limits are designed to provide reasonable protection against harmful interference in a residential installation. This equipment generates, uses, and can radiate radio frequency energy and, if not installed and used in accordance with the instructions, may cause harmful interference to radio communications. However, there is no guarantee that interference will not occur in a particular installation. If this equipment does cause harmful interference to radio or television reception, which can be determined by turning the equipment off and on, the user is encouraged to try to correct the interference by one or more of the following measures:

- Reorient or relocate the receiving antenna.
- Increase the separation between the equipment and receiver.
- Connect the equipment into an outlet that is on a different circuit than the receiver.
- Consult the dealer or an experienced radio/TV technician for help.

Shielded interconnect cables must be employed with this equipment to ensure compliance with the pertinent RF emission limits governing this device.

### Notice to Users of the US Telephone Network

This equipment complies with Part 68 of the FCC rules, and the requirements adopted by ACTA. On the bottom of this equipment is a label that contains, among other information, the FCC registration number and ringer equivalence number (REN) for this equipment; or a product identifier in the format US:AAAEQ##TXXXX. If requested, this information or number must be provided to the telephone company.

This equipment is designed to be connected to the telephone network or premises wiring using a standard jack type USOC RJ11C. A plug and jack used to connect this equipment to the premises wiring and telephone network must comply with the applicable FCC Part 68 rules and requirements adopted by the ACTA. A compliant telephone cord and modular plug is provided with this product. It is designed to be connected to a compatible modular jack that is also compliant.

The ringer equivalent number (REN) of this equipment is 0.0B. The REN is used to determine the number of devices that may be connected to a telephone line. Excessive RENs on a telephone may result in the devices not ringing in response to an incoming

call. In most but not all areas, the sum of RENs should not exceed five (5.0). To be certain of the number of devices that may be connected to a line, as determined by the total RENs, contact the local telephone company. For products approved after July 23, 2001, the REN for this product is part of the product identifier that has the format US:AAAEQ##TXXXX. The digits represented by ## are the REN without a decimal point (e.g., 00 is a REN of 0.0). For earlier products, the REN is separately shown on the label.

If this equipment causes harm to the telephone network, the telephone company will notify you in advance that temporary discontinuance of service may be required. But if advance notice isn't practical, the telephone company will notify the customer as soon as possible. Also, you will be advised of your right to file a complaint with the FCC if you believe it is necessary.

The telephone company may make changes in its facilities, equipment, operations or procedures that could affect the operation of the equipment. If this happens, the telephone company will provide advance notice in order for you to make necessary modifications to maintain uninterrupted service.

If trouble is experienced with this equipment, for repair or warranty information, please refer to the manual or contact Fujitsu PC Corporation, Customer Service. If the equipment is causing harm to the telephone network, the telephone company may request that you disconnect the equipment until the problem is resolved.

The equipment cannot be used on public coin service provided by the telephone company. Connection to party line service is subject to state tariffs. (Contact the state public utility commission, public service commission or corporation commission for information).

If your home has specially wired alarm equipment connected to the telephone line, ensure the installation of this computer does not disable your alarm equipment. If you have any questions about what will disable alarm equipment, consult your telephone company or a qualified installer.

The Telephone Consumer Protection Act of 1991 makes it unlawful for any person to use a computer or other electronic device to send any message via a telephone fax machine unless such message clearly contains in a margin at the top or bottom of each transmitted page or on the first page of the transmission, the date and time it is sent, and an identification of the business or other entity, or other individual sending the message and the telephone number of the sending machine or such business, other entity, or individual.

## DOC (INDUSTRY CANADA) NOTICES

### Notice to Users of Radios and Television

This Class B digital apparatus meets all requirements of Canadian Interference-Causing Equipment Regulations.

CET appareil numérique de la class B respecte toutes les exigence du Règlement sur le matériel brouilleur du Canada.

### Notice to Users of the Canadian Telephone Network

NOTICE: This equipment meets the applicable Industry Canada Terminal Equipment Technical Specifications. This is confirmed by the registration number. The abbreviation, IC, before the registration number signifies that registration was performed based on a Declaration of Conformity indicating that Industry Canada technical specifications were met. It does not imply that Industry Canada approved the equipment.

Before connecting this equipment to a telephone line the user should ensure that it is permissible to connect this equipment to the local telecommunication facilities. The user should be aware that compliance with the certification standards does not prevent service degradation in some situations.

Repairs to telecommunication equipment should be made by a Canadian authorized maintenance facility. Any repairs or alterations not expressly approved by Fujitsu or any equipment failures may give the telecommunication company cause to request the user to disconnect the equipment from the telephone line.

NOTICE: The Ringer Equivalence Number (REN) for this terminal equipment is 0.0. The REN assigned to each terminal equipment provides an indication of the maximum number of terminals allowed to be connected to a telephone interface. The termination on an interface may consist of any combination of devices subject only to the requirement that the sum of the Ringer Equivalence Numbers of all the devices does not exceed five.



For safety, users should ensure that the electrical ground of the power utility, the telephone lines and the metallic water pipes are connected together. Users should NOT attempt to make such connections themselves but should contact the appropriate electric inspection authority or electrician. This may be particularly important in rural areas.

### Avis Aux Utilisateurs Du Réseau Téléphonique Canadien

AVIS: Le présent matériel est conforme aux spécifications techniques d'Industrie Canada applicables au matériel terminal. Cette conformité est confirmée par le numéro d'enregistrement. Le sigle IC, placé devant le numéro d'enregistrement, signifie que l'enregistrement s'est effectué conformément à une déclaration de confor-

mité et indique que les spécifications techniques d'Industrie Canada ont été respectées. Il n'implique pas qu'Industrie Canada a approuvé le matériel.

Avant de connecter cet équipement à une ligne téléphonique, l'utilisateur doit vérifier s'il est permis de connecter cet équipement aux installations de télécommunications locales. L'utilisateur est averti que même la conformité aux normes de certification ne peut dans certains cas empêcher la dégradation du service.

Les réparations de l'équipement de télécommunications doivent être effectuées par un service de maintenance agréé au Canada. Toute réparation ou modification, qui n'est pas expressément approuvée par Fujitsu, ou toute défaillance de l'équipement peut entraîner la compagnie de télécommunications à exiger que l'utilisateur déconnecte l'équipement de la ligne téléphonique.

AVIS: L'indice d'équivalence de la sonnerie (IES) du présent matériel est de 0.0. L'IES assigné à chaque dispositif terminal indique le nombre maximal de terminaux qui peuvent être raccordés à une interface téléphonique. La terminaison d'une interface peut consister en une combinaison quelconque de dispositifs, à la seule condition que la somme d'indices d'équivalence de la sonnerie de tous les dispositifs n'excède pas 5.



Pour assurer la sécurité, les utilisateurs doivent vérifier que la prise de terre du service d'électricité, les lignes téléphoniques et les conduites d'eau métalliques sont connectées ensemble. Les utilisateurs NE doivent PAS tenter d'établir ces connexions eux-mêmes, mais doivent contacter les services d'inspection d'installations électriques appropriés ou un électricien. Ceci peut être particulièrement important en régions rurales.



**UL NOTICE**

This unit requires an AC adapter to operate. Use only UL Listed Class 2 Adapters with an output rating of 16 VDC, with a current of 3.75 A.

AC Adapter output polarity:



When using your modem equipment, basic safety precautions should always be followed to reduce the risk of fire, electric shock, and injury to persons, including the following:



- Do not use this product near water (for example, near a bath tub, wash bowl, kitchen sink or laundry tub, in a wet basement or near a swimming pool).
- Avoid using a modem during an electrical storm. There may be a remote risk of electric shock from lightning.

Do not use the modem to report a gas leak while in the vicinity of the leak.



The modem-to-telephone network connection must be a line cord using a minimum #26 AWG wire.

**For Authorized Repair Technicians Only**

- For continued protection against risk of fire, replace only with the same type and rating fuse.
- Danger of explosion if Lithium (clock) battery is incorrectly replaced. Replace only with the same or equivalent type recommended by the manufacturer. Dispose of used batteries according to the manufacturer's instruction.



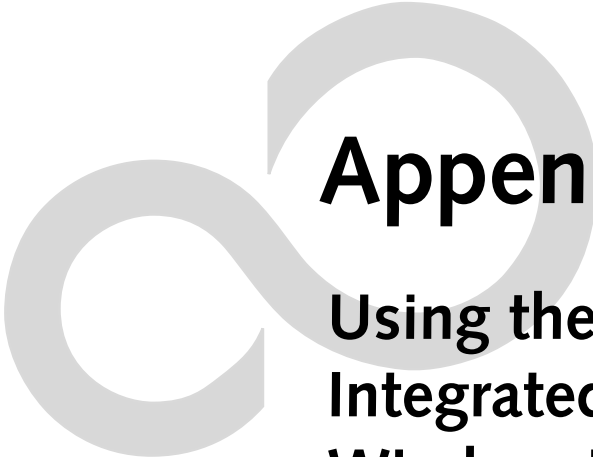

# **Appendix**

## **Using the Integrated Wireless LAN\***

**\*Optional Device**





## FCC Regulatory Information

Please note the following regulatory information related to the optional wireless LAN device.

### Regulatory Notes and Statements

#### Wireless LAN, Health and Authorization for use

Radio frequency electromagnetic energy is emitted from Wireless LAN devices. The energy levels of these emissions, however, are far much less than the electromagnetic energy emissions from wireless devices such as mobile phones. Wireless LAN devices are safe for use by consumers because they operate within the guidelines found in radio frequency safety standards and recommendations. The use of Wireless LAN devices may be restricted in some situations or environments, such as:

- On board an airplane, or
- In an explosive environment, or
- In situations where the interference risk to other devices or services is perceived or identified as harmful.

In cases in which the policy regarding use of Wireless LAN devices in specific environments is not clear (e.g., airports, hospitals, chemical/oil/gas industrial plants, private buildings), obtain authorization to use these devices prior to operating the equipment.

#### Regulatory Information/Disclaimers

Installation and use of this Wireless LAN device must be in strict accordance with the instructions included in the user documentation provided with the product. Any changes or modifications made to this device that are not expressly approved by the manufacturer may void the user's authority to operate the equipment. The manufacturer is not responsible for any radio or television interference caused by unauthorized modification of this device, or the substitution or attachment of connecting cables and equipment other than those specified by the manufacturer. It is the responsibility of the user to correct any interference caused by such unauthorized modification, substitution or attachment. The manufacturer and its authorized resellers or distributors will assume no liability for any damage or violation of government regulations arising from failure to comply with these guidelines.

#### Federal Communications Commission statement

This device complies with Part 15 of FCC Rules.

Operation is subject to the following two conditions: (1) This device may not cause interference, and, (2) This device must accept any interference, including interference that may cause undesired operation of this device.

## FCC Interference Statement

This equipment has been tested and found to comply with the limits for a Class B digital device, pursuant to Part 15 of the FCC Rules. These limits are designed to provide reasonable protection against harmful interference in a residential installation. This equipment generates, uses, and can radiate radio frequency energy. If not installed and used in accordance with the instructions, it may cause harmful interference to radio communications. However, there is no guarantee that interference will not occur in a particular installation.

If this equipment does cause harmful interference to radio or television reception, which can be determined by turning the equipment off and on, the user is encouraged to try and correct the interference by one or more of the following measures:

1. Reorient or relocate the receiving antenna.
2. Increase the distance between the equipment and the receiver.
3. Connect the equipment to an outlet on a circuit different from the one the receiver is connected to.
4. Consult the dealer or an experienced radio/TV technician for help.

## FCC Radio Frequency Exposure statement

This Wireless LAN radio device has been evaluated under FCC Bulletin OET 65C and found compliant with the requirements as set forth in CFR 47 Sections 2.1091, 2.1093, and 15.247 (b) (4) addressing RF Exposure from radio frequency devices. The radiated output power of this Wireless LAN device is far below the FCC radio frequency exposure limits. Nevertheless, this device shall be used in such a manner that the potential for human contact during normal operation is minimized. When using this device, a certain separation distance between antenna and nearby persons must be maintained to ensure RF exposure compliance. In order to comply with RF exposure limits established in the ANSI C95.1 standards, the distance between the antennas and the user should not be less than 20 cm (8 inches).

## Export restrictions

This product or software contains encryption code which may not be exported or transferred from the US or Canada without an approved US Department of Commerce export license. This device complies with Part 15 of FCC Rules., as well as ICES 003 B / NMB 003 B. Operation is subject to the following two conditions: (1) this device may not cause harmful interference, and (2) this device must accept any interference received, including interference that may cause undesirable operation. Modifications not expressly authorized by Fujitsu PC Corporation may invalidate the user's right to operate this equipment.

## Before Using This Device

Thank you for purchasing a Fujitsu LT800P tablet with the optional Integrated Wireless LAN. This manual describes the basic operating procedures for the Wireless LAN (referred to as the “device” in this manual) and how to set up a wireless LAN network. Before using this device, read this manual carefully to ensure correct operation of the device. Keep this manual in a safe place for reference while using the device.

## Characteristics of the Device

This device consists of a wireless LAN card that is attached to the computer via a mini-PCI slot.

The main characteristics are as follows:

- It uses the power saving communications system in the 2.4 GHz band, and does not require any license for radio communication.
- It uses Direct Sequence Spread Spectrum (DS-SS), which is resistant to noise.
- This device complies with Wi-Fi, and is able to communicate at the maximum transfer rate of 11 Mbps.
- The maximum communication range is approximately 120 feet (36.5 meters) inside a building. The range may be shorter depending upon the installation factors, such as walls and columns.
- Unauthorized access can be prevented with the use of SSID and encryption key.

## Wireless LAN Modes Using this Device

### AdHoc Mode

The “AdHoc Mode” refers to the network connecting two computers using wireless LAN cards. This connection is called an “AdHoc network.”

Using an AdHoc network, you can obtain a network connection easily and at a low cost.

In the AdHoc mode, you can use the function supported by Microsoft Network, such as File and Print Sharing to exchange files and share a printer or other peripheral devices.

To use the AdHoc Mode, you must set the same SSID and the same encryption key for all the computers that are connected. All connected computers can communicate with each other within the communication range.

## Infrastructure Mode

If a number of computers are connected simultaneously in the AdHoc mode, the transfer rate may be reduced, communications may become unstable, or the network connection could fail. This is because all wireless LAN cards are using the same radio frequency in the network.

To improve this situation, you can use a wireless LAN access point, which is sold separately. The wireless LAN network is in the “Infrastructure mode” when it uses an access point, and such a connection is called the “Infrastructure Network.”

By using an access point, you can set and use a different communication channel for each network group. Each channel is given a different radio frequency, and it eliminates the collision of communications and provides a more stable communications environment. Infrastructure mode is most suitable when you are configuring multiple wireless LAN networks on the same floor.

To connect a wireless LAN network to a wired LAN, you need an access point.

## How to Handle This Device

The optional Integrated Wireless LAN device is already installed in Stylistic LT800P tablet computers that have been so configured. Under normal circumstances, it should not be necessary for you to remove or re-install it. The LAN has been configured to support the operating system with which your system shipped.

The On/Off switch located on the Wireless LAN cover turns the device on and off. You should switch the device off when it is not in use in order to maximize battery life.



## Connecting Windows 2000 Systems

This chapter describes how to set the wireless LAN connection for computers running Windows 2000.



If you purchased a Stylistic LT800P tablet with the optional integrated wireless LAN device, the device and drivers have already been installed. This procedure outlines the steps for setting the device parameters.

Updated drivers and/or utilities may become available after this manual is printed; see any addenda or fliers that may be included in the system packaging.

### Workflow

The proper setup of the wireless LAN requires several steps which must be performed in the proper order. Following is a general outline of the steps that must be performed. Each step is detailed later in this procedure.

1. Setting parameters
  - Setting the profile
  - Setting the encryption
2. Network settings
  - Setting the protocol and checking the network
  - Setting file and printer sharing
  - Checking the connection

### Setting Parameters

1. Click [Start]-> [Settings] -> [Control Panel].
2. Double-click the [PRISM Settings] icon. The [PRISM Wireless Settings] appears.
3. Set the profile as specified in Table 1. Ask your network administrators to check the setting.
4. When you finish your entry, click [Apply].

Item	Description
Profile	Enter the system file name in which the parameter information is to be saved.
Mode	<i>Ad Hoc Network:</i> Click the down arrow and select "802.11 AdHoc". <i>Infrastructure Network:</i> Click the down arrow and select "Infrastructure".
SSID	Enter the network name to which you want to connect
Transmit Rate	Obtain the information from your network administrator. If you do not have a network administrator, select "Fully Automatic".
Power Save Enabled	Not supported.
AdHoc Channel	<i>AdHoc Network:</i> Select the same channel, 1-11, for all connected computers. If there is more than one wireless LAN nearby (such as on the same floor), we recommend that the channels for each LAN be 5 numbers apart (e.g., if there are two other LANs nearby, the channels used should be 1, 6, and 11). <i>Infrastructure Network:</i> Not an option.

Table A-1 Profile Parameters

5. Click the [Encryption] tab.
6. Set the encryption items in accordance with Table 2.
  - AdHoc Network: Specify the same value for all the computers for which the encryption key is used for connection.
  - Infrastructure Network: Specify the identical encryption keys to the encryption keys set for the access point. For instructions on how to check the encryption keys set for the access point, refer to the access point manual.



Make sure that you specify the encryption keys. If you do not specify the keys, any computer with a wireless LAN card can be connected. This presents a risk that your data may be stolen or destroyed.

Item	Description
Encryption (WEP)	<p>Click the down arrow and select an encryption option.</p> <ul style="list-style-type: none"> <li>▪ <i>Disable</i>: Disables the encryption. In this case, "Create keys with Passphrase" and subsequent items are greyed out, and you cannot enter anything.</li> <li>▪ <i>40 bit*</i>: The encryption is set. Select either "Create keys with Passphrase", "Create keys manually", or "ASCII Input", and enter the encryption keys.</li> <li>▪ <i>104 bit*</i>: The encryption is set. Select either "Create keys with Passphrase", "Create keys manually", or "ASCII Input", and enter the encryption keys.</li> </ul>
Create Keys with Passphrase	Not supported.
Passphrase	Not supported.
Create Keys Manually (Hexadecimal Input)	<p>Select this to use hexadecimal character codes to set the encryption keys (Keys 1 - 4).</p> <p>Enter a 10-digit value when you have selected [40 bit]* for the encryption. Enter a 26-digit value when you have selected [104 bit]* for encryption.</p> <p>Select if the network contains a card that is set with the encryption key using the character code. Specify the encryption keys with the same value used for other wireless LAN cards that are already set.</p>
ASCII Input	<p>Select to use the ASCII codes to set encryption keys (Keys 1 - 4). Select this if network does not contain other wireless LAN cards that are set with encryption key using character codes.</p> <p>Enter a 5-digit value when you have selected [40 bit]* for the encryption. Enter a 13-digit value when you have selected [104 bit]* for encryption.</p> <p>You can use the following characters: 0 - 9, A - Z, a - z, _ (underscore).</p> <p>For example, to set "ABC12" for the encryption key, enter "ABC12."</p>
Default Key	Click the down arrow, and select a key from Keys 1 - 4.

Table A-2 Encryption Key Setup

7. When you finish your entry, click [Apply].
  8. Click [OK]. [PRISM Wireless Settings] closes.
- You have completed the parameter settings.



When using ADSL (PPPoE) with the infrastructure network to connect to the Internet, you must change the computer's MTU size set. To change MTU size, refer to the manual that comes with the access point.

\* 40 bit and 104 bit encryption is the wireless LAN equivalent of 64 bit and 128 bit encryption, as set by Microsoft and wireless LAN manufacturers. This is the same encryption rate that is used by the Windows XP operating system, and was selected in order to align it closer to the wireless LAN standard. For consistency, the Windows 2000 utilities reflect the same modes.

Outside of wireless LAN environments, encryption is generally set at either 64 bit or 128 bit. However, the wireless LAN standard requires that 24 bits be reserved for fixed data. As a result, the user can only use 40 bits (64 minus 24) or 104 bits (128 minus 24) for encryption. This requirement also fixes the number of characters used for 128 bit encryption to 13 which is calculated as  $(13 \times 8 \text{ bits} = 104)$ .

## Network Connection: Windows 2000

The section describes how to set the network connection for a computer with Windows 2000.

### Network Settings

In this section, you set "TCP/IP Settings," and complete "Checking Computer Name and Workgroup," required for the network connection.

#### TCP/IP Settings

1. Click [Start] -> [Settings] -> [Control Panel].
2. Double-click the [Network and Dial-up Connections] icon. The [Network and Dial-up Connections] window appears.
3. Right click the [Local Area Connection], then click [Properties] from the menu that appears. The [Local Area Connection Properties] window appears.



More than one network adapter is installed in your system if more than one [Local Area Connection] entry is displayed. In this case, select the [Local Area Connection] entry with [Intersil PRISM Wireless LAN PCI Card] displayed under [Device Name].

4. Perform the following steps.
  - Click [Internet Protocol (TCP/IP)].
  - Click [Properties]. The [Internet Protocol (TCP/IP) Properties] window appears.
5. Set an IP address as indicated in Table 3. Ask your network administrator to check the setting.

Item	Description
For AdHoc Network	Set the IP address and subnet mask: Click [Use the following IP address], and enter a value for [IP address] and [Subnet mask]. Refer to “Setting IP Addresses” on page 94 to set an IP address and subnet mask.
For Infrastructure Network	Select [Obtain an IP address automatically]: For the DNS server, select [Obtain DNS server address automatically]. For the IP address, DNS server, and default gateway, follow the network administrator's instructions, if any.

*Table A-3 Setting an IP Address*

6. Click [OK]. The [Local Area Connection Properties] window appears again.
7. Click [OK]. When a message appears prompting you to restart the computer, click [Yes].

### Checking the full computer name and workgroup

1. Click [Start] -> [Settings] -> [Control Panel].
2. Double-click the [System] icon. [System Properties] appears.
3. Click the [Network Identification] tab.
4. Check [Full computer name] and [Workgroup]. Ask your network administrator and check the setting.

Item	Description
Full Computer Name	A name to identify the computer on the network. You can specify any name to each computer. For easier identification, use the model name or user name.
Workgroup	A name for the network group: <ul style="list-style-type: none"> <li data-bbox="322 499 925 576">▪ <i>AdHoc Network:</i> Specify the same name to all computers within the same network.</li> <li data-bbox="322 595 958 624">▪ <i>Infrastructure Network:</i> Specify a workgroup name to connect to.</li> </ul> To change the setting, click [Properties], and follow the instructions on the screen. [System Properties] appears again.

*Table A-4 Checking computer name and workgroup*

5. Click [OK]. When a message appears prompting you to restart the computer, click [Yes].

## Sharing

In this section, you set sharing of the drive, folder, and printer.

You only need to set this when you are sharing files or a printer with other computers on the network.

When you share a drive, folder, or printer, you can use them from any computer on the network.

### Setting [File and Printer Sharing for Microsoft Networks]

1. Click [Start] -> [Settings] -> [Control Panel].
2. Double-click the [Network and Dial-up Connections] icon. The [Network and Dial-up Connections] windows appears.

3. Right click the [Local Area Connection], then click [Properties] from the menu that appears. [Local Area Connection Properties] appears.



More than one network adapter is installed in your system if more than one [Local Area Connection] entry is displayed. In this case, select the [Local Area Connection] entry with [Intersil PRISM Wireless LAN PCI Card] displayed under [Device Name].

4. If [File and Printer Sharing for Microsoft Networks] is displayed in the list, make sure that it is checked. If it is not checked, check it and click [OK]. You do not have to perform the following steps. Go to the next section, entitled “Sharing Files.”  
If [File and Printer Sharing for Microsoft Networks] is **not** found in the list, click [Install], and perform Step 5 and subsequent steps. When you click [Install], the [Select Network Component Type] window appears.
5. Perform the following steps.
  - Click [Service].
  - Click [Add]. The [Select Network Service] window appears.
6. Perform the following steps.
  - Click [File and Printer Sharing for Microsoft Networks].
  - Click [OK]. You will go back to [Local Area Connection Properties], and [File and Printer Sharing for Microsoft Networks] is added to the list.
7. Click [OK].



If you have changed the setting, [Close] is shown instead. Click [Close].

## Sharing Files

The following example shows how to set sharing the “Work” folder on the c: drive.

1. On the desktop, double-click [My Computer]-> C: drive.
2. Right-click the “Work” folder, then click [Sharing] from the menu. The [Work Properties] window appears.
3. Click [Share this folder] and set necessary items, as indicated in Table 5.

Item	Description
Share name	You can specify a share name for the drive or folder that you want to share.
Comment	You can enter the description for the drive or folder that you want to share.
User limit	Specifies the limit for the number of sharing users.
Permissions	Specifies the folder access privileges.
Caching	Specifies the caching for the folder.

*Table A-5 Sharing files*

4. Click [OK]. The folder is set shared, and the “Work” folder icon changes.

### Printer Sharing

1. Click [Start] -> [Settings] -> [Printers]. The Printers window appears, showing the printers that are connected.
2. Right click the printer that you want to share, then click [Sharing] from the menu that appears.
3. Click [Sharing], and select necessary items.

Item	Description
Not Shared	Disables printer sharing.
Shared As	Enables printer sharing.
Share Name	Specifies a share name of the printer to be shared.
Comment	Enter the description of the printer to be shared.
Passwords	If you specify a password, you need to enter it when using the printer.

*Table A-6 Printer Sharing*

4. Click [OK]. The printer sharing is set, and the icon changes.



## Checking the Connection

After the network setting is completed, access the shared drive on another computer to check the connectivity of the wireless LAN network.

### Accessing Another Computer

1. Double-click the [My Network Places] icon on the desktop. [My Network Places] appears.
2. Double-click [Computers near me]. The computers that are connected to the network are displayed.
3. Double-click the computer that you want to access. The drive that you set with “Sharing” are displayed.
4. Double-click the drive that you want to access. The drive is displayed showing its contents and made available to you. If you have any questions or problems, refer to “Troubleshooting Table” on page 88.

## Checking the Connectivity

1. Click [Start] -> [Settings] -> [Control Panel].
2. Double-click the [PRISM Settings] icon. [PRISM Wireless Settings] appears.
3. Check the connectivity on the [Link] tab. The current condition of connection is displayed.

Item	Description
State	Shows the current condition of connection. The MAC address of the other computer to which you are connected is displayed when the connection is successful. If you are connected to more than one computer, the computer that has the best connectivity is displayed.
Current Channel	Shows the current channel used for the connection.
Current Tx Rate	Shows the current transfer rate in Mbits/sec.
[Radio Off]/ [Radio On]	Click [Radio Off] to disconnect. Click [Radio On] to connect to the network.
[Rescan] button	Click this button to search for others to connect to.
Throughput (Bytes/sec)	Shows the actual transfer rate of the data transfer for send (Tx) and receive (Rx).
Link Quality	Shows either [Excellent], [Good], [Fair], [Poor], or [Not Connected], depending on the link quality. Not shown for AdHoc connection.
Signal Strength	Shows either [Excellent], [Good], [Fair], [Poor], or [Not Connected], depending on the signal strength. Not shown for AdHoc connection.

*Table A-7 Checking connectivity*

## Connecting Windows XP Systems

This chapter describes how to set up the wireless LAN connection for computers that are running Windows XP.



If you purchased a Stylistic LT800P tablet with the optional integrated wireless LAN device, the device and drivers have already been installed. This procedure outlines the steps for setting the device parameters.

Updated drivers and/or utilities may become available after this manual is printed; see any addenda or fliers that may be included in the system packaging.

### Workflow

The proper setup of the wireless LAN connection requires that several steps be performed in the proper order. Following is a general outline of the steps to be performed. Each step is detailed later in this procedure.

1. Setting parameters
  - Setting the profile
  - Setting the encryption
2. Network settings
  - Setting the protocol and checking the network
  - Setting file and printer sharing
  - Checking the connection

### Setting Parameters

1. Click [Start] -> [Control Panel].
2. Click [Network and Internet connections].
3. Click [Network connection]. A list of networks that are currently installed is displayed.
4. Right click [Intersil PRISM Wireless LAN PCI Card] in the list, and click [Properties] from the menu that is displayed. [Wireless Network Connection Properties] appears.
5. Click the [Wireless Networks] tab. The [Wireless Networks] tab appears.

6. Perform the following steps.
  - Make sure that [Use Windows to configure my wireless network settings] is checked.
  - Click [Add] under [Preferred networks]. [Wireless Network Properties] appears.
7. Set parameters in accordance with Table 8.
  - For the AdHoc network, specify the same value to all the computers, for which the encryption key is used for connection.
  - For the infrastructure network, specify the encryption key (network key) with the same value to the encryption key of the access point. For how to check the encryption keys set for the access point, refer to the manual supplied with the access point.



Be sure to specify the encryption keys. If you do not specify the keys, any computer with a wireless LAN card can be connected. This presents a risk that other users may steal or destroy your data.

Item	Description	
Network Name SSID	<p>Enter the network name to which you want to connect. This is a required item. For the network name, ask your LAN administrator.</p> <p><i>AdHoc network:</i> Set the same name for all of the computers that are to be connected.</p> <p><i>Infrastructure network:</i> Specify the same name as that specified on the access point that is to be connected. For access point instructions, refer to the manual that comes with the access point.</p>	
Key Format	Click the down arrow and select the input for the Network key.	
	<p>ASCII characters</p>	<p>Select this when using ASCII characters for the Network Key. Characters that can be used follow:</p> <p>0-9, A-Z, a-z, and _ (underscore)</p> <p><i>Example:</i> To set the key to "ABC12", input "ABC12".</p>
<p>Hexa-decimal characters</p>	<p>Select this when using hexadecimal characters for the Network Key.</p> <p>Use this if there is a wireless LAN card in the network that has the Network Key set to a character code. In 'Network Key', input the same value as the other wireless LAN card.</p>	

**Table A-8** Setting parameters

8. When you finish your entry, click [OK]. [Wireless Network Connection 2 Properties] appears again.
9. Make sure the network name you specified for the SSID in Step 7 is added under [Preferred networks].

## Network Connection

The section describes how to set the network connection for a computer running Windows XP.

### Network Settings

In this section, you set “TCP/IP Settings,” and complete “Checking Computer Name and Workgroup” required for the network connection.

### TCP/IP Settings

1. On [Wireless Network Connection Properties], click [General].



If [Wireless Network Connection 2 Properties] is not displayed, click [Start] -> [Settings] -> [Control Panel], and double-click the [Network Connection] icon.

Right click the [Wireless Network Connection], and then click [Properties] from the menu that appears.

2. Perform the following steps.
  - Click [Internet Protocol (TCP/IP)].
  - Click [Properties]. [Internet Protocol (TCP/IP) Properties] appears.
3. Set an IP address. Ask your network administrator and check the setting.

Item	Description
AdHoc Network	Set the IP address and subnet mask. Click [Use the following IP address]. Enter a value for [IP address] and [Subnet mask]. See “Setting IP Addresses” on page 94 to set IP address and subnet mask.
For Infrastructure Network	Select [Obtain an IP address automatically]. For the DNS server, select [Obtain DNS server address automatically]. For the IP address, DNS server, and default gateway, follow the network administrator’s instructions, if any.

*Table A-9 Setting an IP address*

5. Click [OK].



If you have changed the setting, [Close] is shown instead. Click [Close].

6. Close [Network Connection].

### Checking the Full Computer Name and Workgroup

1. Click [Start] -> [Control Panel]. Make sure the Classic View is selected.
2. Double-click the [System] icon. [System Properties] appears.
3. Click the [Computer Name] tab.
4. Check [Full computer name] and [Workgroup]. Ask your network administrator and check the setting.

Item	Description
Computer Name	A name to identify the computer on the network. You can specify any name to each computer. Use up to 15 single-byte characters. For easier identification, use the model name or user name.
Workgroup	A name of the network group. Use up to 15 single-byte characters. <i>AdHoc Network:</i> Specify the same name to all computers within the same network. <i>Infrastructure Network:</i> Specify workgroup name to connect to.

**Table A-10** *Setting computer name and workgroup*

To change the setting, click [Change], and follow the instructions on the screen. [System Properties] appears again.

5. Click [OK]. When a message appears prompting you to restart the computer, click [Yes].

### Sharing

In this section, you set sharing of the drive, folder, and printer.

You need to set this only when you are sharing files or a printer with other computers on the network.

When you share a drive, folder, or printer, you can use these from any computer on the network.

## Setting [File and Printer Sharing for Microsoft Networks]

1. Click [Start] -> [Control Panel]. Make sure the Classic View is selected.
2. Double-click the [Network Connection] icon.
3. Right click the [Wireless Network Connection], and then click [Properties] from the menu that appears. [Wireless Network Connection Properties] appears.
4. If [File and Printer Sharing for Microsoft Networks] is displayed in the list:
 

Make sure that it is checked. If it is not checked, check it, and click [OK]. You do not have to perform the following steps. Go to the next section, “Sharing Files.”

If [File and Printer Sharing for Microsoft Networks] is **not** found in the list, click [Install], and perform Step 5 and the subsequent steps. When you click [Install], [Select Network Component Type] appears.
5. Perform the following steps.
  - Click [Service].
  - Click [Add]. [Select Network Service] appears.
6. Perform the following steps.
  - Click [File and Printer Sharing for Microsoft Networks].
  - Click [OK]. You will go back to [Wireless Network Connection 2 Properties], and [File and Printer Sharing for Microsoft Networks] is added to the list.
7. Click [Close].

## Sharing Files

The following example shows how to set sharing the “Work” folder on the c: drive.

1. Click [Start] -> [My Computer].
2. Double-click the [Local Disk (c:)] icon.
3. Right click the “Work” folder, and then click [Sharing and Security] from the menu that appears. [Work Properties] appears.
4. Click [If you understand the security risks but want to share files without running the wizard, click here].



If you have already clicked [If you understand the security risks but want to share files without running the wizard, click here], this window does not appear.

In the [Work Properties] window, the description under [Network Sharing and security] changes.

5. Check [Share this folder on the network]. Uncheck [Allow network users to change my files], if the shared folder is for read only.
6. Click [OK]. The folder is set shared, and the “Work” folder icon changes.

## Printer Sharing

1. Press [Start]->[Control Panel] (or [Settings], if viewing in Classic mode)-> [Printers and Faxes]. The Printers and Faxes display will appear and the connected printers will be displayed.
2. Right-click the printer to be shared, and click [Sharing] from the menu that appears. The properties of the printer to be shared will be displayed. Set printer sharing.

On the display, the printer sharing setting is recommended by the Network Setup Wizard, but for the wireless LAN network, security is maintained by network name (SSID) or network key. The following steps allow you to set up printer sharing without using the Network Setup Wizard.

3. Click 'If you understand the security risks but want to share printers without running the wizard, click here. 'Enable Printer Sharing' will be displayed.
4. Select 'Just enable printer sharing'.
5. Click 'OK'. The printer properties will be indicated.
6. Select 'Share this printer'.
7. Enter the sharing printer name in 'Share name'.
8. Click 'OK'. The printer will be shared, and the printer icon will become a sharing icon.

## Checking the Connection

After the network setting is completed, access the shared drive on another computer to check the connectivity of the wireless LAN network.

## Accessing Another Computer

1. Click [Start] -> [My Computer].
2. From the left menu in [Other Places], click [My Network Places].
3. From the left menu in [Network Tasks], click [View workgroup computers]. The workgroup in which you are participating will appear.
4. Double click the computer to which you want to connect. The drive that you set in [Computer Sharing] appears.
5. Double click the drive to which you want to connect. The contents of the drive will appear, and is available for use.

If you have a question or problem, refer to “Troubleshooting Table” on page 88.



## Checking the Connectivity

1. Click [Start] -> [Control Panel].
2. Double-click the [PRISM Settings] icon. [PRISM Wireless Setting] appears.
3. Check the connectivity on the [Link] tab. The current condition of connection is displayed.

Item	Description
State	Shows the current condition of connection. The MAC address of the other computer that you are connected to is displayed, when the connection is successfully made. If you are connected to more than one computer, the computer that has the best connectivity is displayed.
Current Channel	Shows the current channel used for the connection.
Current Tx Rate	Shows the current transfer rate in Mbits/sec.
Radio Off/Radio On	Click [Radio OFF] to disconnect. Click [Radio On] to connect to the network.
Rescan	Click this button to search for others to connect to.
Throughput (Bytes/sec)	Shows the actual transfer rate of the transfer data for send (Tx) and receive (Rx).
Link Quality	Shows the link quality. This is not shown for the AdHoc connection.
Signal Strength	Shows the signal strength. This is not shown for the AdHoc connection.

*Table A-11 Checking connectivity*

## Troubleshooting

This section contains troubleshooting information, including causes and actions, for problems you may find while using this device.

### Troubleshooting Table

Problem	Possible Cause	Possible Solution
An exclamation mark (!) or cross (x) is attached to [Intersil PRISM Wireless LAN PCI Card].	A failure to recognize the device.	Restart the computer.
	A failure in installing the driver.	Restart the computer.
Other computers are not displayed when the [Network Computer] icon is double-clicked.	The network has not been set up correctly.	Check the setting for the protocol, workgroup, and sharing.  To check this, you need a different procedure, depending upon the operating system that you use. Refer to the appropriate section of this chapter.
	It takes time before the network is searched and the computer connected is displayed.	Perform the following steps to search for the computer. <ul style="list-style-type: none"> <li>▪ Click [Start] -&gt; [Search] -&gt; [Other Computers].</li> <li>▪ Enter the computer name that you are connecting to in [Name], and click [Search].</li> <li>▪ Double-click the icon of the computer that has been searched.</li> </ul>
	A failure in installing the driver.	Make sure that the driver is correctly installed.
	The TCP/IP protocol is not installed, or, the IP address is not set correctly.	Make sure that the TCP/IP protocol is installed. To check this, you need a different procedure, depending on the operating system that you use. Refer to the appropriate section of this manual.

Problem	Possible Cause	Possible Solution
<p>Other computers are not displayed when the [Network Computer] icon is double-clicked.</p> <p>(continued)</p>	<p>The TCP/IP protocol is not installed, or, the IP address is not set correctly.</p>	<p>If the TCP/IP protocol is installed, do the following to check the IP address:</p> <ol style="list-style-type: none"> <li>1. Windows 2000: Click [Start] -&gt; [Programs] -&gt; [Accessories] -&gt; [Command Prompt]. Windows XP: Click [Start] -&gt; [All Programs] -&gt; [Accessories] -&gt; [Command Prompt].</li> <li>2. Enter "IPCONFIG" command, and press [Enter].  (If your hard disk is C drive, enter C:\&gt;ipconfig)</li> </ol> <p>Check that the IP address is correctly displayed under the IP Address.</p> <p>Example: IP address: 10.0.1.3 Subnet Mask: 255.255.255.0 Default Gateway: 10.0.1.1</p>
	<p>No communication due to poor radio signal.</p>	<p>Shorten the distance between computers or remove visible obstacles between them, and retry the connection.</p>

Problem	Possible Cause	Possible Solution
IP packet isn't reaching its destination	Run the PING command to check the connection	<p>Perform the following steps to run the PING command to check if the IP packet is correctly delivered to the destination.</p> <p>To run the PING command, the TCP/IP protocol must be installed. First you will determine your IP address, then you will make sure your IP address can respond, and then you will make sure other computers can be addressed.</p> <ol style="list-style-type: none"> <li>1. Windows 2000: Click [Start] -&gt; [Programs] -&gt; [Accessories] -&gt; [Command Prompt]. Windows XP: Click [Start] -&gt; [All Programs] -&gt; [Accessories] -&gt; [Command Prompt].</li> <li>2. Type: ipconfig &gt; <i>directory</i>\<i>filename</i> where <i>directory</i> and <i>filename</i> represent the location at which you want to store the IP address.</li> <li>3. Click [Enter], then go to the location you specified above. The IP address for your system will be contained in the file.</li> <li>4. To check that your IP address is functioning properly, go back to the DOS prompt and type: ping &lt;IP address&gt;, then press [Enter]. You will receive several replies, followed by the PING statistics (similar to below).</li> <li>5. To check that your system is communicating with other systems, go to the DOS prompt and type: &gt;ping XXX.XXX.XXX.XXX. (With the destination IP address in place of XXX.XXX.XXX.XXX).</li> </ol> <p style="text-align: right;">(continued on next page)</p>

Problem	Possible Cause	Possible Solution
<p>IP packet isn't reaching its destination</p> <p>(continued)</p>		<p>Example: if the destination IP address is 10.0.1.3:</p> <pre>C:\&gt;ping 10.0.1.3</pre> <p>A message similar to the following appears if the connection is successful.</p> <p>Pinging 10.0.1.3 with 32 bytes of data:</p> <pre>Reply from 10.0.1.3: bytes=32 time=1ms TTL=32</pre> <pre>Reply from 10.0.1.3: bytes=32 time&lt;10ms TTL=32</pre> <pre>Reply from 10.0.1.3: bytes=32 time=4ms TTL=32</pre> <pre>Reply from 10.0.1.3: bytes=32 time&lt;10ms TTL=32</pre> <p>If the connection fails, [Request timed out], [Destination host unreachable], or a similar message appears. In this case, refer to the "Other computers are not displayed" portion of this chapter.</p>
<p>Cannot connect to the network</p>	<p>There are several possible causes, as listed to the right. Refer to the specific section of this manual or your user's manual.</p>	<p>The following causes are possible. Check each one of them.</p> <ul style="list-style-type: none"> <li>▪ The network name or encryption key is not right.</li> <li>▪ The driver has not correctly started.</li> <li>▪ The destination computer is not turned on.</li> <li>▪ You do not have the access privilege to the destination computer.</li> <li>▪ The card has failed.</li> <li>▪ Hardware conflict.</li> </ul>

Problem	Possible Solution
<p>I want to remove the driver (Windows 2000)</p>	<p><b>Windows 2000:</b> When removing the driver, make sure the device is attached to the computer. If you try to remove the driver while the device is detached from the computer, the driver is not removed.</p> <ol style="list-style-type: none"> <li>1. Right click the [My Computer] icon on the desktop, and then click [Properties] from the menu that appears. [System Properties] appears.</li> <li>2. Click the [Hardware] tab.</li> <li>3. Click [Device Manager...]. The [Device Manager] window appears.</li> <li>4. Click [+] beside [Network adapters].</li> <li>5. Right click [Intersil PRISM Wireless LAN PCI Card], and click [Uninstall] from the menu that is displayed. [Confirm Device Removal] appears.</li> <li>6. Click [OK].</li> <li>7. Close [System Properties]. Make sure the icon disappears from the task tray in lower right corner of the screen.</li> <li>8. Click [Start] -&gt; [Settings] -&gt; [Control Panel].</li> <li>9. Double-click [Add/Remove Programs]. [Add/Remove Programs] appears.</li> <li>10. Perform the following steps. <ul style="list-style-type: none"> <li>▪ Click [PRISM 11Mbps Wireless LAN for Windows].</li> <li>▪ Click [Change/Remove].</li> </ul> </li> <li>11. A window appears asking you if you really want to remove the driver.</li> <li>12. Click [Yes]. When the driver is removed, a window appears showing that the driver has been removed.</li> <li>13. Click [OK].</li> <li>14. Close [Add/Remove Programs] and [Control Panel].</li> <li>15. Shut down Windows, and turn off the computer.</li> </ol>

Problem	Possible Solution
<p>I want to remove the driver (Windows XP)</p>	<p><b>Windows XP:</b> When removing the driver, make sure that the device is attached to the computer. If you try to remove the driver while the device is detached from the computer, the driver is not removed.</p> <ol style="list-style-type: none"> <li>1. Click [Start], right click [My Computer], and then click [Properties] from the menu that appears. [System Properties] appears.</li> <li>2. Click the [Hardware] tab.</li> <li>3. Click [Device Manager].</li> <li>4. Click [+] beside [Network adapters].</li> <li>5. Right click [Intersil PRISM Wireless LAN PCI Card], and click [Uninstall] from the menu that is displayed. [Confirm Device Removal] appears.</li> <li>6. Click [OK].</li> <li>7. Close [System Properties].</li> <li>8. Make sure that the icon has disappeared from the task tray in the lower right corner of the screen.</li> <li>9. Click [Start] -&gt; [Control Panel]. [Control Panel] appears.</li> <li>10. Double-click [Add/Remove Programs]. [Add/Remove Programs] appears.</li> <li>11. Perform the following steps. <ul style="list-style-type: none"> <li>▪ Click [PRISM 11Mbps Wireless LAN for Windows].</li> <li>▪ Click [Change/Remove].</li> </ul> <p>A window appears asking you if you really want to remove the driver.</p> </li> <li>12. Click [Yes]. When the driver is removed, a window appears showing that the driver has been removed.</li> <li>13. Click [OK].</li> <li>14. Close [Add/Remove Programs] and [Control Panel].</li> <li>15. Shut down Windows, and turn off the computer.</li> </ol>

## About IP Addresses

### Setting IP Addresses

If you are not sure how to set the IP address, refer to the following procedure.

If you have an access point (DHCP server) on the network, set the IP address as follows:

Windows 2000: [Obtain an IP address automatically]

Windows XP: [Obtain an IP address automatically]



A DHCP server is a server that automatically assigns IP addresses to computers or other devices in the network. There is no DHCP server for the AdHoc network.

---

If the IP address is already assigned to the computer in the network, ask the network administrator to check the IP address to be set for the computer.

If no access point is found in the network:

An IP address is expressed with four values in the range between 1 and 255.

Set the each computer as follows: The value in parentheses is a subnet mask.

<Example>

Computer A: 192.168.100.2 (255.255.255.0)

Computer B: 192.168.100.3 (255.255.255.0)

Computer C: 192.168.100.4 (255.255.255.0)

:

:

Computer X: 192.168.100.254 (255.255.255.0)



## Specifications

### Technical Specifications for Integrated Wireless LAN Device

Item	Description
Network Type	IEEE 802.11b
Transfer Rate	11/5.5/2/1Mbps (auto change)
Frequency Range	2,412 - 2,462 MHz
Channels	One of 11 channels is used
Card Type	Non-intelligent
VCC	Class B
Security	Network name, encryption key
Supported Operating Systems	Windows 2000 Professional, Windows XP Professional, Windows XP Tablet PC Edition
Power Current	Max: 350mA
Maximum number of units recommended for wireless LAN (AdHoc network)	10 or less



# Index

## A

AC adapter, 10  
 audio volume too low, 50  
 auto adapter, 10

## B

battery charger, external, 10  
 battery gauge, 36  
 battery gauge icon, 28  
 battery icon, 17  
 battery pack, 10
 

- charging, 36
- charging times, 37
- critically low level, 29
- low-battery warning, 29
- no memory effect, 37
- overcharge protection, 36
- removing and installing, 37, 38
- storing in system unit, 46
- will not begin charging, 37

 battery pack (spare, 6-cell), 10  
 battery power
 

- conserving, 39
- used in suspend-to-RAM mode, 29

 battery release switch, 22  
 battery switch, 14  
 bridge battery, 39  
 brightness, 31

## C

calibrating the pen, 34  
 Charge/DC input icon, 16  
 Charging contacts, 14

charging contacts, 21  
 charging the battery pack, 36  
 compact flash slot, 40  
 configuring peripherals interface, 50  
 connectors and peripheral interfaces, 19  
 conserving battery power, 39  
 conventions used in the guide, 5  
 air flow vents, 12  
 critically low battery level, 29  
 cursor
 

- not tracking pen, 50

## D

DC adapter, 10  
 DC input connector, 20  
 DC power connector, 14  
 display
 

- screen is blank, 49

## E

external battery charger, 10  
 external floppy disk drive, 10

## F

folding deskstand, 10  
 Fujitsu contact information, 6  
 Fujitsu online, 6

## H

hard disk drive access icon, 17  
 headphone, 12  
 headphone jack, 20

hotpads, 12, 31  
hotpads, using, 31  
hovering mode, 36  
    disabling, 36  
hovering mode icon, 18

## **I**

idle state, 25  
infrared data transfer not working, 49  
infrared keyboard, 10  
infrared keyboard port, 12, 21  
interfaces  
    connectors and peripherals, 19  
IrDA port, 14, 21

## **K**

Kensington lock, 12  
keys  
    brightness, 33  
    cursor control, 32  
    display device, 32  
    escape, 32  
    numeric keypad, 32  
    NumLock, 32  
    pen hovering, 33  
    right mouse, 32  
    speaker volume, 33

## **L**

LAN jack, 14  
low-battery warning, 29

## **M**

memory cover, 14  
microphone, 12  
microphone jack, 12, 20

mini-dock, 10  
mini-dock connector  
    connector, 21  
Mini-dock interface, 14  
mini-dock port, 21  
mobile USB keyboard, 10  
Modem  
    connection, 40  
    port, 14  
modem, 21

## **O**

Off state, 25, 27  
optional accessories, 5, 10  
overheating, avoiding, 46

## **P**

PC Card  
    slot, 12, 40  
PC Card slot, 20  
pen, 12  
    not responding, 50  
    replacing, 36  
    using, 34  
peripheral connectors, 20  
portfolio case, 10  
power icon, 16, 26  
    blinking, 26, 28  
    not displayed, 26  
power usage, 25  
problems, solving, 49  
Protecting, 45

## **R**

removable battery pack, 14  
resuming system operation, 30, 49

**S**

Save-to-Disk mode, **25, 28, 30**  
 Screen protectors, **10**  
 screen protectors, **10**  
 Serial Adapter, **10**  
 shutting down the system, **27**  
 slip case, **10**  
 solving problems, **49**  
 speaker, **12**  
 status display, **15**

- battery icon, **17**
- Charge/DC input icon, **16**
- hard disk drive access icon, **17**
- hovering mode icon, **18**
- icons, **16**
- power icon, blinking, **26**
- power icon, system states indicated by, **16, 26**

 storing the system unit, **46**  
 Stylistic LT P-867
 

- features, **11, 13**
- items included with, **9**

 Stylistic LT P-867 Specifications
 

- additional, **55**
- agency approval, **55**
- environmental, **55**
- power, **55**

 Stylistic Pen, **10**  
 suspend mode, determining, **38**  
 Suspend/Resume
 

- button, **12**
- disabled, **30**

 suspend/resume button, **22**  
 suspending system operation, **27**  
 Suspend-to-RAM, **25**

- mode, **28, 30**

 system interface port, **21**  
 system states, **25, 26**

- Idle state, **25**
- Off state, **25**

- On state, **25**
- Save-to-Disk, **25**
- Suspend-to-RAM, **25**

 system status LEDs, **12**  
 system will not resume operation, **49**
**T**

troubleshooting, **49**  
 turning off the system, **27**

**U**

Universal Serial Bus, **14**  
 USB Port, **14, 20**  
 using the pen, **34**

**V**

VGA Out Adapter, **10**

**W**

warranty information, **6**  
 wireless LAN, **14**

- before using, **69**
- characteristics, **69**
- connecting Windows 2000 systems, **71**
- connecting Windows XP systems, **81**
- modes, **69, 70**
- network connection, **74**
- troubleshooting, **88**

 wireless LAN on/off switch, **14**



## Free Manuals Download Website

<http://myh66.com>

<http://usermanuals.us>

<http://www.somanuals.com>

<http://www.4manuals.cc>

<http://www.manual-lib.com>

<http://www.404manual.com>

<http://www.luxmanual.com>

<http://aubethermostatmanual.com>

Golf course search by state

<http://golfingnear.com>

Email search by domain

<http://emailbydomain.com>

Auto manuals search

<http://auto.somanuals.com>

TV manuals search

<http://tv.somanuals.com>