

SPECIFICATIONS

Standards	IMO Resolution A.817(19), IEC 61174 ed2
Display Unit	FEA-2107: MU-201CE, 20.1" color LCD, SXGA (1280 x 1024 pixels) FEA-2807: MU-231CE, 23.1" color LCD, UXGA (1600 x 1200 pixels)
Operating System	Windows XP
Useable Charts	IHO/S-57 v.3 vector chart, ARCS raster chart, C-MAP CM93 ed3* *available in the near future
Presentation Modes	True/Relative Motion Noth-up, True/Relative Motion Course-up Relative Motion Head-up, Relative Motion Route-up
Display of data	Own ship : Position, SOG, COG, Heading Route : Planned route, Monitoring route ARPA targets : Range, Bearing, Speed, Course, CPA and TCPA Others : EBL, VRM, Parallel index line, Cursor position, Navigation and pilot data notebook
Route/Waypoint	Route: more than 100 routes Waypoints: 200 waypoints/route
Voyage Calculation	The following data can be calculated Range/Bearing to destination, TTG, ETA, Fuel consumption
Route Navigation Monitoring	Off track, Waypoint, Arrival, Grounding, Depth
Alarms	Off track, Channel limit, Waypoint approach, Depth
Other Functions	Night/day presentation colors, ARPA target display, Radar overlay, User chart function, Position optimization, MOB, Log book, Pilot data function, Track control system (TCS)* * Please contact the local dealers in your area for details.
Interface	
Input/output	
AIS :	IEC 61162-2 (ABM, BBM)
Radar signal :	Ethernet 100 Base-TX or RAW Video
Input	
Gyrocompass :	IEC 61162-1 (HDT) or Synchro
SDME (Speed log) :	IEC 61162-1 (VBW) or Pulse type
EPFS :	IEC 61162-1 (GLL, GGA, VTG, ZDA, DTM)
Echo Sounder :	IEC 61162-1 (DBT, DPT)
Anemometer :	IEC 61162-1 (MWV)
Water temp Indicator :	IEC 61162-1 (MTW)
Current Indicator :	IEC 61162-1 (VDR)
Output	
Alarms :	Relay output
Printer :	Parallel

Power Supply	
Display Unit:	100 - 230 VAC, 1 ϕ , 50/60 Hz
Processor Unit:	100 - 230 VAC, 1 ϕ , 50/60 Hz
LAN Adapter:	24 VDC
B Adapter:	24 VDC
Environment (IEC 60945 test method)	
Temperature	
All Units:	-15°C to +55°C
Equipment List	
Standard	
1. Display Unit FEA-2107: MU201CE, FEA-2807: MU-231CE	1 unit
2. Control Head RCU-018 or Trackball Control Unit RCU-015 (Specify when ordering)	1 unit
3. Processor Unit EC-1000C	1 unit
4. LAN Adapter EC-1010	1 unit
5. Power Supply Cable for Processor Unit, 1.5 m	1 pc
6. Power Supply Cable for Display Unit, 1.5 m	1 pc
7. DVI Cable between Display Unit and Processor Unit, 5 m	1 pc
8. Cable between Control Unit and Processor Unit, 10 m	1 pc
9. LAN Cable, 2 m	1 pc
10. Standard Spare Parts and Installation Materials	1 set
Option	
1. LAN Adapter EC-1010	
2. B Adapter EC-1020 for equipment with analog interface	
3. Remote Control Unit RCU-016	
4. Cable between Control Unit and Remote Control Unit 03S9610, 1.5/10/20/30 m	
5. Hub HUB-100	
6. Radar Overlay Kit for FAR-21x5 series and FAR-28x5 series	
7. Video Card for Conning Display Unit	
8. Cable between Control Unit and Processor Unit, 20/30 m	
9. DVI Cable between Display Unit and Processor Unit, 10 m	
10. Armored LAN Cable OP03-186-10/20/30	
11. Printer PP-510	
12. USB-Parallel Printer Cable for PP-510	
13. Hand Grip	
14. Bracket	
15. Connection Stand	
16. Pedestal slim/standard Type	

INTERCONNECTION DIAGRAM

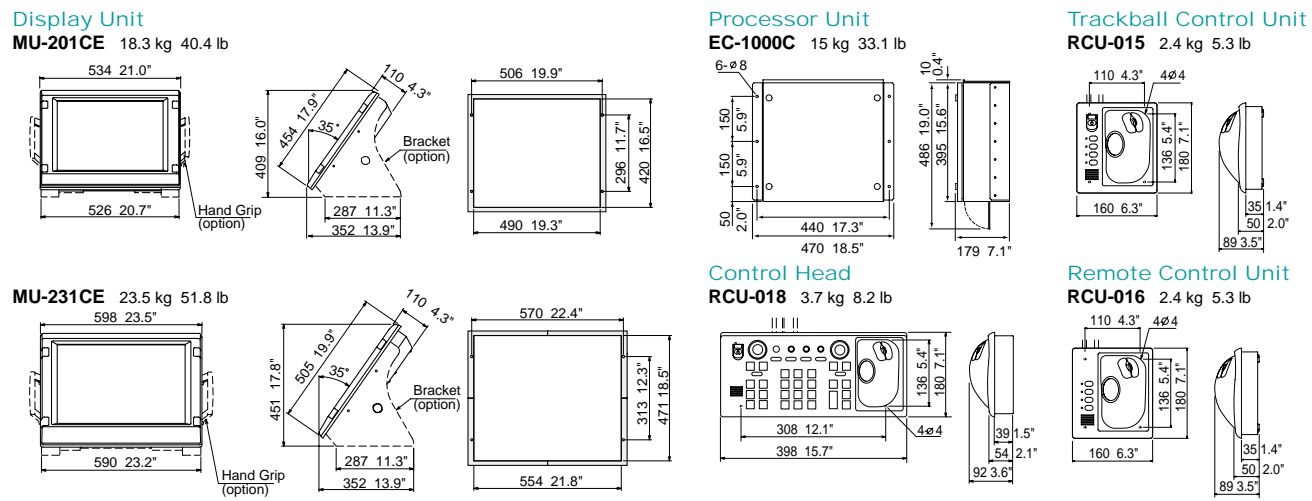
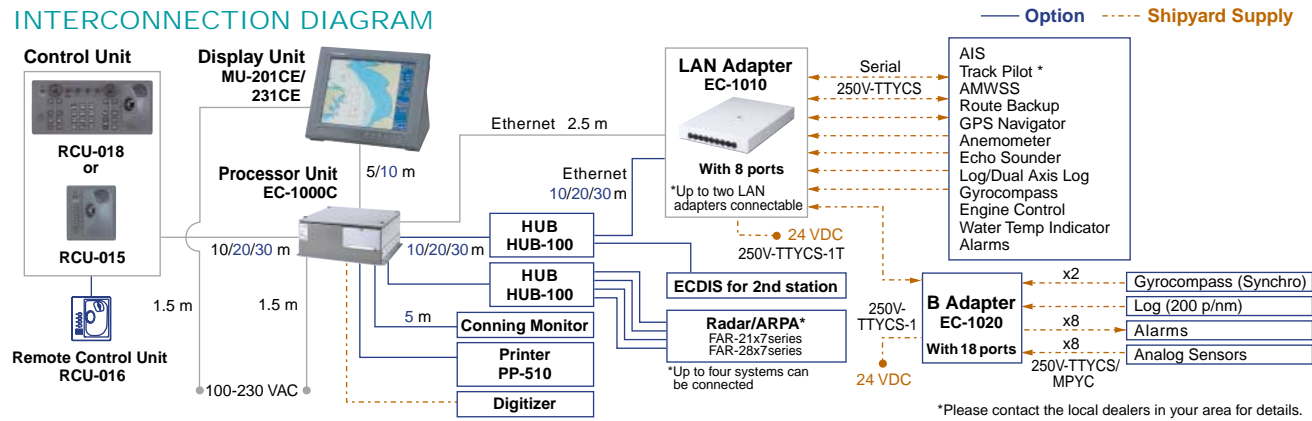

TRADE MARK REGISTERED MARCA REGISTRADA
SPECIFICATIONS SUBJECT TO CHANGE WITHOUT NOTICE

05015U Printed in Japan

FURUNO U.S.A., INC.
Camas, Washington, U.S.A.
Phone: +1 360-834-9300
Fax: +1 360-834-9400

FURUNO (UK) LIMITED
Denmead, Hampshire, U.K.
Phone: +44 2392-230303
Fax: +44 2392-230101

FURUNO FRANCE S.A.
Bordeaux-Mérignac, France
Phone: +33 5 56 13 48 00
Fax: +33 5 56 13 48 01

FURUNO ESPAÑA S.A.
Madrid, Spain
Phone: +34 91-725-90-88
Fax: +34 91-725-98-97

FURUNO DANMARK AS
Hvidovre, Denmark
Phone: +45 36 77 45 00
Fax: +45 36 77 45 01

FURUNO NORGE A/S
Ålesund, Norway
Phone: +47 70 102950
Fax: +47 70 127021

FURUNO SVERIGE AB
Västra Frölunda, Sweden
Phone: +46 31-7098940
Fax: +46 31-497093

FURUNO FINLAND OY
Espoo, Finland
Phone: +358 9 4355 670
Fax: +358 9 4355 6710

FURUNO POLSKA Sp. z o.o.
Gdynia, Poland
Phone: +48 58 669 02 20
Fax: +48 58 669 02 21

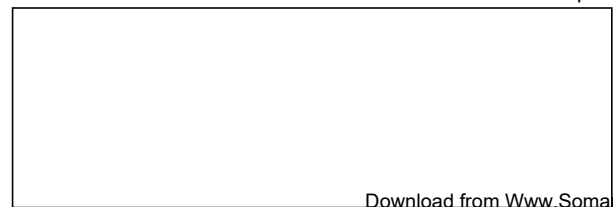

Download from www.Somanuals.com. All Manuals Search And Download.



FURUNO®

ECDIS

Electronic Chart Display and Information System

20.1" color LCD
FEA-2107

23.1" color LCD
FEA-2807



The future today with FURUNO's electronics technology.
FURUNO ELECTRIC CO., LTD.
9-52 Ashihara-cho, Nishinomiya City, Japan Phone: +81 (0)798 65-2111
Fax: +81 (0)798 65-4200, 66-4622 URL: www.furuno.co.jp

Catalogue No. L-161b

TRADE MARK REGISTERED
MARCA REGISTRADA

Obtain critical navigation information
on a state-of-the-art ECDIS
for safe and efficient travels



The FEA-2107 and FEA-2807 are FURUNO's new ECDIS (Electronic Chart Display and Information System), which have been designed to fully comply with the latest standards and resolutions set by IMO, IHO and IEC. The electronic chart is compatible with ENC (S57 Edition 3) charts, C-Map CM93 ed3* and ARCS charts (RASTER CHARTS). Where the ENC chart is not available, the ARCS chart is used instead. Instant conversion is assured, as both chart databases are stored on the ECDIS memory.

State-of-the-art technology has been utilized for high-speed stress-free data processing of chart and navigational data, which are overlaid on the chart. The navigational data includes: AIS and ARPA targets as well as a variety of other navigation information such as position, course, and speed. In the presentation of chart data, faster chart drawing and swift switching for presentation on/off of navigational data can be performed. When planning the voyage route, this gives quick route profile calculation and voyage optimization and continuous monitoring of

huge navigational data, user actions and performance of the system.

The FEA-2107/2807 can be interfaced with up to four sets of radar/ARPA FAR-21x7/28x7 by using of 100 Base-T Ethernet network. This allows high-speed data transfer and data sharing for navigational data within the network, which simplifies the system integration and the expandability of the system. The shared data can be accepted in both serial and analog format.

For the display units, the FEA-2107 uses a 20.1" SXGA LCD and the FEA-2807 uses a 23.1" UXGA LCD. These high-resolution units provide clear and sharp pictures for comfortable observation. The presentation colors can be selectable from five patterns according to the ambient conditions of the bridge area for optimal viewing around the clock. The ergonomically designed control panel consisting of a keyboard, the trackball, thumbwheel and mouse buttons facilitates intuitive and comfortable operation.

FEA-2807: 23.1" LCD



With optional pedestal

FEA-2107: 20.1" LCD



With optional mounting bracket
and connection stand

*available in the near future

ECDIS
Electronic Chart Display and Information System

► The electronic chart can be overlaid with a variety of navigation data such as Radar echo images, ship's position, heading, speed and others to facilitate safe and efficient navigation.

► Compatible with ENC (S57 Edition 3) charts, ARCS charts and C-MAP CM93 ed3*
*available in the near future

► Complies with the following IMO and IEC regulations:

- IMO A.817(19)
- IMO MSC.86(70) Annex 4
- IEC 61174 edition 2
- IEC 61162-1 edition 2
- IMO MSC.64(67) Annex 5
- IMO A.694(17)
- IEC 60945 edition 4
- IEC 61162-2 edition 1



ENC IHO S57 Edition 3

► Flexible expandability allows the ECDIS to be networked with radar/ARPA, positioning equipment, autopilot and others to consolidate the navigation system

► Displays 200 AIS targets

When connected to an optional AIS transponder, the FEA-2107/2807 can store up to 1,000 AIS targets information in its storage buffer, and displays up to 200 AIS targets within the user-defined range on the display. This provides operators with another solution for observation of other craft.



Sleeping AIS Target Activated Target Selected Target Lost Target Dangerous Target

► Streamlined design

The color scheme of the optional pedestal is a stylish pearl white and gray. The streamline design fits perfectly in the modern bridge.



Optional pedestal

► High-resolution color LCD

The use of 20.1"/23.1" high-resolution SXGA/UXGA LCDs provide crystal clear presentations of navigation information, such as marks, lines and waypoints. The LCDs also allows for installation where space is limited.

► Ergonomically designed control panel provides ease-of-use

The ergonomically designed control panel consists of a trackball, a thumbwheel and a keyboard. The logically arranged keyboard provides intuitive operation. Optionally, the compact control head only with a trackball and a thumbwheel is available for space-saving installation.



Palm control unit

► User-customizable chart drawing function

► Route planning applicable to both Mercator's sailing and great-circle sailing

► Track Control System when connected with autopilot (Option)

► Navigation data for the past 12 hours can be recorded

(The data to be recorded includes: time, ship's position, GPS correction data, ship's heading, ship's speed)

► True Motion and Relative Motion modes are available

► Navigation data is shared within an Ethernet network

The 100 Base-T Ethernet is utilized to link this ECDIS with up to four sets of radar/ARPA FAR-21x7/28x7. This link gives high-speed navigational data sharing within the system and allows operators to choose either a single station system or a total Integrated Navigation System (INS).

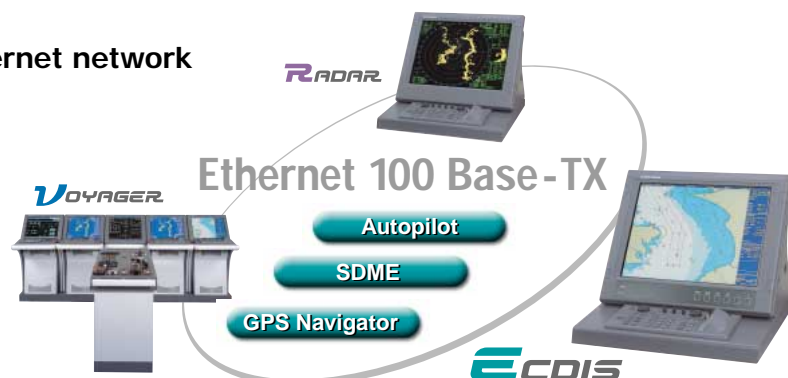

A flexible Ethernet network allows for future expandability

Navigate safely and efficiently with the ECDIS route planning and monitoring

Radar overlay

Radar echo image overlay is optionally available in the FEA-2107/2807. This function gives the exact match in scale and presentation of the chart and radar echo image. This greatly helps the operator's observation and enhances their accuracy.

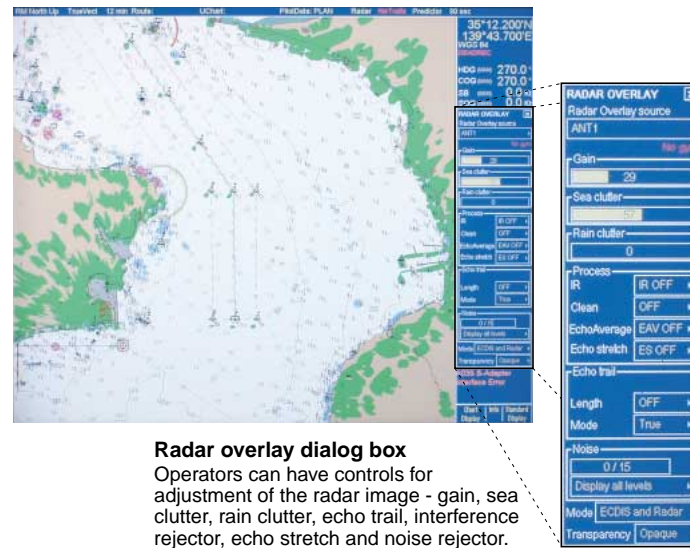

Radar overlay dialog box
Operators can have controls for adjustment of the radar image - gain, sea clutter, rain clutter, echo trail, interference rejector, echo stretch and noise rejector.

Conning display

A variety of navigation information, which is input from up to sixteen onboard sensors, can be graphically displayed on the screen. Up to eight sensors provide the analog data, and the other eight provide the serial data. The information is displayed in six predefined places where the operators can arrange the layout.



Typically, information on the conning display is received from the following sensors:

- ▶ Position sensors
- ▶ Wind sensor
- ▶ Gyro
- ▶ Rate of turn gyro
- ▶ Log/Dual-axis log
- ▶ Echo sounder
- ▶ Rudder
- ▶ Propellers
- ▶ Thrusters

Day/night presentation

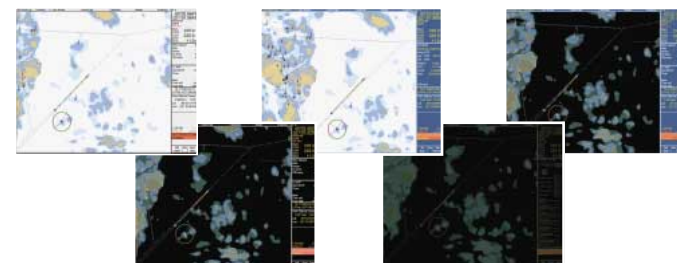

Status bar

- Presentation mode
- Vector mode and vector time
- Planned route, chart name
- Name of pilot data
- Source of target data
- Predictor time

Heading

Cursor

Own ship's marker

AIS symbol

Planned route

WTP (Waypoint)

Buoy



Own ship's information

- Ship's position
- Heading
- Course over ground (COG)
- Speed over ground (SOG)

AIS information

- Name
- IMO MMSI number
- Position
- Speed
- Course
- CPA
- TCPA
- Range

UTC

(coordinated universal time)

Cursor information, Distance and bearing between own ship and cursor



Route planning

The operators can plan and determine the precise route with ease, while studying the chart data on the screen. A route can be altered in minute detail, and the changed route can be saved for later use.



Data display

When the cursor is placed upon any mark on the electronic chart, related information about the object such as a buoy, lighthouse, sunken vessel, etc., will be shown in the data cell. Additionally, other navigational information including both own ship's navigational as well as other ship's information from ARPA can also be presented.

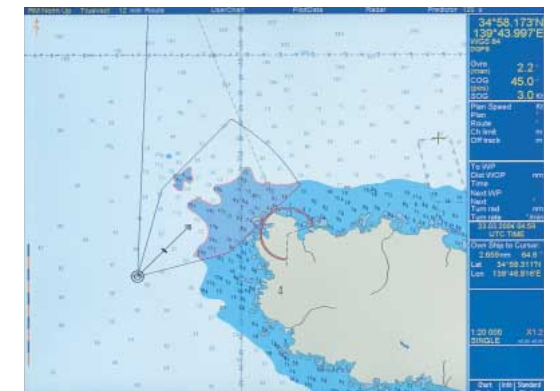

Antigrounding

This function informs the operator beforehand of shallow coastal water and other sea conditions that could contribute to the ship going aground. The information about the sea areas is acquired from the electronic chart and ship's draft data is preset in own ship's information so that possible strand can be avoided.

Free Manuals Download Website

<http://myh66.com>

<http://usermanuals.us>

<http://www.somanuals.com>

<http://www.4manuals.cc>

<http://www.manual-lib.com>

<http://www.404manual.com>

<http://www.luxmanual.com>

<http://aubethermostatmanual.com>

Golf course search by state

<http://golfingnear.com>

Email search by domain

<http://emailbydomain.com>

Auto manuals search

<http://auto.somanuals.com>

TV manuals search

<http://tv.somanuals.com>