

FURUNO

OPERATOR'S MANUAL

MARINE RADAR

MODEL FR-7062/7112/7252



FURUNO ELECTRIC CO., LTD.
NISHINOMIYA, JAPAN

© **FURUNO ELECTRIC CO., LTD.**

9-52, Ashihara-cho,
Nishinomiya, Japan

Telephone: 0798-65-2111
Telefax: 0798-65-4200

•Your Local Agent/Dealer

All rights reserved.

Printed in Japan

FIRST EDITION : APR. 1998
E : JAN. 25, 2001

(YOSH)

PUB. No. OME-34590
FR-7062/7122/7252



* 00080819800 *



SAFETY INSTRUCTIONS

DANGER



Stay away from transmitting antenna.

The radar antenna emits microwave radiation which can be harmful to the human body, particularly the eyes. Never look directly into the antenna radiator from a distance of less than 1 m when the radar is in operation.

Radio Frequency Radiation Hazard

The radar antenna emits electromagnetic radio frequency (RF) energy which can be harmful, particularly to your eyes. Never look directly into the antenna aperture from a close distance while the radar is in operation or expose yourself to the transmitting antenna at a close distance.

Distances at which RF radiation levels of 100 and 10 W/m² exist are given in the table below.

Note: If the antenna unit is installed at a close distance in front of the wheel house, your administration may require halt of transmission within a certain sector of antenna revolution. This is possible—Ask your FURUNO representative or dealer to provide this feature.

Model	Radiator type	Distance to 100 W/m ² point	Distance to 10 W/m ² point
FR7062 (X-bnd, 6 kW)	XN12A (4')	Nil	Worst case 2.5 m
	XN13A (6')		Worst case 2.3 m
FR7112 (X-bnd, 12 kW)	XN12A (4')	Worst case 0.5 m	Worst case 7.5 m
	XN13A (6')	Worst case 0.3 m	Worst case 7.0 m
FR7252 (X-bnd, 25 kW)	XN12A (4')	Worst case 0.8 m	Worst case 9.5 m
	XN13A (6')	Worst case 0.7 m	Worst case 9.0 m

⚠ DANGER



Before turning on the radar make sure no one is near the scanner unit.

Prevent the potential risk of someone begin struck by the rotating antenna and exposure to RF radiation hazard.

⚠ WARNING

Use the proper fuse.

Fuse rating is shown in the chapter 5. Use of a wrong fuse can result in equipment damage

Do not operate the equipment with wet hands.

Electrical shock can result.

⚠ WARNING

Do not open the equipment.

Improper handling can result in electrical shock. Only qualified personnel should work inside the equipment.

Do not disassemble or modify the equipment.

Fire electrical shock or serious injury can result.

Turn off the power immediately if water leaks into the equipment or the equipment is emitting smoke or fire.

Continued use of the equipment can cause fire or electrical shock.

Do not place liquid-filled containers on the top of the equipment.

Fire or electrical shock can result if a liquid spills into the equipment.

⚠ CAUTION

No one navigation device should ever be solely relied upon for the navigation of a vessel.

Always confirm position against all available aids to navigation, for safety of vessel and crew.

The guard alarm is a useful anti-collision aid, but does not relieve the operator of the responsibility to also keep a visual lookout for possible collision situations. The alarm should never be used as the sole means for detecting possible collision situations.

Two warning labels are attached to the display unit and scanner unit. Do not remove these label. If labels are peeling off or are illegible, contact a FURUNO agent or dealer.

<Display Unit>
 Name: Warning Label (1)
 Type: 86-003-1011-0
 Code no.: 100-236-230



<Scanner Unit>
 Name: Radiation Warning Label
 Type: 03-142-3201-0
 Code no.: 100-266-890



SART (Search and Rescue Transponder)

A Search and Rescue Transponder (SART) may be triggered by any X-Band (3 cm) radar within a range of approximately 8 n.miles. Each radar pulse received causes it to transmit a response which is swept repetitively across the complete radar frequency band. When interrogated, it first sweeps rapidly ($0.4 \mu\text{sec}$) through the band before beginning a relatively slow sweep ($7.5 \mu\text{sec}$) through the band back to the starting frequency. This process is repeated for a total of twelve complete cycles. At some point in each sweep, the SART frequency will match that of the interrogating radar and be within the pass band of the radar receiver. If the SART is within range, the frequency match during each of the 12 slow sweeps will produce a response on the radar display, thus a line of 12 dots equally spaced by about 0.64 nautical miles will be shown.

When the radar to the SART is reduced to about 1 n.miles, the radar display may show also the 12 responses generated during the fast sweeps. These additional dot responses, which also are equally spaced by 0.64 nautical miles, will be interspersed with the original line of 12 dots. They will appear slightly weaker and smaller than the original dots.

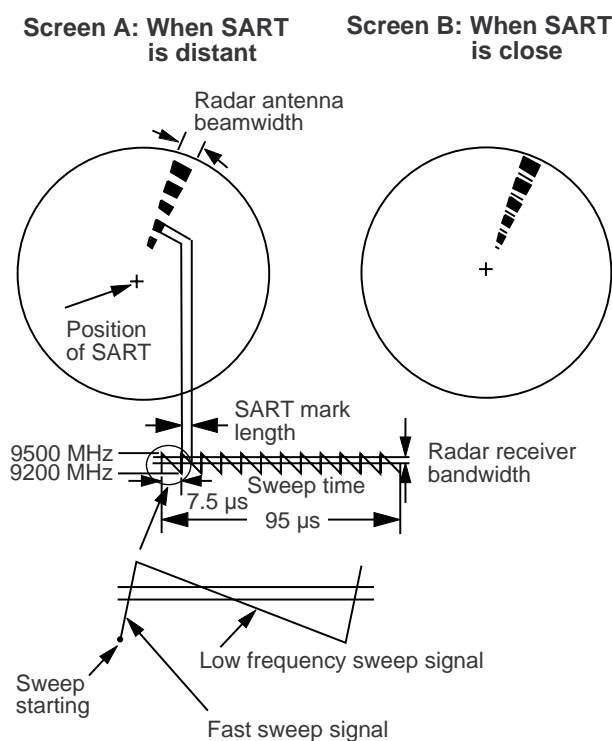

Showing SART marks on the radar display

To show the SART marks only on the radar display, detune the radar receiver by the manual tuning out of best tuning condition. This erases or weakens all normal radar echoes, but, the SART marks are not erased because the SART response signal scans over all frequencies in the 9 GHz band. When the radar approaches the SART in operation, the SART marks will enlarge to large arcs, blurring a large part of the screen. Reduce the sensitivity and adjust the sea clutter control of the radar.

Summary to detect SART response

1. Use range scale of 6 or 12 nm as the spacing between the SART responses is about 0.6 nm (1125 m) to distinguish the SART.
2. Turn off the A/C AUTO function.
3. Turn off the Interference Rejector.

General remarks on receiving SART

Radar range scale

When looking for a SART it is preferable to use either the 6 or 12 nautical mile range scale. This is because the total displayed length of the SART response of 12 (or 24) dots may extend approximately 9.5 nautical miles beyond the position of the SART and it is necessary to see a number of response dots to distinguish the SART from other responses.

SART range errors

When responses from only the 12 low frequency sweeps are visible (when the SART is at a range greater than about 1 n.mile), the position at which the first dot is displayed may be as much as 0.64 n.mile beyond the true position of the SART. When the range closes so that the fast sweep responses are seen also, the first of these will be no more than 150 meters beyond the true position.

FOREWORD

Congratulations on your choice of the FURUNO FR-7062/7112/7252 Marine Radar. We are confident you will see why the FURUNO name has become synonymous with quality and reliability.

For over 40 years FURUNO Electric Company has enjoyed an enviable reputation for innovative and dependable marine electronics equipment. This dedication to excellence is furthered by our extensive global network of agents and dealers.

Your radar is designed and constructed to meet the rigorous demands of the marine environment. However, no machine can perform its intended function unless properly operated and maintained. Please carefully read and follow the recommended procedures for operation and maintenance.

We would appreciate hearing from you, the end-user, about whether we are achieving our purposes.

Thank you for considering and purchasing FURUNO equipment.

Note: In this manual, "N-type" means Netherlands specification radar.

Features

Your radar has a large variety of functions, all contained in a remarkably small cabinet.

The main features of the model FR-7062 are

- Traditional FURUNO reliability and quality in a compact, lightweight and low-cost radar.
- Durable brushless antenna motor.
- On-screen alphanumeric readout of all operational information.
- Standard features include EBL (Electronic Bearing Line), VRM (Variable Range Marker), Guard Alarm, Display Off Center, and Echo Trail.
- Watchman feature periodically transmits the radar to check for radar targets which may have entered the alarm zone.
- Ship's position in latitude and longitude and Loran C TDs, range and bearing to a waypoint, speed, heading, and course can be shown in the bottom text area. (Requires a navigation aid which can output such data in IEC 1162 format.)
- Zoom feature provided.
- Auto Plotter ARP-10 (option) acquires and tracks up to 10 targets, and is installed in the display unit.
- Cursor position data (TLL) can be output to a plotter (option).

TABLE OF CONTENTS

FOREWORD	v
-----------------------	----------

MENU TREE	vii
------------------------	------------

SYSTEM CONFIGURATION....	viii
---------------------------------	-------------

1. PRINCIPLE OF OPERATION

1.1 What is Radar?	1-1
1.2 How Ships Determined Position Before Radar	1-1
1.3 How Radar Determines Range	1-1
1.4 How Radar Determines Bearing	1-1
1.5 Radar Wave Speed and Antenna Rotation Speed	1-1
1.6 The Radar Display	1-1

2. BASIC OPERATION

2.1 Control Description	2-1
2.2 Display Indications and Markers	2-2
2.3 Turning the Radar On/Off	2-3
2.4 Transmitting	2-3
2.5 Stand-by	2-3
2.6 Selecting the Range	2-4
2.7 Adjusting Picture Brilliance	2-4
2.8 Adjusting Receiver Sensitivity	2-4
2.9 Adjusting the A/C SEA Control (reducing sea clutter)	2-4
2.10 Adjusting the A/C RAIN Control (reducing rain clutter)	2-5
2.11 Selecting the Presentation Mode	2-6
2.12 Erasing the Heading Marker, North Marker	2-6
2.13 Magnifying Long Range Echoes (echo stretch)	2-6
2.14 Measuring the Range	2-7
2.15 Measuring the Bearing	2-7
2.16 Using the Offset EBL	2-8
2.17 Shifting (off centering) the Picture	2-9
2.18 Zoom	2-9

3. ADVANCED OPERATION

3.1 Basic Menu Operation	3-1
--------------------------------	-----

3.2 Index Lines	3-1
3.3 Suppressing Radar Interference	3-2
3.4 Selecting Pulsewidth	3-2
3.5 Displaying Navigation Data	3-3
3.6 Echo Trail	3-4
3.7 Guard Alarm	3-4
3.8 Watchman	3-6
3.9 OTHER MENU Description	3-7
3.10 Function Keys	3-8
3.11 Adjusting Brilliance of Markers	3-8
3.12 Suppressing Second-Trace Echoes	3-8
3.13 Suppressing Noise	3-8
3.14 Outputting Target Position	3-8
3.15 Tuning the Receiver	3-8

4. FALSE ECHOES

4.1 Multiple Echoes	4-1
4.2 Side-lobe Echoes	4-1
4.3 Indirect Echoes	4-2
4.4 Blind and Shadow Sectors	4-2

5. MAINTENANCE & TROUBLE-SHOOTING

5.1 Preventative Maintenance	5-1
5.2 Replacing the Fuse	5-1
5.3 Troubleshooting	5-2
5.4 Self Test	5-3
5.5 Life Expectancy of Magnetron	5-3

6. ARP-10 (OPTION)

6.1 General	6-2
6.2 Keys Used for Auto Plotter	6-2
6.3 Activating the Auto Plotter	6-3
6.4 Manual Acquisition	6-4
6.5 Automatic Acquisition	6-4
6.6 Terminating Tracking of Targets	6-5
6.7 Displaying Target Data	6-5
6.8 Mode and Length of Vectors	6-6

SPECIFICATIONS	SP-1
-----------------------------	-------------

INDEX	IN-1
--------------------	-------------

Declaration of Conformity

MENU TREE

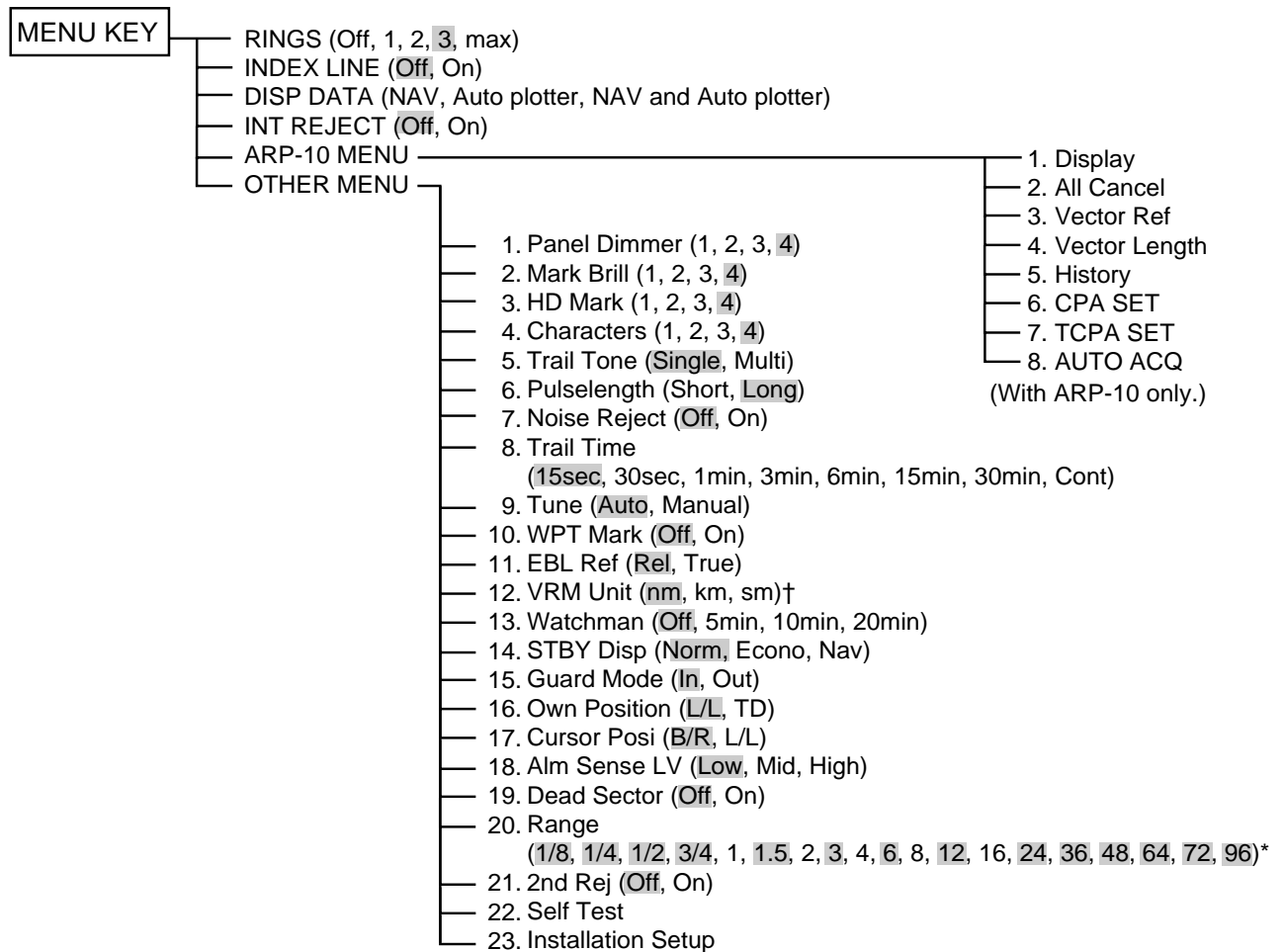

■ = Default setting

*Maximum range
 FR-7062: 64
 FR-7112: 72
 FR-7252: 96

†: Not available on N-type radar.

SYSTEM CONFIGURATION

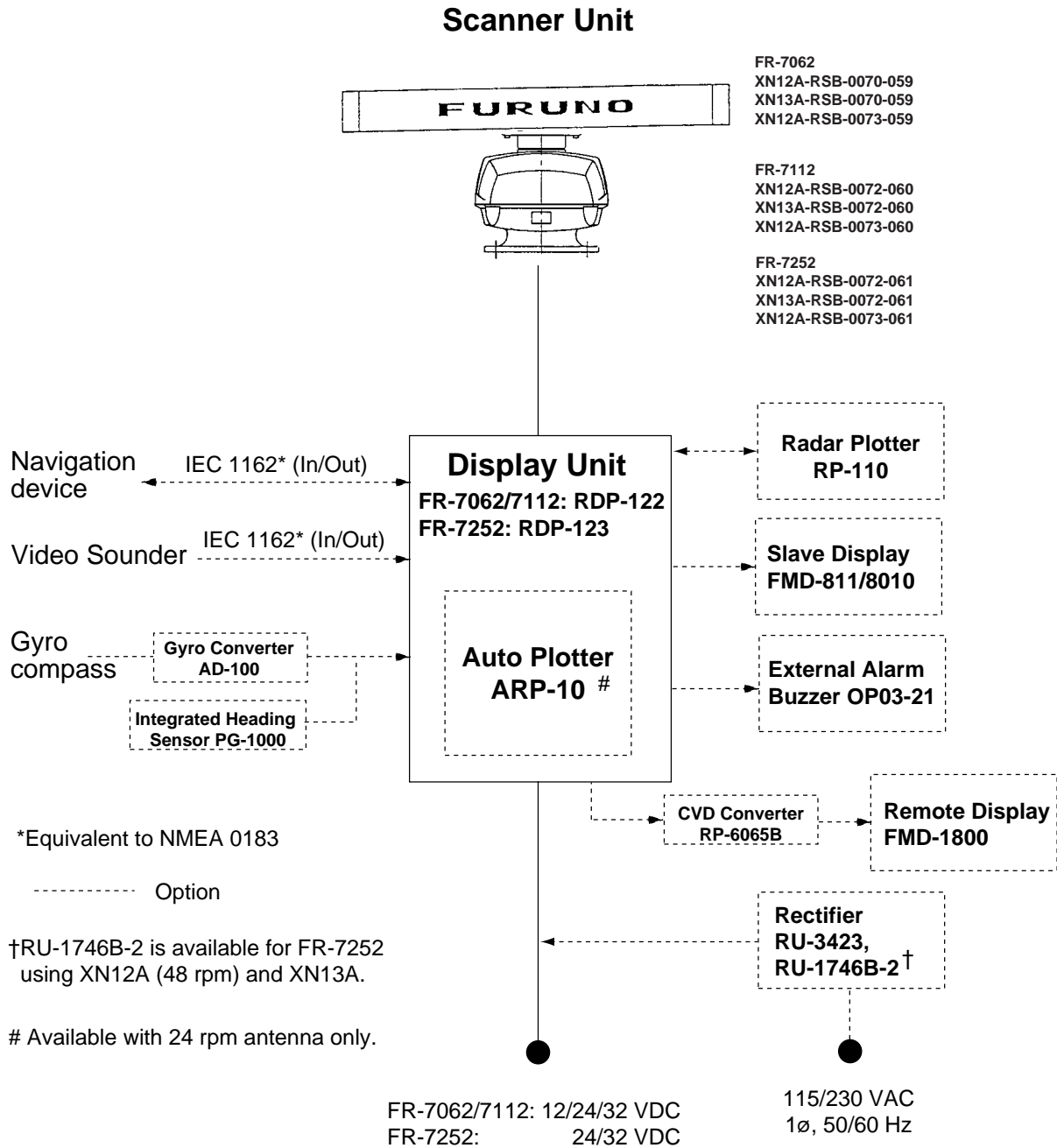

1. PRINCIPLE OF OPERATION

1.1 What is Radar?

The term "RADAR" is an acronym meaning Radio Detection And Ranging. Although the basic principles of radar were developed during World War II, echoes as an aid to navigation is not a new development.

1.2 How Ships Determined Position Before Radar

Before the invention of radar, when running in fog near a rugged shoreline, ships would sound a short blast on their whistles, fire a shot, or strike a bell. The time between the origination of the sound and the returning of the echo indicated how far the ship was from the cliffs or the shore. The direction from which the echo was heard indicated the relative bearing of the shore.

1.3 How Radar Determines Range

Radar determines the distance to the target by calculating the time difference between the transmission of a radar signal and the reception of the reflected echo. It is a known fact that radar waves travel at a nearly constant speed of 162,000 nautical miles per second. Therefore the time required for a transmitted signal to travel to the target and return as an echo to the source is a measure of the distance to the target. Note that the echo makes a complete round trip, but only half the time of travel is needed to determine the one-way distance to the target. This radar automatically takes this into account in making the range calculation.

1.4 How Radar Determines Bearing

The bearing to a target found by the radar is determined by the direction in which the radar scanner antenna is pointing when it emits an electronic pulse and then receives a returning echo. Each time the scanner rotates pulses are transmitted in the full 360 degree circle, each pulse at a slightly different bearing from the previous one. Therefore, if one knows the direction in which the signal is sent out, one knows the direction from which the echo must return.

1.5 Radar Wave Speed and Antenna Rotation Speed

Note that the speed of the radar waves out to the target and back again as echoes is extremely fast compared to the speed of rotation of the antenna. By the time radar echoes have returned to the scanner, the amount of scanner rotation after initial transmission of the radar pulse is extremely small.

1.6 The Radar Display

The range and bearing of a target are displayed on what is called a Plan Position Indicator (PPI). This display is essentially a polar diagram, with the transmitting ship's position at the center. Images of target echoes are received and displayed at their relative bearings, and at their distance from the PPI center.

With a continuous display of the images of targets, the motion of the transmitting ship is also displayed.

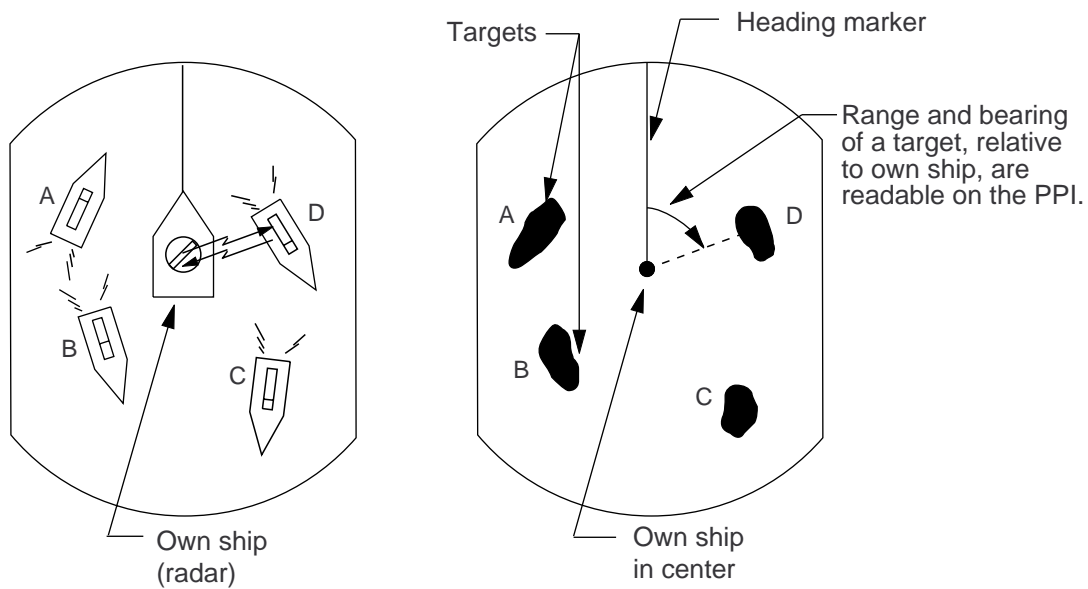

(A) Bird's eye view of situation

(B) Radar picture of (A)

Figure 1-1 How radar works

2. BASIC OPERATION

2.1 Control Description

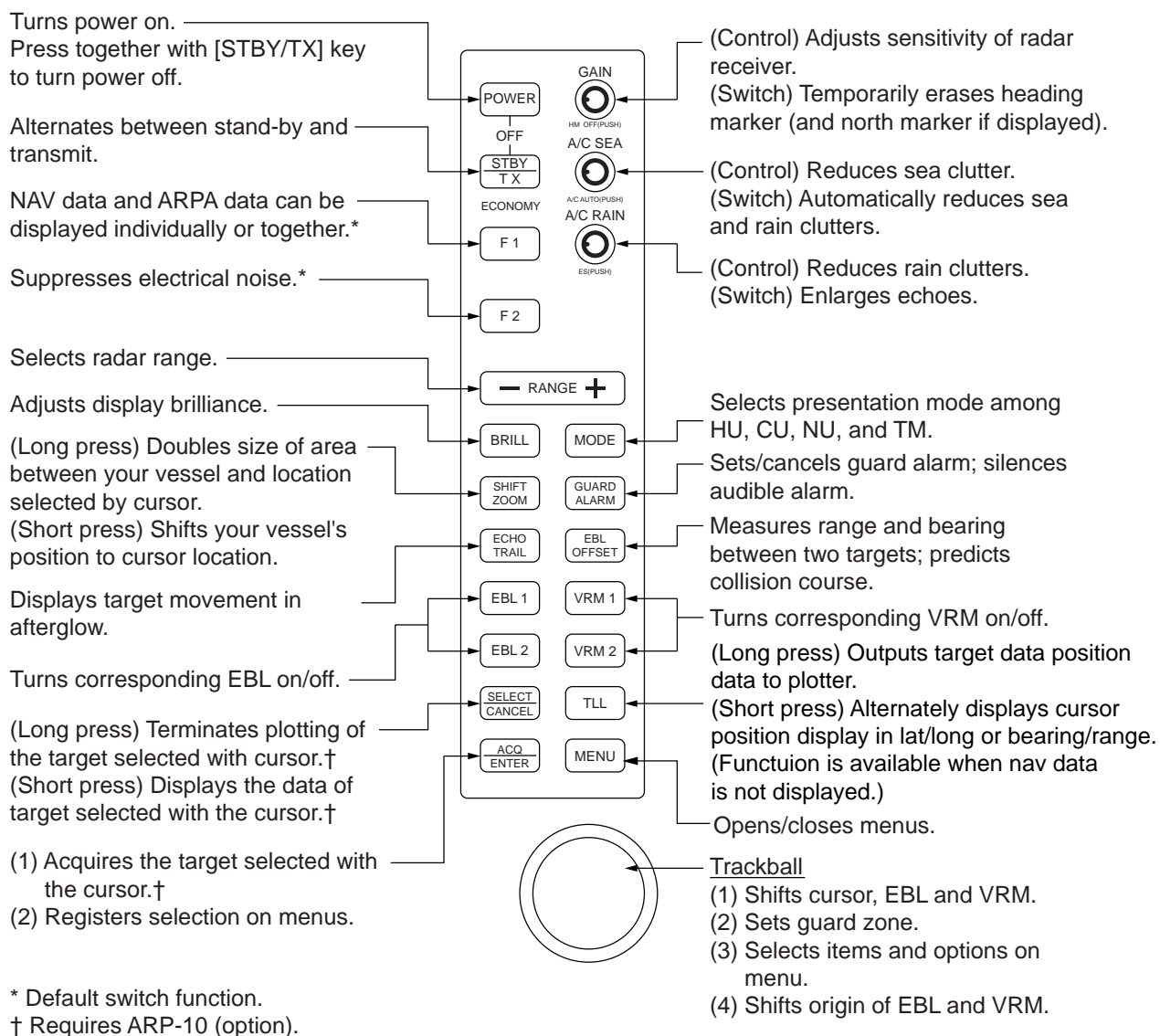

Figure 2-1 Control panel

2.2 Display Indication and Markers

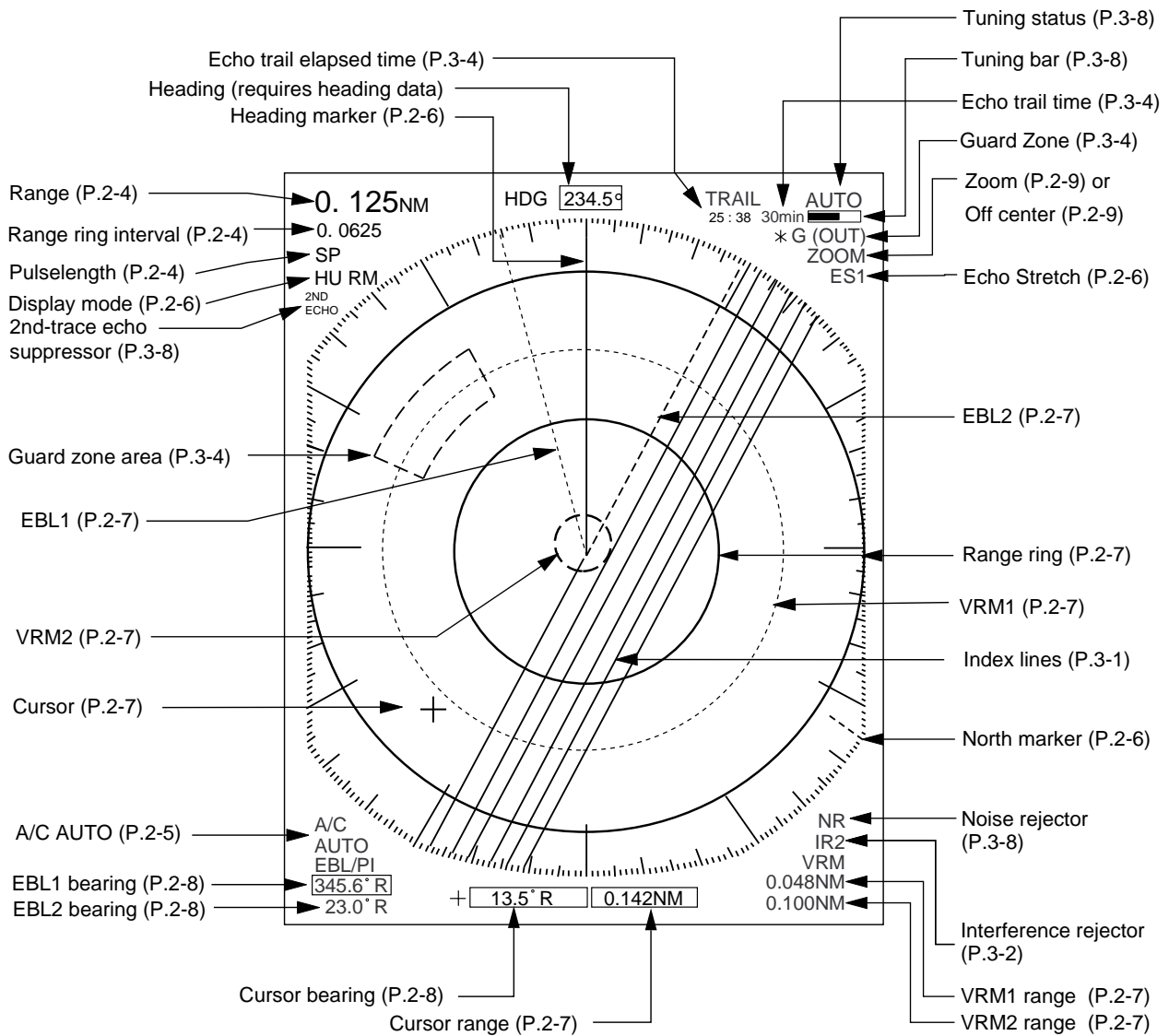

Figure 2-2 Display indications

2.3 Turning the Radar On/Off

Press the [POWER] key to turn the radar on.

To turn the radar off, press the [POWER] key together with the [STBY/TX] key.

When the radar is turned on, the control panel lights and a timer displays the time remaining for warm up of the magnetron (the device which produces radar pulses), counting down from 1:30 to 0:01 (2:00 to 0:01 for FR-7252).

2.4 Transmitting

After the power is turned on and the magnetron has warmed up, STBY (Stand-By) appears at the screen center. This means the radar is now fully operational.

Press the [STBY TX] key to transmit.

When transmitting, any echoes from targets appear on the display. This radar displays echoes in eight tones of green according to echo strength.

2.5 Stand-by

When you won't be using the radar for an extended period, but you want to keep it in a state of readiness, place it in stand-by by pressing the [STBY/TX] key. The display shows "STBY," (default setting) navigation data, or goes into the economy mode. (You can select stand-by condition on the menu. More on menu operation later.)

Economy mode

The CRT can be set to automatically turn itself off when in stand-by, to reduce power consumption. This feature is called the "economy mode". When the economy mode is on, the "ECONOMY" indication under the [STBY/TX] key lights.

Navigation data display during stand-by

If a navigation aid inputs navigation data to this radar, navigation data can be displayed during stand-by. You can turn the navigation data display on/off through the menu. Figure 2-3 shows a typical navigation data display during stand-by.

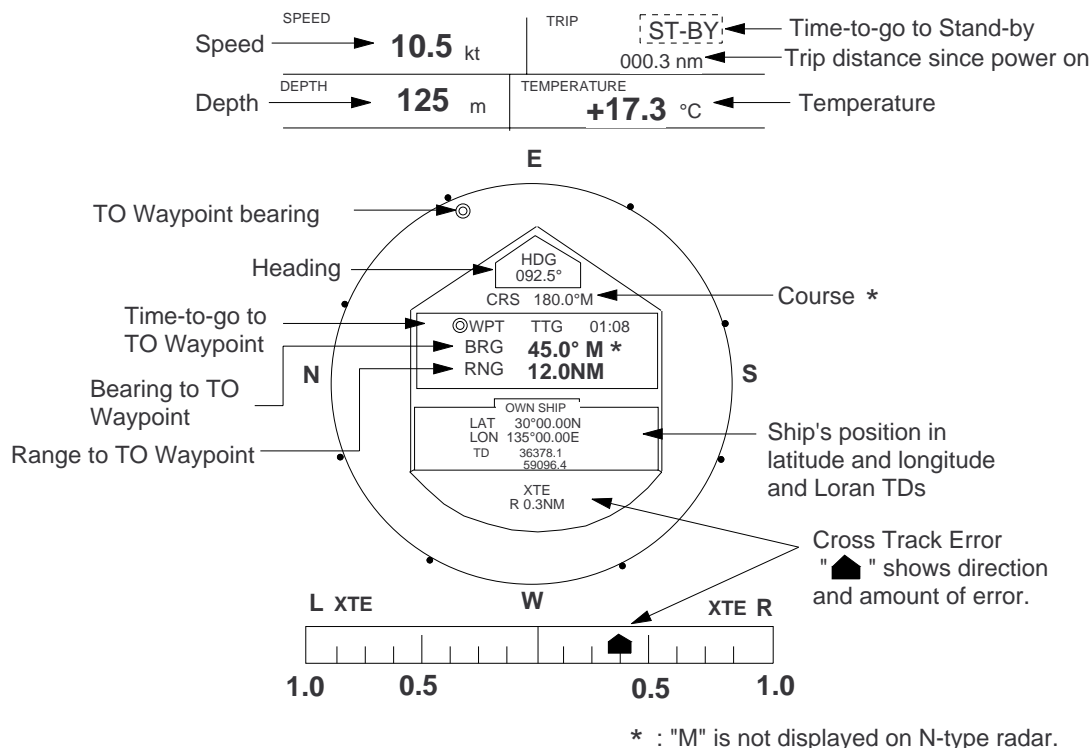

Figure 2-3 Typical navigation data display during stand-by

Note 1: Availability of a particular display item depends on incoming data.

Note 2: When Range to Waypoint reaches 0.1 nm, the WPT mark jumps to dead ahead even though a difference may exist between heading and BRG to WPT.

Note 3: When cross track error exceeds 1 nm on either side, the XTE mark starts blinking.

2.6 Selecting the Range

The range selected automatically determines the range ring interval, the number of range rings, pulselength and pulse repetition rate, for optimal detection capability in short to long ranges.

You can select which ranges and pulselength (for 1.5 and 3 mile ranges) to use through the menu. The range, range ring interval and pulselength appear at the top left-hand corner of the display.

Selecting the range

Press the [- RANGE +] key. The range and range ring interval appear at the top left corner on the display.

Tips for selecting the range

- When navigating in or around crowded harbors, select a short range to watch for possible collision situations.
- If you select a lower range while on open water, increase the range occasionally to watch for vessels that may be heading your way.

2.7 Adjusting Picture Brilliance

The [BRILL] key adjusts the brilliance of the radar picture in sixteen levels.

Press the [BRILL] key to set the brilliance level. The current level momentarily appears on the screen.

2.8 Adjusting Receiver Sensitivity

The [GAIN] control adjusts the sensitivity of the receiver. It works in precisely the same manner as the volume control of a broadcast receiver, amplifying the signals received.

The proper setting is such that the background noise is just visible on the screen. If you set up for too little sensitivity, weak echoes may be missed. On the other hand excessive sensitivity yields too much background noise; strong targets may be missed because of the poor contrast between desired echoes and the background noise on the display.

To adjust receiver sensitivity, transmit on long range, and adjust the [GAIN] control so background noise is just visible on the screen.

2.9 Adjusting the A/C SEA Control (reducing sea clutter)

Echoes from waves can be troublesome, covering the central part of the display with random signals known as “sea clutter”. The higher the waves, and the higher the antenna above the water, the further the clutter will extend. Sea clutter appears on the display as many small echoes which might affect radar performance. (See the left-hand figure in Figure 2-4.) When sea clutter masks the picture, adjust the A/C SEA control to reduce the clutter.

How the A/C SEA control works

The [A/C SEA] control reduces the amplification of echoes at short ranges (where clutter is the greatest) and progressively increases amplification as the range increases, so amplification will be normal at those ranges where there is no sea clutter.

Adjusting the A/C SEA control

The proper setting of the A/C SEA should be such that the clutter is broken up into small dots, and small targets become distinguishable.

If the control is set too low, targets will be hidden in the clutter, while if it is set too high, both sea clutter and targets will disappear from the display. In most cases adjust the control until clutter has disappeared to leeward, but a little is still visible windward.

1. Confirm that the sensitivity is properly adjusted, and then transmit on short range.
2. Adjust the [A/C SEA] control so small targets are distinguishable but some clutter remains on the display.

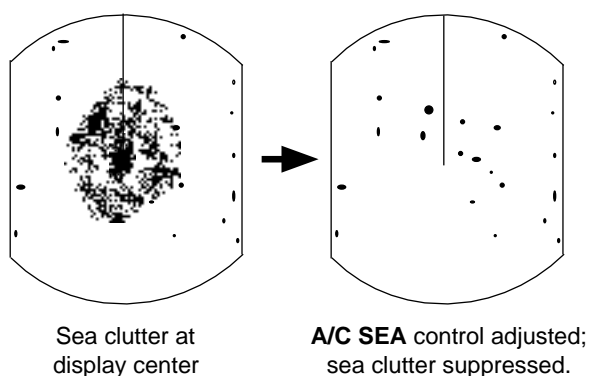
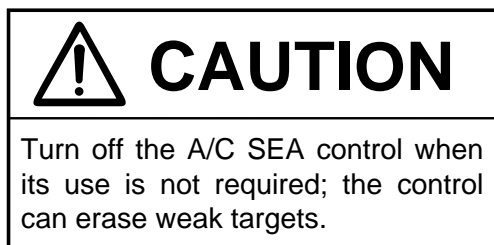

Figure 2-4 How to adjust the A/C SEA control

Tip for adjusting the A/C SEA

A common mistake is to over-adjust the circuit so all the clutter is removed. As an example set up for maximum A/C SEA. You will see how the center of the display becomes dark. This dark zone can be dangerous (targets may be missed), especially if the sensitivity is not properly adjusted. Always leave a little clutter visible on the display to be sure weak echoes will not be suppressed. If there is no clutter visible on the display, turn off the circuit.



2.10 Adjusting the A/C RAIN Control (reducing rain clutter)

The vertical beamwidth of the antenna is designed to see surface targets even when the ship is rolling. However, by this design the unit will also detect rain clutter (rain, snow, hail, etc.) in the same manner as normal targets. Figure 2-5 shows the appearance of rain clutter on the display.

Adjusting A/C RAIN

When rain clutter masks echoes, adjust the [A/C RAIN] control. This control splits up these unwanted echoes into a speckled pattern, making recognition of solid targets easier.

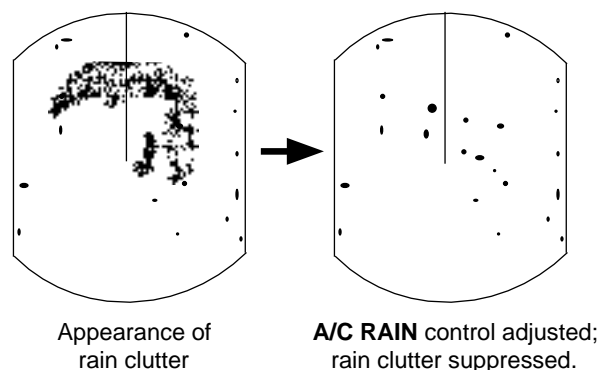

Figure 2-5 Effect of A/C RAIN

Note: In addition to reducing clutter, the [A/C RAIN] control can be used in fine weather to clarify the picture when navigating in confined waters. However, with the circuit activated the receiver is less sensitive. Therefore, turn off the circuit when its function is not required.

Automatic adjustments of A/C SEA and A/C RAIN

Push the [A/C SEA (A/C AUTO)] control. "A/C AUTO" appears at the bottom left-hand corner of the display when the A/C AUTO circuit is on. You can fine tune by adjusting the [A/C SEA], [A/C RAIN] and [GAIN] controls.

2.11 Selecting the Presentation Mode

This radar provides four presentation modes: head-up, course-up, north-up and true motion.

Press the [MODE] key.

With heading sensor connection, the display and the display mode indication at the top left-hand corner of the display change in the sequence of HU RM (Head-up), CU RM (Course-up), NU RM (North-up) and NU TM (True Motion) when the [MODE] key is pressed. If there is no heading sensor connection, the display mode is always HU RM.

Note: The radar begins operation with last selected display mode (except Course-up) whenever the unit is turned on. Note however that Head-up is selected when Course-up was the last-used mode.

Head-up

The picture is oriented so the heading marker is at the top of the display. This mode is useful for navigation in congested waters.

Course-up

The Course-up mode shows ship's heading by the heading marker, at the top of the display. To get heading desired, steer vessel in direction desired, and then show "CU RM" at the top left-hand corner of the display.

North-up

North is at the top of the display and the heading marker moves with ship's heading. This mode is useful for determining ship's position and as a navigation monitor on a nautical chart. The picture is stabilized against yaw of vessel, thereby reducing smear of target echoes. Bearing signal is required from a heading sensor.

True motion

True motion displays own ship and moving objects in their true motion. Bearing signal and speed signal are required from heading sensor and speed sensor.

2.12 Erasing the Heading Marker, North Marker

The heading marker or north marker (available with gyrocompass connection) may occasion-

ally mask a target. To view the target, you can temporarily erase the heading marker and north marker by pressing and holding down the [GAIN (HM OFF)] control. Release the control to re-display the markers.

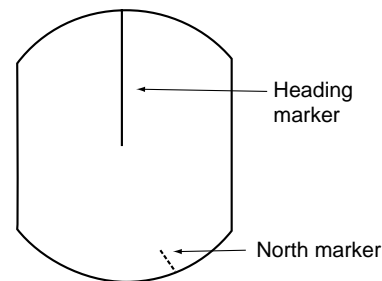

Figure 2-6 Heading marker and north marker

2.13 Magnifying Long Range Echoes (echo stretch)

Normally, the reflected echoes from long range targets appear on the display as weaker and smaller blips even though they are compensated by the radar's internal circuitry. The echo stretch function magnifies these small blips in all ranges. Two types of echo stretch are available: ES1 which stretches echoes in bearing direction and ES2 which stretches them in both range and bearing directions.

To turn the echo stretch on or off, press the [A/C RAIN (ES)] control. Each press changes the echo stretch function in the sequence of ES1, ES2 and OFF. ES1 or ES2 appears at the top right-hand corner of display when echo stretch is on.

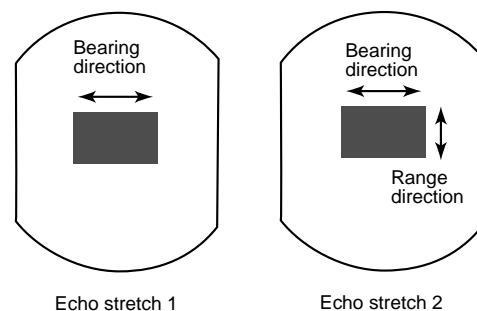

Figure 2-7 Echo stretch

Note 1: This function magnifies not only targets but also sea clutter and radar interference. For this reason be sure the controls for adjustment of sea clutter and radar interference are properly adjusted before activating the echo stretch.

Note 2: ES2 is not available on short ranges.

2.14 Measuring the Range

You can measure the range to a target three ways: by the range rings, by the cursor, and by the VRM (Variable Range Marker).

Measuring range by range rings

Count the number of rings between the center of the display and the target. Check the range ring interval and judge the distance of the echo from the inner edge of the nearest ring.

To turn the rings on or off, see the menu operation later (Chapter 3).

Measuring range by cursor

Operate the trackball to place the cursor intersection on the inside edge of the target echo. The range to the target, as well as the bearing, appears at the bottom of the display.

Measuring by VRM

1. Press either [VRM 1] or [VRM 2] key. The readout of the active marker is circumscribed.

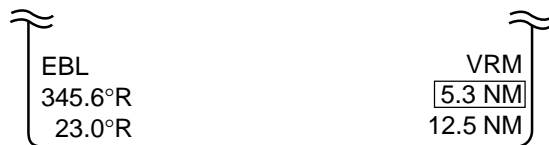

Figure 2-8 Display bottom, showing location of EBL and VRM readouts

2. Operate the trackball to place the outside edge of the VRM on the inside edge of the target. The trackball must be operated within five seconds after pressing a [VRM] key, otherwise the corresponding VRM cannot be operated. Press the [VRM] key again to adjust the VRM.
3. Check the VRM readout at the bottom right-hand corner of the display to find the range to the target.
4. To anchor the VRM, press the [VRM] key again.

To erase the VRM, press and hold down the corresponding [VRM] key about two seconds.

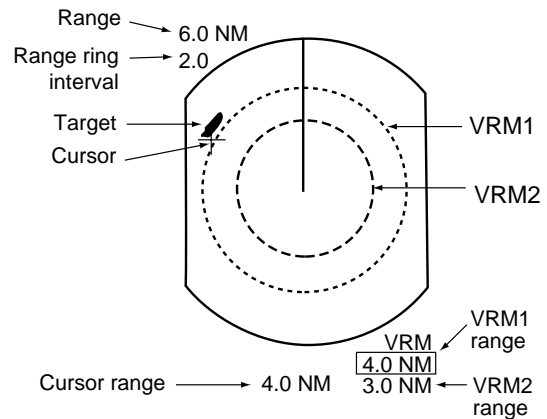

Figure 2-9 Measuring range by the cursor and VRM

Note: You can display the range readout of the VRM and cursor in nautical miles, statute miles or kilometers. For details see the next chapter.

2.15 Measuring the Bearing

There are two ways to measure the bearing to a target: by the cursor, and by the EBL (Electronic Bearing Line).

Measuring bearing by cursor

Operate the trackball to bisect the target with the cursor intersection. The bearing to the target appears at the bottom of the display.

Measuring by EBL

1. Press the [EBL 1] or [EBL 2] key.
2. Operate the trackball to bisect the target with the EBL.

The trackball must be operated within five seconds after pressing an [EBL] key, otherwise the corresponding EBL cannot be operated. Press the [EBL] key again to adjust the EBL.

3. Check the EBL readout at the bottom left-hand corner of the display to find the bearing to the target.
4. To anchor the EBL, press the corresponding [EBL] key again.

To erase the EBL and its readout, press and hold down the corresponding [EBL] key about two seconds.

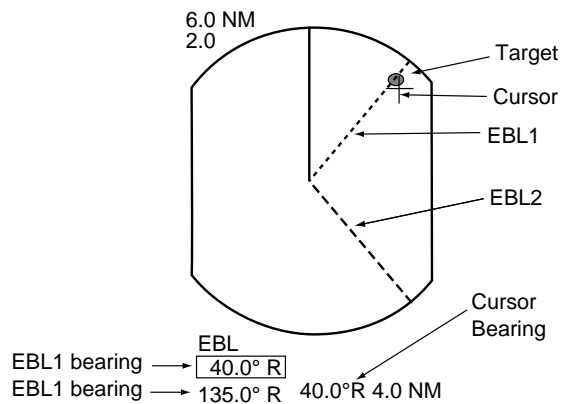

Figure 2-10 How to measure bearing by EBL and cursor

Note: The bearing readout for the EBL and the cursor can be displayed in relative or true bearing (true bearing requires heading sensor input). For North-up and Course-up display modes the bearing reference is always true.

Tips for measuring bearing

- Bearing measurements of smaller targets are more accurate; the center of larger target pips is not as easily identified.
- Bearings of stationary or slower moving targets are more accurate than bearings of faster moving targets.
- To minimize bearing errors keep echoes in the outer half of the picture by changing the range scale; angular difference becomes difficult to resolve as a target approaches the center of the display.

2.16 Using the Offset EBL

The offset EBL provides two functions: predict collision course of radar target and measure the range and the bearing between two targets.

Predicting collision course

1. Operate the trackball to place the cursor on the center of the target.
2. Press the [EBL 1] key to turn on EBL1.
3. Press the [EBL OFFSET] key. EBL1's origin shifts to cursor location.
4. After waiting several minutes, press the [EBL 1] key again.

5. Operate the trackball to pass EBL1 through the center of the target.

If the target tracks along the EBL towards the center of the display (your vessel's position), the target may be on a collision course.

To cancel the offset EBL, press the [EBL OFF-SET] key.

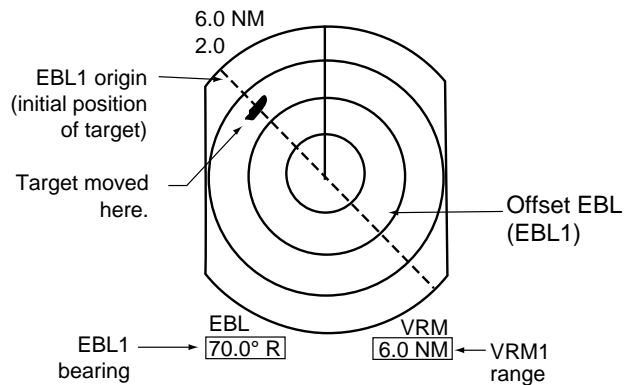

Figure 2-11 Predicting collision course by using the offset EBL

Measuring range and bearing between two targets

The procedure which follows shows how to measure the range and bearing between target "A" and target "B" in Figure 2-12.

1. Operate the trackball to place the cursor on the center of target "A".
2. Press the [EBL 1] key to turn on EBL1.
3. Press the [EBL OFFSET] key. EBL1's origin shifts to cursor location.
4. Press the [EBL 1] key.
5. Operate the trackball to bisect target "B" with EBL1. Check the EBL1 readout to find the bearing between target "A" and target "B".
6. Press the [VRM 1] key to turn on VRM1. Operate the trackball to place the outside edge of VRM1 on the inside edge of target "B". Check the VRM readout to find the range between target "A" and target "B".

To cancel, press the [EBL OFFSET] key.

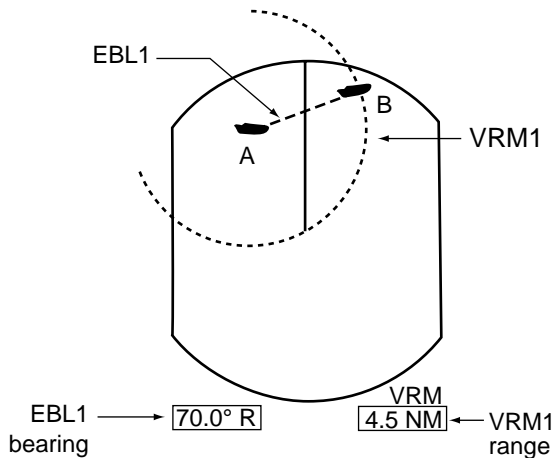

Figure 2-12 Measuring the range and bearing between two targets by using the offset EBL

2.17 Shifting (off centering) the Picture

Your vessel's position can be shifted up to 75% of the range in use to view the situation around your vessel without changing the range or size of targets.

1. Operate the trackball to set cursor where desired.
2. Press the [SHIFT/ZOOM] key.

OFFCENTER appears at the top right corner of the display when the picture is shifted.

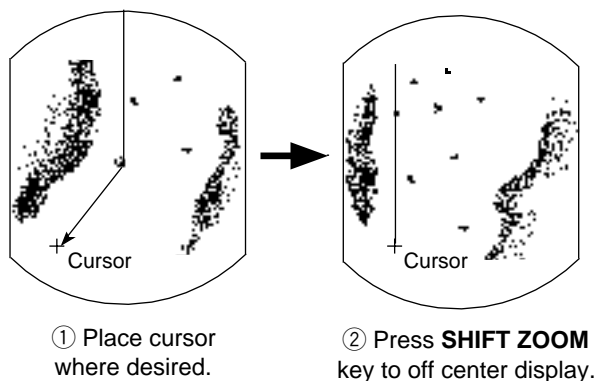

① Place cursor where desired.

② Press **SHIFT ZOOM** key to off center display.

Figure 2-13 Shifting the picture

Canceling shifted picture

Press the [SHIFT/ZOOM] key again.

2.18 Zoom

The zoom feature allows you to double the size of the area between your vessel and any location within the current range to take a closer look at an area of interest.

1. Select location with the cursor.
2. Press and hold down the [SHIFT/ZOOM] key about two seconds. ZOOM appears at the top right corner when the zoom function is on.

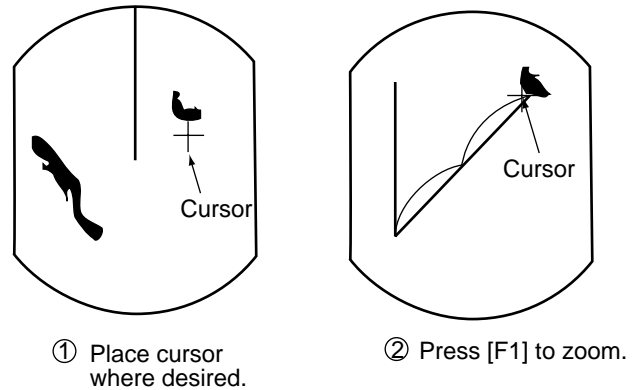

① Place cursor where desired.

② Press [F1] to zoom.

Figure 2-14 Zoom function

Note: Zoom is cancelled when range or presentation mode is changed.

Canceling zoom

Press the [SHIFT/ZOOM] key again.

3. ADVANCED OPERATION

3.1 Basic Menu Operation

The menu mostly contains less-often used functions which once preset do not require regular adjustment. To open or close the menu, press the [MENU] key. You can select items on the menu with the trackball. The complete menu appears at beginning of this manual.

1. Press the [MENU] key to display the main menu.

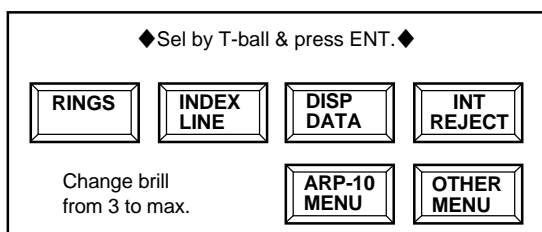

Figure 3-1 Main menu

2. Operate the trackball to select the item. For example, select RINGS. A message appears at the bottom of the menu window.
3. Press the [ACQ/ENTER] key to select setting. Each time this key is pressed, the message changes. For the RINGS menu, the message sequence is as shown below.

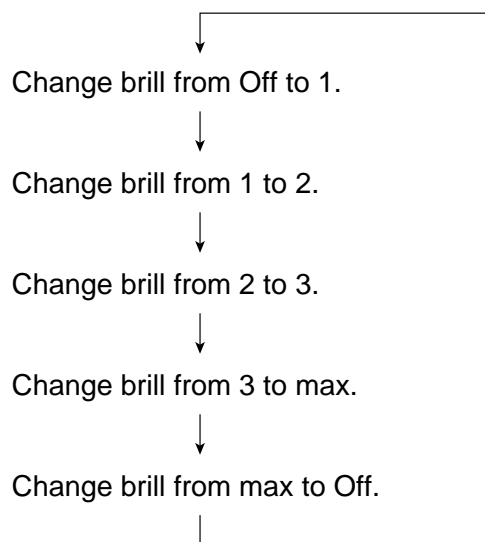

Figure 3-2 Messages for RINGS menu

4. Press the [MENU] key to close the menu.

3.2 Index Lines

The index lines are useful for maintaining a constant distance between own ship and a coast-line or partner ship. They are linked with EBL2 and VRM2.

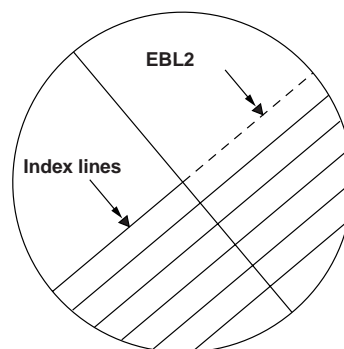

Figure 3-3 Index lines

Turning the index lines on/off

1. Press the [MENU] key.
2. Select "INDEX LINE" by the trackball.
3. Select "Index Line on" by pressing the [ACQ/ENTER] key.
4. Press the [ACQ/ENTER] key to confirm.
5. Press the [MENU] key to close the menu. "PI" indication appears next to EBL at the left bottom corner of the screen.

To turn the index lines off, select "Index Line off" and press the [ACQ/ENTER] key.

Rotating the index lines

1. Press the [EBL 2] key to activate EBL2.
2. Operate the trackball.

Adjusting the index lines interval

1. Press the [VRM 2] key to activate VRM2.
2. Operate the trackball.

3.3 Suppressing Radar Interference

Radar interference may occur when near another shipborne radar operating in the same frequency band as your radar. Its on-screen appearance is many bright dots either scattered at random or in the form of dotted lines extending from the center to the edge of the display. Figure 3-4 illustrates interference in the form of curved spokes. Interference effects are distinguishable from normal echoes because they do not appear in the same place on successive rotations of the antenna.

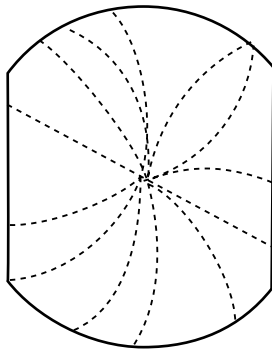

Figure 3-4 Radar interference

Four levels of interference are available, including off; IR1, IR2, IR3 and OFF. IR3 provides the highest level of rejection.

1. Press the [MENU] key.
2. Select “INT REJECT” and press the [ACQ/ENTER] key.
3. Select level desired by pressing the [ACQ/ENTER] key.
4. Press the [MENU] key to close the menu.

IR and level selected appears at the bottom right corner on the display when the interference rejection circuit is turned on.

3.4 Selecting Pulsewidth

Pulsewidth is the transmission time of a single radar pulse. The longer the pulsewidth the greater the direction range capability, however range accuracy and range resolution are reduced.

Pulsewidth can be selected to short or long on the 1.5 and 3 nautical mile ranges.

1. Press the [MENU] key.
2. Select “OTHER MENU” and press the [ACQ/ENTER] key.

[OTHERS]						[TX]
Select item by T-ball and press ENTER key.						
1. Panel Dimmer	1	2	3			4
2. Mark Brill	1	2	3			4
3. HD Mark	1	2	3			4
4. Characters	1	2	3			4
5. Trail Tone		Single	Multi			
6. Pulselength		Short	Long			
7. Noise Reject		Off	On			
8. Trail Time		15sec	30sec	1min		
	3min	6min	15min	30min	Cont	
9. Tune		Auto	Manual			
10. WPT Mark		Off	On			
11. EBL Ref		Rel	True			
12. VRM Unit †		nm	km	sm		
13. Watchman		Off	5min	10min	20min	
14. STBY Disp		Norm	Econo	Nav		
15. Guard Mode		In	Out			
16. Own Position		L/L	TD			
17. Cursor Posi		R/B	L/L			
18. Alm Sense LV		Low	Med	Hig		
19. Dead Sector		Off	On			
20. Range		1/8	1/4	1/2	3/4	1 1.5
	2	3	4	6	8	12 16 24 36 48 64 72 96*
21. 2nd Rej		Off	On			
22. Self Test						
23. Installation Setup						

†: Not displayed on N-type radar; VRM unit is fixed for nm.

*Max. range is;
FR-7062: 64
FR-7112: 72
FR-7252: 96

Figure 3-5 OTHER MENU

3. Select “6. Pulselength” by operating the trackball.
4. Select Short or Long by operating the trackball.
5. Press the [ACQ/ENTER] key.
6. Press the [MENU] key to close the menu.

3.5 Displaying Navigation Data

Navigation data can be displayed at the screen bottom if this radar receives navigation input in IEC 1162 format. Navigation data include;

- Position in latitude and longitude or Loran-C time difference
- Range, bearing and time-to-go to both waypoint selected on the navigator and the cursor
- Speed.

(If the navigation input includes destination data, waypoint position is denoted on the radar display by a dashed ring.)

To turn navigation data on or off

Press the [F1] key if its function is set for DISP DATA (default setting), or select DATA DISP on the menu.

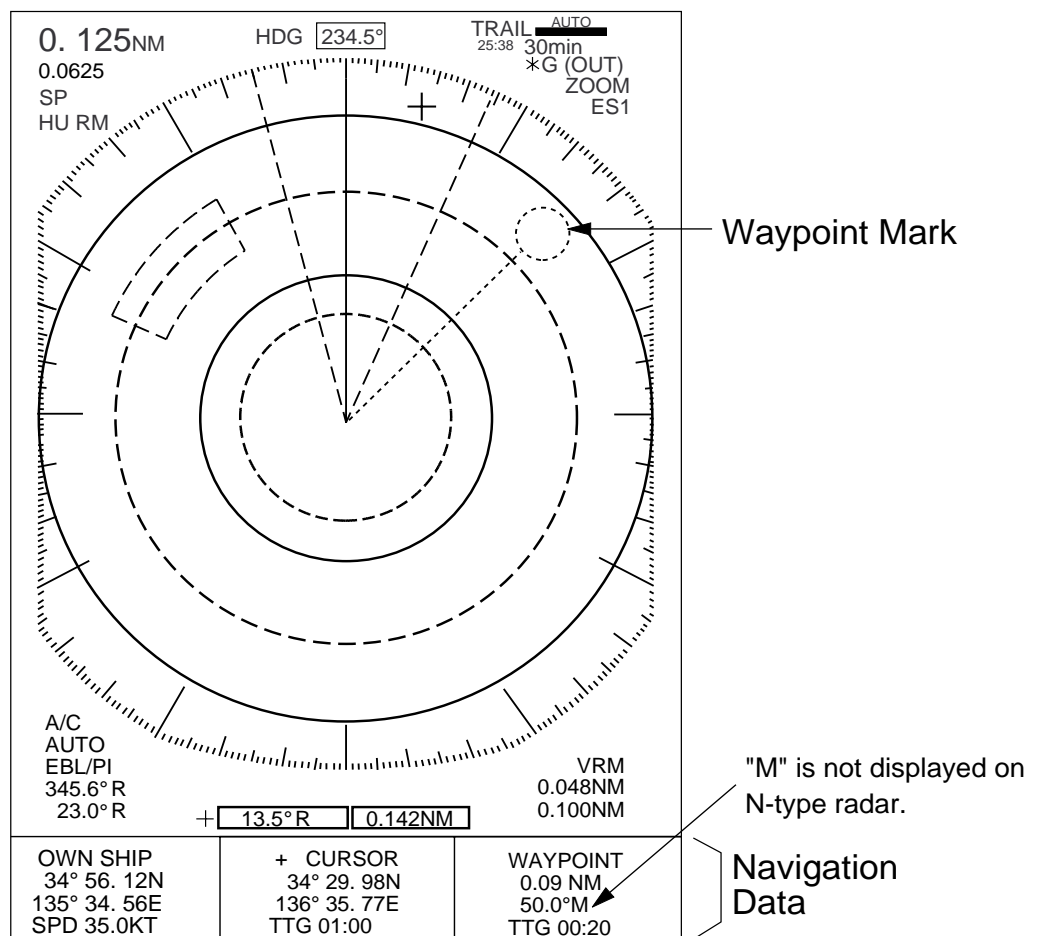

Figure 3-6 Typical navigation data display

3.6 Echo Trail

You can show the movement of all radar targets relative to your vessel in afterglow. This function is useful for alerting you to possible collision situations.

Starting echo trail

Press the [ECHO TRAIL] key.

TRAIL, the echo trail time selected (on "OTHER MENU") and elapsed time appear at the top right-hand corner of the display. Then, afterglow starts extending from all targets.



Figure 3-7 How the echo trail feature works

Note: Trails are restarted when range or mode is changed or zoom or shift is turned on.

Fixed time trail

1. When the elapsed time clock counts up to the trail time selected, the elapsed time display freezes.
2. The oldest portions of trails are erased so only the latest trail, equal in length to the trail time selected, is shown.
3. Trail continues.

For example, the one minute trail time is selected. When the elapsed time clock counts up to 60 seconds, the elapsed time display freezes at "60," but the latest one minute of trail is erased and then trail continues.

Continuous trail

The maximum continuous trail time is 99 minutes and 59 seconds. When the elapsed time clock counts up to that time the elapsed time display is reset to zero and trail begins again.



Cancelling echo trail

Press the [ECHO TRAIL] key again.

Changing trail attributes

Trail gradation and trail time can be selected on the OTHER MENU.

Table 3-1 Trailing attributes

Items in OTHERS menu	Description
Trail Tone	Trails can be shown in single or multiple gradations. Multiple paints trails getting thinner with time just like the afterglow on an analog PPI radar. <div style="display: flex; justify-content: space-around; align-items: center;"> <div style="text-align: center;"> <p>Single</p>  </div> <div style="text-align: center;"> <p>Multiple</p>  </div> </div>
Trail Time	Trails can be set for 15 sec., 30sec., 1min., 3min., 6min., 15min., 30min., or continuous.

3.7 Guard Alarm

The guard alarm allows the operator to set the desired range and bearing for a guard zone. When ships, islands, landmasses, etc. violate the guard zone an audible alarm sounds and the offending target blinks to call the operator's attention.

Selection of guard zone type

The guard alarm can be set to sound when a target enters or exits the guard zone. You can select which type of guard alarm you want through the menu.

In alarm

The alarm sounds on targets entering the guard zone. "G (IN)" appears at the top right-hand corner when the In alarm is selected.

Out alarm

The alarm sounds on targets exiting the guard zone. "G (OUT)" appears at the top right-hand corner when the Out alarm is selected.

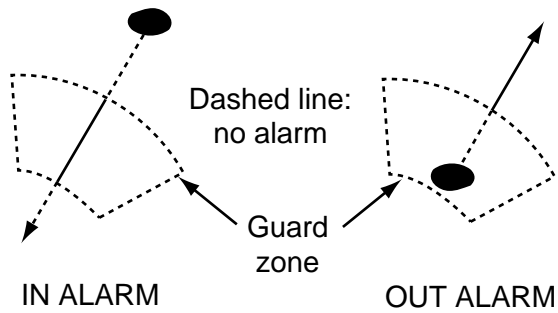

Figure 3-8 In and Out alarm

Setting a guard zone

Preparation

1. Press the [MENU] key, and then select "OTHER MENU," and press the [ACQ/ENTER] key.
2. Select "15. Guard Mode" and "In" (alarm on target entering zone) or "Out" (alarm on target exiting zone) by operating the trackball.
3. Press the [ACQ/ENTER] key.
4. Press the [MENU] key to close the menu.

To set a guard zone

1. Mentally create the guard zone you want to set. For example, the guard zone shown in Figure 3-9 (1).
2. Operate the trackball to set the cursor on point A or B. Press the [GUARD ALARM] key. "*G (IN)" or "*G (OUT)", with asterisk blinking, appears at the top right-hand corner of the display. See Figure 3-9 (2). (The asterisk indicates the guard zone is partially set.)
3. Operate the trackball to set the cursor on point C or D. See Figure 3-9 (3).
4. Press the [GUARD ALARM] key. The asterisk disappears. See Figure 3-9 (4).

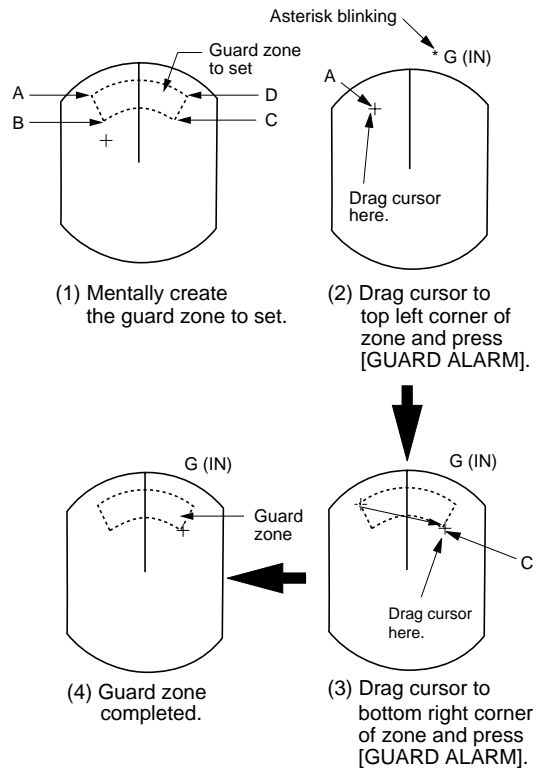

Figure 3-9 How to set the guard zone

Silencing the audible alarm

Any radar targets violating the guard zone will trigger the audible alarm. You can silence the audible alarm by pressing the [GUARD ALARM] key. When this is done, "G(ACKN)" replaces "G(IN)." This means the alarm is acknowledged. Press the key again to reactivate the alarm.

Cancelling the guard zone and alarm

Press and hold down the [GUARD ALARM] key until the guard zone disappears.

Notes on the guard alarm

- The alarm is a useful anti-collision aid, but does not relieve the operator of the responsibility to also keep a visual lookout for possible collision situations.
- When the radar range is less than one half of the guard zone range, the guard zone disappears and “G (IN)” or “G (OUT)” appears in inverse video. If this happens, raise range to re-display the guard zone.
- A target echo does not always mean a land-mass, reef, ships or surface objects but can imply returns from sea surface or precipitation. As the level of these returns varies with environment, the operator should properly adjust the A/C SEA, A/C RAIN and GAIN to be sure the alarm system does not overlook target echoes.

3.8 Watchman

The watchman function periodically transmits the radar for one minute to check for targets in a guard zone. If it finds change in the zone from the previous transmission the audible alarm sounds and the radar transmits continuously. This feature is useful when you do not need the radar's function continuously but want to be alerted to radar targets in a specific area.

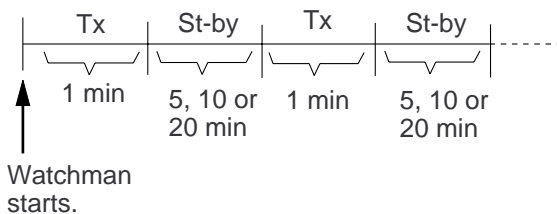

Figure 3-10 How watchman works

How watchman works

When the time selected for the watchman rest period has elapsed, the radar automatically transmits for one minute to check the condition inside the guard zone. If there is no change, the radar goes into stand-by (“WATCHMAN” appears during stand-by.) If there is change, the radar sounds the audible alarm, cancels the watchman function and transmits continuously.

Turning on watchman

1. Create a guard zone (usually 360 degrees) with the guard alarm function.
2. Press the [MENU] key.
3. Select “OTHER MENU”.
4. Press the [ACQ/ENTER] key.
5. Select “13. Watchman”.
6. Operate the trackball to select watchman rest period; 5 minutes, 10 minutes or 20 minutes.
7. Press the [ACQ/ENTER] key.
8. Press the [MENU] key to close the menu.

“WATCHMAN” appears at the top of the screen, the radar transmits for one minute to check for targets inside the guard zone, and then the CRT shuts off and the radar goes into stand-by.

Cancelling watchman

Go into the “OTHER MENU” , and set “13. Watchman” for off.

Note 1: Watchman can be used without a guard zone.

Note 2: The alarm sounds just before the radar starts and stops transmitting.

3.9 OTHER MENU Description

The table below summarizes the OTHER MENU.

Table 3-2 OTHER MENU Description

Item	Description
1. Panel Dimmer	Selects level of panel backlight.
2. Mark Brill	Selects brilliance of VRM, EBL, cursor, guard zone and WP marks.
3. HD Mark	Selects brilliance of heading marker.
4. Characters*	Selects brilliance of characters.
5. Trail Tone	Selects gradations of echo trails.
6. Pulselength	Selects pulselength for 1.5 and 3 mile ranges.
7. Noise Reject	Select "On" to reject noise.
8. Trail Time	Selects the trail time.
9. Tune	Selects automatic or manual tuning. To tune manually; 1. Select "Manual" by the trackball. 2. Press the [ACQ/ENTER] key to enable manual tuning. 3. While pressing and holding down the [GAIN] control, operate the trackball. (adjustment range; FR7062:1.0-11.9V, FR7112/7252:1.0-32 V) 4. Press the [MENU] key to close the menu. "MANUAL" appears at the top right-hand corner when manual tuning is in effect.
10. WPT Mark	Selects "On" to display the waypoint mark.
11. EBL Ref	Selects EBL reference for relative or true.
12. VRM Unit†	Selects distance unit of VRM and cursor for nm, km or sm.
13. Watchman	Turns watchman on (set rest period) or off.
14. STBY Disp	Selects the condition at stand-by; display "STBY" or navigation data, or go into the economy mode.
15. Guard Mode	Selects condition which triggers guard alarm; in or out.
16. Own Position	Displays the own ship's position in lat/long or Loran C TDs. (Requires NAV data.)
17. Cursor Posi	Displays the cursor position in range/bearing or lat/long.
18. Alm Sense LV	Selects minimum echo strength which triggers guard alarm.
19. Dead Sector	Select "On" to display the dead sector, which shows the area where the radar is not transmitted.
20. Range	Selects ranges to use.
21. 2nd Rej	Select "On" to suppress second-trace echoes.
22. Self Test	Tests keys, ROM and RAM, checks antenna rotation speed, and displays program no.
23. Installation Setup	For technicians.

*: Level 1 and 2 are same brilliance while the menu is displayed. The brilliance changes after the menu is erased.

†: Can not be selected on N-type radar; VRM unit is fixed for nm.

3.10 Function Keys

The function keys (F1 and F2) work like the auto-dialing feature of a telephone, automatically executing the function assigned to them. The assigned function can be turned on/off by pressing appropriate function key again.

Default settings

F1: Display NAV/ARPA data

F2: Noise rejector

How to program function keys

1. Press the [MENU] key.
2. Press [F1] or [F2] to open the function menu.



Figure 3-10 Function menu

3. Select function desired.
4. Press the [ACQ/ENTER] key.
5. Press the [MENU] key to close the menu.

3.11 Adjusting Brilliance of Markers

“2. Mark Brill” on the OTHER MENU adjusts the brilliance of markers such as the cursor.

3.12 Suppressing Second-Trace Echoes

In certain situations, echoes from very distant targets may appear as false echoes (second-trace echoes) on the screen. This occurs when the return echo is received one transmission cycle later, namely, after a next radar pulse has been transmitted. To suppress them, select “2nd Rej On” on the OTHER MENU.

3.13 Suppressing Noise

Electrical noise can be suppressed by turning on “7. NOISE REJ” on the OTHER MENU.

This function is available by pressing the [F2] key (default setting).

3.14 Outputting Target Position

Target position data can be output to a plotter in IEC 1162 format. Press and hold down the [TLL] key to output the data. This function requires position data and heading signal.

3.15 Tuning the Receiver

The radar receiver can be tuned automatically or manually, and the default tuning method is automatic. In automatic tuning, the radar is automatically tuned everytime the radar is switched to “Tx” and the indication “TUNING” appears during tuning.

The tuning bar at the top right-hand corner of the display shows tuning condition. Generally, the longer the tuning bar the better the tuning condition, however the length of the bar changes with number of radar echoes, range and other factors. Current tuning method is shown above the tuning bar as either “AUTO” or “MANUAL.”

For how to tune the receiver manually, see “9. Tune” on page 3-7.

Note: Automatic tuning may not work properly if own ship’s radar receives the radar wave of another ship’s radar. If this is the case, the radar will be out of tune. Press the [STBY/TX] key twice to retune.

4. FALSE ECHOES

Occasionally false echoes appear on the screen at positions where there is no target. In some cases the effects can be reduced or eliminated. The operator should familiarize himself or herself with the appearance and effects of these false echoes, so as not to confuse them with echoes from legitimate contacts.

4.1 Multiple Echoes

Multiple echoes occur when a short range, strong echo is received from a ship, bridge, or breakwater. A second, a third or more echoes may be observed on the display at double, triple or other multiples of the actual range of the target as shown in Figure 4-1. Multiple reflection echoes can be reduced and often removed by decreasing the sensitivity or properly adjusting the A/C SEA.

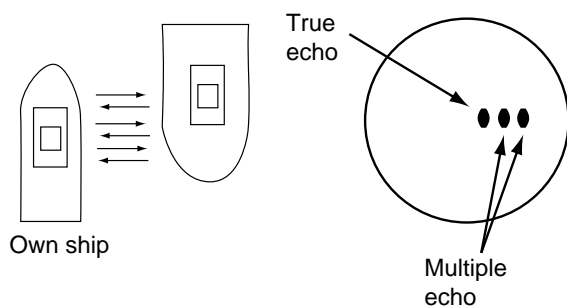

Figure 4-1 Multiple echoes

4.2 Side-lobe Echoes

Every time the antenna rotates, some radiation escapes on each side of the beam—called “side-lobes.” If a target exists where it can be detected by the side-lobes as well as the main-lobe, the side-lobe echoes may be represented on both sides of the true echo at the same range, as shown in Figure 4-2. Side-lobes show usually only at short ranges and from strong targets. They can be reduced through careful reduction of the sensitivity or proper adjustment of the A/C SEA.

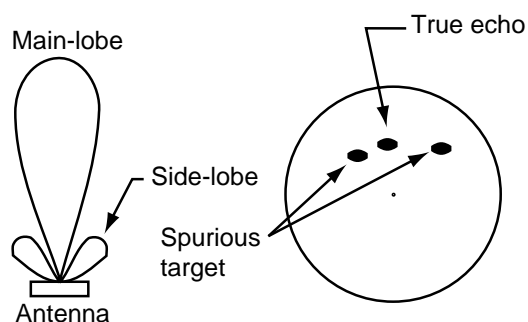

Figure 4-2 Side-lobe echoes

4.3 Indirect Echoes

Indirect echoes may be returned from either a passing ship or returned from a reflecting surface on your own ship, for example, a stack. In both cases, the echo will return from a legitimate contact to the antenna by the same indirect path. The echo will appear on the same bearing of the reflected surface, but at the same range as the direct echo. Figure 4-3 illustrates the effect of an indirect echo. Indirect echoes may be recognized as follows:

- they usually occur in a shadow sector
- they appear on the bearing of the obstruction but at the range of the legitimate contact
- when plotted, their movements are usually abnormal, and
- their shapes may indicate they are not direct echoes.

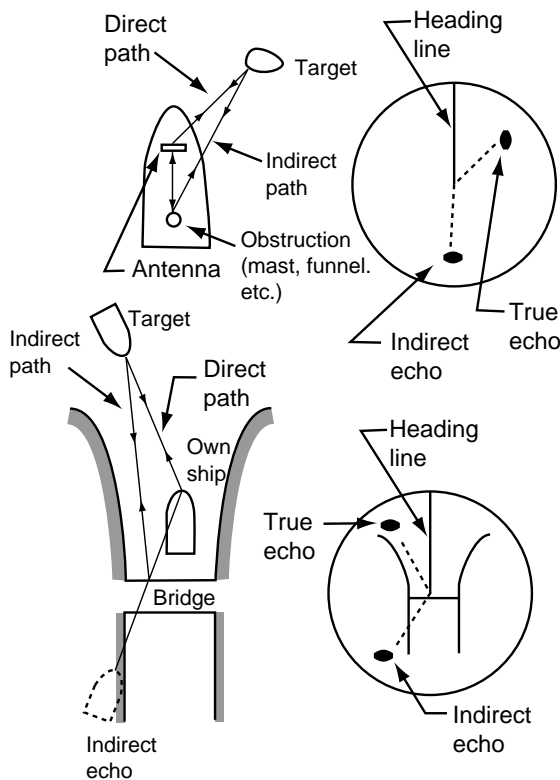

Figure 4-3 Indirect echoes

4.4 Blind and Shadow Sectors

Funnels, stacks, masts, or derricks in the path of antenna may reduce the intensity of the radar beam. If the angle subtended at the antenna is more than a few degrees a blind sector may be produced. Within the blind sector small targets at close range may not be detected while larger targets at much greater ranges may be detected. See Figure 4-4.

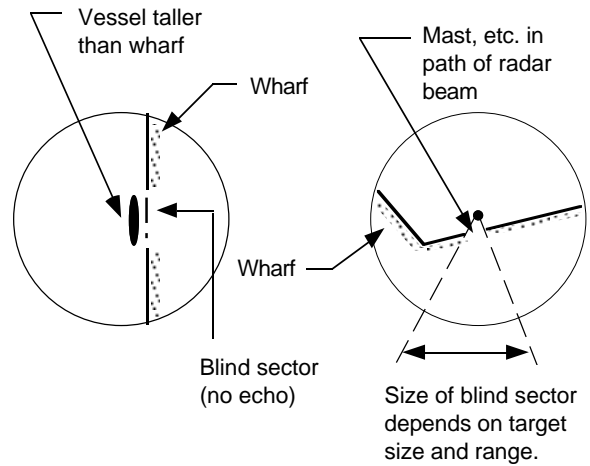

Figure 4-4 Blind and shadow sectors

5. MAINTENANCE & TROUBLESHOOTING

This chapter tells you how to keep your radar in good working order. Before reviewing this chapter please read the safety information which follows.

A maintenance program should be established and should at least include the items listed in Table 5-1.

DANGER

Turn off the power before performing any maintenance or troubleshooting procedure.

Hazardous voltages can shock, burn or cause death. Only qualified personnel totally familiar with electrical circuits should work inside the units.

RF RADIATION HAZARD

The radar scanner emits high frequency radio radiation which can be harmful, particularly to your eyes.

Never look directly into the scanner from a distance of less than two feet when the radar is in operation as you could injure the cornea of your eyes. Always make sure the radar is set to stand-by or is turned off before starting work on the scanner unit.

5.2 Replacing the Fuse

The fuse in the fuse holder at the back of the display unit protects the equipment against reverse polarity of ship's mains, overcurrent, and equipment fault. If the fuse blows, find the cause before replacing it. Never use an incorrect fuse - serious damage to the equipment may result and void the warranty.

FR-7062/7112 is shipped with a 15 A fuse for 12V ship's mains. If the ship's mains is 24/32V, change the fuse to 10 A (supplied).

FR-7252 is supplied with a 10A fuse for 24/32 V ship's mains.

5.1 Preventive Maintenance

Regular maintenance is important for good performance. Always keep the equipment as free as possible from dirt, dust, and water splashes. Make sure all screws securing the components are properly tightened.

CAUTION

Use the proper fuse.

Use of a wrong fuse can result in equipment damage.

Table 5-1 Recommended maintenance program

Period	Item	Check point	Remarks
3 to 6 months	Exposed nuts and bolts on scanner unit	Check for corroded or loosened nuts and bolts. If necessary, clean and repaint them thickly. Replace them if heavily corroded.	Sealing compound may be used instead of paint. Apply a small amount of grease between nuts and bolts for easy removal in future.
	Scanner radiator	Check for dirt and cracks on radiator surface. Thick dirt should be wiped off with soft cloth dampened with fresh water. If a crack is found, apply a slight amount of sealing compound or adhesive as a temporary remedy, then call for repair.	Do not use plastic solvent (acetone) for cleaning. If you need to remove ice from scanner unit, use a wooden hammer or plastic head hammer. Crack on the unit may cause water ingress, causing serious damages to internal circuits.
6 months to 1 year	Display unit connectors	Check for tight connection and corrosion.	If corroded, contact your dealer for replacement.

5.3 Troubleshooting

Table 5-2 contains simple troubleshooting procedures which you can follow to try to restore normal operation. If you cannot restore normal operation, do not attempt to check inside any unit of the radar system. Any repair work is best left to a qualified technician.

Table 5-2 Troubleshooting table

If...	But...	Then...
you pressed the [POWER] key to turn on the radar	the control panel does not light	<ul style="list-style-type: none"> • try adjusting the control panel back-lighting on the OTHERS menu. • battery may have discharged. • check fuse in power cable.
	nothing appears on the display or display contrast is poor	<ul style="list-style-type: none"> • try adjusting the brilliance.
	characters are distorted	<ul style="list-style-type: none"> • request service.
the radar has warmed up and you pressed the [STBY TX] key to transmit	the scanner does not rotate	<ul style="list-style-type: none"> • the problem may be in scanner unit. Request service.
	characters and indications are abnormal	<ul style="list-style-type: none"> • have a qualified technician check the set.
you have adjusted the gain with A/C RAIN and A/C SEA off	neither noise nor targets appear (indications and markers do)	<ul style="list-style-type: none"> • check signal cable for damage.
	neither indications nor markers appear (noise and targets do)	<ul style="list-style-type: none"> • check signal cable for damage.
	the sweep (radial line sweeping around the display) is not synchronized with scanner rotation	<ul style="list-style-type: none"> • the problem may be in the scanner unit. Request service.
	there is no change in sensitivity	<ul style="list-style-type: none"> • request service.
a key is pressed	nothing happens	<ul style="list-style-type: none"> • key may be faulty. Request service.

5.4 Self Test

The self test facility checks the keyboard, ROM and RAM for proper operation.

1. Press the [MENU] key.
2. Select "OTHER MENU".
3. Select "22. Self Test" and press the [ACQ/ENTER] key. The following display appears.

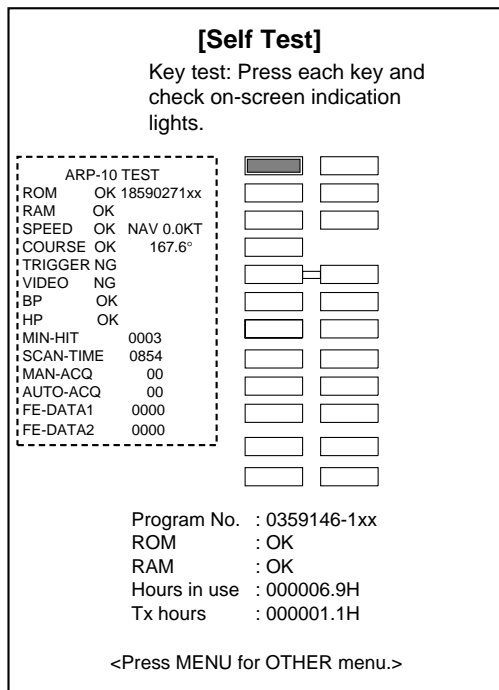

Figure 5-1 Self test screen

4. The ROM and RAM are automatically checked. If NG (No Good) appears to the right of ROM or RAM indication, contact your dealer for advice. ARP-10 TEST results appear only when optional ARP-10 board is mounted.
5. To check the keyboard, press any key except [ACQ/ENTER] and [POWER] keys. The pressed key's on-screen location lights in black while the key is pressed, if the key is operating properly.

6. Press the [ACQ/ENTER] key to check the display circuit. The following pattern should appear.

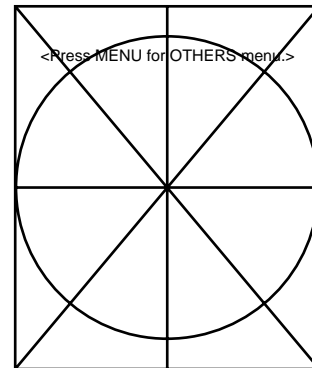

Figure 5-2 Test pattern

7. To return to the Self Test menu, press the [MENU] key.
8. To escape from the self test, press the [MENU] key.

5.5 Life Expectancy of Magnetron

The following table shows the life expectancy of the magnetrons.

Table 5-3 Life expectancy of magnetrons

Model	Type	Code no.	Life expectancy
FR-7062	E3560	000-139-050	2,000-3,000 hours (Including stand-by)
	MG5389	000-135-146	
FR-7112	MG5241	000-100-036	
	E3566	-	
FR-7252	M1458	000-140-344	
	MG5436	000-140-762	

6. ARP-10 (OPTION)

WARNING

No one navigational aid should be relied upon for the safety of vessel and crew. The navigator has the responsibility to check all aids available to confirm position. Electronic aids are not a substitute for basic navigational principles and common sense.

- This auto plotter automatically tracks an automatically or manually acquired radar target and calculates its course and speed, indicating them by a vector. Since the data generated by the auto plotter are based on what radar targets are selected, the radar must always be optimally tuned for use with the auto plotter, to ensure required targets will not be lost or unwanted targets such as sea returns and noise will not be acquired and tracked.
- A target does not always mean a land-mass, reef, ships or other surface vessels but can imply returns from sea surface and clutter. As the level of clutter changes with environment, the operator should properly adjust the A/C SEA, A/C RAIN and GAIN controls to be sure target echoes are not eliminated from the radar screen.

CAUTION

The plotting accuracy and response of this auto plotter meets IMO standards. Tracking accuracy is affected by the following:

- Tracking accuracy is affected by course change. One to two minutes is required to restore vectors to full accuracy after an abrupt course change. (The actual amount depends on gyrocompass specifications.)
- The amount of tracking delay is inversely proportional to the relative speed of the target. Delay is on the order of 15—30 seconds for high relative speed; 30—60 seconds for low relative speed.

Display accuracy is affected by the following:

- Echo intensity
- Radar transmission pulsewidth
- Radar bearing error
- Gyrocompass error
- Course change (own ship or target)

6.1 General

The Auto Plotter ARP-10 is an optional circuit board which is accommodated in the display unit of the FR-7062 radar.

The Auto Plotter permits manual or automatic acquisition and automatic tracking of up to 10 radar targets. An internal microprocessor calculate target data such as speed and course and displays the results in alphanumeric and by vectors. To ensure the reliability of the displayed target data, the radar must be properly adjusted for minimum sea returns and noise.

Principal specifications

Acquisition and tracking

- Acquisition of up to 10 targets between 0.2 and 16 nm.
- Automatic tracking of up to 10 acquired targets between 0.1 and 16 nm.

Vectors

Vector length: 30 s, 1, 3, 6, 15, 30 min.
Orientation: True velocity or relative velocity

Past positions

5 past positions at intervals of 15, 30 s, 1, 2, 3, 6 min.

Alarm

Visual and audible alarms against targets violating CPA/TCPA limits; visual alarm against lost targets.

Target discrimination

A target measuring about 800 m or more in the radial or circumferential direction is regarded as a landmass and not acquired or tracked. Echoes smaller than about 800 m are regarded as true targets.

NOTICE

Heading data required for plotting function.

6.2 Keys Used for Auto Plotter

The Auto plotter utilizes the following touchpad keys. Given below is a brief description of these keys.

MENU:

Displays/Erases the main menu.

SELECT/CANCEL:

(Long press) Terminates plotting of the target selected with the cursor.

(Short press) Displays the data of target selected with the cursor.

ACQ/ENTER:

Acquires the target selected with the cursor.

ARP-10 MENU operation

The ARP-10 MENU includes the followings:

Display:

Turns on/off the plot symbols, past positions and target data.

All Cancel:

Cancels the tracking of all targets.

Vector Ref:

Selects relative vector or true vectors.

Vector Length:

Selects vector time.

History:

Selects past position plot interval.

CPA Set:

Selects CPA alarm limit. When a target is predicted to come within this limit, an aural alarm sounds and at the same time the corresponding target symbol changes to a blinking triangle.

Note: If the preset CPA limit is set at OFF, a target which is on collision course will not produce an alarm.

TCPA Set:

Selects TCPA alarm limit.

Auto ACQ:

Turns on/off Auto Acquisition Area.

6.3 Activating the Auto Plotter

To activate the ARP-10, follow the steps shown below.

1. Adjust the GAIN, A/C SEA and A/C RAIN controls for proper radar picture.
2. Press the [MENU] key to open the main menu.
3. Operate the trackball to select “ARP-10 MENU”.
4. Press the [ACQ/ENTER] key. The menu shown in Figure 6-1 appears.
5. Operate the trackball to select the menu item “1. Display”.
6. Operate the trackball to select “On”.
7. Press the [ACQ/ENTER] key.
8. Press the [MENU] key to close the menu.

[ARP MENU]			
Select item by T-ball and press ENTER key.			
1 . Display	Off	On	
2 . All Cancel			
3 . Vector Ref	Rel	True	
4 . Vector Length		30sec	1min
		3min	6min
		15min	30min
5 . History	Off	15sec	30sec
		2min	3min
		6min	
6 . CPA Set	Off	0.5nm	1nm
		3nm	5nm
		6nm	
7 . TCPA Set	30sec	1min	2min
		4min	5min
		6min	12min
8 . Auto ACQ	Off	On	

Figure 6-1 ARP menu

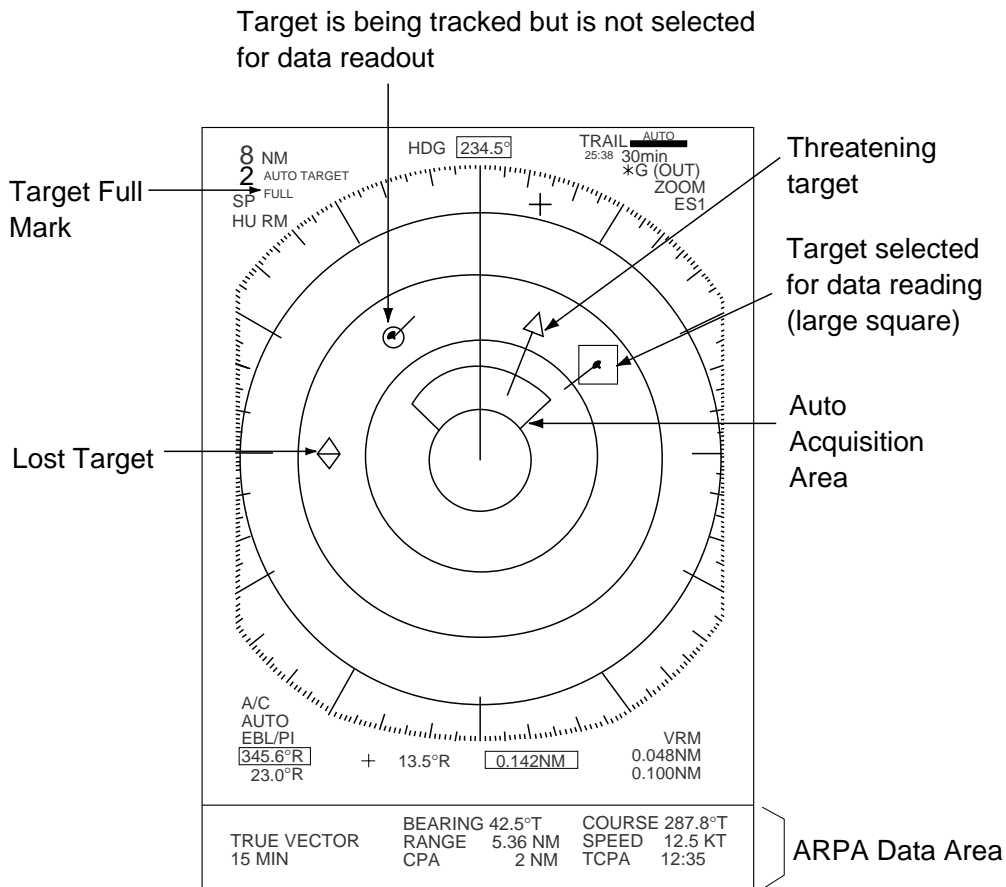

Figure 6-2 ARP display

Deactivating the auto plotter

1. Press the [MENU] key.
2. Open the "ARP-10 MENU".
3. Operate the trackball to select the "1. Display".
4. Operate the trackball to select "Off".
5. Press the [ACQ/ENTER] key.
6. Press the [MENU] key to close the menu.

6.4 Manual Acquisition

Follow the steps below to manually acquire a target. Up to 10 targets can be manually acquired.

1. Place the cursor (+) on a target of interest by operating the trackball.
2. Press the [ACQ/ENTER] key.

The plot symbol changes its shape according to the status as below. A vector appears in about one minute after acquisition indicating the target's motion trend. If the target is consistently detected for three minutes, the plot symbol changes to a solid mark. If acquisition fails, the target symbol blinks and disappears shortly.

 **SQUARE (dotted)**

Immediately after acquisition - Plot symbol shown in broken lines.

 **SQUARE (dotted with a vector)**

One minute after acquisition - Vector still unreliable.

 **CIRCLE (Solid with a vector)**

3 minutes after acquisition - Plot symbol changes to a solid circle indicating the stable tracking condition.

 **LARGE SQUARE**

The plot symbol of a target being tracked becomes twice as large as the normal symbol when the target is selected for data reading.

Note 1: The target to be acquired should be within 0.2 to 16 nm from own ship and not obscured by sea or rain clutter.

Note 2: When you want to acquire 11th target, cancel tracking one of less important targets.

Note 3: When auto acquisition mode (Auto ACQ) is on, up to five targets can be acquired. For details, see 6.5 Automatic Acquisition.

WARNING

When a tracked target nears another tracked target, the targets may be "swapped." When two targets come close to each other, one of the two can become a "lost target." Should this happen, reacquisition of the "lost target" is required after the two targets have separated.

6.5 Automatic Acquisition

The ARP-10 can acquire up to five targets automatically by setting the Auto Acquisition area predefined in the system. If Auto ACQ is selected after more than five targets have been manually acquired, only the remaining capacity of targets can be automatically acquired. For example; when seven targets acquired manually, then the Auto ACQ is switched on, only three targets can be acquire automatically. When five targets have been automatically acquired, "AUTO TARGET FULL" message appears at top left corner seven on the display.

Setting auto acquisition area

Auto acquisition area is predefined between 2.0 and 2.5 nm in range and 45° on either side of the heading maker in bearing. If a target comes into this area, it is acquired automatically.

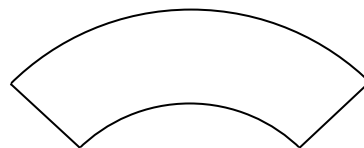

Figure 6-4 Auto acquisition area

Follow the steps below to activate the auto acquisition area.

1. Open the "ARP-10 MENU".
2. Select "8. Auto ACQ" by operating the trackball.
3. Operate the trackball to select "On".
4. Press the [ACQ/ENTER] key.
5. Press the [MENU] key to close the menu.

6.6 Terminating Tracking of Targets

When the ARP-10 has acquired 10 targets, no more acquisition occurs unless targets are lost. Should this happen, cancel tracking of individual targets or all targets by the procedure described below.

Individual targets

Place the cursor (+) on the target which you do not want to be tracked any longer by operating the trackball and press and hold down the [SELECT/CANCEL] key.

All targets

Tracking of all targets can be canceled from the ARP-10 MENU.

1. Open the "ARP-10 MENU".
2. Select "2. All Cancel".
3. Press the [ACQ/ENTER] key.

6.7 Displaying Target Data

The ARP-10 calculates motion trends (range, bearing, course, speed, CPA and TCPA) of all targets being tracked at the ARPA Data area.

To turn ARPA data on;

1. Press the [MENU] key.
2. Select the "DISP DATA".
3. Press the [ACQ/ENTER] key to select the message for "ARP" or "NAV and ARP".
4. Press the [ACQ/ENTER] key to set.
5. Press the [MENU] key to close the menu.

CAUTION

At the speed under 5 kts the target data is displayed with a delay because of filtration.

Place the cursor on a wanted target and press the [SELECT/CANCEL] key. Data on the selected target is displayed at the bottom of the screen. The symbol of the selected target gets twice as large as the normal circle. The data includes the following;

RNG/BRG (Range/Bearing): Range and bearing from own ship to the last-plotted or selected target position with suffix "T" (True) or "M" (Magnetic). For true bearings suffix "T" is used in case of gyrocompass input and suffix "M" is used in case of magnetic compass input.

Note: "M" is not displayed on N-type radar.

COURSE/SPEED (Course/Speed): Course and speed are displayed for the last-plotted or selected target with suffix "T" (True) or "M" (Magnetic). For true bearings suffix "T" is used in case of gyrocompass input and suffix "M" is used in case of magnetic compass input.

Note: "M" is not displayed on N-type radar.

CPA (Closest Point of Approach): The closest range a target will approach to own ship. Do not confuse it with the operator preset CPA alarm limit.

TCPA: The time to CPA measured with present speeds of own ship and the targets. Both CPA and TCPA are automatically calculated. When a target ship has passed clear of own ship, the CPA is displayed and the TCPA appears as "**.*". TCPA is counted up to 99.9 min. and beyond this it is indicated as TCPA>99.9 min.

6.8 Mode and Length of Vectors

True or relative vector

Target vectors are displayed in relative or true mode. Own ship does not have a vector in relative mode.

Vector length

From the ARP-10 MENU, Vector Length can be set to 30 seconds, 1, 3, 6, 15 or 30 minutes and the selected vector time is indicated on the screen.

The vector tip shows an estimated position of the target after the selected vector time elapses. It can be valuable to extend the vector length to evaluate the risk of collision with any target.

Past position display

The ARP-10 displays equally time-spaced dots (maximum 5 dots) marking the past positions of any targets being tracked.

If a target changes its speed, the spacing will be uneven. If it changes course, its plotted course will not be a straight line in TM mode.

Operational warnings

There are two main situations which cause the ARP-10 to trigger visual and audible alarms:

- CPA/TCPA alarm
- Lost target alarm

CPA/TCPA alarm

Visual and audible alarms are generated when the predicted CPA and TCPA of any target become less than their preset limits. The audible alarm continues for 10 seconds.

The ARP-10 continuously monitors the predicted range at the Closest Point of Approach (CPA) and predicted time to CPA (TCPA) of each tracked target to own ship.

When the predicted CPA of any target becomes smaller than a preset CPA alarm range and its predicted TCPA less than a preset TCPA alarm limit, the ARP-10 releases an audible alarm. In addition, the target plot symbol changes to a triangle and flashes together with its vector.

Provided that this feature is used correctly, it will help prevent the risk of collision by alerting you to threatening targets. It is important that GAIN, A/C SEA, A/C RAIN and other radar controls are properly adjusted and the ARP-10 is set up so that it can track targets effectively.

CPA/TCPA alarm ranges must be set up properly taking into consideration the size, tonnage, speed, turning performance and other characteristics of own ship.



WARNING

The CPA/TCPA alarm feature should never be relied upon as a sole means for detecting the risk of collision. The navigator is not relieved of the responsibility to keep visual lookout for avoiding collisions, whether or not the radar or other plotting aid is in use.

Follow the steps shown below to set the CPA/TCPA alarm ranges:

1. Open the "ARP-10 MENU".
2. On the "CPA Set" line, select a CPA limit desired. (Off, 0.5, 1, 2, 3, 5, 6 nm)
3. Press the [ACQ/ENTER] key.
4. On the "TCPA Set" line, select a TCPA limit desired. (30s, 1, 2, 3, 4, 5, 6, 12M)
5. Press the [ACQ/ENTER] key.
6. Press the [MENU] key to close the menu.

The flashing of the triangle plot symbol and vector remains on the screen until the dangerous situation is no longer present or you intentionally terminate tracking of the target by using the [SELECT/CANCEL] key.

Lost target alarm

When the system detects a loss of a tracked target, the target symbol becomes a flashing diamond.

SPECIFICATIONS OF MARINE RADAR

FR-7062/7112/7252

1. GENERAL

(1) Indication System PPI Daylight display, raster scan, 8 tones in monochrome

(2) Range, Pulselength (PL) & Pulse Repetition Rate (PRR)

(range max. FR-7062: 64 nm, FR-7112: 72 nm, FR-7252: 96 nm)

		Range (nautical miles)																				
PL	PRR	0.125	0.25	0.5	0.75	1	1.5	2	3	4	6	8	12	16	24	36	48	64	72	96		
SP	2100 Hz	0.08 μ s																				
MP	1200 Hz						0.3 μ s															
LP	600 Hz*								0.8 μ s													

**550 Hz on 48 nm to 72 nm range, or 500 Hz on 96 nm range*

(3) Range Resolution Better than 20 m

(4) Bearing Discrimination XN12A: within 1.9°, XN13A: within 1.2°

(5) Minimum Range 25 m (0.25 NM range)

(6) Bearing Accuracy Within 1°

(7) Range Ring Accuracy 0.9 % of range or 8 m, whichever is the greater

2. SCANNER UNIT

(1) Radiator Slotted waveguide array

(2) Polarization Horizontal

(3) Antenna Rotation Speed 24 rpm nominal: XN12A (100 kt max.), XN13A (100 kt max.)
48 rpm nominal: XN12A (70 kt max.)

(4) Radiator Length XN12A:120 cm, XN13A: 180 cm

(5) Horizontal Beamwidth XN12A: 1.9°, XN13A: 1.2°

(6) Vertical Beamwidth 22°

(7) Sidelobe Attenuation

XN12A: Within $\pm 20^\circ$ of main-lobe: less than -24 dB

Outside $\pm 20^\circ$ of main-lobe: less than -30 dB

XN13A: Within $\pm 10^\circ$ of main-lobe: less than -24 dB

Outside $\pm 10^\circ$ of main-lobe: less than -30 dB

3. TRANSCEIVER MODULE

(1) Frequency 9410 MHz ± 30 MHz (X band)

(2) Modulation P0N

(3) Peak Output Power FR-7062: 6 kW, FR-7112: 12 kW, FR-7252: 25 kW

(4) Modulator FET Switching Method

- (5) Intermediate Frequency 60 MHz
- (6) Tuning Automatic or manual
(for manual, select manual tuning on menu and tune by trackball)
- (7) Receiver Front End MIC (Microwave IC)
- (8) Bandwidth Tx pulselength 0.08 s and 0.3 s: 25 MHz
Tx pulselength 0.8 s: 3 MHz
- (9) Duplexer Circulator with diode limiter

4. DISPLAY UNIT

- (1) Indication System PPI Daylight display, raster scan, 8 colors
- (2) Picture Tube 12 inch rectangular (184 mm x 245 mm) monochrome CRT
effective display area more than 180 mm

- (3) Range, Range Interval, Number of Rings

(range max. FR-7062: 64 nm, FR-7112: 72 nm, FR-7252: 96 nm)

Range (NM)	0.125	0.25	0.5	0.75	1	1.5	2	3	4	6	8	12	16	24	36	48	64	72	96
Ring Interval (NM)	0.0625	0.125	0.125	0.25	0.25	0.5	0.5	1	1	2	2	3	4	6	12	12	16	18	24
Number of Rings	2	2	4	3	4	3	4	3	4	3	4	4	4	4	3	4	4	4	4

- (4) Markers Heading Line, Bearing Scale, Range Rings,
Variable Range Marker (VRM1, VRM2),
Electronic Bearing Line (EBL1, EBL2),
Tuning Bar, Cursor, Parallel Cursor,
Alarm Zone, Waypoint Mark (navigation input required),
North Mark (heading sensor input required)
- (5) Alphanumeric Indications Range, Range Ring Interval, Pulselength(SP, MP, LP),
Display Mode(HU, CU, NU, TM),
Interference Rejection(IR1, IR2, IR3),
Variable Range Marker(VRM1, VRM2),
Electronic Bearing Line (EBL1, EBL2),
Automatic A/C SEA (A/C AUTO), Stand-by (ST-BY),
Radar Alarm (G(IN), G(OUT), G(ACKN)),
Echo Stretch (ES1, ES2), Cursor Range, Bearing or L/L Position,
Echo Tailing (TRAIL), Trailing Time, Trailing Elapsed Time,
Navigation Data(navigation input required),
Heading (HDC, heading sensor input required)
- (6) Input Data NMEA0183 (Ver.1.5/2.0), current loop
Own ship's position: GGA>RMC>RMA>GLL (GLL is available Ver.1.5 only)
Speed: RMC>RMA>VTG>VHW
Heading (True): HDT>HDG^{*1}>HDM^{*1}>VHW>VHW^{*1}

Heading (Magnetic): HDM>HDG^{*1}>HDT^{*1}>VHW>VHW^{*1}
 Course (True): RMC>RMA>VTG
 Course (Magnetic): VTG>RMC>RMA
 Waypoint(Range, Bearing): RMB>BWC>BWR
 Loran time difference: RMA>GLC>GTD
 Water depth: DPT>DBT>DBK>DBS
 Water temperature: MTW>MDA
 Time: ZDA
 XTE: RMB>XTE>APB

*1: calculate by magnetic drift.

(7) Output Data NMEA0183(Ver.1.5/2.0), RS-422
 TLL (target data) and RSD

5. ENVIRONMENTAL CONDITION

(1) Ambient Temperature Scanner Unit: -25°C to +70°C
 Display Unit: -15°C to +55°C
 (2) Relative Humidity 95 % or less at +40°C
 (3) Waterproofing
 Scanner Unit IPX6
 Display Unit Chassis: not specified
 Panel: IPX4

6. POWER SUPPLY & POWER CONSUMPTION

(1) Power Supply FR-7062/7112: 12/24/32 VDC (10.8 to 41.6 VDC)
 FR-7252: 24/32 VDC (21.6 to 41.6 VDC)
 (2) Voltage and Current
 FR-7062 XN12A(24rpm): 12 VDC/7.5A, 24VDC/3.8A, 32VDC/2.8A
 XN12A(48rpm): 12 VDC/8.8A, 24VDC/4.4A, 32VDC/3.3A
 XN13A(24rpm): 12VDC/10A, 24VDC/5A, 32VDC/3.8A
 FR-7112 XN12A(24rpm): 12 VDC/8.3A, 24VDC/4.2A, 32VDC/3.1A
 XN12A(48rpm): 12 VDC/10A, 24VDC/5A, 32VDC/3.8A
 XN13A(24rpm): 12 VDC/10.8A, 24VDC/5.4A, 32VDC/4.1A
 FR-7252 XN12A(24rpm): 24VDC/5.2A, 32VDC/3.9A
 XN12A(48rpm): 24VDC/5.8A, 32VDC/4.4A
 XN13A(24rpm): 24VDC/6.3A, 32VDC/4.7A
 (3) Power Consumption
 FR-7062 XN12A(24rpm): 70 W to 90 W(100 kt)
 XN12A(48rpm): 85 W to 105 W(70 kt)

FR-7112	XN13A(24rpm): 80 W to 120 W(100 kt)
	XN12A(24rpm): 85 W to 100 W(100 kt)
	XN12A(48rpm): 95 W to 120 W(70 kt)
FR-7252	XN13A(24rpm): 90 W to 130 W(100 kt)
	XN12A(24rpm): 105 W to 125 W(100 kt)
	XN12A(48rpm): 120 W to 140 W(70 kt)
	XN13A(24rpm): 115 W to 150 W(100 kt)

7. DIMENSIONS AND MASS

See Outline Drawings

8. COVERTING COLOR

- | | |
|------------------|---------------------|
| (1) Display Unit | Panel: N3.0 |
| | Chassis: 2.5GY5/1.5 |
| (2) Scanner Unit | N9.5 |

9. COMPASS SAFE DISTANCE

- | | | |
|------------------|-----------------|-----------------|
| (1) Display Unit | Standard: 1.1 m | Steering: 0.8 m |
| (2) Scanner Unit | | |
| FR-7062/7112 | Standard: 1.0 m | Steering: 0.8 m |
| FR-7252 | Standard: 1.7 m | Steering: 1.3 m |

10. ARP MODULE (OPTION)

- | | |
|---------------------------------|--|
| (1) Acquisition Range | 0.2 to 16 NM |
| (2) Tracking Range | 0.1 to 16 NM |
| (3) Maximum Number of Target | 10 |
| (4) Acquisition Time | Within 5 sec (scanner rotation: 24 rpm) |
| (5) Alarm Timing | Lost target (blink mark, collision alert) |
| (6) Vector Length | 30 sec; 1, 3, 6, 15 or 30 min (selected on menu) |
| (7) Plotting Interval | 15, 30 sec; 1, 2, 3 or 6 min (selected on menu) |
| (8) Numeric Data Indication | Distance, Bearing, Course, Speed, CPA, TCPA |
| (9) Acquisition Available Speed | 100 kt relative |

Index

A

Acquisition	6-4
A/C RAIN	2-5
A/C SEA	2-4
ARPA	6-2

B

Bearing	2-7
Blind Sectors	4-4
Brilliance	2-4, 3-8

C

Course Up	2-6
CPA/TCPA alarm	6-6
Cursor	2-7

E

EBL	2-7
Echo Stretch	2-6
Echo Trail	3-4
Echonomy Mode	2-3

F

Function Keys	3-8
Fuse	5-1

G

Gain	2-4
Guard Alarm	3-4
Guard zone	3-4

H

Head Up	2-6
Heading Marker	2-6

I

Index Line	3-1
Indirect Echoes	4-2
Interference	3-2

L

Lost target alarm	6-6
-------------------------	-----

M

Magnetron	5-3
Multiple Echoes	4-1
MENU TREE	vii

N

Navigation Data	2-3, 3-3
Noise	3-8
North Marker	2-6
North Up	2-6

O

OTHER MENU	3-7
Offcenter	2-9
Offset EBL	2-8

P

Presentation Mode	2-6
Preventive Maintenance	5-1
Program No.	5-3
Pulsewidth	2-4
Pulselength	2-4

R

Range	2-4
Range Ring	2-4

S

SART	iii
Second-trace echoes	3-8
Self Test	5-3
Sensitivity	2-4
Shadow Sectors	4-2
Side-lobe Echoes	4-1
Stand-by	2-3

T

TLL	3-8
Trail tone	3-4
Transmitting	2-3
Troubleshooting	5-2
Turning On and Off	2-3

V

Vector length	6-6
Vector mode	6-6
VRM	2-7

W

Watchman	3-6
----------------	-----

Z

Zoom	2-9
------------	-----

FURUNO**FURUNO ELECTRIC CO., LTD.**

9-52 Ashihara-Cho, Nishinomiya City, 662-8580, Hyogo, Japan

Tel: +81 798-65-2111 Fax: +81 798-65-4200

Pub NO. DOC-301

Declaration of ConformityWe **FURUNO ELECTRIC CO., LTD.**-----
(Manufacturer)

9-52 Ashihara-Cho, Nishinomiya City, 662-8580, Hyogo, Japan

(Address)

declare under our sole responsibility that the product

X-band radar Model FR-7062 for navigation**(Serial No. 3373-0005)**-----
(Model name, serial number)

is in conformity with the essential requirements as described in the Directive 1999/5/EC of the European Parliament and of the Council on radio equipment and telecommunications terminal equipment (R&TTE Directive) and satisfies all the technical regulations applicable to the product within this Directive

EN 60945: 1997-01 (IEC 60945 Third edition: 1996-11)**ITU R.R. App. S3 Table 2, Edition 1998**-----
(title and/or number and date of issue of the standard(s) or other normative document(s))

For assessment, see

- Statement of Opinion N° 00214131/AA/00 of 3 January 2001 issued by KTL Certification, The Netherlands
- Test report 96310720 of 1 October 1998 prepared by Telefication, The Netherlands and TI-1672 of 26 February 1998 prepared by Furuno Electric Co., Ltd.

On behalf of Furuno Electric Co., Ltd.

Hiroaki Komatsu

Manager,

International Rules and Regulations

Nishinomiya City, Japan

January 15, 2001

(Place and date of issue)-----
(name and signature or equivalent marking of authorized person)

FURUNO

FURUNO ELECTRIC CO., LTD.

9-52 Ashihara-Cho, Nishinomiya City, 662-8580, Hyogo, Japan

Tel: +81 798-65-2111 Fax: +81 798-65-4200

Pub NO. DOC-300

Declaration of Conformity

We **FURUNO ELECTRIC CO., LTD.**-----
(Manufacturer)

9-52 Ashihara-Cho, Nishinomiya City, 662-8580, Hyogo, Japan

(Address)

declare under our sole responsibility that the product

**X-band radar Model FR-7112 for navigation
(Serial No. 3373-0005)**-----
(Model name, serial number)

is in conformity with the essential requirements as described in the Directive 1999/5/EC of the European Parliament and of the Council on radio equipment and telecommunications terminal equipment (R&TTE Directive) and satisfies all the technical regulations applicable to the product within this Directive

**EN 60945: 1997-01 (IEC 60945 Third edition: 1996-11)
ITU R.R. App. S3 Table 2, Edition 1998**-----
(title and/or number and date of issue of the standard(s) or other normative document(s))

For assessment, see

- Statement of Opinion N° 00214133/AA/00 of 4 January 2001 issued by KTL Certification, The Netherlands
- Test report 96323020 of 20 August 1998 prepared by Telefication, The Netherlands and TI-1673 of 26 February 1998 prepared by Furuno Electric Co., Ltd.

On behalf of Furuno Electric Co., Ltd.

**Hiroaki Komatsu
Manager,
International Rules and Regulations****Nishinomiya City, Japan
January 15, 2001**-----
(Place and date of issue)-----
(name and signature or equivalent marking of authorized person)

FURUNO**FURUNO ELECTRIC CO., LTD.**

9-52 Ashihara-Cho, Nishinomiya City, 662-8580, Hyogo, Japan

Tel: +81 798-65-2111 Fax: +81 798-65-4200

Pub NO. DOC-302

Declaration of ConformityWe **FURUNO ELECTRIC CO., LTD.**-----
(Manufacturer)

9-52 Ashihara-Cho, Nishinomiya City, 662-8580, Hyogo, Japan

(Address)

declare under our sole responsibility that the product

**X-band radar Model FR-7252 for navigation
(Serial No. 3375-0002)**-----
(Model name, serial number)

is in conformity with the essential requirements as described in the Directive 1999/5/EC of the European Parliament and of the Council on radio equipment and telecommunications terminal equipment (R&TTE Directive) and satisfies all the technical regulations applicable to the product within this Directive

**EN 60945: 1997-01 (IEC 60945 Third edition: 1996-11)
ITU R.R. App. S3 Table 2, Edition 1998**-----
(title and/or number and date of issue of the standard(s) or other normative document(s))

For assessment, see

- Statement of Opinion N° 00214135/AA/00 of 4 January 2001 issued by KTL Certification, The Netherlands
- Test report 96323120 of 20 August 1998 prepared by Telefication, The Netherlands and TI-1674 of 13 March 1998 prepared by Furuno Electric Co., Ltd.

On behalf of Furuno Electric Co., Ltd.

**Hiroaki Komatsu
Manager,
International Rules and Regulations****Nishinomiya City, Japan
January 15, 2001**-----
(Place and date of issue)-----
(name and signature or equivalent marking of authorized person)

Free Manuals Download Website

<http://myh66.com>

<http://usermanuals.us>

<http://www.somanuals.com>

<http://www.4manuals.cc>

<http://www.manual-lib.com>

<http://www.404manual.com>

<http://www.luxmanual.com>

<http://aubethermostatmanual.com>

Golf course search by state

<http://golfingnear.com>

Email search by domain

<http://emailbydomain.com>

Auto manuals search

<http://auto.somanuals.com>

TV manuals search

<http://tv.somanuals.com>