

# **FURUNO**

## **OPERATOR'S MANUAL**

*DOPPLER SONAR*

**MODEL**      **DS-30**

---

 **FURUNO ELECTRIC CO., LTD.**

[www.furuno.co.jp](http://www.furuno.co.jp)

**ECF**

(Elemental Chlorine Free)

The paper used in this manual  
is elemental chlorine free.

**FURUNO ELECTRIC CO., LTD.**

9-52 Ashihara-cho,  
Nishinomiya, 662-8580, JAPAN

Telephone : +81-(0)798-65-2111

Fax : +81-(0)798-65-4200

• FURUNO Authorized Distributor/Dealer

All rights reserved. Printed in Japan

Pub. No. OME-72360-U

(TATA ) DS-30

A : AUG . 1992

U : SEP . 16, 2009



\* 0 0 0 8 0 4 7 4 4 1 4 \*



# SAFETY INSTRUCTIONS



## WARNING



**ELECTRICAL SHOCK HAZARD**  
Do not open the equipment.

Only qualified personnel should work inside the equipment.

**Immediately turn off the power at the switchboard if water leaks into the equipment or an object is dropped into the equipment.**

Continued use of the equipment can cause fire or electrical shock. Contact a FURUNO agent for service.

**Do not place liquid-filled containers on the top of the equipment.**

Fire or electrical shock can result if the liquid spills into the equipment.

**Do not disassemble or modify the equipment.**

Fire, electrical shock or serious injury can result.

**Keep the equipment away from rain and water splash.**

Fire or electrical shock can result if the rain or water gets into the equipment.

**Do not operate the equipment with wet hands.**

Electrical shock can result.

**Keep heater away from equipment.**

A heater can melt the equipment's power cord, which can cause fire or electrical shock.

**Use the proper fuse.**

Fuse rating is shown on the equipment. Use of a wrong fuse can result in damage to the equipment.



## CAUTION

**Do not use the equipment for other than its intended purpose.**

Improper use of the equipment can result in personal injury or equipment damage.

**Turn off the equipment immediately if you feel it is abnormal.**

Turn off the power from the switchboard if the equipment is emitting strange noises or becomes excessively hot. Contact your dealer for advice.

**The useable ambient temperature range is 15°C to 55°C.**

Do not use the equipment out of the above temperature range.

**Do not place objects around the equipment.**

Overheating may result.

**Do not power the equipment when the transducer is in air.**

The transducer may become damaged.

**Handle all units carefully.**

Damage can lead to corrosion.

**Do not use chemical cleaners such as alcohol, acetone and benzene to clean the equipment.**

Chemical cleaners can remove paint and markings. Use only a soft, dry cloth. For stubborn dirt, use a soft cloth moistened with water-diluted mild detergent.

**When dry docked remove marine life from the transducer.**

Remove marine life to maintain good sensitivity.

**Do not paint the transducer face. Further, handle the transducer with care.**

Paint will affect equipment performance.

**⚠ CAUTION**

**If the optional rate gyro is installed, turn on the power when the ship is dead in water or running straight.**

The heading generated by the rate gyro is used as reference, therefore turning on the equipment while the ship is turning will result in large heading error.

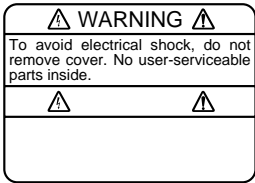

Name: Warning Label (1)  
 Type: 86-003-1011  
 Code No.: 100-236-230

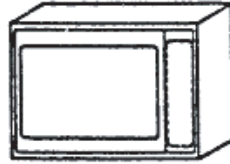

MAIN DISPLAY UNIT  
DS-300/301

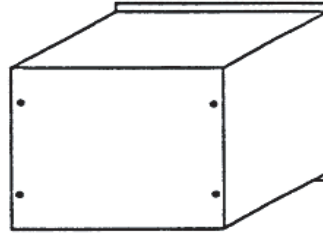

PROCESSOR UNIT  
DS-310

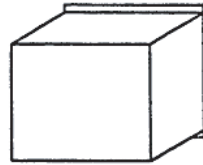

TRANSCIVER UNIT  
DS-320

Warning label

# Table of Contents

---

<b>1. GENERAL</b> .....	<b>1-1</b>
Features .....	1-1
Principle of Doppler Sonar .....	1-2
<b>2. SYSTEM CONFIGURATION</b> .....	<b>2-1</b>
Standard Supply .....	2-1
Optional Supply .....	2-1
<b>3. CONTROL PANEL</b> .....	<b>3-1</b>
Main Display.....	3-1
Operation Panel .....	3-2
<b>4. TURNING ON/OFF POWER</b> .....	<b>4-1</b>
Turning On Power.....	4-1
Turning Off Power.....	4-1
<b>5. NAV DATA MODE OPERATION</b> .....	<b>5-1</b>
Basic Operation .....	5-1
Interpreting Readings and Advanced Operation.....	5-2
1. Ship's Speed.....	5-2
2. Course.....	5-2
3. Ship's Heading.....	5-3
4. Drift.....	5-3
5. Transverse Speed at Bow .....	5-3
6. Longitudinal Speed at Stern.....	5-3
7. Transverse Speed at Stern* .....	5-3
8. Speed Graph.....	5-3
9. Echo Monitor .....	5-3
10. Tracking Mode.....	5-3
11. Date.....	5-4
12. Time.....	5-4
13. Nav Speed/ Course .....	5-4
14. Engine Rev. Ship's Position .....	5-4
15. Current .....	5-4
16. Wind .....	5-5
17. Under-keel Clearance (UKC).....	5-6
18. Under-keel Clearance Graphic.....	5-6
19. Bottom Hardness.....	5-7
20. Voyage Distance /21. Total Distance .....	5-7
<b>6. SPEED DATA MODE OPERATION</b> .....	<b>6-1</b>
Basic Operation .....	6-1
Interpreting Readings and Advanced Operation.....	6-2
1. Echo Monitor .....	6-2
2. Tracking Mode.....	6-2
3. Transverse Speed at Bow .....	6-2
4. Longitudinal Speed at Stern.....	6-2

5. Transverse Speed at Stem .....	6-2
6. Nav Speed/ Course .....	6-2
7. Under-keel Clearance (UKC).....	6-2
8. Total Distance.....	6-3
<b>7. BERTHING MODE OPERATION .....</b>	<b>7-1</b>
Basic Operation.....	7-1
Interpreting Readings and Advanced Operation .....	7-2
1. Own ship .....	7-2
2. Ship's Plot .....	7-2
3. Scale .....	7-3
4. Marker Line .....	7-3
5. Cursor/Marker Line Date .....	7-3
6. Heading up/ North up Indication .....	7-3
7. Tracking Mode.....	7-4
8. Heading.....	7-4
9. Rate of Turn .....	7-4
10. Current .....	7-4
11. Wind .....	7-5
12. Under-keel Clearance.....	7-5
13. Ship's Speed .....	7-6
<b>8. DIGITAL INDICATOR DS-350/351 .....</b>	<b>8-1</b>
DS-350 (LCD Display for Outdoor Use) .....	8-1
Display/Control Panel.....	8-1
DS-351 (LED Display for Indoor Use).....	8-3
Display/Control Panel.....	8-3
Interpreting the Display.....	8-4
<b>9. OPERATION ON USER MENU.....</b>	<b>9-1</b>
General .....	9-1
Structure of Menu .....	9-1
General Rule for Operation on User Menu .....	9-3
Operating Menu .....	9-3
Changing Setting in Menu .....	9-3
Alarm Setting Window .....	9-4
R. O. T. Speed Alarm Setting Window .....	9-4
Speed/Direction (Course) Alarm Setting Window.....	9-5
Distance Alarm Setting Window.....	9-7
Set Display Menu .....	9-8
Set Alarm Menu.....	9-9
Self-test Menu .....	9-10
Init. Setup Menu .....	9-11
Parameter Menu (only for main display) .....	9-13
Offset Data Menu .....	9-14

<b>10. SELF-CHECK.....</b>	<b>10-1</b>
Self-Check.....	10-1
Procedure.....	10-1
Panel Test.....	10-1
Single Test.....	10-2
Continuous Test.....	10-2
TX/RX Test.....	10-3
Error Warning.....	10-4
Troubleshooting Flow Chart.....	10-5
<b>11. SYSTEM MENU SETTING.....</b>	<b>11-1</b>
Opening System Menu.....	11-1
Closing System Menu.....	11-1
Operation on System Menu.....	11-1
Content of System Menu.....	11-1
Display Unit Preset Menu.....	11-1
Display Test Menu.....	11-2
Ship Data Menu.....	11-2
External Sensor Menu.....	11-3
<b>12. REPLACEMENT OF SENSOR IN RATE-OF-TURN GYRO (OPTION).....</b>	<b>12-1</b>
<b>13. SPECIFICATIONS OF DOPPLER SONAR.....</b>	<b>13-1</b>
<b>14. TABLES FOR RECORDING USER PRESETS.....</b>	<b>14-1</b>
<b>15. DIGITAL INTERFACE (IEC 61162-1 EDITION 2).....</b>	<b>15-1</b>
<b>16. PROGRAM NUMBER.....</b>	<b>16-1</b>

**Declaration of conformity**

This page is intentionally left blank.



# 1. GENERAL

The DS-30 is a highly-advanced, precision Doppler Sonar which incorporates FURUNO's long established ultrasonic technology.

It provides accurate displays of ship's speed over a wide range from dead slow to maximum. Speeds are detected relative to the ground or water both fore-aft and athwartship. This feature allows precise docking of mammoth tankers to oil loading/unloading facilities, as well as safe navigation in narrow channels or straits.

## Features

- 1) High measuring accuracy of  $\pm (0.2\% + 0.01 \text{ mm/sec})$  or better for low longitudinal speed, even in shallow waters with under keep clearance as little as 1 meter, enables close control of speed and safe berthing and anchoring operations.
- 2) Ground tracking up to 200 m provides accurate ship's ground speed in most coastal waters.
- 3) Single hull unit composition with employment of the rate-of-turn gyro economizes installation and maintenance costs. (Most other doppler sonars use two hull units: one each for measuring ship's transverse speed at the fore and the stern.
- 4) Rate-of-turn gyro uses optical fibers instead of moving parts, providing high reliability.
- 5) Logically arranged presentations of information on the color LCD for instant recognition of ship's motion and speed together with under-keel clearance, current and wind conditions.
- 6) GPS navigator connection provides ship's ground speed at all times.
- 7) Conforms to the following standards: IMO A.824(19), as amended by MSC.96(72), IMO A.694(17), IEC 61023, IEC 60945 (3<sup>rd</sup> edition), IEC 61162-1 (2<sup>nd</sup> edition)

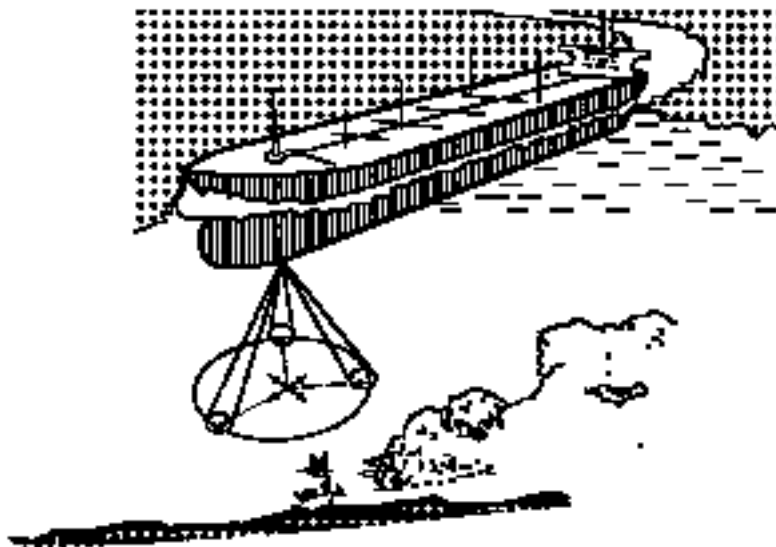

# Principle of Doppler Sonar

The Doppler sonar measures ship's speed by utilizing the principle of the Doppler effect, which defines that a signal emitted from a moving object is heard with its frequency shifted at stationary locations and the degree of the frequency shift is proportional to the speed of the moving object.

For ease of understanding, in this paragraph, measurement of ship's fore-aft speed is explained.

Although the DS-30 employs three directional beams as shown in the illustration on the preceding page, let's suppose that only two beams are used as shown at right.

Ultrasonic waves are emitted at an angle of  $\theta$  relative to water line toward ship's fore and aft directions. If the ship's speed is "V", the source of the ultrasonic wave (transducer) approaches or goes away the reflecting points on the seabed at a speed of  $V \cos \theta$ .

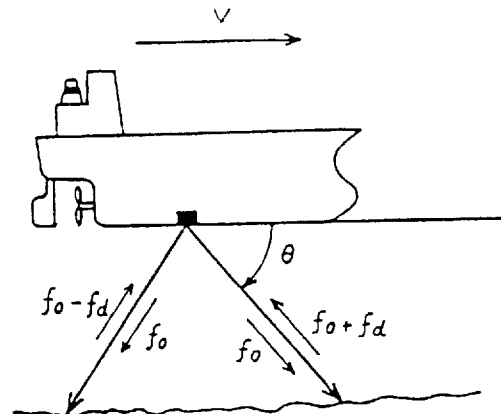

This relative motion causes the Doppler shift and the ultrasonic waves reflected at the seabed are received at frequencies of " $f_o + f_d$ " and " $f_o - f_d$ " by the transducer. In the processor unit of the DS-30, difference of " $f_o + f_d$ " and " $f_o - f_d$ " are computed to extract only the Doppler shift factor " $f_d$ ".

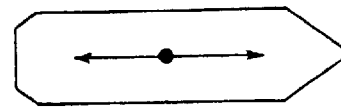

$$"f_o + f_d" - "f_o - f_d" = 2f_d$$

Since the " $f_d$ " is theoretically given by

$f_d = 2V \cos \theta \times f_o / C$  (C: Sound velocity in water)

and  $f_o$ , C and  $\theta$  are known, V can be calculated if the " $f_d$ " is given.

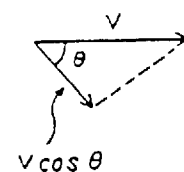

Note that the sound velocity in water changes with water temperature and water pressure but the change by water temperature is automatically compensated by using temperature sensor.

## 2. SYSTEM CONFIGURATION

### Standard Supply

No.	Name	Type	Weight	Qty	Remarks
1	Display	DS-300/301	8/1.5	1	Flush mount
2	Processor Unit	DS-310	40	1	Bulkhead or floor mount
3	Transceiver Unit	DS-320	14	1	Bulkhead or floor mount
4	Transducer	DS-330	9	1	
5	Hull Unit	DS-331	82	1	
6	Accessories			1 set	
7	Spare Parts			1 set	
8	Installation Materials			1 set	

### Optional Supply

No.	Name	Type	Weight	Qty	Remarks
1	Rate-of-Turn Gyro	DS-340	5.5	1	Floor mount
2	Digital Indicator	DS-350	7.0	1	Waterproof, bulkhead or panel mount
3	Digital Indicator	DS-351	4.0	1	Bulkhead or panel mount
4	Distribution Box	DS-370	19.0	1	Bulkhead or floor mount
5	Distance Indicator	MF-22T	6.0	1	
6	Analog Indicator	MF-22A	6.0	1	
7	Analog Indicator	DS-381	6.4	1	Flush mount
8	Analog Indicator	DS-382	6-0	1	Bulkhead mount
9	Junction Box	DS-360			Bulkhead or floor mount



# 3. CONTROL PANEL

## Main Display

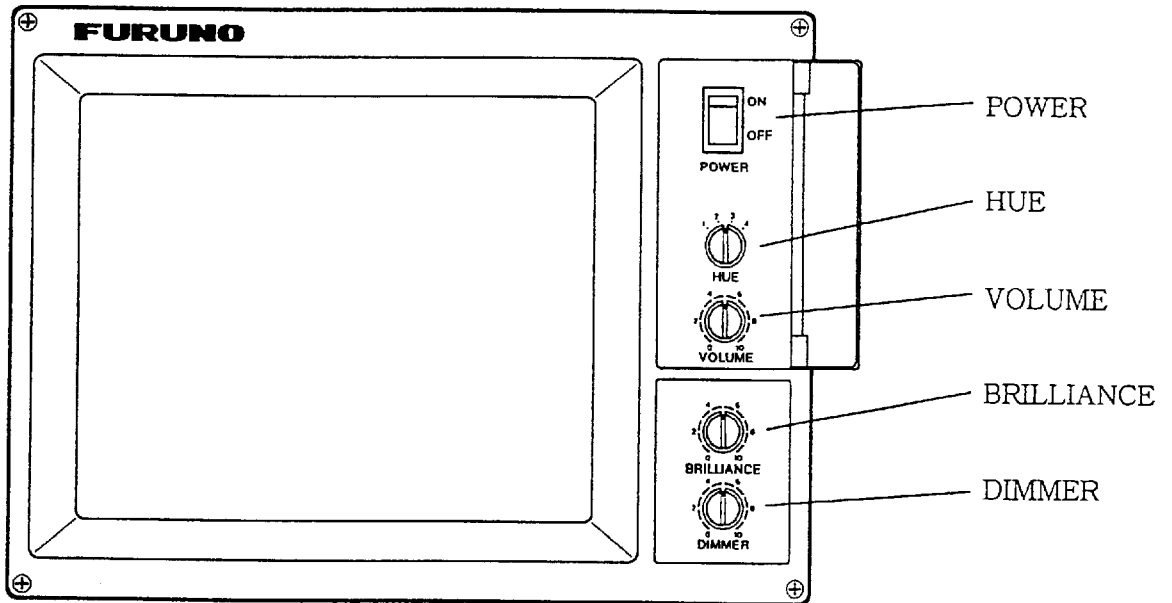



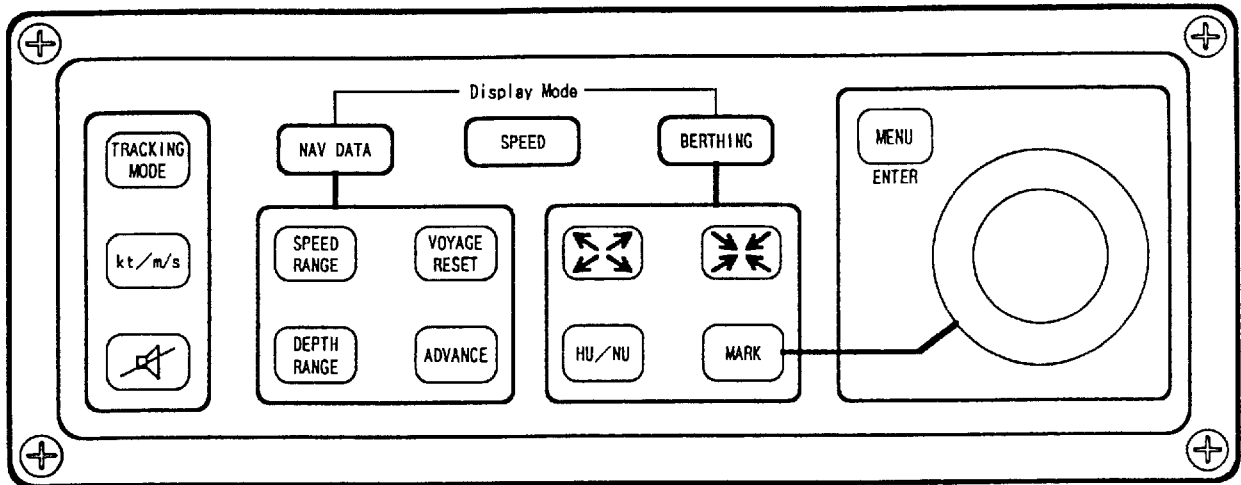

### Description of Front Panel Controls

POWER	Turns on/off the main display and operation panel.															
HUE	<p>Selects colors for foreground and background of screen.</p> <table border="0"> <tr> <td></td> <td>Alpha-numeric</td> <td>Background</td> </tr> <tr> <td>HUE1</td> <td>White</td> <td>Black</td> </tr> <tr> <td>2</td> <td>White</td> <td>Light blue 1</td> </tr> <tr> <td>3</td> <td>White</td> <td>Light blue 2</td> </tr> <tr> <td>4</td> <td>Black</td> <td>Reddish white</td> </tr> </table>		Alpha-numeric	Background	HUE1	White	Black	2	White	Light blue 1	3	White	Light blue 2	4	Black	Reddish white
	Alpha-numeric	Background														
HUE1	White	Black														
2	White	Light blue 1														
3	White	Light blue 2														
4	Black	Reddish white														
VOLUME	Adjusts the volume of audible alarm.															
BRILLIANCE	Adjusts the brilliance of the display screen.															
DIMMER	Adjusts the illumination of keys and characters on the panel of the main display and the operation panel.															

# Operation Panel



APPLICATION	KEYS	FUNCTION
Keys used to select display mode	NAV DATA SPEED BERTHING	Chooses the display modes.
Keys used on all display modes	TRACKING MODE	Chooses the tracking mode. Changes to AUTO, GT (ground tracking) and WT (water tracking) whenever the key is pressed.
	kt/m/s	Chooses the unit of speed display: knots or m/sec.
	[Alarm Icon]	Silences the audible alarm.
Keys used on NAV DATA mode	SPEED RANGE	Chooses the range scale of the ship's speed bar graph. Changes from 5 knots through 40 knots and AUTO whenever the key is pressed. See note 1.
	DEPTH RANGE	Chooses the range scale of the keel clearance graph. Changes from 25m through 400m and AUTO whenever the key is pressed. See note 1.
	ADVANCE	Chooses the time (X-axis) scale of the keel clearance graphic display. Changes from 4 minutes up to 30 minutes (from 500m up to 2000m) whenever the key is pressed. See note 1.
	VOYAGE RESET	Resets the voyage distance to zero.

Keys used on BERTHING mode		Changes the scale of the berthing mode screen from 100m/div up to 5000mdiv.
		Chooses the Heading up (HU) or North up (NU) presentation. In the HU, the own ship is stationary at the screen center with its bow pointing upward and the track moves relative to own ship. In the NU, North is upward on the screen and own ship moves on the screen with its true speed and course.
		Draws marker line. To draw the marker line; 1. Move the cursor to a desired location. 2. Press MARKER to designate the initial point of the marker line. 3. Move the cursor. See note 2. 4. Press the MARKER to designate the terminal point of the marker line.
Key used on MENU		Opens and closes menus or registers the settings on the menus.
Trackball		Moves the cursor on the screen. Used to move the cursor and to designate the marker line location on the berthing mode and also for operation on menus.

*Note: 1. Range scales selected on the range registration menu are sequentially chosen.*

*2. When the cursor is stationary, a point is designated instead of line. Pressing a key other than the MARKER key cancels marker line plotting and returns to the previous screen.*

# 4. TURNING ON/OFF POWER

## Turning On Power

Turn on the POWER switch at the display unit. In about seven seconds, the message "FURUNO" appears on the screen and then 13 seconds later, the start-up test is executed.

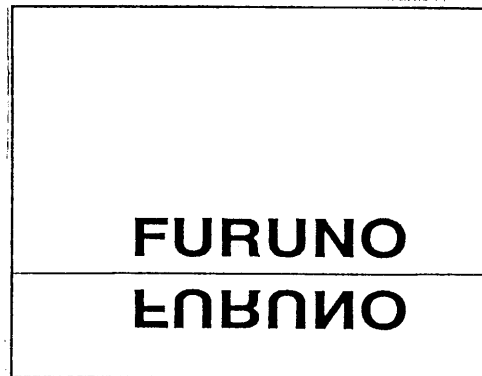

↓  
30 seconds later

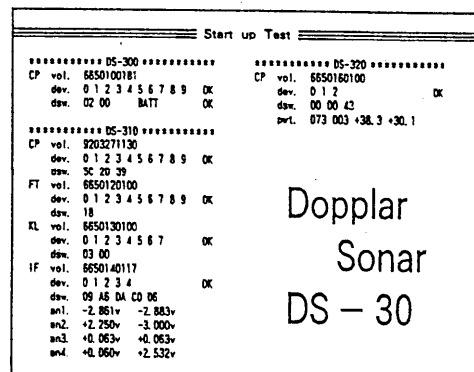

↓  
Normal Operation

During the start-up test, check that seven OKs are displayed. When an NG (No Good) is displayed instead of OK, some circuit is faulty. Contact Furuno Agent for technical support.

After the start-up test, that is, in about one minute after turning on power, normal operation is started.

Note: If equipped with a rate-of-turn gyro (option), turn on DS-30 when the ship is stopped or cruising straightly.

## Turning Off Power

Turn off the POWER switch at the display unit.



# 5. NAV DATA MODE OPERATION

This section describes the operation on the NAV DATA MODE as well as the readings on the screen.

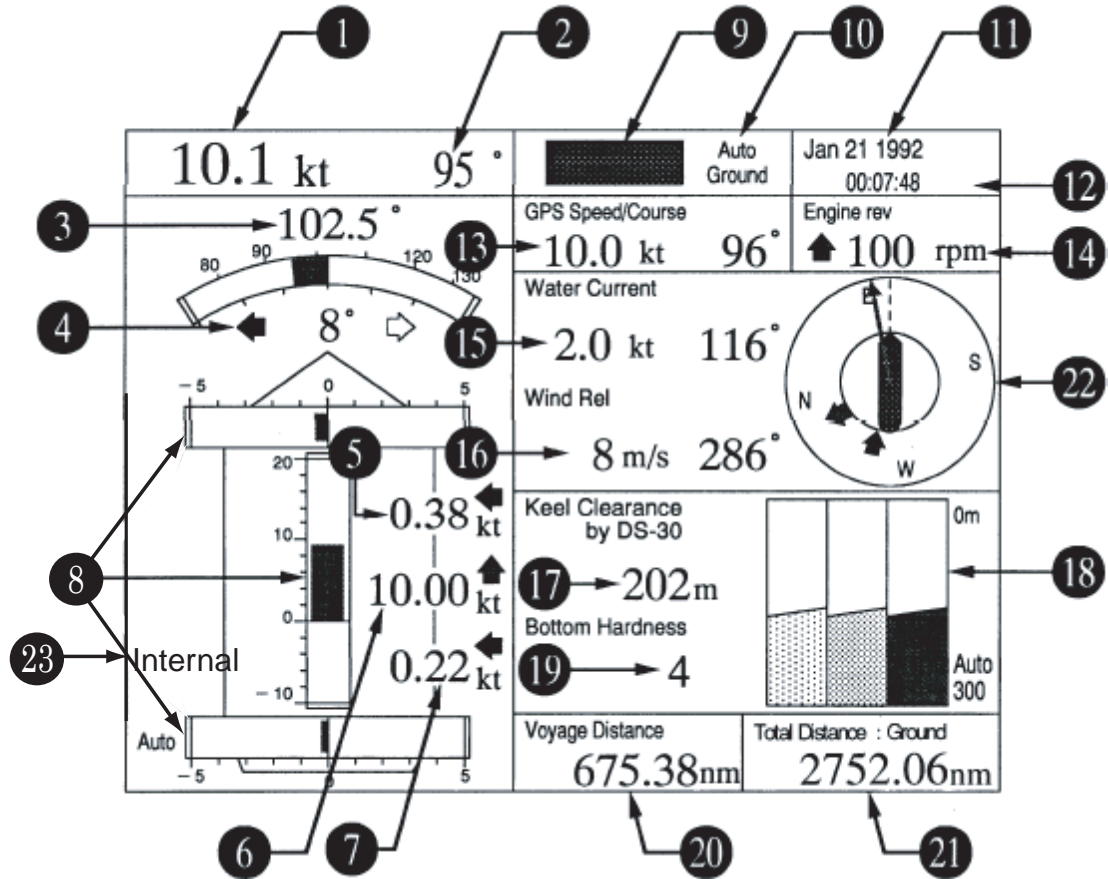

## Basic Operation

You may operate this mode with the following key switches.

### TRACKING MODE

Chooses the tracking mode for ship's speed measurement: Ground, Water or Auto. Normally select "Auto" for automatic changeover to "Water" when the ground tracking is not attainable. The Ground tracking is normally attainable up to a 200m deep bottom.

### kt/m/s

Select the unit of ship's speed display.

### SPEED RANGE

Chooses the range scale of ship's speed bargraph.

### DEPTH RANGE

Chooses the depth scale of the under-keel clearance graphic display.

**ADVANCE**

Chooses the range (time) scale of the under-keel clearance graphic display.

**VOYAGE RESET**

Resets the total distance run to zero.

## Interpreting Readings and Advanced Operation

In this section, the number beside each header corresponds to the same number on the illustration of the NAV DATA MODE screen on the preceding page. For items requiring an operation, the operating procedure is shown.

### 1. Ship's Speed

The ship's speed over-the-ground or through-the-water is displayed as determined by the tracking mode selected. To judge which speed is being displayed, look at item 9: ground or water.

- Speed through-the-water: Speed relative to 2m deep water unless "water track depth " is changed on the parameter set menu. See page 9-13.

### 2. Course

The ship's course through-the-water or over-the-ground (true course) is displayed as determined by the tracking mode selected. In the case of no gyrocompass connection, the drift (angle between ship's heading and the true course) is displayed.

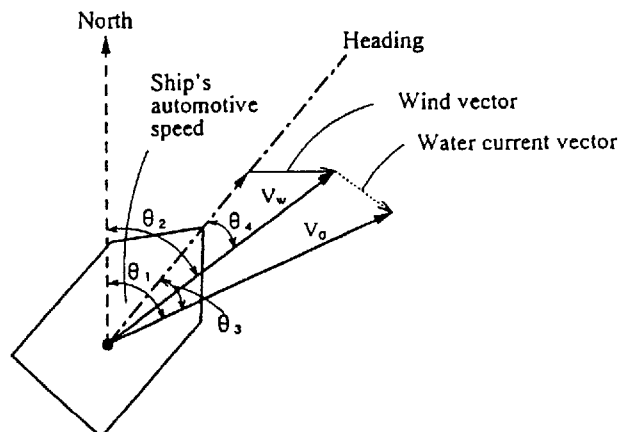

$V_w$  = Through the water speed

$V_G$  = Over- the ground speed

$\theta_1$  = Over- the- ground course (true course)

$\theta_2$  = Through- the- water course

$\theta_3$  = Drift angle in ground tracking mode

$\theta_4$  = Drift angle in water tracking mode. This value is also displayed in ② (course) when the gyrocompass is not connected.

- 3. Ship's Heading** Heading data derived from gyrocompass is indicated. 0° is displayed in the case of no gyrocompass connection.
- 4. Drift** Drift (angle between ship's heading and ship's course) is displayed. See the illustration on page 5-2.
- 5. Transverse Speed at Bow** Value over-the ground or through-the-water is displayed as determined by the tracking mode.
- 6. Longitudinal Speed** Value over-the-ground or through-the-water is displayed as determined by the tracking mode.
- 7. Transverse Speed at Stern\*** Value over-the-ground or through-the-water is displayed as determined by the tracking mode.
- \* Rate-of-turn gyro or gyrocompass required. When no connected, transverse speed at the position of the transducer is indicated.
- 8. Speed Graph** Ship's speed bar graphs for item 5,6 and 7.
- 9. Echo Monitor** Monitors received echoes for past three minutes, showing echo type as follows.
- Ground tracking echo: Green
  - Water tracking echo: Blue
  - No echo: Background color
- 10. Tracking Mode** Press the TRACKING MODE key to change the tracking mode. Three modes are available:
- Auto: Automatic changeover between ground tracking and water tracking.
  - Ground: Ground tracking
  - Water: Water tracking

## 11. Date

Day, month and year are displayed.

### Changing order of day/month/year

The order in which day, month and year are shown can be changed on the initial setup menu. See page 9-11.

## 12. Time

Time in GMT, UTC, JST or local time is displayed. GMT, UTC and JST are fed from the nav sensor. When the internal timer of the DS-30 is used, the time you set on the menu is shown.

### Changing source of time data

You may change the source of time data on the initial setup menu. See page 9-11.

## 13. Nav Speed/ Course

The speed and course measured by a nav sensor (GPS, Loran C) are displayed. Note that only true course is displayed. If a signal is lost, 30 seconds after loss the corresponding indication shows ---°.

### Selecting nav sensor

The nav sensor may be selected on the parameter set menu. See page 9-13.

## 14. Engine Rev. Ship's Pos.

The main engine revolution speed or the ship's position in latitude and longitude is displayed as selected on the set display menu. See page 9-8.

## 15. Water Current

The speed and direction of water current/tide are displayed as follows as determined by the tracking mode and menu setting.

Tracking Mode	Nav Ref. Setting on Parameter Menu	Water Current/Tide Reading
Ground	Any	Speed and direction relative to ground.
Water	No	Current/tide differential, that is, the speed and direction at the specified depth relative to that at the water tracking depth.
	Yes	Speed and direction relative to ground. Ship's over-the-ground speed derived from a nav sensor is used to calculate the speed and direction.

*The water current/tide measurement depth and water tracking depth are set to the same depth (2m) at the factory. Therefore, the current differential reading is normally 0.0 knots and 0 degrees. To get the current differential reading, set the measurement depth deeper than the water tracking depth by at least several meters, on the parameter menu. See page 9-13.*

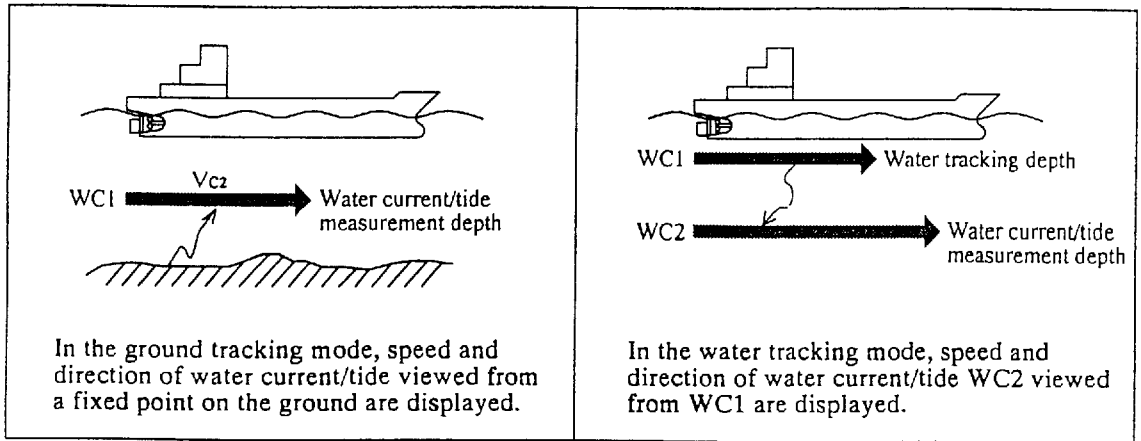

### Changing water current direction readout

The water current readout normally shows the direction *from* which the water current is flowing. It can be changed to the direction *to* which the water current is flowing on the system menu. See page 11-2.

## 16. Wind

The wind reading can be displayed when a wind meter on board is connected to the DS-30. True or relative wind is displayed as determined by tracking mode and menu setting.

Tracking Mode	Wind Tru/Rel Setting on Set Display Menu	Nav Ref. Setting on parameter menu	Wind reading
Ground	True	Any	True wind speed/direction
	Relative		Relative wind speed/direction measured by wind meter
Water	True	No	Wind speed/direction relative to ship's speed/course made good through-the-water
		Yes	True wind speed/direction calculated by using ship's speed/course data fed from nav sensor
	Relative	Any	Relative wind speed/direction measured by wind meter

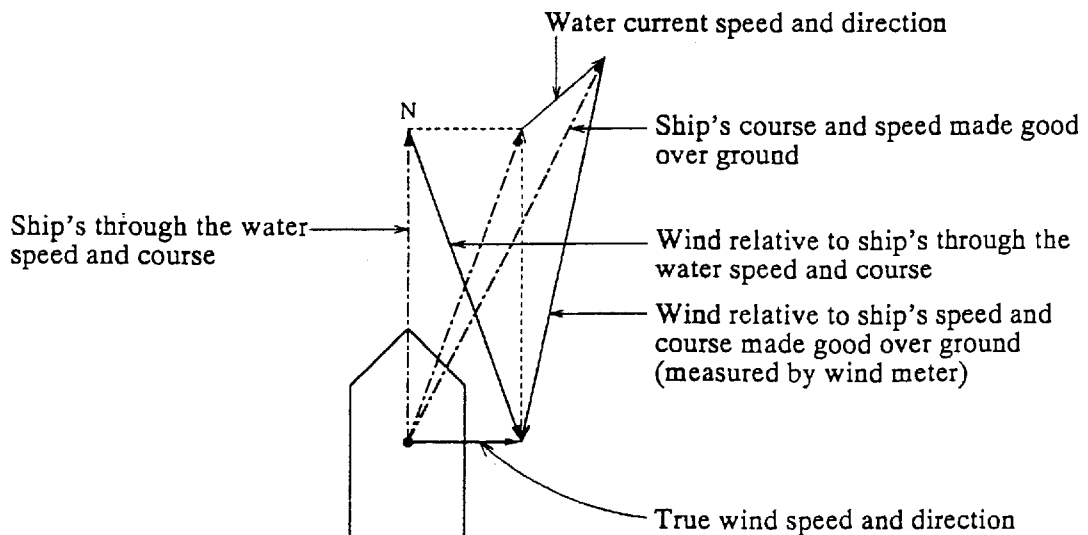

### Changing wind direction readout

The wind direction readout can be changed from the direction the wind is blowing *from* to the direction wind is blowing *to*, on the system menu. See page 11-2. Note that the arrow indicating the wind direction always shows the direction *from* which the wind is blowing.

### Changing unit of wind speed

To change the unit of wind speed from “m/s” to “knots”, open the system menu. See page 11-1.

## 17. Under-keel Clearance (UKC)

The under-keel clearance measured by DS-30 or external echo sounder is displayed.

In the inclined seabed, there may be a difference between the under-keel clearance measured by DS-30 and that measured by an echo sounder.

### Changing unit of depth

The unit of depth can be selected among meter, feet and fathom on the system menu. Refer to page 11-1.

## 18. Under-keel Clearance Graphic

The under-keel clearance measured by DS-30 or an external echo sounder is graphically displayed. For the under-keel graphic measured by DS-30, single (averaged) or triple-split (separate beam) is selected on the set-display menu.

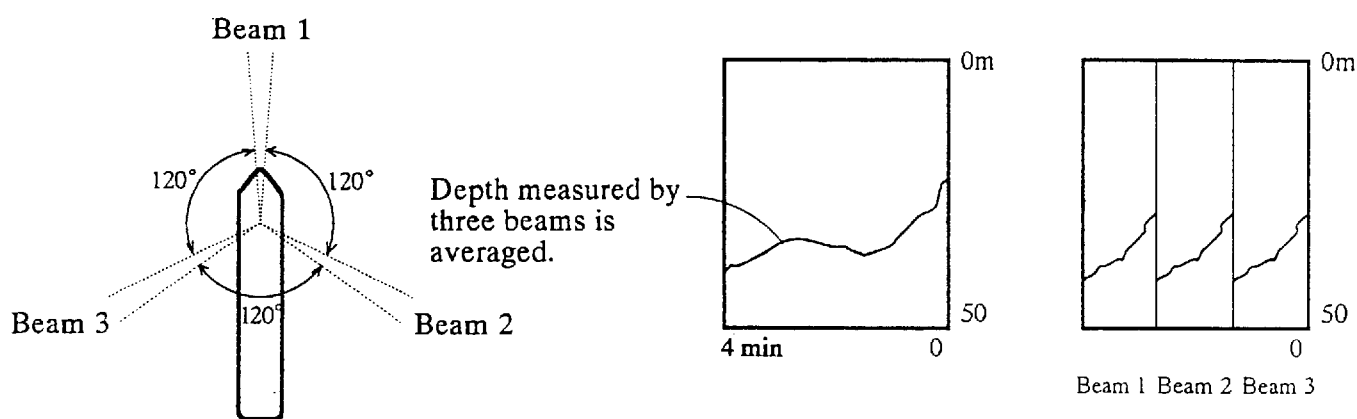

### Selecting range scale

Press the DEPTH RANGE key to change the range scale of the Y-axis and ADVANCE key to change that of the X-axis.

### **Selecting type of under-keel clearance display**

To display single (averaged) or triple-split (separate beam) presentation and also to use whether under-keel clearance measured by DS-30 or the external echo sounder can be selected on the set-display menu. See page 9-9.

### **Reprogramming range scales**

The ranges to be registered on the DEPTH RANGE and ADVANCE keys can be reprogrammed on the initial setup menu. See page 9-12.

### **Displaying 16-color under-keel clearance**

To display received echoes in 16 colors just like an ordinary color video sounder, take the following steps. The 16-color under-keel clearance display is usually used to check the receiving condition of echoes. When the ship's speed reading is unstable or seems to be inaccurate, check that bottom echoes are displayed clearly and also that there is no noise due to air bubbles near transmission line.

Echo colors represent intensity of echoes; reddish brown for the strongest echo, then red, orange, yellow, light-green, green and the light-blue for the weakest echo.

1. Open the set-display menu. See page 9-8.
2. Select the "Int. 16-color" in the UKC source item.
3. In the UKC present: item, select the "Triple" to display the echoes of the three beams separately and "Single" to display three-beam-averaged echoes.

## **19. Bottom Hardness**

The hardness of bottom is calculated from the intensity of echoes and displayed by numbers 1 through 9, where each number corresponds theoretically to the following bottom nature.

7 to 9: Bedrock

4 to 6: Sand, gravel

2 to 3: Mud

### **Turning on/off bottom hardness display**

The bottom hardness display can be turned on or off on the system menu. See page 11-2.

## **20. Voyage Distance**

## **21. Total Distance**

The voyage and total distances are displayed. You may use them as follows. If you are going to call at port "B", "C" and reach final port "D", for example, use the voyage distance to calculate the

distance run between ports and the total distance the total distance run from port “A” to “D”.

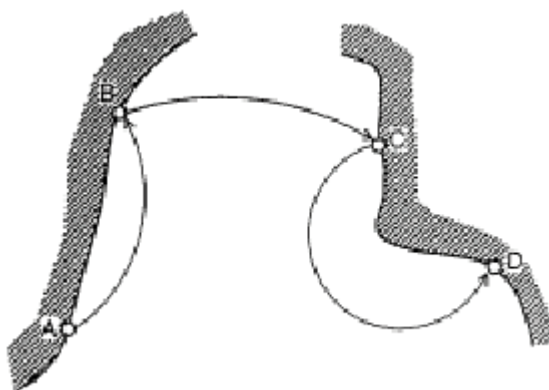

### **Resetting voyage distance**

To reset the voyage to zero, press the VOYAGE RESET key.

### **Resetting voyage distance**

The total distance can be set to any desired value on the initial setup menu. See page 9-12.

### **Selecting unit of distance**

You may select the unit of distance “nm” (nautical mile) or “km” on the system menu. See page 11-1.

## **22. Graphic display**

The drift (4), water current (15), and relative wind (16) are graphically displayed.

## **23. Rate Sensor**

The rate sensor chosen in the INT. SETUP menu is displayed: Internal, External ROT or External HDG.



# 6. NAV DATA MODE OPERATION

This section describes the operation on the SPEED DATA MODE as well as the readings on the SPEED screen.

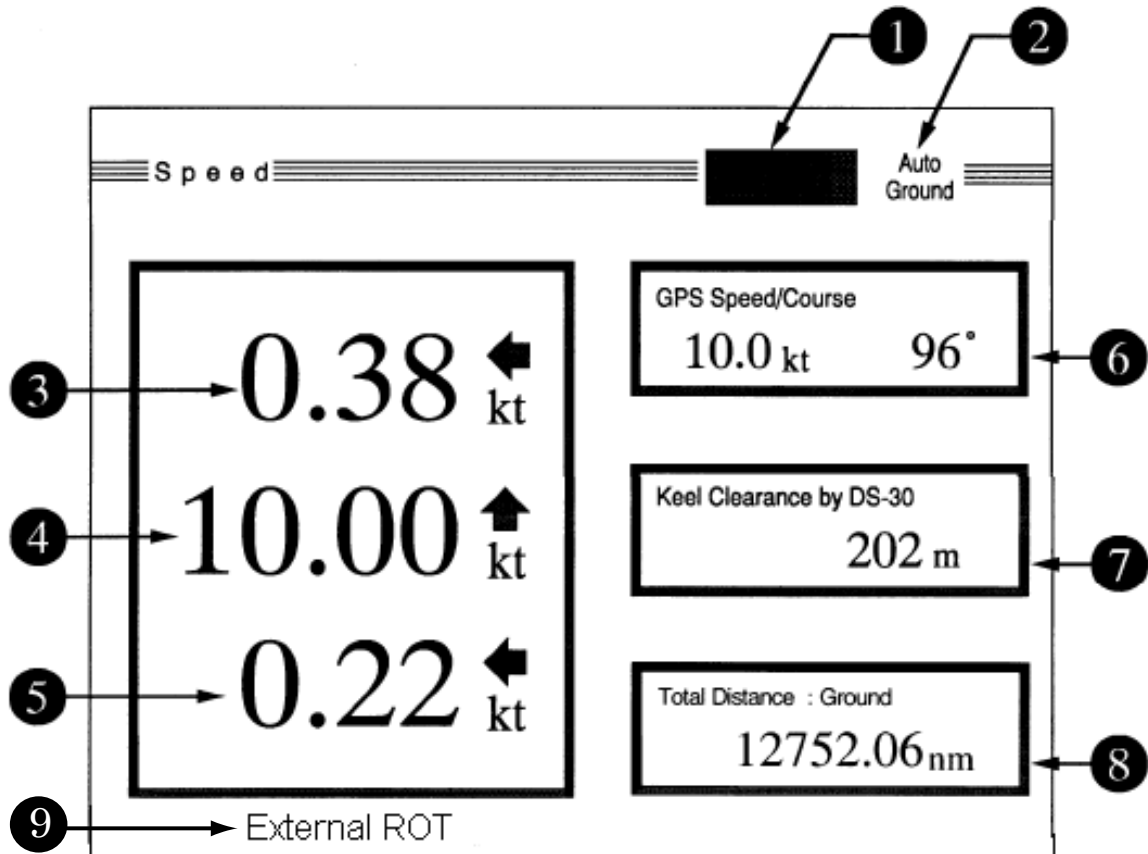

## Basic Operation

You may operate this mode with the following key switches.

### TRACKING MODE

Chooses the tracking mode for ship's speed measurement: Ground, Water or Auto. Normally select "Auto" for automatic changeover to "Water" when the ground tracking is not attainable. The Ground tracking is normally attainable up to a 200 m deep bottom.

### kt/m/s

Select the unit of ship's speed display.

# Interpreting Readings and Advanced Operation

In this section, the number beside each header corresponds to the same number in the illustration of the SPEED DATA MODE screen on the preceding page. If there is an operation related to a headed item, the operating procedure is shown.

## 1. Echo Monitor

Monitors received echoes for the past two minutes, showing echo type as follows.

Three modes are available:

- Ground tracking echo (green)
- Water tracking echo (blue)
- No echo (background color)

## 2. Tracking Mode

Press the TRACKING MODE key to change the tracking mode.

- Auto: Automatic changeover between ground tracking and water tracking.
- Ground: Ground tracking
- Water: Water tracking

## 3. Transverse at Speed at Bow

Value over-the-ground or through-the-water is displayed as determined by the tracking mode.

## 4. Longitudinal Speed

Value over-the-ground or through-the-water is displayed as determined by the tracking mode.

## 5. Transverse speed at Stern

Value over-the-ground or through-the-water is displayed as determined by the tracking mode

## 6. Nav Speed/ Course

The speed and course measured by a nav sensor (GPS, Loran C) are displayed. Note that only true course is displayed. If the speed or course signal is lost the respective indication is erased 30 seconds later.

### Selecting nav sensor

The nav sensor may be selected on the parameter set menu. See page 9-13.

## 7. Under-keel Clearance (UKC)

The under-keel clearance measured by the DS-30 or external sounder is displayed.

In the inclined seabed, there may be a difference between the under-keel clearance measured by DS-30 and that measured by an echo sounder.

## **8. Total Distance**

The total distance run is displayed.

### **Resetting Total Distance**

The total distance run can be set to any desired value on the initial setup menu. See page 9-11.

### **Selecting Unit of Distance**

You may select the unit of distance “nm” (nautical mile) or “km” on the system menu. See page 11-1. Total Distance Run.

## **9. Rate Sensor**

The rate sensor chosen in the INT. SETUP menu is displayed: Internal, External ROT or External HDG.

# 7. BERTHING MODE OPERATION

This section describes the operation on the BERTHING MODE as well as the readings on the screen.

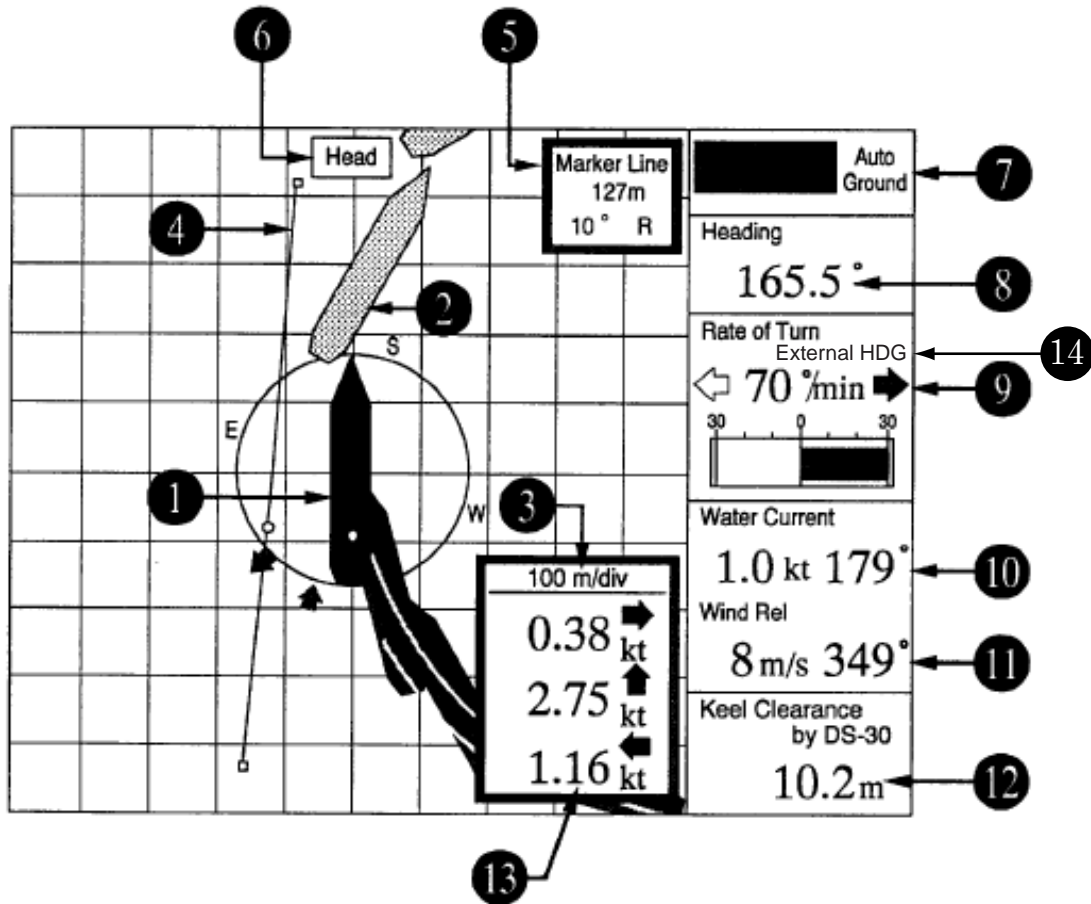

The berthing mode requires gyrocompass connection.

## Basic Operation

You may operate this mode with the following key switches.

### TRACKING MODE

Chooses the tracking mode for ship's speed measurement: Ground, Water or Auto. Normally select "Auto" for automatic changeover to "Water" when the ground tracking is not attainable. The ground tracking is normally attainable up to a 200m deep bottom.

### kt/m/s

Selects the unit of ship's speed display.

### AROW KEY

Chooses the scale of the berthing screen from 100 m/div up to 5000 m/div.

**HU/NU**

Chooses Head Up (HU) or North Up (NU) presentation. In HU, the own ship is stationary at the screen center with its bow pointing upward and the track moving relative to own ship. In NU, North is upward on the screen and own ship moves on the screen with its true speed and course.

**MARK**

Draws the marker line on the berthing screen. Refer to item "Marker Line" for the drawing procedure.

## Interpreting Readings and Advanced Operation

In this section, the number beside each header corresponds to the same number on the illustration of the BERTHING MODE screen on the preceding page. If there is an operation related to a headed item, the operating procedure is shown.

### 1. Own Ship

Own ship mark (green) shows ship's present position. The small circle (yellow) on the own ship is the reference point of own ship (usually bridge).

### 2. Ship's Plot

The historical plot (orange) of the track at ship's bow/stern and the predicted track (pink) are displayed being updated every three seconds. In plotting of the predicted track, the ship's predicted position at intervals of "plot time set on the set-display menu divided by five" is plotted. For instance, if the plot time is set to five minutes, the ship's predicted position is plotted at intervals of one minute.

*Note: Predicted track function requires optional rate-of-turn gyro connection.*

#### Selecting ship's track to be displayed

The type of ship's track to be displayed can be selected on the set display menu. See page 9-8.

#### Selecting plot time

The plot time of the predicted track can be selected on the set-display menu. See page 9-8.

#### Erasing Track

The ship's past track being displayed can be erased on the initial setup menu. See page 9-9.

### **3. Scale**

Use the arrow keys to change scale.

#### **Reprogramming scale**

The scales registered on the arrow keys can be reprogrammed on the initial setup menu. See page 9-12.

### **4. Marker Line**

You may use the marker line to mark a berth, jetty, breakwater, etc. Refer to the echoes on the radar screen to check the exact relationship between own ship and the berth, breakwater, etc.

#### **Plotting marker line**

1. Move the cursor to the initial point of the event line to be plotted.
2. Press the MARK key to register the initial point.
3. Move the cursor to the terminal point of the event line to be plotted.
4. Press the MARK key to register the terminal point.

#### **Erasing marker line**

Press the MARK key.

### **5. Cursor/Marker Line Data**

This data shows range and bearing from own ship to the cursor or marker line.

When the cursor is displayed, the range and bearing are from the reference point ("o" mark) on own ship to the nearest point ("o" mark) of the marker line.

### **6. Head up/ North up Indication**

It shows the orientation of the berthing display; head up or north up

#### **Changing head up/north up**

To change from the head up presentation to the north up presentation or vice versa, press the HU/NU key.

### **7. Tracking Mode**

Press the TRACKING MODE key to change the tracking mode.

Three modes are available.

- Auto: Automatic changeover between ground tracking and water tracking.
- Ground: Ground tracking
- Water: Water tracking

## 8. Heading

Shows ships heading. 0° is displayed in the case of no gyrocompass connection.

## 9. Rate of Turn

This shows the ship's rate-of-turn speed measured by the optional rate-of-turn gyro.

*Note: No display in the case of no rate-of-turn gyro connection.*

## 10. Water Current

The speed and direction of water current/tide are displayed as follows as determined by the tracking mode and menu setting.

Tracking Mode	Nav Ref. Setting on Parameter Menu	Water Current/Tide Reading
Ground	Any	Speed and direction relative to ground.
Water	No	Current/tide differential, that is, the speed and direction at the specified depth relative to that at the water tracking depth.
	Yes	Speed and direction relative to ground. Ship's over-the-ground speed derived from a nav sensor is used to calculate the speed/direction.

- *The water current/tide measurement depth and water tracking depth are set to the same depth (2m) at the factory. Therefore the current differential reading is normally 0.0 knots and 0°. To get the current differential reading, set the measurement depth deeper than the water tracking depth by at least several meters on the parameter menu. See page 9-13.*

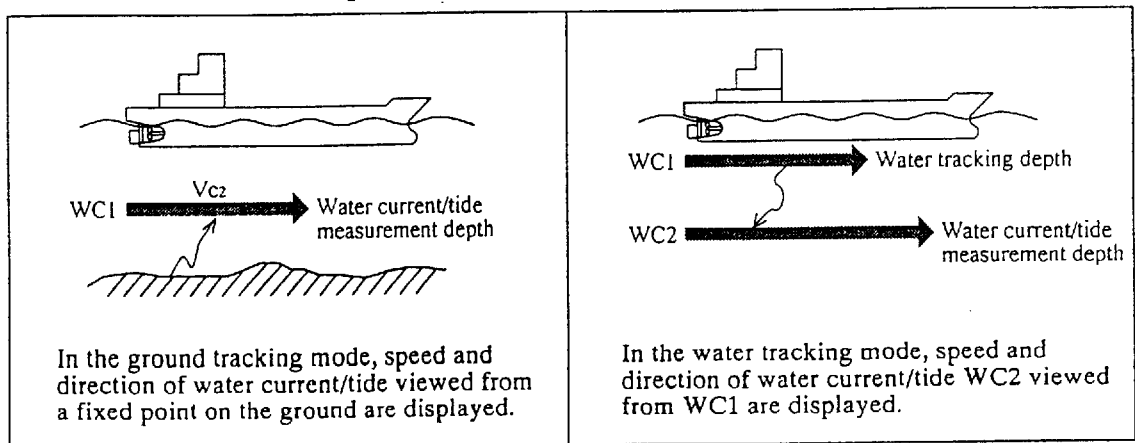

### Changing water current direction readout

The factory set water current readout shows the direction from which the water current is flowing. It can be changed to the direction to which the water current is flowing, on the system menu. See page 11-2. Note that the arrow indicating the current direction always shows the direction from which the water current is flowing.

## 11. Wind

The wind reading is available by connection of a wind meter on board. True or relative wind is displayed as determined by tracking mode and menu setting.

Tracking Mode	Wind Tru/Rel Setting on Set Display Menu	Nav Ref. Setting on parameter menu	Wind reading
Ground	True	Any	True wind speed/direction
	Relative		Relative wind speed/direction measured by wind meter
Water	True	No	Wind speed/direction relative to ship's speed/course made good through-the-water
		Yes	True wind speed/direction calculated by using ship's speed/course data fed from nav sensor
	Relative	Any	Relative wind speed/direction measured by wind meter

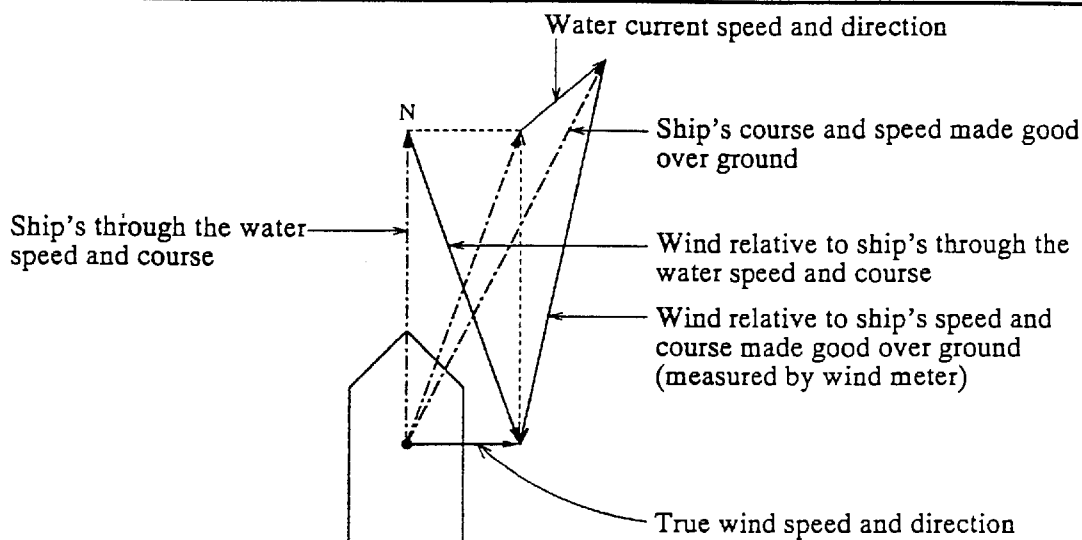

### Changing wind direction readout

The wind direction readout can be changed from the direction wind is blowing from to the direction wind is blowing to, on the system menu. See page 11-2. Note that the arrow indicating the wind direction always shows the direction from which the wind blows.

### Changing unit of wind speed

To change the unit of wind speed from "m/s" to "knots", open the system menu. See page 11-1.

## 12. Under-keel Clearance

The under-keel clearance measured by DS-30 or an external echo sounder is displayed.

### Changing unit of depth

The unit of depth can be selected among meter, feet, fathom on the system menu. See page 11-1.



**13. Ship's Speed**

The ship's speed over-the-ground or through-the-water is displayed as determined by the tracking mode selected. To judge which speed is being displayed, look at item 7: ground or water.

**14. Rate Sensor**

The rate sensor chosen in the INT. SETUP menu is displayed: Internal, External ROT or External HDG.

# 8. DIGITAL INDICATOR DS-350/351

## DS-350 (LCD Display for Outdoor Use)

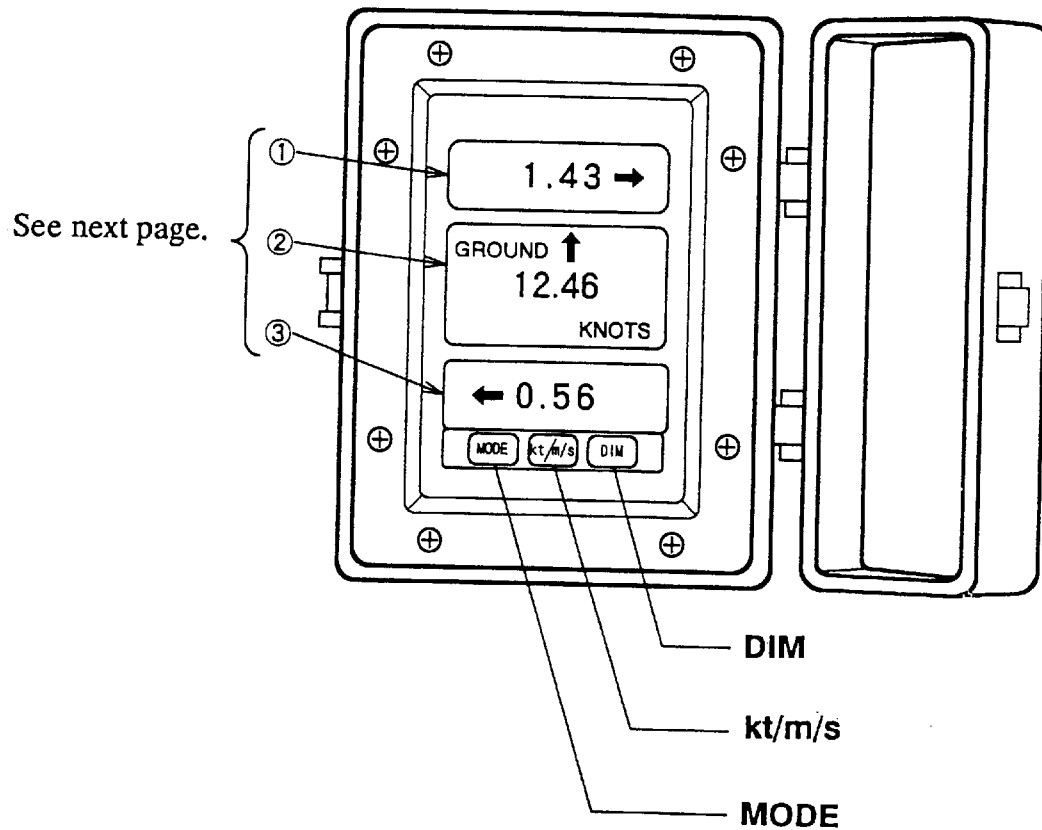

### Display/Control Panel

#### **DIMMER**

Adjust the illumination of display control panel.

#### **MODE**

Selects the contents to be displayed on the 3rd line of display. See the following page for detail.

#### **kt/m/s**

Changes the unit of speed readout

## Interpreting the Display

Pressing the Mode key alternates the readouts of Table 1 and Table 2.

Table 1

No.	Display Item	Remarks
1	Transverse speed at bow	Speed over the ground or through-the-water is displayed depending on the tracking mode.
2	Longitudinal speed	
3	Transverse speed at stern Rate-of-turn gyro connection required.	

Table 2

No.	Display Item	Readout
1	Characters "dEP" is displayed , meaning DEPTH.	dEP
2	Under-keel clearance	15.6 <sup>M</sup>
3	Nothing displayed	[Empty Box]

# DS-351 (LED Display for Indoor Use)

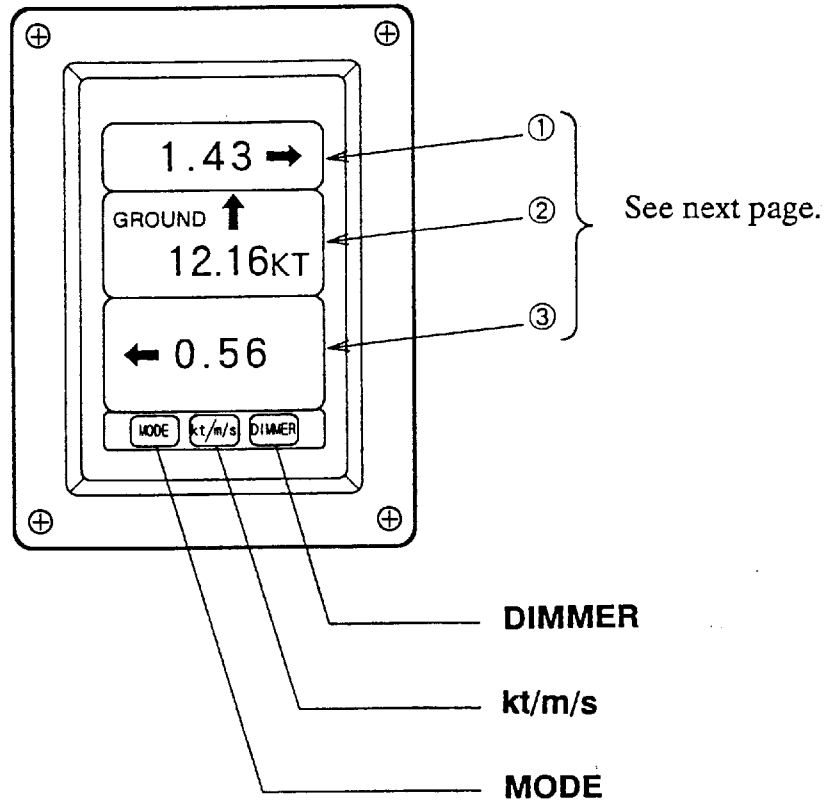

## Display/Control Panel

### **DIMMER**

Adjusts the illumination of display and control panel.

### **kt/m/s**

Changes the unit of speed readout.

### **MODE**

Selects the contents to be displayed on the 3rd line of the display. See the following page for detail.

## Interpreting the display

No	Display Item	Indication/Remarks
1	Transverse speed at bow	Speed over the ground or through-the water is displayed depending in the tracking mode.
2	Longitudinal speed	
3	Reading change as follows whenever the MODE key is pressed	
	Transverse speed at stern (over-the-ground or through-the water) <i>Rate-of-turn gyro or gyrocompass connection required*</i>	
	Rate-of-turn speed <i>Rate-of-turn gyro or gyrocompass connection required*</i>	
	Depth (Under-keel Clearance)	
	Heading 0° is displayed in the case of no gyrocompass connection.	
	Course (over-the ground or through-the-water) Look at the display window of the longitudinal speed at bow to judge whether the course over the-ground or through-the-water is displayed. With no gyrocompass connection, drift angle is displayed.	

\*: When rate-of-turn gyro or gyrocompass is not connected, these display read “---“.

# 9. OPERATION ON USER MENU

## General

The DS-30 employs user menus to let you preset or select those functions which are not frequently altered in daily use, such as navigation conditions.

## Structure of Menu

The user menus are constructed in several layers and those selected by the operator are displayed in multiple windows as shown below.

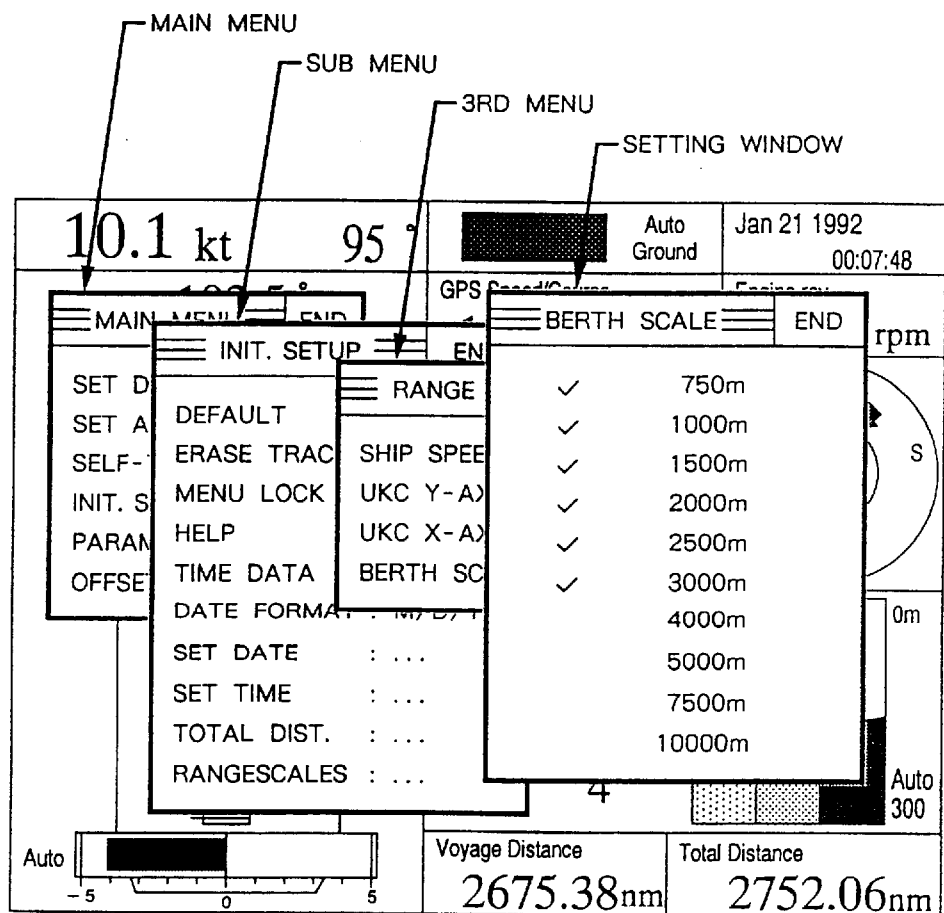

The following figure shows the contents of the user menus. Notice that the selection boxes or the setting windows where you actually select function or change setting are shown for typical ones.

# FLOW OF MENU

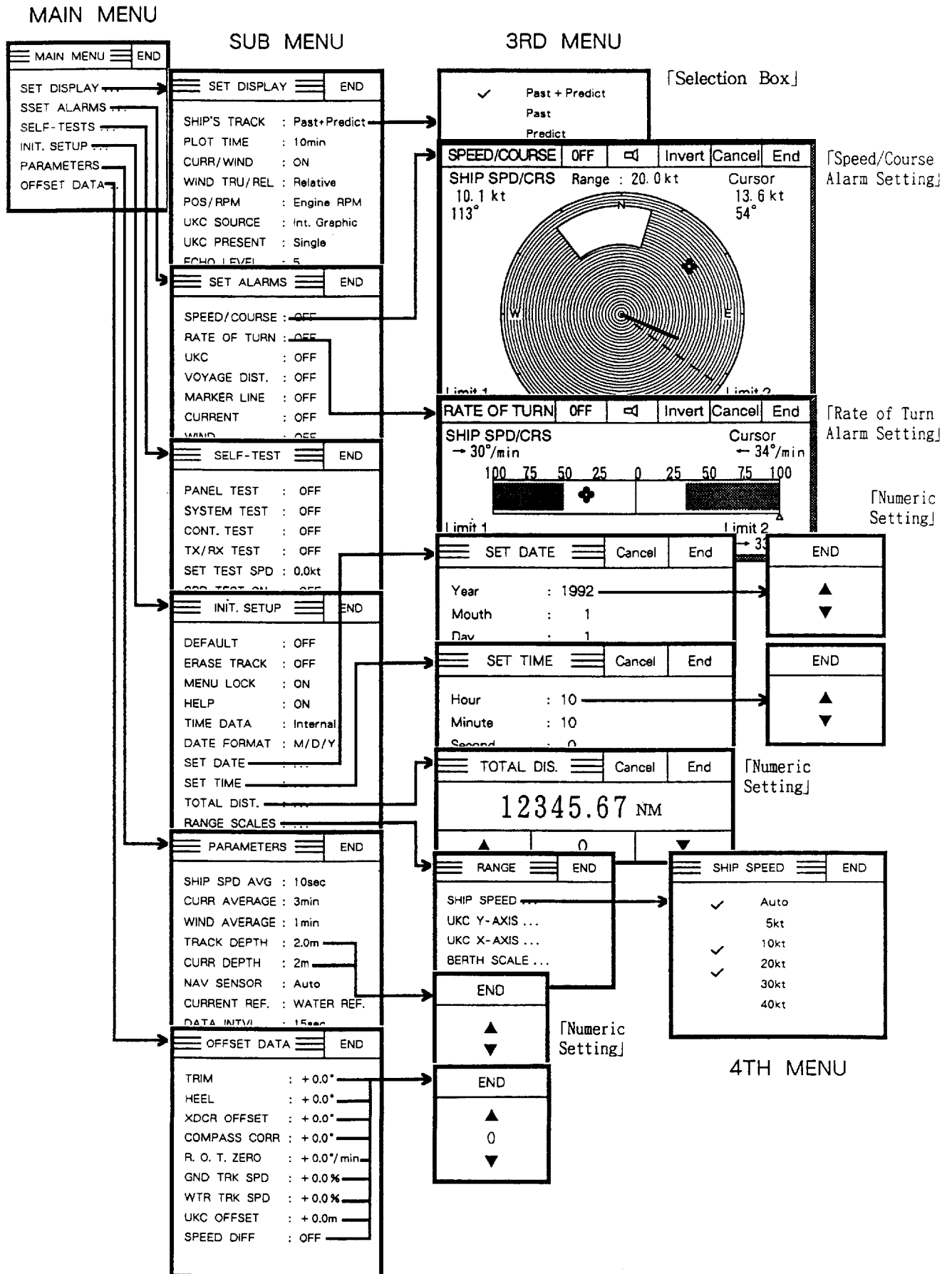

# General Rule for Operation on User Menu

## Opening Menu

You may open the main menu by simply pressing the MENU key. To open one of the sub-1 menus, place the pointer (☞) on desired item in the main menu by operating the trackball and then press the MENU key. The item designated by the pointer is highlighted in inverse video and the sub menu for that item is displayed to the right of it. You may open the 3rd menu in the same manner as sub menu.

## Changing Settings in Menu

When a menu item is selected (by placing the pointer on the item and pressing the MENU key), a selection box or setting window is displayed to the right of the selected item. There are several types of selection boxes and setting windows as shown below and you may use the trackball and the MENU key to change or set parameters in any window or box.

### Numeric setting window

A numeric setting window is displayed when you need to set numeric value. For instance, ship's draft changes from ship to ship and with loading condition, and thus a value specific to your ship should be entered.

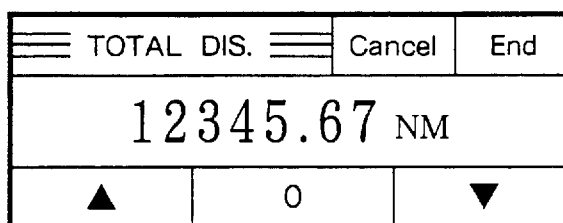
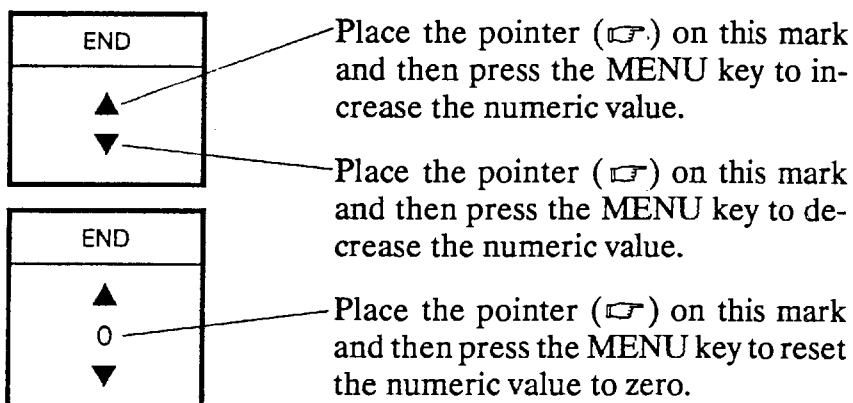

Place the pointer (☞) on the digit above which you want to change value. For instance, if you wish to change from "12345.67" to "15745.67", place the pointer on "3" and press the MENU key. The numerals "123" are highlighted in inverse video. Then place the pointer on the "▲" mark and then press the MENU key to change "123" to "157".



■ **Note:**

*Cancel: Cancels the setting and returns to the previous menu.  
End: Registers the setting and returns to the previous menu.*

**Selection box**

A selection box is displayed when you have to choose one of the parameters or functions from those displayed in the box. Current selection is shown by a "✓" mark. To change the selection, move the  mark by the trackball and then press the MENU key.

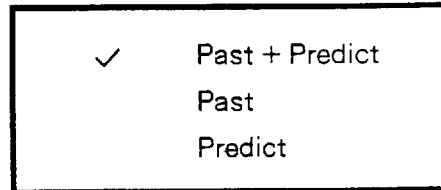

## Alarm Setting Window

There are three types of alarm setting windows. One is for the rate-of-turn (R. O. T.) speed alarm. Another is for ship's speed and course, water current speed and direction and wind speed and direction alarms. The other is for the under-keel clearance, voyage distance and marker line alarms.

### R. O. T. Speed Alarm Setting Window

When the rate-of-turn alarm is selected, the alarm setting window looks something like the figure shown below, where the gray bargraph shows the present alarm zone setting.

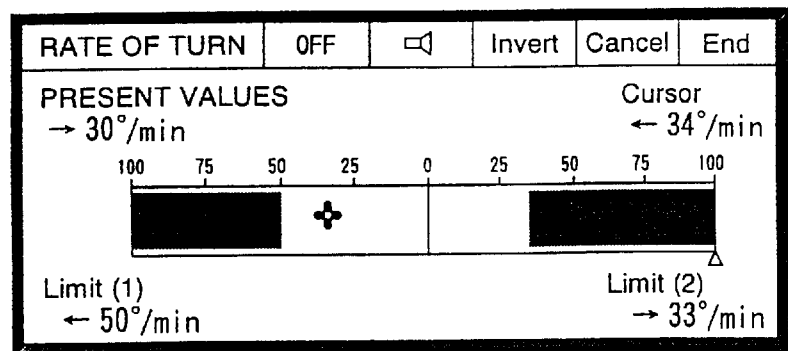

To change the alarm zone:

1. Move the pointer along the bar graph window until the "Cursor" reads the one of the alarm limit values and then press the MENU key. The alarm setting window will change as shown below with the alarm set value set above registered as "Origin".

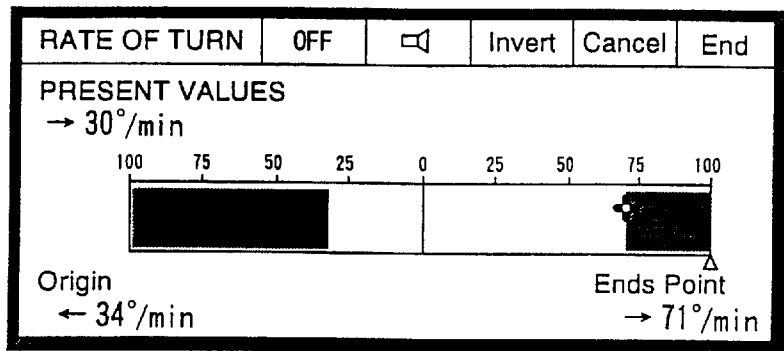

- Do the same to set the other alarm limit value on "End Point". The alarm is activated at the values greater than "Origin" and "End Point". In the above figure, the alarm is active when the rate-of-turn speed is greater than 34°/min to port and 71°/min to starboard.

The functions of the windows on the top line are as follows.

ON/OFF: Enables (ON)/disables (OFF) alarm function.

🔊/🔇: Enables(🔊) / disables the audible alarm.

Invert: Alternates the alarm and non-alarm zones. If the alarm zone is inverted in the above figure, for example, the alarm zone is between 34°/min to port and 71°/min to starboard.

Cancel: Cancels changes and closes the window.

OK: Saves changes and closes the window.

## Speed/Direction (Course) Alarm Setting Window

When you select ship's speed and course, wind speed and direction or water current speed and direction alarm, the setting window looks something like the figure shown below.

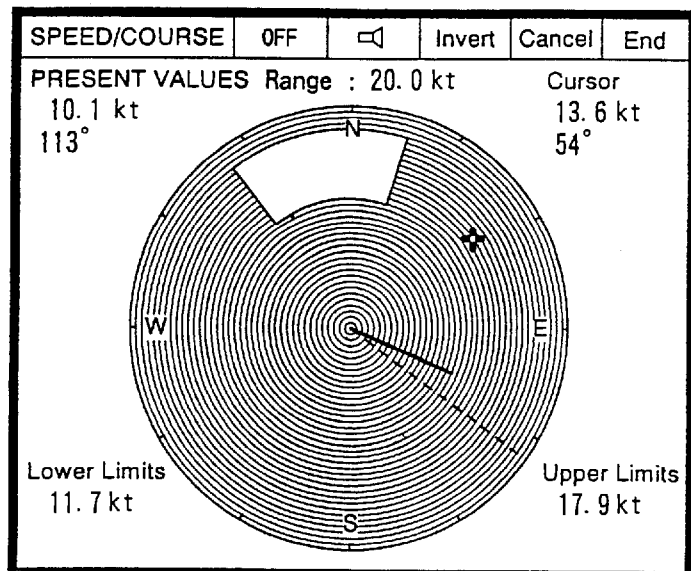

### Setting all direction alarm zone (speed alarm)

When you wish to use, for example, the ship's speed alarm excepting the course alarm, set a circular alarm zone as follows.

1. Operate the trackball so that the "Cursor" reads one of the two alarm limit values for speed.
2. Press the MENU key. The value set at step 1 is registered as "Origin" point of the alarm zone.
3. Move the pointer "+" counter-clockwise inward/outward until the "End Point" reads the other alarm limit value.
4. Press the MENU key, and an all directional alarm zone is created.

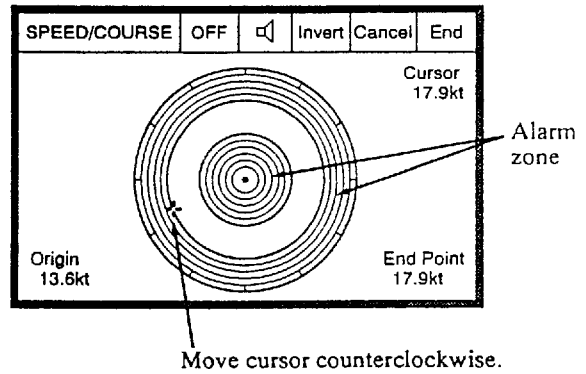
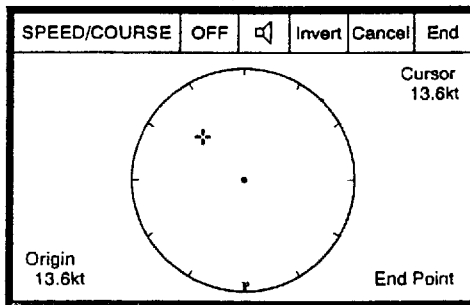

### Setting directional alarm zone (speed/direction alarm)

When you wish to use both speed and course (direction) alarms, create a directional alarm zone as follows.

1. Operate the trackball so that the "Cursor" reads one of the two alarm limit values for speed and direction.
2. Press the MENU key. The value set at step 1 is registered as "Origin" point of the alarm zone.
3. Move the pointer "+" clockwise inward/outward until the "End Point" reads the other alarm limit value for speed and direction.
4. Press the MENU key.

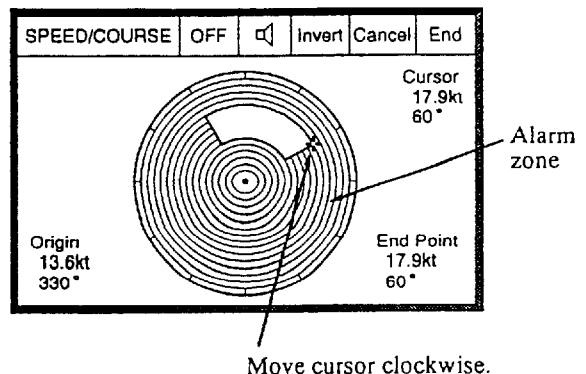
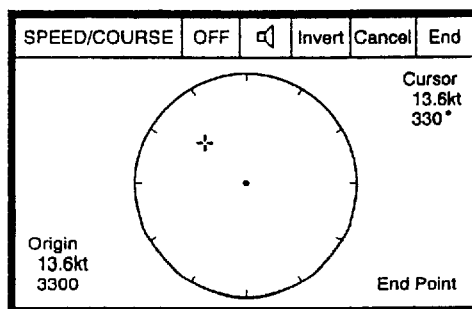

### Alternating alarm zone and non-alarm zone

Place the pointer on the "Invert" window on the top line and press the MENU key, and the alarm zone and the non-alarm zone is alternated.

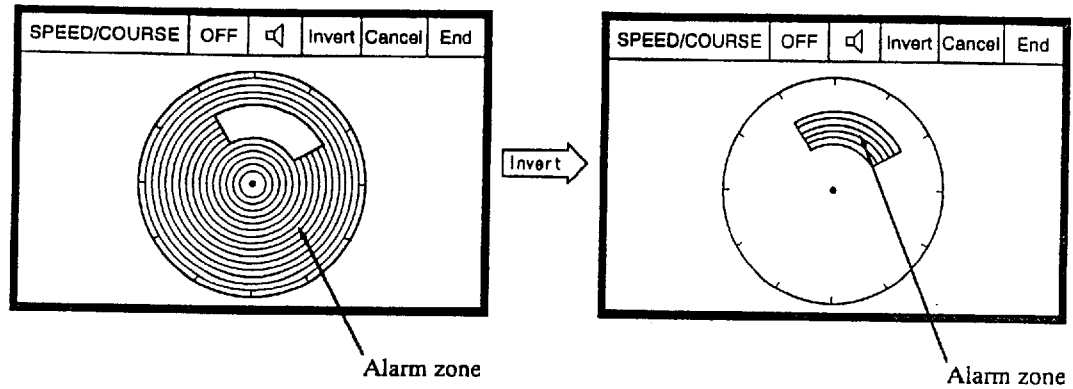

### Canceling alarm zone setting

When you wish to cancel the alarm setting and return to the previous screen, place the pointer on the "Cancel" window on the top line and press the MENU key.

### Turning on or off audible alarm

To turn on or off the audible alarm, leaving the visual alarm active, place the pointer on the "🔊" window and press the MENU key. The symbol in the window will change from "🔊" to "🔇".

### Turning on or off alarm function

To turn on or off the alarm function, place the pointer on "ON (OFF)" window on the top line and press the MENU key.

## Distance Alarm Setting Window

When you select the under-keel clearance, voyage distance or the marker line alarm, the alarm setting window looks something like the figure below.

UKC	OFF	🔊	Cancel	OK
0m				▲
				▼
Set pointer on ▲ or ▼ and press MENU key.				

To set the alarm distance, place the pointer on "▲" or "▼" and press the MENU key until the desired alarm distance is displayed.

# Set Display Menu

In this menu, you may change some items to be displayed on the SPEED, NAV DATA and BERTHING mode screens.

## Main Display

≡ SET DISPLAY ≡	END
SHIP'S TRACK : Past + Predict	
PLOT TIME : 5 min	
CURR/WIND : Yes	
WIND TRU/REL: Relative	
POS/RPM : Position	
UKC SOURCE : Int Graphic	
UKC PRESENT.: Single	
ECHO LEVEL : 7	

## Sub Display

≡ SET DISPLAY ≡	END
SHIP'S TRACK : Past + Predict	
PLOT TIME : 5 min	
CURR/WIND : ON	
WIND TRU/REL: Relative	
POS/RPM : Position	
UKC SOURCE : Int. Graphic	

*Factory setting in bold*

Item	Description	Selection
Ship's Track	Select the type of ship's track to be displayed on the berthing mode screen. Past: Ship's past track Predict: Ship's future movement computed from present speeds (longitudinal, transverse and rate-of-turn-speeds).	<b>1. Past + Predict</b> 2. Past 3. Predict
Plot Time	Choose the plotting time for ship's predicted movement to be displayed on the berthing mode screen. If, for instance, five (5) minutes is selected, the movement from the present time to five minutes future is displayed.	<b>1. 5 min</b> 2. 10 min 3. 20 min 4. 30 min
Curr/Wind	Turns on or off arrows indicating current and wind directions on the berthing mode screen.	<b>1. Yes</b> 2. No
Wind Tru/Rel	Choose true or relative wind speed and direction display True wind: Wind relative to a fixed point on earth. Relative Wind: Wind relative to a moving point on earth, that is, relative to own ship.  <i>Note: Anemometer connection required.</i>	<b>1. True</b> <b>2. Relative</b>
Pos/RPM	Choose to display either ship's position or main engine revolution speed (RPM) on the nav date mode screen  <i>Note: Nav sensor and engine tachometer should be connected to DS-30.</i>	<b>1. Positionn</b> <b>2. Engine RPM</b>

Item	Description	Selection
UKC Source	Choose the signal source and type of under-keel clearance (UKC) display on the nav data mode screen. Int: DS-30                      Ext.: External echo sounder 16-color: Seabed echoes are displayed in 16 colors, depending on echo strength. Graphic: Only the bottom contour is displayed.  <i>Note: To choose "Ext.", digital depth data input required</i>	1. Int. 16 color <b>2. Int. Graphic</b> 3. Ext. Graphic
UKC Present	Choose single (averaged) or triple-split (separate beam) presentation when "Int." is selected in UKC Source item. Single: Under-keel clearance computed from echoes from three beams are averaged. Triple: Echoes from three beams are individually displayed.	1. <b>Single</b> 2. Triple
Echo Level	Sets echo level threshold for the 16-color under-keel clearance display. Normal setting is 5 to 10.	1 to 30 (7)

## Set Alarm Menu

Refer to page 9-4 through 9-8 for operation on the alarm set window.

SET ALARMS	END
SPEED/COURSE : OFF	
RATE OF TURN : OFF	
UKC : OFF	
VOYAGE DIST. : OFF	
MARKER LINE : OFF	
CURRENT : OFF	
WIND : OFF	

*Factory setting in bold*

Item	Description	Selection
Speed/Course	Set the speed/course alarm.	0-40 kt, <b>OFF</b>
Rate of Turn	Set the rate of turn alarm.	100(left)-100(right), <b>OFF</b>
UKC	Set the under-keel-clearance (UKC) alarm. The alarm is activated when the under-the-keel clearance becomes shorter than the set value.	0-100 nm, <b>OFF</b>
Voyage Dist.	Set the voyage distance alarm. The alarm is activated when the set voyage distance is reached.	0-100 nm, <b>OFF</b>

Item	Description	Selection
Marker Line	Set the marker line proximity alarm. The alarm is activated when the distance from own ship ("o" mark) on the berthing mode screen) to the marker line becomes shorter than the set value.	0-2000m, <b>OFF</b>
Current	Set current speed/direction alarm.	0-10 kt, <b>OFF</b>
Wind	Set wind speed/direction alarm.	0-60 m/s, <b>OFF</b>

## Self-test Menu

The self-test menu is used to check the system. The details are explained on page 10-1 to 10-3.

### Main Display

≡	SELF-TEST	≡	END
	PANEL TEST	:	EXECUTE?
	SYSTEM TEST	:	EXECUTE?
	CONT. TEST	:	EXECUTE?
	TX/RX TEST	:	OFF
	SET TEST SPD	:	0.0kt
	SPD TEST ON	:	OFF

### Sub Display

≡	SELF-TEST	≡	END
	PANEL TEST	:	OFF

Item	Description	Selection
Panel Test	Tests the keys and trackball on the operation panel.	EXECUTE?
System Test	Executes the system test once.	EXECUTE?
Cont. Test	Executes the system test repeatedly. Press MENU key again to stop the test and reset the system.	EXECUTE?
TX/RX Test	Check the transducer and associated TX/RX circuits.	1. <b>OFF</b> 2. FORE-STBD 3. STBD-PORT 4. FORE-PORT 5. FORE
Set Tst Spd	Set the value of the internally generated speed signal used for testing.	(-10 to +40 kt (5.0 to 20 m/s) <b>0.0 kt(m/s)</b>
SPD Test On	Activate or deactivate the speed test	1. <b>OFF</b> 2. <b>ON</b>

# Init. Setup Menu

Most items on this menu are set at installation and do not require resetting.

INIT. SETUP		END
DEFAULTS	:	EXECUTE?
ERASE TRACK	:	EXECUTE?
MENU LOCK	:	Lock
HELP	:	ON
TIME DATA	:	Internal
DATE FORMAT	:	M/D/Y
SET DATE	:	...
SET TIME	:	...
TOTAL DIST.	:	0.00NM
RANGE SCALES	:	...
ROT SOURCE	:	Internal

*Factory setting in bold*

Item	Description	Selection
Defaults	Restore factory settings on all user menus, erasing the current setting.	EXECUTE?
Erase Track	Erase ship's past track from berthing mode memory.	EXECUTE?
Menu Lock	Lock or unlock certain menu items to which access is restricted. Lock: Certain menu items are locked and inaccessible. Unlock: All menu items are accessible.	1. Unlock <b>2. Lock</b>
Help	Choose whether to display help message for each menu operation.	<b>1. ON</b> 2. OFF
Time Data	Choose the date/time data source. Internal: Timer in DS-30 External: Timer in nav sensor.	<b>1. Internal</b> 2. External
Date Format	Specify the order in which year (Y), month (M) and day (D) are displayed.	<b>1. Y/M/D</b> 2. M/D/Y 3. D/M/Y
Set Date	Set internal clock date.	
Set Time	Set internal clock time.	
Total Dist.	Set the total distance run readout to the desired value.	



<p>Range Scales</p>	<p>Specify range scales for the berthing mode, ship speed and under-keel clearance graphic displays. When this item is selected, the Sub-2 menu as shown below is displayed. Choose at least two ranges on each item.</p> <p><b>Ship Speed</b> Choose ranges to be registered on SPEED RANGE key for ship's speed graphic display. "Auto" provides automatic selection.</p> <p><b>UKC Y-axis</b> Choose ranges to be registered on the DEPTH key for Y-axis of under-keel clearance (UKC) graphic display. "Auto" provides automatic selection.</p> <p><b>UKC X-axis</b> Choose ranges to be registered on the ADVANCE key for X-axis of the under-keel clearance (UKC) graphic display.</p> <p>*Unit is selected on the system menu. See page 11-1.</p> <p><b>Berth Scale</b> Choose range scales to be registered on scale change arrow keys for berthing mode display.</p> <table border="1" data-bbox="459 1088 759 1330"> <thead> <tr> <th>SHIP SPEED</th> <th>END</th> </tr> </thead> <tbody> <tr><td><input checked="" type="checkbox"/> Auto</td><td></td></tr> <tr><td><input type="checkbox"/> 5 kt</td><td></td></tr> <tr><td><input checked="" type="checkbox"/> 10 kt</td><td></td></tr> <tr><td><input checked="" type="checkbox"/> 20 kt</td><td></td></tr> <tr><td><input type="checkbox"/> 30 kt</td><td></td></tr> <tr><td><input type="checkbox"/> 40 kt</td><td></td></tr> </tbody> </table> <table border="1" data-bbox="778 1088 1078 1357"> <thead> <tr> <th>UKC Y-AXIS</th> <th>END</th> </tr> </thead> <tbody> <tr><td><input checked="" type="checkbox"/> Auto</td><td></td></tr> <tr><td><input type="checkbox"/> 25 m</td><td></td></tr> <tr><td><input checked="" type="checkbox"/> 50 m</td><td></td></tr> <tr><td><input checked="" type="checkbox"/> 100 m</td><td></td></tr> <tr><td><input type="checkbox"/> 200 m</td><td></td></tr> <tr><td><input type="checkbox"/> 300 m</td><td></td></tr> <tr><td><input type="checkbox"/> 400 m</td><td></td></tr> </tbody> </table> <table border="1" data-bbox="459 1384 759 1657"> <thead> <tr> <th>UKC X-AXIS</th> <th>END</th> </tr> </thead> <tbody> <tr><td><input checked="" type="checkbox"/> 5 min</td><td></td></tr> <tr><td><input checked="" type="checkbox"/> 10 min</td><td></td></tr> <tr><td><input type="checkbox"/> 20 min</td><td></td></tr> <tr><td><input checked="" type="checkbox"/> 40 min</td><td></td></tr> <tr><td><input type="checkbox"/> 500 min</td><td></td></tr> <tr><td><input type="checkbox"/> 1000 min</td><td></td></tr> <tr><td><input type="checkbox"/> 2000 min</td><td></td></tr> </tbody> </table> <table border="1" data-bbox="778 1384 1078 1742"> <thead> <tr> <th>BERTH SCALE</th> <th>END</th> </tr> </thead> <tbody> <tr><td><input checked="" type="checkbox"/> 750 m</td><td></td></tr> <tr><td><input checked="" type="checkbox"/> 1000 m</td><td></td></tr> <tr><td><input checked="" type="checkbox"/> 1500 m</td><td></td></tr> <tr><td><input checked="" type="checkbox"/> 2000 m</td><td></td></tr> <tr><td><input checked="" type="checkbox"/> 2500 m</td><td></td></tr> <tr><td><input checked="" type="checkbox"/> 3000 m</td><td></td></tr> <tr><td><input type="checkbox"/> 4000 m</td><td></td></tr> <tr><td><input type="checkbox"/> 5000 m</td><td></td></tr> <tr><td><input type="checkbox"/> 7500 m</td><td></td></tr> <tr><td><input type="checkbox"/> 10000 m</td><td></td></tr> </tbody> </table>	SHIP SPEED	END	<input checked="" type="checkbox"/> Auto		<input type="checkbox"/> 5 kt		<input checked="" type="checkbox"/> 10 kt		<input checked="" type="checkbox"/> 20 kt		<input type="checkbox"/> 30 kt		<input type="checkbox"/> 40 kt		UKC Y-AXIS	END	<input checked="" type="checkbox"/> Auto		<input type="checkbox"/> 25 m		<input checked="" type="checkbox"/> 50 m		<input checked="" type="checkbox"/> 100 m		<input type="checkbox"/> 200 m		<input type="checkbox"/> 300 m		<input type="checkbox"/> 400 m		UKC X-AXIS	END	<input checked="" type="checkbox"/> 5 min		<input checked="" type="checkbox"/> 10 min		<input type="checkbox"/> 20 min		<input checked="" type="checkbox"/> 40 min		<input type="checkbox"/> 500 min		<input type="checkbox"/> 1000 min		<input type="checkbox"/> 2000 min		BERTH SCALE	END	<input checked="" type="checkbox"/> 750 m		<input checked="" type="checkbox"/> 1000 m		<input checked="" type="checkbox"/> 1500 m		<input checked="" type="checkbox"/> 2000 m		<input checked="" type="checkbox"/> 2500 m		<input checked="" type="checkbox"/> 3000 m		<input type="checkbox"/> 4000 m		<input type="checkbox"/> 5000 m		<input type="checkbox"/> 7500 m		<input type="checkbox"/> 10000 m		
SHIP SPEED	END																																																																					
<input checked="" type="checkbox"/> Auto																																																																						
<input type="checkbox"/> 5 kt																																																																						
<input checked="" type="checkbox"/> 10 kt																																																																						
<input checked="" type="checkbox"/> 20 kt																																																																						
<input type="checkbox"/> 30 kt																																																																						
<input type="checkbox"/> 40 kt																																																																						
UKC Y-AXIS	END																																																																					
<input checked="" type="checkbox"/> Auto																																																																						
<input type="checkbox"/> 25 m																																																																						
<input checked="" type="checkbox"/> 50 m																																																																						
<input checked="" type="checkbox"/> 100 m																																																																						
<input type="checkbox"/> 200 m																																																																						
<input type="checkbox"/> 300 m																																																																						
<input type="checkbox"/> 400 m																																																																						
UKC X-AXIS	END																																																																					
<input checked="" type="checkbox"/> 5 min																																																																						
<input checked="" type="checkbox"/> 10 min																																																																						
<input type="checkbox"/> 20 min																																																																						
<input checked="" type="checkbox"/> 40 min																																																																						
<input type="checkbox"/> 500 min																																																																						
<input type="checkbox"/> 1000 min																																																																						
<input type="checkbox"/> 2000 min																																																																						
BERTH SCALE	END																																																																					
<input checked="" type="checkbox"/> 750 m																																																																						
<input checked="" type="checkbox"/> 1000 m																																																																						
<input checked="" type="checkbox"/> 1500 m																																																																						
<input checked="" type="checkbox"/> 2000 m																																																																						
<input checked="" type="checkbox"/> 2500 m																																																																						
<input checked="" type="checkbox"/> 3000 m																																																																						
<input type="checkbox"/> 4000 m																																																																						
<input type="checkbox"/> 5000 m																																																																						
<input type="checkbox"/> 7500 m																																																																						
<input type="checkbox"/> 10000 m																																																																						
<p>ROT SOURCE</p>	<p>Choose source of "rate of turn" data.</p> <ul style="list-style-type: none"> <li>• Internal: When optional Rate-of-Turn Gyro DS-340 is connected.</li> <li>• External ROT: When NMEA format ROT signal is received from an external device.</li> <li>• External HDG: When heading signal is received from an external device.</li> </ul>	<p><b>Internal</b> External ROT External HDG</p>																																																																				

## Parameter Menu (only for main display )

PARAMETERS	END
SHIP SPD AVG	: 10 sec
CURR AVERAGE	: 3 min
WIND AVERAGE	: 1 min
TRACK DEPTH	: 2.0 m
CURR DEPTH	: 2 m
NAV SENSOR	: Auto
NAV REF.	: No
DATA INTVL	: 15 sec
HED. INTVL*	: 30 sec
ROT AVERAGE*	: 60 sec

\*: Displayed only when HEADING is chosen at ROT SOURCE in the EXTERNAL SENSORS menu (page 11-3).

Factory setting lin bold

Item	Description	Selection
Ship's Speed Average	Set averaging time for the ship's speed. You should maintain the factory set value (10 sec) unless you have a specific reason.	1. 5 sec <b>2. 10 sec</b> 3. 15 sec 4. 30sec 5. 60 sec
Current Average	Set averaging time for the water current speed and direction. You should maintain the factory set value (3 minutes) unless you have a specific reason.	1. 1 min 2. 2 min <b>3. 3 min</b> 4. 5 min 5. 10 min
Wind Average	Set the averaging time for the wind speed and direction. You should maintain the factory set value (3 minutes) unless you have a specific reason.	<b>1. 1 min</b> 2. 2 min 3. 3 min 4. 5 min 5. 10 min
Track Depth	Set the water tracking depth for measurement of ship's through-the water speed. The factory setting is 2m. When the ship's through-the water speed readout is unstable due to air bubbles in 2m deep area, set it a little deeper.	2.0 to 25.0 m (0.0 to 80 ft, 1.0 to 12 fa) <b>2.0 m (7.0 ft, 1.0 fa)</b>
Current Measurement	Set the depth for measurement of the water current speed and direction.	2 to 200 m (7 to 300 ft, 1 to 50 fa) <b>2 m (7 ft, 1 fa)</b>
Nav Sensor	Specify source of navigation data. "Auto" provides automatic selection in the priority order GPS, Loran C and Satnav (DR).	<b>1. Auto</b> 2. GPS 3. Loran-C 4. Satnav (DR)

Item	Description	Selection
Current Reference	Choose either data from nav sensor or water reference to calculate speed/direction of water current and wind when ground tracking is not attainable. <b>Yes:</b> Data from nav sensor is used when ground tracking is not attainable. <b>No:</b> Speed/direction of current and wind is measured with respect to water mass in the water tracking depth, when ground tracking is not attainable. When a GPS navigator is connected to the DS-30, it is recommended that “Yes” is selected.	1. Yes 2. <b>No</b>
Data Interval	Choose the data output interval to the external data recorder (option).	1. <b>15 sec</b> 2. 30 sec 3. 1 min 4. 2 min 5. 5 min 6. 10 min 7. 15 min 8. 30 min
HED. INTVL	Choose heading data interval for calculating rate of turn.	1. 0sec 2. 10sec 3. <b>30sec</b> 4. 60 sec 5. 90 sec 6. 120 sec
ROT AVERAGE	Set averaging time for “rate of turn” data.	1. 0sec 2. 10sec 3. 30sec 4. <b>60 sec</b> 5. 90 sec 6. 120 sec

### Offset Data Menu

PARAMETERS	END
TRIM	: +0.0°
HEEL	: +0.0°
XDCR OFFSET	: +0.0°
COMPASS CORR	: +0.0°
R. O. T. ZERO	: +0.0°/min
GND TRL SPD	: +0.0°
WTR TRK SPD	: +0.0°
UKC OFFSET	: +0.0°
SPPED DIFF	: EXECUTE?

Factory setting in bold

Item	Description	Selection
Trim	Set ship’s trim, that is, the relationship of the draft at bow and stern. Use “+” polarity when the ship is down by the stern and “-” polarity when it is down by the head.	-12.5 to +12.5° <b>0.0°</b>
Heel	Set ship’s heel, that is, lateral inclination. Use “+” polarity for starboard up and “-” polarity for starboard down.	-12.5 to +12.5° <b>0.0°</b>

Item	Description	Selection
XDCR Offset	Set deviation angle of the transducer's fore-aft axis with reference to the ship's longitudinal axis. Use "+" polarity when it is deviated to port side. This item is set by the installation engineer and you should not change the setting.	-12.5 to +12.5° <b>0.0°</b>
Compass Correction	Set a correction value to be applied to the heading sensor input to eliminate any constant deviation. Use "+" polarity to add the correction value to the readout and "-" polarity to subtract it from the readout. This item is set by the installation engineer and you should not change the setting.	-12.5 to +12.5° <b>0.0°</b>
R.O.T.(Rate Of Turn) Zero	Set a correction value if required for zero adjustment of the laser rat-of-turn gyro readout. Use "+" polarity to add the correction value to the readout and "-" polarity to subtract it from the readout. This item is set by the installation engineer and you should not change the setting.	-12.5 to +12.5°/min <b>0.0°/min</b>
Ground Track Speed (GND TRK SPD)	Set a correction factor to be applied to the over-the-ground speed measured by DS-30. Use "+" polarity to increase the readout and "-" polarity to decrease it. This item is set by the installation engineer at sea trial by using mile posts and you should not change the setting.	-12.5 to +12.5% <b>0.0%</b>
Water Track Speed (WTR TRK SPD)	<p>Set a correction factor to be applied to the through-the-water speed measured by DS-30. Use "+" polarity to increase the readout and "-" polarity to decrease it. This item is set by the installation engineer sea trial by running the ship on a fair current and then on the head current. You should not change the setting.</p> <p>If the ship's over-the-ground speed is "V<sub>G</sub>" and the water current speed is "V<sub>C</sub>", the ship's through-the-water speed "V<sub>w1</sub>" is given by</p> <p>Ship on fair current    <math>V_{w1} = V_G + V_C</math>                      1</p> <p>Ship on head current    <math>V_{w2} = V_G - V_C</math>                      2</p> <p>Then <math>(V_{w1} + V_{w2})/2 = V_G</math>                      3</p> <p>This means that the ship's through-the-water speeds averaged by equation 3 should be equal to the ground track speed. If there is a difference, a correction factor should be applied.</p>	-12.5 to +12.5% <b>0.0%</b>

# 10. SELF-CHECK

## Self-Check

The DS-30 has a self-check facility for general diagnosis of the major circuits. If an unusual symptom is encountered during operation of the equipment, perform the self-check. If the self-check shows an equipment fault, report the result when calling for service.

### Procedure

1. Call up the main menu by pressing the MENU key.
2. Select the self-test item and press the MENU key. The sub-menu as shown below is displayed.

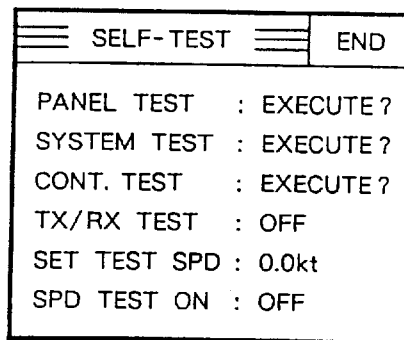

3. Select a self-test item to be executed and press the MENU key. As each self-test item is protected (locked), the following alert appears.

This item is locked.  
Do you want to change setting?

4. Select "Yes" and press the MENU key twice, and the selected self-test is executed.

### Panel Test

The panel test checks the operation panel keys for proper operation.

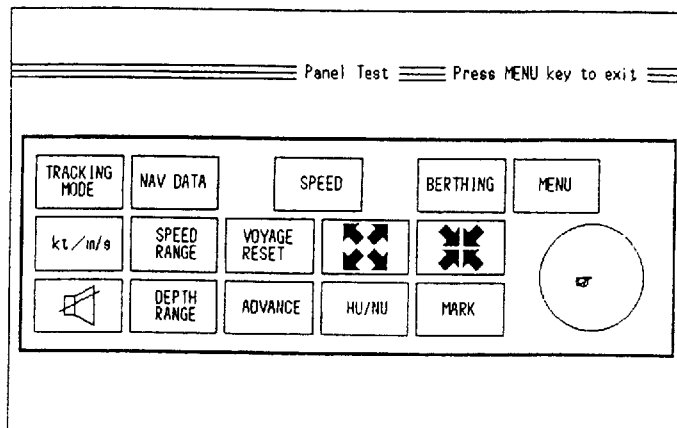

Press each key to see if the corresponding key mark on the screen is highlighted in reverse video. For the trackball, check that the hand pointer (☞) on the screen moves within the circle as the trackball is operated.

To terminate the panel test press the MENU key.

## Single Test

The single test executes the system check for one cycle displaying the test result for each item checked. Items checked are RAM/ROM and battery for display, processor and transceiver units. Seven OKs should be displayed as shown below.

In windows for PORT FORE and STBD beams, color test patterns are displayed. They are an orange bar and a 16-color bar which are alternately displayed, checking color generators in the display unit.

Start up Test																
<pre> ***** DS-300 ***** CP ver. 66501001B1 dev. 0 1 2 3 4 5 6 7 8 9 OK dsw. 02 00 Battery OK           </pre>	<pre> ***** DS-320 ***** CP ver. 6650160100 dev. 0 1 2 OK dsw. 00 00 43 pwt. 073 003 +38.3 +30.1           </pre>															
<pre> ***** DS-310 ***** CP ver. 9203271130 dev. 0 1 2 3 4 5 6 7 8 9 OK dsw. 5C 20 39 FT ver. 6650120100 dev. 0 1 2 3 4 5 6 7 8 9 OK dsw. 18 KL ver. 6650130100 dev. 0 1 2 3 4 5 6 7 OK dsw. 03 00 IF ver. 6650140117 dev. 0 1 2 3 4 OK dsw. 09 A6 DA CO 06 an1. -2.861v -2.883v an2. +2.250v -3.000v an3. +0.063v +0.063v an4. +0.060v +2.532v           </pre>	<table border="1"> <thead> <tr> <th>PORT</th> <th>FORE</th> <th>STBD</th> </tr> </thead> <tbody> <tr> <td></td> <td></td> <td></td> </tr> <tr> <td></td> <td></td> <td></td> </tr> <tr> <td></td> <td></td> <td></td> </tr> <tr> <td></td> <td></td> <td></td> </tr> </tbody> </table> <p>Ss: 0 Sv1: 0 Sv2: 0 NL: -10</p>	PORT	FORE	STBD												
PORT	FORE	STBD														

## Continuous Test

The continuous test executes the system check repeatedly. In addition to the check items of the single test, it displays the transmission voltage/current and received echoes for port, fore and starboard beams.

1	Display transmission voltages for PROT, FORE, STBD beams. Check that the three voltages are more than 180 V. *
2	Displays transmission currents for PORT, FORE and STBD beams. Check that the three current are more than 3.0 A. *
3	Displays received echoes for FORE, PORT and STBD beams. When speed readings are abnormal, check that there is no interruption of echoes due to aeration. Use DEPTH RANGE key to change the depth scale.

\*: The values are changeable, so read the maximum values.

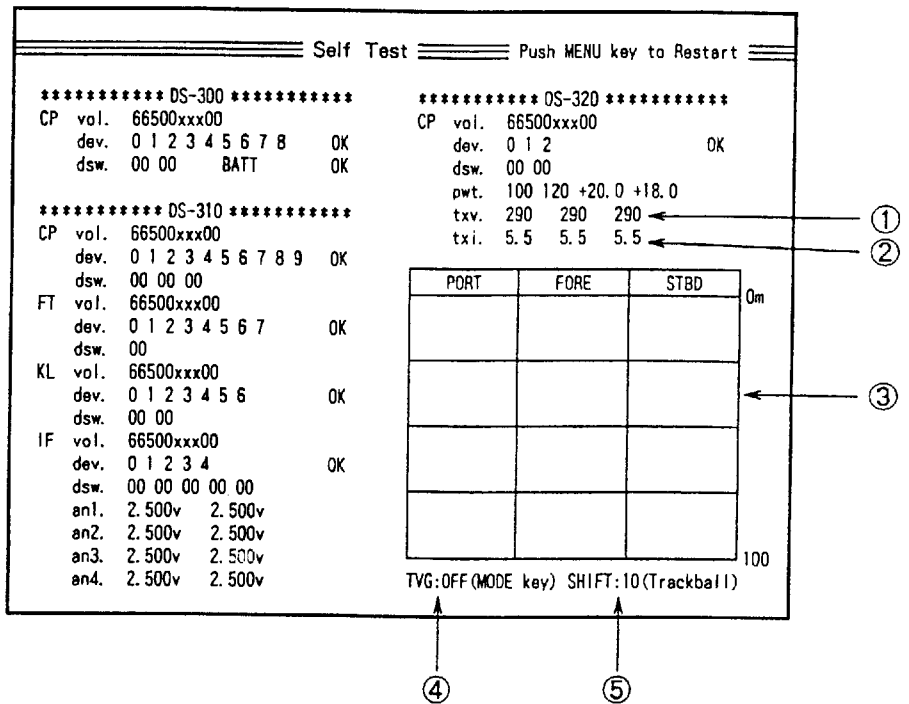

4	<p><b>TVG: ON/OFF</b>  <b>TRACKING MODE</b> key turns on/off the TVG (Time Varied Gain) which is applied to the received echoes displayed in item 3.          When the TVG is ON, propagation attenuation of sound in water is compensated so that echoes from targets with the same property are displayed in the same intensity irrespective of depth where the targets are located.</p>
5	<p><b>SHIFT: 10</b>          Shows gain for echoes displayed in item 3. Use the <b>TRACKBALL</b> to change the gain.</p>

## TX/RX Test

The TX/RX checks the transceiver circuit and the transducer for each beam.

When the speed readings measured by DS-30 are abnormal and echoes shown in the continuous test seem weak for a particular beam, the transceiver circuit or the transducer for that beam may be defective. Conduct the beam test.

In beam FORE-STBD test, the ship's speed is measured by using the fore beam and starboard beam, without using port beam. Likewise, in beam STBD-PORT test, the fore beam is not used, and in beam FORE-PORT test, starboard beam.

If, for example, the speed readings are normal in beam FORE-STBD test but abnormal in beam DTBD-PORT and FORE-STBD tests, the transceiver or the transducer for the portbeam is faulty.

■ **Note**

*When one of the three beams is faulty and you still wish to use the DS-30, use it with the beam test turned on, isolating the faulty beam. Accuracy of the speed measurement goes low but may be practically acceptable for ocean going navigation.*

## **Error Warning**

The DS-30 generates visual and audible warnings when it is unable to provide desired performance or continue operation due to troubles in the system or in the data communication with external sensors. The visual warning is displayed in code on the lowest line of the screen. If multiple warnings occur simultaneously, five error codes at maximum are displayed from the smallest number code. The table below describes error codes and their meanings.

<b>Error Code</b>	<b>Error Status</b>
000	Error in data communication with transceiver unit.
001	Abnormal ship's mains voltage (outside $\pm 15\%$ of rated value)
002	Overheated transducer (transducer surface temperature more than 60°C)
003	Abnormal + B voltage
004	Abnormal TX voltage of beam 1
005	Abnormal TX current of beam 1
006	Abnormal TX voltage of beam 2
007	Abnormal TX current of beam 2
008	Abnormal TX voltage of beam 3
009	Abnormal TX current of beam 3
020	Abnormally high temperature in display unit
100	Heading data input error (gyrocompass)
101	Rate-of-turn data input error
102	High temperature in rate-of-turn gyro
103	Abnormal lazer in rate-of-turn gyro
104	Abnormal control in rate-of-turn gyro
200	Temperature sensor input error (transducer)
201	Clinometer pitching signal input error
202	Clinometer rolling signal input error



# Troubleshooting Flow Chart

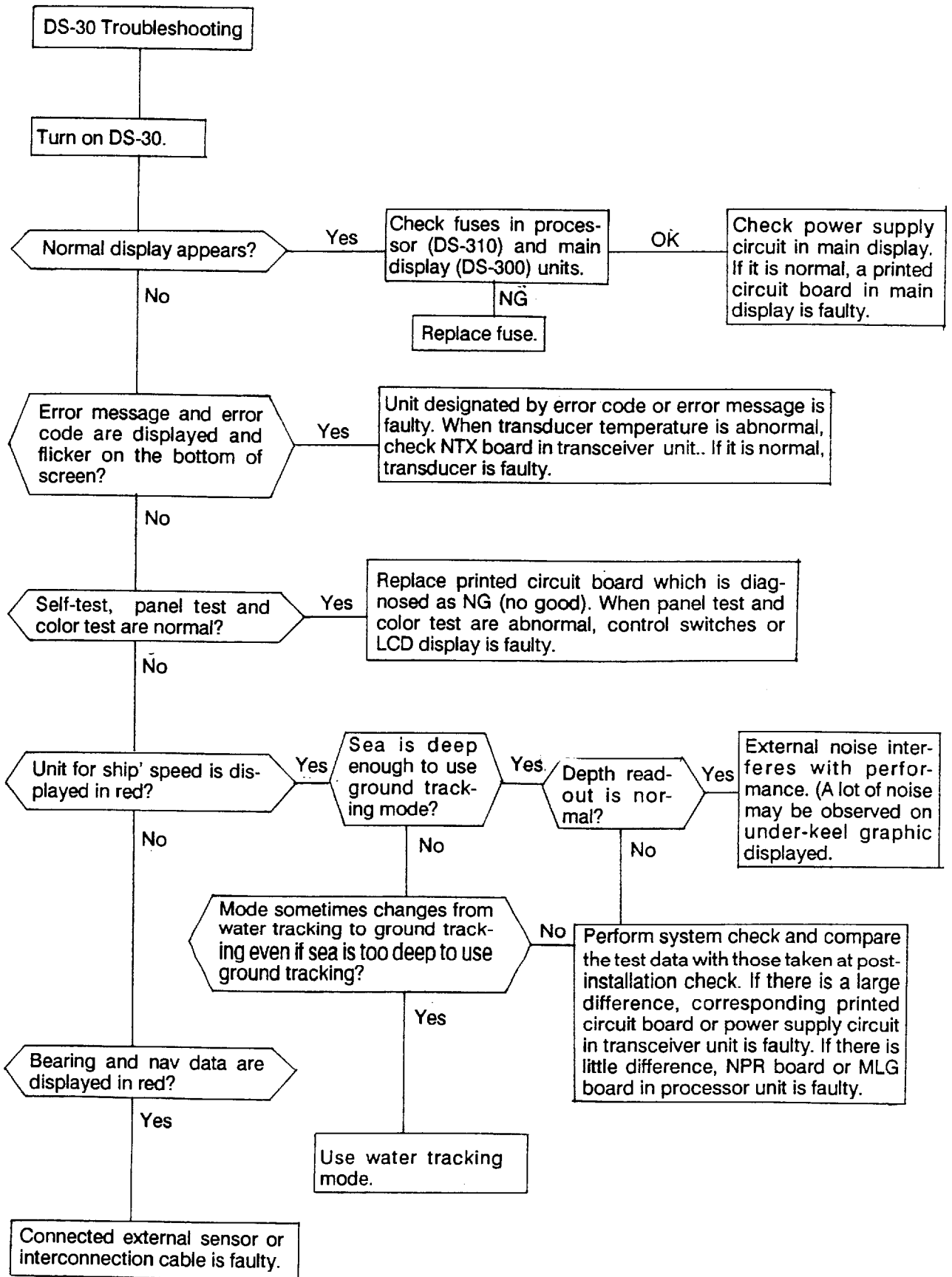

# 11. SYSTEM MENU SETTING

The system menu is set by a service engineer at installation and therefore you need not to change settings.

## Opening System Menu

Press and hold both the POWER switch MENU key until a beep sound stops..

## Closing System Menu

Turn off and then on the POWER switch.

## Operation on System Menu

Operation on the system menu is the same as that on the user menu. See page 9-3.

## Content of System Menu

### Display Unit Preset Menu

Item	Description	Selection
Cursor Speed	Choose the speed at which the cursor is moved by the trackball.	1. Slow 2. <b>Medium</b> 3. Fast
Depth Unit	Choose the unit of depth for the under-keel clearance display.	1. <b>m</b> 2. ft 3. fa
Distance Run	Choose the unit for the distance run readout.	1. <b>nm</b> 2. km
Curr. Speed	Choose the unit for the current speed readout.	1. <b>kt</b> 2. m/s
Wind Speed	Choose the unit for the wind speed readout.	1. kt 2. <b>m/s</b>

Item	Description	Selection
Scale Unit	Choose the distance scale unit for the X-axis of the berthing mode and the under-keel clearance graphic display.	1. m 2. nm
Speed Resolution Level	Choose the resolution level for the ship's speed readout.	1. XX. XX 2. XX.X or XX.XX
Current Direction	Choose "Normal" so that the water current direction readout shows the direction toward which water moves.	1. Normal 2. Opposite
Wind Direction	Choose "Normal" so that wind direction readout shows the direction from which the wind blows.	1. Normal 2. Opposite
Bottom Hardness	Choose whether to display bottom hardness level on the under-keel clearance graphic display.	1. Yes 2. No
Beep Sound	Choose tone/pattern of the audible alarm.	1/2/3/4
System Default	Restore factory settings on all the system menus, erasing present settings.	

## Display Test Menu

Item	Description
Panel Test	Test the keys and trackball on the operation panel.
Color Test	Check display colors.
Pixel Test	Check RGB pixels of color LCD screen.
Gradation	Check gradation of color LCD screen.

## Ship Data Menu

Item	Description	Selection
Reference Point	Specify a reference point for measurement of the ship's data.	1. Bow 2. Stern
Loa	Set ship's length overall.	50.0 to 400.0m
B	Set ship's breadth.	5.0 to 100.0m
L1		0.0 to 30.0m
L2		
L3		
L4		
L5		
L6		
D1	Set distance between DS-30 and #1 transducer echo sounders.	
D2	Set distance between DS-30 and #2 transducer echo sounders.	

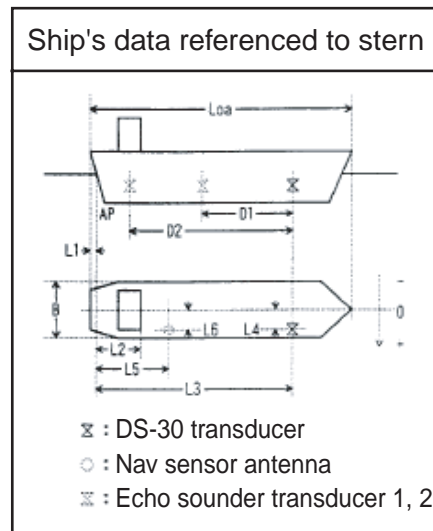
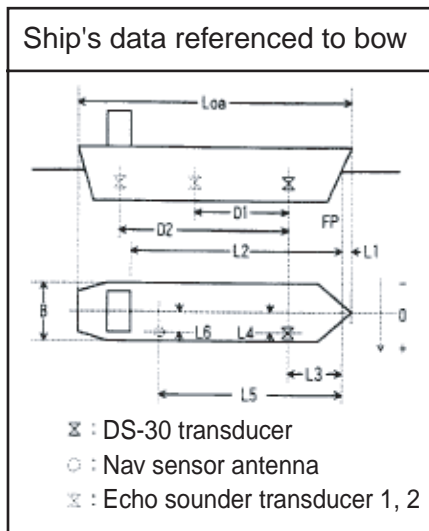

## External Sensor Menu

Item	Description	Selection
GYROCOMPASS	Choose YES if a gyrocompass is connected.	Yes / No
R.O.T GYRO	Choose YES if a laser gyro is connected.	Yes / No
NAV SENSOR	Choose YES if a nav sensor is connected.	Yes / No
WIND METER	Choose YES if a wind meter is connected.	Yes / No
TACHOMETER	Choose YES if main engine's tachometer is connected.	Yes / No
CLINOMETER	Choose YES if a clinometer is connected.	Yes / No

## 12. REPLACEMENT OF SENSOR IN RATE-OF-TURN GYRO (OPTION)

The life of the sensor is approx. 17,000 hours. When its life has expired, the following may occur when the vessel is dead in water;

- 1) The rate-of-turn speed indication is abnormally large.
- 2) The transverse speed indication is abnormally large.

The elapsed time is shown on the hour meter in the Rate-of-Turn Gyro. When it exceeds 17,000 hours, replace the sensor.

Name	Type	Code number
Sensor	HOFG-2H (Ver. 3.1)	000-128-877

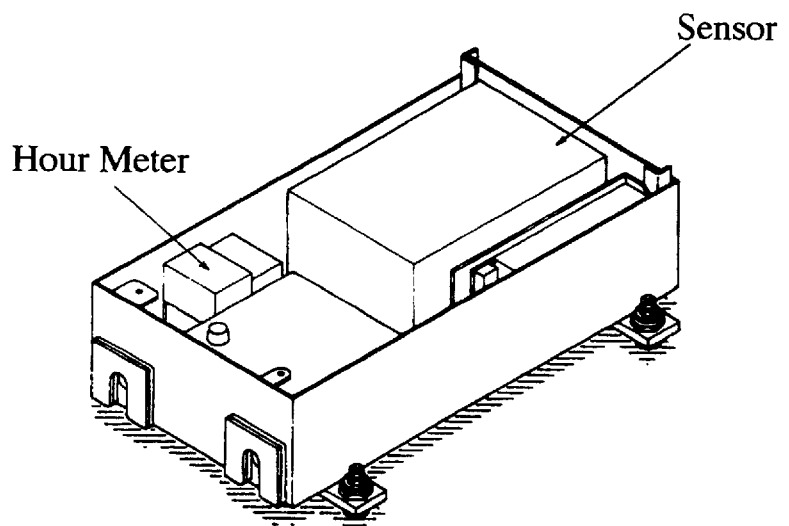

# 13. SPECIFICATIONS OF DOPPLER SONAR DS-30

---

## 1. Measurement Range

### a. Ship's Speed

#### Bow:

Fore-aft: -10.00 to + 40.00 knots

Port-stbd: -9.99 to + 9.99 knots

Stern with optional Laser gyro, gyrocompass or ROT data:

Port-stbd: -9.99 to + 9.99 knots

### b. Speed Measurement Depth

Ground tracking: 1 to 200m below hull bottom

Water tracking: 3 to 25m below hull bottom

(Above figures will be changed depending on installation conditions and surrounding water conditions. The measuring accuracy will be reduced for the depth shallower than 30 m.)

### c. Current

Direction: 360 degrees (Relative or True with gyro signal input)

Speed: 0.0 to + 9.9 knots

### d. Current Measurement Depth

2 to 100m below hull bottom (clearance of more than 8m required)

## 2. Accuracy

### a. Ship's Speed

- $\pm 0.2\%$  or  $\pm 0.01$  m/sec for low ship's speed ground tracking.
- $\pm 1.0\%$  or  $\pm 0.1$  knots for water tracking mode and high ship's speed ground tracking (clearance of more than 30m).
- $\pm 1.0\%$  or  $\pm 0.04$  m/sec for port-stbd at stern (ship's length 400 m) [Influence of ship's inclination and vibration excepted. With Laser Gyro DS-340]
- $\pm 1.0\%$  or  $\pm 0.06$  m/s (0.1 kt) for port-stbd at stern (ship's length approx. 340 m) [Influence of ship's inclination and vibration excepted. With a gyrocompass compatible with IMO performance standard (ROT accuracy:  $0.5^\circ/\text{min}$ ), receiving ROT signal less than one sec. interval. The accuracy is dependent on the performance of the gyrocompass.

### b. Sea Depth (clearance) :

$\pm 1.0\%$  or  $\pm 0.1$  m

(at 1500 m/sec of sound velocity and by converting inclined beams to vertical, without consideration of temperature error.)

### c. Distance Signal

$\pm 1.0\%$  or  $\pm 0.1$  nm

### d. Current Speed

$\pm 2.0\%$  or  $\pm 0.2$  kt

NOTE 1: The speed error which results from variation of sound velocity by water temperature is automatically compensated by water temperature measured with temperature sensor mounted on the transducer: The salinity does not affect accuracy.

NOTE 2: Ship's static inclination (trim and heel) degrades accuracy by  $100(\cos\theta-1)\%$  (where  $\theta$  = angle of inclination). The error caused by this inclination can be corrected by entering trim and heel angles ( $-12.5^\circ$  to  $+12.5^\circ$ ) on the OFFSET DATA menu.

NOTE 3: Ship's rolling/pitching degrades accuracy by 0.2% for  $\pm 5^\circ$  rolling/pitching and 0.65% for  $\pm 10^\circ$ . The error is 1% when it is 11.5%.

### 3. Display

- a. Display Unit                      10-inch color LCD
- b. Digital Display Unit            Wide angle numeric LCD

### 4. Transmission Frequency

440 kHz

### 5. Input/Output Signal

- a. Input/Output                      Serial signal: 2 ports
- b. Input                                Heading from gyro via Converter AD-100: 1 port  
Keying pulse from onboard echo sounding equipment for minimizing interference: 2 ports  
DC signal for wind/speed direction: 1 port  
DC voltage signal for main engine revolution: 1 port
- c. Output                              Ship speed (for digital indicator): 3 ports  
for distribution box: 1 port  
Distance signal: for distribution box: 1 port  
for contact closure signal: 8 ports  
(200 pulses/nm, forward data only, 30V, 0.2A max.)  
for TTL signal (400 p/nm, forward data only): 1 port  
Alarm signal: contact signal (30V, 2A max): 1 port  
Keying pulse: 1 port
- d. IEC 61162-1 2<sup>nd</sup> edition        Input signal: ZDA, GLL, VTG, DBT, RMA, RMC,  
format signal                                HCC\*, HDM\*, DBK\*  
Output signal: VDR, VHW, VTG, VLW, VBW, ROT, VCD\*  
\* = Available in NMEA sentence

### 6. Power Supply

Ship's Mains                              100, 110, 120, 200, 220 or 240 VAC  
1 $\phi$ , 50/60 Hz, 300 VA or less (average), 400 VA or less (peak value)

### 7. Environmental Conditions

- a. Temperature                         $-15^\circ\text{C}$  to  $+55^\circ\text{C}$
- b. Humidity                              95% (at  $40^\circ\text{C}$ ) max.  
(Display unit should be installed indoors)

## 8. Coating Color

Standard

Munsell 2.5G 7/2 Newtone No.1

## 9. Distribution Box DS-370 (Option)

a. Input Signal	Digital speed signal Log signal (400p/nm) Alarm signal Power on/off signal
b. Output signal	The following output boards are selectable. (7 boards max.)
OTX board	Serial signal for DS-350/351 digital indicator and/or cascade connection of DS-370 distribution box.
ODD board	BCD signal for digital indicator
OAD board	Analog current signal for analog indicator (2 ports) -2.5mA to 10.0mA for -10kt to 40kt or -3.33mA to 10.0mA for -10kt to 30kt
OLG board	For distance indicator ( 1 port) Log signal (200/400 p/nm contact closure signal, 30V/0.2A,3 ports) One log signal port can be modified to fore/aft status signal port (contact closure signal, 30V, 0.2A)
OAC board	Ship's speed current signal (4.0mA to 20.0mA for -10kt to max. speed. max load 250 ohms, 1 port) Ship's speed status signal ( 1 port)
OAV board	Ship's speed voltage signal, 1 port (-2.50 to 10.0V for -10kt to 40kt. -3.33 to 10.0V for -10kt to 30kt, -4.00 to 10.0V for -10kt to 25kt, -5.00 to 10.0V for -10kt to 20kt, max load 1k ohm) Ship's speed status signal, 1 port

## 10. Digital Indicator DS-350 (Option)

a. Indication System	LED display with dimmer
b. Indication	
Speed	Fore/aft: 0.00 to 99.99 Port/stb: 0.00 to 9.99
Unit	Knot or m/s
Direction	By up/down and right/left arrows
Mode	Ground or water tracking
Depth	Up to 99.9m
c. Controls	Dimmer, Mode switch, Unit switch



## 11. Digital Indicator DS-351 (Option)

- a. Indication System      LCD display with dimmer
- b. Indication
  - Speed                      Fore/aft: 0.00 to 99.99  
                                 Port/stb: 0.00 to 9.99
  - Unit                        Knot or m/s
  - Direction                By up/down and right/left arrows
  - Mode                      Ground or water tracking
  - Depth                     Up to 99.9m
- c. Controls                Dimmer, Mode switch, Unit switch

*Note: 1. Depths are measured below transducer surface (hull bottom).*

*2. The DS-30 uses an acoustic wave for speed measurements.*

*Aeration due to rapid acceleration/deceleration, heavy engine/propeller vibration or interference from other sounding equipments can degrade performance of this equipment.*

# 14. TABLES FOR RECORDING USER PRESETS

The DS - 30 employs menus to preset various measuring and display parameters, to customize the equipment precisely to your operating conditions.

Fill in the form below to record your presets, so they can be restored if lost by misoperation or by maintenance/service work.

Items marked with "⊙" can be changed by user.

Items marked with "\*" should not be changed by user. They are set at installation. Change can degrade the accuracy of measurements.

## I . USER MENU

### 1. SET DISPLAY MENU

	ITEM	USER PRESET <input checked="" type="checkbox"/> : selected				FACT. SETTING
⊙	PLOT TYPE	<input type="checkbox"/> Past + Predict	<input type="checkbox"/> Past	<input type="checkbox"/> Predict		Past + Predict
⊙	PLOT TIME	<input type="checkbox"/> 5min	<input type="checkbox"/> 10min	<input type="checkbox"/> 20min	<input type="checkbox"/> 30min	5min
⊙	CURR/WIND	<input type="checkbox"/> ON	<input type="checkbox"/> OFF			Yes
⊙	WIND TRU/REL	<input type="checkbox"/> True	<input type="checkbox"/> Relative			True
⊙	POS/RPM	<input type="checkbox"/> Position	<input type="checkbox"/> Engine RPM			Position
⊙	UKC SOURCE	<input type="checkbox"/> Int. 8-Color	<input type="checkbox"/> Int. Graphic	<input type="checkbox"/> Ext. Graphic		Int. Graphic
⊙	UKC PRESENT	<input type="checkbox"/> Single	<input type="checkbox"/> Triple			Single
⊙	ECHO LEVEL		1 to 30			7

### 2. INIT. SETUP MENU

	ITEM	USER PRESET <input checked="" type="checkbox"/> : selected				FACT. SETTING
*	MENU LOCK	<input type="checkbox"/> Lock	<input type="checkbox"/> Unlock			Lock
⊙	HELP	<input type="checkbox"/> ON	<input type="checkbox"/> OFF			ON
⊙	TIME DATA	<input type="checkbox"/> Internal	<input type="checkbox"/> External			Internal
⊙	DATE FORMAT	<input type="checkbox"/> Y/M/D	<input type="checkbox"/> M/D/Y	<input type="checkbox"/> D/M/Y		Y/M/D

### 3. PARAMETERS MENU

	ITEM	USER PRESET <input type="checkbox"/> : selected					FACT. SETTING
⊙	SHIP SPD AVG	<input type="checkbox"/> 5sec	<input type="checkbox"/> 10sec	<input type="checkbox"/> 15sec	<input type="checkbox"/> 30sec	<input type="checkbox"/> 60sec	10sec
*	CURR AVERAGE	<input type="checkbox"/> 1min	<input type="checkbox"/> 2min	<input type="checkbox"/> 3min	<input type="checkbox"/> 5min	<input type="checkbox"/> 10min	3min
*	WIND AVERAGE	<input type="checkbox"/> 1min	<input type="checkbox"/> 2min	<input type="checkbox"/> 3min	<input type="checkbox"/> 5min	<input type="checkbox"/> 10min	1min
*	TRACK DEPTH	[    ] m	0.0 to 25.0m				2.0m
⊙	CURR. DEPTH	[    ] m	0 to 100m				2m
*	NAV. SENSOR	<input type="checkbox"/> AUTO	<input type="checkbox"/> GPS	<input type="checkbox"/> LC	<input type="checkbox"/> DR		Auto
⊙	CURRENT REF.	<input type="checkbox"/> Yes	<input type="checkbox"/> No				No
⊙	DATA INTVL	<input type="checkbox"/> 15sec	<input type="checkbox"/> 30sec	<input type="checkbox"/> 1min	<input type="checkbox"/> 2min	<input type="checkbox"/> 5min	15sec
		<input type="checkbox"/> 10min	<input type="checkbox"/> 15min	<input type="checkbox"/> 30min			

### 4. OFFSET DATA MENU

	ITEM	USER PRESET <input checked="" type="checkbox"/> : selected		FACT. SETTING
⊙	TRIM	[    ] °	- 12.5 to + 12.5°	0.0°
⊙	HEEL	[    ] °	- 12.5 to + 12.5°	0.0°
*	XDCR OFFSET	[    ] °	- 12.5 to + 12.5°	0.0°
*	COMPASS CORR	[    ] °	- 12.5 to + 12.5°	0.0°
*	R. O. T. ZERO	[    ] °/min	- 12.5 to + 12.5°/min	0.0°/min
*	GND TRK SPD	[    ] %	- 12.5 to + 12.5 %	0.0 %
*	WTR TRK SPD	[    ] %	- 12.5 to + 12.5 %	0.0 %
*	UKC OFFSET	[    ] m	- 50.0 to + 50.0m	0.0m

### 5. RANGE SCALES SUB-MENU (INIT. SETUP MENU)

	ITEM	USER PRESET <input type="checkbox"/> : selected					FACT. SETTING	
⊙	SHIP SPEED	<input type="checkbox"/> Auto	<input type="checkbox"/> 5kt	<input type="checkbox"/> 10kt	<input type="checkbox"/> 20kt	<input type="checkbox"/> 30kt	<input type="checkbox"/> 40kt	Auto, 10kt, 20kt
⊙	UKC Y-AXIS	<input type="checkbox"/> Auto	<input type="checkbox"/> 25m	<input type="checkbox"/> 50m	<input type="checkbox"/> 100m	<input type="checkbox"/> 200m		Auto, 50m, 100m
		<input type="checkbox"/> 300m	<input type="checkbox"/> 400m					
⊙	UKC X-AXIS	<input type="checkbox"/> 5min	<input type="checkbox"/> 10min	<input type="checkbox"/> 20min	<input type="checkbox"/> 40min	<input type="checkbox"/> 500min		5min, 10min, 500min
		<input type="checkbox"/> 1000m	<input type="checkbox"/> 2000m					
⊙	BERTH SCALE	<input type="checkbox"/> 100m	<input type="checkbox"/> 150m	<input type="checkbox"/> 200m	<input type="checkbox"/> 250m	<input type="checkbox"/> 300m	<input type="checkbox"/> 400m	750m, 1000m
		<input type="checkbox"/> 500m	<input type="checkbox"/> 750m	<input type="checkbox"/> 1000m	<input type="checkbox"/> 1500m	<input type="checkbox"/> 2000m	<input type="checkbox"/> 2500m	1500m, 2000m
		<input type="checkbox"/> 3000m	<input type="checkbox"/> 4000m	<input type="checkbox"/> 5000m				2500m, 3000m

## II . SYSTEM MENU

### 1. DISPLAY UNIT PRESET MENU

	ITEM	USER PRESET <input checked="" type="checkbox"/> : selected				FACT. SETTING
⊙	CURSOR SPEED	<input type="checkbox"/> Slow	<input type="checkbox"/> Medium	<input type="checkbox"/> Fast		Medium
⊙	DEPTH UNIT	<input type="checkbox"/> m	<input type="checkbox"/> ft	<input type="checkbox"/> fa		m
⊙	DISTANCE RUN	<input type="checkbox"/> nm	<input type="checkbox"/> km			nm
⊙	CURR SPEED	<input type="checkbox"/> kt	<input type="checkbox"/> m/s			kt
⊙	WIND SPEED	<input type="checkbox"/> kt	<input type="checkbox"/> m/s			kt
⊙	SCALE UNIT	<input type="checkbox"/> m	<input type="checkbox"/> nm			m
⊙	SPD RES LVL	<input type="checkbox"/> xx.xx	<input type="checkbox"/> x.xx or xx.x			xx.xx
⊙	CURRENT DIR	<input type="checkbox"/> Normal	<input type="checkbox"/> Opposite			Normal
⊙	WIND DIR	<input type="checkbox"/> Normal	<input type="checkbox"/> Opposite			Normal
⊙	BTM HARDNESS	<input type="checkbox"/> *Yes	<input type="checkbox"/> No			No
⊙	BEEP SOUND	<input type="checkbox"/> 1	<input type="checkbox"/> 2	<input type="checkbox"/> 3	<input type="checkbox"/> 4	

### 2. SHIP DATA MENU

	ITEM	USER PRESET <input checked="" type="checkbox"/> : selected		FACT. SETTING
*	REF POINT	<input type="checkbox"/> Bow	<input type="checkbox"/> Stern	<input type="checkbox"/> Bow
*	Loa	[    ] m	50 to 400.0 m	0.0m
*	B	[    ] m	5.0 to 100.0 m	0.0m
*	L1	[    ] m	0.0 to 30.0 m	0.0m
*	L2	[    ] m	0.0 to (Loa - L1) m	0.0m
*	L3	[    ] m	0.0 to (Loa - L1) m	0.0m
*	L4	[    ] m	- B/2 to + B/2m	0.0m
*	L5	[    ] m	0.0 to (Loa - L1) m	0.0m
*	L6	[    ] m	- B/2 to + B/2m	0.0m
*	D1	[    ] m	0.0 to (Loa - L1) m	0.0m
*	D2	[    ] m	0.0 to (Loa - L1) m	0.0m

### 3. EXTERNAL SENSORS MENU

	ITEM	USER PRESET <input checked="" type="checkbox"/> : selected			FACT. SETTING
*	GYROCOMPASS	<input type="checkbox"/> Yes	<input type="checkbox"/> No		No
*	R. O. T. GYRO	<input type="checkbox"/> Yes	<input type="checkbox"/> No		No
*	NAV SENSOR	<input type="checkbox"/> Yes	<input type="checkbox"/> No		No
*	WIND METER	<input type="checkbox"/> Yes	<input type="checkbox"/> No		No
*	TACHOMETER	<input type="checkbox"/> Yes	<input type="checkbox"/> No		No
*	CLINOMETER	<input type="checkbox"/> Yes	<input type="checkbox"/> No		No

# 15. DIGITAL INTERFACE (IEC 61162-1 EDITION 2)

## Output sentences of channel 1, 2 (NMEA/CIF 1, NMEA/CIF 2)

VDR, VHW, VTG, VLW (talker VD), VBW, ROT

## Input sentences of channel 1, 2 (NMEA/CIF 1, NMEA/CIF 2)

ZDA, GLL, VTG, DBT, RMA, RMC

## Transmission interval

1 s for any sentence

## Data transmission

Data is transmitted in serial asynchronous form in accordance with the standard referenced in 2.1 of IEC 61162-1. The first bit is a start bit and is followed by data bits, least-significant-bit as illustrated below.

The following parameters are used:

Baud rate: 4800

Data bits: 8 (D7 = 0), parity none

Stop bits: 1

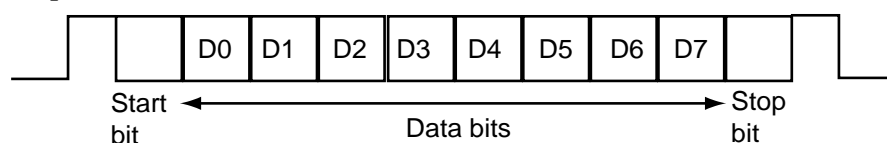

## Schematic diagram

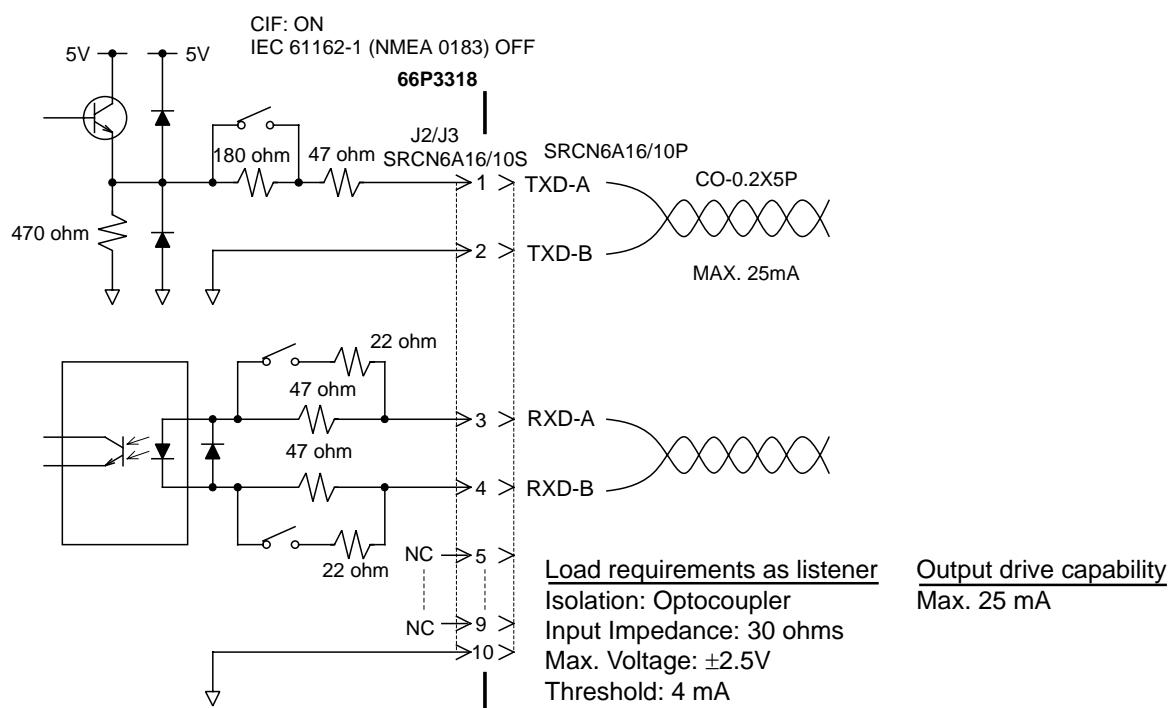

## Data sentences (input)

### DBT – Depth below transducer

\$--DBT,x.x,f,x.x,M,x.x,F\*hh<CR><LF>

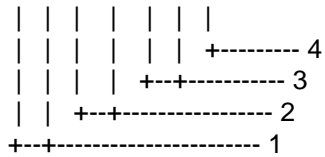

1. Water depth, feet
2. Water depth, m
3. Water depth, fathoms
4. Checksum

### GLL – Geographic position, latitude and longitude

\$--GLL,III.III,a,yyyyy.yyy,a,hhmmss.ss,A,a\*hh<CR><LF>

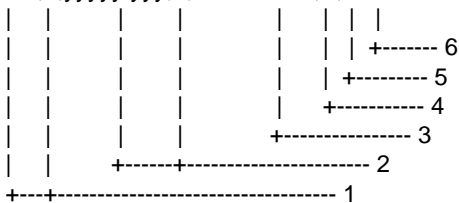

1. Latitude, N/S
2. Longitude, E/W
3. UTC of position
4. Status: A=data valid, V=data invalid
5. Mode indicator(see note)
6. Checksum

NOTE Positioning system Mode indicator:

- A = Autonomous
- D = Differential
- E = Estimated (dead reckoning)
- M = Manual input
- S = Simulator
- N = Data not valid

The Mode indicator field supplements the Status field. The Status field shall be set to V=invalid for all values of Operating Mode except for A=Autonomous and D=Differential. The positioning system Mode indicator and Status field shall not be null fields.

### MWD – Wind direction and speed

\$--MWD,x.x,T,x.x,M,x.x,N,x.x,M\*hh<CR><LF>

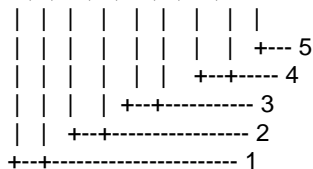

1. Wind direction, 0 to 359 true
2. Wind direction, 0 to 359 Magnetic
3. Wind speed, knots
4. Wind speed, m/s
5. Checksum

## MTW - Water temperature

\$--MTW,x.x,C\*hh<CR><LF>

```

| | |
| | +----- 2
+---+----- 1

```

1. Temperature, degrees C
2. Checksum

## RMA - Recommended minimum specific LORAN-C data

\$--RMA,A,III.III,a,yyyyy.yy,a,x.x,x.x,x.x,x.x,x.x,a\*hh<CR><LF>

```

| | | | | | | | | | | |
| | | | | | | | | | | | +----- 10
| | | | | | | | | | | | +----- 9
| | | | | | | | | | | +---+----- 8
| | | | | | | | | | +----- 7
| | | | | | | | | +----- 6
| | | | | | | | +----- 5
| | | | | | | +----- 4
| | | | | | +---+----- 3
| | | | | +----- 2
+----- 1

```

1. Status: A=data valid, V=blink, cycle or SNR warning
2. Latitude, degrees N/S
3. Longitude, degrees E/W
4. Time difference A, microseconds
5. Time difference B, microseconds
6. Speed over ground, knots
7. Course over ground, degrees true
8. Magnetic variation(see note 1),degree E/W
9. Mode indicator(see note 2)
10. Checksum

NOTE 1 - Easterly variation(E) subtracts from true course  
Westerly variation(W) adds to true course

NOTE 2 Positioning system Mode indicator:

- A = Autonomous
- D = Differential
- E = Estimated (dead reckoning)
- M = Manual input
- S = Simulator
- N = Data not valid

The Mode indicator field supplements the Status field. The Status field shall be set to V=invalid for all values of Operating Mode except for A=Autonomous and D=Differential. The positioning system Mode indicator and Status field shall not be null fields.



## RMC - Recommended minimum specific GPS/TRANSIT data

\$--RMC,hhmmss.ss,A,lll.lll,a,yyyyy.yyy,a,x.x,x.x,xxxxx,x.x,a,a\*hh<CR><LF>

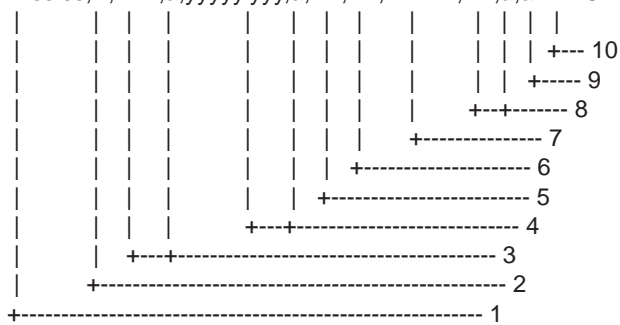

1. UTC of position fix
2. Status: A=data valid, V=navigation receiver warning
3. Latitude, N/S
4. Longitude, E/W
5. Speed over ground, knots
6. Course over ground, degrees true
7. Date: dd/mm/yy
8. magnetic variation, degrees E/W
9. Mode indicator(see note)
10. Checksum

NOTE Positioning system Mode indicator:

- A = Autonomous
- D = Differential
- E = Estimated (dead reckoning)
- M = Manual input
- S = Simulator
- N = Data not valid

The Mode indicator field supplements the Status field. The Status field shall be set to V=invalid for all values of Operating Mode except for A=Autonomous and D=Differential. The positioning system Mode indicator and Status field shall not be null fields.

## MWV – Wind speed and angle

\$--MWV,x.x,a,x.x,a,A\*hh<CR><LF>

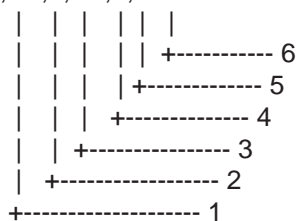

- 1.2. Wind angle (000.0 to 359.9), Reference (R: Relative, T: True)
- 3.4. Wind speed (00.00 to 99.99), Units (K/M/N)
5. Status (A: OK, V: NG)
6. Checksum





## VLW - Distance travelled through the water

\$--VLW,x.x,N,x.x,N\*hh<CR><LF>

```

| | | | |
| | | | +----- 3
| | +----- 2
+----- 1

```

1. Total cumulative distance, nautical miles
2. Distance since reset, nautical miles
3. Checksum

## VTG - Course over ground and ground speed

\$--VTG,x.x,T,x.x,M,x.x,N,x.x,K,a\*hh<CR><LF>

```

| | | | | | | | | | |
| | | | | | | | | | +----- 6
| | | | | | | | | | +----- 5
| | | | | | | | | | +----- 4
| | | | | | | | | | +----- 3
| | | | | | | | | | +----- 2
+----- 1

```

1. Course over ground, degrees true
2. Course over ground, degrees magnetic
3. Speed over ground, knots
4. Speed over ground, km/h
5. Mode indicator(see note)
6. Checksum

NOTE Positioning system Mode indicator:

- A = Autonomous
- D = Differential
- E = Estimated (dead reckoning)
- M = Manual input
- S = Simulator
- N = Data not valid

The positioning system Mode indicator field shall not be a null field.

## ROT – Rate of turn

\$--ROT,x.x,A\*hh<CR><LF>

```

| | |
| | +--- 3
| +----- 2
+----- 1

```

1. Rate of turn, deg/min, "-"=bow turns to port
2. Status: A=data valid, V=data invalid
3. Checksum

# 16. PROGRAM NUMBER

Pub No., Reason for Modification, Date	Software (Prog. No.)
OME-72360-S Modified to conform to IEC 61162-1 Edition 2  2005/8	DS-300 CP board 665-0100-209 DS-310 MCP board 665-0110-111 FT board 665-0120-100 KL board 665-0130-100 MIF board 665-1004-002 DS-320 CP board 665-0160-102

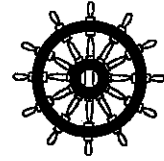
**Declaration of conformity****0560**We **FURUNO ELECTRIC CO., LTD.**

(Manufacturer)

9-52 Ashihara-Cho, Nishinomiya City, 662-8580, Hyogo, Japan

(Address)

hereby declare under our sole responsibility that the product

Marine Speed and Distance Measuring Equipment Type DS-30 Doppler Sonar consisting of Main Display DS-300, Operational Panel DS-301, Processor Unit DS-310, Transducer Unit DS-320, Transducer DS-330, and their optional equipment: Digital Indicator DS-350, Digital Indicator DS-351, Analog Indicator DS-382, Distribution Box DS-370, Junction Box DS-360 and Rate of Turn Gyro DS-340

(Model names, type numbers)

to which this declaration relates conforms to the following standard(s) or normative document(s)

StandardIMO Resolution MSC.36(63)  
IMO Resolutions A.824(19), MSC.96(72)  
IMO Resolution A.694(17)Test standardEN 61023 (IEC 61023: 1999-07)  
EN 60945: 2002 (IEC 60945 4th edition: 2002-08)  
IEC 61162-1: 2000-07

(title and/or number and date of issue of the standard(s) or other normative document(s))

For assessment, see

- Certificate of EC type-examination (Module B) N°: 02212008/AA/02 of 30 August 2005 issued by Telefication, The Netherlands
- Product Quality System (Module D) certificate No. P 112 of 20 May 2005 issued by Telefication, The Netherlands
- Certificate of type approval TT/44/92-1 of 17 August 1994 issued by MARINE SAFETY AGENCY, U.K.
- Certificate of type approval DERA-MED-07/00-01 of 3 March 2000 issued by the DERA Fraser, U.K.
- Report on type testing AWI/C-R/TT/44/92/2-1.0 of August 1994 issued by DERA Fraser
- Test report FLI 12-99-040 of November 15, 1999 prepared by Furuno Labotech International Co., Ltd. and authorized by KCS Certification, The Netherlands
- Test report FLI 12-05-035 of 28 July 2005 prepared by Furuno Labotech International Co., Ltd.

This declaration is issued according to the provisions of European Council Directive 96/98/EC on marine equipment modified by Commission Directive 2002/75/EC.

On behalf of Furuno Electric Co., Ltd.

Hiroaki Komatsu  
Manager,  
International Rules and RegulationsNishinomiya City, Japan  
September 20, 2005

(Place and date of issue)

(name and signature or equivalent marking of authorized person)

## Free Manuals Download Website

<http://myh66.com>

<http://usermanuals.us>

<http://www.somanuals.com>

<http://www.4manuals.cc>

<http://www.manual-lib.com>

<http://www.404manual.com>

<http://www.luxmanual.com>

<http://aubethermostatmanual.com>

Golf course search by state

<http://golfingnear.com>

Email search by domain

<http://emailbydomain.com>

Auto manuals search

<http://auto.somanuals.com>

TV manuals search

<http://tv.somanuals.com>