

FURUNO

OPERATOR'S MANUAL

LCD VIDEO SOUNDER

MODEL LS-6000



FURUNO ELECTRIC CO., LTD.
NISHINOMIYA, JAPAN

©FURUNO ELECTRIC CO., LTD.

9-52, Ashihara-cho,
Nishinomiya, Japan

Telephone: 0798-65-2111
Telefax: 0798-65-4200

All rights reserved. Printed in Japan

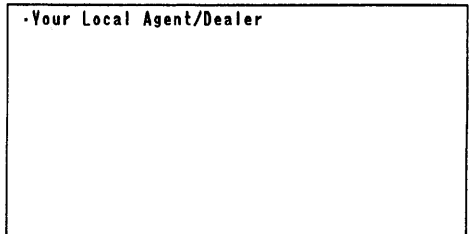

FIRST EDITION : DEC 1997

**PUB. No. OME-23500
LS-6000**



SAFETY INSTRUCTIONS

Safety Instructions for the Installer



WARNING



Do not work inside the equipment unless totally familiar with electrical circuits.

Hazardous voltage which can cause electrical shock, burn or serious injury exists inside the equipment.



Turn off the power at the mains switchboard before beginning the installation. Post a sign near the switch to indicate it should not be turned on while the equipment is being installed.

Fire, electrical shock or serious injury can result if the power is left on or is applied while the equipment is being installed.



CAUTION



Ground the equipment to prevent electrical shock and mutual interference.



Confirm that the power supply voltage is compatible with the voltage rating of the equipment.

Connection to the wrong power supply can cause fire or equipment damage. The voltage rating appears on the label at the rear of the display unit.

Use the correct fuse.

Use of a wrong fuse can cause fire or equipment damage.

Safety Instructions for the Operator

 WARNING	
	<p>Do not open the equipment.</p> <p>Hazardous voltage which can cause electrical shock, burn or serious injury exists inside the equipment. Only qualified personnel should work inside the equipment.</p>
<p>Do not disassemble or modify the equipment.</p> <p>Fire, electrical shock or serious injury can result.</p>	
<p>Turn off the power immediately if water leaks into the equipment or the equipment is emitting smoke or fire.</p> <p>Continued use of the equipment can cause fire or electrical shock.</p>	
<p>Keep heater away from equipment.</p> <p>Heat can alter equipment shape and melt the power cord, which can cause fire or electrical shock.</p>	

 CAUTION
<p>Use the proper fuse.</p> <p>Use of a wrong fuse can result in fire or permanent equipment damage.</p>

TABLE OF CONTENTS

FOREWORD	1
Features	1
1. HANDLING PRECAUTIONS	3
2. PRINCIPLE OF OPERATION	4
3. TRANSMISSION FREQUENCY AND DETECTING AREA	6
4. WHAT APPEARS ON THE DISPLAY	8
4-1. Normal Mode Display	8
4-2. Other Displays	9
5. OPERATION	10
5-1. Front Panel Controls	10
5-2. Operation	11
Power ON/OFF	11
Brilliance control	11
TONE control	12
Using the AUTO function	12
Display mode selection	13
Display advance speed selection	17
Eliminating interference	17
The alarm function	17
Manual gain control (AUTO: OFF)	19
Display Range Selection	19
Shifting the VRM	20
6. MENU SETTING	21
6-1. Operating Procedure	21

6-2. Description of Menus	22
Menu 1	22
Menu 2	23
7. TROUBLESHOOTING	25
Cannot turn on the power.	25
Bottom and fish schools are not clearly displayed.	25
Nothing appears on the display.	27
Echoes suddenly disappear.	28
The bottom is displayed intermittently when the AUTO function is ON.	28
No echo appears	28
8. INSTALLATION	29
8-1. Installing the Transducer	29
Installation location	29
Inside-hull mount	32
Through-hull mount	33
Transom Mount	34
8-2. Mounting the Display Unit	35
8-3. Wiring	36
Wiring diagram	36
9. UNIT INITIALIZATION	38
10. SPECIFICATIONS	39
11. EQUIPMENT LIST	41
12. EXPLODED VIEW	42
13. APPENDIX	43

FOREWORD

Congratulations on your choice of the FURUNO LS-6000 LCD Video Sounder. We are confident that you will enjoy many years of operation with this fine piece of equipment.

For over 40 years FURUNO Electric Company has enjoyed an enviable reputation for quality and reliability throughout the world. This dedication to excellence is furthered by our extensive global network of agents and dealers.

The LS-6000 is just one of the many FURUNO developments in the field of echo sounding. The compact, lightweight but rugged unit is easy to operate and is suitable for both fresh and salt water applications.

This unit is designed and constructed to give the user many years of trouble-free operation. However, to obtain optimum performance from this unit, you should carefully read and follow the recommended procedures for installation, operation and maintenance. No machine can perform to the utmost of its ability unless it is installed and maintained properly.

We would appreciate feedback from you, the end-user, about whether we are achieving our purposes.

Thank you for considering and purchasing FURUNO equipment.

Features

- High-resolution LCD is visible even in direct sunlight.
- The display shows echoes in three tones according to strength.
- The White Line function distinguishes bottom fish echoes from seabed echoes.
- The Zoom function expands the area selected by 2 (or 4) times its size and displays it on the left half of the screen.

- The Bottom-Lock function gives detailed information of bottom fish.
- The Battery alarm sounds if the battery voltage drops below 10.5 V or exceeds 16.5V.
- Navigation data, such as own ship's position, range and bearing to destination, ship's speed or course, can be displayed by connecting a navigation aid which outputs navigation data in NMEA0183 format.
- Auto function provides fully automatic adjustment of gain and range scale.

1. HANDLING PRECAUTIONS

Use 12 Vdc power only

Supply voltage should be within the range of 10 to 16 Vdc. If the supply voltage drops below 10.5V, an alarm will sound and "SUPPLY VOLTAGE TOO LOW: CHECK BATTERY." appears on the display. Charge the battery when the indication appears. The alarm can be stopped by pressing any key. Further, "SUPPLY VOLTAGE TOO HIGH. TURN POWER OFF." appears and the alarm sounds if the voltage exceeds 16.5V. Lower the supply voltage.

Handle cables carefully

Handle the transducer and power cables with great care to prevent breakage. Further, do not extend them unnecessarily. When disconnecting the plug, never pull the cable itself. Hold the plug and then pull it.

Handle equipment carefully

Take care not to drop the equipment or allow it to receive strong shocks.

Never use the equipment in extremely hot areas

If the equipment's temperature exceeds 70°C (158°F) malfunction may result. Keep the unit out of direct sunlight or at least shaded to prevent heat which can build up inside the cabinet. It should never be stored in a car trunk.

Never clean the unit with chemical solvents

Since the main body and panel are made of plastic, do not clean them with chemical solvents such as thinner or alcohol. If the equipment is extremely dirty, dampen a soft cloth with water or neutral detergent, wring the cloth thoroughly, then wipe the equipment.

Never disassemble the equipment yourself

Only service personnel are allowed to disassemble and repair the equipment. FURUNO will not accept responsibility for any problems caused by unauthorized disassembly or repair.

2. PRINCIPLE OF OPERATION

The LS-6000 LCD Video Sounder determines the distance between its transducer and underwater objects such as fish, lake bottom or seabed and displays the results on a 6" LCD (Liquid Crystal Display). It does this by utilizing the fact that an ultrasonic wave transmitted through water travels at a nearly constant speed of 1500m (4800 feet) per second. When a sound wave strikes an underwater object such as fish or sea bottom, part of the sound wave is reflected back toward the source. Thus by calculating the time difference between the transmission of a sound wave and the reception of the reflected sound wave, the depth to the object can be determined. In a sense an echo sounder can be thought of as being an extremely sophisticated and quick timer, since it is capable of resolving time differences shorter than one thousandth of a second.

The entire process begins in the display unit. Transmitter power is sent to the transducer as a short pulse of electrical energy. The electrical signal produced by the transmitter is converted into an ultrasonic pulse by the transducer and transmitted into the water. Any reflected signals from intervening objects (such as a fish school) are received by the transducer and converted back into an electrical signal. It is then amplified in the amplifier section, and finally, displayed on the screen.

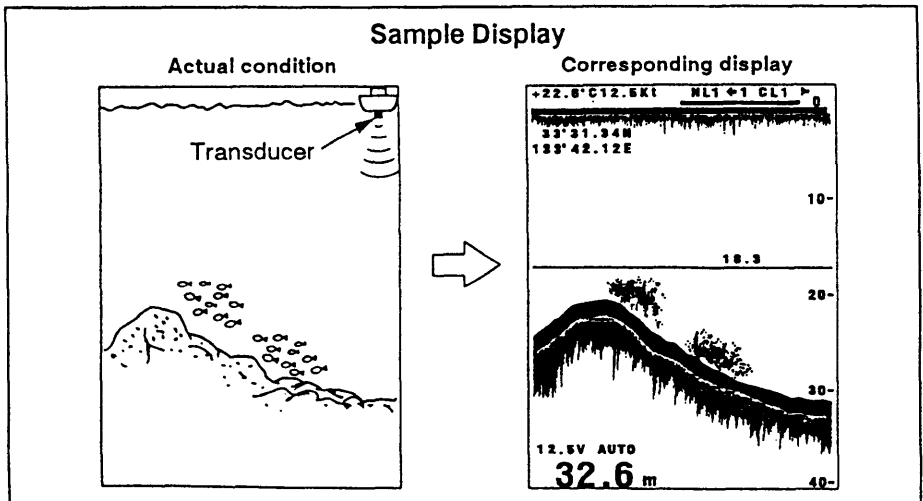

The picture displayed by the LS-6000 is made up of a series of vertical scan lines, one for each transmission. Each line represents a "snapshot" of what has occurred beneath the boat. The series of snapshots are accumulated side by side across the screen, and the resulting contours of the bottom and fish between the bottom and surface are displayed. The amount of history of objects that have passed beneath the boat over a series of transmission varies from less than a minute to a few minutes, depending on how you adjust the unit.

3. TRANSMISSION FREQUENCY AND DETECTING AREA

As discussed in the previous chapter, both fish echoes and bottom contour echoes are composed of a series of vertical scan lines moving right to left across the screen. It is possible for the same object to be recorded on the display in a variety of shapes depending on the distance to the object, the angle at which the fish is struck by the transmitted pulse, echo strength, etc.

The sounding area varies depending on the main beamwidth of the transducer, as shown below. Objects out of the main beam but close to the beam will be presented less densely, smaller in size, and at a lower intensity.

With the LS-6000, the operator has the choice of either the 50kHz or 200kHz unit. There are advantages and disadvantages to both frequencies and you should select the frequency best suited to your needs.

Generally, beamwidth depends on transmission frequency; a narrower beamwidth is usually obtained at the higher frequency. For example, the 200kHz transducer has a "-3dB" beamwidth of approximately 10 degrees, whereas the 50kHz transducer has a beamwidth of approximately 46 degrees.

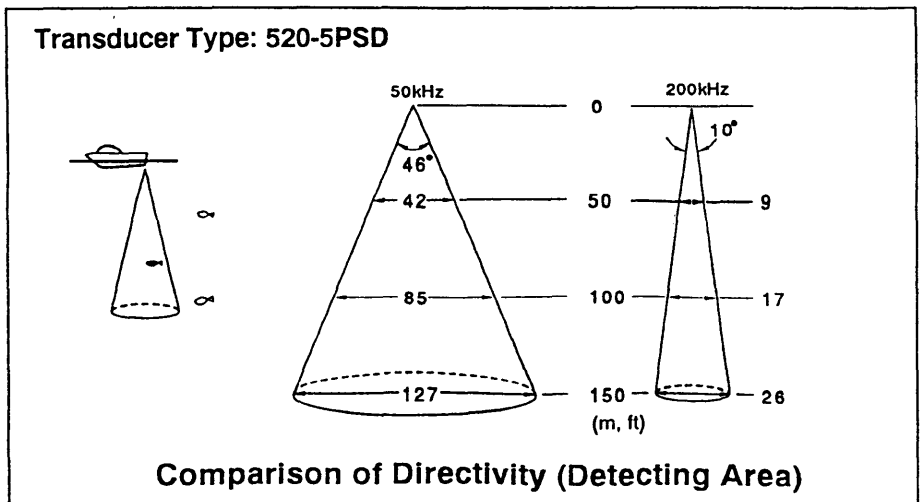

Because the beamwidth of the 200kHz transducer is narrow, the operator has the advantage of higher resolution. In addition, the effects of cruising noise and air bubbles are greatly reduced, since air bubbles resonate at a frequency between 15 and 100kHz. On the minus side, a narrow beamwidth transducer will display even the smoothest bottom contour in a sawtooth pattern if the boat is pitching and rolling. This makes discrimination of fish close to the bottom difficult. Also, because of the limited coverage area, a narrow beamwidth tends to overlook catchable fish at the sides of the boat. The maximum percent of depth covered on the bottom for the 200kHz transducer is 17% of the depth. For example, if the bottom depth is 150 meters (492ft), the diameter of the coverage circle on the bottom would be only 26 meters (83ft).

4. WHAT APPEARS ON THE DISPLAY

4-1. Normal Mode Display

Signal intensity and display tone

Fish school and seabed echoes are displayed in three tones (dark, medium and light) according to their intensities.

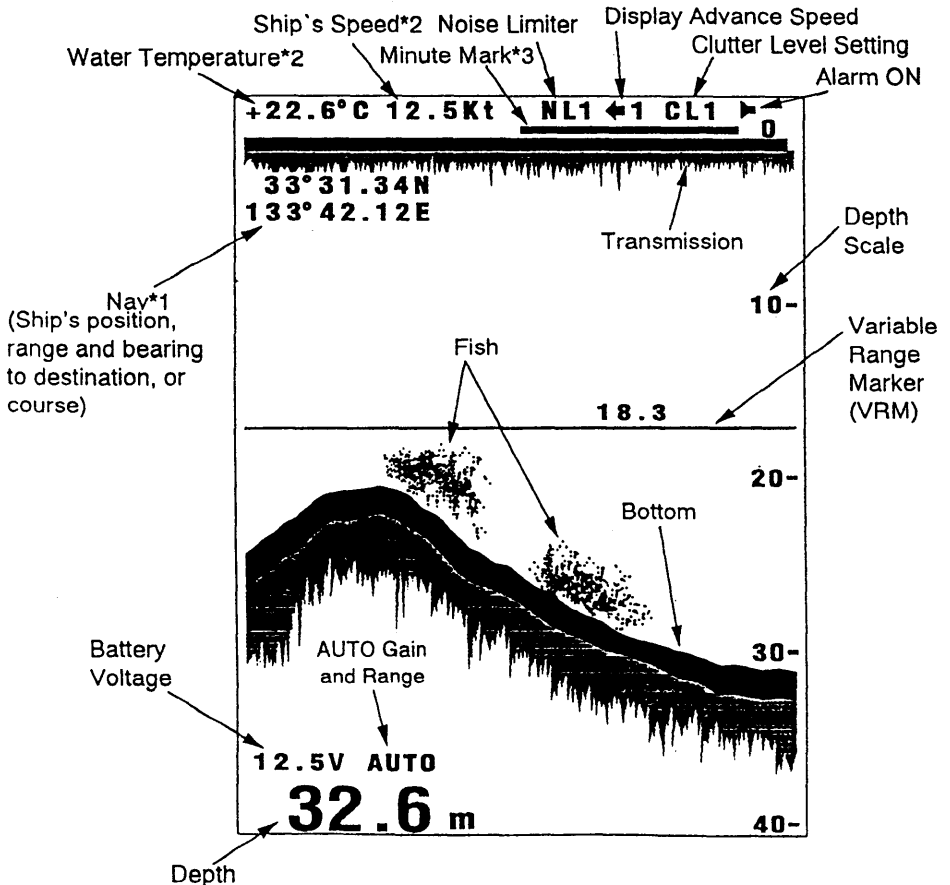

- *1: Requires connection of position-fixing equipment.
- *2: Requires connection of speed/temperature sensor.
- *3: One minute is shown by a 30 second horizontal bar and 30 second space.

4-2. Other Displays

A-SCP display

- The A-Scope display shows echoes with amplitudes and tones proportional to their intensities on the right 1/4 of the screen.

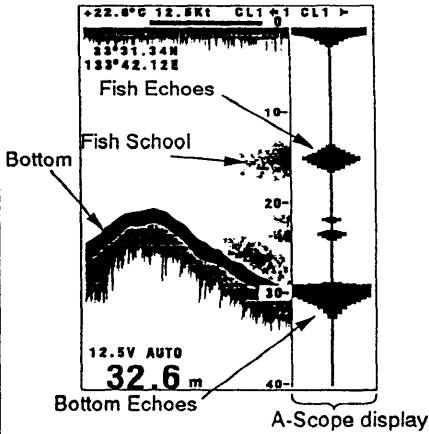

B-LCK display

- The BOTTOM-LOCK expansion display provides 5m (or 10m) wide layer in contact with seabed on the bottom 1/3 of the screen.

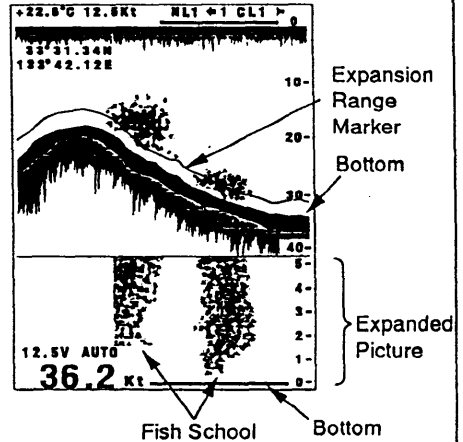

NAV display

- The NAV display shows navigation data.

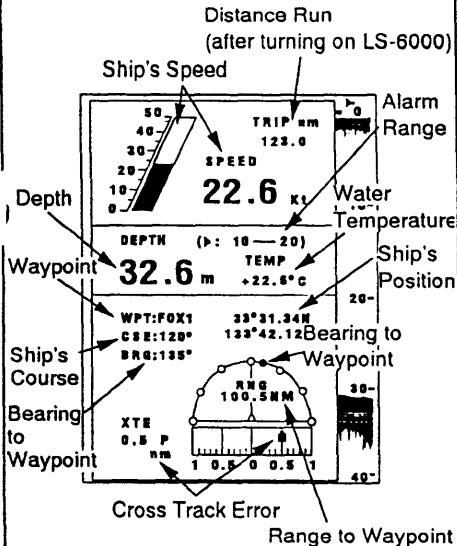

ZOOM display

- The ZOOM expansion display expands the area between the VRM and the Zoom Range Marker on the left half of the screen.

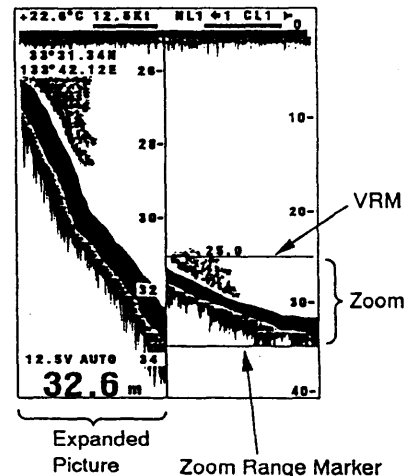

5. OPERATION

5-1. Front Panel Controls

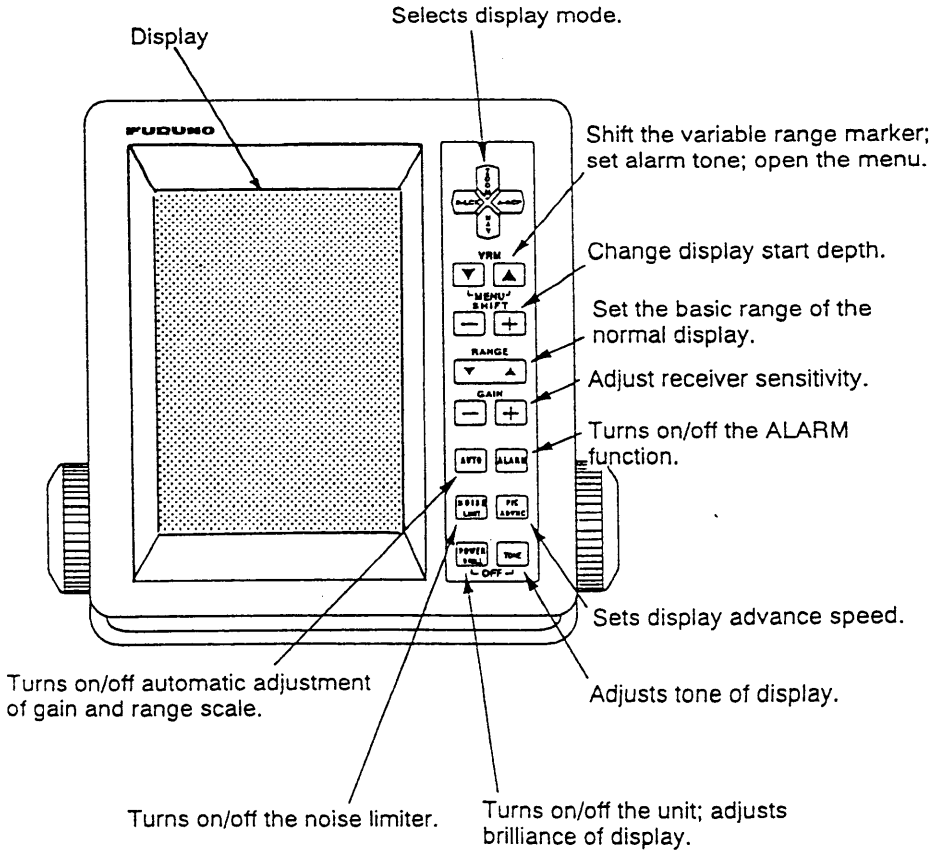

5-2. Operation

Power ON/OFF



Press the POWER/BRILL key to turn the power ON. The POWER/BRILL and TONE keys pressed together turn the power OFF.

NOTE:

Do not start the boat's engine when the unit is on. The voltage may drop below 10.5V, causing the unit not to work properly.

Demonstration Display



Your unit has a demonstration display which helps you acquaint yourself with the function of the unit, without connection of the transducer. Most functions can be controlled from the front panel.

To show the demonstration display, turn on the power while pressing and holding down any key except the TONE key. Turn off the power to escape.

Brilliance control

Adjust the POWER/BRILL key to set the brilliance of the display. Six levels are available.

TONE control

**POWER
BRILL**

TONE

Adjust the TONE key to set the contrast of the display. 10 levels are available.

NOTE:

Like any LCD, the LS-6000 has limitations on the amount of heat or cold it will tolerate without losing some of its excellent performance. At extremes of hot or cold, the display will darken or lighten when operating the unit. Adjust the TONE control to compensate for this event.

Using the AUTO function

AUTO

The AUTO function provides automatic selection of the gain and the range scale.

Press the AUTO key to turn the AUTO function ON/OFF. AUTO appears at the bottom left-hand corner of the screen when the AUTO function is ON.

AUTO range ····

Range changes automatically to locate the bottom on the lower half of the screen.

AUTO gain ····

The gain is automatically adjusted to display the bottom echo in dark tone.

NOTE:

The GAIN, SHIFT and RANGE controls are inoperative when the AUTO function is on.

Display mode selection



Display Mode Selection Keys

You may select one of five display modes by the display mode selection keys: NORMAL, ZOOM, B-LCK, A-SCP or NAV.

NORMAL display

This is the basic presentation mode for observing fish schools and seabed. To display this mode, press the last-pressed display mode selection key.

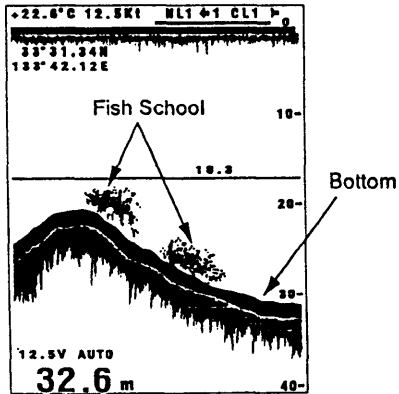

A-SCOPE display

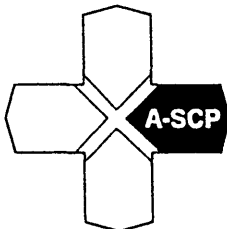

The A-SCOPE display shows echoes by amplitudes and tones proportional to their intensities on the right 1/4 of the display. Press the A-SCOPE key to turn the A-SCOPE display on/off.

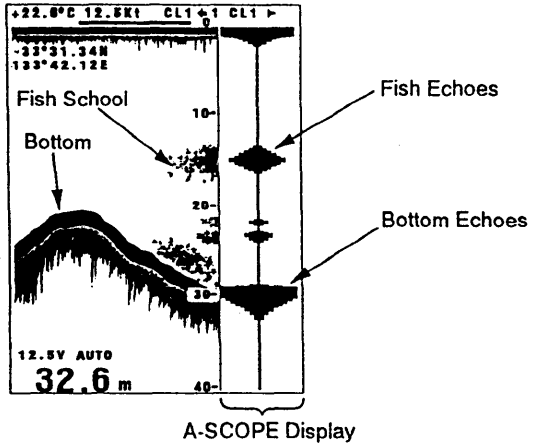

BOTTOM-LOCK display

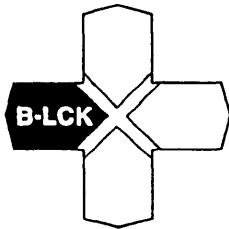

The BOTTOM-LOCK expansion display provides a compressed normal display on the upper 2/3 of the screen and a 5 meter wide layer in contact with the seabed onto the rest of the screen with the seabed contour displayed by a straight line at the bottom of the screen. Note that the width of the layer in contact with the seabed may be changed to 10 meter, on the menu. More on this in a later chapter.

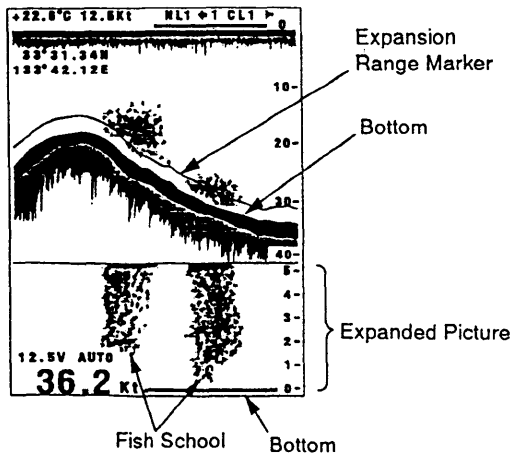

Press the B-LCK key to turn the BOTTOM-LOCK display on/off.

NAV display

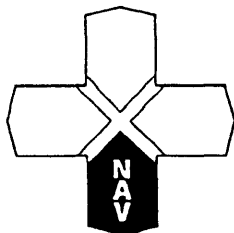

When the equipment is connected to a navigation unit which outputs navigation-data in NMEA0183 formats or a water temperature sensor, navigation data such as ship's position, range and bearing to waypoint, ship's speed and course, and water temperature can be displayed on the screen.

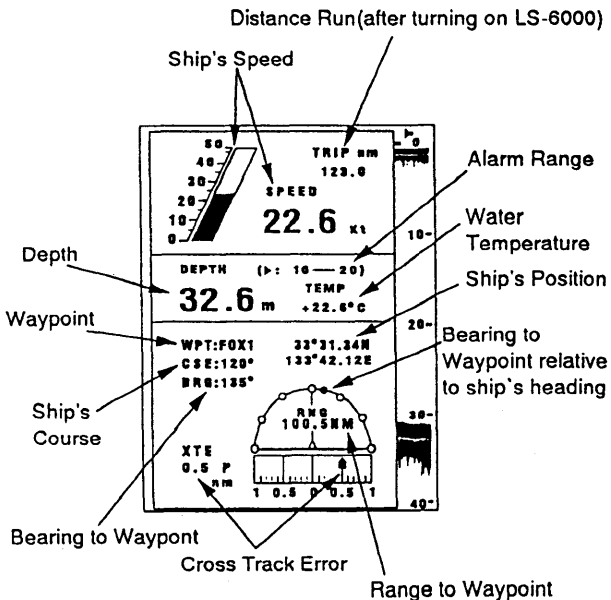

Press the NAV key to turn the NAV display on/off.

ZOOM display

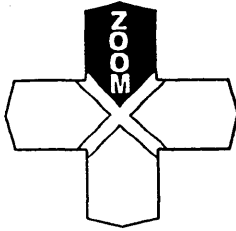

This mode expands any location on the normal display to full vertical size of the screen on the left half of the screen.

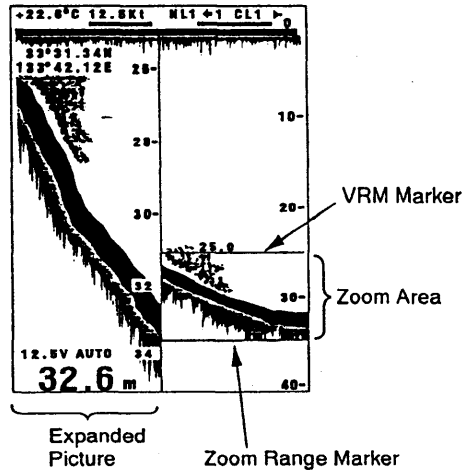

Press the ZOOM key to turn the ZOOM display on/off. You may specify the portion to be expanded by using the VRM \blacktriangledown or \blacktriangle key. The segment between the VRM and the Zoom Range Markers are expanded. The length of the segment is equal to one division of the depth scale.

Zoom expansion rate can be set to either two or four on the menu. More on this in a later chapter.

Display advance speed selection



Advance speed of the display may be adjusted with the PIC ADVNC key, in 5 steps. Setting "0" stops advancement of the picture. The current speed appears at the top of display to the right of the arrow mark.

Eliminating interference



When interference from other echo sounders operating nearby or other types of electrical interference appears on the screen, you may use the noise limiter to eliminate or reduce it.

Press the NOISE LIMIT key to select level of noise rejection desired.

OFF Noise rejection is OFF.

NL1 Low degree of noise rejection

NL2 High degree of noise rejection.

Turn off the noise limiter when no interference exists, otherwise small fish echoes may also be eliminated. The current setting (NL1 or NL2) appears at the top of the display.

The alarm function



The alarm function alerts you to either the presence of fish echoes or seabed in a specified alarm zone. You may select either the fish alarm or bottom alarm on the menu. When the alarm is active, ► mark appears at the top of the screen. The alarm does not sound on seabed or fish school within 1 meter from the transducer. This is done to prevent strong sea reflections from triggering the alarm.

Setting the alarm zone

The alarm zone range is interlocked with the range scale and is as shown in the table below.

Range		1	2	3	4	5	6	7
Zone	Meter	0.5	1	2	4	8	16	32
	Fathom	0.25	0.5	1	2	4	8	16
	Feet	2	4	8	16	32	64	128

1. Press the ALARM key. The alarm message appears for three seconds on the center of the screen.
2. While the alarm message is displayed, move the alarm zone marker to the desired depth by operating the VRM key.

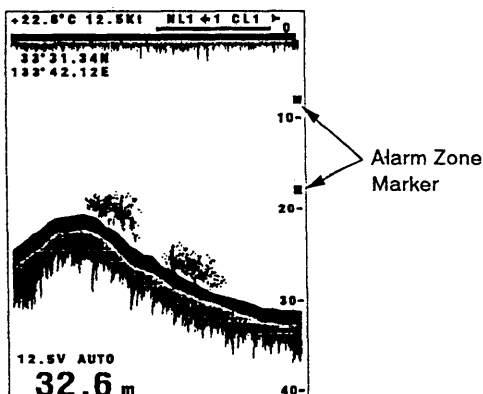

NOTE:

The alarm is given to dark and medium tone echoes for fish alarm and only to dark tone echoes for bottom alarm.

Manual gain control (AUTO:OFF)



The gain control adjusts the sensitivity of the receiver. Normally, set it where excessive noise just disappears.

The gain may be adjusted by the GAIN [+] or [-] key, in 10 steps. Note that the GAIN control is inoperative when the AUTO function is ON.

Display Range Selection

The RANGE and SHIFT keys together let you select the depth you can see on the display. The basic range can be regarded as a "window" set into the water column, which you shift up and down by pressing the SHIFT key.

For instance, suppose the display range is set to "5". In this case, the window is set to 40m. If you shift the window by 10 meter, for example, the display start depth is 10m and the display end depth is 50m (40m +10m).

Basic range selection (AUTO:OFF)



The basic range is selected by the RANGE key from the seven ranges shown in the following table.

Range	1	2	3	4	5	6	7
Meter	0-2.5	0-5	0-10	0-20	0-40	0-80	0-160
Fathom	0-1	0-2.5	0-5	0-10	0-20	0-40	0-80
Feet	0-10	0-20	0-40	0-80	0-160	0-320	0-640

Note that the RANGE key is inoperative when the AUTO function is ON.

Shift range selection (AUTO:OFF)



Range		1	2	3	4	5	6	7
m	Shifting Step	1	2	2.5	5	10	20	40
	Maximum	160	160	160	160	160	160	160
	Display Range	162.5	165	170	180	200	240	320
Fathom	Shifting Step	1	2	2.5	5	10	20	40
	Maximum	80	80	80	80	80	80	80
	Display Range	81	82.5	85	90	100	120	160
Feet	Shifting Step	2.5	5	10	20	40	80	160
	Maximum	640	640	640	640	640	640	640
	Display Range	650	660	680	720	800	960	1280

The basic range selected may be shifted up or down by the SHIFT keys. The amount of shifting appears at the top of the display.

Note that the SHIFT key is inoperative when the AUTO function is ON.

Shifting the VRM



The VRM functions to measure the depth to an object. You can shift it by the VRM key.

6. MENU SETTING

6-1. Operating Procedure

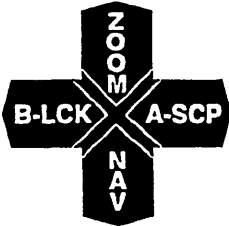

Display Mode Selection Keys



1. Press the VRM ▼ and ▲ keys together to turn on the menu display.

2. Press the display mode selection keys to select menu desired.

ZOOM, NAV: Cursor shifts up, down
 B-LCK, A-SCP: Cursor shifts left, right

3. Press the display mode selection keys to select both menu item and option.

To return to the normal display, press any key except the display mode selection keys.

Menu 1

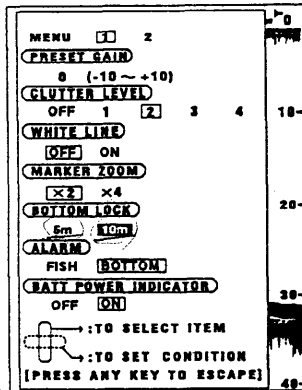

Menu 2

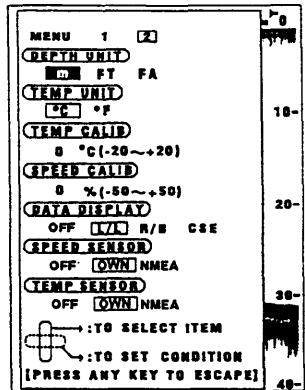

6-2. Description of Menu

Menu 1

PRESET GAIN

This presets the gain level. If the sensitivity is low or the AUTO function does not work properly, lower the value of preset gain.

Note that the sensitivity is in inverse proportion to the value of preset gain.

CLUTTER LEVEL

Dark dots may appear on a large part of the screen, hiding fish echoes. These dots are mainly due to dirty water. You can eliminate or suppress them by adjusting the clutter reduction level. Set the level to OFF when there is no clutter on the display, otherwise weak echoes may be eliminated.

WHITE LINE

There are occasions when fish echoes and seabed echoes are nearly equal in strength. When this occurs and the fish school is near the seabed, the fish school echo will merge with the seabed echo and become lost. You can distinguish the fish school from the seabed by turning on the white line function. When turned on, the seabed intensity is lower than fish echoes near the seabed.

WHITE LINE: OFF

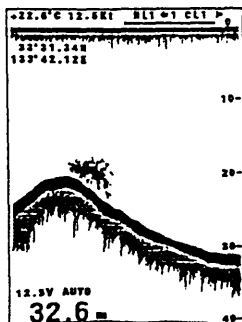

WHITE LINE: ON

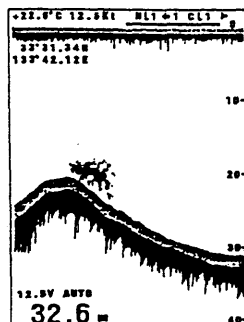

MARKER ZOOM	Set zoom expansion rate to 2 or 4 in the ZOOM display.
BOTTOM LOCK	Select expansion range (5m or 10m) in the BOTTOM-LOCK display.
ALARM	Select either the fish alarm or the bottom alarm.
BATT POWER INDICATOR	Turn on/off the battery voltage indication.

Menu 2

DEPTH UNIT	Set unit of depth measurement to meters, feet or fathoms.
TEMP UNIT	Set unit of water temperature measurement to Celsius or Fahrenheit.
TEMP CALIB	Correct the water temperature measured by the speed/temperature sensor up to $\pm 20.0^{\circ}\text{C}$ or $\pm 20.0^{\circ}\text{F}$ in 0.1°C or 0.1°F steps.
SPEED CALIB	Correct ship's speed measured by the speed/temperature sensor up to $\pm 50\%$.
DATA DISPLAY	Select navigation data to display. This function requires navigation data input in NMEA0183 format. OFF : No data is displayed. L/L : Ship's position (longitude and latitude) R/B : Range and bearing to destination CSE : Ship's course

SPEED SENSOR

Select the source of ship's speed data.

OFF : No data is displayed.

OWN : Ship's speed measured by the speed sensor connected to the equipment.

NMEA : Ship's speed over ground fed by the navigation unit (NMEA0183)

NOTE:

"0.0" kt appears when;

- *OWN is selected and there is no speed sensor connection.*
- *No NMEA0183 signal output, or*
- *No speed data.*

TEMP SENSOR

Select source of water temperature data.

OFF : No data is displayed.

OWN : Water temperature measured by the temperature sensor connected to the equipment.

NMEA : Water temperature fed by the navigation unit (NMEA0183)

NOTE:

No temperature data is displayed when;

- *OWN is selected and there is no temperature sensor connection.*
- *No NMEA0183 signal*
- *No temperature data.*

7. TROUBLESHOOTING

If something appears wrong with your unit, check the equipment referring to the troubleshooting guide which follows. If you cannot restore normal operation, do not attempt to check inside the unit. Any repair work is best left to a qualified technician.

Cannot turn on the power.

1. Is the power cable securely connected to the unit?

Check the power cable for tight connection.

2. Is supply voltage normal?

Recharge battery.

3. Is power cable connected correctly (white wire to +, black wire to -)?

Check for reversed connection of ship's mains.

4. Corrosion on battery terminal?

Check battery terminals for corrosion. Clean if necessary. If heavily corroded, replace power cable.

5. Is the power cable damaged?

Replace cable if damaged.

Bottom and fish schools are not clearly displayed.

1. Low sensitivity.

Adjust sensitivity with the GAIN key, or turn the AUTO function ON.

2. Is the display range too shallow?

Adjust the display range with the RANGE key, or turn the AUTO function ON.

3. Are there air bubbles on the transducer surface?

Clean surface of the transducer with a soft cloth while the transducer is under the water. (If the unit is brand new, air bubbles tend to adhere to the unit.)

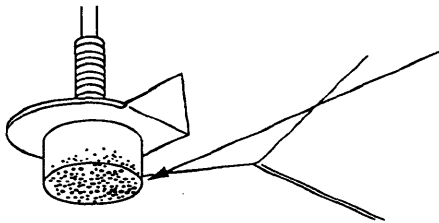

Air bubbles on the transducer surface.
Clean surface of the transducer with a soft cloth while the transducer is under the water.

4. Marine life attached to the transducer surface?

Clean the transducer surface carefully, not to give it strong mechanical shock.



Weeds, oysters, barnacles, etc.

5. What is the current bottom feature/water condition?

Muddy or seaweed-covered bottoms and dirty or air-bubble filled water can prevent clear display of the bottom echo.

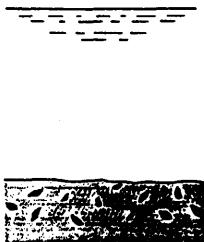

Muddy Bottom

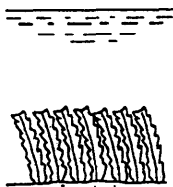

Seaweeds

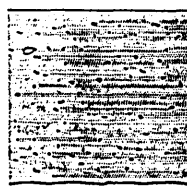

Dirty Water



White Water
(air bubbles in water)

Nothing appears on the display.

1. Check the transducer.

There may be corrosion on the transducer plug or something wrong with the transducer. Do the following procedure to check the transducer.

TRANSDUCER CHECK

Transmitter

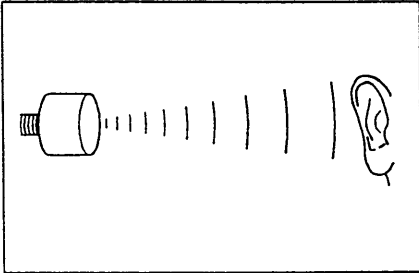

Haul the transducer from the water and turn the power ON. Put your ear about 1m distance from the transducer surface and carefully listen for the transmission sound. If you can hear a clicking sound, the transducer is O.K. (You can not hear sound if the unit is in demonstration mode.)

※ In case of neither sound nor noise, the transducer is likely to be faulty.

Receiver

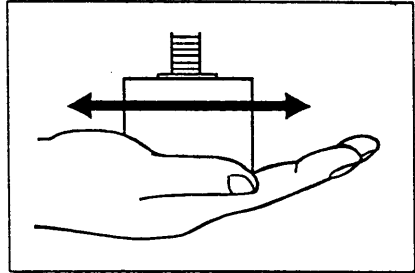

Rub the transducer surface with your hand and observe whether any noise appears on the screen. The appearance of noise indicates that the transducer is normal.

2. Is the transducer completely under the water?

Confirm that the transducer is under the water.

3. For inside-hull mount with a tank, is there sufficient castor oil inside the transducer tank?

Have a technician check the level.

Echoes suddenly disappear.

1. Is the transducer completely under the water?

Install the transducer so that it is always under the water.

2. For transom mount, is the transducer location suitable?

This type of mounting attracts air bubbles. When speed is increased, air bubbles collect near the transducer, blocking the ultrasonic wave path. If the condition persists, try changing the mounting location.

3. Air bubbles produced by own boat's screw or other boat's screw may be near transducer.

Move your boat or wait until air bubbles disappear.

The bottom is displayed intermittently when the AUTO function is ON.

Is the sea rough?

If the sea is rough, display range may vary frequently. Turn off the AUTO function, and set the display range by manual operation.

No echo appears.

Is the display advance speed set to other than "0"?

Change the display advance speed with the PIC ADVNC key.

8. INSTALLATION

8-1. Installing the Transducer

The LS-6000 is available with either an inside-hull/through-hull mount or transom mount transducer.

Installation location

Installation location should be chosen carefully since the transducer's performance is directly affected by the transducer location. This is especially true on high speed boats. Determine mounting location considering ship's construction and the guidelines, which follow.

- 1) Bubbles and turbulence caused by the ship's movement interfere with the propagation of ultrasonic waves, drastically hindering the sounding ability of the transducer. Therefore, the transducer should be installed in a place where such interference is minimum. In addition, lifting strakes and noise caused by the screw affect performance. Locate the transducer away from the screw and inward of the first lifting strakes.
- 2) The transducer must always remain submerged, even when the boat is pitching, rolling, or up on a plane at high speed. Be sure the transducer location affords this condition.

- 3) For displacement hulls, using inside-hull or through-hull mount, install the transducer at a point between $1/3$ to $1/2$ of the full length from the stern. For planing hulls, install it in an area where it is always positioned underwater (that is near the stern), regardless of the planing attitude of the boat.

Installation Location of Transducer

Straight V-shaped hull boat)

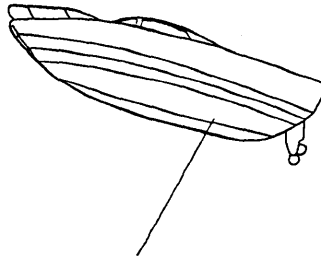

- * $1/2$ to $1/3$ of the full length from the stern.
- * 15 to 30cm from the center line.
(inward of the first lifting strakes)

High-speed V-shaped hull boat



- * Place where the transducer is always positioned underwater.
- * Dead rise angle within 15 degrees.

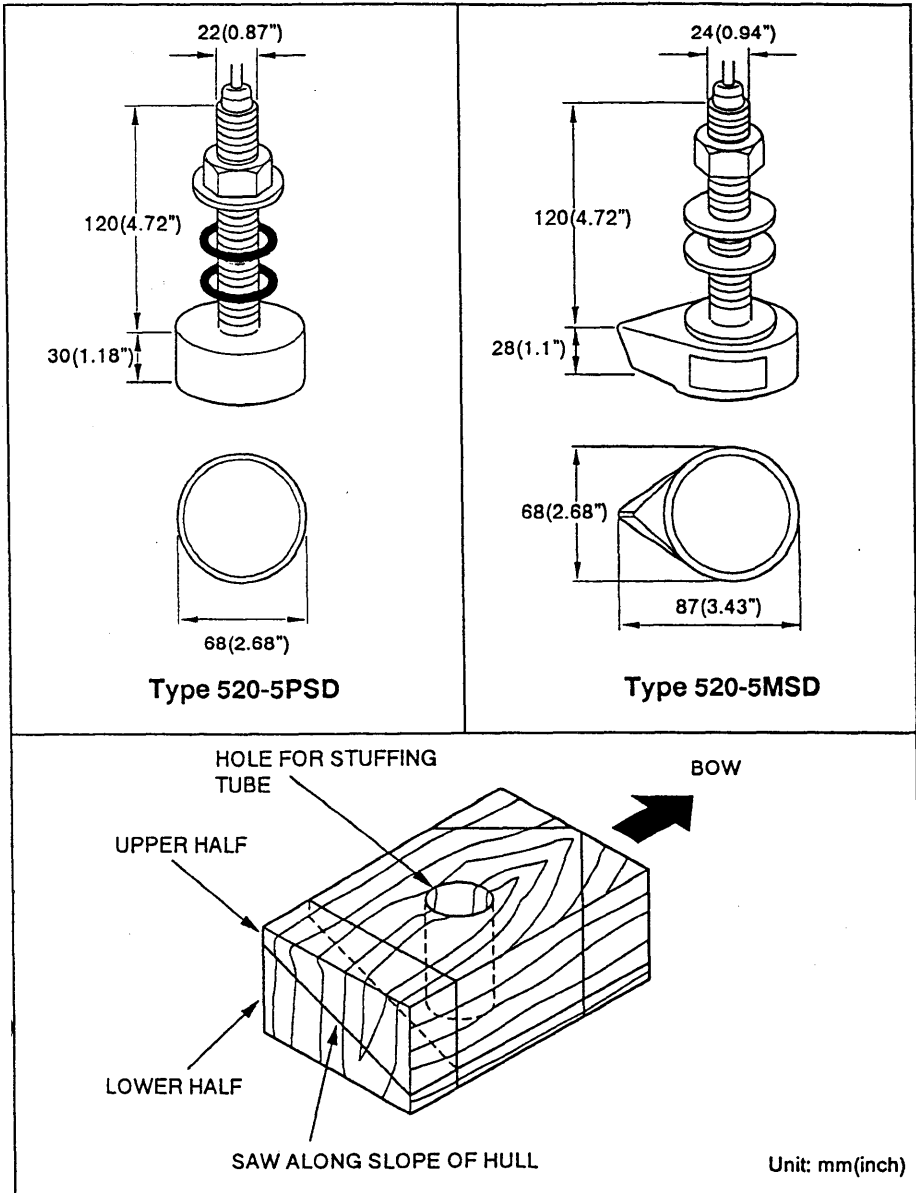

External Dimensions of Transducer and Construction of Fairing Block

Inside-hull mount

This type of mounting is sometimes effective on fiberglass boats. However, since the ultrasonic wave will be attenuated through the hull, this method may not be suitable for deep water sounding.

The following points should be kept in mind when selecting a mounting location, in addition to the above-mentioned point.

- The transducer should be installed in a place where the hull of the ship is single-layered. If the hull board contains bubbles or other foreign materials, sounding ability drops drastically.
- Avoid areas where hull struts or ribs are running.
- Avoid areas where the hull inclines more than 15 degrees.

For best results you should install the display unit first, then carry out a trial test to determine the best location for the transducer.

Turn on the unit. Run the boat at various speeds and move the transducer to various locations to select location where you get the best picture. Once you find a good location, permanently mount the transducer.

Installation procedure

1. Lightly roughen the surface of the transducer with #100 sandpaper. Wipe the surface with thinner or alcohol to remove grease. Do the same to the surface of the hull where the transducer is to be installed.
2. Allow the surfaces to dry. Coat them with adhesive (option). In cold environment, warm the adhesive to about 40°C before usage to soften it.

3. Push the transducer firmly against the hull, and move it back and forth to remove bubbles contained in the adhesive. Allow enough time for the adhesive to dry.

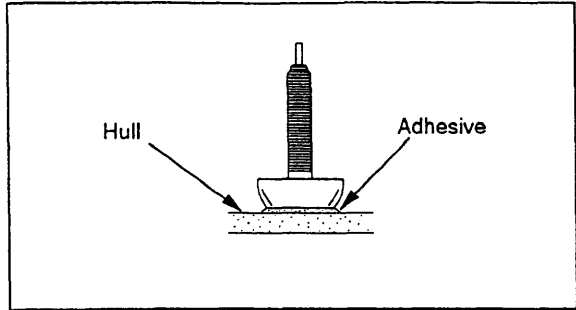

Through-hull mount

Since the transducer projects from the hull, influences of air bubbles and turbulence generated along the hull of the ship are greatly reduced, providing excellent sounding performance. For installation location of the transducer, refer to page 29. If the ship has a keel make, sure that the transducer is at least 30cm away from the keel line.

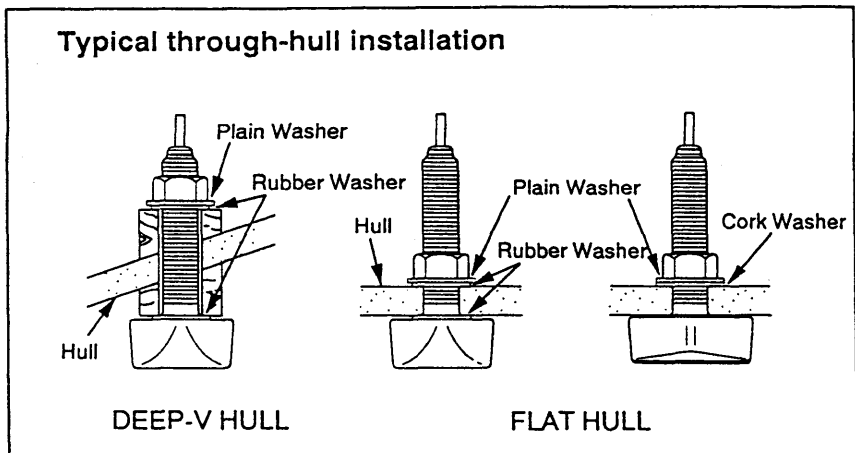

Installation procedure

1. Haul the boat out of the water. Mark the transducer location on the hull.
2. In the case of a straight V-shaped hull ship (inclining at more than 15 degrees), use a (teak) fairing block in order to position the transducer in parallel with the waterline. The surface of the fairing block should be as smooth as possible. It is preferable for the fairing block to be smaller than the transducer, as this reduces water turbulence generated near the side of the boat.
3. Drill a hole just large enough to pass the threaded stuffing tube of the transducer through the hull, making sure it is drilled vertically.
4. Apply a sufficient amount of high quality caulking compound to the top surface of the transducer, around the threads of the stuffing tube and inside the mounting hole (and fairing blocks if used) to ensure watertight mounting.
5. Mount the transducer and fairing blocks and tighten the locking nuts. Be sure that the transducer is properly oriented and its working face is parallel to the waterline. Do not over-stress the stuffing tube and locking nuts through excessive tightening since the wood block will swell when the boat is in the water. It is suggested that the nut be tightened lightly at installation and retightened several days after the boat has been launched.

Transom Mount

See the installation instructions on the page 43.

8-2. Mounting the Display Unit

The display unit can be installed on a tabletop or on the overhead.

Fix the hanger to the mounting location with four M6 tapping screws. Set the display unit to the hanger and tighten the knob bolts.

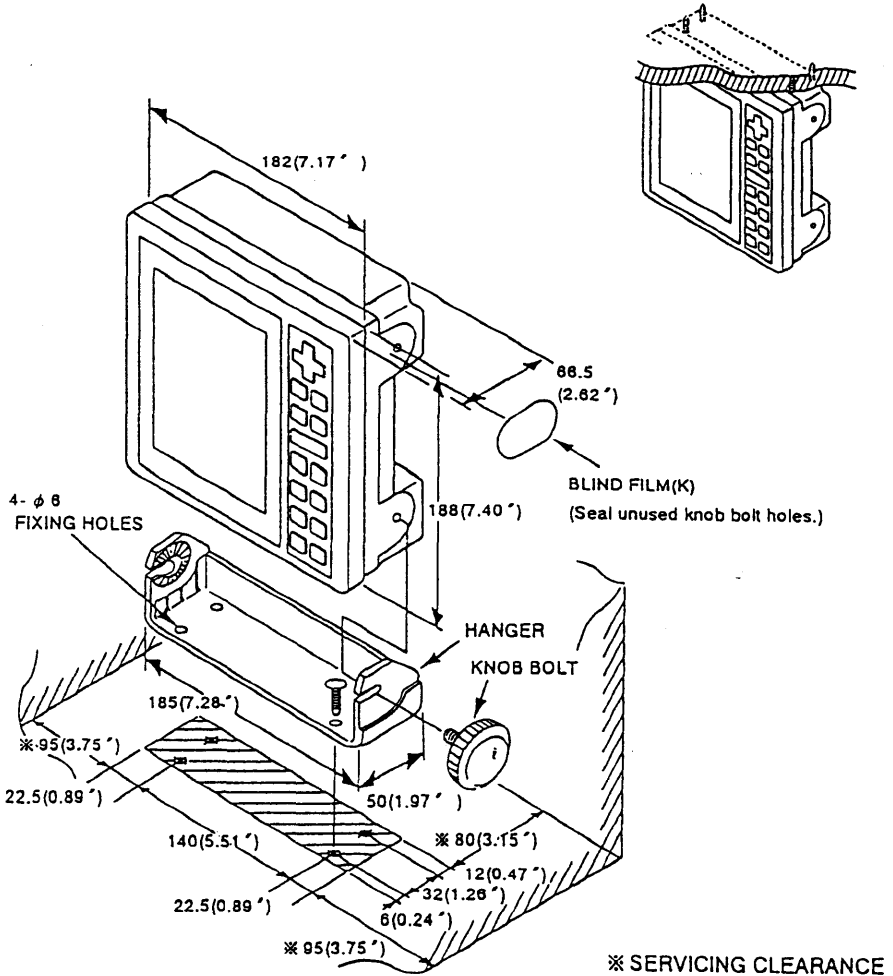

Unit: mm (inch)

8-3. Wiring

Wiring diagram

As shown in the figure below, connect the transducer cable, the power cable and the ground wire to the rear panel of the display unit. The ground wire should be as short as possible and fastened to a grounding boss.

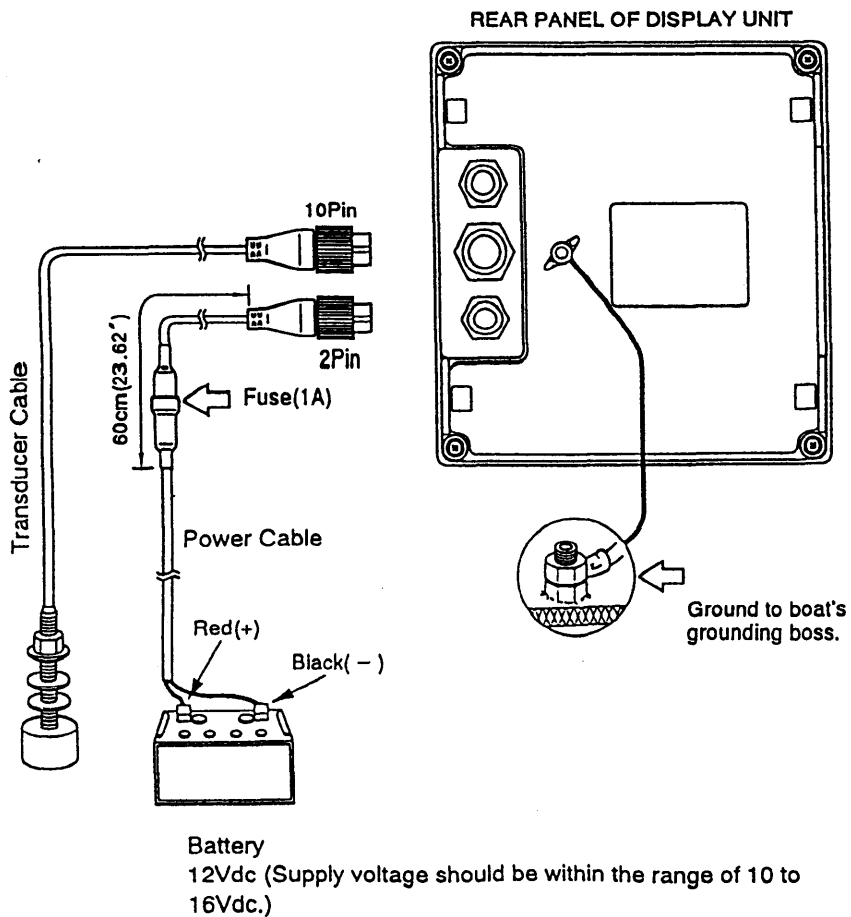

Connect the navigation unit which is to feed navigation data (in NMEA0183 format) to the LS-6000. You will need an NMEA Cable (22S0021, 5m) and a connector.

Connect the navigation unit to the equipment using the NMEA cable as shown below. Attach a connector to the other end of the cable and connect it to the navigation unit.

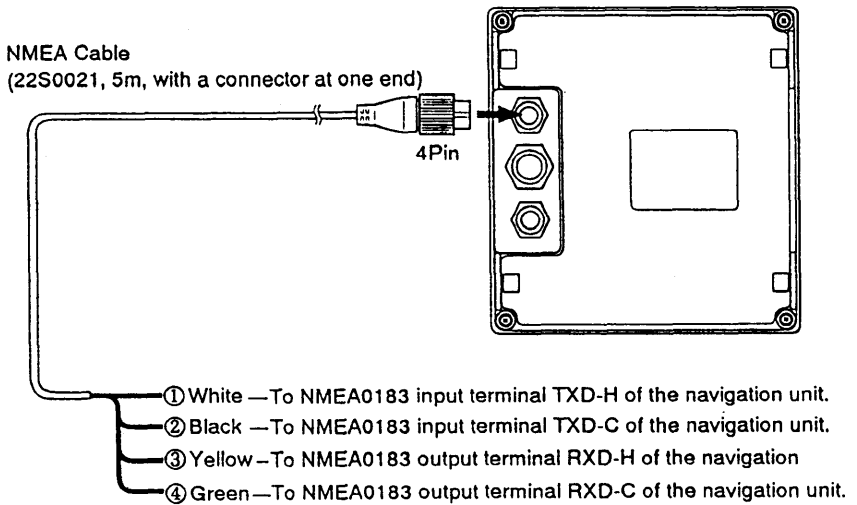

9. UNIT INITIALIZATION

When you wish to reset all settings on the front panel keys and the menus:

Turn on the power while pressing and holding down the SHIFT [-] and RANGE ▼ keys simultaneously, and the settings on the keys and the menus are reset to factory settings as shown below.

Menu 1

VRN ▼ ▲	0
SHIFT - +	0
RANGE ▼ ▲	0-20m
GAIN - +	5
AUTO	OFF
ALARM	OFF
NOISE LIMIT	OFF
PIC ADVNC	3
POWER BRILL	MAX
TONE	6

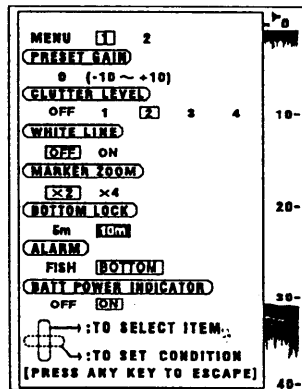

Menu 2

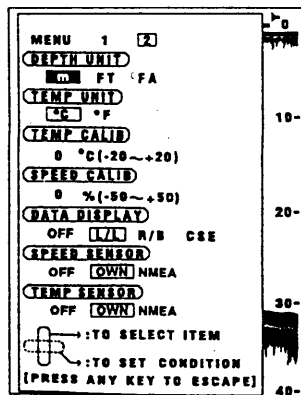

10. SPECIFICATIONS

1. Range/Pulselength/TX Rate

		Range	1	2	3	4	5	6	7
Basic Range	Meters	0-2.5	0.5	0-10	0-20	0-40	0-80	0-160	
	Fathoms	0-1	0-2.5	0-5	0-10	0-20	0-40	0-80	
	Feet	0-10	0-20	0-40	0-80	0-160	0-320	0-640	
Shift Step	Meters	0.5	1	2	4	8	16	32	
	Fathoms	0.25	0.5	1	2	4	8	16	
	Feet	2	4	8	16	32	64	128	
Display End Depth	Meters	162.5	165	170	180	200	240	320	
	Fathoms	81	81.5	85	90	100	120	160	
	Feet	650	660	680	720	800	960	1,280	
Pulselength	msec	0.1	0.2	0.2	0.2	0.2	0.2	0.4	
TX Rate	320~75 pulse/min (automatic switching according to display end depth)								

2. Display

6" LCD 92mm(W) × 122mm(H)
3.62" (W) × 4.80" (H)

3. Display Advance Speed

Setting	0	1	2	3	4
Lines/TX	Stop	2/8	2/4	2/2	2/1

4. Picture Element

240×320 pixels

5. Echo Display

3 tones (dark, medium, light)

6. Fish Alarm

The alarm sounds when a dark or medium tone echo comes into the specified alarm zone.

7. Bottom Alarm

The alarm sounds when seabed comes into the specified alarm zone.

- | | |
|---------------------------------------|--|
| 8. Battery Voltage Monitor | Sounds when battery voltage becomes lower than 10.5V or greater than 16.5V. |
| 9. Demonstration Display | The demonstration display provides artificially generated seabed and fish echoes, without transducer connection. |
| 10. TX Frequency/ Output Power | 50kHz or 200kHz, 300W (rms) |
| 11. Input/Output Data | NMEA0183 ver. 1.5/2.0
Input: RMA, RMB, RMC, BWC, GLL, VTG, MTW, XTE
Output: SDDBT (depth), YCMTW* (Water temperature), VWVHW* (Ship's speed)
*Requires speed temperature sensor |
| 12. Power Supply | 12Vdc (10 to 16Vdc), 10W |
| 13. Environmental Conditions | Temperature: 0 to 50°C (32 to 122°F)
Relative humidity: 20 to 90%
Waterproof structure: IPx5 (jet-proof type) |
| 14. Dimensions | 188(H) × 182(W) × 65(D)mm
7.40" (H) × 7.17" (W) × 2.56" inch |
| 15. Weight | 1.5 kg, 3.3 lb (Main unit, without hanger) |

11. EQUIPMENT LIST

Standard Supply (containing complete set)

Item	Model	Qty	Code No.	Remarks
LCD Video Sounder	LS-6000-50	1 set		50kHz
	LS-6000-200			200kHz

Complete Set

Item	Type	Qty	Code No.
Display Unit	LS-6000	1	
Hanger		1	100-185-361
Knob Bolt		2	100-173-273
Tapping Screw		4	000-802-081
Power Cable		1	000-134-082
Fuse		1	000-549-061
Waterproofing Cap		1	000-109-510
Blind Film		1	100-185-380
Operator's Manual		1	

Option

Item	Type	Code No.	Remarks
Transducer	520-5PSD	000-015-125	Plastic through-hull type
Transducer	520-5MSD	000-015-127	Metal through-hull type
Transducer	520-5PWD	000-015-126	Transom type
NMEA Cable	22S0021-3	000-109-517	Connection of navaid, connector at one end
P8 Metal Plug Adapter Cable	02S4093-0	000-134-901	Adaptor cable for 520-5PSC, 520-5MSC, 520-5PWC
Adhesive	0P02-31	000-013-634	For installation of inside-hull transducer
Inside-hull Mounting Kit	22S0191	000-802-598	

12. EXPLODED VIEW

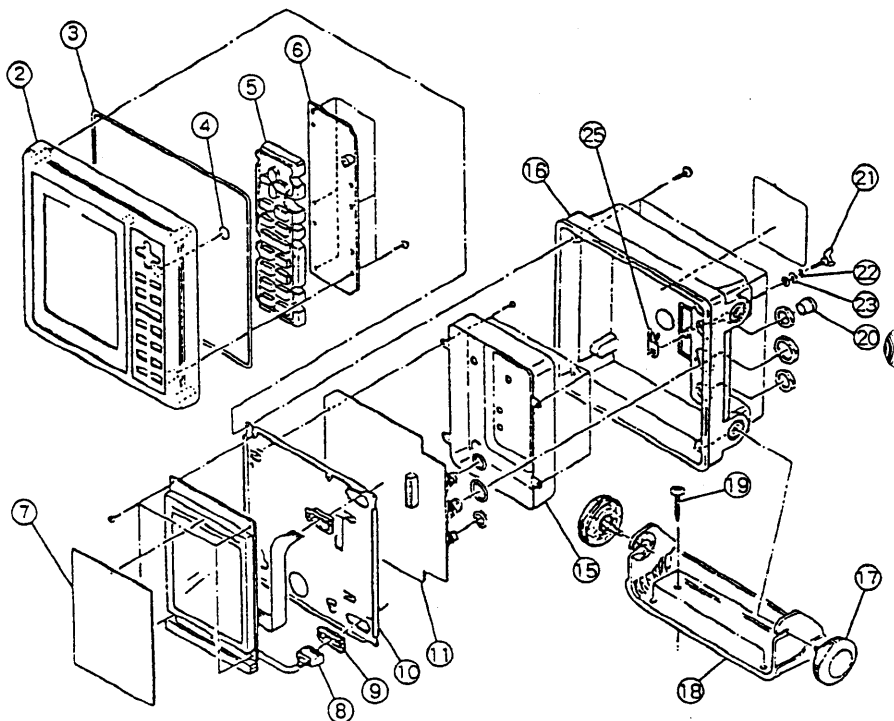

No.	Description	Qty
2	Front Panel	1
3	Panel Gasket	1
4	Buzzer Gasket	1
5	Key Assembly	1
6	P. C. Board Assembly	1
7	Filter	1
8	LCD Module	1
9	Square Bushing	2
10	P. C. Board Mounting Plate	1
11	Main P. C. Board Assembly	1

No.	Description	Qty
15	Shield Plate	1
16	Rear Panel	1
17	Knob Bolt	2
18	Hanger	1
19	Tapping Screw	4
20	Waterproofing Cap	1
21	Wing Bolt	1
22	Spring Washer	1
23	Flat Washer	2
		1
25	Ground Terminal	1

13. APPENDIX

Transom mount Transducer

Introduction

This type of mounting is very commonly employed, usually on relatively small I/O or outboard boats. Do not attempt this mounting on an inboard boat because turbulence is created by the propeller ahead of the transducer.

Procedure

1. Attach the transducer to the bracket.
2. To determine a suitable transducer mounting location, run the boat at several speed ranges and observe the water flow at the rear and near the transom. Suitable location is at least 50 cm away from engine and where the water flow is smooth.
3. On a relatively flat hull, the transducer is mounted flush with the hull-bottom, and there are two choices of installation as shown on page 45. Note that the direction of the transducer and fixing holes used on the brackets are different in each method. Although there is less influence from air bubbles with method (2), you must be careful not to damage the transducer when the boat is hauled out of the water/put on the trailer. On a deep "V" hull, the transducer is mounted in the same method as method (2). It should be mounted as near as the bottom edge of the transom, and the transducer face must be parallel with the sea surface, not with the hull bottom.
4. Mark the screw locations by holding the transducer in position on the transom.

5. Drill four pilot holes.
6. Mount the transducer and secure it with four self-tapping screws. Small amount of sealing compound under the head of each screw will preserve the watertight integrity of the transom.
7. Adjust the transducer position so that the transducer faces right the seabed.
8. If necessary, to improve water flow and minimize air bubbles staying on the transducer face, incline the transducer about 5 degrees at the rear. This may require a certain amount of experimentation for fine tuning at high cruising speeds.
9. Fill the gap between the wedge front of the transducer and transom with epoxy material to eliminate any air spaces.

When the transducer with speed/temperature sensor (molded in one unit: 520ST-PWD) is installed, follow the installation methods (2) on the next page.

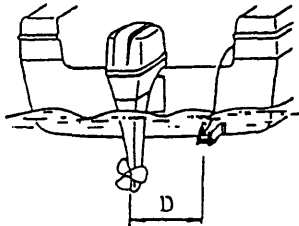

$D \geq 50 \text{ cm (18")}$

(Flat Hull)

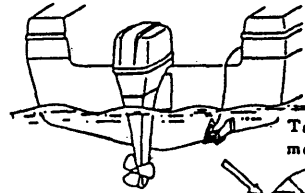

Take the method (2)

(Deep V-Hull)

METHOD (1) ... flush with hull

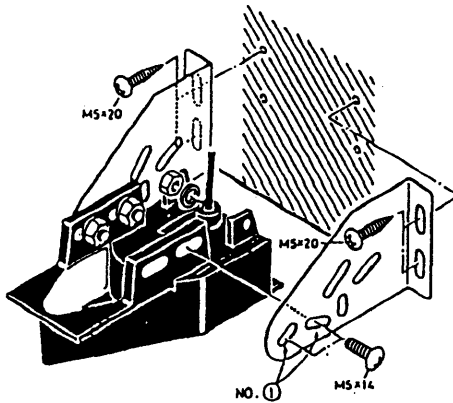

Cover the gap between transducer and hull plate with tape. Fill in epoxy materials and wait until they dry. When they dry, remove tape.

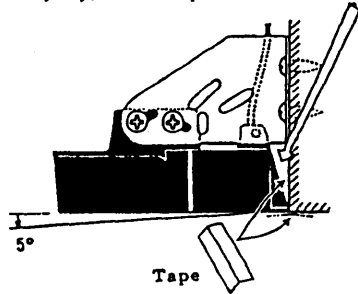

METHOD (2) ... projected from hull

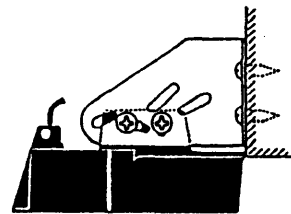
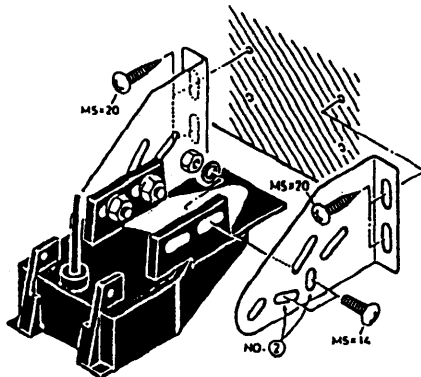

Installation

Free Manuals Download Website

<http://myh66.com>

<http://usermanuals.us>

<http://www.somanuals.com>

<http://www.4manuals.cc>

<http://www.manual-lib.com>

<http://www.404manual.com>

<http://www.luxmanual.com>

<http://aubethermostatmanual.com>

Golf course search by state

<http://golfingnear.com>

Email search by domain

<http://emailbydomain.com>

Auto manuals search

<http://auto.somanuals.com>

TV manuals search

<http://tv.somanuals.com>