

FUSION[®]

USER / INSTALLATION MANUAL

MARINE STEREO

MS-IP600 / MS-CD600 / MS-AV600



FUSION[®]

www.fusionelectronics.com

FUSION Electronics New Zealand Ph: +64 9 369 2900
FUSION Electronics Australia Ph: +61 1300 736 012
FUSION Electronics Europe Ph: +44 1268 889580
FUSION Electronics USA Ph: +1 623 580 9000

PRECAUTIONS

Do not attempt to open the units chassis. There are no user serviceable parts or adjustment's inside.

This unit has been tested with all compatible authentic iPod models under normal expected operating conditions, free from any pre-existing defects in either the unit or the iPod.

No responsibility can be taken for use of the unit other than under normally expected operating conditions in conjunction with fully functional and undamaged iPod units which have been manufactured and authorised by Apple Inc.

BEFORE INSERTING IPOD (MS-IP600)

Please ensure iPod dock connector is clean, dry & free from damage. Check that the units iPod dock is free from obstructions. Insert correct sleeve combination to match your iPod (Never insert iPod without a correct sleeve.)

Ensure iPod is inserted with display facing upwards, Never force your iPod into the dock, if the iPod does not mate with reasonable ease the sleeve/iPod combination is most likely incorrect.

Always remove your iPod from the unit when not in use & do not leave in your vessel, this in turn prevents risk of theft or damage as vessel cabins can reach extreme temperatures.

Do not remove iPod or use stereo in a distractive manner whilst operating the vessel, check and obey all marine laws in association with use.

Take care when removing iPod from unit as surfaces may be warm.

HANDLING COMPACT DISCS (CD/CD-R/CD-RW)

- » Avoid touching the surface of the disc
- » Avoid exposing the disc to direct sunlight
- » Ensure the disc is clean
- » Ensure the disc is not scratched or damaged

PLAYBACK OF CD-R/CD-RW

- » If your CD-R/CD-RW will not play, Ensure that the last recording session was closed or finalized.

FCC COMPLIANCE STATEMENT

This device complies with part 15 of the FCC rules. Operation is subject to the following two conditions:

- » This device may not cause harmful interference, and
- » This device must accept any interference received, including interference that may cause undesired operation.

RECORD YOUR PRODUCT DETAILS HERE:

Model Number

Date Of Purchase

Affix Receipt Here

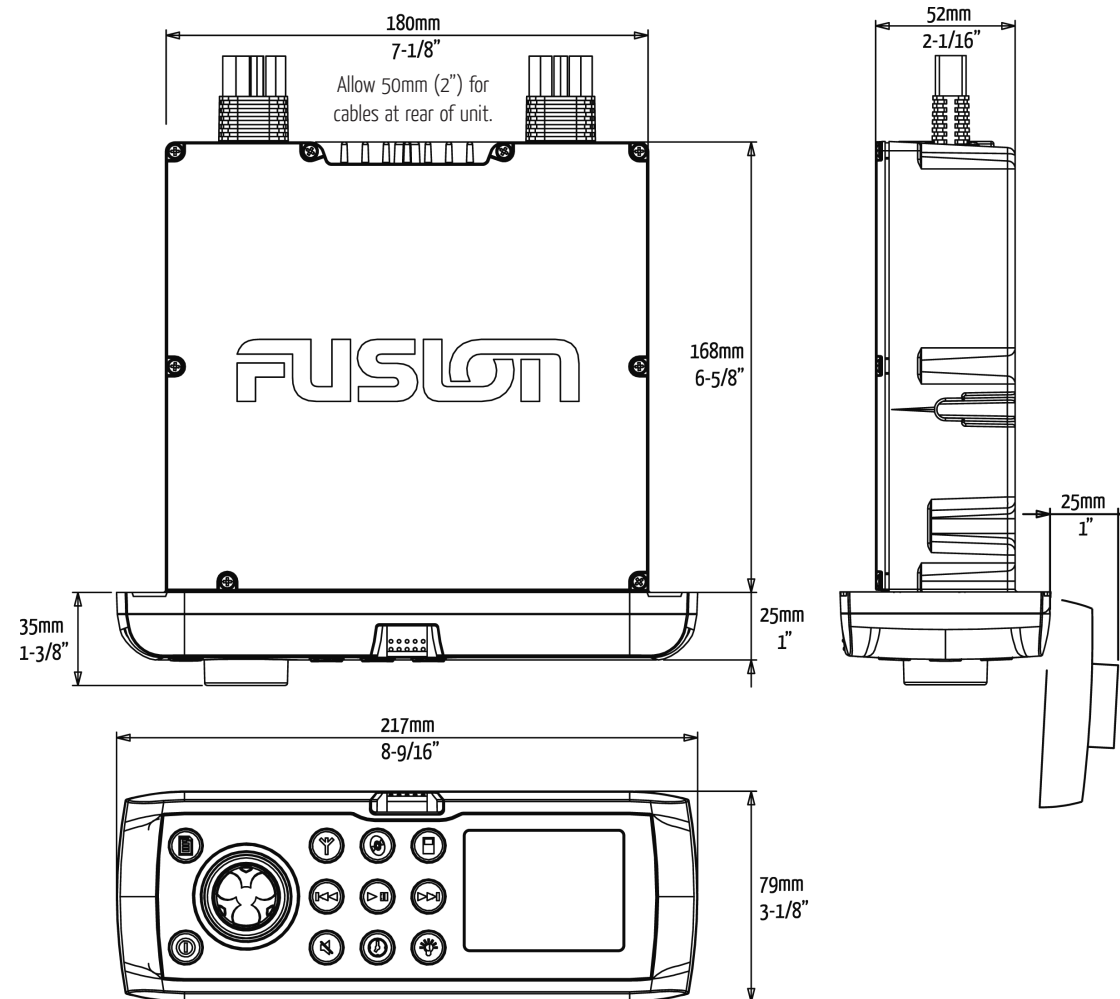

SPECIFICATIONS AND LICENSING

SPECIFICATIONS

CHASSIS DIMENSIONS	Depth 168mm - 6-5/8" Width 180mm - 7-1/8" Height 52mm - 2-1/16"
FACE PLATE DIMENSIONS	Depth 35mm - 1-3/8" Width 217mm - 8-9/16" Height 79mm - 3-1/8"
OPERATING VOLTAGE:	10.2 - 16VDC Negative ground
FUSE RATING:	15 Amp
OUTPUT POWER:	70 Watts x 4 (Max) 26 Watts RMS @ 4 Ohms 43 Watts RMS @ 2 Ohms
SPEAKER IMPEDANCE:	2 - 4 Ohms per channel
PRE - OUTPUT VOLTAGE:	3V
TUNING RANGE	
Europe and Australasia:	
FM Radio	AM Radio
Frequency Range: 87.5 - 108 MHz	Frequency Range: 522 - 1620 MHz
Frequency step: 100 kHz	Frequency step: 9 kHz
USA	
FM Radio	AM Radio
Frequency Range: 87.5 - 107.9 MHz	Frequency Range: 530 - 1710 MHz
Frequency step: 200 kHz	Frequency step: 10 kHz

CD PLAYER

Laser power Class 1

SUPPORTED MEDIA

» Only use discs with the following logos on the label.



» If you use discs without the above logos, correct performance cannot be guaranteed.

» You can play audio discs recorded on DVD +R -R, CD-R (Recordable), or CD-RW (Re Writable) media

» MP3 formatted audio files can also be played on DVD +R -R , CD-R and CD-RW containing these files.

COMPATIBLE WITH THE FOLLOWING iPod MODELS:

- » iPod classic, 80GB 120GB 160GB (2007, 2009);
- » iPod with video, 30GB 60GB 80GB;
- » iPod touch; iPod touch (2nd Gen);
- » iPod nano (3rd Gen); iPod nano (4th Gen);
- » iPod nano (5th Gen)

For latest news on supported iPod models visit www.fusionelectronics.com

LICENSING

 Apple, the Apple logo, iPod and iTunes are Trademarks of Apple Computer, Inc., registered in the U.S. and other countries.

 © 2007 SIRIUS Satellite Radio Inc. "SIRIUS" and the SIRIUS dog logo are trademarks of Sirius Satellite Radio Inc. All rights reserved.



PUBLISHED BY FUSION ELECTRONICS LIMITED. © Copyright 2009 by FUSION Electronics Limited. All rights reserved. Specifications and design are subject to change without notice. v5.2
YOU CAN HELP PROTECT THE ENVIRONMENT Please remember to respect the local regulations: Hand in the non-working electrical equipment to an appropriate waste disposal centre.

CONTENTS

BUTTON DESCRIPTION	2
INSTALLATION	4
CONNECTIONS	5
WIRING DIAGRAM	6
GENERAL OPERATION	7
RADIO OPERATION	8
SIRIUS SATELLITE RADIO (USA ONLY)	9
CD/MP3 OPERATION	10
AUX OPERATION	11
iPod OPERATION	12
DVD OPERATION	14
MS-AV600 IR REMOTE OPERATION	15
ZONE OPERATION	16
MENU STRUCTURE	17
TROUBLESHOOTING	18
FUSION MARINE ACCESSORIES	19
SPECIFICATIONS AND LICENSING	20

BUTTON DESCRIPTION



MS-IP600 model shown



ROTARY ENCODER

Turn

To adjust volume, move up or down a menu structure, or adjust a specific setting item.

Press

To select a highlighted option, confirm a setting. Press to step through each zone for volume adjustment.

Press and Hold

For quick access to subwoofer level adjustment



CATCH RELEASE BUTTON

Press down to open front panel.



EJECT (MS-CD600 and MS-AV600 only)

Press to eject CD/DVD. (Located inside front panel)



POWER

Press to turn the unit ON/OFF.



MENU

Press to enter Menu System. Press to return to previous screen.



FUSION MARINE ACCESSORIES

iPod EXTERNAL DOCK

MS-IPDOCK / MS-IPDOCKG2



Connect this external iPod dock to the Marine CD Stereo (MS-CD600) or the Marine DVD Stereo (MS-AV600) to provide the additional benefit of an integrated housing for your iPod. The bulkhead mount dock complies with IPx5 Waterproof

Standards, protecting your iPod from the harsh marine environment. The iPod marine external dock can be flush mounted or wall mounted.

iPod CONNECTION CABLE (1.5m)

MS-IP15L2



Enables the connection of your iPod to the Marine CD Stereo (MS-CD600) or the Marine DVD Stereo (MS-AV600).

MARINE WIRED REMOTE

MS-WR600



The Marine Wired Remote Control extends the capabilities of the Stereo by enabling local control of the audio in each zone of your vessel. Up to three remotes can be linked to the Stereo, via a CANbus network, providing true system flexibility.

MARINE ZONE AMPLIFIER

MS-AM702



The Marine 2x70 Watt D-Class Zone Amplifier is designed to support the multi-zone technology of the Marine Stereo. The Zone Amplifier is small, enabling discrete installation and when combined with the Marine Stereo provides the platform for a True multi-zone audio system.



TROUBLESHOOTING

RESET BUTTON

Press the Reset button in the event of a malfunction to reset the unit, where normal operation is not automatically restored within 1 minute.

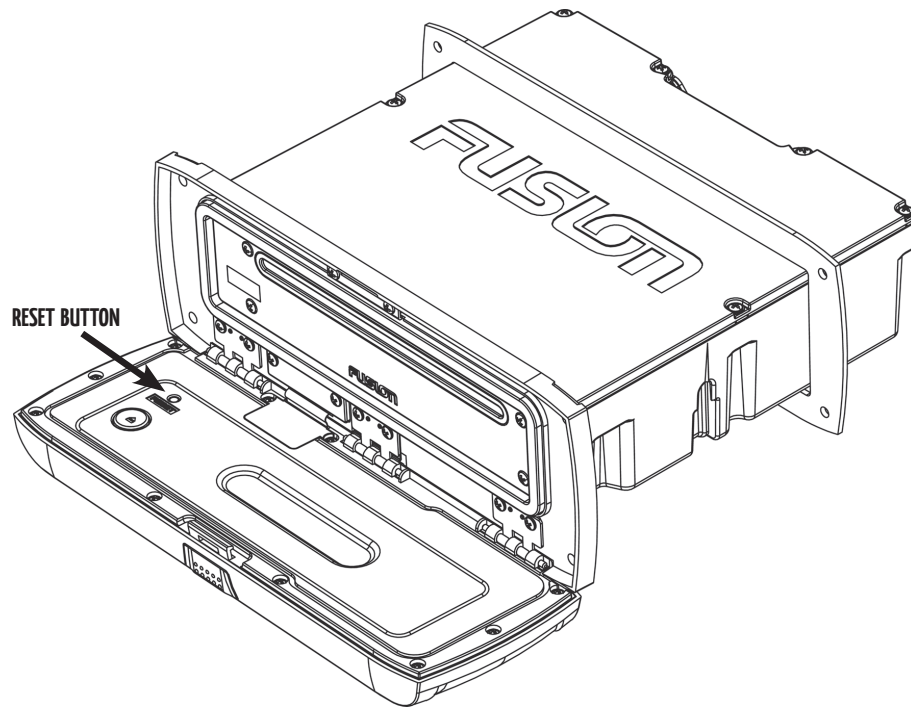

○

|



RADIO

Press to access the Radio source AM - FM - SIRIUS.



CD (MS-CD600 only)

Press to access the CD/MP3 source.

DVD (MS-AV600 only)

Press to access the DVD/CD/MP3 source.



AUX (MS-IP600 only)

Press to access Auxiliary source.



iPod

Press to access the iPod source.

Press again to access Auxiliary source (MS-CD600 & MS-AV600).



BACK/PREVIOUS

Short Press

DVD/CD/MP3/iPod - Select the previous track.
AM/FM/Sirius - Start tuning down the frequency spectrum. (Auto/Manual tuning mode) or previous preset (Preset mode).

Press and Hold

DVD/CD/MP3/iPod - Rewind the current track.
AM/FM/Sirius - Enter Manual Tuning mode.



FORWARD/NEXT

Short Press

DVD/CD/MP3/iPod - Select the next track.
AM/FM/Sirius - Start tuning up the frequency spectrum. (Auto/Manual tuning mode) or next preset (Preset mode).

Press and Hold

DVD/CD/MP3/iPod - Forward the current track.
AM/FM/Sirius - Enter Manual Tuning mode.



PLAY/PAUSE

DVD/CD/MP3/iPod - Pause / resume the current track.
AM/FM/Sirius - Switch between Auto/Preset tuning mode.

Press and Hold

AM/FM/Sirius - Store the current station as a Preset.



MUTE

Mutes all sound in all zones.



CLOCK

Displays the clock.



DISPLAY

Press to enter the display settings screen.
Adjustment can be made to the Contrast and Brightness.

○

INSTALLATION

IF ANY MODIFICATION TO THE VESSEL IS REQUIRED, SUCH AS DRILLING HOLES ETC FUSION RECOMMENDS CONSULTATION WITH YOUR BOAT DEALER OR MANUFACTURER BEFOREHAND.

- » Remove the Sun Cover from the unit
- » Fit mounting gasket
- » Insert the unit into the mounting hole
- » Pull down the front face to expose the mounting screw locations.
- » Use either the supplied 4 x wood screws, or 4 x machined screws and metal clamps to affix the unit into position.
- » The unit must be mounted within 30 degrees of the horizontal plane.

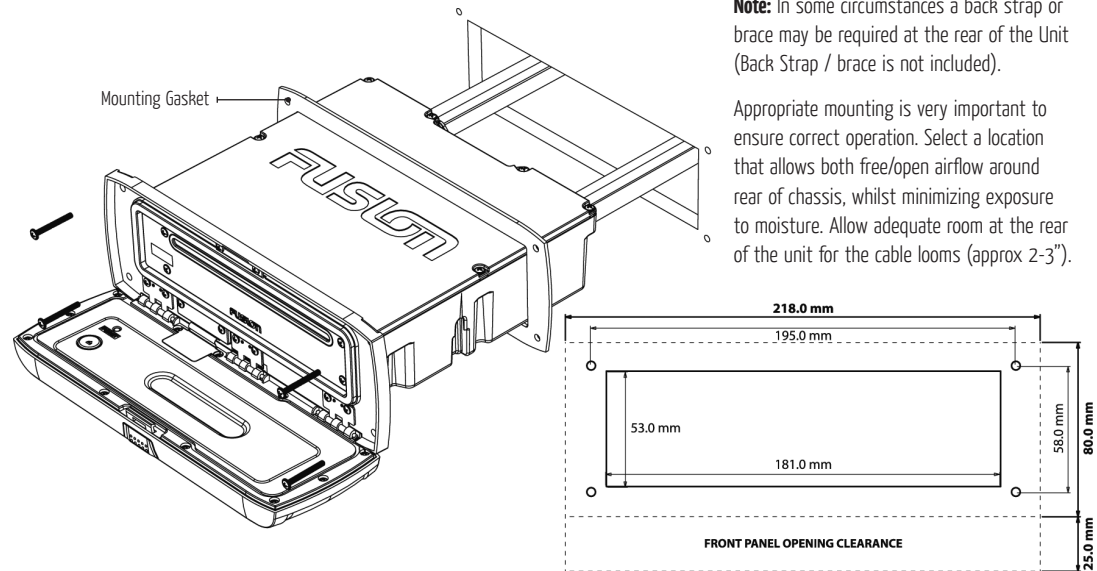

ELECTRICAL WIRING

Caution: The MS-IP600, MS-CD600 and MS-AV600 are designed for vessels with a 12V DC Negative ground electrical system

MENU STRUCTURE

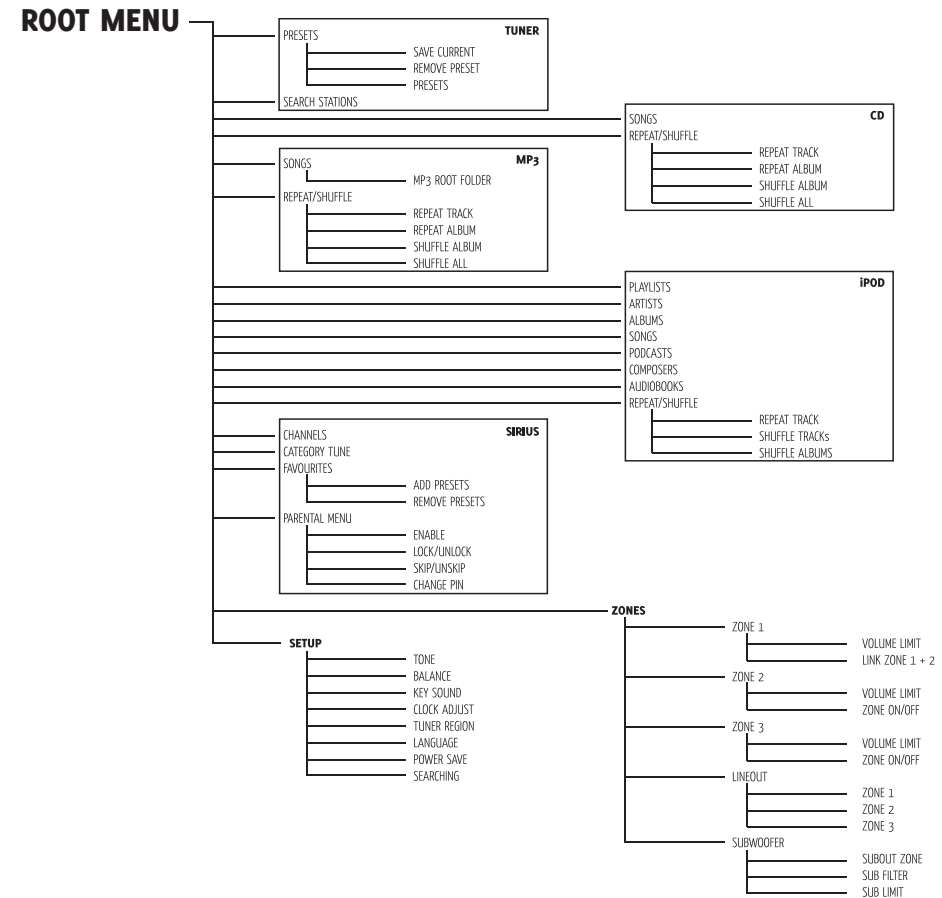

ZONE OPERATION

The FUSION Marine Stereo makes it possible to have 3 'Zones', that have independent volume control.

Zone 1 and 2 are powered and can be linked, Zone 3 requires a FUSION Marine Amplifier. All Zones have adjustable volume limits.

Note: If the Zone is selected as 'Off' The features are not available.

ZONE SETUP

Press the 'Menu' button and select 'Zones'. Select the Zone you wish to setup.

ZONE ON/OFF

Select 'On' if Zones are present on the vessel.

Note: Zone 1 cannot be turned OFF

VOLUME LIMIT

Select 'Volume Limit' to set the desired maximum output volume for each individual Zone.

LINK ZONE 1 + 2

Allows the volume control to operate Zones 1 + 2 as a combined pair. The Zone set up for Zone 1 and 2 can be configured separately when in this mode.

Press the 'Menu' button and select 'Zones'. Select 'Zone 1' then 'Link Zone 1 + 2'. Select 'On' to activate this feature.

LINEOUT

Lineout gives you the ability to connect a FUSION Marine Amplifier.

Note: The lineout can independently be assigned to Zone 1, 2 or 3.

Press the 'Menu' button and select 'Zones'. Select 'Lineout'. Select the Zone you are assigning to the Lineout.

SUBWOOFER

Change the assigned zone of the subwoofer. Also adjust the sub level and filter.

SUBOUT ZONE

Press the 'Menu' button and select 'Zones'. Select 'Subwoofer' then 'Subout Zone'. Select the desired subwoofer zone.

Note: The subwoofer can independently be assigned to Zone 1, 2 or 3.

SUB FILTER

Press the 'Menu' button and select 'Zones'. Select 'Subwoofer' then 'Sub Filter'. Select the desired frequency.

SUB LIMIT

Press the 'Menu' button and select 'Zones'. Select 'Subwoofer' then 'Sub Limit'. Select the desired maximum subwoofer output volume.

Note: Press and Hold the 'Rotary Encoder' for quick access to subwoofer level adjustment

CONNECTIONS

DESCRIPTION

COLOUR

Battery +12VDC	Yellow
Accessory +12V switched	Red
Negative Ground	Black
Remote Amplifier Turn On	Blue/White

Refer to the wiring diagram for reference (pg 6)

Note: The +12V switched and +12V battery can be joined for some installation requirements.

ANTENNA CONNECTION

Connect an AM/FM marine antenna.

AUX INPUT

Connect an Auxiliary source to the left and right RCA (White = L, Red = R).

iPod CONNECTION (MS-CD600 and MS-AV600 only)

Connect the 1.5m iPod accessories lead MS-IP15L (not included), or connect the MS-IPDOCK (not included)

SIRIUS SATELLITE RADIO (For use in USA only)

Connect to SiriusConnect™ tuner (not included)

WIRED REMOTE (MS-WR600)

Connect a marine wired remote to the CANbus system connector. Up to 3 remotes can be connected to the system.

VIDEO CONNECTION (MS-AV600)

Connect the composite video or the S-Video output to a TV / LCD monitor.

ZONE

CONNECTIONS

Zone 1

White = Speaker Left Positive
White / Black = Speaker Left Negative
Grey = Speaker Right Positive
Grey/ Black = Speaker Right Negative

Zone 2

Green = Speaker Left Positive
Green / Black = Speaker Left Negative
Purple = Speaker Right Positive
Purple / Black = Speaker Right Negative

Note: Speaker connection (2 Ohm Stereo minimum). 2 pairs of 4 Ohm speakers per channel can be connected in parallel to achieve 2 Ohm configuration.

Zone 3/Lineout

Low level output
(For connection to external amplifier)
White RCA= Left Output
Red RCA = Right Output
Orange RCA= Subwoofer Output

Note: Line Output / Sub can both be independently assigned to Zone 1, Zone 2 or as a unique Zone 3.

WIRING DIAGRAM

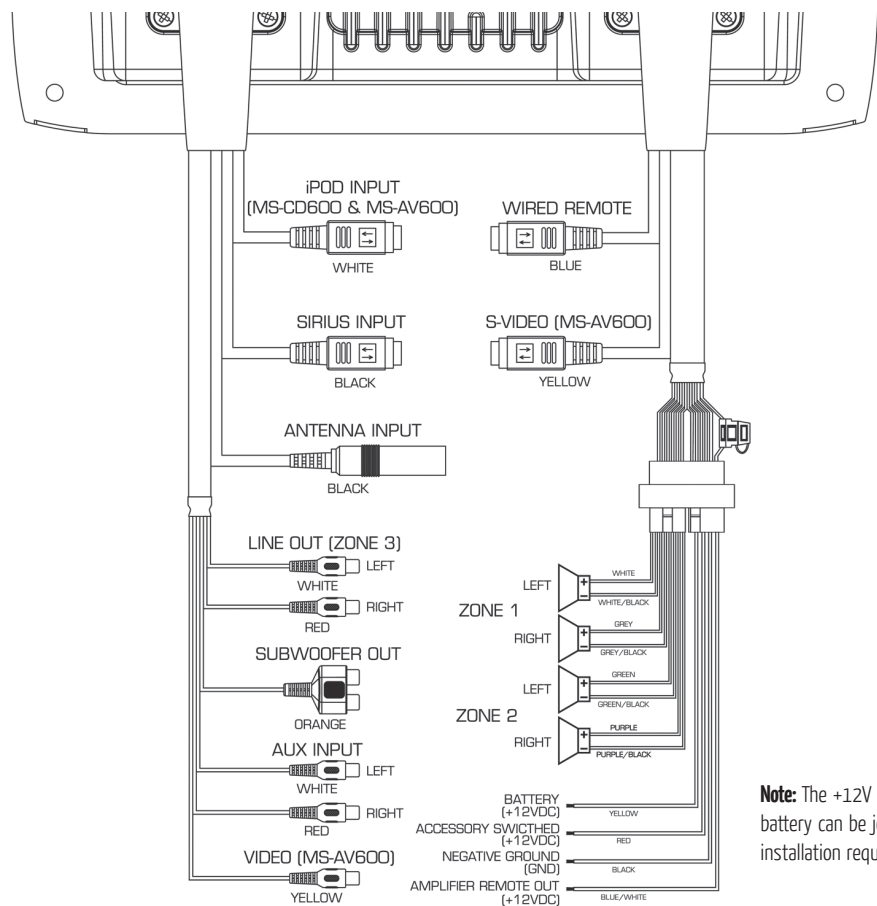

Note: The +12V switched and +12V battery can be joined for some installation requirements.

○

|

MS-AV600 IR REMOTE OPERATION

	MENU	Direct access to the menu		SETUP	Used to access the DVD settings
	SEL	Select the item with the SEL key		SYSTEM SET UP	TV System - Auto Play - TV Type - Password - Rating -Default - Exit Setup
	SEL NAVIGATION	Navigate & adjust using the up, down, left & right keys.		LANGUAGE SET UP	OSD Language - Audio Language - Subtitle Language - Menu Language - Exit Setup
	POWER	Press to turn the unit ON / OFF		VIDEO SET UP	Brightness - Contrast - Hue - Saturation - Sharpness - Exit Setup
	CLOCK	Displays the clock		PREVIOUS	Selects previous track
	MUTE	Mutes all sound in all zones		NEXT	Selects next track
	SOURCE	Select the source required ▶ DVD - iPod - AUX - FM - AM - Sirius ▶		PLAY/PAUSE	Pause or play the track
	ZOOM	Select picture size video output		BACK	Rewind track
	SUB-T	Select subtitle language		FORWARD	Fast-forward track
	RDM	Press to cycle through options		STOP	Press Once: to 'Pre-stop' Press Again: to stop disc completely
	REPEAT	Press to cycle through options		VOLUME	Press + to increase the volume Press - to decrease the volume Press volume then 'SEL' to select different zone for volume adjustment
	DISPLAY	Press to cycle through options			
	0-9 KEYPAD	Direct track access			

|

○

DVD OPERATION

MS-AV600 only

PRECAUTIONS

Never insert foreign objects into the disc slot. If the disc does not insert easily, there may already be another disc inserted. Some disc formats may not be readable if the format is not compatible.

PLAYING A DVD/CD/MP3





Press the 'DVD' button to select DVD / CD / MP3 source. Playback of the disc will start automatically. The disc loading time will vary.

Note: The disc will resume from the start.

DVD/CD/MP3 NAVIGATION

Navigation is controlled by the supplied Infrared Remote Control, and is presented on external screen. (See MS-AV600 IR Remote Operation)

DVD FUNCTIONS

-  **DVD** Press to access the DVD/CD/MP3 source
-  **PLAY/PAUSE** Play or Pause the track
-  **BACK/PREVIOUS** **Short Press:** Selects previous track/chapter
Press and Hold: Rewind
-  **NEXT/FORWARD** **Short Press:** Selects next track/chapter
Press and Hold: Fast-forward







GENERAL OPERATION

POWER

Press the 'Power' button to turn the unit ON/OFF

SELECTING A SOURCE

Press the desired source button:

-  **RADIO** AM/FM/Sirius (Sirius - US Only)
-  **CD / DVD** CD/MP3 (MS-CD600) / DVD (MS-AV600)
-  **iPod/AUX** Press for iPod
Press twice for AUX (MS-CD600 and MS-AV600)
-  **AUX** AUX (MS-IP600)

ADJUSTING THE VOLUME

Turn the 'Rotary Encoder' to adjust the volume.

ZONE VOLUME

Press the 'Rotary Encoder' to step through zones.



Note: The last adjusted zone, becomes the start of the above zone selection cycle.

SETUP

Press the 'Menu' button and select 'Setup'. Select the desired function. Turn the 'Rotary Encoder' to adjust or press to switch selection (if available). Press 'Menu' to return.

Note: Remember, whilst in the Setup system the 'Menu' button acts as a back/return to the previous screen.

TONE

Adjust the treble and bass settings. Press the 'Rotary Encoder' to switch between bass and treble selection.

BALANCE

Adjust the audio balance from left to right.

CLOCK ADJUST

Adjust the Clock time, 12/24 hour. Turn the 'Rotary Encoder' to adjust the Hour, Press to confirm, repeat to adjust the minutes. Press to confirm.

REGIONS

Select Europe for the following tuner frequency stepping:

FM Radio	AM Radio
Frequency Range: 87.5 - 108 MHz	Frequency Range: 522 - 1620 MHz
Frequency step: 50 kHz	Frequency step: 9 kHz

Select USA for the following tuner frequency stepping:

FM Radio	AM Radio
Frequency Range: 87.5 - 107.9 MHz	Frequency Range: 530 - 1710 MHz
Frequency step: 100 kHz	Frequency step: 10 kHz

Note: Select 'Europe' for Australasian tuner frequency stepping

LANGUAGE

Select the desired language for the on screen display.

POWER SAVE

OFF Backlight on constantly

ON Backlight display goes off after one minute of non-operation

Note: The MS-CD600, MS-IP600 and MS-AV600 feature Clock battery back up and EEPROM technology. This allows the unit to be completely disconnected from the constant +12V voltage supply (Battery switch) with no settings being lost.

RADIO OPERATION

SETUP

REGION SELECTION

Press the 'Menu' button and select 'Setup'. Select 'Tuner Region' and select your tuner region.

OPERATION

BAND SELECTION

Press the 'Radio' button to select band. FM - AM - SIRIUS (USA only)

AUTOMATIC SEEK TUNING

Press the 'Previous' or 'Next' button to scan to the next station.

MANUAL SEEK TUNING

Press and hold the 'Previous' or 'Next' button for 3 seconds to enter manual mode. The manual tuning icon will flash on screen. Press the 'Previous' or 'Next' button to step up and down the spectrum.

Note: After remaining idle for six seconds, the tuning mode will revert to automatic.

PRESETS

You can manually store radio frequencies in the preset memory, or automatically in FM band. There are 15 presets available per band.

STORING A STATION AS A PRESET

When listening to a frequency, press and hold the 'Play' button to store preset.

Alternatively: Press the 'Menu' button and select 'Presets'. Select 'Save Current' to store station.

AUTOMATIC SEARCH AND STORE PRESETS (FM only)

Press the 'Menu' button and select 'Search Stations' to automatically search and store stations.

Note: Automatic search mode will erase all other presets already stored, and will automatically store the stations into the preset menu in numerical order.

RECALLING A PRESET STATION

To listen to a radio frequency stored in the preset menu, select the required band, FM - AM - Sirius. Press the 'Play' button to enter 'Presets' mode. Press the 'Previous' or 'Next' button to select previous or next preset.

Alternatively: Select the required band. FM - AM - Sirius. Press 'Menu' and select 'Presets'. Select the desired preset.

DELETING A STORED PRESET

Press 'Menu' and select 'Presets'. Select 'Remove Presets'. Select the desired preset, or 'All'.

F.A.S.T

FUSION ALPHA SEARCH TECHNOLOGY

If your iPod contains more than 50 Artists, Songs or Albums you can use F.A.S.T to quickly navigate by letter or number.

Example: Press the 'Menu' button and select 'Artists'. Select 'D' and the first 'Artist' beginning with 'D' will automatically highlight. Using the 'Rotary Encoder' you can then scroll up or down from this selection.

F.A.S.T THRESHOLD

The threshold (number of items) at which point the Alpha Search screen appears for iPod menus can be changed. To change the threshold, navigate as follows - press the 'Menu' button and select 'Setup', then 'Searching'. Select your desired item number threshold.

▶ ON → OFF → 50 → 100 → 200 → 400 → 800 ▶

NO iPod CONNECTED

If this appears on the display possible causes are

- » Ensure the iPod is correctly connected
- » Ensure the cable is not excessively bent (MS-CD600, MS-AV600)
- » The iPods battery remains low (refer to iPod manual and charge the battery)

iPod OPERATION

PRECAUTIONS FOR iPod

(MS-IP600 only) Before inserting your iPod into the MS-IP600 you must first insert the correct sleeves to match iPod model.

- » For the iPod nano (3rd gen), the iPod must be placed inside the adapter sleeve, and then placed inside Dock sleeve combination A.
- » Before inserting iPod, Please ensure iPod dock connector is clean, dry & free from damage. Check that unit iPod dock is free from obstructions. Insert correct sleeve combination to match your iPod. Never insert iPod without a correct sleeve.
- » Ensure iPod is inserted with display facing upwards, Never force your iPod into the dock, if the iPod does not mate with reasonable ease the sleeve/iPod combination is most likely incorrect.

SELECTING THE CORRECT IPOD SLEEVE

(MS-IP600 only) A different set of sleeves is used for each iPod model. The different sleeve combinations are outlined in the chart below:

iPod	TOP SLEEVE	BOTTOM SLEEVE
iPod with video, 30GB	A	A
iPod with video, 60GB 80GB	A	B
iPod classic, 80GB	B	A
iPod classic, 160GB (2007)	B	B
iPod classic, 120GB	B	A
iPod classic, 160GB (2009)	B	A
iPod touch,	D	D
iPod touch, 2nd gen	D	D
iPod touch, 2nd gen (2009)	D	A
nano, 3rd Gen	A	A + adapter
nano, 4th Gen	E	E
nano, 5th Gen	G	G
Other	F	F

Note: To check your iPod model, go to www.apple.com/support and enter the serial number found on the back of the iPod.





LISTENING TO AN iPod

Press the 'iPod' button. Playback of the iPod will start automatically.

iPod NAVIGATION

Press the 'Menu' button to enter the iPod menu. The rotary encoder operates similar to the click wheel on your iPod. Turn to navigate and press to enter.

Note: Press the 'Menu' button to return to the previous menu screen.

-  **iPod** Press to access the iPod source
-  **PLAY/PAUSE** Play or Pause the track
-  **BACK/PREVIOUS** **Short Press:** Selects previous track
Press and Hold: Rewind track
-  **NEXT/FORWARD** **Short Press:** Selects next track
Press and Hold: Fast-forward track

REPEAT / SHUFFLE

Press the 'Menu' button and select 'Repeat/Shuffle'. Select 'Repeat Track', 'Shuffle Track' or 'Shuffle Album'. Select ON/OFF. Default setting is OFF.

SIRIUS SATELLITE RADIO

USA only - SIRIUS TUNER NOT INCLUDED

ACTIVATING YOUR SIRIUS TUNER

You must activate the SIRIUS tuner before you can begin to receive the SIRIUS Satellite Radio Service.

In order to activate your radio subscription, you will need the SIRIUS ID (SID) which uniquely identifies your tuner. The 12 digit SID is displayed on the LCD on initialization. MS-CD600, MS-IP600 and MS-AV600 will display the SID on Channel 0.

Power on your system and make sure that you are receiving good signal, you are able to hear audio on the SIRIUS Preview channel (Ch-184)

Note: Have your credit card handy and contact SIRIUS on the internet at <https://activate.sirius.radio.com/> and follow the prompts to activate your subscription. You can also call SIRIUS toll-free at 1-888-539-SIRIUS (1-888-539-7474) Once activated, you will be able to begin enjoying SIRIUS Satellite Radio's digital entertainment and can tune to other channels.

SIRIUS OPERATION

Press 'Radio' to select Sirius source radio.

SIRIUS NAVIGATION

Press the 'Menu' button and navigate the functions.

CHANNELS

Select the desired channel (listed in channel order) and music preference

CATEGORY

Select the desired genre type. (The unit will only play the selected option)

FAVOURITES

Add your favourite channel to your favourites list by selecting 'Add Favourite' (Maximum 15 channels). Remove channels by selecting 'Remove Favourite'. Select 'All' or the individual channel. Exit by pressing the 'Menu' button.

Alternatively: Press and hold the 'Play' button to store favourite.

PARENTAL MODE

ENABLE ON/OFF

Select to enable channels to be locked/unlocked

PIN

Turn the 'Rotary Encoder' to select number and press to enter, repeat to enter the 4 digit code. (Factory setting is 0000)

Note: Must be entered before the following items are operational.

LOCK / UNLOCK

Select the channel to be locked or unlocked

SKIP / UN-SKIP

Select the channel to be bypassed

CHANGE PIN

Personalise your Pin number. (4 digits max)

CD/MP3 OPERATION

MS-CD600 only

PRECAUTIONS FOR CD/MP3

Never insert foreign objects into the CD slot. If the CD does not insert easily, there may already be another disc in the unit. Some CD-R/CD-RW may not be readable if the format is not compatible.

The format of an MP3 disc must be ISO9660 Level 1 or 2 or Joliet in the expansion Format. When naming an MP3 file, ensure the file extension is .MP3





LISTENING TO A CD/MP3

Press the 'CD' button. Playback of the CD will start automatically.

CD NAVIGATION

Press the 'Menu' button and select 'Tracks'. Select desired track.

CD / MP3 FUNCTIONS

-  **CD** Press to access the CD/MP3 source
-  **PLAY/PAUSE** Play or Pause the track
-  **BACK/PREVIOUS** **Short Press:** Selects previous track
Press and Hold: Rewind track
-  **NEXT/FORWARD** **Short Press:** Selects next track
Press and Hold: Fast-forward track

MP3 NAVIGATION

Note: The MP3 disc will take approx 10 seconds to load the disc data (if available) to the unit.

Press the 'Menu' button and select 'Songs' to enter the MP3 root directory. Use the 'Rotary Encoder' to navigate the functions of your MP3 folders and files. Select the highlighted folder or file.

Note: Press the 'menu' button to return to the previous menu screen.

REPEAT / SHUFFLE

Press the 'Menu' button and select 'Repeat/Shuffle'. Select 'Repeat Track', 'Repeat Album', 'Shuffle Album' or 'Shuffle All'. Select ON/OFF. Default setting is OFF.

AUX OPERATION

CONNECTING AN AUXILIARY AUDIO DEVICE

- » The Left & Right AUX RCA plugs are located at the rear of the unit.
- » Connect your auxiliary audio device.

Note: You may require an adapter cable to connect your device.

LISTENING TO YOUR AUXILIARY AUDIO DEVICE

- » Press the 'AUX' button to select AUX mode (MS-IP600) or press the 'iPod' button twice (MS-CD600 or MS-AV600)
- » Start playback on your auxiliary audio device. Use both the volume control on your auxiliary device (if available) and the volume control on the FUSION Marine Stereo to set the volume level.

Free Manuals Download Website

<http://myh66.com>

<http://usermanuals.us>

<http://www.somanuals.com>

<http://www.4manuals.cc>

<http://www.manual-lib.com>

<http://www.404manual.com>

<http://www.luxmanual.com>

<http://aubethermostatmanual.com>

Golf course search by state

<http://golfingnear.com>

Email search by domain

<http://emailbydomain.com>

Auto manuals search

<http://auto.somanuals.com>

TV manuals search

<http://tv.somanuals.com>