

Gas Convection Oven

HALF SIZE

UCCO-G-05
UCCO-G-25



PLEASE READ ALL SECTIONS OF THIS MANUAL

THIS PRODUCT HAS BEEN CERTIFIED AS COMMERCIAL COOKING EQUIPMENT AND MUST BE INSTALLED BY PROFESSIONAL PERSONNEL AS SPECIFIED.

WE SUGGEST INSTALLATION, MAINTENANCE AND REPAIRS SHOULD BE PERFORMED BY YOUR LOCAL AUTHORIZED GARLAND SERVICE AGENCY LISTED IN YOUR INFORMATION MANUAL PAMPHLET.

In the event you have any questions concerning the installation, use, care or service of the product, write our Customer Service Department.

NOTE. Unit must be installed with no less than 6" clearance from Combustible construction at rear and 6" from sides.

RETAIN FOR FUTURE REFERENCE.

Continuous product improvement is a Garland policy, therefore specifications and design are subject to change without notice

GARLAND
A WEILBILT Company

Garland Commercial Industries, Inc.
Freeland, Pennsylvania 18224

Phone (717) 636-1000
Telex 887610

P/N 1382620 R-1

Printed in U.S.A.

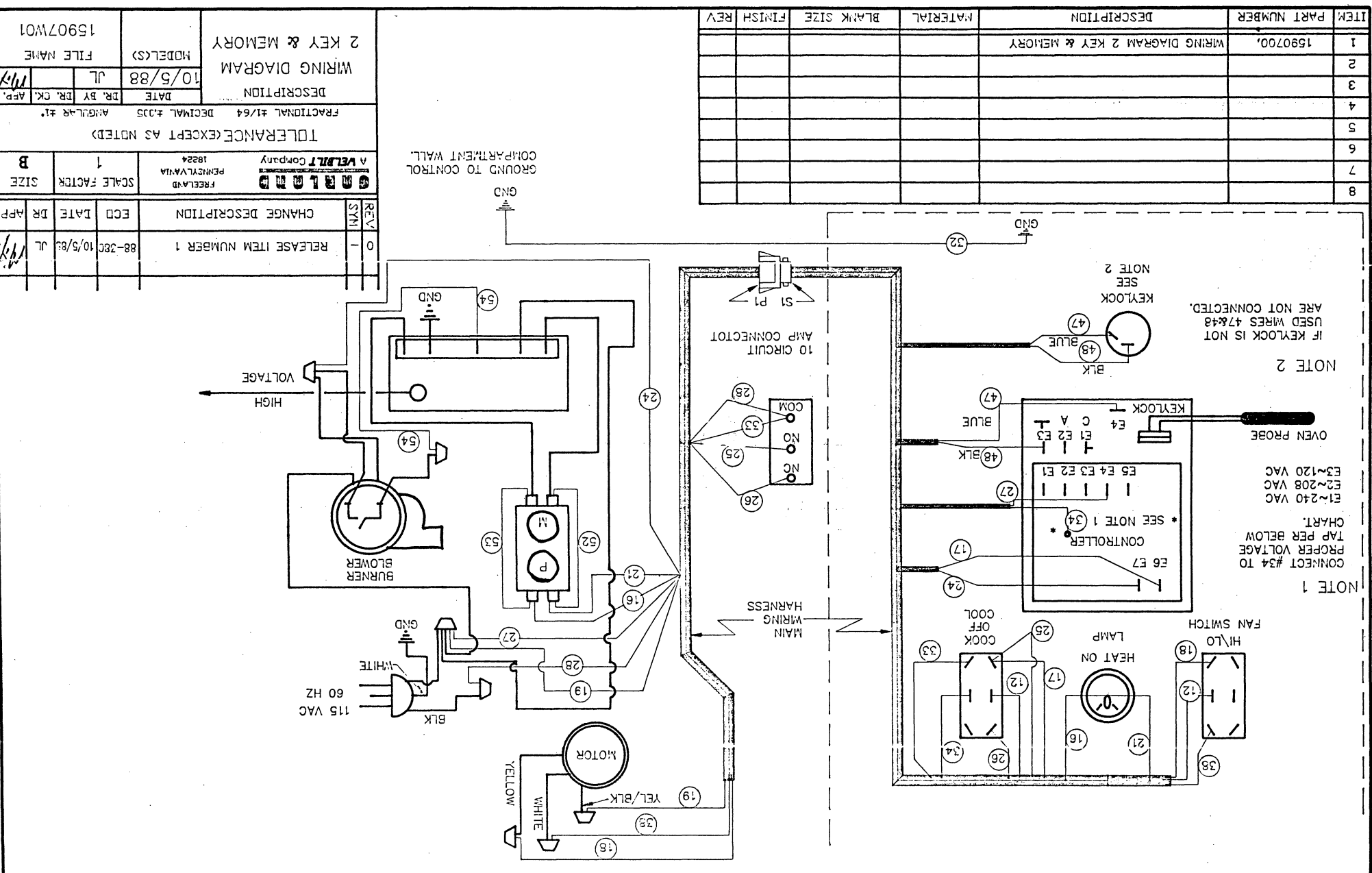

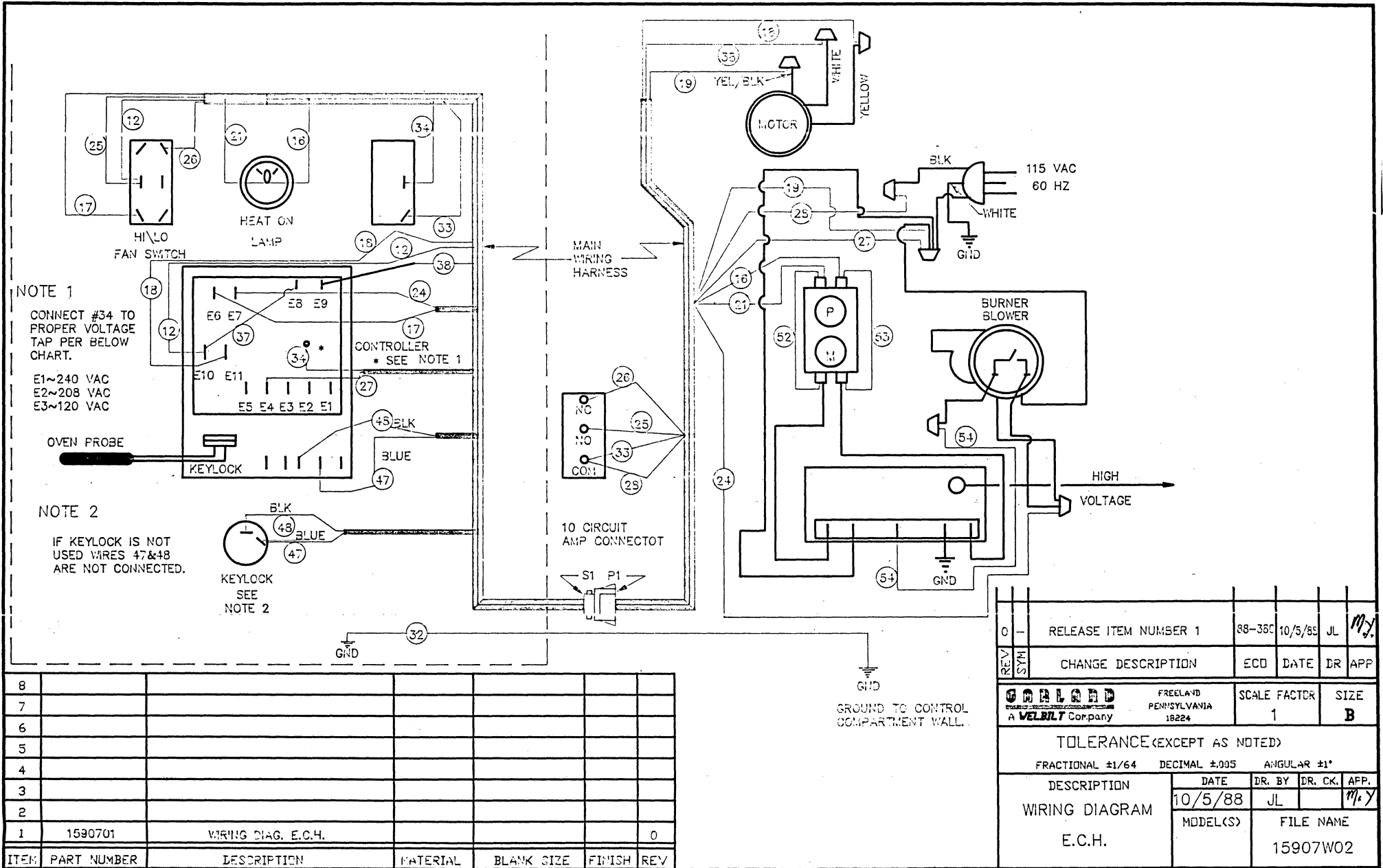

FOR YOUR SAFETY
DO NOT STORE OR USE GASOLINE
OR OTHER FLAMMABLE VAPORS AND
LIQUIDS IN THE VICINITY OF THIS OR
ANY OTHER APPLIANCE.

FOR YOUR SAFETY: Post in a prominent location, instructions to be followed in the event the user smells gas. This information shall be obtained by consulting your local gas supplier.

EXTERIOR FINISHES

Painted and stainless surface may be cleaned and kept in good condition by applying a light oil such as Shielia Shine. Saturate a soft cloth and wipe oven exterior when cold. Wipe excess with a clean cloth.

OVEN INTERIOR

Before cleaning oven interior, remove oven racks and rack guides. Oven racks and rack guides can be cleaned with a mild soap and warm water.

The porcelain interior can be easily cleaned with oven cleaners such as Easy-Off or Dow Cleaner. Apply only when oven is cold.

MAINTENANCE - MOTOR CARE

The motor on your GARLAND Convection Oven is maintenance free since it is constructed with self-lubricated sealed ball bearings. It is designed to provide durable service when treated with ordinary care. We have a few suggestions to follow on the care of your motor. When the motor is operating, it cools itself internally by air entering at the rear of the motor case, provided proper clearance has been allowed.

Since the blower wheel is in the oven cavity it is at the same temperature as the oven. If the motor is stopped while the oven is hot, the heat from the blower wheel is conducted down the shaft and into the armature of the motor. This action could shorten motor life.

We recommend, at the end of the bake or roasting period, when the oven will be idle for any period of time or before shutting down completely, that the doors be left open, and by use of the cool-down position on the fan switch, the fan continues to run at least 5 minutes. The "FAN" should never be turned "OFF" when the oven is "HOT".

TROUBLESHOOTING GUIDE

---CAUTION---

HIGH VOLTAGE - Before opening control panel for servicing disconnect appliance from power source. Failure to do so may result in serious injury.

- NOTES:
1. The time/temp control in the **UCO** is an all electronic unit and contains no field serviceable components or adjustments. If malfunction is traced to control it should be replaced.
 2. It is important to note the calibration of the time/temp control is dependent upon the correct voltage/phase and frequency of the electrical supply. This should be checked whenever any control problems are encountered. The appliance rating plate shows the correct values and can be used as reference.
 3. If calibration check is required, measuring thermometer or pyrometer must be placed in the center of the oven cavity. Two calibration bands are provided in the temp control. The low band extends from 100-300°F; the high band from 300-500°F. Calibration should be checked at 200°F and 400°F.
- IMPORTANT** - Temp control operates in 5°F steps. When checking calibration with actual temp. switch, only temperatures divisible by 5 will be displayed.
4. Refer to chart below for troubleshooting.

SYMPTOM	UNIT TOTALLY INOPERATIVE	FAN MOTOR	TEMP INACCURATE	NO HEAT	TEMP INACCURATE	CONTROL INOPERATIVE DISPLAY UNIT	CNT START TIMER	CNT DISPLAY	ACTUAL TEMP SWITCH	DYEN PROOF
OVER FAN	X	X	X	X						
INOPERATIVE	X	X	X	X						
FAN SPEEDS AT	X	X	X	X						
FAN SPEEDS AT	X	X	X	X						
FAN INOPERATIVE	X	X	X	X						
FAN INOPERATIVE	X	X	X	X						
IN COOL DOWN MODE	X	X	X	X						
POOR PRE-HEAT	X	X	X	X						
NO HEAT	X	X	X	X						
TEMP INACCURATE	X	X	X	X						
TEMP INACCURATE	X	X	X	X						
CONTROL INOPERATIVE	X	X	X	X						
DISPLAY UNIT	X	X	X	X						
CNT START TIMER	X	X	X	X						
CNT DISPLAY	X	X	X	X						
ACTUAL TEMP SWITCH	X	X	X	X						
DYEN PROOF	X	X	X	X						

CONGRATULATIONS! You have purchased the finest commercial cooking equipment available anywhere.

Like any other fine, precision built piece of equipment, it should be given regular care and maintenance. Periodical inspections by your dealer or a qualified service agency are recommended. When corresponding with the factory or your equipment dealer regarding service problems or replacement parts, be sure to refer to the particular unit by the correct model number (including prefix and suffix letters and numbers) and the serial or code number. The rating plate affixed to the unit contains the information.

REGULAR MAINTENANCE ENSURES PEAK PERFORMANCE

TABLE OF CONTENTS

Specifications 2
 Installation 3, 4
 Operation 5
 Maintenance 6, 7
 Use Guide 6
 Troubleshooting 7
 Wiring Diagram 8

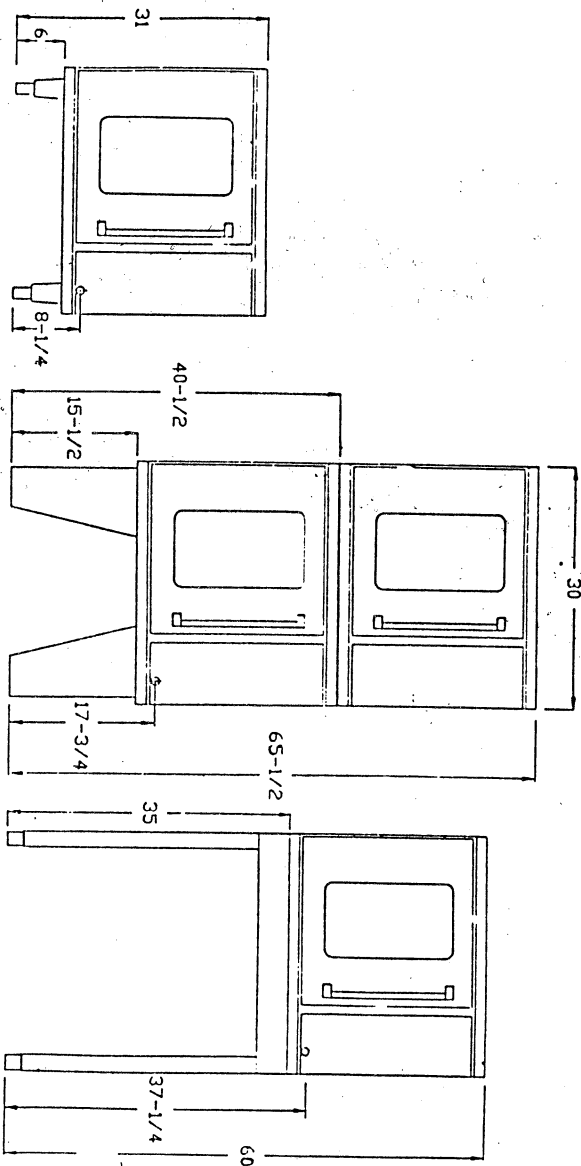

MODEL	GAS SPECIFICATIONS		ELECTRICAL CHARACTERISTICS
	NATURAL	PROPANE	
UCO-G-05	25,000 BTU/HR # 43 DMS	25,000 BTU/HR # 54 DMS	AMPS: 2.3 each Volt: 115 VAC. 1 Phase 60 HZ
UCO-G-25	25,000 BTU/HR # 43 DMS	25,000 BTU/HR # 54 DMS	

*Measured at manifold tap.
 Cabinet base or open base does not change the gas specifications.

The importance of the proper installation of commercial gas cooking equipment cannot be overstressed. Proper performance of the equipment is dependent, in great part, on the compliance of the installation with the manufacturer's specifications. In addition, compliance with the National Fuel Gas Code ANSI Z 223.1/NFPA No. 54-Latest Edition and/or local code is required to assure safe and efficient operation.

RETAIN FOR FUTURE REFERENCE

SECTION I FIELD ASSEMBLY

1. Single and Double Deck Units

A. Leg Installation:

All units are shipped with N.S.F. approved legs. These legs must be installed to provide a minimum clearance of 6" between the floor and bottom of the unit in order to meet National Sanitation Foundation requirements.

- When using the legs described above, raise front of unit and block, install leveling legs by inserting them into the conical leg retainers. Repeat at rear of unit and adjust all legs to level unit. The bottom of the foot is hexagonal in shape so a wrench may be used to adjust the height of the leg to level oven.

DECKING INSTRUCTIONS

1. Leg Installation:

- Raise the front of oven. Position the legs at the front corners of the main bottom. Start each bolt with lock washer threading then into the weld nuts which are located in the main bottom. Four bolts must be used to secure each leg in place. Tighten the bolts evenly and securely. (5/16 DIA bolts and lockwashers in decking kit).

- Raise and block the rear of the oven and fasten the rear legs as above.

2. Stacking of Units:

- Place top unit into place and line up body sides and backs of the units.
- Fasten the rear of the two units together by removing 2 screws from bottom of upper deck, and remove 2 screws from top of lower deck. Secure units together with mounting plates provided in decking kit.
- Open control panels on top and bottom units.
- Locate existing 1/4" hole in main bottom of top unit.
- Drill 1/4" hole in main top of bottom unit using 1/4" hole (Item D) as template.

- Bolt top and bottom units together by using 1/4" nut and bolt supplied in stacking kit.
- Mount the flue riser at the rear of the unit.
- Assemble stacking pipes according to illustrations.
- Level unit four (4) ways and hook up the gas feed line. Plug in the cord set of each unit.

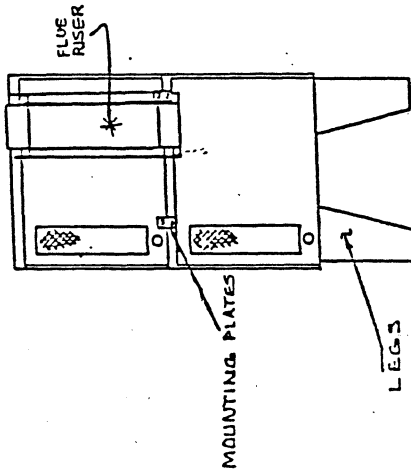

BACK VIEW

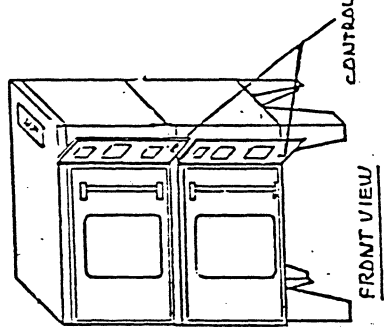

FRONT VIEW

CLEARANCES: FROM COMBUSTIBLE MATERIAL 6" REAR AND 6" SIDES.

Each gas appliance shall be located with respect to building construction and other equipment so as to permit access to the appliance. Such access and clearance may be necessary for servicing and cleaning.

PRODUCT INFO	TEMPERATURE	TIME
Sheet Cakes (3 lbs. ea. pan, 5 pans*)	300°F	25 min.
Chocolate Chip Cookies (2", 15 ea. pan, 5 pans*)	300°F	12 min.
Sugar Cookies (2", 15 ea. pan, 5 pans*)	300°F	12 min.
Soda Biscuits (12 ea. pan, 5 pans*)	375°F	6 min.
Bread (1 lb. loaves, 12 loaves, 3 racks)	330°F	20-25 min.
Rolls (15 ea. pan, 5 pans*)	330°F	12 min.
Fruit Pies, 20 oz. frozen (2 ea. pan, 5 pans*)	345°F	35 min.
Basic Muffins (2 1/2 oz. ea., 120 muffins, 5 racks)	325°F	18 min.
Hamburgers (6/1, 12 ea. pan, 5 pans*)	400°F	10 min.
Rolled Roast (4 roasts, 10 lbs. ea., 2 pans)	300°F	2 1/2 hrs.
Baked Potatoes (8 oz. ea., 18 ea. pan, 5 pans*)	425°F	45 min.
Lasagne, Frozen (6 lb. pans, 5 pans)	325°F	1 1/2 hrs.
Cheese Sandwichs, Toasted (12 ea. pan, 5 pans*)	400°F	7 min.
Chicken Parts (20 ea. pan, 5 pans)	350°F	35 min.

*Half-Size Bun Pan - 17 13/16" x 12 7/8"

MAINTENANCE

STAINLESS STEEL

For routine cleaning just wash with a hot detergent solution. Wash just a small area at a time or the water will evaporate leaving the chemicals behind causing streaking.

Rinse the washed area with a clean sponge dipped in a sanitizing solution and wipe dry with a soft clean cloth before it can dry.

Use a paste of water and a mild scouring powder if you have to, but never rub against the grain. All stainless steel has been polished in one direction. Rub with the polish lines to preserve the original finish. Then thoroughly rinse as before.

To prevent fingerprints there are several stainless steel polishes on the market that leave an oily or waxy film. Do not use on surfaces that will be in contact with food.

Stainless may discolor if overheated. These stains can usually be removed by vigorous rubbing with a scouring powder paste.

Scale may form whenever hard water is used. Regular cleaning should eliminate any build-up. Water softening equipment may be required if the condition is severe.

Use only stainless steel, wood, or plastic tools if necessary to scrape off heavy deposits of grease and oil. Do not use ordinary steel scrapers or knives as particles of the iron may become imbedded and rust. Steel wool should never be used.

Either a typical bleach solution or hot water can be used to sanitize stainless steel without harm.

4. MANUAL OPERATION (CONT'D)

- F. At this point, temperature display digits will flash until oven reaches temperature.
- G. When temperature digits lock in steady; load product and depress "Start Timer" keypad. Colon will now blink indicating Timer is counting down.

See Step 3B above for tones heard at end of cook or roast cycle depending on if hold temperature has been selected.

- NOTE: In manual mode of operation, time and/or temperature may be increased or decreased by rotating time or temperature select knobs as desired.

5. COOL DOWN

- A. To cool cavity down, set mode switch to "Cool" position and open oven door.

MEMORY THERMOSTAT

1. Start Up

- A. Set Power Switch to "ON" position.
- B. Set Mode Switch to desired position.

NOTE: Digital displays 4 & 5 should be illuminated.

2. Pre-setting of Time/Temperature programs.

- A. Rotate keyswitch 8 to "Program" position.
- B. Depress and hold keypad labeled "Pgm. 1".
- C. Rotate time select control 6 until desired cook time is indicated by time display digits 4.
- D. Rotate temperature select control 7 until desired cooking temperature is indicated by temperature display digits 5.
- E. Release keypad "Pgm. 1".
- F. Program remaining locations Pgm. 2 thru 5 in the same manner as above.
- G. Return keyswitch 8 to "Run" position.

3. Operation - Program Mode

- A. Depress desired cooking program (pgm 1 -- pgm. 5).

NOTE: Time and temperature displays 4 & 5 will now indicate pre-set values as programmed in step 2 - Oven will pre-heat to indicated temperature and temperature display digits will stop flashing. At this point oven is ready.

- B. Load product and depress keypad labeled "Start Timer". Time digits will stop flashing and colon 4a will now blink indicating that timer is counting down.
- C. When cook time has elapsed, a tone will sound to alert operator.

NOTE: Tone is continuous and may be cancelled only by depressing keypad labeled "Cancel".

4. Manual Operation.

NOTE: Keyswitch must be in "Run" position.

- A. Select desired cooking temperature with: temperature select Control 7.
- B. Select desired cooking time with time select control 6. At this point temperature display digits 5 will flash until oven reaches temperature.
- C. When temperature digits lock in steady; load product and depress "Start Timer" keypad. Colon 4a will now blink indicating timer is counting down.
- D. Cancel tone with "Cancel" keypad.

NOTE: In manual mode of operation time and/or temperature may be increased or decreased "on the fly" by rotating time or temperature controls as desired.

5. Cool Down

- A. To cool oven cavity, set mode switch to cool down position and open oven door.

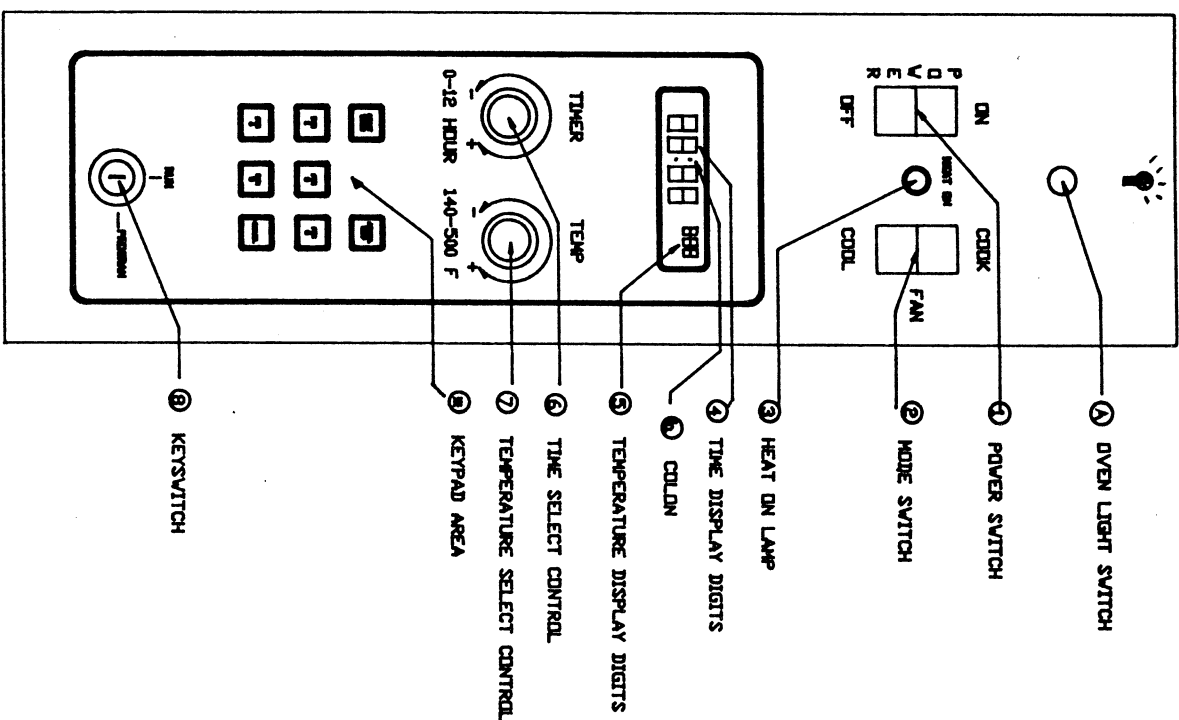

SECTION II GAS CONNECTION

1. A readily accessible gas shut-off valve of an approved type should be installed in the supply line upstream of the unit pressure regulator. A pipe joint compound resistant to liquefied petroleum gases should be used on all pipe joints. There must be room at the rear and right side in order to properly install the gas connection.

2. The American National Standards Institute makes it mandatory that a pressure regulator be installed on all gas commercial cooking equipment. An approved pressure regulator is provided with each unit for either natural or propane gas as manufactured per the order.

3. The 1" NPT inlet of the tee must be considered in piping the gas supply for double stack units. Undersize gas supply line(s) may restrict the gas supply and affect performance. If other gas appliances are supplied by the same supply line, the supply line must be sized to carry the combined volume without causing more than 1/2" pressure drop at the manifold of each appliance on the line at full rate.

NOTE: The appliance and its individual shutoff valve must be disconnected from the gas supply piping system during any pressure testing of that system at pressures in excess of 1/2 PSIG (3.45 KP2).

The appliance must be isolated from the gas supply piping system by closing its individual manual shutoff valve during any pressure testing of the gas supply piping system at test pressures equal to or less than 1/2 PSIG (3.45 KP2).

Installation for Ovens Equipped with Casters

The installation shall be made with a connector that complies with the Standard for Connectors for Moveable Gas Appliances ANSI Z21.69-Latest Edition.

2. The front casters of the oven are equipped with brakes to limit the movement of the oven without depending on the connector and any quick-disconnect device of its associated piping to limit the appliance movement.
3. Please be aware, there is a restraint on the oven and if disconnection of the restraint is necessary, be sure to reconnect the restraint after the oven has been returned to its originally installed position.

ELECTRICAL CONNECTIONS

A separate 15 AMP service must be provided for each oven section. For 115V usage, a cord and plug is provided but connection to the electrical service must comply with local codes; or in the absence of local codes, with the National Electrical Code ANSI/NFPA No. 70-latest Edition.

This appliance is equipped with a three-prong (grounding) plug for your protection against shock hazard and should be plugged directly into a properly grounded three-prong receptacle. Do not cut or remove the grounding prong from this plug.

Wiring diagram is attached to the rear of the unit.

LOCATION - VENTILATION AND AIR SUPPLY

1. Appliances shall be installed in a location in which the facilities for ventilation permit satisfactory combustion of gas and proper circulation of air within the confined space. When buildings are so tight that normal infiltration does not provide the necessary air, outside air shall be introduced.

2. All gas burners and pilots need sufficient air to operate and large objects should not be placed in front of this oven which would obstruct the air flow through the front.

3. A good ventilation system is important for satisfactory performance and it is recommended to install the oven under a power vented canopy.

4. Objects should not be placed on main top rear of oven while in use. This could obstruct the venting system of the units flue products.

5. If the oven must be connected to a direct flue, this flue should rise 10 feet above the roof of the building in which the oven is installed, or 10 feet above any portion of a building within a horizontal distance of 10 feet. It is recommended that a flue hood assembly and 6" draft diverter for single and double deck units be installed to insure proper ventilation. All parts described above are available from GARLAND.

DRAFT HOOD

If your oven(s) are connected to a direct flue vent it will require periodical examination and cleaning. Commercial cooking equipment requires an adequate ventilation system. For additional information refer to the National Fire Protection Association Standard No. 96.

CHECK PROPER DRAFT

If you experience pilot outage or erratic bake results you can make an easy check on the direct flue system.

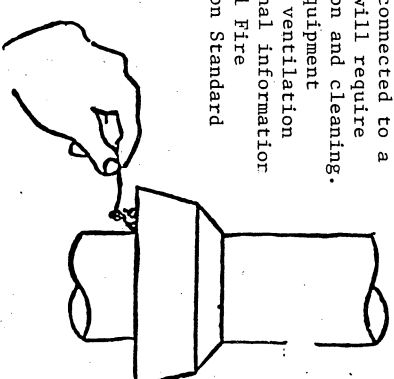

After the appliance has been on for approximately 15 minutes, strike a wooden kitchen match. Blow it out and while still smoking hold it near the draft hood relief opening. If the smoke is not easily drawn into the opening, the vent is not functioning properly. Consult your vent installer or factory service agent for further action.

FOR YOUR SAFETY: KEEP YOUR APPLIANCE AREA FREE FROM COMBUSTIBLES.

SECTION III TESTING AND ADJUSTMENTS

This equipment has been factory tested and adjusted, but rough handling, low gas pressure, altitude or variations in gas characteristics may require fine adjustment or changes of pilot settings or burner air adjustments.

All fittings and pipe connections must be tested for leaks. Use approved gas leak detectors, soap solution or equivalent, checking over and around all fittings and pipe connection. DO NOT USE FLAME!!!!

STANDARD ELECTRONIC THERMOSTAT OPERATION

1. A. Set Cook/Off/Cool Switch 1 to cook position.
- B. Set fan high/low switch 2 to desired speed.

NOTE: Digital displays 4 & 5 should be illuminated and the oven fan on.

2. A. Rotate temperature knob 7 to obtain desired cooking temperature. Red temperature digits 5 will now flash until internal oven temperature reached desired cooking temperature.
- B. The actual internal oven temperature may be viewed at any time by depressing the temperature switch 9.
- C. The cooking temperature may be increased or decreased at any time by rotating the temperature knob 7. The temperature digits 5 will again flash until oven reaches new temperature.

3. TIMER OPERATION

- A. To set timer, rotate time knob 6 until desired cooking time is indicated on the white display digits. 4 - digits will now flash indicating that timer is ready to be started.
- B. To start timer depress timer start switch 8. White digits 4 will stop flashing and timer colon 4A will blink indicating timer is counting down.

NOTE: When the time digits reach 00:00 a tone will sound to alert operator.

- NOTE: 1. The tone is continuous and must be cancelled by depressing timer cancel switch 8.
2. Timer does not control oven; product must be removed by operator at time = 00:00 or oven switched off manually.

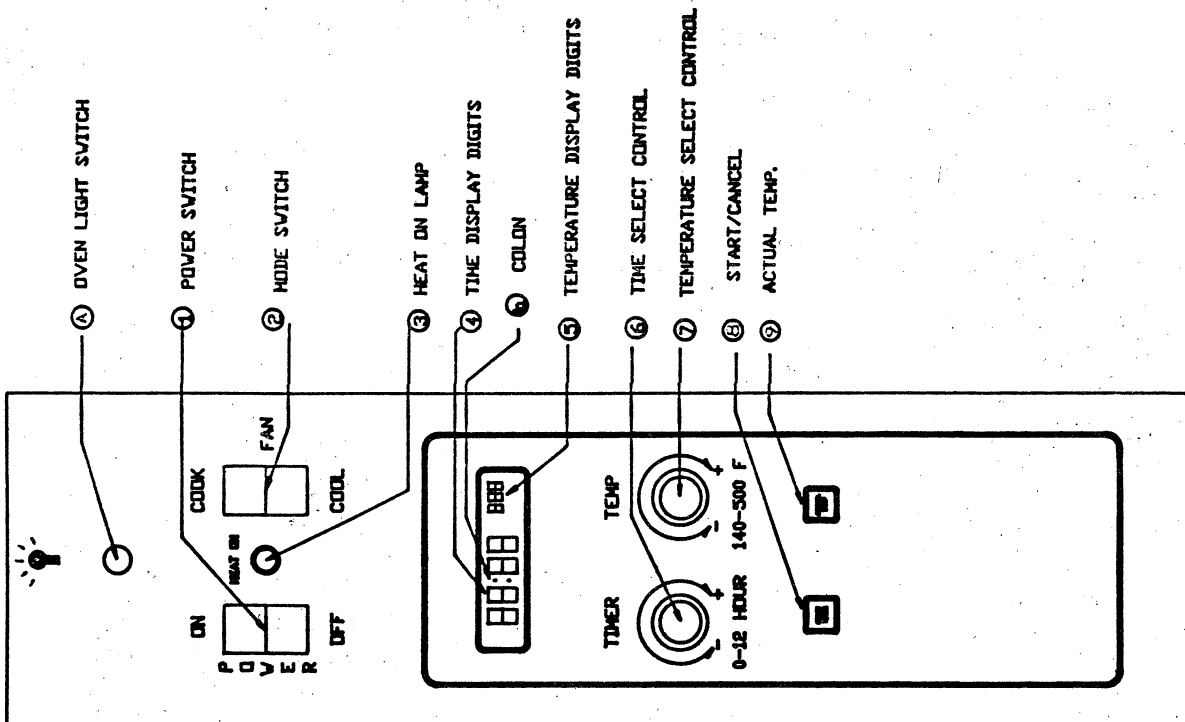

4. COOL DOWN

- A. To cool oven cavity, set cook/off/cool switch to cool down position and open oven door.

5. TESTING AND LIGHTING INSTRUCTIONS

- A. Open control panel door to access gas fittings. Turn on main gas valve. Leak test all fittings and connections ahead of the service valve located upstream from the gas solenoid. Correct any leaks and recheck.
- B. Open shutoff valve located on combination control which is located behind control panel. Turn switch on control panel to cook position. Amber light on control panel will cycle with burner with amber light on; burner is now ignited by direct spark. Check all fittings again and correct any leaks and recheck.

OPERATING INSTRUCTIONS

COOK OR ROAST/HOLD THERMOSTAT

1. START UP

- A. Set Power Switch to "On" position.
 - B. Set Mode Switch to desired position.
- NOTE: Digital Displays 4 & 5 should be lit.

2. PRESETTING OF COOK OR ROAST/HOLD PROGRAMS

NOTE: It is easier to program keys with the door open and Mode Switch in the cook position. In this set up, neither the fan nor the burners will operate.

- A. Rotate keyswitch to "Program" position.
- B. Depress keypad labeled "Roast" (for slow fan speed) or "Cook" (for high fan speed) and Release.
- C. Depress and Hold keypad labeled "Pgm. 1".
- D. Rotate Time Select Control until desired cook or roast time is indicated by the time display digits (up to 24 hours).
- E. Rotate Temperature Select Control until desired cook or roast temperature is indicated by temperature display digits (from 140° to 500°F).
- F. Release keypad "Pgm. 1".
- G. To Set Hold Temperature (Note: Hold is not required unless desired as part of a cook or roast process): Depress keypad labeled "Hold" and Release.
- H. Depress and Hold keypad labeled "Pgm. 1".
- I. Rotate Temperature Select Control until desired holding temperature is indicated by temperature display digits (from 140° to 250°F).
- J. Release keypad "Pgm. 1".
- K. Program remaining locations Pgm. 2 thru 6 in the same manner as steps "B" thru "J" above.

3. OPERATION - PROGRAM MODE

NOTE: Keyswitch must be in "Run" position.

- A. Depress desired program (keypads "Pgm. 1" thru "Pgm. 6").
NOTE: Time, Temperature, and Mode Display will now indicate pre-set values as programmed in step 2. Oven will pre-heat to indicated temperature and temperature display digits will stop flashing. At this point, oven is ready.
- B. Load product and depress keypad labeled "Start Timer". Time digits will stop flashing and colon will blink indicating that the timer is counting down. When the cook or roast time has elapsed and a hold temperature has been selected, 3 beeps will sound indicating the end of the specified cook or roast time.

The temperature display digits will flash indicating the oven is ramping down to the selected hold temperature. Also at this time, if the Heat On Lamp is off, the motor will turn off. In the hold mode, the motor is on only when the heat is on. When the oven temperature ramps down to the specified hold temperature (the first time the heat and motor come on after the end of the cook or roast time) the timer will start counting up to show the amount of time the product has been in hold.

If no hold temperature was selected, a tone will sound at the end of the cook or roast cycle to alert the operator. This tone is continuous and may be cancelled only by depressing the keypad labeled "Cancel".

4. MANUAL OPERATION

NOTE: Keyswitch must be in "Run" position.

- A. Depress keypad labeled "Roast" (for slow fan speed) or "Cook" (for high fan speed).
- B. Rotate Time Select Control until desired. Cook or roast time is indicated by the time display digits (up to 24 hours).
- C. Rotate Temperature Select Control until desired cook or roast temperature is indicated by temperature display digits (from 140° to 500°F).
- D. To set "Hold" temperature (NOTE: Hold is not required unless desired as part of a cook or roast process): Depress keypad labeled "Hold".
- E. Rotate Temperature Select Control until desired holding temperature is indicated by temperature display digits (from 140° to 250°F).

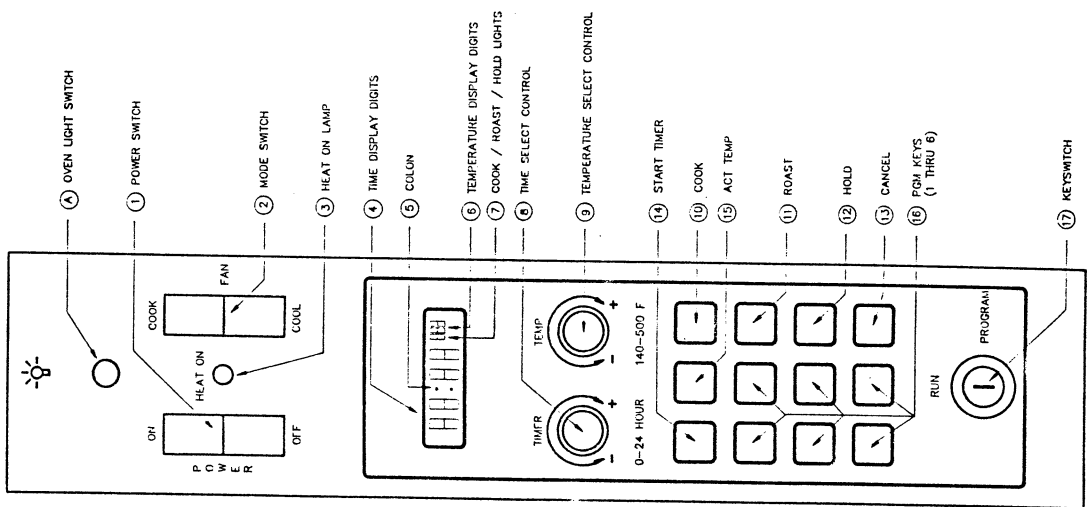

Free Manuals Download Website

<http://myh66.com>

<http://usermanuals.us>

<http://www.somanuals.com>

<http://www.4manuals.cc>

<http://www.manual-lib.com>

<http://www.404manual.com>

<http://www.luxmanual.com>

<http://aubethermostatmanual.com>

Golf course search by state

<http://golfingnear.com>

Email search by domain

<http://emailbydomain.com>

Auto manuals search

<http://auto.somanuals.com>

TV manuals search

<http://tv.somanuals.com>