



# INSTALLATION, OPERATING & SERVICE INSTRUCTIONS FOR THE GARLAND ELECTRIC XPRESS GRILL, MODELS XE24, XE36



### FOR YOUR SAFETY

DO NOT STORE OR USE GASOLINE OR OTHER  
FLAMMABLE VAPORS OR LIQUIDS IN THE  
VICINITY OF THIS OR ANY OTHER APPLIANCE.

### WARNING:

IMPROPER INSTALLATION, ADJUSTMENT,  
ALTERATION, SERVICE OR MAINTENANCE CAN  
CAUSE PROPERTY DAMAGE, INJURY OR DEATH.  
READ THE INSTALLATION, OPERATION AND  
MAINTENANCE INSTRUCTIONS THOROUGHLY  
BEFORE INSTALLING OR SERVICING  
THIS EQUIPMENT.

PLEASE READ ALL SECTIONS OF THIS MANUAL AND RETAIN FOR FUTURE REFERENCE.

THIS PRODUCT HAS BEEN CERTIFIED AS COMMERCIAL COOKING EQUIPMENT AND MUST BE INSTALLED BY PROFESSIONAL PERSONNEL AS SPECIFIED.

#### *For Your Safety:*

Post in a prominent location, instructions to be followed in the event the user smells gas. This information shall be obtained by consulting your local gas supplier.



Users are cautioned that maintenance and repairs must be performed by a Garland authorized service agent using genuine Garland replacement parts. Garland will have no obligation with respect to any product that has been improperly installed, adjusted, operated or not maintained in accordance with national and local codes or installation instructions provided with the product, or any product that has its serial number defaced, obliterated or removed, or which has been modified or repaired using unauthorized parts or by unauthorized service agents. For a list of authorized service agents, please refer to the Garland web site at <http://www.garland-group.com>. The information contained herein, (including design and parts specifications), may be superseded and is subject to change without notice.

Continuous product improvement is a Garland policy, therefore design and specifications are subject to change without notice.

**GARLAND COMMERCIAL INDUSTRIES**  
185 East South Street  
Freeland, Pennsylvania 18224  
Phone: (570) 636-1000  
Fax: (570) 636-3903

**GARLAND COMMERCIAL RANGES,  
LTD.**  
1177 Kamato Road, Mississauga, Ontario L4W 1X4  
CANADA  
Phone: 905-624-0260  
Fax: 905-624-5669

**Enodis UK LTD.**  
Swallowfield Way, Hayes, Middlesex UB3 1DQ ENGLAND  
Telephone: 081-561-0433  
Fax: 081-848-0041

---

## INTRODUCTION

---

 **GARLAND**<sup>®</sup>

**Xpress grill**

The Garland Xpress Grill provides a method for efficient two-sided cooking, while accommodating a variety of products. The unit will also serve as a flat grill, and meets all standards for safety, efficiency, and cleanliness.

### Standard Features:

- Stainless steel front, top & sides
- 4.3kW input for each twelve-inch section of griddle
- 208V/240V, three phase or 400V, three phase top heaters
- ¾" thick, Carbon steel griddle plate, machine ground, highly polished
- Swivel casters complete with front brakes (4)
- Die cast aluminum electric top heating elements rated 208V, 240V or 400V
- Automatic lifting and lowering top heaters
- Towel bar with bun pan lip
- Stainless steel dual side grease collectors
- Separate programmable controller for each twelve-inch section
- Multi-colored LED indicator lights to identify operational mode
- One year limited parts and labor warranty (USA & Canada)



---

# TABLE OF CONTENTS

---

<b>Introduction.....</b>	<b>2</b>	To Change a Product Name:.....	19
Standard Features: .....	2	<i>System Info</i>	
<b>Dimensions &amp; Specifications, XE18.....</b>	<b>4</b>	To View Recovery Time - Upper Platen: .....	19
<b>Dimensions &amp; Specifications, XE24 .....</b>	<b>5</b>	To View Recovery Time - Grill: .....	19
<b>Safety Precautions.....</b>	<b>6</b>	To View the Garland Part Number: .....	20
<b>Installation.....</b>	<b>7</b>	To View the Flash Number: .....	20
National Codes Requirements: .....	7	To View the Software Number: .....	20
Electrical Connections: .....	8	To View the Download Number: .....	20
<b>Grill Controls .....</b>	<b>8</b>	<i>System Setup</i>	
Master Power Switch: .....	8	To Change temperature Units, (°F or °C): .....	21
Indicator Lights:.....	8	To Change Gap Setting Display Units: .....	21
Display: .....	8	To Change the Alarm Volume: .....	21
Gap Setting Buttons (1-5): .....	8	To Change Probe Calibration - Upper: .....	21
Gap Button: .....	8	To Change Probe Calibration - Grill:.....	22
Power Button: .....	9	To Change Platen Set:.....	22
Program Button: .....	9	To Change Instant-On Time: .....	22
Temperature Button:.....	9	To Change Control Type: .....	23
Up/Down Arrow Buttons; 2 Functions: .....	9	To Turn Extended Time On/Off: .....	23
Enter Button: .....	9	To Change the Grill Function:.....	23
Cancel/Raise Platen Button, (Green): .....	9	To Change the Start Delay:.....	23
Black Button: .....	9	To Change the Alarm Mode: .....	24
<b>Operation .....</b>	<b>10</b>	To Turn Clean Mode On/Off: .....	24
Installing Release Material: .....	10	<i>Service Mode</i>	
Lighting Instructions: .....	11	To Change SCK Address:.....	24
To Cook in Two-Sided Mode:.....	11	To Perform Limit Switch Test: .....	25
To Perform and Additional Cook Cycle:.....	11	<i>Gap Button</i>	
To Cook in Flat Grill Mode:.....	11	To Change Gap Setting: .....	25
Enter Standby Mode: .....	12	<b>Calibration.....</b>	<b>26</b>
Exit Standby Mode: .....	12	Bi-Weekly Calibration:.....	26
To Display the Current Temperatures:.....	12	Probe Locations: .....	27
To View Settings for a Menu Item: .....	12	<b>Troubleshooting.....</b>	<b>28</b>
To Clean the Grill:.....	12	<i>Error Messages</i>	
<b>Cleaning &amp; Maintenance.....</b>	<b>13</b>	PROBE ERROR:.....	28
Cleaning During Operation:.....	13	PLATEN DOWN ERROR:.....	28
Daily Cleaning:.....	13	PLATEN UP ERROR:.....	28
Platen Zeroing:.....	14	HEATING ERROR:.....	28
<b>Programming.....</b>	<b>16</b>	COMM ERROR: .....	28
Programming Modes/Menu Sequence: .....	16	MOTOR OVER CURRENT: .....	28
<i>Menu Items</i>		MOTOR ERROR: .....	28
To Change the Cook Time of a Product: .....	18	<b>Wiring Diagrams .....</b>	<b>29</b>
To Turn Platen, (2-Sided), Cooking On/Off: .....	18		
To Change Upper Platen Set Temperature:.....	18		
To Change Grill Set Temperature:.....	18		

# DIMENSIONS AND SPECIFICATIONS, MODEL XE24

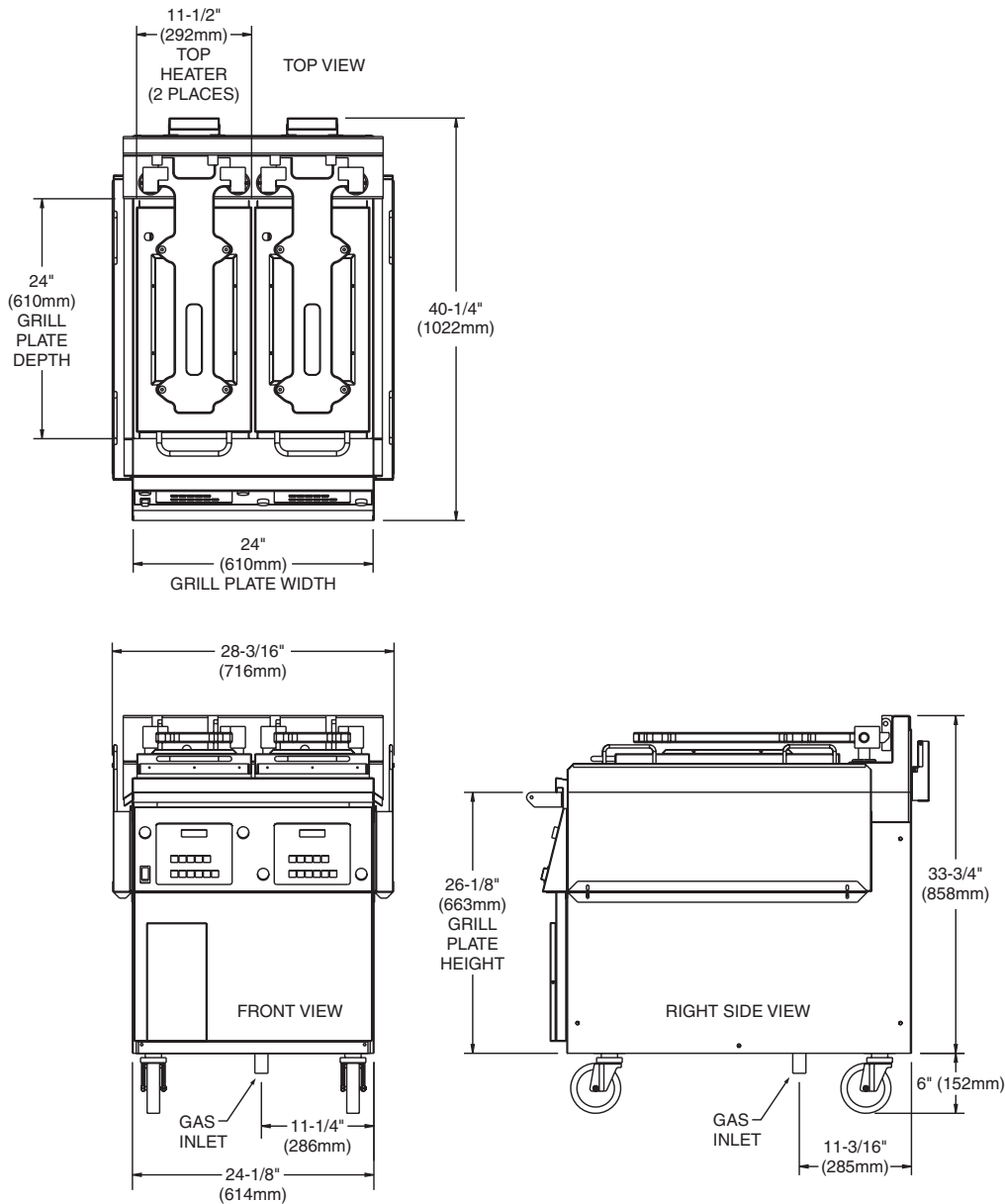

Model	Loading kW Per Phase				Nominal Amps Per Line								
	208/220/240V 3-Phase				208V 3-Phase Delta			220V 3-Phase Delta			240V 3-Phase Delta		
	*	X-Y	X-Z	Y-Z	X	Y	Z	X	Y	Z	X	Y	Z
XE24	TB1	3.67	4.00	3.67	32.03	30.70	32.03	30.28	29.02	30.28	27.76	26.60	27.76
	TB2	1.84	1.84	1.84	15.43	15.43	15.43	14.60	14.60	14.60	13.38	13.38	13.38
	CAN	5.51	5.84	5.51	47.46	46.13	47.46	44.88	46.62	44.88	41.14	39.98	41.14

\* TB1 and TB2 are for dual supply units for the USA only.

CAN is for single supply units, typically used in Canada only.

Clearances			
Entry		Installation	
Crated	Uncrated	Sides	Rear
47-1/2" (1207mm)	32" (813mm)	6" (152mm)	3" (76mm)

# DIMENSIONS AND SPECIFICATIONS, MODEL XE36

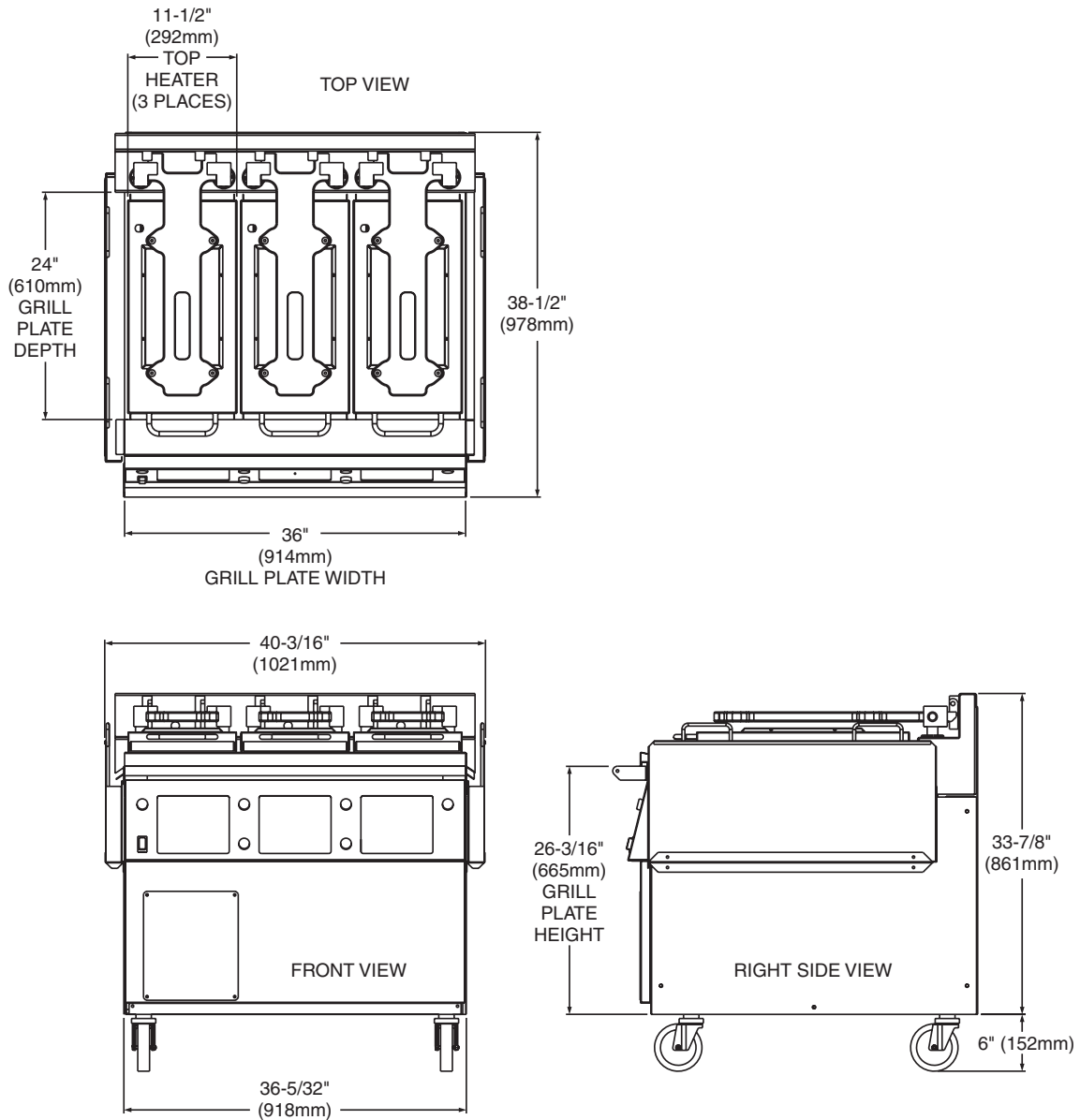

Model	Loading kW Per Phase				Nominal Amps Per Line								
	208/220/240V 3-Phase				208V 3-Phase Delta			220V 3-Phase Delta			240V 3-Phase Delta		
	*	X-Y	X-Z	Y-Z	X	Y	Z	X	Y	Z	X	Y	Z
XE24	TB1	5.53	6.01	5.53	48.04	46.04	48.04	45.42	46.53	45.42	41.64	39.90	41.64
	TB2	2.78	2.78	2.78	23.14	23.14	23.14	21.88	21.88	21.88	20.06	20.06	20.06
	CAN	8.31	8.79	8.31	71.18	69.18	71.18	67.30	65.41	67.30	61.70	59.96	61.70

\* TB1 and TB2 are for dual supply units for the USA only.

CAN is for single supply units, typically used in Canada only.

Clearances			
Entry		Installation	
Crated	Uncrated	Sides	Rear
47-1/2" (1207mm)	32" (813mm)	6" (152mm)	3" (76mm)

---

## SAFETY PRECAUTIONS

---

Always follow these safety precautions when operating the Xpress Grill.

- **THIS GRILL MUST** be operated by persons who have been given adequate training.
- **THIS EQUIPMENT MUST ONLY BE OPERATED UNDER AN APPROVED HOOD SYSTEM.**
- **DO NOT** operate the grill without reading this operation manual.
- **DO NOT** operate the Xpress grill unless all service and access panels are in place and fastened properly.

The Garland Xpress Grill is a semi-automatic cooking appliance. The upper platen is lowered automatically, following the manual, two-handed initiation of the cooking cycle, and the upper platen is raised automatically upon completion of the cooking cycle.

When two sided cooking, the area between the upper platen and the griddle plate should be regarded as a “danger zone.” During two sided cooking the operator must not be within this danger zone. When used as a flat grill, then this area is no longer a danger zone, the platens do not move.

For whatever reason, be it cleaning, maintenance, or normal operation, any exposed person must use extreme caution if within this danger zone.

In two side cooking the upper platen remains in the lowered position by nature of its own weight. It is not locked down. It can be raised by lifting up on the handle on the front of the platen.

The Xpress Grill may during its operation emit airborne noise equivalent to a continuous A weighted sound pressure level of 73dB(A).

**WARNING: To avoid serious personal injury:**

- **DO NOT** attempt to repair or replace any part of the Xpress Grill unless all main power supplies to the grill have been disconnected.
- **USE EXTREME CAUTION** in setting up, operating and cleaning the Xpress Grill to avoid coming in contact with hot grill surfaces or hot grease. Suitable protective clothing should be worn to prevent the risk of burns.
- **DO NOT** clean this appliance with a water jet.
- **DO NOT** apply **ICE** or **COLD WATER** to a **HOT** grill surface.
- **NOTE** all warning labels and markings affixed to the grill.

**WARNING:** After turning the master power switch to the **START** position, the grill will go through initialization. If the upper platens are in the lowered position they will return to their raised upper position. This movement takes approximately 8 seconds.

---

# INSTALLATION

---

**IMPORTANT:** Rating plates for this appliance are located in two places: 1) inside back panel on left side, 2) under front control panel on center.

This equipment must be installed by a competent factory trained, certified, licensed and / or authorized service or installation person.

**WARNING:** This appliance must be properly grounded.

Prior to installation, the four casters, supplied loose with the grill, must be securely located on the underside of the base. The casters fitted with a brake must be located at the front of the grill.

This appliance should be connected to a potential equalization system. A labeled equipotential bonding point is fitted to the rear of the grill.

It is recommended that this grill be connected to a residual current, (earth leakage), device with a tripping current not exceeding 30mA. The leakage current of this grill will not exceed 5mA.

**CAUTION:** Prior to installation, check the electrical supply to ensure input voltage and phase match the equipment voltage rating and phase. See data plate located rear left side of grill and lower front panel.

Grill is to be located directly under ventilation system.

Once installed in the grill station underneath the ventilation system, the platens, in their highest position, must not interfere with the lower lip of the ventilation system hood. The raised position of each platen is adjusted by raising or lowering the upper of the two microswitches, (limit switches), in the rear of the grill. The lower microswitch position must not be adjusted.

Grill plate must be level front to back, side to side and diagonally. This leveling must be done with the unit under the hood and in it's normal operational position to prevent warping of the grill plate.

**NOTE:** Fuses are installed to prevent damage in the event of failure of the upper microswitch.

## National Codes Requirements:

In Canada, electrical connection must comply with applicable sections of the Canadian Electrical Code, C22.1 - 1990, latest edition, "Safety Standard for Installation, Part 1" and C22.2- No. O-M 1982 latest edition, "General Requirements, Part 2".

## Electrical Connections:

All electrically operated appliances must be electrically grounded in accordance with local codes; or in the absence of local codes, with the latest edition of National Wiring Regulations. A wiring diagram is located on the rear panel of the grill. See rating plate in rear of grill, or lower front panel for proper voltages.

---

# GRILL CONTROLS

---

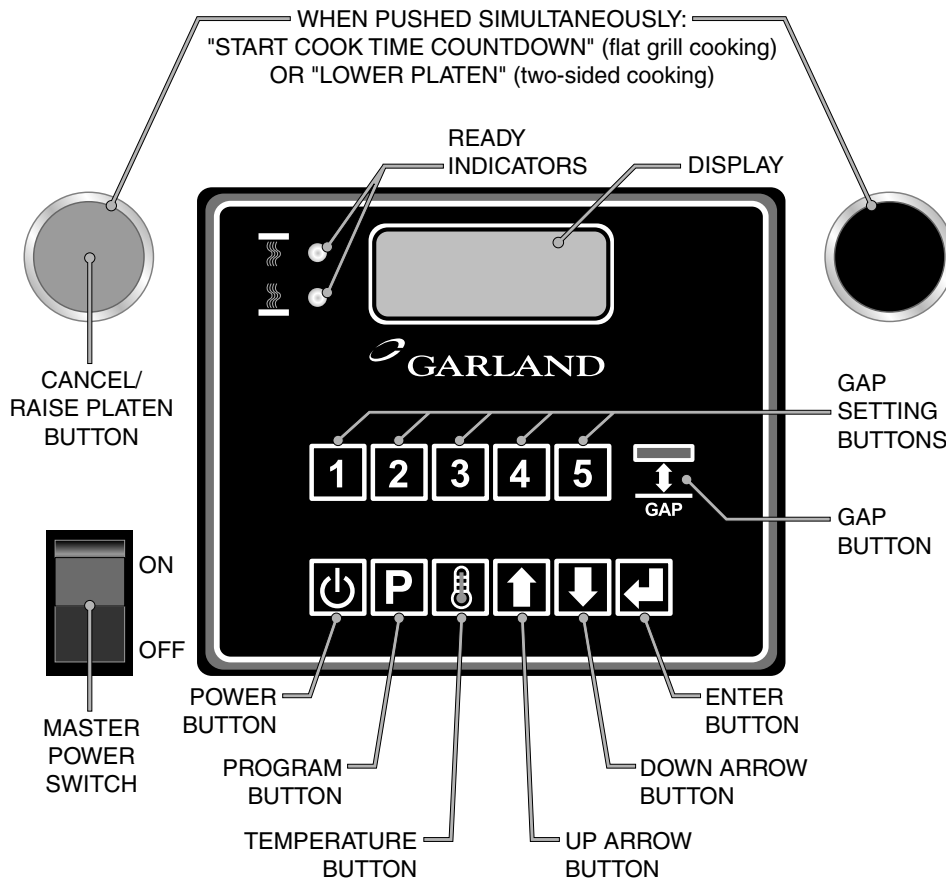

## Master Power Switch:

Controls power to the grill and must be turned "ON" to start operation. The controller display will be active when the switch is "ON".

## Indicator Lights:

There are two, (2), indicator lights, indicating the temperature status of each control's heat zones; one, (1), on the upper platen, (top light), and one, (1), on the grill surface. Each light can display three, (3), different colors, indicating temperature status for the corresponding zone.

**Red:** The zone is too hot, (more than 79°F/45°C over the set temperature), or heat zone failure.

**Amber:** The zone is calling for heat.

**Green:** The zone is at or above the set temperature.

## Display:

The controller display will contain information relevant to each operation in both cook and program modes.

## Gap Setting Buttons (1-5):

For two-sided recipes, the desired gap button is pressed before the cook cycle begins to set the gap. Hold buttons 1-5 to apply gap settings 6-10. The chosen gap button and its value will be displayed. Until a different menu item is selected, (or the current item is changed and then returned to), the Gap Button only needs to be pressed before the initial cook.

## Gap Button:

When in programming mode, press the Gap Button to set the values for Gap Buttons 1-10. Press Enter to accept the changes. After going through all ten, you will return to Programming Mode.



---

## GRILL CONTROLS continued

---

### **Power Button:**

---

After the main power switch is turned on, this button will put the control into cook mode. If pressed again, the control will go back to displaying "OFF."

### **Program Button:**

---

The primary function is to access Programming and Calibration of the grill. Push and hold for five (5) seconds. Display will ask for the code. After entering code, four programming features will be accessible "MENU ITEMS," "SYSTEM INFO," "SYSTEM SETUP," and "SERVICE MODE."

### **Temperature Button:**

---

In the Cook mode, each time the button is pressed the current temperature for one zone will be displayed. The grill temperature is displayed first followed by the platen temperature. After five (5) seconds, the display will return to the menu item selected.

### **Up/Down Arrow Buttons; 2 Functions:**

---

1. In the cook mode, the Up/Down Arrow Buttons will cycle through the different menu items.
2. In the program mode, the Up/Down Arrow Buttons will change the value of the current setting.

### **Enter Button:**

---

Function is to accept programming steps.

### **Cancel/Raise Platen Button, (Green):**

---

During the cooking cycle, pressing this button will cancel the cooking timer and return the grill to the "IDLE" mode. This button will also bring the grill out of STANDBY.

### **Black Button:**

---

When both Black and Green "CANCEL/RAISE" buttons are pressed simultaneously, the upper platen will lower to the griddle surface.

# OPERATION

## Installing Release Material:

Slide release material rod through hemmed end of the release material sheet.

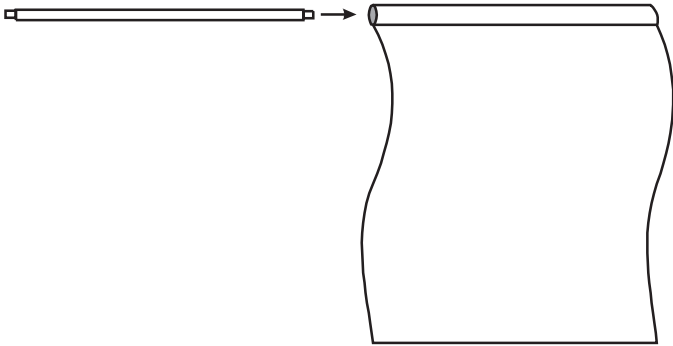

Hook release material rod on brackets located at the rear of the upper plate

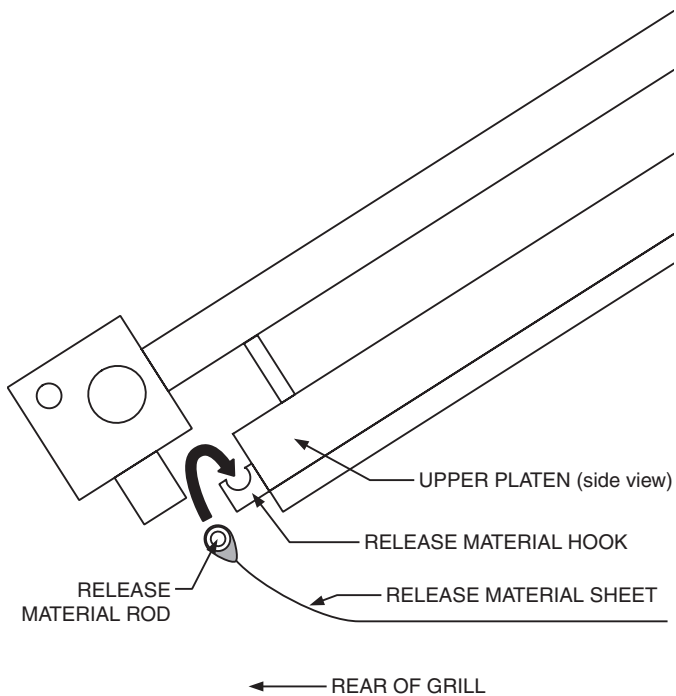

Holding the bottom of the release material sheet in place, gently pull the sheet toward the front of the platen.

Thread the front edge of the release material sheet behind the release material bar on the front of the platen, then

around the top and down over the front of the bar as shown.

Place locking clips over release material sheet and press into place over release material bar.

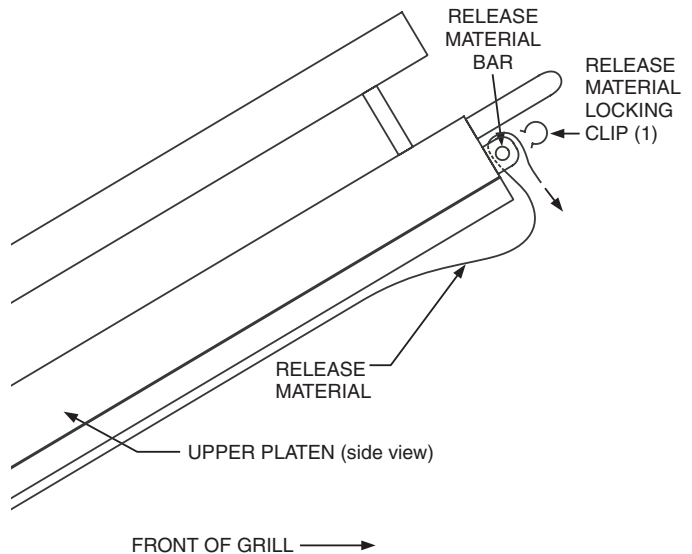

Check alignment and tightness of release material against upper platen.

NOTE: Make sure release material fits smoothly over upper platen. Installing release material sheets too tight may cause premature failure of the sheet.

Release sheets are reversible and should be flipped over and reattached on a daily basis. For instructions on cleaning release sheets, see Step 17., at top of Page 15.

**A release material sheet must be replaced when:**



- Product sticks to release material.
- Carbon build-up causes problems in taste or appearance.
- Tearing occurs in the sheet's cooking area.
- Release material coating is worn off sheet.

---

## OPERATION continued

---

### To Cook in Two-Sided Mode:

1. Select a menu item by pressing  or  until the desired menu item is displayed. Press the Gap Setting Number desired for the selected item, (Gap Buttons 1-5, or hold for 6-10). The display may read either "TOO COOL" or "TOO HOT," (alternating with the 'MENU ITEM'), until the grill attains the set temperature range for that menu item, then the "MENU ITEM," and the gap setting alternating with the Gap Button number will be displayed.

**NOTE: If the display reads either "TOO COOL" or "TOO HOT" the upper platen will not lower and initiate a cooking sequence.**

2. After loading the grill with product, press the GREEN, ('CANCEL/RAISE'), and the BLACK buttons at the same time. An audible alert will sound and the platen will lower to the preset gap and the timing will automatically start.
3. When the cook timer reaches one, (1), second remaining, a pre-time-out alarm will sound to alert the grill operator.
4. When the cooking time has been completed, "PRODUCT NAME" and "REMOVE" will be displayed with an audible alert. Cooking is complete. Remove product.
5. To cancel a cooking cycle, press and hold the GREEN ('CANCEL/RAISE') button. The upper platen will rise. The display will flash "CANCEL" with an audible alert.

### To Perform an Additional Cook Cycle:

The Krystal Xpress Grill is capable of performing two different cook cycles in the same cooking zone.

**NOTE:** In order to perform an additional cook cycle, the initial cook cycle time remaining must be greater than 45 seconds. If the time remaining is less than 45 seconds, the platen will only rise at the end of the cycle, or when the GREEN/CANCEL button is pressed.

1. Provided the initial cook time is greater than 45 seconds, press the BLACK button to raise the platen.
2. Add additional product.
3. Press both the GREEN and BLACK buttons to lower the platen and continue the initial cook cycle and begin the additional cook cycle. Both cook times will be displayed on the controller.

**NOTE:** If both the GREEN and BLACK buttons are not pressed within 25 seconds to resume cooking, BOTH cook cycles will be canceled and the grill will return to idle mode.



4. When the initial cook cycle is completed, the platen will automatically rise and the alarm will sound. Remove the product from the initial cook.
5. Press both the GREEN and BLACK buttons to resume cooking.

**NOTE:** If both the GREEN and BLACK buttons are not pressed within 25 seconds after the initial cook cycle ends, the cook cycle(s) will be canceled and the grill will return to idle mode.

6. When the additional cook cycle ends, the platen will rise. Remove the product.

**NOTE:** If only the GREEN button is pressed anytime during cook cycles, BOTH/ALL cook cycles will be canceled, the platen will rise (if down), and the grill will return to idle.

### To Cook in Flat Grill Mode:

1. Select a menu item by pressing  or  until the desired menu item is displayed. The display may read either "TOO COOL" or "TOO HOT," (alternating with the 'MENU ITEM'), until the grill attains the set temperature range for that menu item
2. After loading the grill with product, press the GREEN, (CANCEL/RAISE), and the BLACK

---

## OPERATION continued

---



buttons at the same time, starting the cooking time countdown.

**NOTE: If the display reads either “TOO COOL” or “TOO HOT” the controller will not initiate a cooking sequence.**

3. Perform the required functions as they are displayed, i.e.; sear, turn. To cancel the audible alerts, press the BLACK button.

**CAUTION: Pressing the GREEN (‘CANCEL/RAISE’) button will cancel the cooking cycle, and pressing any other button on the controller will cancel the alarm.**

4. When the cooking time has been completed, the “PRODUCT NAME” and “REMOVE” will be displayed with an audible alert. Cooking is complete. Remove product. **Enter Standby Mode:**

1. Select Standby Mode by pressing  or  until “STANDBY” is displayed.

**NOTE: If the display reads either “TOO COOL” or “TOO HOT” the upper platen will not go into Standby Mode.**

2. Press the GREEN (‘CANCEL/RAISE’) and the BLACK buttons at the same time. As soon as the upper platen moves down, the display will read “STANDBY MODE.”

### Exit Standby Mode:

1. Press the GREEN (‘CANCEL/RAISE’) button. The upper platen will raise and the display will read “CANCEL” with an audible alarm.

### To Display the Current Temperatures:





1. Press the  button and repeat for each zone to be displayed...

1st press - LOWER GRILL ZONE





2nd press - UPPER PLATEN

**NOTE: The temperatures may be displayed at any time, including during a cooking cycle.**

### To View Settings for a Menu Item:

1. Enter Programming; Menu Items, (see Programming)
2. Press  to enter “PROGRAMMING MODE MENU ITEMS”
3. Use  and  to choose the desired Menu Item.
4. Press  to scroll through the settings for the chosen item.

### To Clean the Grill:

1. Press the  or  button to obtain the menu item “CLEAN MODE.” The temperature is also displayed.
2. Press  to acknowledge that Clean Mode is desired. This will cause the appliance, (grill and platen, if selected), to heat to the Clean Temperature.
3. “READY TO CLEAN” will be displayed when the grill is at the proper cleaning temperature and an audible alarm will sound.
4. Press . The temperature control and platen will be turned off and the display will show “CLEANING.”
5. To exit Cleaning Mode, Press . The Display will show “OFF.”

When cleaning is completed, you may turn the “MASTER POWER” (rocker) switch off.

---

## OPERATION continued

---

### PLATEN SET:

This function allows the platen to be moved up or down once it is parallel to the grill surface. Values range from -160 to +160.



### EXTENDED TIME:

This option will add 6, 4 and 2 seconds to the time of the next three cooks respectively if the grill has had no activity for 5 minutes. Provided the temperature is not 25°F above set temperature for either the grill or the platen.

### INSTANT ON TIME:

This can be set in the range of 00:00 to 00:40. Instant on will turn on the heat zone(s) as soon as a cook cycle starts.

### START DELAY:

This number is how long the operator must hold the GREEN ('CANCEL/RAISE') and BLACK buttons to start a cooking cycle for 2-sided recipes only. There will be one beep when the cook is started and another beep when the START DELAY time is reached. If the GREEN ('CANCEL/RAISE') and BLACK buttons are released before that time the cook will be canceled. If Yes is toggled press enter to allow the user to pick from 1 to 5 seconds in 0.5 second increments using  and .

---

## CLEANING AND MAINTENANCE

---





### Cleaning During Operation:

1. After each product load is removed, Use a grill scraper to scrape grease on lower grill plate from front to back only. Do not scrape left to right across the lower grill plate with the grill scraper.
2. Use a grill squeegee to clean release material sheet on upper platen in a downward motion. Do not press hard against the release material sheet to prevent scratching or tearing.
3. Push the grease to the rear of the grill, or pull it to the front trough. Then, squeegee the grease into the buckets on either side. Do not use the scraper for this step.
4. Use a clean, damp cloth to clean back splash and bullnose areas as needed during operation.

**Note:** To increase life of release material sheets, wipe them down with a folded clean, damp cloth at least four times during each hour of operation.

### Daily Cleaning:

**Warning:** The upper platen surface and edges are very hot! To prevent burn injuries, use extreme caution when wiping down release sheets and platen edges.

1. Press the  or  button to obtain the menu item "CLEAN MODE."
2. Press  to acknowledge that Clean Mode is desired. This will cause the appliance (grill and platen, if selected) to heat to the Clean Temperature.
3. "READY TO CLEAN" will be displayed when the grill is at the proper cleaning temperature and an audible alarm will sound.
4. To exit Cleaning Mode, press . The Display will show "OFF."
5. Wearing protective gloves, empty and replace the grease troughs.
6. Wipe down the exposed surface of the release sheet with a clean, damp cloth.

---

## CLEANING AND MAINTENANCE *continued*

---

- Remove the release sheet locking clips and bars.
- Scrape only the lower grill surface with a grill scraper, and squeegee any residue into the grease troughs with a grill squeegee.

**Caution: Do not scrape or otherwise scratch the upper platens. The use of metal scrapers, abrasive pads, or wire brushes will permanently damage the surface of the upper platens.**

- Open one packet of high-temperature grill cleaner, (several cleaners may be available on the market), and empty the contents into a suitable container. (One packet will clean one grill.)
- Firmly attach a no-scratch pad to a pad holder.
- Dip the no-scratch pad into the grill cleaner, and spread a light coating of grill cleaner over the entire platen surface, back, front, and side edges of both upper platens. **DO NOT SCRUB.**
- After applying the grill cleaner, lightly scrub the platen surfaces, **BACK, FRONT AND SIDE EDGES** with the no-scratch pad until all the soil has been liquefied by the grill cleaner. For stubborn soils, apply additional grill cleaner and lightly scrub. **DO NOT RINSE THE PLATENS AT THIS TIME.**
- Starting at the back of the lower grill, spread a light coating of grill cleaner over the entire surface. **DO NOT SCRUB.**
- After applying the grill cleaner, lightly scrub the grill surface with the No-Scratch Pad until all the soil has been liquefied.
- Rinse the upper platens with a dripping wet cloth.
- Carefully pour small quantities of lukewarm water onto the grill while brushing the surface, backsplash, and bullnose with a pot brush or equivalent high-temperature brush. Continue until the water no longer boils away and the grill remains wet. Squeegee dry.

**Caution: Ice, cold water, or large quantities of water must never be applied to the grill plate or upper platen. Severe damage to the grill will occur!**

- Clean the release sheets as follows:
  - Place the sheets on the lower grill. Scrub both sides of the sheets with the same no-scratch pad used on the grill.
  - Rinse both sides of the sheets with a clean, wet cloth.
- Rinse the lower grill by flooding the surface twice with lukewarm water. Squeegee after each rinse.
- Wipe the lower grill surface, backsplash, bullnose, and hood with a clean, damp cloth.
- When cleaning is completed, you may turn the "MASTER POWER" (rocker) switch off.

**AFTER CLEANING**, apply a thin coat of fresh shortening to the lower grill surface only. Wipe down the surrounding areas. Empty, wash, rinse, and replace the grease troughs.

---

### Platen Zeroing:

---

Turn Master power switch "ON", wait for controllers to display "OFF".

- Press and hold **P** for three, (3) seconds. "ENTER CODE" will be displayed.
- Using the Gap Setting buttons, **1 2 3 4 5** enter the code, (1251). "ENTER CODE \*\*\*\*" will be displayed.
- Press **↵** to enter the Programming Mode. "PROGRAMMING MODE MENU ITEMS" will be displayed.
- Press **↑** two, (2) times in succession to display "PROGRAMMING MODE SYSTEM SETUP."
- Press **↵** six, (6) times. "PLATEN SET +/- XX" will be displayed. (XX=numbers that will vary from grill to grill.)

---

## CLEANING AND MAINTENANCE *continued*

---

6. Allow time for grill to heat and turn ready. Press both the Cancel (Green) and Standby (Black) buttons simultaneously to lower the upper platen. Press the Cancel (Green) button to raise the platen. Now, press both the Cancel (Green) and (Black) Buttons to re-lower the platen.
7. Remove platen adjuster caps from all four adjustment points on each platen. Remove the four locking caps from the adjustment points.
8. Using the adjusting tool lower platen until adjusting tool touches the arm assembly.
9. With gapping tool, adjust right rear of platen until the gapping tool fits snugly between the upper platen and grill surface.
10. Move next to the left front adjuster and raise the platen until the gapping tool fits snugly between the upper platen and grill surface.
11. Next go to the left rear adjuster and raise the platen until the gapping tool fits snugly between the upper platen and grill surface.
12. Move next to the right front adjustment and raise the platen until the gapping tool fits snugly between the upper platen and grill surface.
13. Repeat steps 9-12 one or more times until gapping tool fits snugly between the upper platen and grill surface at all four adjustment points without further adjustment. (See diagram below.)
14. Replace the platen adjuster locking caps “hollow side down” and tighten snugly. Replace platen adjuster caps.
15. Repeat steps 9-14 for each platen.

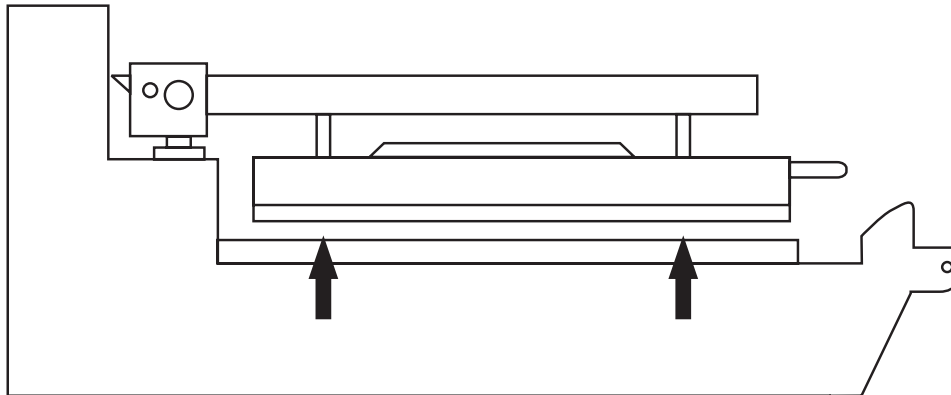

Insert gap tool directly below platen adjusters.





# PROGRAMMING continued

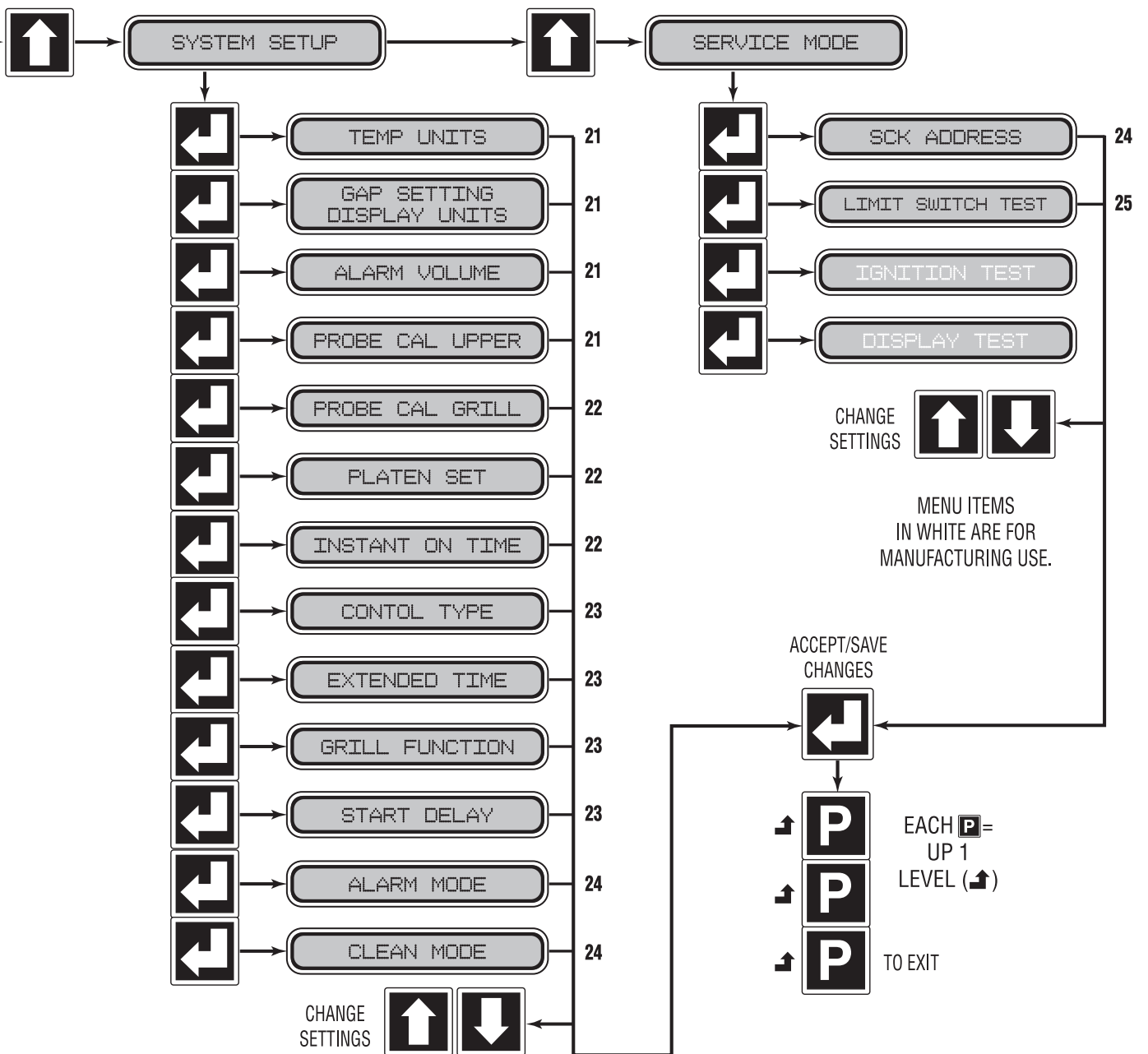
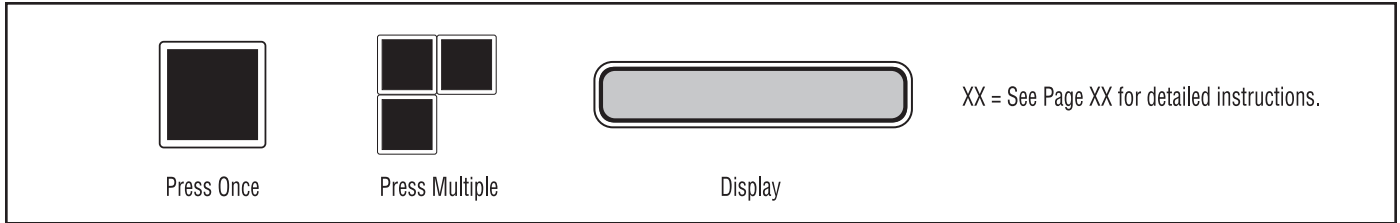

---

## PROGRAMMING continued

---

### *Menu Items...*

#### To Change the Cook Time of a Product:

1. Press and hold **P** for three, (3) seconds. "ENTER CODE" will be displayed.
2. Using the Gap Setting buttons, **1 2 3 4 5** enter the code, (1251). "ENTER CODE \*\*\*\*" will be displayed.
3. Press **↵** to enter the Programming Mode. "PROGRAMMING MODE MENU ITEMS" will be displayed.
4. Press **↵**. "MENU ITEMS STANDBY" will be displayed.
5. Use **↑** and **↓** to choose the desired Menu Item.
6. Press **↵** to display "(MENU ITEM) COOK TIME XX:XX"
7. Use **↑** and **↓** to adjust the cook time.
8. Press **↵** to save the changes.
9. Press **P** to return to "PROGRAMMING MODE MENU ITEMS"
10. Press **P** again to exit.

#### To Turn Platen, (2-Sided), Cooking On/Off:

1. Press and hold **P** for three, (3) seconds. "ENTER CODE" will be displayed.
2. Using the Gap Setting buttons, **1 2 3 4 5** enter the code, (1251). "ENTER CODE \*\*\*\*" will be displayed.
3. Press **↵** to enter the Programming Mode. "PROGRAMMING MODE MENU ITEMS" will be displayed.
4. Press **↵**. "MENU ITEMS STANDBY" will be displayed.
5. Use **↑** and **↓** to choose the desired Menu Item.
6. Press **↵** twice to display "(MENU ITEM) UPPER PLATEN YES/NO "
7. Use **↑** and **↓** to turn upper platen on or off.

8. Press **↵** to save the changes.
9. Press **P** to return to "PROGRAMMING MODE MENU ITEMS"
10. Press **P** again to exit.

#### To Change Upper Platen Set Temperature:

1. Press and hold **P** for three, (3) seconds. "ENTER CODE" will be displayed.
2. Using the Gap Setting buttons, **1 2 3 4 5** enter the code, (1251). "ENTER CODE \*\*\*\*" will be displayed.
3. Press **↵** to enter the Programming Mode. "PROGRAMMING MODE MENU ITEMS" will be displayed.
4. Press **↵**. "MENU ITEMS STANDBY" will be displayed.
5. Use **↑** and **↓** to choose the desired Menu Item.
6. Press **↵** three, (3) times to display "(MENU ITEM) UPPER TEMP XXX" displayed in °F or °C.
7. Use **↑** and **↓** to change the set temperature to the desired value.
8. Press **↵** to save the changes.
9. Press **P** to return to "PROGRAMMING MODE MENU ITEMS"
10. Press **P** again to exit.

#### To Change Grill Set Temperature:

1. Press and hold **P** for three, (3) seconds. "ENTER CODE" will be displayed.
2. Using the Gap Setting buttons, **1 2 3 4 5** enter the code, (1251). "ENTER CODE \*\*\*\*" will be displayed.
3. Press **↵** to enter the Programming Mode. "PROGRAMMING MODE MENU ITEMS" will be displayed.
4. Press **↵**. "MENU ITEMS STANDBY" will be displayed.

---

## PROGRAMMING continued

---

5. Use **↑** and **↓** to choose the desired Menu Item.
6. Press **↵** four, (4) times to display “(MENU ITEM) GRILL TEMP XXX” displayed in °F or °C.
7. Use **↑** and **↓** to change the set temperature to the desired value.
8. Press **↵** to save the changes.
9. Press **P** to return to “PROGRAMMING MODE MENU ITEMS”
10. Press **P** again to exit.

### To Change a Product Name:

1. Press and hold **P** for three, (3) seconds. “ENTER CODE” will be displayed.
2. Using the Gap Setting buttons, **1 2 3 4 5** enter the code, (1251). “ENTER CODE \*\*\*\*” will be displayed.
3. Press **↵** to enter the Programming Mode. “PROGRAMMING MODE MENU ITEMS” will be displayed.
4. Press **↵**. “MENU ITEMS STANDBY” will be displayed.
5. Use **↑** and **↓** to choose the desired Menu Item.
6. Press **↵** five, (5) times to display “PRODUCT NAME (CHOSEN ITEM)”
7. Use **↑** and **↓** to cycle through the available product names until the desired name is achieved.
8. Press **↵** to save the changes. You will automatically return to “PROGRAMMING MODE MENU ITEMS”.
9. Press **P** to exit.

### *System Info...*

#### To View Recovery Time - Upper Platen:

1. Press and hold **P** for three, (3) seconds. “ENTER CODE” will be displayed.
2. Using the Gap Setting buttons, **1 2 3 4 5** enter the code, (1251). “ENTER CODE \*\*\*\*” will be displayed.
3. Press **↵** to enter the Programming Mode. “PROGRAMMING MODE MENU ITEMS” will be displayed.
4. Press **↑** one, (1) time to display “PROGRAMMING MODE SYSTEM INFO.”
5. Press **↵** to view the upper recovery time. “RECOVERY UPPER XXXX” will be displayed.
6. Press **P** to return to “PROGRAMMING MODE SYSTEM INFO”.
7. Press **P** to exit.

#### To View Recovery Time - Grill:

1. Press and hold **P** for three, (3) seconds. “ENTER CODE” will be displayed.
2. Using the Gap Setting buttons, **1 2 3 4 5** enter the code, (1251). “ENTER CODE \*\*\*\*” will be displayed.
3. Press **↵** to enter the Programming Mode. “PROGRAMMING MODE MENU ITEMS” will be displayed.
4. Press **↑** one, (1) time to display “PROGRAMMING MODE SYSTEM INFO.”
5. Press **↵** two, (2), times to view the grill recovery time. “RECOVERY GRILL XXXX” will be displayed.
6. Press **P** to return to “PROGRAMMING MODE SYSTEM INFO”.
7. Press **P** to exit.

---

## PROGRAMMING continued

---

### To View the Garland Part Number:

---

1. Press and hold **P** for three, (3) seconds. "ENTER CODE" will be displayed.
2. Using the Gap Setting buttons, **1 2 3 4 5** enter the code, (1251). "ENTER CODE \*\*\*\*" will be displayed.
3. Press **↩** to enter the Programming Mode. "PROGRAMMING MODE MENU ITEMS" will be displayed.
4. Press **↑** one, (1) time to display "PROGRAMMING MODE SYSTEM INFO."
5. Press **↩** three, (3), times to view the Garland Part Number for the grill. "GARLAND PART # X...X" will be displayed. (number varies by grill).
6. Press **P** to return to "PROGRAMMING MODE SYSTEM INFO".
7. Press **P** to exit.

### To View the Flash Number:

---

1. Press and hold **P** for three, (3) seconds. "ENTER CODE" will be displayed.
2. Using the Gap Setting buttons, **1 2 3 4 5** enter the code, (1251). "ENTER CODE \*\*\*\*" will be displayed.
3. Press **↩** to enter the Programming Mode. "PROGRAMMING MODE MENU ITEMS" will be displayed.
4. Press **↑** one, (1) time to display "PROGRAMMING MODE SYSTEM INFO."
5. Press **↩** four, (4), times to view the Flash Number. "FLASH NUMBER X...X" will be displayed. (Flash number varies by grill).
6. Press **P** to return to "PROGRAMMING MODE SYSTEM INFO".
7. Press **P** to exit.

### To View the Software Number:

---

1. Press and hold **P** for three, (3) seconds. "ENTER CODE" will be displayed.
2. Using the Gap Setting buttons, **1 2 3 4 5** enter the code, (1251). "ENTER CODE \*\*\*\*" will be displayed.
3. Press **↩** to enter the Programming Mode. "PROGRAMMING MODE MENU ITEMS" will be displayed.
4. Press **↑** one, (1) time to display "PROGRAMMING MODE SYSTEM INFO."
5. Press **↩** five, (5), times to view the Software Number. "SOFTWARE NUMBER X...X" will be displayed. (number varies by grill).
6. Press **P** to return to "PROGRAMMING MODE SYSTEM INFO".
7. Press **P** to exit.

### To View the Download Number:

---

1. Press and hold **P** for three, (3) seconds. "ENTER CODE" will be displayed.
2. Using the Gap Setting buttons, **1 2 3 4 5** enter the code, (1251). "ENTER CODE \*\*\*\*" will be displayed.
3. Press **↩** to enter the Programming Mode. "PROGRAMMING MODE MENU ITEMS" will be displayed.
4. Press **↑** one, (1) time to display "PROGRAMMING MODE SYSTEM INFO."
5. Press **↩** six, (6), times to view the Download Number. "DOWNLOAD NUMBER X...X" will be displayed. (Download number varies by grill).
6. Press **P** to return to "PROGRAMMING MODE SYSTEM INFO".
7. Press **P** to exit.

---

## PROGRAMMING continued

---

### System Setup

#### To Change temperature Units, (°F or °C):

1. Press and hold **P** for three, (3) seconds. “ENTER CODE” will be displayed.
2. Using the Gap Setting buttons, **1 2 3 4 5** enter the code, (1251). “ENTER CODE \*\*\*\* ” will be displayed.
3. Press **↵** to enter the Programming Mode. “PROGRAMMING MODE MENU ITEMS” will be displayed.
4. Press **↑** two, (2) times. “PROGRAMMING MODE SYSTEM SETUP” is displayed.
5. Press **↵** to enter system setup. “TEMP DISPLAY FAHRENHEIT (or CELSIUS)” will be displayed.
6. Press **↓** to change the temperature units to either Fahrenheit or Celsius.
7. Press **↵** to save the changes.
8. Press **P** to return to “PROGRAMMING MODE SYSTEM SETUP”
9. Press **P** again to exit.

#### To Change Gap Setting Display Units:

1. Press and hold **P** for three, (3) seconds. “ENTER CODE” will be displayed.
2. Using the Gap Setting buttons, **1 2 3 4 5** enter the code, (1251). “ENTER CODE \*\*\*\* ” will be displayed.
3. Press **↵** to enter the Programming Mode. “PROGRAMMING MODE MENU ITEMS” will be displayed.
4. Press **↑** two, (2) times. “PROGRAMMING MODE SYSTEM SETUP” is displayed.
5. Press **↵** two, (2), times. “GAP SETTING DISPLAY INCHES (or MILLIMETERS)” will be displayed.
6. Press **↓** to change the Gap Setting Display units to either Inches or Millimeters.

7. Press **↵** to save the changes.
8. Press **P** to return to “PROGRAMMING MODE SYSTEM SETUP”
9. Press **P** again to exit.

#### To Change the Alarm Volume:

1. Press and hold **P** for three, (3) seconds. “ENTER CODE” will be displayed.
2. Using the Gap Setting buttons, **1 2 3 4 5** enter the code, (1251). “ENTER CODE \*\*\*\* ” will be displayed.
3. Press **↵** to enter the Programming Mode. “PROGRAMMING MODE MENU ITEMS” will be displayed.
4. Press **↑** two, (2) times. “PROGRAMMING MODE SYSTEM SETUP” is displayed.
5. Press **↵** three, (3), times. “ALARM VOLUME LOW (or HIGH)” will be displayed.
6. Use **↑** or **↓** to change the Alarm Volume to either Low or High.
7. Press **↵** to save the changes.
8. Press **P** to return to “PROGRAMMING MODE SYSTEM SETUP”
9. Press **P** again to exit.





#### To Change Probe Calibration - Upper:

1. Press and hold **P** for three, (3) seconds. “ENTER CODE” will be displayed.
2. Using the Gap Setting buttons, **1 2 3 4 5** enter the code, (1251). “ENTER CODE \*\*\*\* ” will be displayed.
3. Press **↵** to enter the Programming Mode. “PROGRAMMING MODE MENU ITEMS” will be displayed.
4. Press **↑** two, (2) times. “PROGRAMMING MODE SYSTEM SETUP” is displayed.
5. Press **↵** four, (4), times. “PROBE CAL – UPPER XXXF” will be displayed.

---











## PROGRAMMING continued

---

6. Use  or  to change the Probe Calibration to the correct temperature measured with a pyrometer.\*  
SEE CALIBRATION REQUIREMENTS
7. Press  to save the changes.
8. Press  to return to "PROGRAMMING MODE SYSTEM SETUP"
9. Press  again to exit.

### To Change Probe Calibration - Grill:

---

1. Press and hold  for three, (3) seconds. "ENTER CODE" will be displayed.
2. Using the Gap Setting buttons,  enter the code, (1251). "ENTER CODE \*\*\*\*" will be displayed.
3. Press  to enter the Programming Mode. "PROGRAMMING MODE MENU ITEMS" will be displayed.
4. Press  two, (2) times. "PROGRAMMING MODE SYSTEM SETUP" is displayed.
5. Press  five, (5), times. "PROBE CAL – GRILL XXXF" will be displayed.
6. Use  or  to change the Probe Calibration to the correct temperature measured with a pyrometer.\*  
SEE CALIBRATION REQUIREMENTS
7. Press  to save the changes.
8. Press  to return to "PROGRAMMING MODE SYSTEM SETUP"
9. Press  again to exit.

#### \*CALIBRATION REQUIREMENTS











The control software will beep to the user when it is appropriate to calibrate. The control will allow calibration provided the following conditions are met:

- Temperature is currently falling from a detected peak of 360°F or higher.
- Temperature is falling and has fallen 2°F from a detected peak that is within the 350-360°F range. (i.e. calibration would be allowed at 355°F if the achieved peak temperature was 357°F)

- Temperature is rising through the 350-360°F range as a result of a heat on pulse of less than 30 seconds.





### To Change Platen Set:

---

1. Press and hold  for three, (3) seconds. "ENTER CODE" will be displayed.
2. Using the Gap Setting buttons,  enter the code, (1251). "ENTER CODE \*\*\*\*" will be displayed.
3. Press  to enter the Programming Mode. "PROGRAMMING MODE MENU ITEMS" will be displayed.
4. Press  two, (2) times. "PROGRAMMING MODE SYSTEM SETUP" will be displayed.
5. Press  six, (6) times. "PLATEN SET +/- XX" will be displayed. (numbers will vary by grill)
6. Use  and  to change the Platen Set to the correct value.
7. Press  to save the changes.
8. Press  to return to "PROGRAMMING MODE MENU ITEMS"
9. Press  again to exit.

### To Change Instant-On Time:





---

1. Press and hold  for three, (3) seconds. "ENTER CODE" will be displayed.
2. Using the Gap Setting buttons,  enter the code, (1251). "ENTER CODE \*\*\*\*" will be displayed.
3. Press  to enter the Programming Mode. "PROGRAMMING MODE MENU ITEMS" will be displayed.
4. Press  two, (2) times. "PROGRAMMING MODE SYSTEM SETUP" will be displayed.
5. Press  seven, (7) times. "INSTANT ON TIME XX:XX" will be displayed. (numbers will vary by grill).

---















## PROGRAMMING continued

---

- Use  and  to change the Instant on Time to the desired value.
- Press  to save the changes.
- Press  to return to “PROGRAMMING MODE MENU ITEMS”
- Press  again to exit.







### To Change Control Type:







---

- Press and hold  for three, (3) seconds. “ENTER CODE” will be displayed.
- Using the Gap Setting buttons,  enter the code, (1251). “ENTER CODE \*\*\*\* ” will be displayed.
- Press  to enter the Programming Mode. “PROGRAMMING MODE MENU ITEMS” will be displayed.
- Press  two, (2) times. “PROGRAMMING MODE SYSTEM SETUP” will be displayed.
- Press  eight, (8) times. “CONTROL TYPE ELECTRIC (or GAS)” will be displayed. (type varies by grill).
- Use  and  to change Control Type to match the design of the grill.
- Press  to save the changes.
- Press  to return to “PROGRAMMING MODE MENU ITEMS”
- Press  again to exit.

### To Turn Extended Time On/Off:















---

- Press and hold  for three, (3) seconds. “ENTER CODE” will be displayed.
- Using the Gap Setting buttons,  enter the code, (1251). “ENTER CODE \*\*\*\* ” will be displayed.
- Press  to enter the Programming Mode. “PROGRAMMING MODE MENU ITEMS” will be displayed.

- Press  two, (2) times. “PROGRAMMING MODE SYSTEM SETUP” will be displayed.
- Press  nine, (9) times. “EXTENDED TIME NO (or YES)” will be displayed.
- Use  and  to turn Extended Time on or off.
- Press  to save the changes.
- Press  to return to “PROGRAMMING MODE MENU ITEMS”
- Press  again to exit.







### To Change the Grill Function:

---

- Press and hold  for three, (3) seconds. “ENTER CODE” will be displayed.
- Using the Gap Setting buttons,  enter the code, (1251). “ENTER CODE \*\*\*\* ” will be displayed.
- Press  to enter the Programming Mode. “PROGRAMMING MODE MENU ITEMS” will be displayed.
- Press  two, (2) times. “PROGRAMMING MODE SYSTEM SETUP” will be displayed.
- Press  ten, (10) times. “FUNCTION CLAMSHELL (or FLAT)” will be displayed.
- Use  and  to toggle between Flat mode and Clamshell mode.
- Press  to save the changes.
- Press  to return to “PROGRAMMING MODE MENU ITEMS”
- Press  again to exit.

### To Change the Start Delay:











---

- Press and hold  for three, (3) seconds. “ENTER CODE” will be displayed.
- Using the Gap Setting buttons,  enter the code, (1251). “ENTER CODE \*\*\*\* ” will be displayed.

---











## PROGRAMMING continued

---

3. Press  to enter the Programming Mode. "PROGRAMMING MODE MENU ITEMS" will be displayed.
4. Press  two, (2) times. "PROGRAMMING MODE SYSTEM SETUP" will be displayed.
5. Press  eleven, (11) times. "START DELAY YES (or NO)" will be displayed.
6. Use  and  to turn Start Delay on or off.
7. If Start Delay is On (YES), press  to display "DELAY TIME XX:XX"
8. Use  and  to set the Delay Time to the desired value.
9. Press  to save the changes.
10. Press  to return to "PROGRAMMING MODE MENU ITEMS"
11. Press  again to exit.











### To Change the Alarm Mode:

---

1. Press and hold  for three, (3) seconds. "ENTER CODE" will be displayed.
2. Using the Gap Setting buttons,  enter the code, (1251). "ENTER CODE \*\*\*\*" will be displayed.
3. Press  to enter the Programming Mode. "PROGRAMMING MODE MENU ITEMS" will be displayed.
4. Press  two, (2) times. "PROGRAMMING MODE SYSTEM SETUP" will be displayed.
5. Press  twelve, (12) times. "ALARM MODE AUTO (or MANUAL)" will be displayed.
6. Use  and  to change the Alarm Mode to either Auto or Manual.
7. Press  to save the changes.
8. Press  to return to "PROGRAMMING MODE MENU ITEMS"
9. Press  again to exit.

### To Turn Clean Mode On/Off:









---

1. Press and hold  for three, (3) seconds. "ENTER CODE" will be displayed.
2. Using the Gap Setting buttons,  enter the code, (1251). "ENTER CODE \*\*\*\*" will be displayed.
3. Press  to enter the Programming Mode. "PROGRAMMING MODE MENU ITEMS" will be displayed.
4. Press  two, (2) times. "PROGRAMMING MODE SYSTEM SETUP" will be displayed.
5. Press  thirteen, (13) times. "CLEAN MODE YES (or NO)" will be displayed.
6. Use  and  to turn Clean Mode On or Off.
7. Press  to save the changes.
8. Press  to return to "PROGRAMMING MODE MENU ITEMS"
9. Press  again to exit.

### Service Mode

### To Change SCK Address:

---

1. Press and hold  for three, (3) seconds. "ENTER CODE" will be displayed.
2. Using the Gap Setting buttons,  enter the code, (1251). "ENTER CODE \*\*\*\*" will be displayed.
3. Press  to enter the Programming Mode. "PROGRAMMING MODE MENU ITEMS" will be displayed.
4. Press  three, (3) times. "PROGRAMMING MODE SERVICE MODE" is displayed.
5. Press  one, (1), time. "Address XX" will be displayed.
6. Use  and  to change to the desired SCK Address.
7. Press  to save the changes.



---

## PROGRAMMING continued

---

8. Press **P** to return to “PROGRAMMING MODE SERVICE MODE”
9. Press **P** again to exit.

### To Perform Limit Switch Test:

1. Press and hold **P** for three, (3) seconds. “ENTER CODE” will be displayed.
2. Using the Gap Setting buttons, **1 2 3 4 5** enter the code, (1251). “ENTER CODE \*\*\*\* ” will be displayed.
3. Press **↵** to enter the Programming Mode. “PROGRAMMING MODE MENU ITEMS” will be displayed.
4. Press **↑** three, (3) times. “PROGRAMMING MODE SERVICE MODE” is displayed.
5. Press **↵** two, (2), times. “PLATEN” (along with the position of each switch), will be displayed.
6. Use **↑** and **↓** to move the platen up and down. Check for correct switch operation:  
**Correct Switch Operation:**  
**Platen Up** - U (Closed) L (Open)  
**Platen Down** - U (Open) L (Closed)
7. Press **P** to return to “PROGRAMMING MODE SERVICE MODE”
8. Press **P** again to exit.

### *Gap Button*

#### To Change Gap Setting:

1. Press and hold **P** for three, (3) seconds. “ENTER CODE” will be displayed.
2. Using the Gap Setting buttons, **1 2 3 4 5** enter the code, (1251). “ENTER CODE \*\*\*\* ” will be displayed.
3. Press **↵** to enter the Programming Mode. “PROGRAMMING MODE MENU ITEMS” will be displayed.
4. Press **↓**. “GAP LEVEL 1 X.XXX” will be displayed.
5. Press **↵** until the desired Gap Level is displayed.
6. Use **↑** and **↓** to adjust the Gap Level to the desired value.
7. Press **↵** to save the changes.
8. Press **P** to return to “PROGRAMMING MODE MENU ITEMS”
9. Press **P** again to exit.

---

# CALIBRATION

---

## Bi-Weekly Calibration:

---

**Tools:** Digital Pyrometer with Surface Probe

**Warning:** PERSONAL INJURY FROM BURNS MAY RESULT WHEN COMING IN CONTACT WITH HOT COOKING SURFACES.

**NOTE:** Calibration of grills is done with release material sheets installed.

### NOTE: CALIBRATION REQUIREMENTS



The control software will beep to the user when it is appropriate to calibrate. The control will allow calibration provided the following conditions are met:















- Temperature is currently falling from a detected peak of 360°F or higher.
- Temperature is falling and has fallen 2°F from a detected peak that is within the 350-360°F range. (i.e. calibration would be allowed at 355°F if the achieved peak temperature was 357°F)
- Temperature is rising through the 350-360°F range as a result of a heat on pulse of less than 30 seconds.

### To Calibrate:

1. The upper platens and lower grill plate should be at operating temperatures to perform this calibration procedure.

Turn on the Master Switch and press  to enter cooking mode.

2. Press  or  to select a “CLAM” operation and allow the grill to reach the set temperature and stabilize, (approximately 30 minutes).
3. Press and hold  for three, (3) seconds. “ENTER CODE” will be displayed.

4. Using the Gap Setting buttons,      enter the code, (1251). “ENTER CODE \*\*\*\* ” will be displayed.
5. Press  to enter the Programming Mode. “PROGRAMMING MODE MENU ITEMS” will be displayed.
6. Press  two, (2) times. “PROGRAMMING MODE SYSTEM SETUP” is displayed.
7. Press  four, (4) times. “PROBE CAL – UPPER XXXF” will be displayed.
8. Place the surface probe of the digital pyrometer directly on the probe location, (see diagram on following page).
9. Allow at least 5 seconds for the pyrometer to respond and stabilize. Note the temperature on the pyrometer.
10. If the temperature on the grill control display does not match the temperature on the pyrometer, adjust the temperature on the grill control accordingly using the  and  buttons.
11. Press . “PROBE CAL – GRILL XXXF” will be displayed.
12. Repeat steps 8 - 10.
13. Press  to save the changes.
14. Press  to return to “PROGRAMMING MODE SYSTEM SETUP”
15. Press  again to exit.
16. Repeat steps 1 - 15 at each control.

---

## CALIBRATION continued

---

### Probe Locations:

The grill's thermocouple probes are located on each section of the lower grill plate in the center of the cooking zone as shown in the diagram below. Each upper platen has one thermocouple probe in the center.

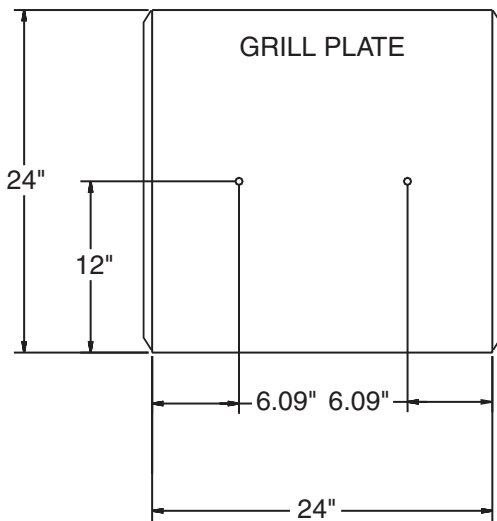
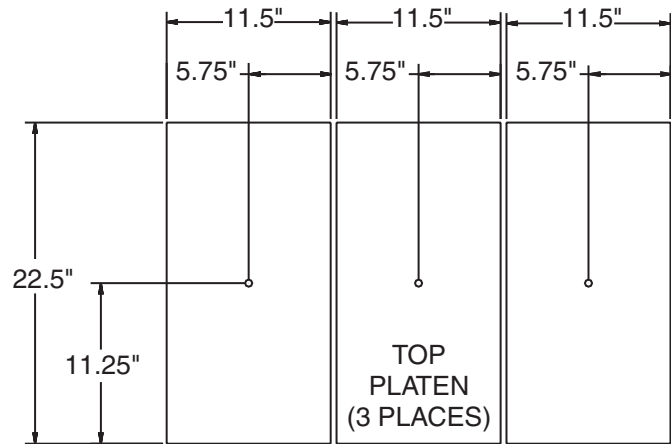
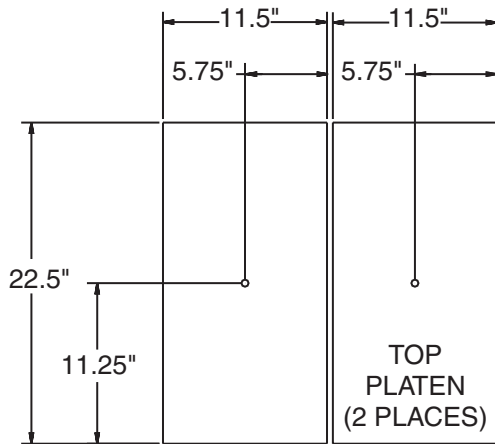

MODEL XE24

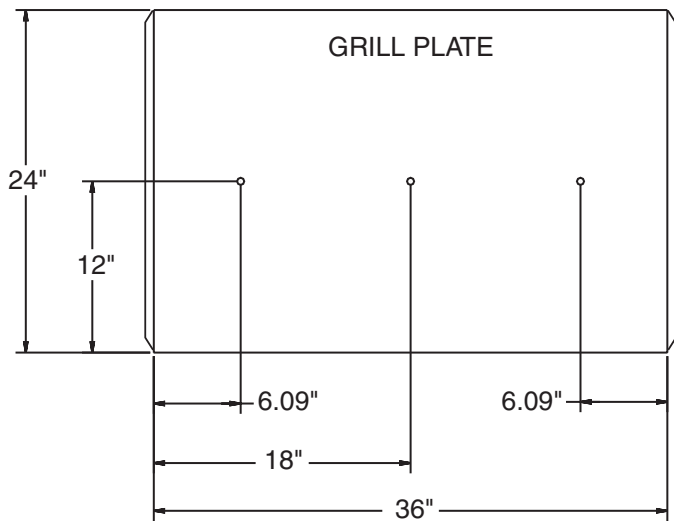

MODEL XE36

---

# TROUBLESHOOTING

---

## ***ERROR MESSAGES:***

**NOTE: WE STRONGLY SUGGEST THAT ANY INSTALLATION, MAINTENANCE AND REPAIRS SHOULD BE PERFORMED BY YOUR LOCAL GARLAND AUTHORIZED SERVICE AGENCY.**

### **PROBE ERROR:**

...occurs when the probe is open or not connected. The control will turn the heat off. If the fault is in the platen the grill can still be used with recipes that do not call from the platen. If the grill probe is opened the grill will not operate. The corresponding tri-color LED will turn red indicating which element is in error. Programming is allowed during this time.

### **PLATEN DOWN ERROR:**

...occurs if the platen does not reach the proper position in 40 seconds or fails to move during this time. There is an audio alarm with this message.

To cancel the message, press .

### **PLATEN UP ERROR:**

...occurs if the platen is below the lower limit and does not move for 40 seconds.

To cancel the audio alarm press .

### **HEATING ERROR:**

...occurs when the controller does not detect a proper temperature response over a six minute period. The corresponding tri-color LED will turn red indicates which element is in error.

### **COMM ERROR:**

...occurs when there is no communication between the control board and the motor board.

Press  to reset the message and silence the beep.

### **MOTOR OVER CURRENT:**

...displayed when the platen has been mechanically resisted. The platen will stop and move to the lower limit. Press the GREEN/CANCEL button to eliminate this display.

### **MOTOR ERROR:**

...occurs when the platen is going up or down and does not get 5 encoder counts in 1 second when the platen is below the lower limit moving down or above the lower limit going up. At this message the display will flash and there will be an audio alarm. To cancel the message the power switch must be recycled.

### **CLEAR OBSTRUCTION**

...occurs when the movement of the upper platen has been mechanically or physically resisted, or the platen control motor is inoperative. Press Green and Black buttons to resume.

### **FAULTY ELEMENT**

...occurs when the controller does not detect a proper temperature response. The corresponding tri-color LED will turn red indicating which element is in error.







 **GARLAND®**

**X** *press grill*



## Free Manuals Download Website

<http://myh66.com>

<http://usermanuals.us>

<http://www.somanuals.com>

<http://www.4manuals.cc>

<http://www.manual-lib.com>

<http://www.404manual.com>

<http://www.luxmanual.com>

<http://aubethermostatmanual.com>

Golf course search by state

<http://golfingnear.com>

Email search by domain

<http://emailbydomain.com>

Auto manuals search

<http://auto.somanuals.com>

TV manuals search

<http://tv.somanuals.com>