



## VHF 100/200 Series Radio Installation Instructions

These installation instructions are for the following VHF radios and handsets:

North American Models	International Models
VHF 100	VHF 100i
VHF 200	VHF 200i
GHS 10	GHS 10i

Compare the contents of this package with the packing list on the box. If any pieces are missing, contact your Garmin® dealer immediately. Before you begin the installation:

- Read these instructions thoroughly.
- Gather the appropriate fasteners and tools.
- Verify that all cables can reach the radio mounting location.
- Wear safety goggles and a dust mask when drilling, cutting, or sanding.

### Product Registration

Help us better support you by completing our online registration today. Go to <http://my.garmin.com>. Keep the original sales receipt, or a photocopy, in a safe place.

### Contact Garmin

Contact Garmin Product Support if you have any questions while using your VHF 100/200 series radio. In the USA, go to [www.garmin.com/support](http://www.garmin.com/support), or contact Garmin USA by phone at (913) 397.8200 or (800) 800.1020.

In the UK, contact Garmin (Europe) Ltd. by phone at 0808 2380000.

In Europe, go to [www.garmin.com/support](http://www.garmin.com/support) and click **Contact Support** for in-country support information, or contact Garmin (Europe) Ltd. by phone at +44 (0) 870.8501241.

### Warnings and Safety Notices

#### Antenna Mounting and EME Exposure

Your VHF radio generates and radiates radio frequency (RF) electromagnetic energy (EME). Failure to observe these guidelines may expose persons to RF radiation absorption exceeding the maximum permissible exposure (MPE).

Garmin declares an MPE radius of 59 in. (1.5 m.) for this system, which was determined using 25 watts output to an omni-directional 9 dBi gain antenna. The antenna should be installed such that a distance of 59 in. (1.5 m) is maintained between the antenna and all persons.

---

 **WARNING:** Radio operators with cardiac pacemakers, life-support machines, or electrical medical equipment should not be exposed to excessive radio-frequency fields.

---

 **WARNING:** Operate the device in accordance with the instructions supplied.

---

 **NOTICE:** The device complies with internationally recognized standards covering human exposure to electromagnetic fields from radio devices.

---

 **NOTICE:** Check with local authorities for any antenna or operational restrictions that may apply.

---

#### Safe Compass Distance

Ensure that you install your VHF radio at least 20 in. (500 mm) from any compass. Test your compass to verify that it operates correctly when the radio is operating.

#### VHF 100/200 Series Dimensions

- Flush Mount—(W × H × D) 7.16 × 3.86 × 6.42 in. (18.2 × 9.8 × 16.3 cm)
- Bail Mount—(W × H × D) 7.56 × 4.65 × 6.42 in. (19.2 × 11.8 × 16.3 cm)

## Installing your VHF 100/200 Series Radio

1. Select a location ([page 2](#)).
2. Mount the radio ([page 2](#)).
3. Connect the radio to power ([page 4](#)).
4. Connect the radio to an antenna ([page 5](#)).
5. Mount the microphone hangar ([page 5](#)).

Although they are not necessary to use your radio, these instructions cover the following additional installation options.

- Connecting the radio to a chartplotter ([page 5](#))
- Connecting the radio to a hailer horn ([page 7](#))
- Connecting the radio to an external speaker ([page 8](#))
- Connecting the GHS™ 10 or GHS 10i handset or a relocation microphone ([page 8](#))

### Step 1: Select a Location for the VHF 100/200 Series Radio

Consider the following when you select an installation location:

- Provides optimal viewing.
- Allows easy access to the radio controls and handset.
- Is strong enough to support the weight of the radio and protect it from excessive vibration or shock.
- Allows room for the routing and connection of the cables for power and data. There should be at least 5 in. (127 mm) of clearance behind the case.
- Is located at least 20 in. (500 mm) from a magnetic compass.
- Is in an area that minimizes exposure to extreme weather conditions.



**NOTE:** The temperature range for the VHF 100/200 series radios is from 14°F to 122°F (from -10°C to 50°C). Extended exposure to temperatures outside this range (in storage or operating conditions) may cause failure of the LCD screen or other components. This type of failure and related consequences are not covered by the manufacturer's limited warranty.

### Step 2: Mount the VHF 100/200 Series Radio

You can mount your radio in one of two ways:

- Bail Mount—mount the radio onto the bracket that attaches to the console or overhead.
- Flush Mount—use the flush-mount kit to mount the radio into a flat panel.

#### Bail Mounting the VHF 100/200 Series Radio

In addition to the included mounting bracket, mounting knobs, and three of the 4.2 × 25 mm panhead mounting screws, bail mounting the VHF 100/200 series radio requires the following tools (not included):

- Phillips screwdriver
- Drill and 9/64 in. (3.5 mm) drill bit
- Center punch and hammer
- Customer-supplied mounting hardware (optional) - bolts, nuts, and washers

#### To mount the bracket assembly:

1. Using the base of the bracket as a template, mark the location of the three holes (two screws towards the front, one screw towards the back).
2. Using the center punch, indent the center of each of the three mounting-hole locations.
3. Drill the mounting holes, using a 9/64 in. (3.5 mm) drill bit
4. Secure the base with the three 4.2 × 25 mm included screws or, if desired, secure with appropriate bolts, nuts, and washers (not included).

#### To install the VHF 100/200 series radio on the mounting bracket:

1. Loosely attach the mounting knobs to the VHF 100/200 series radio.
2. Slide the radio onto the mounting bracket, and tighten the mounting knobs.

## Flush Mounting the VHF 100/200 Series Radio

In addition to the four included  $4.2 \times 25$  mm, panhead mounting screws, flush mounting the VHF 100/200 series radio requires the following tools (not included):

- Phillips screwdriver
- Drill and 9/64 in. (3.5 mm) drill bit for mounting holes
- 3/8 in. (10 mm) drill bit for a starter hole
- Jigsaw
- Scissors and tape
- Center punch and hammer
- File and sandpaper
- Anti-seize lubricant (optional)

---

 **NOTE:** Ensure that the surface on which you mount the VHF 100/200 series radio has sufficient open space behind it to accommodate the radio and the connected cables. There should be at least 5 in. (127 mm) of clearance behind the case.

---

### To flush mount the VHF 100/200 series radio:

1. Cut and trim the flush-mount template ([page 9](#)) and ensure it will fit in the location where you want to flush mount the VHF 100/200 series radio.
2. Tape the flush-mount template to the mounting location.
3. Use the center punch to indent the center of each of the four mounting-hole locations.
4. Use a 9/64 in. (3.5 mm) drill bit to drill the four mounting holes.
5. Use a 3/8 in. (10 mm) drill bit to drill a starter hole inside the corner of the template to begin cutting the mounting surface.
6. Use the jigsaw to cut the mounting surface along the inside of the dashed line indicated on the template. Use a file and sandpaper to refine the size of the hole.
7. Place the radio into the cutout to confirm that the four mounting holes are correct after refining the hole. If not, mark the correct locations of the four mounting holes. Remove the radio from the cutout.
8. Apply the gasket to the back of the VHF 100/200 series radio.
9. If the top and bottom snap covers are attached to the front of the VHF 100/200 series radio, remove them by unsnapping the covers from the sides.
10. Place the VHF 100/200 series radio into the cutout.
11. Securely tighten the four mounting screws through the VHF 100/200 series radio into the drilled mounting holes.

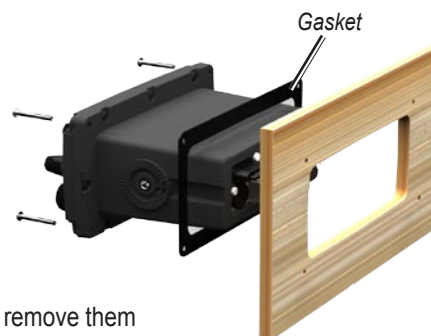

---

 **NOTE:** Stainless-steel screws may bind when screwed into fiberglass and overtightened. Garmin recommends applying an anti-galling, stainless, anti-seize lubricant to the screw before using.

---

12. Place the snap covers over the mounting screws.

### Step 3: Connect the VHF 100/200 Series Radio to Power

The VHF 100/200 series radios have a power-cable wiring harness that connects to power and provides interface capabilities for connecting external devices.

#### Notes:

- The replacement fuse on the power cable wiring harness is a 10 A, slow-blow fuse.
- If it is necessary to extend the power wires, use 18 AWG wire.
- If your boat has an electrical system, you might be able to wire the radio directly to an unused holder on your current fuse block. If you are using the fuse block, remove the in-line fuse holder supplied with the radio. You can also wire the radio directly to the battery.

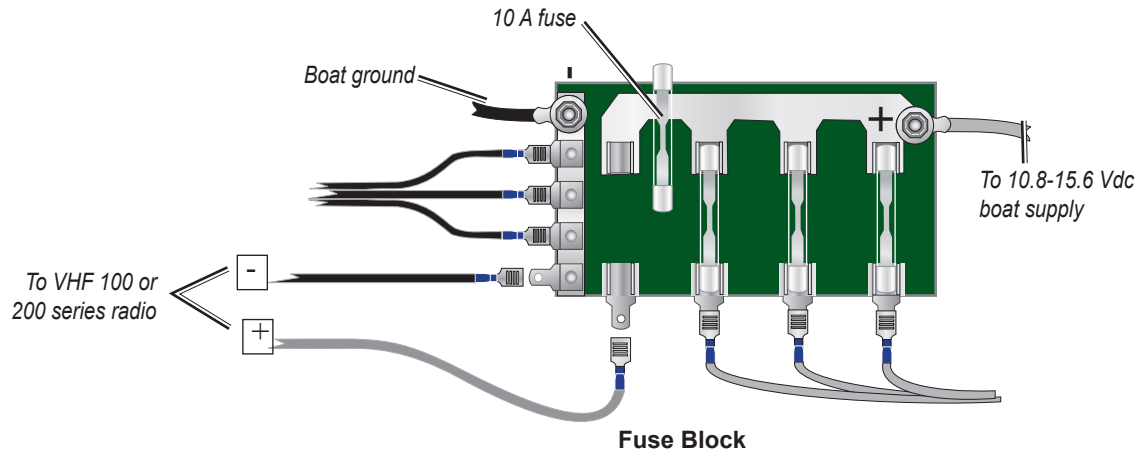

**CAUTION:** The VHF 100/200 series radio maximum input voltage is 15.6 Vdc. Do not exceed this voltage, because this can damage the radio and void the warranty.

**NOTE:** During a typical installation, use only the red and black wires. The other wires are used for NMEA 0183 and other connections, and do not have to be connected for normal operation of the radio. For information on connecting to a NMEA 0183-compatible device, see [page 5](#).

#### To install the power-cable wiring harness:

1. Use a test light or voltmeter to determine the polarity of the voltage source.
2. Connect the red (+) wire on the power-cable wiring harness to the positive voltage terminal on the battery. (If you use the fuse block on the boat, route the positive connection through the fuse, as shown on the Fuse Block diagram.)
3. Connect a ground wire (not included) from the ground connector screw to the negative voltage terminal on the battery, using 18 AWG wire.

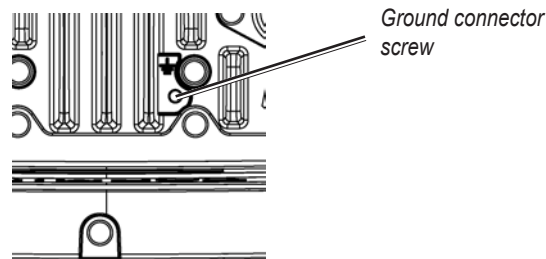

4. Connect the black (-) wire on the power-cable wiring harness to the negative voltage terminal on the battery.
5. Install or check the 10 A fuse (on the fuse block or in the in-line holder).
6. Connect the power-cable wiring harness red and black wires to the red and black wires on the back of the radio (connect the two red wires together and the two black wires together).

**CAUTION:** Cover the connections with a waterproof, adhesive tape, such as rubber vulcanizing tape, to prevent water from seeping into the radio.

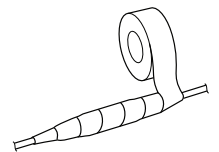

## Step 4: Connect the VHF 100/200 Series Radio to an Antenna

Connect a marine VHF antenna to the radio using the antenna port on the rear panel of the radio. Mount the antenna according to the installation instructions provided with the antenna.

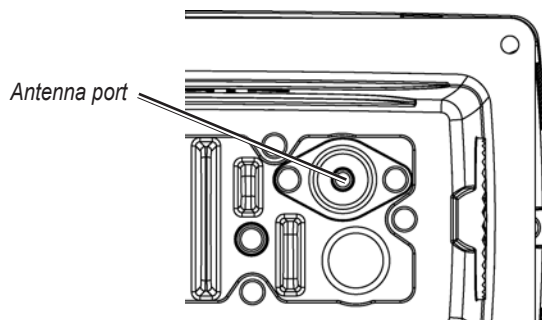

## Step 5: Mounting the Microphone Hanger

Drill the mounting holes using a 1/8 in. (3 mm) drill bit. Use three of the included 3.5 × 20 mm, panhead mounting screws to mount the microphone hanger in a convenient location near the radio.

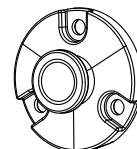

## Connecting the VHF 100/200 Series Radio to a Chartplotter (Optional)

The VHF 100/200 series radio can be connected to a chartplotter so that data such as DSC information can be displayed on a chartplotter. Additionally, location information from the GPS function of the chartplotter can be displayed on the radio.

A VHF 100/100i or 200/200i radio can be connected to a NMEA 0183-compliant chartplotter. A VHF 200 or 200i can be connected to a NMEA 2000®-compliant chartplotter.

## Connecting a VHF 100/200 Series Radio to a NMEA 0183-Compliant Chartplotter

The following diagram illustrates the NMEA 0183 wiring used to connect your VHF 100/200 series radio to a GPS chartplotter. If additional cabling is necessary, go to <http://buy.garmin.com>.

**VHF 200 or 200i radio only**—Attach the included 59 in. (1.5 m) NMEA 0183 extension cable to the cable on the rear panel of the radio. The other end of the extension cable has bare wires.

Connect NMEA 0183 bare wires as indicated in the following illustration.

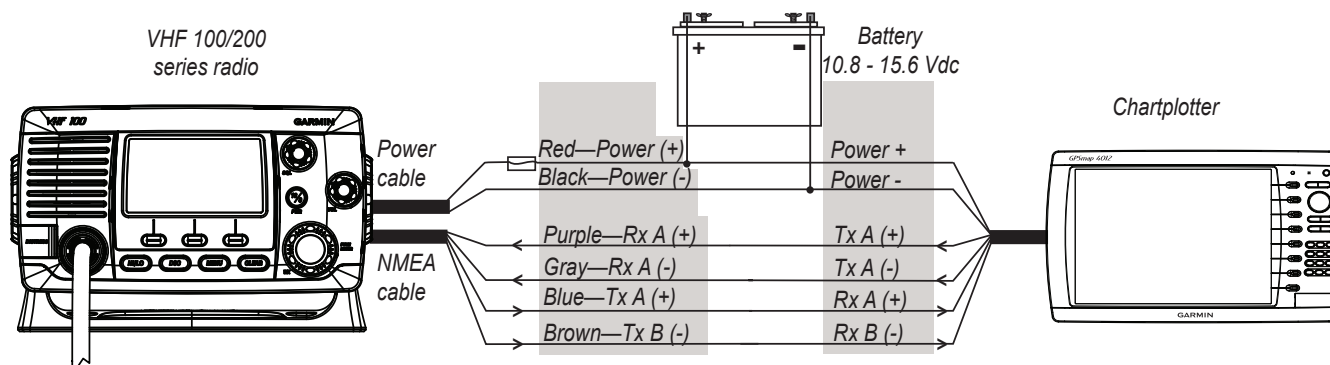

**CAUTION:** Cover the connections with a waterproof, adhesive tape, such as rubber vulcanizing tape, to prevent water from seeping into the radio.

The VHF 100/200 series radio can receive and transmit the following NMEA 0183 sentences (version 3.01) from a NMEA 0183-compliant device:

Sentence (Receive)	Definition
GGA	Global Positioning System Fix Data
GLL	Geographic Position (Latitude and Longitude)
GNS	GNSS (Global Navigation Satellite System) Fix Data
RMA	Recommended Minimum Specific Loran-C Data
RMB	Recommended Minimum Navigation Information
RMC	Recommended Minimum Specific GNSS Data

Sentence (Transmit)	Definition
DSC	DSC Information
DSE	Expanded DSC

## Connecting a VHF 200 Series Radio to a NMEA 2000 network

The VHF 200 and VHF 200i radios can be connected to your existing NMEA 2000 network, or you can build a basic NMEA 2000 network to connect to another NMEA 2000-compatible device, such as a chartplotter. For more information on NMEA 2000 and to purchase required connectors, visit [www.garmin.com](http://www.garmin.com).

**NOTE:** The VHF 100 and VHF 100i radios cannot be connected to a NMEA 2000 network. See [page 5](#) to connect your radio to a NMEA 0183 network.

### To connect the VHF 200 series radio to your existing NMEA 2000 network:

1. Determine where you would like to connect the radio to your existing NMEA 2000 backbone.
2. Disconnect one side of a NMEA 2000 T-connector from the backbone at an appropriate location.  
If you need to extend the NMEA 2000 backbone, connect an appropriate NMEA 2000 backbone extension cable to the side of the T-connector you disconnected.
3. Add a T-connector (not included) for the radio in the NMEA 2000 backbone by connecting it to the side of the T-connector you disconnected.
4. Route a NMEA 2000 drop cable (not included) to the bottom of the T-connector added in step 3 to your NMEA 2000 network. Use a drop cable with a length up to 20 ft. (6 m).
5. Connect the drop cable to the T-connector and the NMEA 2000 port on the radio

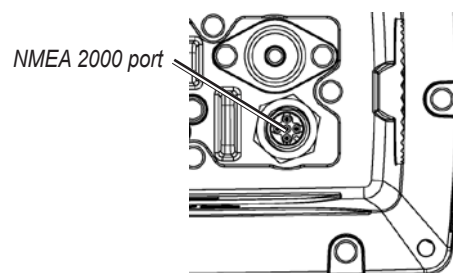

**CAUTION:** If you have an existing NMEA 2000 network on your boat, it should already be connected to power. Do not connect an additional NMEA 2000 power cable to an existing NMEA 2000 network, because only one power source should be connected to a NMEA 2000 network.

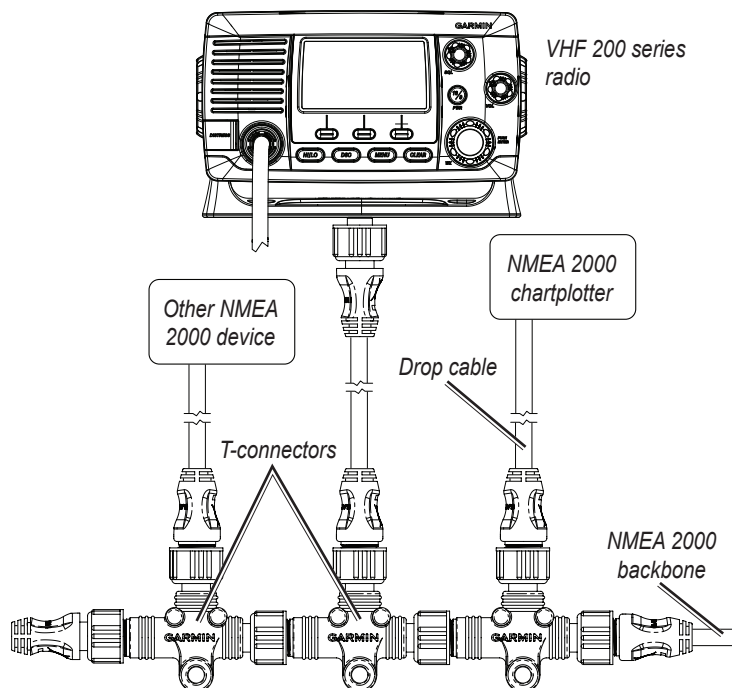

### Connecting the VHF 200 Series Radio to an Existing NMEA 2000 Network

#### To create a basic NMEA 2000 network:

1. Connect two T-connectors (not included) together by their sides.
2. Connect a NMEA 2000 power cable (not included) to one of the T-connectors.

**CAUTION:** A NMEA 2000 power cable must be connected to a 12 Vdc power source through a switch. The VHF 200 series radio may drain your battery if it is connected directly. Connect the cable to the ignition switch of the boat if possible, or through an appropriate additional switch.

3. Connect a NMEA 2000 drop cable (not included) to the other T-connector and to the NMEA 2000 port on the radio.



4. Add additional T-connectors for each device you want to add to the NMEA 2000 network, and connect each device to a T-connector with a drop cable.
5. Connect terminators (not included) to each end of the combined T-connectors.

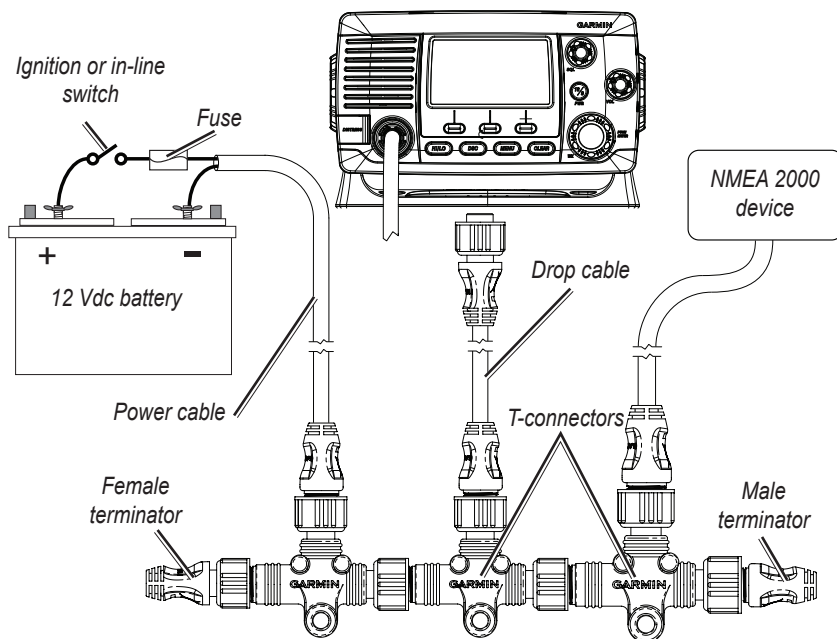

Creating a Basic NMEA 2000 Network

### NMEA 2000 PGN information

Use this table to determine the approved NMEA 2000 PGN information that can be received and transmitted by a VHF 200 series radio when communicating with a NMEA 2000-compliant device.

Receive		Transmit	
059392	ISO Acknowledgment	059392	ISO Acknowledgment
059904	ISO Request	060928	ISO Address Claim
060928	ISO Address Claim	126208	NMEA Request/Command/ Acknowledge Group Function
126208	NMEA - Command/Request/Acknowledge Group Function		
129026	COG (course over ground) and SOG (speed over ground) - Rapid Update	126464	PGN List
129029	GNSS (Global Navigation Satellite System) Position Data	126996	Product Information
		129799	Radio Frequency/Mode/Power
		129808	DSC Call Information



Garmin VHF 200 Series radios are NMEA 2000 certified.

### Connecting the VHF 200 Series Radio to a Hailer Horn (Optional)

The radio can be connected to a hailer horn that will allow using the microphone or the GHS 10 handset to make announcements through your public address system.

To mount the hailer horn, refer to the installation instructions that came with the device. Mount the hailer horn at least 10 ft. (3 m) away from the microphone and facing away from the microphone to avoid feedback.

#### To connect the VHF 200 series radio to a hailer horn:

1. Attach the included 23 in. (600 mm) hailer cable to the cable on the rear panel of the radio by connecting the red RCA plug into the red jack.
2. Connect the white wire on the other end of the hailer cable to the positive (+) connection on the hailer.
3. Connect the black wire to the negative (-) connection on the hailer.

**CAUTION:** Cover the connections with a waterproof, adhesive tape, such as rubber vulcanizing tape, to prevent water from seeping into the radio.

Refer to the *VHF 100/200 Series Owner's Manual* to operate the hailer.

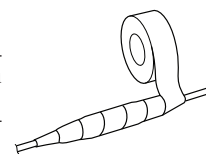

## Connecting the VHF 100/200 Series Radio to an External Speaker (Optional)

The radio can be connected to an external speaker that allows you to hear your radio at a remote location. To mount the external speaker, refer to the installation instructions that came with the speaker.

### To connect the VHF 100 series radio to an external speaker:

1. Connect the yellow wire on the wiring harness (located on the rear panel of the radio) to the positive (+) connection on the external speaker.
2. Connect the green wire to the negative (-) connection on the external speaker.

### To connect the VHF 200 series radio to an external speaker:

1. Attach the included 23 in. (600 mm) speaker cable to the cable on the rear panel of the radio by connecting the white RCA plug into the white jack.
2. Connect the yellow wire on the other end of the speaker cable to the positive (+) connection on the external speaker.
3. Connect the green wire to the negative (-) connection on the external speaker.

 **CAUTION:** Cover the connections with a waterproof, adhesive tape, such as rubber vulcanizing tape, to prevent water from seeping into the radio.

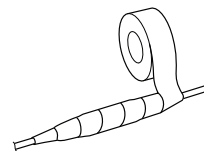

## Connecting the GHS 10 or GHS 10i Handset or a Relocation Microphone to the VHF 200 Series Radio (Optional)

Use the microphone relocation port on the rear panel of the VHF 200 series radio to connect either a relocation microphone or a Garmin GHS 10 handset.

### Connecting a Relocation Microphone for the VHF 200 or VHF 200i

To relocate the VHF 200 series radio detachable microphone, you can order a microphone relocation kit at <http://buy.garmin.com>, which consists of a 32.8 ft. (10 m) extension cable, a weather cap for the front microphone connector, and the necessary cable hardware.

#### To connect the relocation microphone:

1. Connect the extension cable to the microphone relocation port on the rear of the radio.

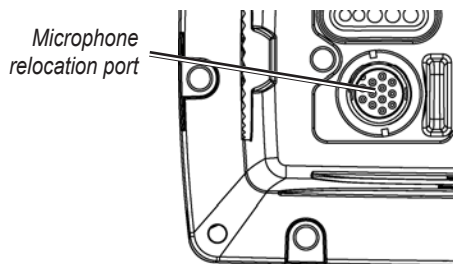

2. Connect the other end of the extension cable to the relocation microphone.

### Connecting a GHS 10 or GHS 10i Handset

You can use a Garmin GHS 10 handset with the VHF 200 radio, or a Garmin GHS 10i handset with the VHF 200i radio. The handset comes with a 32.8 ft. (10 m) extension cable, a cable mounting plate, a weather cap, and the necessary cable hardware. You can order a GHS 10 or GHS 10i handset at <http://buy.garmin.com>.

Install the GHS 10 or GHS 10i handset at least 20 in. (500 mm) from any compass.

#### To connect the GHS 10 or GHS 10i handset:

1. Use the three 3.5 × 20 mm, panhead mounting screws to mount the bulk head plate where the handset will be located.
2. Connect the extension cable to the microphone relocation port on the rear of the VHF 200 or VHF 200i radio.
3. Use the bulk head plate to mount the other end of the extension cable and connect the extension cable to the handset.

#### To connect an external speaker next to the GHS 10 or GHS 10i handset:

The green and yellow wires on the extension cable can be used to connect an external speaker. Connect the yellow wire to the positive (+) connection on the external speaker. Connect the green wire to the negative (-) connection on the external speaker.

Refer to the *VHF 100/200 Series Owner's Manual* to operate the GHS 10 or GHS 10i handset.

The CE Notified Body number (0168) is valid for the VHF 100i and VHF 200i only.

**CE 0168** 



# VHF 100/200 Series Flush-Mount Template

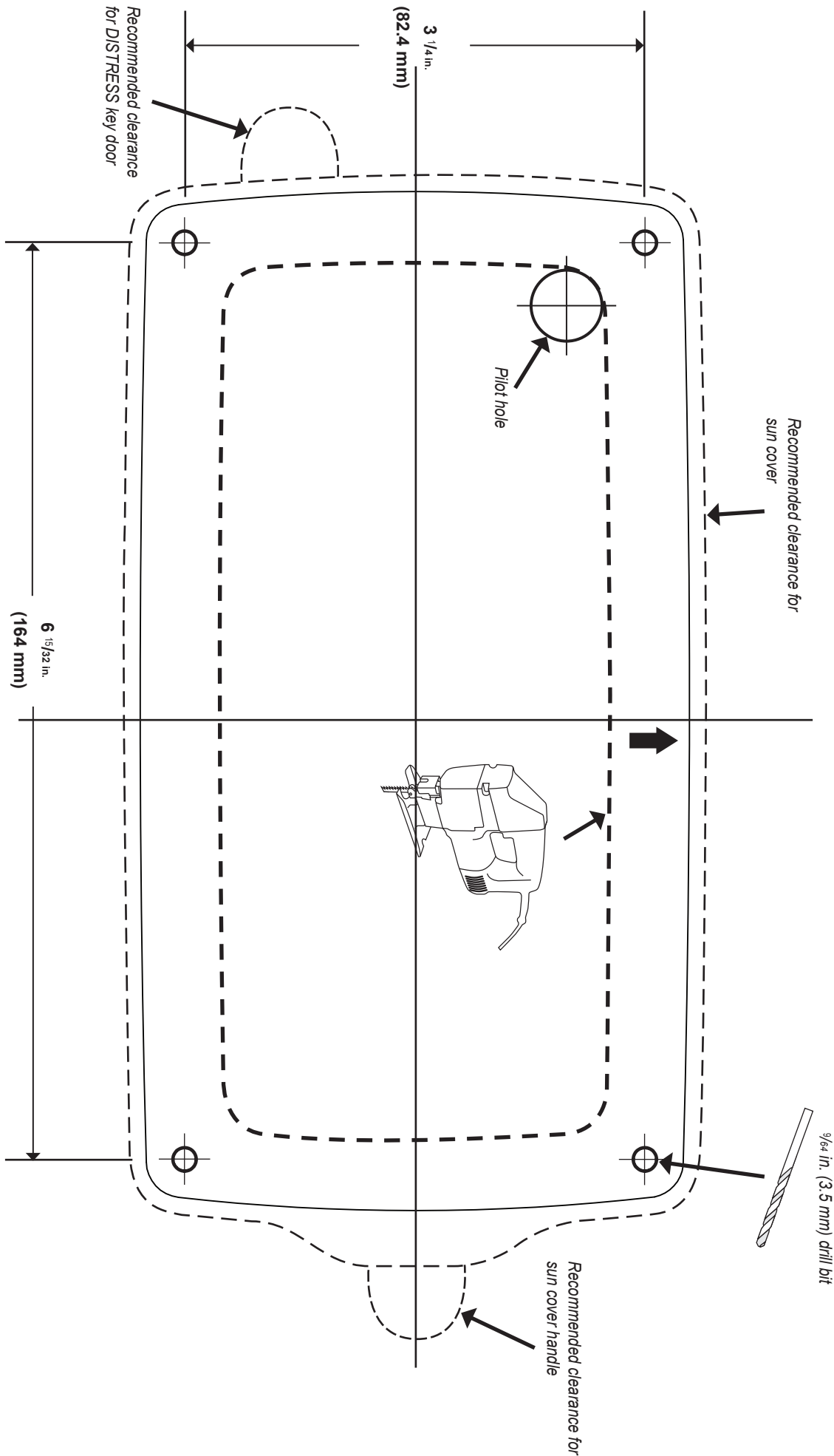



© 2009 Garmin Ltd. or its subsidiaries

Garmin International, Inc.  
1200 East 151<sup>st</sup> Street, Olathe, Kansas 66062, USA

Garmin (Europe) Ltd.  
Liberty House, Hounsdown Business Park, Southampton, Hampshire, SO40 9LR UK

Garmin Corporation  
No. 68, Jangshu 2nd Road, Shijr, Taipei County, Taiwan

[www.garmin.com](http://www.garmin.com)

July 2009

190-01019-02 Rev. E

Printed in China

## Free Manuals Download Website

<http://myh66.com>

<http://usermanuals.us>

<http://www.somanuals.com>

<http://www.4manuals.cc>

<http://www.manual-lib.com>

<http://www.404manual.com>

<http://www.luxmanual.com>

<http://aubethermostatmanual.com>

Golf course search by state

<http://golfingnear.com>

Email search by domain

<http://emailbydomain.com>

Auto manuals search

<http://auto.somanuals.com>

TV manuals search

<http://tv.somanuals.com>