

GPSMAP 182/182C/232

chartplotting receivers



owner's
manual
and
reference
guide

(GPSMAP 232 and 182C shown)

© 2003 Garmin Ltd. or its subsidiaries

Garmin International, Inc., 1200 East 151st Street, Olathe, KS 66062, U.S.A.
Tel. 913/397.8200 or 800/800.1020 Fax 913/397.8282

Garmin (Europe) Ltd., Unit 5, The Quadrangle, Abbey Park Industrial Estate, Romsey SO51 9DL, U.K.
Tel. 44/1794.519944 Fax 44/1794.519222

Garmin Corporation, No. 68, Jangshu 2nd Road, Shijr, Taipei County, Taiwan
Tel. 886/2.2642.9199 Fax 886/2.2642.9099

All rights reserved. Except as expressly provided herein, no part of this manual may be reproduced, copied, transmitted, disseminated, downloaded or stored in any storage medium, for any purpose without prior written consent of Garmin. Garmin hereby grants permission to download a single copy of this manual onto a hard drive or other electronic storage medium to be viewed for personal use, provided that such electronic or printed copy of this manual or revision must contain the complete text of this copyright notice and provided further that any unauthorized commercial distribution of this manual is strictly prohibited.

Information in this manual is subject to change without notice. Garmin reserves the right to change or improve its products and to make changes in the content without obligation to notify any person or organization of such changes. Visit the Garmin web site (www.garmin.com) for current updates and supplemental information concerning the use and operation of this and other Garmin products.

June 2003

Part Number 190-00215-10 Rev. A

Printed in Taiwan

Introduction

Foreword



GARMIN[®], Autolocate[®], GPSMAP[®], TracBack[®], DCG[®], See-Thru[®], MapSource[®], and BlueChart[®] are registered trademarks of Garmin Ltd. or its subsidiaries and may not be used without the express permission of Garmin.

Introduction

Preface/Registration/ Software License Agreement

Customer Service Product Registration

Help us better support you by completing our on-line registration today!

Have the serial number of your GPSMAP 182/182C/232 handy and connect to our web site (www.garmin.com). Look for the Product Registration link on the Home page. Also, be sure to record your serial number in the area provided on page iv of this manual.

NOTE: If you have previously registered a Garmin product purchase, we invite you to re-register using our NEW on-line system. Many services provided by our new product registration system are now being automated and re-registering your purchase ensures you the best possible support from Garmin.

Preface

Congratulations on choosing one of the most advanced marine navigation systems available! The Garmin GPSMAP 182/182C/232 models utilize the proven performance of Garmin GPS and full featured mapping to create unsurpassed marine navigation chartplotters.

This manual covers instructions for the GPSMAP 182, GPSMAP 182C (color), and GPSMAP 232. Unit operation and specifications will be the same on all three models unless otherwise specified. For GSD 20 sonar related operations, refer to “GSD 20 Sounder Module with Garmin Chartplotters” (190-00241-03). To get the most out of your new navigation system, take the time to go through this owner’s manual and learn the operating procedures for your unit. This manual is broken down into two parts for your convenience.

Part One introduces you to the GPSMAP 182/182C/232 and provides a Getting Started tour so that you may become more familiar with the unit. This section will provide you with a basic working knowledge necessary to use the unit to its fullest potential.

Part Two is divided into sections that provide detailed references to the advanced features and operations of the GPSMAP 182/182C/232. This allows you to concentrate on a specific topic quickly and look up detailed information about the GPSMAP 182/182C/232.

Software License Agreement

BY USING THE GPSMAP 182/182C/232, YOU AGREE TO BE BOUND BY THE TERMS AND CONDITIONS OF THE FOLLOWING SOFTWARE LICENSE AGREEMENT. PLEASE READ THIS AGREEMENT CAREFULLY.

Garmin grants you a limited license to use the software embedded in this device (the “Software”) in binary executable form in the normal operation of the product. Title, ownership rights and intellectual property rights in and to the Software remain in Garmin.

You acknowledge that the Software is the property of Garmin and is protected under the United States of America copyright laws and international copyright treaties. You further acknowledge that the structure, organization and code of the Software are valuable trade secrets of Garmin and that the Software in source code form remains a valuable trade secret of Garmin. You agree not to decompile, disassemble, modify, reverse assemble, reverse engineer or reduce to human readable form the Software or any part thereof or create any derivative works based on the Software. You agree not to export or re-export the Software to any country in violation of the export control laws of the United States of America.

The GPS system is operated by the United States government, which is solely responsible for its accuracy and maintenance. The system is subject to changes which could affect the accuracy and performance of all GPS equipment. Although the Garmin GPSMAP 182/182C/232 is a precision electronic NAVigation AID (NAVAID), any NAVAID can be misused or misinterpreted and, therefore, become unsafe.

The electronic chart is an aid to navigation and is designed to facilitate the use of authorized government charts, not replace them. Only official government charts and notices to mariners contain all information needed for safe navigation – and, as always, the user is responsible for their prudent use.

Use the GPSMAP 182/182C/232 at your own risk. To reduce the risk of unsafe operation, carefully review and understand all aspects of this Owner's Manual—and thoroughly practice operation using the simulator mode prior to actual use. When in actual use, carefully compare indications from the GPSMAP 182/182C/232 to all available navigation sources, including the information from other NAVAIDs, visual sightings, charts, etc. For safety, always resolve any discrepancies before continuing navigation.

FCC Compliance

The GPSMAP 182/182C/232 complies with Part 15 of the FCC interference limits for Class B digital devices FOR HOME OR OFFICE USE. These limits are designed to provide reasonable protection against harmful interference in a residential installation, and are more stringent than “outdoor” requirements. Operation of this device is subject to the following conditions: (1) This device may not cause harmful interference, and (2) this device must accept any interference received, including interference that may cause undesired operation. This equipment generates, uses and can radiate radio frequency energy and, if not installed and used in accordance with the instructions, may cause harmful interference to radio communications. However, there is no guarantee that interference will not occur in a particular installation. If this equipment does cause harmful interference to radio or television reception, which can be determined by turning the equipment off and on, the user is encouraged to try to correct the interference by one or more of the following measures: Reorient or relocate the receiving antenna. Increase the separation between the equipment and receiver. Connect the equipment into an outlet on a circuit different from that to which the receiver is connected. Consult the dealer or an experienced radio/TV technician for help.

The GPSMAP 182/182C/232 does not contain any user-serviceable parts. Repairs should only be made by an authorized Garmin service center. Unauthorized repairs or modifications could result in permanent damage to the equipment, and void your warranty and your authority to operate this device under Part 15 regulations.

Introduction



Warnings and Precautions

MAP DATA INFORMATION: *One of the goals of Garmin is to provide customers with the most complete and accurate cartography that is available to us at a reasonable cost. We use a combination of governmental and private data sources, which we identify (as required) in product literature and copyright messages displayed to the consumer. Virtually all data sources contain inaccurate or incomplete data to some degree. This is particularly true outside the United States, where complete and accurate digital data is either not available or prohibitively expensive.*

CAUTION: *IT IS THE USER'S RESPONSIBILITY TO USE THIS PRODUCT PRUDENTLY. THIS PRODUCT IS INTENDED TO BE USED ONLY AS A NAVIGATIONAL AID AND MUST NOT BE USED FOR ANY PURPOSE REQUIRING PRECISE MEASUREMENT OF DIRECTION, DISTANCE, LOCATION, OR TOPOGRAPHY.*

WARNING: *This product, its packaging, and its components contain chemicals known to the State of California to cause cancer, birth defects, or reproductive harm. This Notice is being provided in accordance with California's Proposition 65. If you have any questions or would like additional information, please refer to our web site at <http://www.garmin.com/prop65>.*

Introduction

Warranty and Serial Number

Serial Number

Use this area to record the serial number (8-digit number located on the back of the unit) in case it is lost, stolen, or needs service. Be sure to keep your original sales receipt in a safe place or attach a photocopy inside the manual.

Serial Number:

* *



The Garmin GPSMAP 182/182C/232 has no user-serviceable parts. Should you ever encounter a problem with your unit, please take it to an authorized Garmin dealer for repairs.

The GPSMAP 182/182C/232 is fastened shut with screws. Any attempt to open the case to change or modify the unit in any way will void your warranty and may result in permanent damage to the equipment.

iv

LIMITED WARRANTY

This Garmin product is warranted to be free from defects in materials or workmanship for one year from the date of purchase. Within this period, Garmin will at its sole option, repair or replace any components that fail in normal use. Such repairs or replacement will be made at no charge to the customer for parts or labor, provided that the customer shall be responsible for any transportation cost. This warranty does not cover failures due to abuse, misuse, accident or unauthorized alteration or repairs.

THE WARRANTIES AND REMEDIES CONTAINED HEREIN ARE EXCLUSIVE AND IN LIEU OF ALL OTHER WARRANTIES EXPRESS OR IMPLIED OR STATUTORY, INCLUDING ANY LIABILITY ARISING UNDER ANY WARRANTY OF MERCHANTABILITY OR FITNESS FOR A PARTICULAR PURPOSE, STATUTORY OR OTHERWISE. THIS WARRANTY GIVES YOU SPECIFIC LEGAL RIGHTS, WHICH MAY VARY FROM STATE TO STATE.

IN NO EVENT SHALL GARMIN BE LIABLE FOR ANY INCIDENTAL, SPECIAL, INDIRECT OR CONSEQUENTIAL DAMAGES, WHETHER RESULTING FROM THE USE, MISUSE, OR INABILITY TO USE THIS PRODUCT OR FROM DEFECTS IN THE PRODUCT. Some states do not allow the exclusion of incidental or consequential damages, so the above limitations may not apply to you.

Garmin retains the exclusive right to repair or replace the unit or software or offer a full refund of the purchase price at its sole discretion. SUCH REMEDY SHALL BE YOUR SOLE AND EXCLUSIVE REMEDY FOR ANY BREACH OF WARRANTY.

To obtain warranty service, contact your local Garmin authorized dealer. Or call Garmin Customer Service at one of the numbers shown below, for shipping instructions and an RMA tracking number. The unit should be securely packed with the tracking number clearly written on the outside of the package. The unit should then be sent, freight charges prepaid, to any Garmin warranty service station. A copy of the original sales receipt is required as the proof of purchase for warranty repairs.

Products sold through online auctions are not eligible for rebates or other special offers from Garmin. Online auction confirmations are not accepted for warranty verification. To obtain warranty service, an original or copy of the sales receipt from the original retailer is required. Garmin will not replace missing components from any package purchased through an online auction.

Garmin International, Inc.
1200 East 151st Street
Olathe, Kansas 66062, U.S.A.
Phone: 913/397.8200
USA Only: 800/800.1020
FAX: 913/397.0836

Garmin (Europe) Ltd.
Unit 4, The Quadrangle, Abbey Park Industrial Estate
Romsey, SO51 9DL, U.K.
Phone: 44/1794.519944
FAX: 44/1794.519222

Designed for detailed electronic charting capability, the Garmin GPSMAP 182/182C/232 is a powerful navigation device that can give you the information you need:

Precision Performance

- 16-color TFT display with backlighting (GPSMAP 182C only)
- High-contrast, ten-level gray, LCD screen with backing (GPSMAP 182/232 only)
- 12-channel parallel receiver tracks and uses up to 12 satellites for fast, accurate positioning
- WAAS Capable — receive signals from the additional set of WAAS (Wide Area Augmentation System) satellites to give you better accuracy.
- Differential-Ready — just add an optional Garmin beacon receiver for better than 5-meter accuracy
- Fully gasketed, high-impact plastic alloy case, waterproof to IEC 529-IPX-7

Advanced Navigating and Plotting

- 3000 alphanumeric waypoints with selectable icons and comments
- Built-in Worldwide basemap to 20 miles includes detailed ocean, river and lake coastlines, cities, interstates, US state highways and local thoroughfares
- 50 reversible routes with up to 50 (254 GPSMAP 182C) waypoints each
- Uploadable maps using Garmin's MapSource PC products and BlueChart Data Cards
- Coordinates: Lat/Lon, UTM/UPS, Loran TD, plus 16 grids, including Maidenhead
- TracBack route feature which allows you to quickly retrace your track log to a starting position
- Built-in simulator mode
- Built-in tide information from over 3,000 tide stations around the USA coastline, Alaska, Hawaii, western Canada and several Caribbean Islands

Introduction

Capabilities

Superior Fishfinding Ability (when combined with the GSD 20 Sounder Module)

- Whiteline feature provides a clear image of bottom hardness and structure.
- See-Thru technology which helps separate fish returns from thermoclines and structure.
- Depth Control Gain (DCG) feature automatically adjusts fishfinder sensitivity according to depth
- Four Zoom levels with a moving view window, plus bottom lock.
- Underwater waypoint marking
- Map/Sonar split screen combines navigation and fishfinding ability.
- Fish and Depth alarms.

Introduction

Packing List

Before installing and getting started with your unit, please check to see that your package includes the following items. **If any parts are missing, please contact your Garmin dealer immediately.**

Standard Package:

- GPSMAP 182/182C/232 Unit
- GA 29 Remote Antenna and 30' cable*
- Internal Antenna, Bail Mount**
- Ferrite Bead Filter Clamp (GPSMAP 182C Only)
- Gimbal Mount and Knobs
- Power/Data Cable
- Owner's Manual
- Quick Reference Card
- Protective Cover

* Not included with part numbers 010-00238-01 or 010-00259-01 with internal bail mount antenna.

** Not included with part numbers 010-00238-00 or 010-00259-00 with remote antenna.

Optional Accessories:

- US A/C PC Adapter
- EURO A/C PC Adapter
- UK A/C PC Adapter
- Cigarette Lighter Adapter
- BlueChart Marine Data Cards, MapSource CDs, USB Data Card Programmer, and Data Cards
- GSD 20 Remote Sounder Module
- GBR 21 Beacon Receiver for differential corrections
- 2nd Mounting Station
- Marine Swivel Mount, 1" RAM® Mount (GPSMAP 182/182C Only)

Introduction i-viii

Foreword i
Preface/Registration/Software Licenseii
Warnings and Precautions iii
FCC Compliance iii
Warranty and Serial Number iv
Capabilities v
Packing List vi
“How To” Index viii

Section One: Getting Started 1-17

Keypad Usage, Selecting Options, Entering Data, Initializing the Receiver, Power On/Off, Backlighting, Simulator, Description of Main Pages, Simulated Tour

Section Two: Reference 18-67

Map Page and Options18
 Map Page Configuration24
Compass Page and Options27
Numbers Page28
Highway Page and Options28
Waypoints30
 Creating30
 Reviewing and Editing32
 Proximity35
Going to a Destination37
 TracBack38
 MOB40

Routes 41
 Creating 41
 Route List Page 43
 Reviewing and Editing 44
Active Route Page 48
Find Feature 49
Main Menu Page 51
 GPS Tab 52
 Tide Tab 56
 Trip Tab 58
 Celestial Tab 58
 Track Tab 59
 Time Tab 61
 Pages Tab 61
 System Tab 62
 Units Tab 63
 Communication Tab 64
 Alarm Tab 67

Appendix A: Loran TD 68
Appendix B: DSC 70
Appendix C: Time Offsets 76
Appendix D: Messages 77
Appendix E: Map Datums 79
Appendix F: Navigation Terms 81
Appendix G: Specifications 83
Appendix H: Installation 84
Appendix I: Index 90

Introduction

Table of Contents

Introduction

“How To” Index



The list to the right is provided to help you quickly find some of the more important procedures you will use on your new GPSMAP 182/182C/232.

TO DO THIS:	SEE PAGE(S):
Turn the unit on or off	4, 6, 17
Initialize the GPS receiver (first time use)	4-5
Adjust screen backlighting	6-7
Enter data and select options	2-3
Learn how to operate the unit's function keys.	1
Mark your present location as a waypoint	10, 30
Go to a destination	11-14, 37-38
Create and use a route	41-47
Learn about the Map page	8-9, 18-19
Pan using the map arrow	9, 19-20
Zoom in or out on the Map page	9, 20
Reconfigure the Map page display	24-26
Access the Main Menu	16, 51
Change units of measure (statute, nautical, metric)	63-64
Change the displayed time (zone)	61
Setup Loran TD	68-69
View tide information.	56-57
View celestial information	58
Set Alarms	67
Use the Find function.	49
View a unit message	77

Keypad Usage

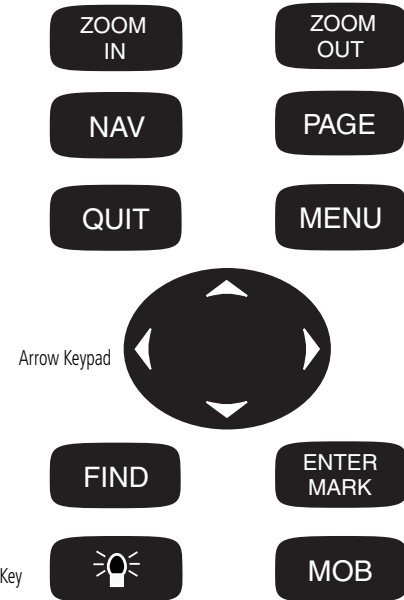

*Always press and release a key to perform its primary function. Pressing and holding the **ENTER/MARK** will activate the secondary function.*

ZOOM IN Key

The ZOOM IN/IN key adjusts the map scale to display a smaller area with more detail. (Zooms in)

ZOOM OUT Key

The ZOOM OUT/OUT key adjusts the map scale to display a larger area with less detail. (Zooms out)

NAV Key

The NAV key displays the Go To and Follow navigation menu.

PAGE Key

The PAGE key selects the main pages in sequence and returns display from a submenu page.

QUIT Key

The QUIT key returns the display to the previous page and, when entering data, it restores the previous value (cancels data entry).

MENU Key

The MENU key displays a menu of available options for the current page. Press twice to display the Main Menu.

ARROW KEYPAD

The ARROW KEYPAD is used to select (Highlight) menu options and enter data. It also controls cursor movement on the Map Page.

FIND Key

The FIND key activates the find function to search for nearby items and user waypoints.

ENTER/MARK Key

The ENTER/MARK key selects a highlighted menu option. When entering data, it allows you to initiate entry, and then to accept the selected value(s). It also marks the current location as a waypoint when pressed and held for more than one second.

POWER/ BACKLIGHT Key

The POWER/ BACKLIGHT key turns on/off the unit and display illumination. Also controls Contrast on monochrome units.

MOB Key

The MOB (Man OverBoard) key activates the Man OverBoard navigation feature when pressed.

Getting Started

Selecting Options

Hide Numbers
Change Numbers
Measure Distance
Set Up Map
Turn Declutter On
ENTER for Main Menu

Hide Numbers
Change Numbers
Measure Distance
Set Up Map
Turn Declutter On
ENTER for Main Menu

Options Menu with highlighted option.

Use the **ARROW KEYPAD** to highlight the next option. Press **ENTER/MARK** to activate.

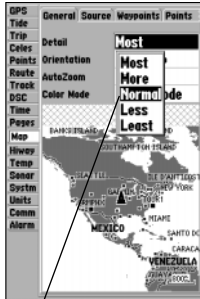

Pop-up list of options for a highlighted field.

2

How To Select Options and Enter Data

Before moving ahead into the features of the GPSMAP 182/182C/232, you will need to learn basic operations. You can select and activate options and enter data to customize the GPSMAP 182/182C/232 to fit your requirements. You can use the **ENTER/MARK** key and **ARROW KEYPAD** to select options, enter names and numbers in data fields, and activate your selections.

To select and activate an optional feature:

1. With any page displayed, press the **MENU** key to pop-up the options menu. The options menu will display a list of optional features which are specific for that particular page. To select any feature on the list of options requires movement of the cursor, which is identified as highlighting, selecting or choosing an item in a list or a field (box) on a page.
2. Use the **ARROW KEYPAD** to move the cursor (highlight) up and down a list or up, down, and sideways on menus.
3. Once you have moved to the selection desired, press the **ENTER/MARK** key to either activate the feature or the **MENU** key to pop-up a sub-menu or list of yet more feature options. Just repeat this process to select an option from the list or press the **QUIT** key to return to the previous setting.

The **QUIT** key will move backwards through these steps or when pressed, back to the main page you started on.

To select and activate a function button:

1. When moving about a page with function buttons, like the 'New Map Waypoint' page, you will observe functions such as 'Show Map', 'Delete' and 'OK'. To activate the function, highlight the desired button and press the **ENTER/MARK** key.

Naming a waypoint or placing any sort of data that has not been predefined requires the use of both the **ARROW KEYPAD** and the **ENTER/MARK** key.

To enter a name or number in a data field:

- Once you have accessed a page with programmable data fields (i.e. 'Waypoint Edit') you can use the **ARROW KEYPAD** to move the cursor (Highlight) to fields on the page. Use the UP/DOWN arrows to move up or down and the LEFT/RIGHT arrows to move sideways.
- Pressing the **ENTER/MARK** key with the field highlighted begins the process for entering data in the form of alphanumeric characters.
- Use the **ARROW KEYPAD** UP/DOWN arrows to cycle through numbers 0 to 9, plus/minus symbols, blank space, and the alphabet. Pressing and releasing the keypad moves you character by character through the list. Pressing and holding the keypad moves you rapidly through the list.
- Use the **ARROW KEYPAD** LEFT/RIGHT arrows to move to the next character on the line or backwards to edit characters. If there are more than two lines of data, keep pressing to the RIGHT to drop down to the next line.
- When data entry is completed press **ENTER/MARK** to accept data, then move to the next programmable field. Not all data fields are programmable, like the date and time. When moving about a page with these type of fields, the cursor will skip over them.

Every field and button on this page can be programmed or activated.

- A waypoint symbol can be selected from a list of symbols.
- A comment can be added.
- The coordinates can be changed.

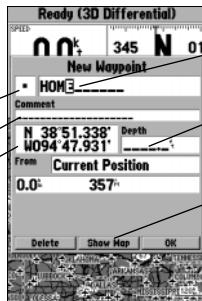

- The waypoint can be renamed.
- A depth can be entered.
- Option buttons can be activated.

Getting Started

Entering Data

N 28°28.327'
W082°42.401'

N 28°28.328'
W082°42.401'



Pressing **UP** or **DOWN** on the **ARROW KEYPAD** changes numbers and letters.

N 28°28.328'
W082°42.401'

N 28°28.328'
W082°42.401'



Pressing **LEFT** or **RIGHT** on the **ARROW KEYPAD** moves the cursor along the line or to the next line.

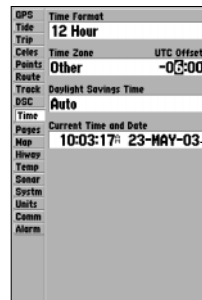

Data Entry Field

Non-programmable data fields

Getting Started

Initializing the Receiver



GPSMAP 182/
182C/232 Warning
Screen (232 shown)

The GPSMAP 182/182C/232's advanced keypad system is designed to allow for fast, convenient selection of navigation options and data entry. The Getting Started Tour will introduce you to the keypad and provide a 'hands-on' lesson in using the GPSMAP 182/182C/232. We strongly encourage you to take the Getting Started tour before using your unit for actual navigation.

The GPSMAP 182/182C/232 Quick Reference Guide contains helpful tips on using the unit and performing various navigation tasks. It's a good idea to keep the Quick Reference Guide nearby whenever you're operating your new GPSMAP 182/182C/232.

Initializing the Receiver

The first time you power up your new GPSMAP 182/182C/232, the receiver must be given an opportunity to collect satellite data and establish its present position. To ensure proper initialization, the GPSMAP 182/182C/232 is shipped from the factory in AutoLocate mode, which will allow the receiver to "find itself" anywhere in the world. To speed up the initialization process, we recommend using the graphic initialization process described on the next page, which will usually provide a position fix within a few minutes.

Before you initialize, make sure the GPSMAP 182/182C/232 unit and antenna have been correctly installed on your vessel according to the instructions in Appendix H. The antenna needs to be in a location with a clear and unobstructed view of the sky to receive satellite signals.

To turn the GPSMAP 182/182C/232 on:

1. Press and hold the **POWER** key until the power tone sounds and the display comes on, then release the **POWER** key.

A warning page will appear, asking you to read and acknowledge important information regarding the proper use of the unit.

To acknowledge the warning:

1. After reading the warning, press the **ENTER/MARK** key if you agree.

Initializing the Receiver

To graphically initialize the GPSMAP 182/182C/232:

1. Press the **MENU** key twice for the Main Menu. Press Up or Down on the **ARROW KEYPAD** until the 'GPS' tab is highlighted, then press the **MENU** key once.
2. Using the **ARROW KEYPAD**, highlight 'Initialize Position' and press **ENTER/MARK** to initialize the receiver from the map. The Initialize Position Page will appear, prompting you to select your approximate location with the map cursor.
3. Use the **ARROW KEYPAD** to move the map cursor and point to your approximate location within 200 miles. If you have difficulty identifying your position, press and release the **IN** key to see the next lower map scale.
4. Once you have determined your approximate location on the map, press the **ENTER/MARK** key.



This does not "calibrate" the unit in any way, but rather helps to speed up the initial satellite acquisition. If the unit displays 'Ready (2D) or (3D)' during this process, it is not necessary to initialize the unit.

The GPSMAP 182/182C/232 will now begin searching for the appropriate satellites for your region and should acquire a fix within a few minutes. When viewing the 'GPS' tab on the Main Menu, a signal strength bar for each satellite in view will appear on the bottom of the page, with the appropriate satellite number under each bar. The progress of satellite acquisition is shown in three stages:

- No signal strength bars—the receiver is looking for the satellites indicated.
- Hollow signal strength bars—the receiver has found the indicated satellite(s) and is collecting data.
- Solid signal strength bars—the receiver has collected the necessary data and the satellite(s) are ready for use.

Once the receiver has collected information from at least three satellites, the top of the screen will display either "Ready (2D or 3D)", and the GPSMAP 182/182C/232 is ready for use.

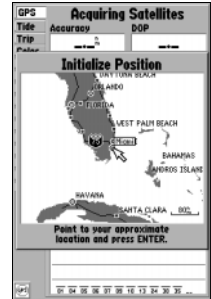

Point to your approximate location and press ENTER/MARK.

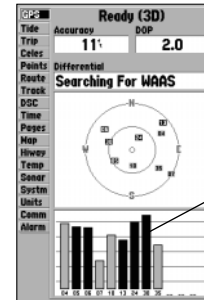

A satellite's strength bars will turn black when it's ready for use.

Getting Started

Power On/Screen Backlighting

A full-screen GPS Information pop-up page is displayed after you press the **ENTER** key to acknowledge the Warning Page. The pop-up page will go away after the unit gets a position fix or you press either **ENTER** or **QUIT**. The page can be disabled and enabled on the Pages Tab (see page 61).

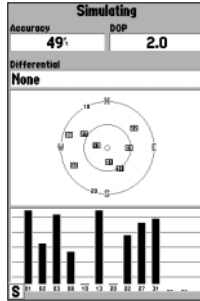

Press **UP** or **DOWN** on the **ARROW KEYPAD** to move the backlighting slider up for brighter or down for dimmer backlighting. (182C shown)

GPSMAP 182/182C/232 Getting Started Tour

The Garmin GPSMAP 182/182C/232 is a powerful electronic navigation system that provides detailed map coverage and convenient control of many advanced features right from the screen display. This tour is designed to take you through the basic pages and functions of the system using the simulator mode. Once you're familiar with the main pages and functions of the unit, refer to the reference section for instructions on performing specific tasks and functions. For GSD 20 sonar related operations, refer to "GSD 20 Sounder Module with Garmin Chartplotters" (190-00241-03).

The Getting Started Tour assumes that the receiver has been properly installed and initialized, and you have not changed any of the default unit settings. If you have changed any settings (position formats, units of measure, etc.), the descriptions and pictures in the tour may not match your configuration.

To turn the GPSMAP 182/182C/232 on:

1. Press and hold the **POWER** key until the power tone sounds, then release the **POWER** key. The Warning Page will appear while the unit conducts a self-test.
2. Once the self-test is complete, press the **ENTER/MARK** key, if you agree, to acknowledge the warning.

The GPS Information Page will appear as the receiver begins acquiring satellites. From this or any other page, you may also adjust the screen backlighting.

The GPSMAP 182/182C/232's adjustable screen backlighting is controlled with the **POWER** key, and may be adjusted at any time from any page. The backlight can cycle through minimum, user-defined, and maximum backlight levels by repeatedly pressing the **POWER** key.

To adjust the backlighting:

1. Press **POWER** and the Light window will appear.
2. Press **POWER** again and the user-defined level of backlighting will activate. You may adjust this level by pressing UP or DOWN on the **ARROW KEYPAD**. If you press **POWER** one more time, the backlighting will be at the maximum setting.
3. Press **ENTER/MARK** or **QUIT** when done.

The backlight will now cycle through minimum, the user-defined, and maximum backlight levels by repeatedly pressing the **POWER** key. You may also adjust the screen contrast (GPSMAP 182/232 monochrome only).

To adjust the screen contrast:

1. Press **POWER** and the Light and Contrast window will appear.
2. To decrease or increase the screen contrast, press left or right on the **ARROW KEYPAD**.
3. Press the **ENTER/MARK** key to finish.

Each page of the GPSMAP 182/182C/232's system also features an options page, which gives you access to other functions and features that relate to the specific page you are viewing. To get a feel for how the options pages work, let's put the GPSMAP 182/182C/232 into simulator mode.

To place the GPSMAP 182/182C/232 in simulator mode:

1. Press the **MENU** key twice for the Main Menu. Press Up or Down on the **ARROW KEYPAD** until the 'GPS' tab is highlighted, then press the **MENU** key once.
2. Use the UP or DOWN arrow of the **ARROW KEYPAD** to highlight the 'Start Simulator' option and press **ENTER/MARK**. Choose 'No' to the retail demonstration and press the **ENTER/MARK** key.
3. Press the **ENTER/MARK** key to confirm the 'Running Simulator' message that appears at the bottom of the display. 'Simulating' will appear at the top of the Main pages.

While in Simulator mode, a 'Running Simulator' message will appear after 2 minutes of inactivity. Now you're ready to continue the rest of the simulated tour. Keep in mind that the GPSMAP 182/182C/232 does not track satellites in simulator mode, and this mode should never be used for actual navigation. All the waypoint and route planning done in simulator mode will still be retained in memory for future use.

Getting Started

Backlighting/ Simulator Mode

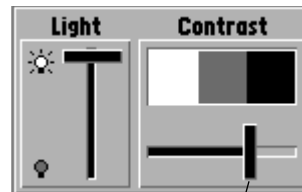

To adjust the screen contrast, press **LEFT** or **RIGHT** on the **ARROW KEYPAD** to move the contrast slider. (non-color units)

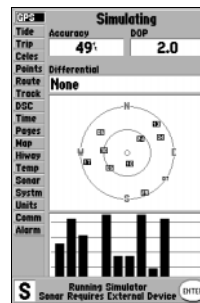

A "Running Simulator" message will appear after 2 minutes.

Getting Started

Map Page

The Map Page is one of six main pages used in the GPSMAP 182/182C/232s system. The six main pages are the Map Page, Sonar Page (If equipped with GSD 20. For GSD 20 sonar related operations, refer to “GSD 20 Sounder Module with Garmin Chartplotters” (190-00241-03)), Compass Page, Numbers Page, Highway Page, and Active Route Page. All five pages are linked together in a simple chain, which allows you to scroll through the pages in either direction using the **PAGE** and **QUIT** keys.

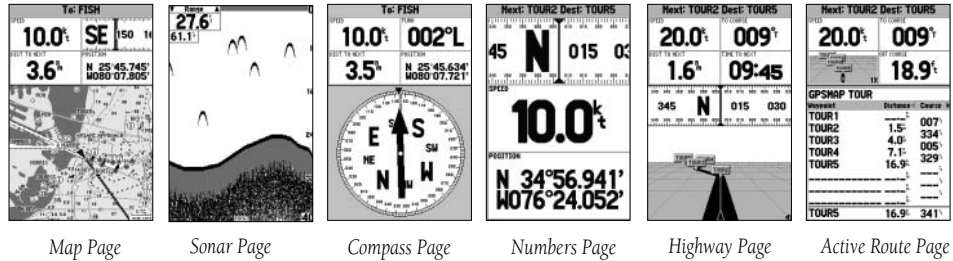

The GPSMAP 182/182C/232s Map Page combines digital chartplotting with a user-selectable display of navigation data and a built-in worldwide database. It will also be the page you use most to create and edit waypoints and routes. Before we take off on our practice route, let's take a brief look at its various features and displays.

The map display shows your “boat” as a triangle marker on an electronically generated chart. Geographic names, roads, markers and buoys that are provided by the optional BlueChart or MapSource data are also shown. It also displays your track, routes and nearby waypoints. An on-screen cursor lets you pan to other map areas, determine the range and bearing to a position, and perform various waypoint and route functions.

The data window, located at the top of the page, provides a user-selectable display of various navigation data, including speed over ground, distance to the next navigation point, compass ribbon and current position coordinates. The current map scale setting is located at the bottom right of the page.

Using the Map Cursor

Working from the Map Page is a simple process that centers around the use of the cursor. Controlled by the **ARROW KEYPAD**, the cursor is an important tool that can be used to pan to other map locations, mark and edit waypoints and routes, and review position data of on-screen map items and waypoints.

To get a feel for using the Map Page and using the cursor, try the following exercise:

1. Use the **IN/OUT** keys to set the map scale to the 50 nm setting. Your boat should be near the center of the map, at the receiver's last known position. (If your boat isn't where it should be, make sure that you have initialized the receiver and acquired a position as described on pages 1-2.)
2. Use the **ARROW KEYPAD** to move the cursor. Notice how another data field appears, showing the bearing and distance from your boat to the cursor, along with the latitude/longitude of the cursor.
3. Press the **QUIT** key to remove the cursor and re-center your boat on the map display.

As you become more familiar with the cursor, you'll see that the map display actively scrolls or 'pans', letting you explore areas around the world and create waypoints and routes. Wherever you move the cursor, you'll always be just one **QUIT** keystroke away from returning the map to your present position.

Now that you've seen how the Map Page can be used to monitor your present location, let's take a minute to learn how to mark and store your present position as a waypoint. (Since you're in simulator mode, the present position displayed will be the last position calculated by the receiver, which should be the spot where you've initialized the unit.) This will also give you an opportunity to see how the GPSMAP 182/182C/232's keypad and **ENTER/MARK** key are used for data entry and changing the waypoint name and symbol.

Map Cursor

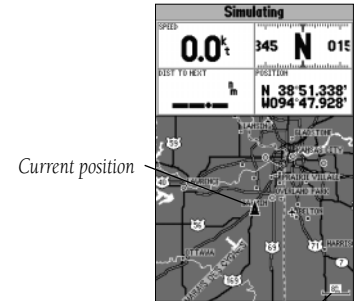

Map Scale

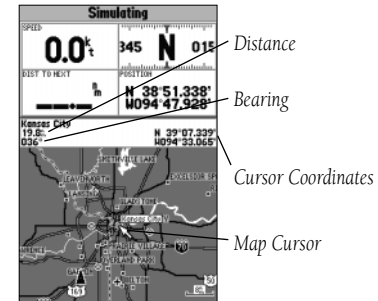

Getting Started

Marking Waypoints



Press **ENTER/MARK**
after entering the name

You can choose from a list of useful symbols. There are two Diver Down waypoint symbols to select from: the International version and the U.S. version.

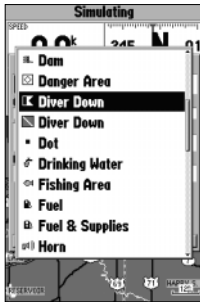

To mark your present position:

1. Hold down the **ENTER/MARK** key until the 'New Waypoint' window appears then release the key. The window will show a default three-digit waypoint name/number (001), symbol (dot), and position. You can leave the name as the auto-assigned number, but for this exercise, let's change the name to 'DOCK'.
2. Use the **ARROW KEYPAD** to highlight the waypoint name field (001) and press **ENTER/MARK**. You will see that just the first '0' is now highlighted.
3. Press LEFT on the **ARROW KEYPAD** to clear the name field.
4. Press UP or DOWN on of the **ARROW KEYPAD** until the letter 'D' appears, and then press RIGHT to go to the next space to the right, then UP or DOWN again until 'O' appears. Repeat this until you have entered the name 'DOCK'. If you make a mistake and select an incorrect character, simply press LEFT on the **ARROW KEYPAD** to backspace the cursor and then UP or DOWN to correct the entry. (If you accidentally press **ENTER/MARK** before you are done, simply press **ENTER/MARK** again and move the highlight to where you left off.)
5. After you have entered all the letters, press **ENTER/MARK** to confirm the name.
6. To access the waypoint symbol page, highlight the waypoint symbol field which is to the left of the waypoint's name and press **ENTER/MARK**. Note: The default symbol is a dot.
7. You will see an alphabetical list of available waypoint symbols to choose from. Press the **ARROW KEYPAD** UP or DOWN until you highlight the 'ANCHOR' symbol. You will see a scroll bar on the right of the window indicating your current position on the entire list of symbols.
8. Press **ENTER/MARK** to confirm the 'ANCHOR' symbol.
9. Highlight 'OK' at the bottom of the window and press **ENTER/MARK** again to confirm the 'OK' prompt and save the waypoint.

The waypoint is now stored in memory. Note that waypoints may also be created graphically from the map display or by manually entering position coordinates. Each of these techniques is described in the reference section of the manual and/or on your GPSMAP 182/182C/232 Quick Reference Guide.

Going to a Destination

GPS is all about marking positions as waypoints and navigating to them using the receiver's steering guidance and map displays. We've already seen how to use the **ENTER/MARK** key to store our present position, so it's time to move on to the fun part—going to a destination.

The **NAV** key, located on the keypad above the **QUIT** key, is the primary tool used to select a destination waypoint, TracBack, or a route to navigate. The **NAV** key can be used in two primary ways:

- Pressing **NAV** once displays a list of options from which you can select 'Go To Point', 'Follow Route', 'Follow Track', or 'Stop Navigation'.
- Highlighting an on-screen waypoint or map item as a destination directly from the Map Page and pressing **NAV** allows you to graphically select points to "Go To".

For our simulated trip, you're going to select a pre-programmed tour route using the first method. This will also show how the **MENU** key is used throughout the GPSMAP 182/182C/232 system to provide tab style options and functions. Let's start by changing the position to where the practice route is located.

To change the GPSMAP 182/182C/232 position in simulator mode:

1. Press the **MENU** key twice to display the list of Main Menu tab items.
2. Use the UP or DOWN arrow of the **ARROW KEYPAD** to highlight the 'System' tab.
3. Highlight 'Set Position' in the simulator setup window and press **ENTER/MARK**.
4. From the Initialize Position page, press the **MENU** key. You will see 'Enter As Text' highlighted, then press **ENTER/MARK**.
5. On the Enter Position window, press **ENTER/MARK** then use the **ARROW KEYPAD** to enter N34°56.800', W076°24.066' and press **ENTER/MARK** when done, then press **QUIT** to return to the Map Page.

Getting Started

Using the NAV Key

Text entry for simulator position.

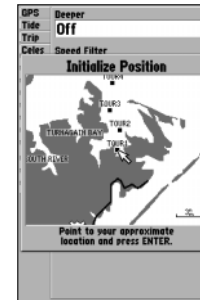
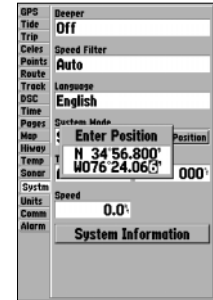

For future practice, you may skip steps 3 and 4 and point to a location from the Initialize Position page.

Getting Started

Simulated Tour

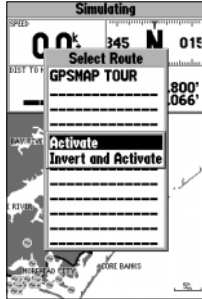

You can also Invert a route to follow it in reverse.

The Set Position, Track Control, Track and Speed fields will only show while in simulator mode.

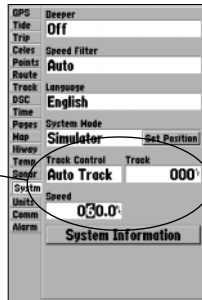

To activate the practice route stored in memory for navigation:

1. Press **NAV**. The option list page will appear. (If we were selecting a single waypoint to navigate to rather than a route, we could highlight the waypoint on the map, press **NAV** and then press **ENTER/MARK**.)
2. Use the **ARROW KEYPAD** to highlight the 'Follow Route' option. Press **ENTER/MARK** to confirm.
3. The Select Route page will appear, with the 'GPSMAP TOUR' route highlighted.
4. Press **ENTER/MARK** then highlight 'Activate' and press **ENTER/MARK** again.

To zoom in to a closer map scale:

1. Repeatedly press the **IN** key until you select the 3 nm scale.

You may also hold the **IN** or **OUT** keys down to quickly scroll through the map scales. The Map Page should now display five waypoints chained together in a simple route, with your boat at the first route waypoint.

A data field at the top of the page will now display the speed, distance to the second route waypoint, your position coordinates and a compass ribbon which shows you which way to go. To get started, let's enter a speed for our vessel, which we can do from the Main Menu Page.

To enter a boat speed:

1. Press the **MENU** key twice to display the Main Menu Page.
2. Use the **ARROW KEYPAD** to highlight the 'System' tab, then press **RIGHT** then **DOWN** until the field below the word 'Speed' is highlighted and press **ENTER/MARK**.
3. Use the **ARROW KEYPAD** to enter a speed of 60 knots.
4. Press **ENTER/MARK** to finish, and **QUIT** until you return to the Map Page.

Once a speed has been entered, you'll notice that the map will automatically begin to move slowly, keeping your boat centered on the display. The direction of movement, also called 'track', will be controlled by the simulator.

Getting Started

You'll now have a clearer picture of the route you are navigating. Keep in mind that whenever you do exceed the usable range of the built-in database or the optional MapSource or BlueChart data in use, the range field will display 'OVERZOOM' to indicate that you should exercise extreme caution using the map data. Press the **IN** key to zoom into the 2 nm scale. Now that you've zoomed in a little closer to your route, you can pan ahead of your vessel with the cursor to review map items and create on-screen waypoints. Try moving the cursor to highlight the 'TOUR3' waypoint— just use the **ARROW KEYPAD** to move the cursor as close as possible to the waypoint. (To move the cursor in small increments, try a series of short key presses.)

Once the cursor is over the TOUR3 waypoint, you'll notice that the waypoint symbol and name will become highlighted. The data field at the top of the page will display the waypoint name, the range and bearing from your present position, and the coordinates for the waypoint.

To review the waypoint page for a selected waypoint:

1. Press the **ENTER/MARK** key.
2. To return to the Map Page, press **ENTER/MARK** again or press **QUIT**.

The cursor can also be used to create new waypoints right from the map display.

To create a new waypoint using the cursor:

1. Use the **ARROW KEYPAD** to move the cursor as close as possible to the following position: N35° 02.914; W 076° 26.152' (Use the data window to verify the cursor position.)
2. Press and release the **ENTER/MARK** key to capture the cursor position. Do not hold the button down, as doing so will mark your present position, not the map position.
3. Use the **ARROW KEYPAD** to highlight the waypoint symbol field to the left of the waypoint name/number.
4. Press **ENTER/MARK** to access the symbol page.
5. Press UP or DOWN on the **ARROW KEYPAD** to select the 'Shipwreck' symbol and press **ENTER/MARK** to confirm.
6. Highlight 'OK' at the bottom and **ENTER/MARK** again to finish.

Reviewing/Creating Map Waypoints

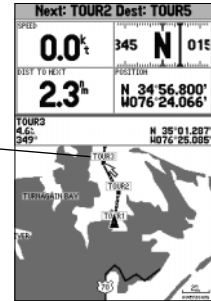

The waypoint will 'highlight' when the cursor is moved over it.

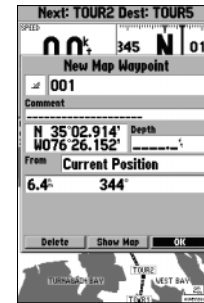

Waypoint numbering will start with 001 and continually count up, even if the waypoint name has been deleted.

Getting Started

Compass/Numbers Navigation Pages

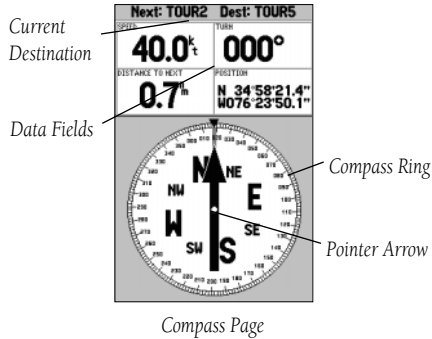

Numbers Page

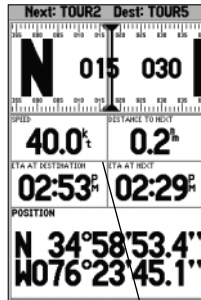

Numbers Page with split numbers

Now that we're navigating to an actual destination, let's move on to the GPSMAP 182/182C/232 navigation pages by pressing the **PAGE** key.

The Compass Page provides graphic steering guidance to a destination waypoint, with an emphasis on the bearing to your destination and current direction of travel. The middle of the page features a rotating 'compass ring' that shows your course over ground (track) while you're moving, and a bearing pointer that indicates the direction of the destination (bearing) relative to the course over ground. The compass ring and pointer arrow work independently to show—at a glance—the direction of your movement and the direction to your destination. For instance, if the arrow points up, you are going directly to the waypoint. If the arrow points any direction other than up, turn toward the arrow until it points up—then continue in that direction.

The current speed, distance to the next waypoint, turn angle and current position are displayed at the top of the screen. This page provides better steering guidance when travelling at slower speeds and/or when making frequent directional changes. When you are not navigating to a waypoint, the compass will show your direction of travel as you move but the arrow will not appear.

Press **PAGE** to see the next page appearing in the main sequence, the Numbers Page. The Numbers Page allows for precision navigation to 1 degree of steerage. The default page will display 3 large numbers fields. You may customize the Numbers Page to display the size and number of fields along with the type data you wish to see. (See pages 22-23 for changing the types of data.)

To split the data fields:

1. Press **MENU**, then press **ENTER/MARK**. Highlight the 'SPEED' data field and press **MENU**.
2. Highlight 'Split Numbers', then press **ENTER/MARK**. You will now see four new data fields. Press **QUIT** when done.
3. To return to the original configuration, repeat the above steps, but instead of 'Split Number', select either 'Merge Numbers' or 'Defaults'. Press **QUIT** when done.

Let's move on to the Highway Page by pressing the **PAGE** key.

Getting Started

The GPSMAP 182/182C/232's Highway Page also provides graphic steering guidance to a destination waypoint, placing greater emphasis on the straight-line desired course and the distance and direction you are off course. As you head toward your destination, the middle of the screen provides visual guidance to your waypoint on a moving graphic "highway." Your present position is at the bottom center of the highway display. The line down the middle of the highway represents your desired course. As you navigate toward a waypoint, the highway will actually move—indicating the direction you're off course. To stay on course, simply steer toward the center of the highway or "keep it on the road". The four default data fields at the top of the page indicate 'Speed' and 'Distance To Next' point, along with 'To Course' which shows the bearing to get you back on course and 'Time To Next' point. Additionally, a compass ribbon is displayed to show your current heading along with a dark, vertical bar which will indicate the direct bearing to the navigation point. When the dark, vertical indicator (or arrow) lines up with the lighter red bar in the middle, you are heading directly to the navigation point. Use the Highway Page as your primary navigation page (in lieu of the Compass Page) when your main concern is following a defined course.

Whenever the GPSMAP 182/182C/232 is in simulator mode, you can also adjust your speed and course from the Highway Page using the **ARROW KEYPAD**. As you head toward each waypoint in the tour route, try adjusting your boat speed and course to get a feel for how the highway works.

To adjust the simulated boat speed/heading from the Highway Page:

1. Press the UP arrow of the **ARROW KEYPAD** to increase the speed in 10 knot/kph/mpH increments. Press the DOWN arrow to decrease the speed in the same increments. Press the LEFT and RIGHT arrows of the **ARROW KEYPAD** to steer the boat.

Notice that as you get off course, the highway will move to give you graphic guidance to get back on course. You can zoom in or out on the Highway display for a smaller or larger view. Five available settings range from 1X to 16X, with a default setting of 8X. The current scale will appear in the bottom right of the display.

To zoom in or out on the highway display:

1. Press either the **IN** or **OUT** key to increase or decrease the zoom scale.

Highway Page

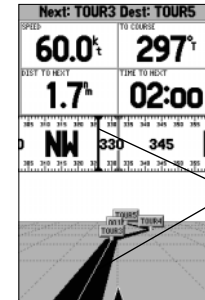
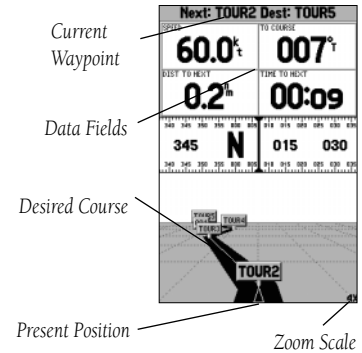

Steer towards the center of the highway or towards the black vertical bar on the compass ribbon to get back on course.

Getting Started

Active Route Page/ Main Menu Page

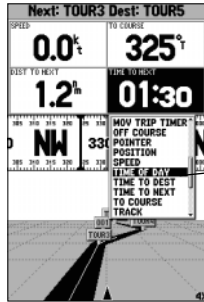

You may choose from several different types of data.

Current
Waypoint

Waypoint	Distance	Course
TOUR1	---	---
TOUR2	---	---
TOUR3	0.8	334°
TOUR4	3.9	005°
TOUR5	13.7	329°

TOURS	13.7	341°
-------	------	------

Active Route Page

The main pages' data fields may also be configured to display several different information categories (see pages 22-23 for the complete list). On the Highway Page, let's change the 'TIME TO NEXT' field to 'TIME OF DAY'.

To change a data field:

1. Press the **MENU** key to display the Highway Page options.
2. Press DOWN on the **ARROW KEYPAD**, highlight 'Change Numbers' and press **ENTER/MARK**.
3. Once the menu window disappears, use the **ARROW KEYPAD** and highlight 'TIME TO NEXT', then press **ENTER/MARK**.
4. On the alphabetical list of options, press the **ARROW KEYPAD UP** or **DOWN** until you highlight 'TIME OF DAY' and press **ENTER/MARK**. (You will see a scroll bar on the right side of the window indicating your current position on the entire list of options.)
5. Press the **QUIT** key when done.

Press **PAGE** to see the last page appearing in the main sequence, which is the Active Route Page. Whenever you have activated a route or Follow Track, this page will show each waypoint name along with useful data for each point. As you navigate the route, the information will automatically update to indicate the next point along the route. For more detailed information on the Active Route Page, see page 48.

As you've seen, the primary pages provide map and navigation information. The tour's last page is the Main Menu page, which allows access to the GPSMAP 182/182C/232's waypoint, route and planning functions, as well as various operational and navigation setup features, and celestial and tide data.

The Main Menu is available from any page, and is accessed through the **MENU** key.

To access the main menu page:

1. Press the **MENU** key twice.

The Main Menu page lists 18 menu 'tabs' that are divided into categories by function. You can view a particular menu by simply highlighting the desired tab, which will then show any secondary submenu tabs and options for that tab.

To get a basic feel for how the Main Menu page works, let's delete the two waypoints you created during the simulated tour. This will ensure that you have a clean slate once you start navigating in your home waters.

To select the Points (Waypoint) submenu tab:

1. Use the **ARROW KEYPAD** to highlight the 'Points' menu tab. You will see a list of stored waypoints appear to the right of the Main Menu list.
2. Press to the right one time on the **ARROW KEYPAD** and you will see the 'User' tab highlighted.
3. Press down on the **ARROW KEYPAD** until waypoint 001 with the shipwreck symbol is highlighted.
4. You may delete the waypoint by either pressing **MENU**, then highlighting 'Delete Waypoint' or press **ENTER/MARK** and then highlight 'Delete' from the Waypoint Edit page.
5. Press **ENTER/MARK** to delete the waypoint, then **ENTER/MARK** again to confirm. Repeat the above steps to delete the 'Dock' waypoint also.

Congratulations! You've now gone through the basic operation of the Garmin GPSMAP 182/182C/232. Your new digital chartplotter is a powerful tool with many advanced features not covered in the Getting Started tour. For detailed instructions on using these features or performing a specific task, please refer to the Quick Reference Guide or the appropriate reference section of this manual. If equipped with GSD 20, refer to the "GSD 20 Sounder Module with Garmin Chartplotters" (190-00241-03) for sonar operations. The unit is still in Simulator mode for practice, but will automatically return to its 'Normal' operation mode when you shut it off and turn it back on.

To turn the GPSMAP 182/182C/232 off:

1. Press and hold the **POWER** key for about 2 seconds, until the screen is blank.
2. When the screen is blank, release the **POWER** key.

The next section of the manual describes the pages and functions of the GPSMAP 182/182C/232 in detail. If you are unable to locate a specific option or function, please refer to the index on pages 90-92. Thank you for choosing the Garmin GPSMAP 182/182C/232 navigation unit. We hope it will be a useful and fun tool for you wherever you go!

Getting Started

Deleting Waypoints/ Powering Off Unit

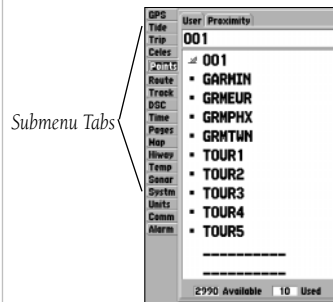

Main Menu

Reference

Map Page

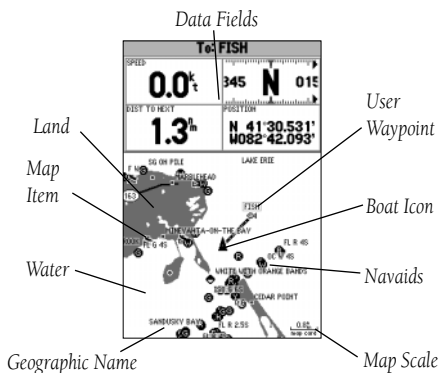

Map Page shown using optional MapSource data.

Map Page

The GPSMAP 182/182C/232's Map Page provides a comprehensive display of electronic cartography, plotting and navigational data. When using the unit with the optional BlueChart data or MapSource software, the map display shows your boat on a digital chart, complete with geographic names, map items, nav aids and a host of other chart features. It also plots your track and displays any routes and waypoints you create. An on-screen cursor lets you pan and scroll to other map areas, determine the distance and bearing to a position, and perform various route and waypoint functions.

When the cursor is active, an additional data window will appear below the data fields to indicate the position, range and bearing to the cursor or a selected waypoint or map item. The map scale displays at the bottom right of the page.

The **(ZOOM) IN** and **(ZOOM) OUT** keys, combined with the **ARROW KEYPAD**, let you select zoom ranges and move the cursor. Two basic map operating modes, position mode and cursor mode, determine what cartography is shown on the map display. Position mode pans the cartography to keep the present position marker within the display area, while cursor mode pans the cartography to keep the cursor within the display area.

The GPSMAP system will always power up in the position mode, with your vessel centered on the map display.

- When sufficient map coverage is not available to keep the boat centered, the boat icon will move toward the edge of the display.

When the **ARROW KEYPAD** is pressed, the GPSMAP 182/182C/232 will enter cursor mode. In cursor mode:

- The cursor can be moved over the map display using the **ARROW KEYPAD**.
- Whenever the cursor reaches the edge of the display, the map will scroll forward under the cursor. Keep in mind that the boat icon will move with the map scrolling and may go off the display screen (you may not be able to see your present position).

- When the cursor is stationary, a fixed coordinate position will appear in the position field. Note that the distance and bearing will change as the boat's position changes.
- Whenever you zoom in cursor mode, the cursor will be centered on screen.
- To return to position mode, press the **QUIT** key.



When the cursor reaches the edge of the map, the unit may pause as it loads new map data.

Using the Cursor

The cursor allows you to pan away from your present position and scroll to other map areas around the world (even outside of your current detail coverage). As you pan past the edge of the current map display, the screen will actively scroll forward to provide continuous map coverage. You will see an hourglass symbol by the pointer while the unit is busy drawing new map detail.

To move the cursor:

1. Press the **ARROW KEYPAD** to move the cursor in an up, down, left or right direction.

As you move the cursor, the distance and bearing from your present position to the cursor will be displayed in the data window, along with the cursor's position coordinates. Keep in mind that when the cursor is stationary, the distance and bearing from your present position will change as your boat moves. The cursor may also be used to 'snap' to on-screen waypoints and map items, allowing you to review a selected position directly from the map display.

To select an on-screen waypoint or map item with the cursor:

1. Use the **ARROW KEYPAD** to move the cursor to the desired waypoint or map item (if there are several waypoints grouped closely together, zoom in closer for a better view).
2. When a waypoint or map item is selected, it will become highlighted on screen, with the name and position displayed. Press **ENTER/MARK** to show details of the map item. When using BlueChart or MapSource data, additional information tabs will appear. Use the **ARROW KEYPAD** to highlight the individual tabs to display the information and additional options.

Reference

Map Page Cursor

Move the cursor over an item on the map to highlight it.

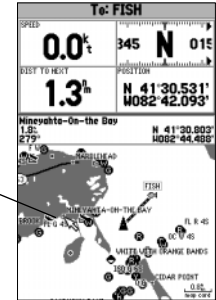

Additional information tabs.

*Pressing **ENTER/MARK** while highlighting a map item will bring up additional details and options.*

Option buttons

Reference

Map Page Cursor and Zooming



Creating New Map Waypoint



Using Built-In Basemap



Using BlueChart/MapSource Data



Overzoom, no additional data

To eliminate the cursor and re-center your position on-screen:

1. Press the **QUIT** key.

The cursor may also be used to create new waypoints directly from the map.

To create a waypoint with the cursor:

1. Use the **ARROW KEYPAD** to move the cursor to the desired map position.
2. Press the **ENTER/MARK** key and the 'New Map Waypoint' window will appear. If the cursor is on a map item, you will get a new window with details about the item when **ENTER/MARK** is pressed. Press **ENTER/MARK** again on the highlighted 'Create Wpt' option.
3. Press **ENTER/MARK** to confirm the new waypoint using the default three-digit name and symbol.

Selecting Map Scales

The map display has 28 available range scales from 20 ft. to 800 mi. (5 m to 1200 km). The map scale is controlled by the **IN** and **OUT** keys, with the current scale displayed at the bottom right of the data window.

To select a map scale:

1. Press the **OUT** key to zoom out and the **IN** key to zoom in.



The scale value represents the distance from one end of the scale bar to the other.

The GPSMAP 182/182C/232's system has a built-in worldwide database to 20 mi, with more detailed coverage available through the use of the optional BlueChart or MapSource data. The GPSMAP 182/182C/232 will display cartography as long as there is chart information available for the range you've selected. Map coverage will conform to the following conditions:

- When the selected zoom range is covered by either the internal database, BlueChart, or MapSource data, cartography will be displayed.
- When the selected zoom range is covered by both the internal database and BlueChart/MapSource data, cartography will be displayed using the data with the best resolution.
- When the selected zoom range exceeds the resolution of the data in use, overzoom cartography will be displayed and an 'overzoom' warning will appear below the scale field.

Map Page Options

Many features of the GPSMAP 182/182C/232 are menu driven. Each of the main pages have an options menu, allowing you to custom tailor the corresponding page to your preferences and/or select special features that specifically relate to that page. The data window, located at the top of the main pages provides a user-selectable layout of various types of useful data. Each data field may be configured to display any one of several data options. The data window layout may also be changed to display additional data fields and change the actual size of the data displayed.

The GPSMAP 182/182C/232's Map Page provides access to functions and features relating to the Map Page and the layout options.

To display the Map Page options:

1. Press **MENU**.

To select a menu option:

1. Use the **ARROW KEYPAD** to highlight the desired option and press **ENTER/MARK**.

The available options are Full Screen Map/Show Data, Change Numbers, Measure Distance, Show Sonar (If equipped with GSD 20. See the "GSD 20 Sounder Module with Garmin Chartplotters" (190-00241-03) for details on this feature.). Set Up Map and Turn Declutter On/Off. Following are details on using each of these options.

• **Full Screen Map/Show Data** — toggles between a Map Page without or with data fields on the map display.

To maximize the map/show data fields:

1. Highlight the 'Full Screen Map' option and press **ENTER/MARK**. The Map Page will now be maximized with no data fields.
2. To show the data fields again, press **MENU**, highlight 'Show Data' and press **ENTER/MARK**.

Map Page Options

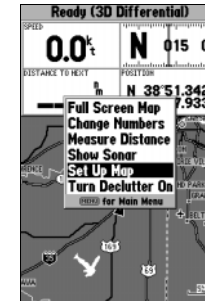

Map Page Options

Reference

Map Page Options



Highlight the field you wish to change

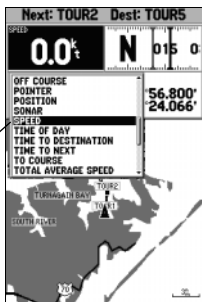

Choose the type of data you wish to display.

• **Change Numbers** — allows you to specify the type of data displayed in each data field used on the map display. This option is available from any of the main pages.

To change a data field:

1. From the menu, use the **ARROW KEYPAD** to highlight the 'Change Numbers' option and press **ENTER/MARK**.
2. Move the field highlight to the data field you want to change and press **ENTER/MARK**.
3. Move up or down on the list using the **ARROW KEYPAD** to highlight the data you want to display, and press **ENTER/MARK**. To exit, press **QUIT**.

The following data options are available for data fields on the main pages:

- BEARING – Compass direction from your position to destination
- COMPASS – Compass ribbon
- COURSE – Desired Track
- DEPTH* – Depth below transducer
- DIST TO DESTINATION – Distance to final waypoint
- DIST TO NEXT – Distance to next waypoint
- ELEVATION – Elevation above/below MSL (Mean Sea Level)
- ETA AT DESTINATION – Estimated Time of Arrival to final waypoint
- ETA AT NEXT – Estimated Time of Arrival to next waypoint
- GPS ACCURACY – Shows estimated GPS accuracy
- HIGHWAY – Smaller version of the Highway Page
- MAXIMUM SPEED – Fastest speed the unit has traveled
- MOVE AVERAGE SPEED – Average moving speed
- MOVE TRIP TIME – Time unit has been moving for a trip
- OFF COURSE – Distance from desired track
- POINTER – Arrow points to your destination
- POSITION – Current position coordinates
- SONAR* – Compressed view of sonar data
- SPEED – Speed over ground
- TIME OF DAY – Current time
- TIME TO DESTINATION – Time to final waypoint
- TIME TO NEXT – Time to next waypoint
- TO COURSE – Bearing to desired track
- TOTAL AVERAGE SPEED – Total average speed

- TOTAL TRIP TIME – Total travel time of trip, stopped and moving
- TRACK – Current compass direction of travel
- TRIP ODOMETER – Trip Odometer
- TURN – Directional amount of turn needed to match bearing
- VELOCITY MADE GOOD – Velocity Made Good to destination
- VOLTAGE – Current voltage reading being received by unit
- WATER SPEED* – Speed through the water
- WATER TEMP. LOG* – Timeline graph of the transducer's temperature reading.
- WATER TEMPERATURE * – Water temperature

*If receiving proper sonar data from other device, such as a GSD 20 Sounder Module.

NOTE: COMPASS, HIGHWAY, POSITION and SONAR will only be available on medium and large sized data fields.

You may also choose to 'merge' the four medium, default data fields to a single, large field for better readability or you may 'split' any or all of the default data fields to show 4 small data fields. This option is available from any of the main pages.

To Split or Merge the Numbers fields:

1. While in 'Change Numbers' mode, highlight the data field you want to change and press **MENU**.
 2. Choose 'Split Number' or 'Merge Numbers', then press **ENTER/MARK**. You will now see four new data fields or one large field. Press **QUIT** when done.
 3. To return to the factory configuration, repeat the above steps, but instead choose 'Defaults', then press **ENTER/MARK**. Press **QUIT** when done.
- **Measure Distance**— allows you to measure the bearing and distance between any two points on the map display.

To measure the Bearing/distance between two points:

1. Highlight the 'Measure Distance' option and press **ENTER/MARK**. An on-screen pointer will appear on the map display at your present position with 'ENT REF' below it.
2. Move the cursor to the desired reference point (the point that you want to measure from) and press **ENTER/MARK**.
3. Move the cursor to the point that you want to measure to. The bearing and distance from the reference point and cursor coordinates will be displayed in the data window at the top of the display. Press the **QUIT** key to finish.

Reference

Map Page Options

Single, large data field



Default, medium fields

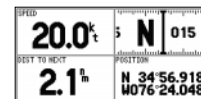

Split, small fields

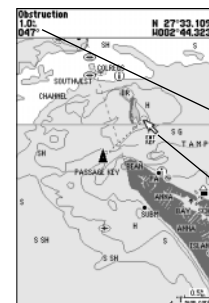

Cursor Coordinates

Distance and Bearing

Map Cursor

Full screen map shown
(with BlueChart data)

Reference

Map Page Options

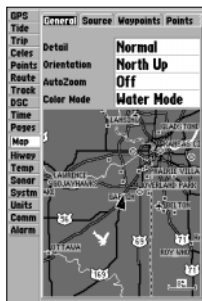

Main Menu—
Map Configuration Tab

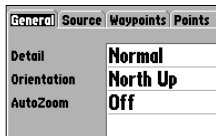

General Tab
(182C shown)

• **Set Up Map**— allows you to configure the map display to your preferences, including map detail, map orientation, automatic zoom, and various map items and points. The map set up option uses a 'file tab' feature, making it easier to organize the various settings for ease of use. The following table lists the file tabs and the settings available under each tab:

General	Detail, Orientation, AutoZoom, Color Mode (182/232 monochrome only)
Source	Basemap, Data Card Maps
Waypoints	Waypoints, Active Route
Points	Spot Soundings, Tide Stations, Services
Nav aids	Symbol Set, Text Size, Light Sectors
Nav Line	Heading Line, Bearing Line, Course Line
Track	Saved Tracks, Track Log
Other	Accuracy Circle, Lat/Lon Grid, Map Outlines

To change a map setup feature:

1. From the Map Page menu, highlight 'Set Up Map' and press **ENTER/MARK**.
2. Move LEFT or RIGHT on the **ARROW KEYPAD** to highlight the desired tab, then UP or DOWN on the **ARROW KEYPAD** to highlight to the setting you want to change and press **ENTER/MARK**.
3. Move UP or DOWN on the **ARROW KEYPAD** to highlight to the desired setting and press **ENTER/MARK**. To exit, press **QUIT**.

General Tab

Detail— Most, More, Normal, Less, Least: controls how much map detail you will see. This setting only applies to any map feature set to "Auto". Those features which have a specified scale or turned "Off" are unaffected by this setting.

Orientation— North Up— fixes the top of the map display to a north heading; Track Up— fixes the top of the map display to the current track heading; Course Up— fixes the map so the direction of navigation is always "up" and turns the navigation leg line vertical on the screen.

AutoZoom— On/Off: when "On" the map will automatically adjust the map scale to a lower scale as you approach your destination point.

Color Mode (182/232 monochrome only) — Water Mode, Land Mode: when in "Water Mode", land will appear as a dark color and water will be light. In "Land Mode", land will appear as a light color and water will be dark. If using optional BlueChart data, it is recommended to use 'Water Mode'.

Source Tab

Basemap— On/Off: turns the built in base map on or off.

Data Card Maps— On/Off: turns all optional BlueChart/MapSource data loaded on the data card on or off. The 'Data Card Maps' option box shows a list of the optional BlueChart/MapSource data loaded on the data card. Each area is described by name and may be deselected if you do not wish to display the data on the Map Page.

To display the Map Information Page:

1. Highlight the 'Data Card Maps' option box and press **ENTER/MARK**.
2. Use the **ARROW KEYPAD** to scroll through the list of maps.
3. To select/deselect a map, highlight the check box to the left of the name of the desired map. Press **ENTER/MARK** to select/deselect the map. The map is selected and will be displayed on the Map Page when an "✓" appears in the box adjacent to that map. You may also press **MENU** and choose to 'Show All' or 'Show None' and press **ENTER/MARK**.
4. To display detailed information and notes for each area, highlight the desired name and press **ENTER/MARK**. To view the notes for that area, choose 'Show Notes'. To scroll through the notes, you may either highlight the notes, press **ENTER/MARK** and use the **ARROW KEYPAD** to scroll UP, DOWN, LEFT and RIGHT or press **MENU** and choose the desired scroll option.

Waypoints Tab— Waypoints/Active Route

Text— None, Small, Medium, and Large: controls the screen size of the name.

Zoom— Auto, Off, 120 ft.-800 mi.: sets the maximum scale at which the feature should appear on the screen. Some types of data will only show up to certain zoom scales.

Points Tab— Spot Soundings/Tide Stations/Services

Text— None (except Spot Snd.), Small, Medium, and Large: controls the screen size of the name.

Zoom— Auto, Off, 120 ft.-800 mi.: sets the maximum scale at which the feature should appear on the screen. Some types of data will only show up to certain zoom scales.

Nav aids Tab—

Symbol Set— Auto, GARMIN, NOAA, International: controls the desired navaid symbol set.

Auto - BlueChart maps are drawn using symbols similar to the NOAA/NIMA standard.

Non-BlueChart maps are drawn using traditional Garmin symbols.

GARMIN - All maps are drawn using traditional Garmin symbols.

Map Page Options*Source Tab*

General	Source	Waypoints	Points
Basemap	On		
Data Card Maps	On		
Data Card Maps			

'Data Card Maps' Map Information Page

Map Information	
MUS03L - Florida to Bahamas, Apr 2001	
Show	Map Name
<input checked="" type="checkbox"/>	West Indies.Straits of Florida
<input checked="" type="checkbox"/>	Bahamas.Little Bahama Bank
<input checked="" type="checkbox"/>	Bahamas.North East Providence
<input checked="" type="checkbox"/>	U.S. - East Coast. Cape Hatteras
<input checked="" type="checkbox"/>	Atlantic Coast.Straits of Florida
<input checked="" type="checkbox"/>	United States - Gulf Coast. Florida
<input checked="" type="checkbox"/>	U.S. - Gulf Coast.Florida.Ancient
<input checked="" type="checkbox"/>	Intracoastal Waterway. Florida
<input checked="" type="checkbox"/>	Intracoastal Waterway. Florida
<input checked="" type="checkbox"/>	U.S. - Gulf Coast. Florida. Texas
<input checked="" type="checkbox"/>	United States-Gulf Coast. Florida
Map03H Bahamas, North East Providence Channel and Tansue of the Ocean. 2912 (1:300000)	

Waypoints Tab

General	Source	Waypoints	Points
		Text	Zoom
Waypoints		Med	Auto
Active Route		Med	Auto

Points Tab

Waypoints	Points	Nav aids	Nav Li
		Text	Zoom
Spot Soundings		Small	On
Tide Stations		None	Auto
Services		None	Auto

Reference

Map Page Options

Waypoints	Points	Navoids	Nav Li
Symbol Set	Auto		
Text Size	Med		
Light Sectors	Auto		

Navoids Tab

Wpts	Points	Nav Line	Track	Other
			Zoom	
Heading Line			Off	
Bearing Line			Off	
Course Line			Auto	

Nav Line Tab

Wpts	Points	Nav Line	Track	Other
			Zoom	
Saved Tracks			Auto	
Track Log			Auto	

Track Tab

Wpts	Points	Nav Line	Track	Other
			Text	Zoom
Accuracy Circle			On	
Lat/Lon Grid			Med	Off
Map Outlines				On

Other Tab



*Map Setup
Menu Options*

NOAA - All maps are drawn using a symbol set similar to NOAA/NIMA.
International - All maps are drawn using a symbol set similar to the IALA symbol set.

Text Size— Small, Medium, and Large: controls the screen size of the name.

Light Sectors— Off, Auto, On: controls the drawing light sectors on the map. Color units indicate the actual color of each sector using the color of the light. Monochrome units draw white and yellow sectors as white, and draw blue, red & green sectors as dark gray.

Off— No light sectors are ever drawn.

Auto— Light sectors appear when you point to them with the map cursor.

On— Light sectors are drawn for all lights that have them.

Nav Line Tab—

Heading Line— On/Off: draws an extension from the end of the boat icon in the direction of travel.

Bearing Line— On/Off: toggles the black/white line which points to the current navigation point.

Course Line— Auto, Off, 120 ft.-800 mi.: sets the maximum zoom scale at which the desired course line should appear on the screen.

Track Tab— Saved Tracks/Track Log

Zoom— Auto, Off, 120 ft.-800 mi.: sets the maximum scale at which the feature should appear on the screen. Some types of data will only show up to certain zoom scales.

Other Tab—

Accuracy Circle— On/Off: toggles the circle “On” and “Off”. The circle represents the approximate accuracy of the unit based on EPE, DOP, and basemap quality. Your position will be within the circle.

Lat/Lon Grid— Text— None, Small, Medium, and Large: controls the screen size of the name.

Zoom— Auto, Off, 120 ft.-800 mi.: sets the maximum scale at which the feature should appear.

Map Outlines— On/Off: toggles the coverage boxes for BlueChart/MapSource data “On” and “Off”.

- **Turn Declutter On/Off** — toggles between showing spot soundings and map outlines for easier viewing.

From the map setup page, you can access the following menu options by pressing **MENU**:

- Defaults— restores settings back to factory settings for the tab highlighted.
- All Map Defaults— restores settings back to factory settings for all tabs.

Compass Page

The GPSMAP 182/182C/232 features two different navigation pages: Compass and Highway. Whenever a **NAV**, Follow Track (TracBack) or Follow Route have been activated, the GPSMAP 182/182C/232's Compass Page will guide you to your destination with digital readouts and a graphic compass display, which includes a bearing pointer. Use this page (instead of the Highway Page) when travelling at slower speeds, when making frequent directional changes, or where straight-line navigation is not possible due to obstructions or terrain. The middle of the page features a rotating 'compass ring' that shows your course over ground (track) while you're moving. Your present course over ground is indicated at the top of the compass ring. A bearing pointer arrow, in the middle of the compass ring, and a bearing 'bug' indicator on the outside of the compass ring, indicate the direction of the destination (bearing) relative to the course over ground. The compass ring and pointer arrow work independently to show—at a glance—the direction of your movement and the direction to your destination. For instance, if the arrow points up, you are going directly to the waypoint. If the arrow points any direction other than up, turn toward the arrow until it points up, then continue in that direction.



The bearing pointer, bearing bug and/or compass ring may point in various directions when you are stationary or at very low speeds. Once you start moving, the pointer will be correct.

The GPSMAP 182/182C/232's Compass Page features a menu page that provides access to layout and data field options. The data window, located at the top of the page, provides a user-selectable layout of various types of useful data. Each data field may be configured to display several data options. The data window layout may also be changed to display more/less data fields and change the actual size of the data displayed.

To display the Compass Page options:

1. Press **MENU**.

To select a menu option:

1. Use the **ARROW KEYPAD** to highlight the desired option and press **ENTER/MARK**. For detailed instructions on changing the data fields and layout of the Compass Page, see pages 22-23.

Reference

Compass Page

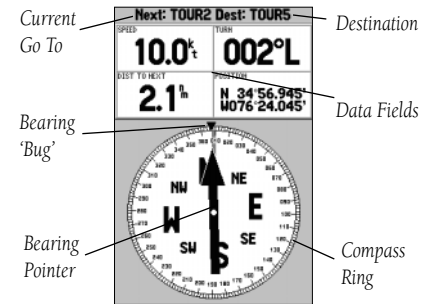

Reference

Numbers/Highway Pages



Numbers Page shown with middle data field split into four fields

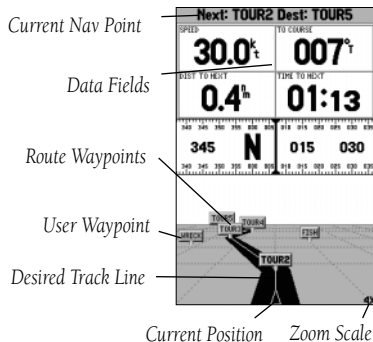

28

Numbers Page

The Numbers Page provides a quick reference for the important data you want to display. The default page will display three large, user-selectable data fields showing a compass ribbon, speed and current position coordinates. You may also choose to show the three data fields in large lettering for better readability or you may 'split' any or all of the data fields to show 4 smaller data fields. For detailed instructions on changing the data fields and layout of the Numbers page, see pages 22-23.

Highway Page

Whenever a Go To, TracBack or route has been activated, the GPSMAP 182/182C/232's Highway Page will provide digital and graphic steering guidance to the destination with the Navigation Page. The top half of the Highway Page features user-selectable data fields that display useful navigation data. Additionally, a compass ribbon is displayed to show your current heading along with a dark, vertical bar which will indicate the bearing to your course. To stay on course, steer towards the dark, vertical indicator (or arrows) until it lines up with the lighter red bar in the middle. The bottom section of the screen provides visual guidance to the waypoint on a graphic highway display. The line down the center of the highway represents your desired track line.

As you head toward your destination, the highway perspective moves to indicate your progress to the waypoint and which direction you should steer to stay on course. If you are navigating a route, the Highway Page shows each route waypoint in sequence connected by a red "road" with a yellow line down the middle, which is your desired track line. Nearby waypoints not in the active route can also be displayed. The highway perspective scale may also be zoomed in or out to display a larger or smaller view of the highway. Five settings are available from 1X to 16X, with a default setting of 8X.

To change the highway perspective scale:

1. Press the **IN** or **OUT** key to select the desired setting.

The GPSMAP 182/182C/232's Highway options page allows you to define the data fields and select which waypoints and track are displayed on screen. The data window, located at the top of the page,

provides a user-selectable layout of various types of useful data. Each data field may be configured to display several data options. The data window layout may also be changed to display additional data fields and change the actual size of the data displayed.

The GPSMAP 182/182C/232's Highway Page features a menu options page that provides access to functions and features relating to the Highway Page and the layout options.

To display the Highway Page options:

1. Press **MENU**.

To select a menu option:

1. Using the **ARROW KEYPAD**, highlight the desired option and press **ENTER/MARK**.

The following options are available from the Highway Page menu:

- **Set Up Highway**— allows you to select what waypoints and tracks are shown on the Highway display. Use the **ARROW KEYPAD** and **ENTER/MARK** key to select/deselect the desired options. Four options are available:
 - Active Route Waypoints— all active route waypoints.
 - User Waypoints— only nearby waypoints to the route.
 - Track Log— current active track log.
 - Saved Tracks— any saved track logs near the route.

- **Change Numbers**— allows you to specify the type of data displayed in each data field used on the map display. For detailed instructions on changing the data fields and layout of the Highway page, see pages 22-23.

Active Route Page

Whenever you have activated a route in the GPSMAP 182/182C/232 system, the Active Route page will show each waypoint of the active route, along with various, user-selectable types of data. For additional details on the Active Route Page, see page 48.

Highway Page Options

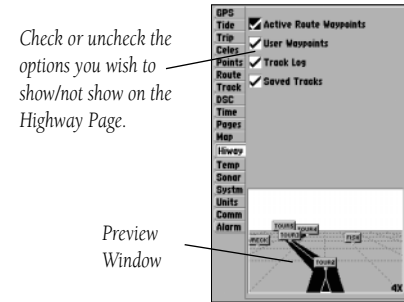

Highway Page Set Up

Next: TOUR2 Dest: TOUR5	
SPEED 30.0 ^{kt}	TO COURSE 008 [°]
TRIP MILEAGE 26.6 ^{kt}	OFF COURSE 26.6 ^{kt}
GPSMAP TOUR	
Waypoint	Distance Course
TOUR1	-----
TOUR2	0.2 ^{kt} 007 [°]
TOUR3	2.7 ^{kt} 334 [°]
TOUR4	5.8 ^{kt} 005 [°]
TOUR5	15.6 ^{kt} 329 [°]
-----	-----
-----	-----

Active Route Page

Reference

Creating Waypoints



Press **ENTER/MARK** to use the default name and symbol.

Highlight a field and press **ENTER/MARK** to enter a new symbol, name, comment or depth.



Creating and Using Waypoints

The Garmin GPSMAP 182/182C/232 stores up to 3000 alphanumeric waypoints with a user-defined icon, comments and depth available for each waypoint. Waypoints can be created using two basic methods:

- **ENTER/MARK** key— used primarily for marking your present position, the **ENTER/MARK** key also provides options that allow you to select a map position or map item from the map display. You may also enter a new waypoint's position coordinates manually (from a chart, etc.).
- Graphically— allows you to define a new waypoint position from the map display using the **ARROW KEYPAD**.

ENTER/MARK Key

The Garmin GPSMAP 182/182C/232's **ENTER/MARK** key lets you quickly capture your present position— or cursor or map item position— in order to create a new waypoint. You must have a valid position (2D or 3D) fix to mark your present position. This can be determined by looking at the GPS Tab on the Main Menu. When you move the cursor over a map item, you will see a highlighted description of that item. You may also use this option to manually enter waypoint coordinates.

To mark your present position:

1. Press and hold the **ENTER/MARK** key until the 'New Waypoint' window appears then release it. You will see a default three-digit name and symbol for the new waypoint.
2. To accept the waypoint with the default name and symbol, press **ENTER/MARK** to confirm the highlighted 'OK' prompt.
3. To enter a different name, highlight the name field and press the **ENTER/MARK** key, then use the **ARROW KEYPAD** to enter the new letter/numbers and press **ENTER/MARK** when done. Note: You may use up to 10 alphanumeric characters for the name.
4. To enter a different symbol, highlight the symbol field to the left of the name and press the **ENTER/MARK** key, then use the **ARROW KEYPAD** to highlight the new symbol and press **ENTER/MARK**.

- To enter optional comments or a depth, highlight the "Comments" or "Depth" field to the right of the position coordinates and press the **ENTER/MARK** key, then use the **ARROW KEYPAD** to enter a value and press **ENTER/MARK**.
- To manually enter a set of coordinates, highlight the coordinates and press the **ENTER/MARK** key, then use the **ARROW KEYPAD** to enter the new coordinates and press **ENTER/MARK** when done.
- When done, use the **ARROW KEYPAD** to highlight the 'OK' prompt and press **ENTER/MARK** to save the waypoint into memory.

Creating Waypoints Graphically

Waypoints may also be quickly created from the map display, which allows you to 'point and shoot' at any map position to create a new waypoint. To mark a map item, select the desired map item with the cursor. When selecting a map item, the option 'Create Wpt' will appear in addition to a description of that point and its distance and bearing from your current position.

To create a new waypoint graphically:

- Use the **ARROW KEYPAD** to move the cursor to the desired map position. If you want to create the new waypoint at an on-screen map item, highlight the map item on the map display.
- Press and release the **ENTER/MARK** key to capture the cursor position. Do not hold the button down, as doing so will mark your present position, not the map position.

If you are not using a map item to create a waypoint, go to step 4.

- Highlight 'Create Wpt' or 'OK' and press the **ENTER/MARK** key.
- To accept the waypoint with the default name and symbol, press **ENTER/MARK**.
- To change the name, symbol or add a comment or depth, highlight the appropriate field and press **ENTER/MARK**. Make your changes and press **ENTER/MARK** when done.
- After entering and confirming your changes, move the field highlight back to the 'OK' prompt and press **ENTER/MARK**.

Creating Waypoints

Map waypoint from non-map item.

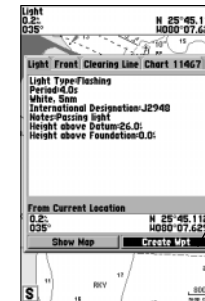

Choose 'Create Wpt' to use a map item for a new waypoint.

Editing Waypoints

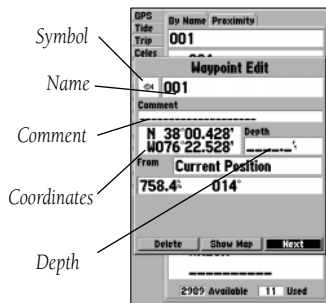
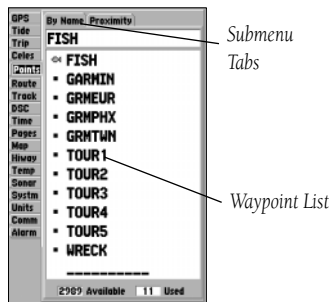

Waypoint Edit Page

Reviewing and Editing Waypoints

Once you have created and stored a waypoint, it may be modified, reviewed, renamed, moved or deleted at any time through the Waypoint Edit page. The Waypoint Edit page is available for any stored waypoint by highlighting the desired waypoint from the map display or selecting it from the waypoint lists under the 'Points' tab in the Main Menu and pressing the **ENTER/MARK** key once.

To access the Waypoint Edit page:

1. Use the **ARROW KEYPAD** to highlight the desired waypoint on the map display. You may also press **MENU** twice, highlight the 'Points' tab, and then highlight a waypoint from the 'User', or 'Proximity' waypoint lists.
2. Press **ENTER/MARK** to display the Waypoint Edit page.

From the Waypoint Edit page, you may change the name, symbol, comment, position coordinates, or depth for the selected waypoint. Once the changes have been made, highlight 'Next' and press **ENTER/MARK** to save them or press **QUIT**.

To change the waypoint name:

1. Highlight the waypoint name field and press **ENTER/MARK**.
2. Use the **ARROW KEYPAD** to enter a new name and press **ENTER/MARK** when done.

To change the waypoint symbol:

1. Highlight the waypoint symbol field to the left of the waypoint name and press **ENTER/MARK**.
2. Use the **ARROW KEYPAD** to select the desired symbol and press **ENTER/MARK** when done.

To change the Comment/Position Coordinates/Depth:

1. Highlight the desired field and press **ENTER/MARK**.
2. Use the **ARROW KEYPAD** to edit/enter the data. To drop to the next line, press to the right on the **ARROW KEYPAD**.
3. Press **ENTER/MARK** when done.

Editing Waypoints

To move the waypoint on the map:

1. From the Waypoint Edit page, highlight 'Show Map' and press **ENTER/MARK**. Highlight the waypoint and press **ENTER/MARK**. A 'MOVE' label will now appear under the cursor arrow in addition to a distance, bearing, and coordinate window. You may also use the IN and OUT keys to zoom the map. The map scale will appear in the lower right corner.
2. Use the **ARROW KEYPAD** to point to the new position and press **ENTER/MARK**. If you wish to stop the move process, press **QUIT**.

Point Submenus

The GPSMAP 182/182C/232's Main Menu Page features two waypoint submenu tabs, 'User' and 'Proximity', that let you manage a large number of waypoints quickly and efficiently. The submenu tabs also provide a continuously updated proximity waypoint alarm function that can be used to define an alarm circle around submerged hazards, shallow waters, etc.

To access the Main Menu Page/Waypoint (Points) submenus:

1. Press **MENU** twice, then highlight the 'Points' tab using the **ARROW KEYPAD**, then highlight the desired submenu tab.

User Waypoint List

The first waypoint submenu list available from the 'Points' tab is the 'User' list, which displays a master list of all waypoints currently stored in memory. From the User list, you may review, edit, rename or delete individual waypoints, or delete all user waypoints. The total number of stored and available waypoints is displayed at the bottom of the 'User' page, with the stored waypoints arranged in numerical/alphabetical order.

The following options are available from the 'User' submenu of the 'Points' tab:

- Create Waypoint— allows you to create a waypoint. (See page 30 for creating a waypoint)
- Delete Waypoint— deletes selected waypoint from list and any route in which it was used.
- Delete By Symbol— deletes waypoints that use the same symbol.
- Delete All— deletes all waypoints from the unit.



*Point to a new location and press **ENTER/MARK** to move the waypoint.*

Waypoint Options

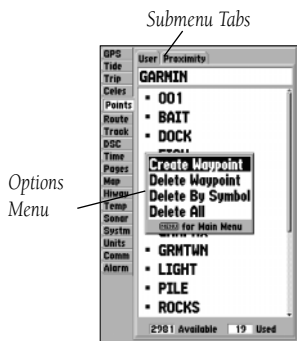

Point List Status



Once a waypoint is deleted from the list, it cannot be recovered from the unit. It is advisable to backup important waypoints to a computer using an optional PC cable and interface software or record them down manually.

To display the waypoint menu options:

1. Using the **ARROW KEYPAD**, highlight the 'User' tab and press the **MENU** key.

To scroll through and review the waypoint list:

1. With the **ARROW KEYPAD**, highlight the 'Points' tab from the main menu page and then highlight 'User'.
2. Use the **ARROW KEYPAD** to scroll through the list in the desired direction.
3. Press **ENTER/MARK** to review the highlighted waypoint on the 'Waypoint Edit' page.
4. Press **ENTER/MARK** to return to the list and automatically highlight the next waypoint.

To delete an individual waypoint from the list:

1. Use the **ARROW KEYPAD** to highlight the waypoint to be deleted and press **MENU**.
2. Highlight 'Delete Waypoint' and press **ENTER/MARK**. You may also highlight the waypoint, press **ENTER/MARK**, then highlight 'Delete' and press **ENTER/MARK**.
3. Press the **ENTER/MARK** key to confirm the deletion warning.

To delete waypoints by symbol:

1. From the 'User' tab, highlight the waypoint to be deleted and press the **MENU** key, then select 'Delete By Symbol' and press **ENTER/MARK**.
2. Use the **ARROW KEYPAD** to highlight the symbol of the waypoint(s) to be deleted and press **ENTER/MARK**.
3. Press **ENTER/MARK** to confirm. You may also choose 'Cancel' or press **QUIT** to stop the deletion.

To delete all waypoints or the entire waypoint list:

1. Press the **MENU** key to select the options window.

- Use the **ARROW KEYPAD** to highlight 'Delete All' and then press **ENTER/MARK**.
- Highlight the 'OK' prompt and press **ENTER/MARK** to confirm.

Proximity Waypoint List

The second waypoint submenu list available from the 'Points' tab is the 'Proximity' list, which lets you define an alarm circle around a stored waypoint position, and can be used to help you avoid reefs, rocks or restricted waters. Up to ten waypoints may be listed, with a maximum alarm radius of 99.99 nautical or statute miles or kilometers. If a proximity alarm circle overlaps with an existing alarm circle, a 'Proximity Overlaps Another Proximity Waypoint' message will appear. Since the unit will only alert for one of the overlap points, use caution when navigating in these areas. If you enter an alarm circle overlap, you will only be alerted to the closest proximity waypoint.

To add a proximity waypoint:

- Use the **ARROW KEYPAD** to highlight an empty space on the Proximity list and press **ENTER/MARK**. The 'Find' screen appears. Highlight 'Waypoints' and press **ENTER/MARK**.
- To select a waypoint from the lists, use the **ARROW KEYPAD** to highlight the desired waypoint from the 'User' or 'Nearest' tab lists.

To select a waypoint from the map, highlight either the 'User' or 'Nearest' tab and press **MENU**. With 'Select From Map' highlighted, press **ENTER/MARK**. Use the zoom **IN** and **OUT** buttons and the **ARROW KEYPAD** to highlight a waypoint.

- Press **ENTER/MARK** to confirm. The distance field will now be highlighted.
- Press **ENTER/MARK** to begin entry of the proximity radius.
- Use the **ARROW KEYPAD** to enter a distance value (to 99.99 units) and press **ENTER/MARK**.

To turn proximity alarms on or off:

- Use the **ARROW KEYPAD** to highlight the field below "Proximity Alarm" and press **ENTER/MARK**.
- Select the desired 'ON' or 'OFF' setting and press **ENTER/MARK**.

Proximity Waypoint List

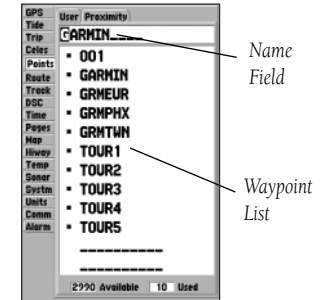

You can also search for a waypoint by name:

- Highlight the name field and press **ENTER/MARK**.
- Use the **ARROW KEYPAD** to select the first letter of the name.
- Move to the **RIGHT** and enter the second letter if you do not see it on the list below.
- Repeat this until the name appears. Press **ENTER/MARK** when you see the name.
- Highlight the name on the list and press **ENTER/MARK** again to review the waypoint. When done, highlight 'OK' and press **ENTER/MARK**.

Reference

Proximity Waypoint List

Waypoint	Distance	
PILE	0.50'	
ROCKS	1.00'	
SHIPWRECK	0.40'	

Proximity Waypoint List

Icon appears when proximity alarms triggers.

Proximity Waypoint

Proximity Circle

A dashed circle will appear showing the alert boundary for the proximity waypoints.

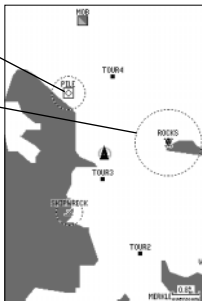

The following options are available from the 'Proximity' submenu of the 'Points' tab:

- Delete Alarm— removes selected waypoint from proximity list.
- Delete All— removes all waypoints from proximity list.

To display the waypoint menu options:

1. Using the **ARROW KEYPAD**, highlight the 'Proximity' tab and press the **MENU** key.

To clear one or all proximity waypoint(s) from the list:

1. Use the **ARROW KEYPAD** to highlight the proximity waypoint to clear and then press the **MENU** key.
2. To clear a single alarm, highlight the 'Delete Alarm' option and press **ENTER/MARK**.
3. To clear all proximity waypoints, select the 'Delete All' option and press **ENTER/MARK**.
4. Use the **ARROW KEYPAD** to highlight the 'OK' prompt and press **ENTER/MARK** to confirm.

Going to a Destination

Using the **NAV** key, the GPSMAP 182/182C/232 provides three ways to navigate to a destination: Go To Point, Follow Route and Follow Track (TracBack). Once you are actively navigating, you will see a straight line that always runs from your current location to the destination. The easiest method for selecting a destination is the 'Go To' function, which lets you select a destination point and quickly sets a direct course from your present position. If you have a point highlighted on a list or the map, 'Go To <point name>' will appear in addition to 'Go To Point'. The 'Go To' function can be accessed from any list of points or graphically from the map display.

To activate a 'Go To' from a point list:

1. Press the **NAV** key.
2. Use the **ARROW KEYPAD** to highlight 'Go To Point' and press **ENTER/MARK**.
3. From the 'Find' menu, highlight 'Waypoints' and press **ENTER/MARK**. (You may also choose to go to other points, such as Cities, Tide Stations, etc. from this list.)
4. To select a waypoint from the waypoint lists, use the **ARROW KEYPAD** to highlight either the 'User' or 'Nearest' tab, select a waypoint and press **ENTER/MARK**. To select a waypoint from the map, highlight either the 'User' or 'Nearest' tab and press **MENU**. With 'Select From Map' highlighted, press **ENTER/MARK**. Use the zoom **IN** and **OUT** buttons and the **ARROW KEYPAD** to select a waypoint, then press **ENTER/MARK**.
5. You may also activate a 'Go To' for any point, on any list. With any list point highlighted, press the **NAV** key. You will see 'Go To <point names>' appear, then press **ENTER/MARK**.

Selecting a 'Go To' Graphically

A graphical 'Go To' may be used to select one of three items from the map display: an existing waypoint, an on-screen map item (roads, rivers, cities, nav aids, etc.), or a new map point (non-map item). If you are selecting a map item as the 'Go To' destination, the GPSMAP 182/182C/232 will automatically use the name of the map item, but the point will not be stored in the waypoint list. See page

Going to a Destination

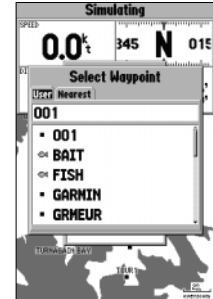

Choose a waypoint from either the 'User' or 'Nearest' tab list.



The waypoint or map item name will automatically appear when highlighted and NAV is pressed.

Reference

Going to a Destination/ TracBack Navigation



'Go To MAP Point' allows you to navigate to a spot on the map which is not a waypoint or map item.

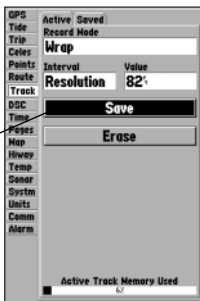

Highlight 'Save' and press ENTER/MARK to save an active track log.

31 for creating waypoints using map items. If you are selecting a new map point (non-map item) as the 'Go To' destination, the GPSMAP 182/182C/232 will automatically create or move a waypoint named 'MAP' at the cursor position.

To activate an existing waypoint or map item as a 'Go To' from the map display:

1. Use the **ARROW KEYPAD** to highlight the waypoint or map item on screen and press **NAV**.
2. You will see 'Go To <waypoint name>', then press **ENTER/MARK**. You may also highlight the waypoint or map item, press **ENTER/MARK**, highlight 'Go To' from options at the bottom of the window and press **ENTER/MARK**.

To activate a new map point (non-map item) as a 'Go To' from the map display:

1. Use the **ARROW KEYPAD** to move the arrow cursor to the desired position.
2. Press **NAV**, you will see 'Go To MAP Point' highlighted, then press **ENTER/MARK**.

TracBack Navigation (Follow Track)

The second method of navigating to a destination is by using the TracBack or Follow Track feature. The TracBack function allows you to retrace your path using the track log automatically stored in the receiver's memory, which will eliminate the need to store waypoints along the way. TracBack routes are created by reducing your track log into a route of up to 50 turns and activating an inverted route along those points. Once activated, a TracBack route will lead you back to the oldest stored track log point, so it's a good idea to clear the existing track log before you start your current trip.

To clear the track log and define a starting point for a TracBack route:

1. Press the **MENU** key twice to display the Main Menu page.
2. Using the **ARROW KEYPAD**, highlight the 'Track' tab, then highlight the 'Active' tab to the right.
3. Use the **ARROW KEYPAD** to select the 'Erase' option and press **ENTER/MARK**.
4. Highlight the 'OK' field and press **ENTER/MARK**.

You must first save the track log before you can use the 'Follow Track' feature. The Save feature allows you to store up to 15 track logs from certain times and dates.

To save a track log:

1. From the Main Menu, use the **ARROW KEYPAD** to highlight the 'Track' tab, then highlight the 'Active' tab to the right.
2. Use the **ARROW KEYPAD** to select the 'Save' option and press **ENTER/MARK**.
3. From the 'Save Back Through' window, highlight the desired time, date, or 'Entire Log' and press **ENTER/MARK**.
4. Next, the track will begin saving and then display the 'Saved Track' window when done. The default name, distance and number of points (500 max) will be displayed.
5. To change the name of the saved track, highlight the name field and press **ENTER/MARK**, make your changes and press **ENTER/MARK** again. You may also choose a style (monochrome units) or color (color models) that will be used to display the saved track line. If you wish for the saved track to be displayed on the Map and Highway page, highlight the check box to the left of 'Show on Map and Highway' and press **ENTER/MARK**. Highlight 'OK' and press **ENTER/MARK** to save the track.

To activate a TracBack using the NAV key:

1. Press the **NAV** key, then highlight the 'Follow Track' option and press **ENTER/MARK**.
2. Highlight the track you wish to follow and press **ENTER/MARK**.
3. Choose either 'Original', which will navigate you from the start to the end of your trip, or 'Reverse', which will navigate you from the end to the start of your trip and press **ENTER/MARK**.

Once a TracBack has been activated, the GPSMAP 182/182C/232 will take the track log currently stored in memory and divide it into segments called 'legs'. Up to 50 (254 on 182C) temporary 'turns' (BEGIN, TURN 1, TURN 2, TURN 3, ..., TURN X, END) will be created to mark the most significant features of the track log in order to duplicate your exact path as closely as possible. To get the most out of the TracBack feature, remember the following tips:

- Always clear the track log at the point that you want to go back to (dock, etc.).
- The 'Record Mode' option on the track log setup page must be set to 'Fill' or 'Wrap'.
- There must be at least two track log points stored in memory to create a TracBack route.

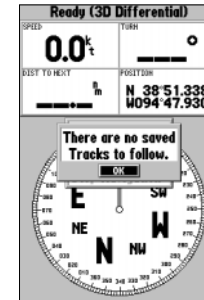
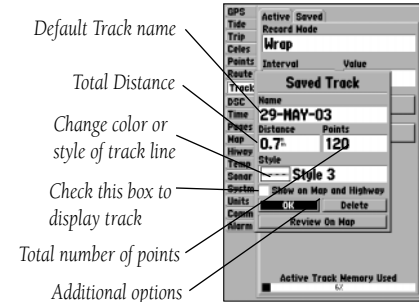
TracBack Navigation

You must first save a track before using the 'Follow Track' option.

Reference

TracBack Navigation/ MOB: Man OverBoard

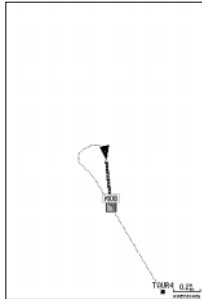

The MOB function allows you to quickly activate a navigation back to a location.

Highlight 'Yes' and press **ENTER/MARK** to stop navigation.



- If the track log interval is set to the 'Time' option, the route may not follow your exact path (keep the interval set to 'resolution' for best performance).
- If the receiver is turned off or satellite coverage is lost during your trip, the TracBack will draw a straight line between any point where coverage was lost and where it resumed.
- If your track log's changes in distance and direction are too complex, 50 waypoints may not mark your path accurately. The receiver then assigns the 50 waypoints to the most significant points of your track, and simplifies segments with fewer changes in direction.

To stop TracBack navigation:

1. Press the **NAV** key, highlight 'Stop Navigation' and press **ENTER/MARK**.

For more information on setting up the Track options and saved tracks, see pages 59-60.

MOB

The GPSMAP 182/182C/232's Man OverBoard function (MOB) lets you simultaneously mark and set a course to a position for quick response to emergency situations.

To activate the MOB function:

1. Press the **MOB** key.
2. Press the **ENTER/MARK** key to confirm and begin navigating to the MOB position.

Once a MOB has been activated, a 'MOB' waypoint with an international MOB symbol will be created and the unit will be on an active navigation to that point. Use any of the Navigation Pages to guide you back to the MOB point. The MOB waypoint will be stored in the waypoint list and may be deleted like any other waypoint.

To stop navigation to the MOB position:

1. Press the **NAV** key, highlight 'Stop Navigation' and press **ENTER/MARK**.

Routes

The last way to navigate to a destination is to create a user-defined route. The Garmin GPSMAP 182/182C/232 system lets you create and store up to 50 reversible routes (numbered 1-50), with up to 50 (254 on 182C) waypoints each. Routes can be created and modified in two ways. The first way to the 'Edit on Map' from the Route Edit map page, allowing you to see each route graphically on-screen as you create, review, or modify the route. The second way is to 'Edit as Text' from the Route Review page, allowing you to see a list of the waypoints as you create, review, or modify the route. All of the GPSMAP 182/182C/232's route functions are accessed through the Main Menu page or the **NAV** key.

To create a route graphically from the Route Edit map page:

1. Press the **MENU** key twice to display the Main Menu page.
2. Use the **ARROW KEYPAD** to highlight the 'Route' tab and press the **MENU** key to display the route options page or you may also highlight the first available blank route slot and press **ENTER/MARK**. (Skip to step 4 if you use this method.)
3. Select the 'New Route' option and press **ENTER/MARK**.
4. To add an existing waypoint or map item to the route, use the map cursor to highlight the desired waypoint or map item on screen and press **ENTER/MARK**. Map items will not appear in the waypoint list. To create a waypoint from a map item, see page 31.
5. To add a new waypoint to the route, use the map cursor to select the desired map position and press **ENTER/MARK**. Press **ENTER/MARK** again to confirm the new waypoint. You may also change the name and symbol of the new waypoint (see page 32).

As you add each new waypoint to the route, the data window at the top of the map display will show the waypoint/map item name, bearing and distance from your location, and coordinates of the cursor. The bottom of the display will show you the number of available and used points. A route line will appear on the map to indicate each completed leg, and a dotted line will appear to indicate the distance and bearing to the arrow cursor from the last route waypoint.

6. Repeat steps 4 and 5 until you have finished defining all route waypoints.
7. When finished press **QUIT** twice to return to the Route List page or press **MENU**, highlight 'Edit as Text' and press **ENTER/MARK** to return to the Route Review page.

Reference

Creating Routes

Route Tab and Route Options Menu

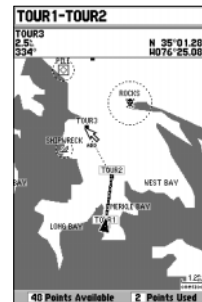
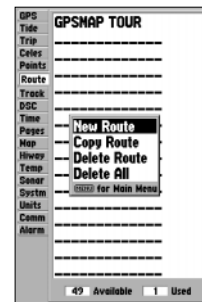

You will see 'ADD' below the cursor as you add points.

Reference

Creating Routes

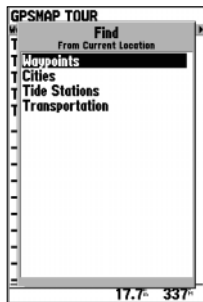

Choose the category you want to add a route point from.

Choose a waypoint from either the 'By Name' or 'Nearest' tab list.

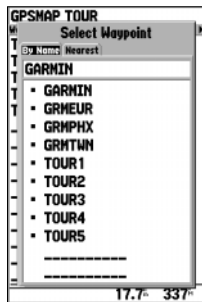

To create a route using text from the Route Review page:

1. Press the **MENU** key twice to display the Main Menu page.
2. Use the **ARROW KEYPAD** to highlight the 'Route' tab and press the **MENU** key to display the route options page or you may also highlight the first available blank route slot and press **ENTER/MARK**. (Skip to step 4 if you use this method.)
3. Select the 'New Route' option and press **ENTER/MARK**.
4. Press **MENU**, select 'Edit as text' and press **ENTER/MARK**.
5. Use the **ARROW KEYPAD** to highlight the first field under the word "Waypoint" and press **ENTER/MARK**.
6. From the 'Find' menu, highlight 'Waypoints' and press **ENTER/MARK**. (You may also choose from other points, such as Cities, Tide Stations, etc. from this list.) From either the "By Name" or "Nearest" tab lists, choose the waypoint you want and press **ENTER/MARK**. (See page 35 for searching for waypoints by name.)
7. From the Waypoint Review page, 'OK' will be automatically highlighted. You may use the 'Show Map' option to view the point on the map, then press **QUIT** when done viewing to return to the Waypoint Review page. Press **ENTER/MARK** to add the point to the route. The next field down on the list will automatically highlight.
8. Keep using the methods on steps 5-7 until the desired route points have been entered. Press **QUIT** to return to the Route List page.

Route List Page

The GPSMAP 182/182C/232 Route List page displays all the routes currently stored in memory, along with a descriptive name for each route. Once a route has been created, it can be activated and used for navigation with the **NAV** key. A route may be followed in the same sequence as it was originally created, or you can invert the route and navigate from the end waypoint back to the beginning waypoint. From the Route list menu, you may choose 'New Route' (pg 41), 'Copy Route', 'Delete Route', or 'Delete All'.

To activate a route with the NAV key:

1. From any page, press the **NAV** key, then using the **ARROW KEYPAD**, highlight 'Follow Route' and press **ENTER/MARK**. (If you highlight a route from the Route List or Route Review page and press **NAV**, the window will automatically display, 'Follow <the route name>'.)
2. Highlight the route you wish to navigate and press **ENTER/MARK**.
3. Choose 'Activate' or 'Invert and Activate' and press **ENTER/MARK**. ('Activate' will use the route as is, 'Invert and Activate' will reverse the route then activate it.)

To deactivate (stop navigation) of a route:

1. Press the **NAV** key, highlight 'Stop Navigation' and press **ENTER/MARK**.

To copy or delete a route:

1. From the Route List, using the **ARROW KEYPAD**, highlight the route you want to copy or delete and press **MENU**.
2. Choose either 'Copy Route' or 'Delete Route' and press **ENTER/MARK** and with "OK" highlighted, press **ENTER/MARK** again to confirm a deletion. Copy will use the same route name with an additional number, starting at 1, at the end of the route name.

To delete all routes:

1. From the Route List, press **MENU**.
2. Highlight 'Delete All' and press **ENTER/MARK** and with "OK" highlighted, press **ENTER/MARK** again to confirm the deletion.

Route List Page

If you highlight a route name from the Route List and press NAV, the name will automatically appear.

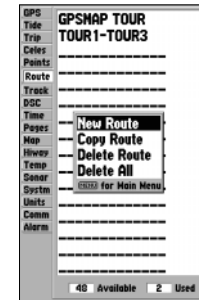

Route List Menu

Route Review Menu Options

Menu options available from the Route Review page are Edit on Map, Add Before, Remove and Trip Planning.

Edit on Map— this option allows you to review and modify the route displayed for each point (waypoint or map item) on a map page. You may also use the cursor to insert a new route point on a map page, review the waypoint or map item.

To edit the route on the map:

1. From the Route Review page, press **MENU**, highlight 'Edit on Map' and press **ENTER/MARK**.

To edit a route point:

1. Use the **ARROW KEYPAD** to highlight the desired route waypoint and press **MENU**.

To review a route point:

1. Highlight the point and press **ENTER/MARK**. Press **ENTER/MARK** again when done.

A pop-up menu of editing choices will appear, with options for removing, moving (user waypoints only) or adding turns to the beginning or end of the route.

To remove a route waypoint:

1. Highlight the 'Remove' option and press **ENTER/MARK**.

To move a route waypoint:

1. Highlight the 'Move' option and press **ENTER/MARK**.
2. Move the cursor to the new map position and press **ENTER/MARK**.

To add turns at the beginning or end of the route:

1. Select the first (to add waypoints to the beginning of the route) or last (to add waypoints to the end of the route) route waypoint with the map cursor, and press **MENU**.
2. Highlight the 'Add' option and press **ENTER/MARK**.
3. Move the cursor to the new point or position and press **ENTER/MARK**.
4. If you are not inserting an existing waypoint, press **ENTER/MARK** to confirm the new waypoint.
5. Repeat steps 3 and 4 to insert additional waypoints, or press **QUIT** to finish.

Reference

Editing Routes

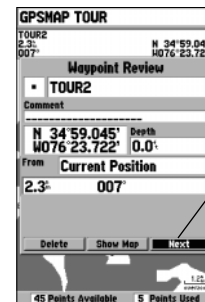
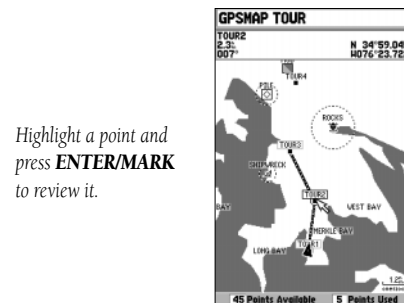

Choose 'Next' to center the map on the next point in the route. You can step through the points by repeatedly pressing **ENTER/MARK**.

Reference

Editing Routes



Highlight the route leg on which you wish to insert a waypoint and press **ENTER/MARK**.

Drag the route leg to an existing waypoint (shown), map item, or a blank spot on the map to create a new route point.

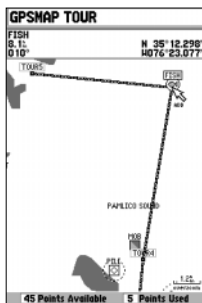

The GPSMAP 182/182C/232's route edit mode also allows you to insert a new route waypoint in any route leg using the map cursor.

To insert a new waypoint between two existing route waypoints:

1. Use the **ARROW KEYPAD** to select the leg you want to insert the new waypoint in (the route line will highlight and change to a dotted line when the leg is selected) and press **ENTER/MARK**.
2. Move the cursor to the new map position, existing waypoint, or map item (You will see 'ADD' below the arrow and the route lines will move with the arrow) and press **ENTER/MARK**.
3. If you are not inserting an existing point, press **ENTER/MARK** to confirm the new waypoint.

Add Before— Allow you to insert a waypoint into the list of route points or add a point(s) onto the end of the route.

To insert a point into the route or add a point to the end:

1. From either the Route Review or Active Route pages, use the **ARROW KEYPAD** to highlight the point you wish to insert the new point before (To add a point to the end, highlight the blank field at the bottom of the list) and press **MENU**.
2. Highlight 'Add Before' and press **ENTER/MARK**.
3. From the 'Find' menu, highlight 'Waypoints' and press **ENTER/MARK**. (You may also choose from other points, such as Cities, Tide Stations, etc. from this list.) From either the "User" or "Nearest From Current Location" tab lists, choose the waypoint you want and press **ENTER/MARK** twice. (See page 35 for searching for waypoints by name.)

To select a waypoint from the map, highlight the 'User' or 'Nearest' tab and press **MENU**. With 'Select From Map' highlighted, press **ENTER/MARK**. Use the zoom **IN** and **OUT** buttons and the **ARROW KEYPAD** to highlight a waypoint on the map and press **ENTER/MARK**.

Remove— Allows you to remove a point (waypoint or map item) from a route. This option is available from both the Route Review and Active Route Pages.

To remove a point from a route:

1. From either the Route Review or Active Route pages, use the **ARROW KEYPAD** to highlight the point to remove and press **MENU**.
2. Highlight 'Remove' and press **ENTER/MARK**.

Trip Planning— The Route Review and Active Route pages also display trip-planning information for each leg or the entire route. Available information includes Course, ETA, Fuel (to point), Leg Distance, Leg Fuel, Leg Time, Sunrise and Sunset (at point location) and Time To (point).

To use the Trip Planning feature:

- To select the desired planning figure, highlight the desired route from the Route List and press **ENTER/MARK** to display the Route Review page.
- One of nine available planning figures appears to the right of each route waypoint and its distance. Use the LEFT/RIGHT keys on the **ARROW KEYPAD** to select the desired item.
- To enter planning information, from the Route Review Page only, press **MENU** and select 'Trip Planning' from the options list. Enter the figures for Speed, Fuel Flow, Departure Time, and Departure Date. Press **QUIT** to return to the Route Plan Page.



Fuel flow rates on your unit are measured in "units per hour". System setting changes for units of measure (statute, nautical or metric) do not affect the fuel flow measure. You should enter fuel flow rates based upon available information for your vehicle (operator's manual, performance specifications, etc.) and make note of the desired units of measure (gallons, liters, etc.).

Delete Route— deletes a route from the Route List. Waypoints and map items will not be deleted from unit memory.

To delete a route:

- From the Route Review page press **MENU**.
- Highlight 'Delete Route' and press **ENTER/MARK** and **ENTER/MARK** again to confirm the deletion.

Editing Routes

Waypoint	Distance	Leg Dist
TOUR1	0.0'	2.3'
TOUR2	2.3'	2.5'
TOUR3	4.8'	3.1'
TOUR4	7.9'	9.8'
TOURS	17.7'	
	17.7'	17.7'

Press **LEFT** or **RIGHT** on the **ARROW KEYPAD** to change the data field.

GPSMAP TOUR		Distance	Leg Dist
Waypoint	Distance	Leg Dist	
TOUR1	0.0'	2.3'	
TOUR2	2.3'	2.5'	
TOUR3	4.8'	3.1'	
TOUR4	7.9'	9.8'	
TOURS	17.7'		
	17.7'	17.7'	

Trip Planning
Data Fields

Reference

Active Route Page

Next: TOUR2 Dest: TOUR5	
TO COURSE SPEED	TO COURSE 007 ^h
30.0 ^k	007 ^h
OFF COURSE 1.0 ^k	
GPSMAP TOUR	
Waypoint	Distance Course
TOUR1	---
TOUR2	2.0 ^h 007 ^h
TOUR3	4.6 ^h 334 ^h
TOUR4	7.7 ^h 005 ^h
TOUR5	17.5 ^h 329 ^h
---	---
---	---
---	---
---	---
---	---
---	---
---	---
---	---
---	---
17.5 ^h	341 ^h

Active Route Page

Next: TOUR2 Dest: TOUR5	
TO COURSE SPEED	TO COURSE 019 ^h
0.0 ^k	019 ^h
OFF COURSE 1.6 ^k	079 ^h
GPSMAP	
Change Numbers	
Edit on Map	
Add Before	Course
Remove	017 ^h
Invert	344 ^h
Re-evaluate	015 ^h
Re-evaluate	339 ^h
---	---
---	---
---	---
---	---
---	---
---	---
---	---
---	---
---	---
---	---
---	---
---	---
---	---
---	---
---	---
---	---
---	---
---	---
---	---
17.2 ^h	351 ^h

Active Route Page
Menu Options

Active Route Page

Whenever you have activated a route in the GPSMAP 182/182C/232 system, the Active Route page shows each point (waypoint or map item) of the active route, with the point name, distance and choice of Course, ETA, Fuel to point, Leg Distance, Leg Fuel, Leg Time, Sunrise and Sunset at point location, or Time To point for each point from your present position. The current destination point, the 'active' point, is marked with an arrow icon. As you navigate a route, the waypoint list will automatically update to indicate the next 'active' point first. The Active Route and Route Review pages share many of the same features and options.

The following route options are available from the Active Route page:

- Hide/Show Numbers— see page 21 for instructions (same as Map Page option).
- Change Numbers— see page 22-23 for instructions.
- Edit on Map— see page 45 for instructions.
- Add Before— see pages 45-46 for instructions.
- Remove— see pages 45-46 for instructions.
- Invert— reverses the direction of the route.
- Re-evaluate— recalculates and reactivates the current route data.

Invert— reverses the route.

To Invert an active route:

- 1 From the Active Route page, press **MENU**.
2. Using the **ARROW KEYPAD**, highlight 'Invert' and press **ENTER/MARK** to reverse the route.

Re-evaluate— reactivates the current route and selects the route leg closest to your current position as the active leg. The active leg defines the current 'from' and 'to' waypoints.

To Re-evaluate an active route:

- 1 From the Active Route page, press **MENU**.
2. Using the **ARROW KEYPAD**, highlight 'Re-evaluate' and press **ENTER/MARK** to recalculate.

Find Function

The **FIND** key allows you to search the units for user waypoints, map items and any optional BlueChart or MapSource information loaded on a data card. By pressing the **FIND** key, the unit will search for items from your current location by default or you may also search from other locations. When you press **FIND**, a list of available items to search from will appear. The default items are Waypoints, Cities, Tide Stations and Transportation. Additional items, such as Anchorages, Businesses, Exits, Nav aids, Restricted Areas, Wrecks Obstructions, etc., will display depending on the optional BlueChart or MapSource data card inserted into the unit. If you pan around on the Map Page and press **FIND**, the unit will center its search from the point where the cursor is located. When using BlueChart or MapSource data, your position or the map pointer must be within the map outline area to search for information from that area.

To Find a waypoint or other item from your current location:

- 1 From any page, press **FIND**.
2. Using the **ARROW KEYPAD**, highlight the desired category from the list and press **ENTER/MARK**.
3. For Waypoints and Cities, you may search using 'By Name' or 'Nearest'. Use the **ARROW KEYPAD** to highlight the desired tab. For 'By Name', you may use the top field to spell out the name or scroll down through the list. (See also page 35 sidebar for steps on entering a name.)

To Find a waypoint or item from other locations:

- 1 From the Map Page, use the **ARROW KEYPAD** to pan to the desired location and press **FIND**.
2. Using the **ARROW KEYPAD**, highlight the desired category from the list and press **ENTER/MARK**.

The Find option supports a "find from" feature which allows you to center your search around an item which you have just found using the Find function. For example, you search for "Restricted Areas" and the search shows an "Anchoring Prohibited" search result. If you press **FIND** again, you will see "From Anchoring Prohibited" as the new search from point. You may also use the Find feature to center your search from any waypoint or route list entry, map item or tide station. Highlight the item you want to Find 'from', and press the **FIND** key.

Reference

Find Key

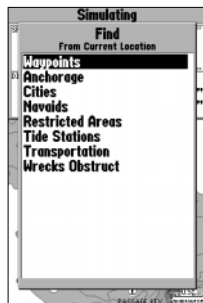

Find Items List

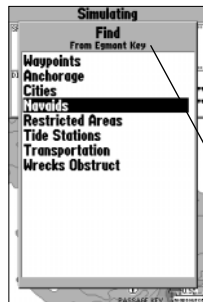

You may also Find from items found on the Find List.

Reference

Find Options

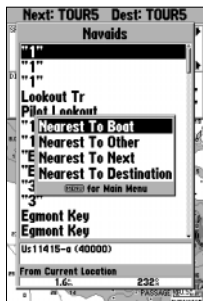

Find Menu Options

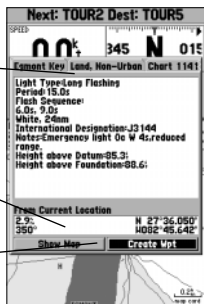

Additional Information
Tabs

Distance, Bearing,
Coordinates of item

Additional Option
Buttons

Additional Information Window

Find Options

Using the Find options, you may search from various map data and utilize variety of nearest criteria for all items, except waypoints. Available Find options are:

- Nearest To Boat— centers search from your boat's current location
- Nearest To Other— allows you to choose another map location from which to search.
- Nearest To Next— centers search from the next point of your active route.
- Nearest To Destination— centers search from the last point of your active route.

To Find an item using the Find options:

- 1 From any page, press **FIND**.
- 2 Using the **ARROW KEYPAD**, highlight the desired category from the list and press **ENTER/MARK**.
- 3 From the search results list, press **MENU**, then highlight the desired option and press **ENTER/MARK**.

Additional Information

Any item you locate using the Find feature will also have additional information, such as item classification, distance, bearing and coordinates, data source, etc., depending on the type of data on the optional BlueChart or MapSource data card. Tabs will appear at the top of the detail window, along with additional option buttons at the bottom.

To view additional information for a Find item:

- 1 From the Find list, highlight an item and press **ENTER/MARK**.
- 2 Use the **ARROW KEYPAD** to highlight the individual tabs to display the information and additional options. Scroll up, down, left and right in additional text windows (show notes), highlight the field and press **ENTER/MARK**, the use the **ARROW KEYPAD** to scroll, or press **MENU** and choose the desired scroll option.

Main Menu Page

The GPSMAP 182/182C/232's Main Menu Page provides access to various waypoint, system, navigation and interface management, and setup menus in an easy to use "tab" format. The Main Menu page is available from any page in the system, and is accessed through the **MENU** key. See pages 2-3 for additional instructions changing settings and entering data.

To access the Main Menu Page:

1. Press **MENU** twice. The 18 Menu tabs are divided into categories by function.

To select a Menu tab from the Main Menu page:

1. Move the **ARROW KEYPAD** UP or DOWN to highlight the tab you want to view. The information for the highlighted tab will automatically appear to the right. If you want to highlight any of the tab items, press to the RIGHT on the **ARROW KEYPAD**, then move UP or DOWN to select individual items.
2. Press either **MENU** for additional submenu options or press **ENTER/MARK** to make changes to the highlighted item. Press LEFT on the **ARROW KEYPAD** to get back to the Menu tab list. Press **QUIT** to return to the Main Menu page.

The Main Menu tabs are:

- GPS— shows satellite status, accuracy, initialize position.
- Tide— shows 24 hour tide chart with levels and times.
- Trip— provides trip speeds, odometers, averages, and trip timers.
- Celes— shows sun/moon time cycles and positions.
- Points— allows you to create, edit or delete waypoints. See pages 30-36.
- Route— allows you to create, edit, activate or delete routes. See pages 41-47.
- Track— lets you record a track, define how it is recorded and displayed.
- DSC— allows you to control the Digital Selective Calling (DSC) interface
- Time— sets up time format, time zones, and daylight savings.
- Pages— enables main pages to be shut off, turned on, or 'jumped to'.
- Map— sets up Map Page features, zooms, and text size. See pages 24-26.
- Hiway— sets up Highway Page features. See pages 28-29.
- Temp*— displays temperature log graph (if equipped with GSD 20 or NMEA compatible device)
- Sonar*— sets up sonar options (if equipped with GSD 20)
- System— defines beeper and simulator, restores setup, and displays software version.
- Units— defines position format, datum, heading, and distance and speed units.
- Comm— interface settings for use with a PC or second device.
- Alarm— sets up alarms for anchor drag, arrival, off course, and clock.

Reference

Main Menu Tabs

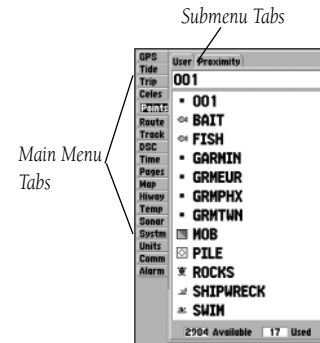

Main Menu Page

* See the "GSD 20 Sounder Module with Garmin Chartplotters" (190-00241-03) for operational instructions.

Reference

Main Menu: GPS Tab

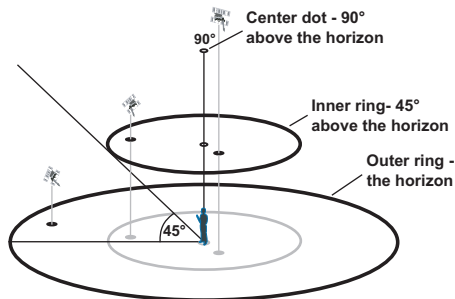
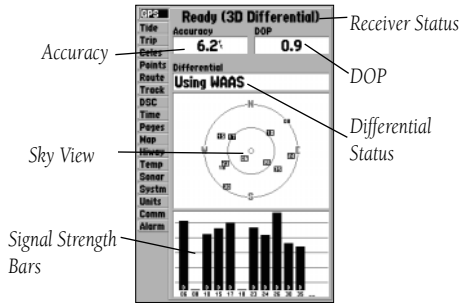

52

GPS Tab— provides a visual reference of satellite acquisition, receiver status, and accuracy. The status information will give you an idea of what the receiver is doing at any given moment. The sky view and signal strength bars give you an indication of what satellites are visible to the receiver and whether or not they are being tracked. The signal strength is shown on a bar graph for each satellite, with the satellite number below. As the receiver locks onto satellites, a signal strength bar will appear for each satellite in view. The progress of satellite acquisition is shown in three stages:

- No signal strength bars— the receiver is looking for the satellites indicated.
- Light signal strength bars— the receiver has found the satellite(s) and is collecting data.
- Dark signal strength bars— the receiver has collected the necessary data and the satellite(s) are ready for use.

As soon as the GPSMAP 182/182C/232 has collected the necessary data from the best satellites in view to calculate a fix, the status field will indicate a 2D or 3D status. The unit will then update the position, date and time.

You can use the sky view to help determine if any satellites are being blocked, and whether you have a current position fix (indicated by a '2D', '2D Differential', '3D', or '3D Differential' in the status field). The sky view shows a bird's-eye view of the position of each satellite relative to the receiver's last known position. The outer circle represents the horizon (north up), the inner circle 45° above the horizon, and the center point a position directly overhead. You can also set the sky view to a 'Track Up' configuration, causing the top of the sky view to align along your current track heading.

WAAS Capability

The GPSMAP 182/182C/232 is capable of receiving WAAS (Wide Area Augmentation System) satellite signals. WAAS is an FAA (Federal Aviation Administration) funded project to improve the overall accuracy and integrity of the GPS signal for aviation use, but land/sea based users may also benefit from this system. At this time, the system is still in the development stage and is not fully operational. There are currently two WAAS satellites that can be received in the U.S.A., one over the Atlantic Ocean and one over the Pacific Ocean, in a geo-stationary orbit over the equator. Effective use of the WAAS satellite signal may be limited by your geographic location in relation to those satellites, now in developmental service. WAAS satellite signal reception requires an absolute clear view of the sky and works

Main Menu: GPS Tab

best when there are no nearby obstructions such as buildings, mountains, etc. WAAS satellites will be numbered 33 or higher when viewing the sky view on your GPSMAP 182/182C/232. Initial reception of the WAAS signal may take up to 15-20 minutes, then 1-2 minutes afterwards. When WAAS differential correction has been received for GPS satellites (numbers 32 or below), a 'D' will appear in the signal bar of the sky view and '2D or 3D Differential' will appear in the receiver status. To learn more about the WAAS system, its satellite positions and current state of development, visit the FAA web site (<http://gps.faa.gov>). Since WAAS requires CPU resources of the GPSMAP 182/182C/232 to search for and track the satellites, you may disable the WAAS feature to improve unit performance if WAAS reception is not available in your area.

To Disable/Enable WAAS capability:

1. From the GPS Tab, press **MENU**, then use the **ARROW KEYPAD** to highlight 'WAAS Off' or 'WAAS On' and press **ENTER/MARK**.

Receiver Status, Accuracy and DOP

Receiver status is indicated at the top field of the page, with the current Accuracy and Dilution Of Precision (DOP) to the right of the sky view. DOP is an indication of satellite geometry quality measured on a scale of one to ten (lowest numbers the best, highest numbers the poorest). Accuracy uses DOP and other factors to calculate horizontal position accuracy in feet or meters. The status field will show one of the following conditions:

- Looking For Satellites—the receiver is looking for any satellites.
- AutoLocate—the receiver is looking for any satellite whose almanac has been collected. This process can take up to five minutes.
- Acquiring Satellites—the receiver is looking for and collecting data from satellites visible at its last known or initialized position, but has not collected enough data to calculate a fix.
- 2D—at least three satellites with good geometry have been acquired and a 2 dimensional position fix (latitude and longitude) is being calculated. '2D Differential' will appear when you are receiving DGPS corrections in 2D mode and a 'D' will show on the strength bar of satellites being corrected.

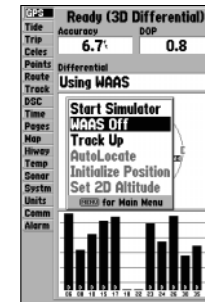

Highlight 'WAAS Off' and press **ENTER/MARK** to disable the WAAS capabilities.

Main Menu: GPS Tab

- 3D— at least four satellites with good geometry have been acquired and your position is now being calculated in latitude, longitude and elevation. '3D Differential' will appear when you are receiving DGPS corrections in 3D mode and a 'D' will show on the strength bar of satellites being corrected.
- Poor GPS Coverage— the receiver is no longer tracking enough satellites for a 2D or 3D fix.
- Receiver Not Usable— the receiver is unusable, possibly due to interference or abnormal satellite conditions. Turn the unit off and back on to reset.
- Simulating— the receiver is in simulator mode.

The Differential Receiver status will show one of the following:

- Off— No optional beacon receiver attached or enabled in the Comm menu or WAAS Off
- Searching For WAAS— WAAS is enabled and receiver is searching for WAAS signal
- Using WAAS— WAAS capability enabled and unit receiving WAAS corrections
- No Beacon Signal— DGPS receiver attached, but not transmitting RTCM data to GPS
- Tuning Beacon— Receiver is tuning manual DGPS frequency
- Receiving Beacon— Unit is receiving DGPS corrections
- Scanning Beacon— DGPS receiver is scanning for available frequency

The Differential SNR (Signal to Noise Ratio) indicates, on a scale to 0-30db with 30db being the best, the strength of the DGPS signal being received. If no optional DGPS receiver is used with the GPSMAP 182/182C/232, the 'DGPS Rcvr' field will display 'Off'. The SNR will depend upon the mounting of your DGPS receiver and the distance from the DGPS transmitting station.

The GPSMAP 182/182C/232's GPS Tab features an options page that provides access to functions and features relating to the GPS Info display.

To display the GPS Tab options:

1. Press **MENU**.

To select a menu option:

- Using the **ARROW KEYPAD**, highlight the desired option and press **ENTER/MARK**.

The following options are available:

- Start/Stop Simulator— toggles the unit simulator on or off. Retail Demo mode will restore factory settings to the unit if left unattended for over 2 minutes. This mode should only be used for display purposes. User waypoints will NOT be deleted.
- WAAS On/WAAS Off— toggles the WAAS capability of the receiver on or off.
- Track Up/North Up— allows you to select between a north up or track up sky view display for the GPS Info display only.
- AutoLocate— allows the receiver to locate your position automatically. This process can take up to five minutes.
- Initialize Position— allows you to initialize the receiver graphically on the Map Page to initially help the receiver acquire more quickly. See pages 4-5 for instructions on initialization.
- Set 2D Elevation— allows you to manually enter the elevation when in 2D or Simulator mode only. Any elevation entered will be automatically calculated when the GPS is in 3D mode.

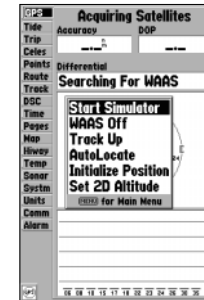

Note: If a DGPS receiver is attached to the unit and Garmin DGPS, RTCM In/NMEA Out, or Other DGPS is enable on Port 2, WAAS will be automatically disabled (WAAS Off). It is not possible for the GPSMAP 182/182C/232 to receive WAAS and DGPS corrections at the same time.

**Main Menu:
GPS Tab**

GPS Tab Options

Reference

Main Menu: Tide Tab

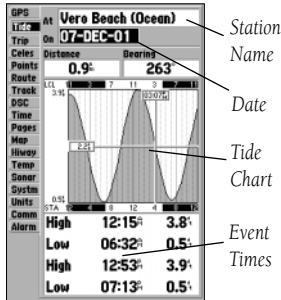

Tide Tab



You can select from a list of nearest stations.

Tide Tab— shows a graphical chart which displays tide station information in a 24 hour span starting at midnight station time. You can choose from different dates and over 3000 tide stations around the USA coastline, Alaska, Hawaii, western Canada and several of the Caribbean islands.

The top of the page displays the tide station being referenced, below that the date. The top of the chart shows a 24-hour block of local time (LCL) for your position, with the reported station time (STA) appearing at the bottom. Daylight (light bar or yellow on 182C) and nighttime (dark bar or blue on 182C) show across the time scale, with the time progressing from left to right. (Local time scales and sunrise/sunset info may not be available for a few stations). The solid, light vertical lines are in 4-hour increments, and the light, dotted vertical lines are in 1-hour increments. A solid, vertical line (with the current time box at the top) will indicate the time of day when using current date and will intersect the tide graph to show their relation.

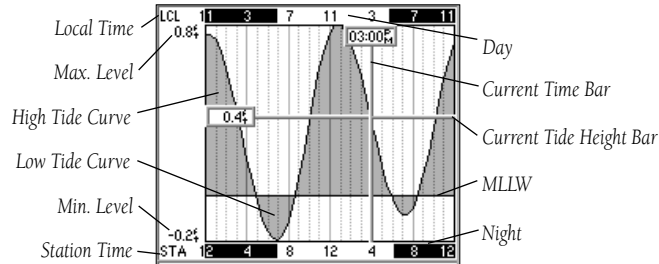

The tide curve shows as a shaded area, with higher tides being taller (blue on 182C) and lower tides shorter (red on 182C). The solid, horizontal line (with the current tide box on the left) indicates the current tide height. The figure to the left of the line will show the current tide level in feet. The Mean Lower Low Water (MLLW) appears as a solid, horizontal line near the bottom of the chart (This line will only appear if the tide ranges to the zero value or below). The numbers directly below/above 'LCL' and 'STA' indicate the maximum/minimum levels, respectively. The four data fields below the chart, indicate event times and levels at which the tide changes starting in the upper left field, going downward, then to the upper right and down again.

To select the nearest tide station from you current location:

1. From the "Tide" tab, highlight the 'At' field and press **ENTER/MARK**.
2. Highlight the desired station of the list and press **ENTER/MARK** twice.

If you are not within this range, you will see a message "None Found". Use the 'Nearest To Other' Find option and select a location closer to a tide station.

To select a tide station from the map:

1. Press **FIND**, then **MENU** when the search results appear.
2. Highlight 'Nearest To Other' and press **ENTER/MARK**.
3. Select a position on the map and press **ENTER/MARK**.
4. A list will appear showing up to nine of the nearest tide stations. Highlight the desired station and press **ENTER/MARK** twice. If the "None Found" message appears, repeat steps 1-4 until you find a station.

You may also change the date to see tide charts for other days.

To change the date for the tide chart:

1. Using the **ARROW KEYPAD**, highlight the "On" field and press **ENTER/MARK**.
2. Enter the desired date and press **ENTER/MARK**.

To use the current date:

1. Press **MENU**, then highlight 'Use Today's Date' and press **ENTER/MARK**.

You may move the time bar on the tide chart in 5 minute increments to show tide heights at various times on the chart.

To see tide heights at various times on the chart:

1. Press **MENU**, then highlight 'Move Cursor' and press **ENTER/MARK**.
2. Press LEFT or RIGHT on the **ARROW KEYPAD** to change the time. Press **QUIT** when done or press **MENU**, then highlight 'Stop Moving Cursor' and press **ENTER/MARK**.

**Main Menu:
Tide Tab**

You may automatically search for the nearest station using a variety of search locations. You must select a location within 100 nm. of a tide station.

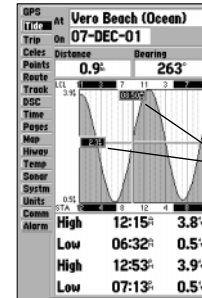
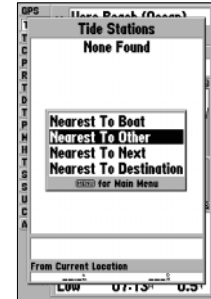

You may move the cursor to see tide heights at different times. Tide data will show in a black box when in cursor mode.

Reference

Main Menu: Trip/ Celes (Celestial) Tab

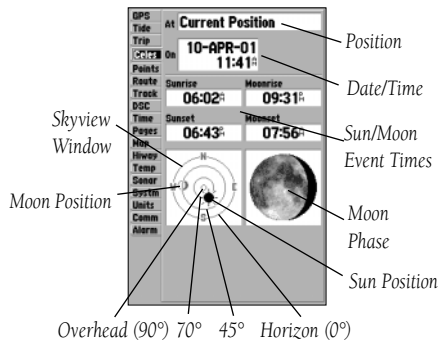

You may also change the skyview from 'North Up' to 'Track Up'.



Celestial Tab Menu

Trip Tab— displays Trip Odometer, Moving Average speed, Total Average speed, Maximum Speed, Stopped Time, Moving Time, Total Time, and Odometer. You may reset the data by choosing from 'Reset Trip', 'Reset Odometer', 'Reset Max Speed', or 'Reset All' and pressing **ENTER/MARK**.

Celes (Celestial) Tab— displays celestial data for sun and moon rise/set, moon phase, and approximate skyview location of the sun and moon. The moon phase will display the current visible portion of the moon as a light color. You may display this data for your current position, a position from the map, or a Find item location. Also, you may select a different date and time, or use the current data.

To choose a position:

1. From the Celes tab, highlight the 'At' field and press **ENTER/MARK**.
2. From the Find list highlight any category, except Other Location, and press **ENTER/MARK**. If you wish to reference a Find item, select from the Find list, and press **ENTER/MARK**.
3. Select an item from the desired list or tab lists and press **ENTER/MARK**. For a location from the map, choose 'Other Location' and press **ENTER/MARK**, select a position on the map and press **ENTER/MARK**.
4. From the Find item detail page, highlight 'OK' and press **ENTER/MARK**.

The location the unit is using will appear in the Date/Time/Position field. The timetables displayed will be based upon your current time zone. When using a position from another location outside of your time zone, you will need to set the Time Zone for that location under the "Time" tab on the Main Menu (see page 61).

To change the time or date:

1. From the Celes tab, use the **ARROW KEYPAD** to highlight the date or time and press **ENTER/MARK**.
2. Enter a new date or time and press **ENTER/MARK**.

To use current date and time:

1. From the Celes tab, press **MENU**, then use the **ARROW KEYPAD** to highlight 'Use Current Date and Time' and press **ENTER/MARK**.

Track Tab— lets you specify whether or not to record a track log (an electronic ‘breadcrumb trail’ recording of your path), define how it is recorded, or save track log data for future use. The Track Logs Page also provides an indicator of the memory used for the active track log and options to clear the track memory or start a TracBack route. See pages 38-40 for TracBack information. The Track submenu is divided in two tabs: ‘Active’ tab and the ‘Saved’ tab.

The ‘Active’ tab is for the active log (the log currently being recorded). It displays track memory used and current settings.

The ‘Saved’ tab displays and manages a list of any saved track logs, allows TracBack activation, map display of saved logs. The active log stores up to approximately 2500 track log points, based upon the criteria specified in the Track settings. Up to 15 track logs may be saved in memory, with up to 500 track log points in each saved log.

For the ‘Active’ tab, the following settings are available:

- Record Mode— lets you select one of three track recording options:
 - Off— No track log will be recorded. Note that selecting the ‘Off’ setting will prevent you from using the TracBack feature.
 - Fill— a track log will be recorded until the track memory is full.
 - Wrap— A track log will be continuously recorded, wrapping through the available memory (replacing the oldest track data with new data).
- Interval— defines the frequency at which the track plot is recorded. Three interval settings are available:
 - Distance— records track based on a user-defined distance between points.
 - Time— records track plot based on a user-defined time interval.

Main Menu: Track Tab



Active Track Tab



Saved Track Tab

Reference

Main Menu: Track Tab



You can use the 'Review On Map' option to display a saved track on a Track Map Page.

The track name will automatically appear when highlighted on the 'Saved' list and NAV is pressed.

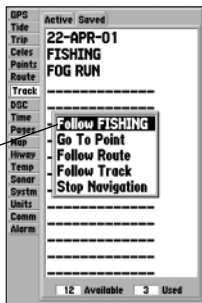

Resolution— records track plot based upon a user-defined variance from your course over ground. The resolution option is the default setting and is recommended for the most efficient use of memory and TracBack performance. The distance value (entered in the value field) is the maximum error allowed from the true course before recording a track point.

- Value— defines the distance or time used to record the track log.
- Save— allows you to save the current active track log.
- Erase— allows you to clear the active track log currently stored in memory.

For the 'Saved' tab, the following menu options are available:

- Review On Map— displays the saved track log on a Track Map page.
- Delete Track— deletes highlighted saved track log from memory.
- Delete All— deletes all saved track logs from memory.

You may also activate a TracBack from any of the saved tracks on this tab.

To activate a TracBack from the 'Saved' tab list:

1. Using the **ARROW KEYPAD**, highlight the track you wish to use for a TracBack and press **NAV**.
2. The 'Follow <track name>' will automatically appear highlighted. Press **ENTER/MARK**.
3. Choose either 'Original', which will navigate you from the end to the start of your trip, or 'Reverse', which will navigate you from the start to the end of your trip and press **ENTER/MARK**.

DSC Tab— Digital Selective Calling (DSC) uses marine VHF radio and Global Positioning System (GPS) technologies to transmit and receive location information. DSC is used by mariners to assist them in two major areas: Distress Calls and Position Reporting. See Appendix B for more information on DSC and using it with your GPSMAP 182/182C/232.

Time Tab— displays the current time and date, allows you to adjust the 12 or 24 hour time format, enter a time zone and adjust for daylight savings to show correct local time.

The following options are available:

- Time Format— choose from 12 or 24 hour (military) time format.
- Time Zone- choose your correct time zone to show correct local time or enter a UTC Offset. The UTC (also called Greenwich Time) offset is how many hours you are ahead or behind the time line. See the table on page 70 for time offsets.
- Daylight Savings— choose from 'Auto', 'On', or 'Off' to adjust for daylight savings.

Pages Tab— allows you to turn on/off any of the main pages or 'Jump To' a particular page. You may also set which page appears first when you power the unit on or enable/disable the GPS Info on power up screen.

To select/deselect a main page:

1. Use the **ARROW KEYPAD** to highlight the box to the left of the page name. Pressing **ENTER/MARK** will select/deselect that page. When a page is selected a '✓' will appear in the box. You must leave at least one page checked.

You may also press Menu and choose from one of the following and press **ENTER/MARK**:

- All Pages— selects all pages.
- Chartplotter Only— selects Map page only.
- Nav Tools Only— selects Compass, Numbers, Highway, and Active Route pages only.
- Basic Fishfinder— selects Sonar page only (if equipped with GSD 20).
- Defaults— selects all pages.

To 'Jump To' a specific page:

1. Use the **ARROW KEYPAD** to highlight the 'Jump To' option to the right of the desired page and press **ENTER/MARK**.

To set the First Page:

1. Use the **ARROW KEYPAD** to highlight the 'First page' option and press **ENTER/MARK**. Highlight the page you wish to appear first and press **ENTER/MARK**.

Reference

Main Menu: Time and Pages Tabs

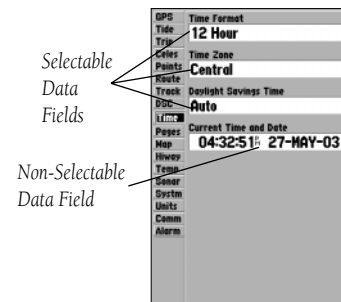

Time Tab

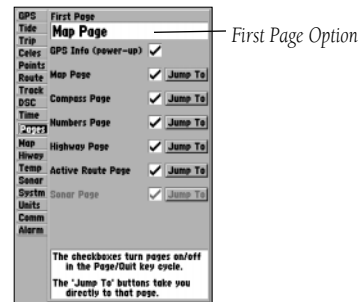

Pages Tab

Reference

Main Menu: System (System) Tab

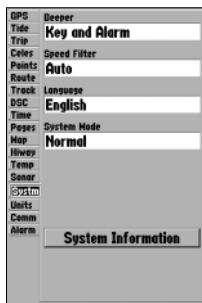

System (System) Tab
Normal Mode



Simulator Mode

Retail Demo mode will restore factory settings to the unit if left unattended for over 2 minutes. This mode should only be used for display purposes. User waypoints will NOT be deleted.

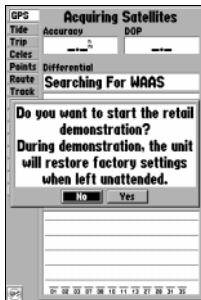

System (System) Tab— controls system setting for beeper, speed filter, languages, system mode, simulator controls, restores factory settings, and displays software version.

The following settings are available:

- **Beeper**— controls audible beep. Select from 'Off', 'Alarms Only' (sounds for alarms/messages), 'Key and Alarm' (sounds for key presses and alarms/messages).
 - **Speed Filter**— averages speed-readings. Choose from 'Off', 'Auto' (automatically controls filtering), or 'On' (allows you to enter a value from 1 to 255 seconds).
 - **Language**— select from various languages for the unit's on-screen display (English, Danish, Finnish, German, Italian, Swedish, Spanish, Portuguese, Norwegian, French, or Dutch).
 - **System Mode**— select from 'Normal' (Normal Navigation) or 'Simulator' (For practice ONLY)
 - **Set Position***— allows to set your location while in simulator mode. See page 11, starting with step 2, for additional instructions.
 - **Track Control***— 'Auto Track' will steer to the current navigation point. 'User Track' allows you to enter a heading in the 'Track' field.
 - **Track***— lets you enter a heading.
 - **Speed***— lets you enter a speed.
 - **Transducer***— allows you to select a simulated transducer type.
- * These fields will only appear when the unit is in Simulator Mode.

The following option is also available from the "System" tab:

- **System Information**— displays the unit's software, basemap version and electronic serial number. Press **MENU** for the following options:
 - **Defaults**— restores settings on Systm page to default values.
 - **All Unit Defaults**— restores all settings to Garmin's original setup values for the entire unit.

Units Tab— defines Position Format, Map Datum, Heading, Distance, Speed, Elevation, Depth and Temperature.

The following settings are available:

- Position Format— is used to change the coordinate system in which a given position reading is displayed. You should only change the position format if you are using a map or chart that specifies a different position format or wish to use a format you are familiar with. The default format is latitude and longitude in degrees, minutes, and thousandths of a minute (hddd°mm.mmm'). The following additional formats are available:
 - hddd.ddddd°— latitude/longitude in decimal degrees only
 - hddd°mm'ss.s"— latitude/longitude in degrees, minutes, seconds
 - UTM/UPS— Universal Transverse Mercator / Universal Polar Stereographic grids
 - British Grid
 - Dutch Grid
 - Finnish KKJ27
 - German Grid
 - India Zones
 - Irish Grid
 - Loran TD
 - Maidenhead
 - MGRS
 - New Zealand
 - Qatar Grid
 - RT90
 - Swedish Grid
 - Swiss Grid
 - Taiwan Grid
 - User Grid
 - W Malay RSO

For additional information on Loran TD setup, see pages 68-69.

- Map Datum— allows you to manually select the datum reference used to determine a given position. The default setting is 'WGS 84'. The unit will automatically choose the best datum depending upon your chosen position format. Datums are used to describe geographic positions for surveying, mapping, and navigation and are not actual maps built in the unit. Although over 100 datums are available (as listed on pages 79-80), you should only change the datum if you are using a map or chart that specifies a different datum.



WARNING: *Selecting the wrong map datum can result in substantial position errors. When in doubt, use the default WGS 84 datum for best overall performance.*

Reference

Main Menu: Units Tab



The Units tab settings will affect how navigation information is displayed on the GPSMAP 182/182C/232. When in doubt, seek assistance.

If you are using a map or chart in conjunction with your GPS, make sure the settings under the 'Units' tab of the GPSMAP 182/182C/232 match that of the map or chart. This information should be displayed somewhere on the map or chart. If the information is not present, contact the map or chart maker to determine what position format, datum, heading and units of measure are being used for the map or chart.



Units Tab

Reference

Main Menu: Units Tab

GPS	Position Format
Tide	hddd mm.mmm'
Trip	
Chirp	Map Datum
Points	WGS 84
Route	
Track	Headings
DSC	User Mag Var 010
Time	
Pages	Distance, Speed and Elevation
Map	Nautical (nm, kt, ft)
Way	
Temp	Depth
Sonar	Feet (ft)
Systm	
Units	Temperature
Comm	Fahrenheit (°F)
Alarm	

You may manually enter a magnetic variation.



WARNING: If 'User Mag Var' is selected, you must periodically update the magnetic variation as your position changes. Using this setting, the unit will not automatically calculate and update the magnetic variation at your present position. Failure to update this setting may result in substantial differences between the information displayed on your unit and external references, such as a magnetic compass

- **Heading**— lets you select the reference used in calculating heading information. You can select from 'Auto Mag Var', 'True', 'Grid' and 'User Mag Var'. 'Auto Mag Var' provides magnetic north heading references which are automatically determined from your current position. 'True' provides headings based upon a true north reference. 'Grid' provides headings based on a grid north reference (and is used in conjunction with the grid position formats described on page 63). 'User Mag Var' allows you to specify the magnetic variation at your current position and provides magnetic north heading references based upon the variation you enter.

To enter a user defined magnetic variation:

1. With the "Heading" field set to 'User Mag Var', highlight the heading reference field (immediately to the right) and press **ENTER/MARK**.
 2. Use the **ARROW KEYPAD** to enter the magnetic variation at your current position and press **ENTER/MARK**.
- **Distance, Speed and Elevation**— lets you select the desired units of measure for distance, speed and elevation readouts in 'Nautical' (nm, kt, ft), 'Nautical' (nm, kt, m), 'Statute' (mi, mh, ft) or 'Metric' (km, kh, m) terms.
 - **Depth**— lets you select the desired units of measure for depth in Feet (ft), Fathoms (fa) or Meters (m).
 - **Temperature**— lets you select the desired units of measure for temperature in Fahrenheit (°F) or Celsius (°C).

Comm (Communications) Tab— lets you control the input/output format used when connecting your GPSMAP 182/182C/232 to a GSD 20 Sonar Module, external NMEA devices, a DGPS beacon receiver, a personal computer, another Garmin GPSMAP 182/182C/232, etc. Note: If a DGPS receiver is used, WAAS capability will automatically be turned to 'Off'. See pg. 87 for wiring and NMEA version information. The unit supports two input/output ports. Individual Port settings are:

Port 1—

- **GARMIN Data Transfer**— the proprietary format used to upload/download MapSource data, exchange waypoint, route, track, almanac, and proximity data with a PC or another Garmin GPSMAP 182/182C/232. When you select 'GARMIN Data Transfer', there are 11 Transfer Modes to choose from: Host, Request Almanac, Request Proximity, Request Routes, Request Tracks, Request Waypoints, Send Almanac, Send Proximity, Send Routes, Send Tracks and Send Waypoints.

- GARMIN Remote Sonar— supports the GSD 20 Sonar Module interface.
- NMEA In/NMEA Out— supports the input/output of standard NMEA 0183 data, and sonar NMEA input support for the DPT, MTW and VHW sentences.
- None— provides no interfacing capabilities.

Port 2—

- GARMIN Remote Sonar— supports the GSD 20 Sonar Module interface.
- GARMIN DGPS— used to connect the GPSMAP 182/182C/232 with a Garmin DGPS beacon receiver.
- Other DGPS— allows DGPS input using a standard RTCM format, without any output capabilities.
- NMEA In/NMEA Out— supports the input/output of standard NMEA 0183 data, and sonar NMEA input support for the DPT, MTW and VHW sentences. You may also adjust the NMEA output.
- RTCM In/NMEA Out— allows Differential GPS (DGPS) input using a standard RTCM format and also provides NMEA 0183 output.
- None— provides no interfacing capabilities.

To select an input/output format:

1. Select the desired Port tab, then highlight the 'Serial Data Format' field and press **ENTER/MARK**.
2. Use the **ARROW KEYPAD** elect the desired setting and press **ENTER/MARK**.

To select a transfer mode:

1. Use the **ARROW KEYPAD** to select 'GARMIN Data Transfer' in the 'Serial Data Format' field.
2. Highlight the 'Transfer Mode' field and press **ENTER/MARK**.
3. Use the **ARROW KEYPAD** to select the desired setting and press **ENTER/MARK**.

You may also adjust the NMEA output to enable/disable certain sentences and adjust the number of Lat/Lon output precision digits. You must have one of the ports set to NMEA In/NMEA Out to use this option. Settings will affect both Port 1 and Port 2 NMEA outputs.

To adjust the NMEA output:

1. From the Comm tab, press **MENU**, highlight 'NMEA Setup' and press **ENTER/MARK**.
2. Highlight the desired option and press **ENTER/MARK**.
3. Use the **ARROW KEYPAD** to select the desired setting and press **ENTER/MARK**. Press **QUIT** when done to return to the Comm tab.

Reference

Main Menu: Comm Tab



Comm Tab Data Transfer Progress



When transferring data between two Garmin units, be sure to always set one to 'Host' and use the other unit to either Send or Request the desired data.

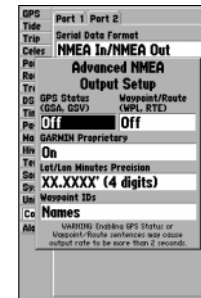

Advanced NMEA Output Setup Page

Reference

Main Menu: Comm tab

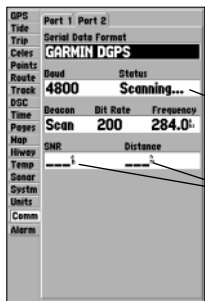

The DGPS beacon transmitters are operated by the U.S. Coast Guard (or similar government agency in other countries), which is responsible for their accuracy and maintenance. For DGPS transmitter problems or to find the most updated list of frequencies and coverage areas, contact your local USCG, or see their web site at <http://www.navcen.uscg.mil/>.

To restore the Serial Data Format settings back to the default 'GARMIN Data Transfer':

1. From the Comm tab, press **MENU**, highlight 'Defaults' and press **ENTER/MARK**.

If 'GARMIN DGPS' or 'RTCM In/NMEA Out' format is selected, additional fields are provided to control a Garmin differential beacon receiver directly from your GPSMAP 182/182C/232. You may have the unit automatically scan for the DGPS beacon signal or you can enter the beacon frequency and bit rate on the unit and the information will be used to tune the beacon receiver.

To have the unit automatically scan for a frequency:

1. With the unit set to 'GARMIN DGPS' or 'RTCM In/NMEA Out', use the **ARROW KEYPAD** to highlight the "Beacon" field and press **ENTER/MARK**.
2. Highlight 'Scan' and press **ENTER/MARK**. The numbers in the "Frequency" field will change as the unit scans from 284 kHz to 325 kHz, 200 bit rate, then 100, at 6-second intervals.

To restart the scan:

1. Press **MENU**, highlight 'Restart Scan' and press **ENTER/MARK**.

To manually enter a frequency and bit rate:

1. With the unit set to 'GARMIN DGPS' or 'RTCM In/NMEA Out', use the **ARROW KEYPAD** to highlight the "Beacon" field and press **ENTER/MARK**.
2. Highlight 'User' and press **ENTER/MARK**.
3. Highlight the "Frequency" or "Bit Rate" field, press **ENTER/MARK**, then enter a frequency or bit rate and press **ENTER/MARK** when done.

The "Status" field will show one of the following:

- Tuning— unit is attempting to tune to the specified frequency and bit rate.
- Scanning— unit is automatically scanning through the frequencies and bit rates.
- Receiving— unit is receiving DGPS signal and ready for operation.
- Check Wiring— unit is not making connection with DGPS receiver.

When the unit is receiving a DGPS signal, the "SNR" (Signal to Noise Ratio) and "Distance" fields will show data. The SNR range is 0dB to 30dB, with 30 being the best. The Distance may or may not show data, depending upon the signal being broadcast from the DGPS site.

Alarm Tab— allow you to define the alarm settings. The Alarm tab is divided into three submenu tabs: System alarms, Nav alarms and Sonar alarms.

System Tab:

- Clock— provides an alarm for the system clock. Enter a time in the time field and turn the alarm on and off from the control field menu. Remember to enter alarm times in the same time format (UTC or local) you're using for your system. The unit must be on for the clock alarm to work.
- Battery— sets an alarm to sound when the battery is reaching a critical state of discharge.
- DGPS and Accuracy— DGPS alarm will sound when the unit loses a differential fix. The accuracy alarm will sound when the GPS position accuracy falls outside the user-set value.

Nav Tab:

- Anchor Drag— sets an alarm to sound when you've exceeded a specified drift distance. Enter a value in the distance field and use the control field to turn the alarm on and off.
- Arrival— sets an alarm to sound when you're a specified distance or time away from a destination waypoint. Enter a distance radius or time for sounding the alarm and use the control field to set the alarm to 'Off', 'Dist' (Distance), or 'Time'.
- Off Course— sets an alarm to sound when you're off a desired course by a specified distance. Enter a distance in the distance field and use the control field to turn the off course alarm on and off.

Sonar Tab: (You must be receiving sonar NMEA data (pg. 87) for these functions to work.)

- Shallow Water/Deep Water— set alarms to sound when you enter an area of specified depth that is too shallow and/or too deep. Enter a depth in the distance fields and use the control fields to turn the alarms on and off.
- Water Temperature — sets an alarm to sound when the transducer reports a temperature either above, below, inside or outside the specified values.
- Fish — sets alarm to sound when unit detects a fish of the specified symbol size.

To set an alarm:

1. Use the **ARROW KEYPAD** to highlight desired submenu tab of the Alarm Tab.
2. Highlight the field below the alarm name you wish activate and press **ENTER/MARK**.
3. Change the mode to the desired setting and press **ENTER/MARK**.
4. Highlight the next field to the right and press **ENTER/MARK**, then enter the desired settings and press **ENTER/MARK** to finish.
5. If you want the alarm to display and beep until acknowledged, highlight the 'Persist' box and press **ENTER/MARK** to place a check mark in the box.

Main Menu: Comm and Alarm Tabs

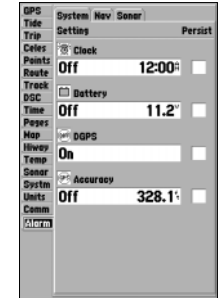

Alarm Tab

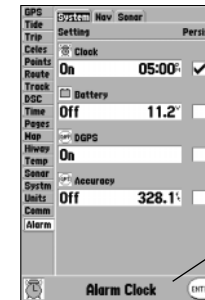

An alarm will stay active until acknowledged if 'Persist' is checked. Press **ENTER/MARK** to acknowledge an alarm.

Appendix A

Loran TD

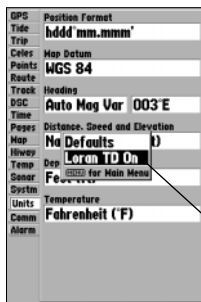

You may change to Loran TD from the Units Tab on the Main Menu.



Loran TD System

LORAN C is a radio navigation aid operated and maintained in the United States by the United States Coast Guard. The name LORAN is an acronym for “Long RANGE Navigation”. The LORAN system covers the entire United States and the U.S. Coastal Confluence Zone. From the perspective of a mariner, the system is used for ocean and coastal navigation. It can be used as a supplemental system for harbor and harbor approach navigation, and it is used for inland navigation by recreational vehicles.

LORAN TD Feature

The LORAN TD (Time Delay) feature eases the transition from using LORAN to using GPS. The GPSMAP unit automatically converts GPS coordinates to LORAN TDs for those who have a collection of LORAN fixes for favorite fishing spots and other waypoints recorded as TDs. You can display your position as a TD or enter waypoints as TDs. The accuracy to be expected from this conversion is approximately thirty meters. When the unit is placed in the LORAN TD format mode, it simulates the operation of a LORAN receiver. Position coordinates may be displayed as TDs, and all navigation functions may be used as if the unit was actually receiving LORAN signals.

Using the LORAN TD Format

When creating new waypoints using LORAN TD coordinates, you must set the correct LORAN chain number and secondary stations in the Setup TD field before storing the waypoint. You must have the correct chain number as well as the secondary station identifiers to use this option correctly. These values will vary per coordinate set or geographical location. Failure to enter correct information could result in inaccuracies for the desired destination. After the waypoint is stored in unit memory, it will always reference the LORAN chain number and secondary stations currently selected in the Setup TD field. If you enter a different LORAN chain number, change the secondary stations or offsets in the Setup TD field, the active waypoint information will reflect those changes. Since the GPSMAP unit does not rely on the LORAN signal for navigation, it can reference a different GRI chain and/or secondary stations and still navigate to the location stored in memory.

The LORAN Position Format field is located under the Units tab in the Main Menu. The 'LORAN TD Setup' window contains the fields to select the Loran GRI-Chain Number, Primary and Secondary Stations, and TD Offsets.

To setup Loran TD from the Main Menu:

1. Using the **ARROW KEYPAD**, highlight the "Units" tab and then the "Position Format" field and press **ENTER/MARK**. You may also press **MENU** from the "Units" tab to display the 'Loran TD On' option. (If you use 'Loran TD On', skip to step 3.)
2. Highlight 'Loran TD', press **ENTER/MARK**, then highlight 'Setup' and press **ENTER/MARK**.
3. To change the settings of any of the five fields, highlight the field, press **ENTER/MARK**, select/enter the desired setting and press **ENTER/MARK**.
4. When done, press the **QUIT** key to return to the Main Menu.

If the active GRI Chain, secondary stations or offsets have been changed since the waypoint was created, the waypoint will now reference the active GRI-chain and secondary stations and adjust the TD coordinates accordingly. Remember that the GPS is not relying on the LORAN signal for navigation and actually converts the TD coordinate to a useful LAT/LON coordinate (in the background) before storing the waypoint to memory or using it for navigation. Because of this the unit can navigate to a TD coordinate anywhere in the world.

For more information on Loran TDs, you may download Garmin's "Loran TD Position Format Handbook" from the Garmin web site at <http://www.garmin.com/support/userManual.html>.

Loran TD Setup

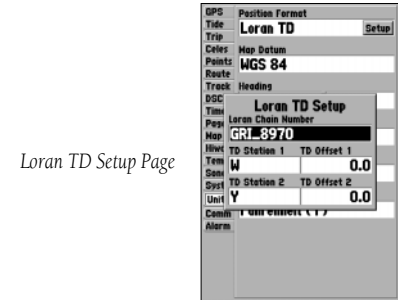

Loran TD Setup Page

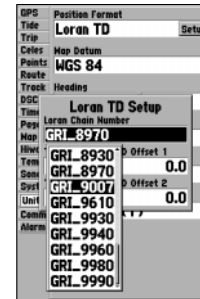

Selecting the Loran Chain Number.

Digital Selective Calling (DSC)

WHAT IS DIGITAL SELECTIVE CALLING (DSC)?

Digital Selective Calling (DSC) uses marine VHF radio and Global Positioning System (GPS) technologies to transmit and receive location information. DSC is used by mariners to assist them in two major areas: Distress Calls and Position Reporting.

An emergency DSC Distress Call allows a vessel in trouble to transmit a substantial amount of information in a single transmission or “call,” without the need for voice communication. When any nearby rescuer receives the DSC signal, an alarm sounds and they immediately receive the position of the caller. The rescuer may then choose to navigate (Go To) the caller’s position to assist or forward the call on to the Coast Guard. When the Coast Guard receives the call, they can immediately access the caller’s information (such as who they are and the type of vessel) in their database while they are in transit to the caller’s position.

A non-emergency DSC Position Report allows mariners to exchange and display the positions of one another. Once a DSC position is received, the mariner may choose to create a waypoint or to show the received position on an electronic map.

Anytime a vessel receives a DSC call, they can store that location and quickly navigate to that position using a Go To. This makes DSC a time saver, especially in an emergency situation. In order to use DSC, users must first register their VHF radio with the FCC and receive a Maritime Mobile Service Identity (MMSI) number.

WHAT IS A MARITIME MOBILE SERVICE IDENTITY (MMSI)?

Maritime Mobile Service Identity (MMSI) basically allows a VHF radio to act like a phone. In order to make a “call” on a phone, you first need a phone number to dial. The 9 digit MMSI number acts like a phone number when used in a *Position Report* and as a unique identifier to the Coast Guard when used in an emergency *Distress Call*. In order to obtain a Maritime Mobile Service Identity (MMSI) number, users must register their VHF radio with the FCC (Form 605). **Garmin does not supply this number!** Information to obtain this number can be found on the next page.

Digital Selective Calling (DSC)

HOW ARE MMSI ASSIGNMENTS OBTAINED?

Non-commercial users (e.g. recreational users who remain in domestic waters and only carry VHF, EPIRB (Emergency Position Indicating Radio Beacons), and Radar) are not required to have a FCC ship station license. The FCC and Coast Guard have authorized some second and third party vendors to assign MMSI numbers. This service is limited to registering recreational vessels only. **To receive information on how to obtain a recreational MMSI number please contact:** <http://www.uscg.mil/rescue21/links/mmsi.htm> or <http://wireless.fcc.gov/marine/>.

U.S Non-Federal User: Commercial users, or those who travel outside the U.S. or Canada, must apply for a ship station license, or an amendment to a ship station license. **To find out if you require a Ship Station license contact:** <http://wireless.fcc.gov/marine/ftsht14.html>. If your vessel requires licensing by the FCC you will obtain a MMSI during the application/licensing process when you file FCC Forms 159 and 605.

U.S. Federal User: Federal users can obtain MMSI assignments from their agency radio spectrum management office. These procedures are currently under review by the NTIA (National Telecommunications and Information Administration).

Outside the U.S.: Users can obtain an MMSI assignment from their telecommunications authority or ship registry, often by obtaining or amending their ship station license.

In Canada: Industry Canada is responsible for assigning MMSI numbers to commercial and recreational vessels. Information is available at the following web site: <http://apollo.ic.gc.ca/english/mmsi.html>.

For more information regarding MMSI's visit: <http://www.navcen.uscg.gov/marcomms/gmdss/mmsi.htm>.

HOW CAN GARMIN HELP YOU WITH DSC?

To receive *Distress Calls* or *Position Reports*, the user must have a DSC-equipped chartplotter as well as a VHF radio with DSC support. During normal, non-emergency *Position Report* communication, Channel 70 (156.525 MHz) has been set aside as the VHF/DSC digital call channel. For a *Distress Call*, a mariner presses the MayDay button on their VHF radio. The call transmits on an emergency channel

Appendix B

Digital Selective Calling (DSC)



Distress Call Message

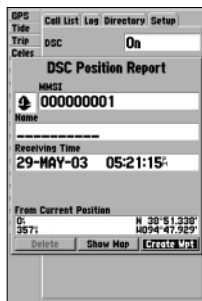

Position Report Message

with the MMSI number attached to the call (if the user has DSC support). Any DSC-equipped mariner (on sea or land) within range can receive the call.

When the Garmin GPSMAP 182/182C/232 is connected to a VHF with DSC support, the GPS unit displays a Call List, Log, and a Directory available to store incoming information received from another user's DSC capable VHF/GPS combination. Basic wiring is required for the Garmin unit and VHF radio to send and receive NMEA data from each other (pg.87).

Distress Call

With a Garmin DSC capable chartplotter/sounder properly connected to a VHF radio with DSC output, the user may receive any DSC Distress Call within range. A window will pop up and a message will display when a Distress Call is received. To notify the user a Distress Call has been received, an alarm will sound (if enabled). The alarm only sounds on a Distress Call, and it will not sound on a Position Report. Distress Calls are broadcasted to all DSC users in radio range.

Options available from this screen are:

- Show on Map: If the user immediately wants to see the caller's position they select 'Show on Map'.
- Create Waypoint: If the user wanted to create a waypoint of that position they highlight 'Create Waypoint' and press **ENTER/MARK**.

The user also has the ability to input the user's name, if it is known. (NOTE: The user's name replaces the MMSI number as a reference once it is entered.)

DSC Position Report

The Position Report operates similarly to the Distress Call. Remember this type of contact is like a phone call, but no emergency alarms are set off and the call is specific to the receiver. Position Reports are not broadcasted to all DSC users.

Digital Selective Calling (DSC)

DSC Call List

The DSC Call List displays the current calls received. The GPS can manage up to 50 calls. When 'calls' are received, they are updated constantly to give the most current information, even if the unit is left unattended. Any entry from the Call List can be selected to show an Entry Review.

DSC Log

When DSC calls are received, they are automatically stored in the Log, with the latest call at the top. The unit may store up to 100 logs. Once 100 logs are received, the oldest log file is removed when a new call is received. The Log displays information of call Type, Date/Time, Position, and MMSI/Name. Pressing **MENU** from this page allows you to 'Sort By Time', 'Sort By Name', 'Sort By (Call) Type', 'Delete' (only after highlighting a particular call), and 'Delete All'.

To Review a Call:

1. From the DSC tab of the Main Menu and the **Log** or **Call List** tab highlighted, press **DOWN** Arrow Keypad until the call you want to review is highlighted.
2. Press **ENTER/MARK** to select the call.

DSC Entry Review

The DSC Entry Review operates similarly to the Distress Page and Position Report Page. This page has the additional option to 'Delete' the displayed call. From the DSC Entry Review, the user can 'Delete' the entry, 'Show on map', or 'Create Waypoint'.and create a name for the entry.

DSC Directory

The DSC Directory acts much like a phone book. A user can save up to 50 contacts. The directory lists by Name and MMSI number. Pressing **MENU** from this page allows you to create a 'New Item', 'Delete Item', or 'Delete All'.

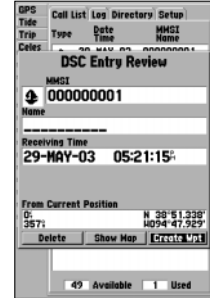

DSC Entry Review

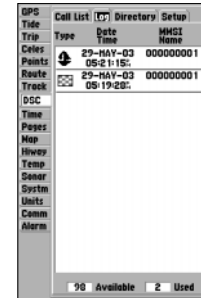

DSC Log

Appendix B

Digital Selective Calling (DSC)



Adding a Directory Entry

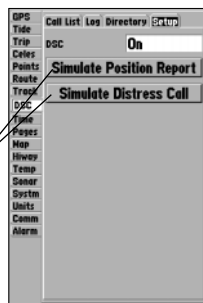

DSC Setup
'Simulate ...' options only appear while in Simulator mode.

There are two ways to add a new entry into the directory.

To add a new Directory entry:

1. Press Menu, then highlight 'New Item' and press **ENTER/MARK**.
2. Or, with the Directory Tab highlighted press the Arrow Keypad **DOWN**, highlight an empty field and press **ENTER/MARK** to access the New Directory Item window.

The New Directory Item window allows the user to input information of a known contact.

To add the MMSI number, Name, or Comment:

1. Press **UP/DOWN** on the Arrow Keypad to highlight the MMSI, Name, or Comment field.
2. Press **ENTER/MARK** to highlight the first digit on that field.
3. Press **UP/DOWN** on the Arrow Keypad to enter the numbers/letters.
4. Press **LEFT/RIGHT** on the Arrow Keypad to move to the next position.
5. Press **ENTER/MARK** to accept the entry.
6. Press **UP/DOWN** on the Arrow Keypad, highlight the 'Delete' button and press **ENTER/MARK** to delete the entry, or highlight the 'OK' button and press **ENTER/MARK** to accept the entry.

After creating a New Directory Item entry, the name created is attached to that particular MMSI number. If the user returns to the Log, the new name is displayed under the corresponding MMSI number. Another way to input a name is from the Entry Review page or the DSC Distress Call or DSC Position Report pages. The Name field is only available in the GPS. Names cannot be sent like the MMSI numbers to other DSC users.

DSC Setup

Garmin chartplotters have the ability to turn DSC 'On' or 'Off'. This option is beneficial for users who have more than one GPS chartplotter. If the user wants only DSC to display on a particular chartplotter, turn DSC off on the remaining Garmin chartplotters that support DSC.

A user also has the ability to simulate a Distress Call or a Position Report on this page. This is help-

ful for practice before connecting to the real system. The Distress Call simulator also helps to check if alarms are working properly.

To run a simulation:

1. Place the chartplotter into simulation (see pg. 7).
2. From the Main Menu, select the DSC tab, then highlight the Setup tab.
3. Highlight which simulation you wish to run and press **ENTER/MARK**.

Using the NAV Button

The receiver of a Distress Call or Position Report can quickly navigate to the caller using the NAV button. Once the call is logged the user presses the NAV button and selects to Go To the MMSI number or the Name of the caller.

Digital Selective Calling (DSC)

Appendix C

Time Offsets



A simple way to determine your local time offset is how many hours you are behind or ahead of UTC (also called 'Greenwich' or 'zulu' time).

Example: EST (Eastern Standard Time) is 5 hours behind UTC, so your offset would be -5. Adding one hour for daylight savings would make EDT (Eastern Daylight Time) - 4. Subtract an hour for each time zone as you travel west.

Offsets for Continental U.S. would be:

EST	-5	EDT	-4
CST	-6	CDT	-5
MST	-7	MDT	-6
PST	-8	PDT	-7

The chart below gives an approximate UTC (Universal Time Coordinate) time offset for the various longitudinal zones. Check with local charts for more detailed information. If you are in daylight savings time, add one hour to the offset.

Longitudinal Zone	Offset	Longitudinal Zone	Offset
W180.0° to W172.5°	-12	E007.5° to E022.5°	+1
W172.5° to W157.5°	-11	E022.5° to E037.5°	+2
W157.5° to W142.5°	-10	E037.5° to E052.5°	+3
W142.5° to W127.5°	-9	E052.5° to E067.5°	+4
W127.5° to W112.5°	-8	E067.5° to E082.5°	+5
W112.5° to W097.5°	-7	E082.5° to E097.5°	+6
W097.5° to W082.5°	-6	E097.5° to E112.5°	+7
W082.5° to W067.5°	-5	E112.5° to E127.5°	+8
W067.5° to W052.5°	-4	E127.5° to E142.5°	+9
W052.5° to W037.5°	-3	E142.5° to E157.5°	+10
W037.5° to W022.5°	-2	E157.5° to E172.5°	+11
W022.5° to W007.5°	-1	E172.5° to E180.0°	+12
W007.5° to E007.5°	0		

The GPSMAP 182/182C/232 uses an on-screen pop-up message system to alert you to unit operating characteristics. Press the **ENTER** key to acknowledge and return to the page you were viewing.

Alarm Clock— The alarm clock has sounded.

Anchor Drag Alarm— You have drifted out of the specified distance range.

Antenna Input Shorted To Ground— Check antenna wiring/connections or antenna replacement.

Approaching Waypoint— You are a specified alarm distance from a destination waypoint.

Arrival At Waypoint— You have arrived at the destination waypoint.

Basemap Failed Unit Needs Repair— Internal problem with unit. Contact your dealer or Garmin Customer Service (pg. iv) to have the unit serviced.

Database Error— Internal problem with unit. Contact your dealer or Garmin Customer Service (pg. iv) to have the unit serviced.

Lost Satellite Reception— The unit has lost satellite signals. Check antenna connections or try moving to a location with a clear view of the sky.

Memory (RAM) Failed Unit Needs Repair— Internal problem with unit. Contact your dealer or Garmin Customer Service (pg. iv) to have the unit serviced.

Memory (ROM) Failed Unit Needs Repair— Internal problem with unit. Contact your dealer or Garmin Customer Service (pg. iv) to have the unit serviced.

No DGPS Position— No differential correction data is available or not enough data is available to compute a DGPS position.

Off Course Alarm— You have exceeded the specified off-course distance.

Processor Failed Unit Needs Repair— Internal problem with unit. Contact your dealer or Garmin Customer Service (pg. iv) to have the unit serviced.

Proximity Alarm List is Full— You have used all ten proximity waypoints.

Proximity Alarm Waypoint— You have entered the alarm radius for the proximity waypoint indicated.

Appendix D

Messages

Proximity Overlaps Another Proximity Waypoint—The alarm radius specified overlaps the area specified for another proximity waypoint. Adjust distance.

Route Already Exists: <route name>— You have entered a route name that already exists in memory. Modify route name or delete the previous route name.

Route Does Not Exist: <route name>— Route has been renamed or removed from memory and cannot be used.

Route Is Full— You have attempted to add more than 50 points to a route. Reduce number of points or create second route.

Route Memory Is Full Can't Create Route— Maximum amount of 50 routes already in unit memory and no additional routes can be added until existing ones are removed.

Route Truncated— Uploaded route from other device has more than 50 points. Reduce number of points.

Running Simulator— Unit is in simulator (practice) mode.

Track Already Exists: <track name>— You have entered a saved track name that already exists in memory. Modify track name or delete the previous track name.

Track Memory Is Full Can't Create Track— Track log memory is full. No additional track log data can be stored without deleting old data to create memory space.

Track Truncated— A complete upload track will not fit into memory. The oldest track log points were deleted to make space for the most recent data.

Transfer Complete— The unit has finished uploading/downloading information to the connected device.

Waypoint Already Exists: <waypoint name>— You have entered a waypoint name that already exists in memory. Modify waypoint name or delete the previous waypoint name.

Waypoint Memory Is Full Can't Create Waypoint— You have used all 3000 waypoints available. Delete unwanted waypoints to make space for new entries.

Adindan	Adindan- Ethiopia, Mali, Senegal, Sudan
Afgooye	Afgooye- Somalia
AIN EL ABD '70	AIN EL ANBD 1970- Bahrain Island, Saudi Arabia
Anna 1 Ast '65	Anna 1 Astro '65- Cocos I.
ARC 1950	ARC 1950- Botswana, Lesotho, Malawi, Swaziland, Zaire, Zambia, Zimbabwe
ARC 1960	Kenya, Tanzania
Ascnsn Isld '58	Ascension Island '58- Ascension Island
Astro B4 Sorol	Sorol Atoll- Tern Island
Astro Bcn "E"	Astro Beacon "E"- Iwo Jima
Astro Dos 71/4	Astro Dos 71/4- St. Helena
Astr Stn '52	Astronomic Stn '52- Marcus Island
Aus Geod '66	Australian Geod '66- Australia, Tasmania Island
Aus Geod '84	Australian Geod '84- Australia, Tasmania Island
Austria	Austria
Bellevue (IGN)	Efate and Erromango Islands
Bermuda 1957	Bermuda 1957- Bermuda Islands
Bogata Observ	Bogata Observatry- Colombia
Campo Inchspe	Campo Inchauspe- Argentina
Canton Ast '66	Canton Astro 1966- Phoenix Islands
Cape	Cape- South Africa
Cape Canavrl	Cape Canaveral- Florida, Bahama Islands
Carthage	Carthage- Tunisia
CH-1903	CH 1903- Switzerland
Chatham 1971	Chatham 1971- Chatham Island (New Zealand)

Chua Astro	Chua Astro- Paraguay
Croatia	Croatia
Corrego Alegr	Corrego Alegre- Brazil
Djakarta	Djakarta (Batavia)- Sumatra Island (Indonesia)
Dos 1968	Dos 1968- Gizo Island (New Georgia Islands)
Dutch	Dutch
Easter Isld 67	Easter Island 1967
European 1950	European 1950- Austria, Belgium, Denmark, Finland, France, Germany, Gibraltar, Greece, Italy, Luxembourg, Netherlands, Norway, Portugal, Spain, Sweden, Switzerland
European 1979	European 1979- Austria, Finland, Netherlands, Norway, Spain, Sweden, Switzerland
Finland Hayfrd	Finland Hayford- Finland
Gandajika Base	Gandajika Base- Republic of Maldives
GDA	Geocentric Datum of Australia
Geod Datm '49	Geodetic Datum '49-New Zealand
Guam 1963	Guam 1963- Guam Island
Gux 1 Astro	Guadalcanal Island
Hjorsey 1955	Hjorsey 1955- Iceland
Hong Kong '63	Hong Kong
Hu-Tzu-Shan	Taiwan
Indian Bngldsh	Indian- Bangladesh, India, Nepal
Indian Thailand	Indian- Thailand, Vietnam
Indonesia 74	Indonesia 1974-Indonesia
Ireland 1965	Ireland 1965- Ireland
ISTS 073 Astro	ISTS 073 ASTRO '69- Diego Garcia

Appendix E

Map Datums



The GPSMAP's built-in world-wide database includes coverage down to 20 n.m. (30 km). Note that the GPSMAP 182/182C/232 basemap is valid to 75° north and 60° south of latitude.



The 'User' datum is based on a WGS-84 Local datum and is an advanced feature for unlisted or custom datums. To learn more, check your local library or on the world wide web for educational materials on datums and coordinate systems.

Appendix E

Map Datums

Johnston Island	Johnston Island Kandawala Kandawala- Sri Lanka
Kerguelen Islnd	Kerguelen Island
Kertau 1948	West Malaysia, Singapore
L. C. 5 Astro	Cayman Brac Island
Liberia 1964	Liberia 1964- Liberia
Luzon Mindanao	Luzon- Mindanao Island
Luzon Philippine	Luzon- Philippines (excluding Mindanao Isl.)
Mahe 1971	Mahe 1971- Mahe Island
Marco Astro	Marco Astro- Salvage Isl.
Massawa	Massawa- Eritrea (Ethiopia)
Merchich	Merchich- Morocco
Midway Ast '61	Midway Astro '61- Midway
Minna	Minna- Nigeria
NAD27 Alaska	North American 1927- Alaska
NAD27 Bahamas	North American 1927- Bahamas (excluding San Salvador Island)
NAD27 Canada	North American 1927- Canada and Newfoundland
NAD27 Canal Zone	North Am. 1927- Canal Zone
NAD27 Caribbn	North American 1927- Caribbean (Barbados, Caicos Islands, Cuba, Dom. Rep., Grd. Cayman, Jamaica, Leeward and Turks Islands)

NAD27 Central	North American 1927-Central America (Belize, Costa Rica, El Salvador, Guatemala, Honduras, Nicaragua)
NAD27 CONUS	North Am. 1927- Mean Value (CONUS)
NAD27 Cuba	North American 1927- Cuba
NAD27 Grnland	North American 1927- Greenland (Hayes Peninsula)
NAD27 Mexico	N. American 1927- Mexico
NAD27 San Sal	North American 1927- San Salvador Island
NAD83	North American 1983- Alaska, Canada, Central America, CONUS, Mexico
Nhrwn Masirah	Nahrwn- Masirah Island (Oman)
Nhrwn Saudi A	Nahrwn- Saudi Arabia
Nhrwn United A	Nahrwn- United Arab Emirates
Naparima BWI	Naparima BWI- Trinidad and Tobago
Obsrvtorio '66	Observatorio 1966- Corvo and Flores Islands (Azores)
Old Egyptian	Old Egyptian- Egypt
Old Hawaiian	Old Hawaiian- Mean Value
Oman	Oman- Oman
Ord Srvy GB	Old Survey Grt Britn- England, Isle of Man, Scotland, Shetland Isl., Wales
Pico De Las Nv	Canary Islands
Potsdam	Potsdam-Germany
Ptcairn Ast '67	Pitcairn Astro '67- Pitcairn
Prov S Am '56	Prov So Amrcn '56- Bolivia, Chile, Colombia, Ecuador, Guyana, Peru, Venezuela
Prov S Chln '63	So Chilean '63- S. Chile
Puerto Rico	Puerto Rico & Virgin Isl.
Qatar	Qatar National- Qatar

Qornoq	Qornoq- South Greenland
Reunion	Reunion- Mascarene Island
Rome 1940	Rome 1940- Sardinia Isl.
RT 90	Sweden
Santo (Dos)	Santo (Dos)- Espirito Santo
Sao Braz	Sao Braz- Sao Miguel, Santa Maria Islands
Sapper Hill '43	Sapper Hill 1943- East Falkland Island
Schwarzeck	Schwarzeck- Namibia
Sth Amrcn '69	S. American '69- Argentina, Bolivia, Brazil, Chile, Colombia, Ecuador, Guyana, Paraguay, Peru, Venezuela, Trin/Tobago
South Asia	South Asia- Singapore
SE Base	Southeast Base- Porto Santo and Madera Islands
SW Base	Southwest Base- Faial, Graciosa, Pico, Sao Jorge and Terceira Islands
Taiwan	Modified Taiwan
Timbalai 1948	Timbalai 1948- Brunei and E. Malaysia (Sarawak and Sabah)
Tokyo	Tokyo- Japan, Korea, Okinawa
Tristan Ast '68	Tristan Astro 1968- Tristan da Cunha
User	User-defined custom datum
Viti Levu 1916	Viti Levu 1916- Viti Levu/Fiji Islands
Wake-Eniwetok	Wake-Eniwetok- Marshall
WGS 72	World Geodetic System 72
WGS 84	World Geodetic System 84
Zanderij	Zanderij- Surinam

Navigation Terms

Avg Speed— The average of all second-by-second speed readings since last reset.

Bearing (BRG)— The compass direction from your present position to a destination waypoint.

Course— The desired course between the active 'from' and 'to' waypoints.

Distance (Dist)— The 'great circle' distance from present position to a destination waypoint.

Distance to Destination— The 'great circle' distance from present position to a GOTO destination, or the final waypoint in a route.

Distance to Next— The 'great circle' distance from present position to a GOTO destination, or the next waypoint in a route.

Elevation— Height above mean sea level (MSL).

ETA— Estimate Time of Arrival. The estimated time you will reach your destination waypoint, based on current speed and track.

ETA at Destination— The estimated time you will reach a GOTO destination, or the final waypoint in a route.

ETA at Next— The estimated time you will reach a GOTO destination, or the next waypoint in a route.

Fuel— The fuel required to travel from present position to the indicated route waypoint.

Leg Dist— The distance between two route waypoints.

Leg Fuel— The fuel required to travel from a route waypoint to the next waypoint (in sequence) in the route.

Leg Time— The time required to travel from a route waypoint to the next waypoint (in sequence) in the route.

Max Speed— The maximum second-by-second speed recorded since last reset.

Moving Average Speed— Average speed while the unit is moving.

Moving Trip Timer— Total time the unit has been moving.

Appendix F

Navigation Terms

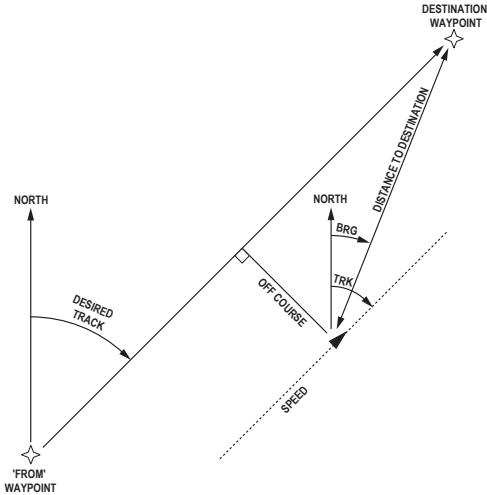

Odometer— A running tally of distance travelled, based upon the distance between second-by-second position readings.

Off Course— The distance you are off a desired course in either direction, left or right. Also referred to as 'cross-track error' or 'course error'.

Speed— The current velocity at which you are travelling, relative to a ground position. Also referred to as 'ground speed'.

Time To— The estimated time required to reach a GOTO destination, or the next waypoint in a route. Also referred to as 'estimated time en route'.

Time to Destination— The estimated time required to reach a GOTO destination, or the final waypoint in a route.

Time to Next— The estimated time required to reach a GOTO destination, or the next waypoint in a route.

To Course— The recommended direction to steer in order to reduce course error or stay on course. Provides the most efficient heading to get back to the desired course and proceed along your route.

Track— The direction of movement relative to a ground position. Also referred to as 'ground track'.

Trip Odometer— A running tally of distance travelled since last reset. Also see 'Odometer'.

Total Average Speed— Average speed of unit for both moving and stopped speeds since last timer reset.

Total Trip Timer— Total time the unit has been in operation since last reset of the trip timers.

Turn— The angle difference between the bearing to your destination and your current track. 'L' indicates you should turn left, 'R' indicates you should turn right. The degrees indicate the angle you are off course.

VMG— Velocity Made Good. The speed you are closing in on a destination along a desired course. Also referred to as the 'vector velocity' to your destination.

Physical Specifications

Size:	182: 6.18" H x 6.30" W x 2.64" D (15.7cm x 16.0cm x 6.7cm) 232: 7.55" H x 7.7" W x 2.57" D (19.18 x 19.56 x 6.53 cm) 182C: 6.18" H x 6.30" W x 2.64" D (15.7cm x 16.0cm x 6.7cm)
Weight:	182/ 182C: Less than 2.0 lb. (.763Kg); 232: less than 2.0 lb. (.907Kg)
Display:	182: 5.5" diagonal (14.1cm) 232: 7.1" diagonal (18.03cm) high-contrast, 10-level gray FSTN LCD with adjustable backlighting (360 x 240 pixels) 182C: 5.0" diagonal (12.7cm) 16-color TFT display with backlighting (234 x 320 pixels)
Case:	Fully gasketed, high-impact plastic alloy, waterproof to IEC 529-IPX-7
Temp. Range:	5°F to 158°F (-15°C to 70°C)

Performance

Receiver:	Differential-ready 12 parallel channel WAAS capable receiver
Acquisition Times:	
Warm:	Approx. 15 seconds
Cold:	Approx. 45 seconds
AutoLocate:	Approx. 2 minutes
Update Rate:	1/second, continuous
GPS Accuracy:	Position*: <15 meters (49 feet), 95% typical* Velocity: 0.05 meters/sec steady state
DGPS (USCG) Accuracy:	Position: 3-5 meters (10-16 feet) with optional Garmin DGPS receiver, 95% typical* Velocity: 0.05 meters/sec steady state
DGPS (WAAS) Accuracy:	Position: <3 meters (10 feet), 95% typical* Velocity: 0.05 meters/sec steady state
Dynamics:	6g's

* Subject to accuracy degradation to 100m 2DRMS under the U.S. DOD-imposed Selective Availability Program.

Power

Source:	182C: 10-35V DC; 182/232: 8-35vDC
Usage:	182/232: 4 watts max; 182C: 10 watts max. at 13.8vDC
Fuse:	AGC/3AG - 1.5 Amp

Appendix G

Specifications

UNIT CARE

Cleaning - The GPSMAP 182C lens is coated with a special anti-reflective coating which is very sensitive to skin oils, waxes and abrasive cleaners. CLEANERS CONTAINING AMMONIA WILL HARM THE ANTI-REFLECTIVE COATING. It is very important to clean the lens using an eyeglass lens cleaner which is specified as safe for anti-reflective coatings and a clean, lint-free cloth. Units with a monochrome display may use the same cleaning method. The unit's case is constructed of high quality material and does not require user maintenance other than cleaning. Clean the unit housing using a cloth lightly dampened with a mild detergent solution and then wipe dry. Avoid chemical cleaners and solvents that may damage plastic components. Do not apply cleaner to electrical contacts on the back of the unit.

Storage - Do not store the unit where exposure to temperature extremes may occur (see left), as permanent damage may result. User information, such as waypoints, routes, etc. will be retained in the unit's memory, without the need for external power. It is always a good practice to back up important user data by manually recording it or downloading it to a PC (see pg. 64).

Appendix H

Antenna Installation

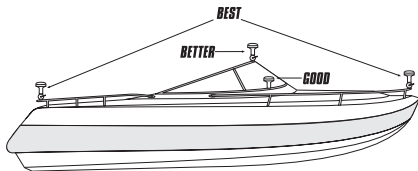

Suggested locations for mounting the GA 29 antenna.



It is possible to route the coaxial cable either through, or outside the antenna mount. It is possible to remove the BNC connector on the coaxial cable and the coaxial cable shortened to ease installation, however, doing so will void the antenna warranty. If the BNC connector is removed it must be replaced with a new solder-on or crimp BNC connector.

Installing the GPSMAP 182/182C/232

The GPSMAP 182/182C/232 must be properly installed according to the following instructions to get the best possible performance. If you have the GPSMAP 182/182C/232 with the built-in internal bail mount antenna, you may skip this section and proceed to the next page. For units purchased with the remote GA 29 antenna, follow the instructions below. To complete the installation, you'll need the appropriate fasteners and a 1" x 14-thread marine antenna mount available at most marine dealers.

When in doubt, seek professional assistance.

Mounting the GPS Antenna

The antenna should be mounted in a location that has a clear, unobstructed view of the sky in all directions to ensure the best reception. Avoid mounting the antenna where it will be shaded by the boat's superstructure, a radome antenna, or mast. Sailboat users should avoid mounting the antenna high on the mast to prevent inaccurate speed readings caused by excessive heeling. Most marine VHF and LORAN antennas should not seriously degrade the GPS antenna's reception. Never paint the antenna or clean it with harsh solvents.

The Garmin antenna screws directly onto any standard 1" x 14-thread antenna mount. If you need to raise the antenna to avoid shading, try using a 1" x 14-thread extension mast available at most marine dealers.

To install the GPS antenna:

1. Screw the antenna directly onto the 1" x 14-thread mount.
2. Route the cable to the mounting location of the display unit. Use the appropriate tie-wraps, fasteners and sealant to secure the cable along the route and through any bulkhead or deck.
3. Once the GPSMAP 182/182C/232 unit has been installed, connect the cable to the antenna connector on the back of the display unit. Make sure that you turn the antenna cable connector 1/4 turn clockwise to lock the cable into place.

Unit Installation

Mounting the GPSMAP 182/182C/232 Unit

The GPSMAP 182/182C/232's compact, waterproof case is suitable for mounting in exposed locations or at the nav station. The unit comes with a gimbal bracket that can be used for surface or overhead mounting. When choosing a location for the display unit, make sure you consider the following conditions:

- There should be at least a 3" (7 cm) clearance behind the case to allow connection of the antenna (external antenna only), power/data cables.
- The mounting surface should be heavy enough to support the unit and protect it from excessive vibration and shock.
- For GPSMAP 182/182C/232 unit's with the built-in internal bail mount antenna, it should be mounted in a location that has the clearest, most unobstructed view of the sky in all directions to ensure the best reception. Avoid mounting the unit where it will be blocked by the boat's superstructure, a radar arch, or mast.



The temperature range for the GPSMAP 182/182C/232 is 5°F to 158°F (-15°C to 70°C). Extended exposure to temperatures exceeding this range (in storage or operating conditions) may cause failure of the LCD screen. This type of failure and related consequences are NOT covered by the manufacturer's limited warranty.

To install the GPSMAP 182/182C/232 unit:

1. Place the mounting bracket in the desired location.
2. Mark and drill the four mounting holes for the fastener you are using.
3. Fasten the bracket to the surface using the appropriate fastener.
4. Insert the GPSMAP 182/182C/232 into the mounting bracket. The bracket is designed for a tight fit to provide additional support when swiveling the unit.
5. Screw the two mounting knobs through the bracket and into the display case.
6. Connect the power/data and antenna cables (external antenna only) to the back of the unit, making sure the locking rings are fully tightened on both connectors.

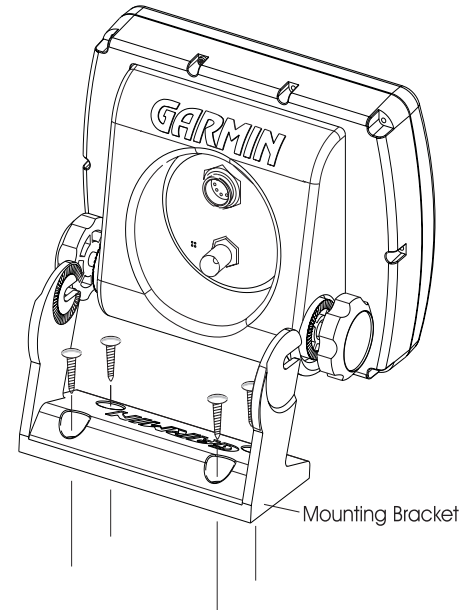

Appendix H

Unit Installation

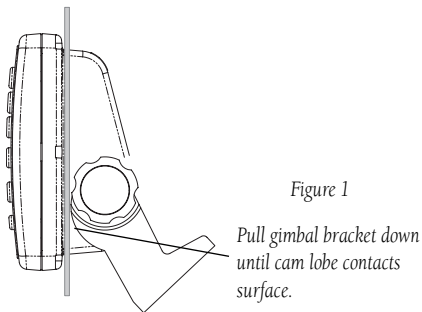

Figure 1

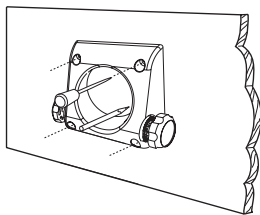

Figure 2

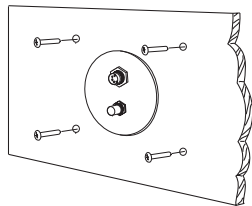

Figure 3

The GPSMAP 182/182C/232 with external antenna can be flush mounted on a flat panel of .08-.52" thickness using the cam lobe feature on its gimbal mounting bracket. When flush mounting the GPSMAP 182/182C/232, be sure to choose an appropriately sized location for the unit (see unit dimensions pg. 83) and leave 1.25" (32mm) clearance below the data card slot for inserting/removing data cards. For flush mounting the GPSMAP 232 unit, skip to the next set of instructions.

To flush mount the GPSMAP 182/182C unit using the gimbal mounting bracket:

1. Cut a 4.33"W x 4.33"H (110 x 110 mm) hole in the panel.
2. Place the GPSMAP 182/182C/232 into the hole from the front until the flange rests against the mounting surface.
3. From the back of the panel, loosely attach the bracket such that the slot in the ratchet area points away from the mounting panel (figure 1).
4. Rotate the bracket downward until the panel is pinched tightly between the unit's flange and bracket lobe (figure 1).
5. Tighten the knobs and connect the power/data and antenna cables. Note: if the panel is too thick to allow use of the supplied knobs, two M6 screws may be used to secure the bracket.

The GPSMAP 182/182C/232, with external antenna, may also be flush mounted on a flat panel using its existing mounting bracket.

To flush mount the GPSMAP 182/182C/232 unit:

1. Remove the four M5 screws from the back of the unit and remove the mounting bracket.
2. Using the mounting bracket as a template, outline the center relief area and mark the location of the four screw holes centers on your bulkhead or other surface (figure 2).
3. Cut the relief hole from the panel and drill the four 0.20" (5.08 mm) screw holes.
4. Place the GPSMAP 182/182C/232 into the relief hole until it rests flush against the mounting surface.
5. Secure the unit to the mounting surface using the M5 screws. Do not try to force the screws deeper into the holes than the holes will allow. For thick mounting surfaces, insert the M5 screws directly thru the drilled holes (figure 3). For thin panels, place the mounting bracket on the back side of the panel for more support. Connect the power/data and antenna cables.

Connecting the Power/Data

The power/data cable connects the GPSMAP 182/182C/232 to a DC system and provides interface capabilities for connecting external devices. The color code in the diagram below indicates the appropriate harness connections. Replacement fuse is a AGC/3AG 1.5 Amp fuse. For wiring the GPSMAP to a GSD 20 Sonar Module, refer to the “GSD 20 Installation Guide”(190-00255-00).

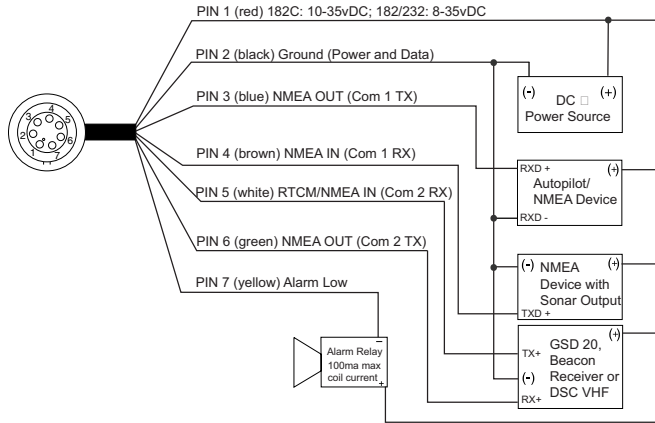

Interfacing

The following formats are supported for connection of external devices: Garmin proprietary GSD 20 Sonar Module and Differential GPS (DGPS), NMEA 0183 version 2.3 (3.01 on GPSMAP 182C software version 5.20 & GPSMAP 182/232 4.20 and higher) , RTCM SC-104 input (version 2.0).

The following are the sentences for NMEA 0183, version 2.3 and later output:

Approved sentences— GPBWC, GPRMC, GPGGA, GPGSA, GPGSV, GPGLL, GPBOD, GPRMB, GPRTE, GPVTG, GPWPL and GPXTE. Proprietary sentences— PGRME, PGRMM, PGRMZ, and PSLIB.

The GPSMAP 182/182C/232 also includes NMEA input with support for the WPL sentence and sonar NMEA input with support for the DPT (Depth), MTW (Water Temp) and VHW (Water Speed & Heading) sentences. If connecting to COM2 for sonar NMEA input, the unit interface must be set to NMEA In/NMEA Out (see page 65). If connecting to COM1, the unit must be set to NMEA In/NMEA Out.

Appendix H

Wiring and Interfacing

You can download a copy of Garmin's proprietary communication protocol the Help and Support section of our web site at www.garmin.com.

Documentation concerning NMEA &-RTCM formats and sentences are available for purchase from:

National Marine Electronics Association (NMEA)
Seven Riggs Avenue
Severna Park, MD 21146
U.S.A.
410-975-9425
410-975-9450 FAX
www.nmea.org

Radio Technical Commission For Maritime Services (RTCM)
1800 Diagonal Road, Suite 600
Alexandria, VA 22314-2480
U.S.A.
703-684-4481 (Info Only)
703-836-4229 FAX
www.rtcmm.org

Appendix H

Installing and Removing Data Cards

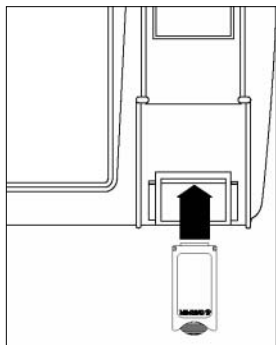

The first time you insert a data card, the unit will take a few seconds to read the card.

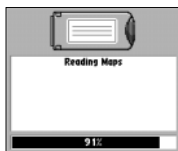

Once the data card has been read, a summary screen will appear. Press **ENTER/MARK** to acknowledge.



Installing and Removing Data Cards

The GPSMAP 182/182C/232 uses optional Garmin marine BlueChart and MapSource data cards to display digital charts and maps on-screen. Data cards are installed in the card slot located at the bottom right of the unit. Data cards may be installed or removed at any time, whether the unit is on or off.

To install a data card:

1. Open the card door by pressing together on the two handles at the bottom of the door and lifting it up and open.
2. Insert the card, with the label facing front and the handle bottom, into the slot.
3. Firmly push the card into the unit. It is not necessary to force the card and about 1/2" will still be exposed when it is properly inserted. If the unit is on, a confirmation tone will sound and a message will display on the screen noting the card details when the card has been properly installed and accepted.
4. Close the cover.

If you insert a data card and get a 'card format not recognized' message, try removing the card and reinserting it. If the card is still not recognized, contact Garmin Support or your Garmin dealer for assistance. Data cards are not waterproof, should not be exposed to moisture or excessive static charges, and should be stored in the case supplied with the card.

To remove a data card:

1. Open the card door by pressing together on the two handles at the bottom of the door and lifting it up and open.
2. Grasp the card handle at the bottom and pull down firmly.
3. If the unit is on, a confirmation tone will sound when the data card has been removed.

Installing the Ferrite Bead Clamp (GPSMAP 182C Only)

In order to filter Radio Frequency Interference (RFI) radiation, which could possibly interfere with items such as televisions, radios, or other marine electronics that are operating in close proximity to the GPSMAP182C with GA 29 remote antenna, a ferrite bead filter clamp and neoprene foam strip are included for attachment to the unit's antenna cable. The clamp attaches to the antenna cable near the point at which it connects to the back of the GPSMAP 182C. The foam strip has adhesive on one side and is used to keep the clamp stationary on the cable.

To install the ferrite bead clamp:

1. Choose a location which is no more than two inches (5 cm) from the back of the GPSMAP 182C.
2. Remove the backing from the adhesive foam strip. Place the strip at an angle to the cable with adhesive facing towards the cable. Snugly spiral wrap the foam strip around the antenna cable. (Fig. 1)
3. Open the filter clamp by slightly pulling on the latch and opening the filter halves.
4. Position the clamp (Fig. 2) and squeeze it shut around the cable until the latch is securely fastened. If the clamp is difficult to close, you may want to remove some of the foam strip.

The clamp should not need to be replaced under normal use. Please contact your Garmin dealer or Garmin Support if you have any questions or require a replacement filter clamp.

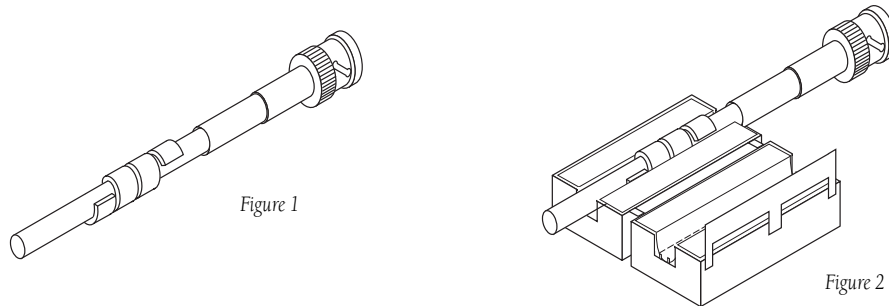
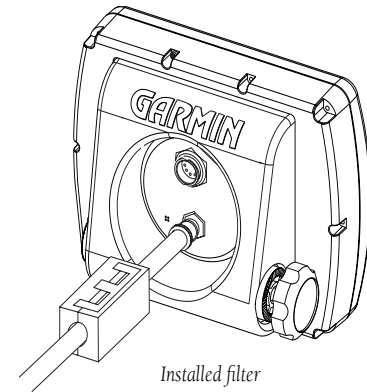
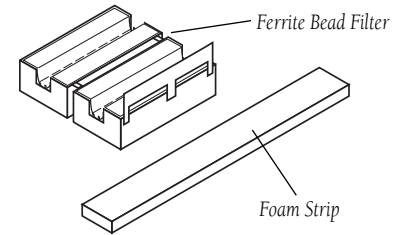

Figure 1

Figure 2

Appendix H

Installing Ferrite Clamp



Appendix I

Index

A

Accuracy	53
Accuracy Circle	26
Active Route Page	16, 29, 48
Active Route Page Options	48
Alarms	67
Anchor Drag Alarm	67
Arrival Alarm	67
ARROW KEYPAD	1

B

Backlighting	6-7
Battery Alarm	67
Bearing Line	26
Bearing/Distance Measuring	23
Beeper	62

C

Capabilities	v
Cautions	iii
Celestial Page Settings	58

90

Changing Data Fields	16, 22-23
Cleaning, Unit	83
Clearing the Track Log	38
Clock Alarm	67
Compass Page	14, 27
Compass Page Options	27
Configuring the Map	24-26
Cursor Movement	9, 19-20

D

Data Card Installation	82
Data Transfer	65
Date/Time	61
Datum, Map	63, 79-80
Daylight Savings Time	61
Deep Water Alarm	67
Depth	3, 22, 31, 33, 63, 65, 67, 87
DGPS Interface Settings	65-66
DGPS Status	54, 66
Differential Receiver Status	54, 66
Dilution Of Precision (DOP)	52-54
Distance, Speed and Elevation	63
DSC	51, 60, 70-75

E

Editing Waypoints	32
ENTER/MARK Key	1, 30

F

Ferrite Clamp Installation	89
Find Function	49
Follow Track	38
Follow Route	12, 43
Fuel Flow	47
Full Screen Map	21

G

GPS Status	5, 52
Go To Waypoint	37-38
Going to a Destination	11, 37

H

Heading	63
Heading Line	26
Hide Numbers	21
Highway Page	15, 28
Highway Page Configuration	29
Highway Page Options	29
How To Enter Data	2, 3
“How To” Index	viii
How To Select Options	2

I

IN Key	1
Initialization	4-5, 52

Appendix I

Index

Power/Backlight/Key	1
Preface	ii
Proximity Waypoints	35-36
Q	
QUIT Key	1
R	
Receiver Status.....	52
Re-evaluate Active Route	48
Registration	ii
Restore Unit Defaults.....	62
Reviewing Waypoints	32
Route List Page	43
Route Review Page	44
Routes	41-47
Routes- Activating	12, 43
Routes- Copying	43
Routes- Creating	41-42
Routes- Deactivating	43
Routes- Deleting	43, 47
Routes- Editing	44-46
Routes- Insert/Add Turns & Points	45-46

Installation	84-89
Interface Formats	65
Interfacing	65, 87
J	
Jump To Page	61
K	
Keypad Usage	1
L	
Land Mode	24
Language Selection	62
Light Sectors.....	26
Local Time Offset	61, 76
Loran TD	68-69
Loran TD Setup	69
M	
Main Menu	51-57
Main Menu Page	51
Map Configuration	24-26
Map Datums	63, 79-80
Map Page	8-9, 18-27
Map Page Layout	22-23
Map Page Options	21
Map Scales	20
Map, Zooming	9, 20
Measure Distance/Bearing.....	23
MENU Key	1

Messages	77-78
MMSI Number	70-75
MOB Key	40
Moonrise/Moonset	58
N	
NAV Key	1, 12, 37-41, 43
Navaid Symbols.....	25-26
Navigation Terms	81-82
Nearest To Boat	50, 56-57, 59
Nearest To Destination	50, 56-57, 59
Nearest To Next	50, 56-57, 59
Nearest To Other	50, 56-57, 59
NMEA Output Formats	65, 87
O	
Odometers, Trip	58
Off Course Alarm	67
OUT Key	1
Overzoom	20
P	
Packing List	vi
PAGE Key	1
Pages Menu	61
Position Format	63
Power Off	17
Power On	4, 6

Appendix I

Index

Routes- Inverting	43, 48
Routes- Naming	44
Routes- Trip Planning	47
Routes- Remove Points	45-46
Routes- Reviewing Points	43-45

S

Satellite Sky View	5, 52
Serial Data Format	65
Serial Number	iv
Shallow Water Alarm	67
Show Numbers	21
Signal Strength Bars	5, 52
Simulator	7, 62
Simulator Speed	62
Software Version	62
Sonar Page	8
Sonar Setup	51
Specifications	83
Speed, Distance and Elevation	63
Speed Filter	59
Storage	83
Sunrise/Sunset	48, 58, 68

92

Symbols, Waypoint	10, 13, 30-34
System Mode	62

T

Table of Contents	vii
Temperature	23, 51, 63
Tide Charts	56-57
Tide Page Settings	56-57
Time Format	61
Time Offsets	61, 70
Time Zone	61
Time, Daylight Savings	61
Timers, Trip	58
TracBack	38-39, 59
Track Log- Clearing	38, 60
Track Log- Deleting	60
Track Log- Displaying	26, 29, 60
Track Log- Saving	38, 60
Track Log- Showing on Map	26, 39, 60
TrackLog-Style	39

Track Setup	59-60
Trip and Fuel Planning	47
Trip Odometers	58
Trip Timers	58

U

Units Setting	63
---------------------	----

Units Care	83
User Datum	79

W

WAAS	v, 53-55, 65
Warnings	iii
Warranty	iv
Water Mode	24
Waypoint Lists	32-36
Waypoint Options	34-35
Waypoints- Creating	10, 13, 19, 20, 30-31
Waypoints- Deleting	33-34
Waypoints- Editing	33-35
Waypoints- Manually Entered	30-31
Waypoints- Moving	33
Waypoints- Naming	32
Waypoints- Nearest	35, 37, 42-43, 47, 59
Waypoints- Proximity	35-36
Waypoints- Reviewing	13, 32
Welcome Page	ii
Wiring Installation	87

Z

Zooming	9, 15, 18, 20, 28
Zoom In Key	1
Zoom Out Key	1

**For the latest free software updates (excluding map data)
throughout the life of your Garmin products, visit the
Garmin web site at www.garmin.com**



© 2003 Garmin Ltd. or its subsidiaries

Garmin International, Inc.
1200 East 151st Street, Olathe, Kansas 66062, U.S.A.

Garmin (Europe) Ltd.
Unit 5, The Quadrangle, Abbey Park Industrial Estate, Romsey, SO51 9DL, U.K.

Garmin Corporation
No. 68, Jangshu 2nd Road, Shijr, Taipei County, Taiwan

www.garmin.com

Part Number 190-00215-10 Rev. A

Free Manuals Download Website

<http://myh66.com>

<http://usermanuals.us>

<http://www.somanuals.com>

<http://www.4manuals.cc>

<http://www.manual-lib.com>

<http://www.404manual.com>

<http://www.luxmanual.com>

<http://aubethermostatmanual.com>

Golf course search by state

<http://golfingnear.com>

Email search by domain

<http://emailbydomain.com>

Auto manuals search

<http://auto.somanuals.com>

TV manuals search

<http://tv.somanuals.com>