

# GPSMAP® 198C Sounder

*chartplotting receiver*

*owner's manual*



© Copyright 2005 Garmin Ltd. or its subsidiaries

Garmin International, Inc.  
1200 East 151<sup>st</sup> Street,  
Olathe, Kansas 66062, U.S.A.  
Tel. 913/397.8200 or 800/800.1020  
Fax 913/397.8282

Garmin (Europe) Ltd.  
Unit 5, The Quadrangle,  
Abbey Park Industrial Estate,  
Romsey, SO51 9DL, U.K.  
Tel. 44/0870.8501241  
Fax 44/0870.8501251

Garmin Corporation  
No. 68, Jangshu 2<sup>nd</sup> Road, Shijr,  
Taipei County, Taiwan  
Tel. 886/2.2642.9199  
Fax 886/2.2642.9099

All rights reserved. Except as expressly provided herein, no part of this manual may be reproduced, copied, transmitted, disseminated, downloaded or stored in any storage medium, for any purpose without the express prior written consent of Garmin. Garmin hereby grants permission to download a single copy of this manual onto a hard drive or other electronic storage medium to be viewed and to print one copy of this manual or of any revision hereto, provided that such electronic or printed copy of this manual must contain the complete text of this copyright notice and provided further that any unauthorized commercial distribution of this manual or any revision hereto is strictly prohibited.

Information in this document is subject to change without notice. Garmin reserves the right to change or improve its products and to make changes in the content without obligation to notify any person or organization of such changes or improvements. Visit the Garmin Web site ([www.garmin.com](http://www.garmin.com)) for current updates and supplemental information concerning the use and operation of this and other Garmin products.

Garmin<sup>®</sup>, GPSMAP<sup>®</sup>, AutoLocate<sup>®</sup>, TracBack<sup>®</sup>, BlueChart<sup>®</sup>, and MapSource<sup>®</sup> are registered trademarks of Garmin Ltd. or its subsidiaries and may not be used without the express permission of Garmin.

## INTRODUCTION

Thank you for choosing the Garmin® GPSMAP® 198C Sounder. The GPSMAP 198C Sounder utilizes the proven performance of Garmin GPS and full-featured mapping to create an unsurpassed portable GPS receiver. Take a moment now to compare the contents of this package with the packing list on the outside of the box. If any pieces are missing, contact your Garmin dealer immediately.

Before you begin working with the GPSMAP 198C Sounder, review the installation instructions listed in the Appendix. If you have any question about installing your chartplotter, contact Garmin Product Support or a professional installer.

The GPSMAP 198C Sounder Quick Reference Guide contains helpful tips on using the unit and performing various navigation tasks. It's a good idea to keep the Quick Reference Guide nearby whenever you are operating your new GPSMAP 198C Sounder.

## About This Manual

To get the most out of your new navigation system, take time to read this manual and learn the operating procedures for your unit in detail. This manual is organized into the following chapters.

The **Introduction** section contains the Table of Contents as well as GPSMAP 198C Sounder care information.

The **Basic Operation** section provides you with detailed information and step-by-step directions for features such as using the Find Menu, navigating a route, and using waypoints.

The **Main Pages** section provides detailed explanations about each page in the GPSMAP 198C Sounder and step-by-step directions on using the pages.

The **Main Menu** section provides detailed explanations about the Main Menu and how to use it to configure your unit.

The **Appendix** contains installation instructions, specifications, optional accessories, and maintenance information. You can also find warranty and FCC information in the Appendix. **Read the Safety Information to learn how to install and use your Garmin GPSMAP 198C Sounder safely and responsibly.**

An **Index** is provided at the end of the manual for reference.

## Table of Contents

Introduction.....	i
About This Manual .....	i
Warning .....	iv
Caution .....	iv
Basic Operation.....	1
Initializing the Receiver .....	1
Simulator Mode .....	3
Adjusting the Backlight .....	4
Interface Keys.....	5
Entering Data and Selecting Options .....	6
Using the Map Pointer .....	7
Creating and Using Waypoints .....	8
Man OverBoard (MOB).....	10
Reviewing and Editing Waypoints .....	11
Navigating to a Destination .....	12
Routes .....	17
Find .....	19
Additional Information .....	21
DSC.....	22
Main Pages.....	26
Map Page.....	27
Compass Page.....	33
Numbers Page .....	34
Highway Page.....	35
Active Route Page.....	37

Main Menu.....	39
GPS Tab.....	39
Tide Tab.....	43
Trip Tab.....	46
Celes (Celestial) Tab .....	47
Points Tab .....	48
Routes Tab .....	53
Track Tab.....	59
DSC Tab.....	61
Card Tab.....	62
Time Tab.....	62
Pages Tab.....	63
Map Tab .....	64
Hiway (Highway) Tab.....	68
Temp (Temperature) Tab .....	68
Sonar Tab .....	68
System (System) Tab .....	69
Units Tab .....	70
Comm (Communications) Tab .....	72
Alarm Tab.....	76
Using Sonar .....	78
Sonar Page.....	78
Sonar Tab Options .....	85
Understanding Sonar.....	89

**Appendix .....92**  
    **Specifications ..... 92**  
    **Installing the GPSMAP 198C Sounder ..... 93**  
    **Mounting the GPSMAP 198C Sounder ..... 94**  
    **Installing the Transducer ..... 96**  
    **Care Information..... 98**  
    **Connecting the Power/Data Cable ..... 99**  
    **Interfacing ..... 100**  
    **Installing and Removing Data Cards ..... 101**  
    **Satellite Information ..... 102**  
    **What is WAAS?..... 103**  
    **What is Differential GPS (DGPS)? ..... 103**  
    **What is a Maritime Mobile Service Identity (MMSI)? ..... 104**  
    **How ARE MMSI assignments obtained?..... 104**  
    **Navigation Terms ..... 105**  
    **Messages ..... 107**  
    **LORAN TD System ..... 109**  
    **Optional Accessories ..... 111**  
    **Software License Agreement ..... 112**  
    **Product Registration ..... 112**  
    **Limited Warranty ..... 113**  
    **FCC Compliance..... 114**  
**Index ..... 115**

 **Warning**

**Failure to avoid the following potentially hazardous situations could result in an accident or collision resulting in death or serious injury.**

When navigating, carefully compare information displayed on the GPSMAP 198C Sounder to all available navigation sources, including information from visual sightings, and maps. For safety, always resolve any discrepancies or questions before continuing navigation.

Use the electronic chart in the GPSMAP 198C Sounder only to facilitate, not to replace, the use of authorized government charts. Official government charts and notices to mariners contain all information needed to navigate safely.

**WARNING:** This product, its packaging, and its components contain chemicals known to the State of California to cause cancer, birth defects, or reproductive harm. This Notice is being provided in accordance with California's Proposition 65. If you have any questions or would like additional information, please refer to our Web site at <http://www.garmin.com/prop65>.

 **Caution**

**Failure to avoid the following potentially hazardous situations may result in injury or property damage.**

Use the GPSMAP 198C Sounder only as a navigational aid. Do not attempt to use the GPSMAP 198C Sounder for any purpose requiring precise measurement of direction, distance, location, or topography. The Global Positioning System (GPS) is operated by the United States

government, which is solely responsible for its accuracy and maintenance. The government's system is subject to changes which could affect the accuracy and performance of all GPS equipment, including the GPSMAP 198C Sounder. Although the GPSMAP 198C Sounder is a precision navigation device, any navigation device can be misused or misinterpreted and, therefore, become unsafe.

**Map Data Information:** One of the goals of Garmin is to provide customers with the most complete and accurate cartography that is available to us at a reasonable cost. We use a combination of governmental and private data sources, which we identify in product literature and copyright messages displayed to the consumer. Virtually all data sources contain inaccurate or incomplete data to some extent. This is particularly true outside the United States, where complete and accurate digital data is either not available or prohibitively expensive.

## BASIC OPERATION

### Initializing the Receiver

The first time you turn on the GPSMAP 198C Sounder, the receiver must be given an opportunity to collect satellite data and establish its present location. To ensure proper initialization, the GPSMAP 198C Sounder is shipped from the factory in AutoLocate Mode.

Before you initialize, make sure the GPSMAP 198C Sounder unit and antenna are correctly installed on your vessel according to the instructions in the “Appendix.” Install the antenna in a location with a clear and unobstructed view of the sky.

A full-screen GPS Information Page is shown after you press **ENTER** to acknowledge the Warning Page. The page goes away after the unit gets a position fix or you press either **ENTER** or **QUIT**. The page can be disabled and enabled on the Main Menu—Pages tab (see [page 63](#)).

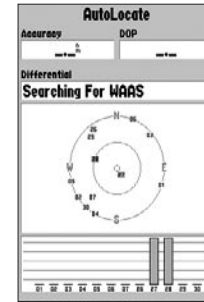

#### To turn on the GPSMAP 198C Sounder:

1. Press and hold the **POWER** key until the power tone sounds, then release the **POWER** key. The Warning Page appears while the unit conducts a self-test.
2. When the self-test is complete, press **ENTER** to agree and acknowledge the warning.

The GPS Information Page appears as the receiver begins acquiring satellites.

#### To turn off the GPSMAP 198C Sounder:

1. Press and hold the **POWER** key for about two seconds, until the screen is blank.
2. When the screen is blank, release the **POWER** key.

## To graphically initialize the GPSMAP 198C Sounder:

1. Press **MENU** twice for the Main Menu. Press up or down on the **ROCKER** until the **GPS** tab is highlighted, and then press **MENU** once.
2. Using the **ROCKER**, highlight **Initialize Position**, and press **ENTER**. The Initialize Position Page appears, prompting you to select your approximate location with the map pointer.
3. Use the **ROCKER** to move the map pointer to your approximate location within 200 miles. If you have difficulty identifying your location, press and release the **IN** key to see the next lower map range.
4. After you have determined your approximate location on the map, press **ENTER**.



***NOTE:** This does not calibrate the unit in any way, but rather helps to speed up the initial satellite acquisition. If the unit shows “Ready 2D or 3D” during this process, it is not necessary to initialize the unit.*



The unit now begins searching for the appropriate satellites for your region and should acquire a fix within a few minutes. When viewing the GPS tab on the Main Menu, a signal strength bar for each satellite in view appears on the bottom of the page, with the appropriate satellite number under each bar.

- **No signal strength bars**—the receiver is looking for the satellites indicated.
- **Hollow signal strength bars**—the receiver has found the indicated satellite(s) and is collecting data.
- **Solid signal strength bars**—the receiver is ready to use.

When the receiver has collected information from at least three satellites, the top of the screen shows either “Ready 2D or 3D”, and the GPSMAP 198C Sounder is ready for use.



## Simulator Mode

Simulator Mode turns the GPS receiver off for use indoors or practice. Any of the functions discussed in the following pages can be performed in Simulator Mode. While in Simulator Mode, a “Running Simulator” message appears after 2 minutes of inactivity. Keep in mind that the GPSMAP 198C Sounder does not track satellites in Simulator Mode, and this mode should never be used for actual navigation. All the waypoint and route planning completed in Simulator Mode is retained in memory for future use.



**WARNING:** Do not attempt to navigate using Simulator Mode. When the unit is set to Simulator Mode, the GPS receiver is turned off. Any satellite signal strength bars shown are only simulations and do not represent the strength of actual satellite signals.

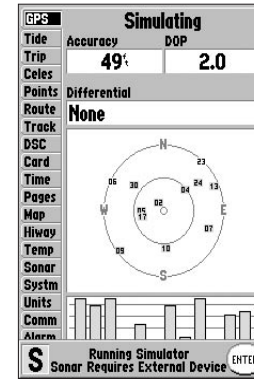

### To place the GPSMAP 198C Sounder in Simulator Mode:

1. Press **MENU** twice to show the Main Menu. Press up or down on the **ROCKER** until the **GPS** tab is highlighted, and then press **MENU** once.
2. Use the **ROCKER** to highlight **Start Simulator**, and press **ENTER**. Choose **No** to the retail demonstration, and press **ENTER**.
3. Press **ENTER** to confirm the **Running Simulator** message that appears at the bottom of the screen. “Simulating” appears at the top of each of the Main Pages.
4. To turn off the Simulator Mode, press **MENU**, and select **Stop Simulator**.

The Set Position, Track Control, Track and Speed fields only show while in Simulator Mode.

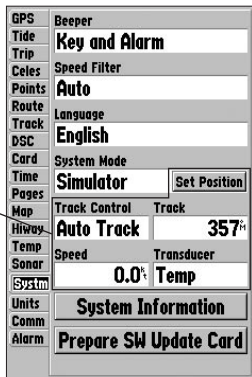

### To enter a simulated speed and heading from the Main Menu:

1. Press **MENU** twice to show the **Main Menu**.
2. Use the **ROCKER** to highlight the **System** tab, press right then down until the field below the word **Speed** is highlighted, then press **ENTER**.
3. Use the **ROCKER** to enter a speed, and press **ENTER**.
4. Use the **ROCKER** to highlight **Track Control**. Press **ENTER**, and select a heading.
5. Press **ENTER** to finish, and **QUIT** until you return to the Map Page.

### To adjust the simulated speed and heading from the Compass or Highway Pages:

1. Press up on the **ROCKER** increase the speed in 10 knot/kph/mph increments. Press down on the **ROCKER** to decrease the speed in the same increments.
2. Press left and right on the **ROCKER** to steer the boat.

## Adjusting the Backlight

The Sounder's adjustable screen backlighting is controlled with the **POWER** key, and can be adjusted from any page.



### To adjust the backlighting:

1. Press and release the **POWER** key. The adjustment slider window appears.
2. Press the **POWER** key again and the user-defined level of backlighting starts. You can adjust this level by pressing up or down on the **ROCKER**. If you press **POWER** one more time, the backlight is at the maximum setting.
3. Press **ENTER** or **QUIT** when finished.

## Interface Keys

### POWER Key

- Press and hold to turn the unit on or off.
- Press and release to adjust backlighting.

### PAGE Key

- Press to cycle through the main pages.
- Press to end an operation in progress and return to the main page.

### QUIT Key

- Press and release to cancel data entry or exit a page.

### ENTER/MARK Key

- Press and release to enter highlighted options and data or confirm on-screen messages.
- Press and hold at any time to mark your current location as a waypoint.

### MOB Key

- Press and hold for MOB waypoint.



### IN/OUT Zoom Keys

- From the Map Page, press to zoom in or out.
- From any other page, press to scroll up or down a list.

### ROCKER Key

- Move up, down, right or left to move through lists, highlight fields, on-screen buttons and icons, enter data, or move the map pointer.

### MENU Key

- Press and release to view options for a page.
- Press twice to view the Main Menu.

### NAV Key

- Press and release at any time to view the Navigation Menu.

### FIND Key

- Press to search for points such as user waypoints, cities, and services.

## Entering Data and Selecting Options

You can select and start options, and enter data to customize the GPSMAP 198C Sounder to fit your requirements. Use the **ENTER** key and the **ROCKER** to select options, enter names and numbers in data fields, and start your selections.

### To select an optional feature:

1. With any page shown, press **MENU** to show the options menu. The options menu shows a list of optional features that are specific for that page. To select an option requires movement of the cursor. This is referred to as highlighting, selecting, or choosing an item.
2. Use the **ROCKER** to move the cursor (highlight) up and down a list or up, down, left, and right on menus.
3. After you have highlighted a selection, press **ENTER** to either start the feature or press **MENU** to show a sub-menu or list with more options. Repeat this process to select an option from the list, or press **QUIT** to return to the previous setting.

### To select an on-screen button:

Some pages contain on-screen buttons. As shown below, the New Waypoint Page has three buttons: **Map**, **Delete**, and **OK**. To start, highlight the a button, and press **ENTER**.

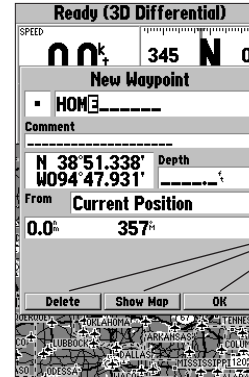

On-Screen Buttons

## Using the Map Pointer

Working from the Map Page centers around the use of the pointer. Controlled by the **ROCKER**, the pointer is used to pan to map locations, mark and edit waypoints and routes, and review position data of on-screen map items and waypoints. When you move the pointer over a map item, a highlighted description of that item appears.

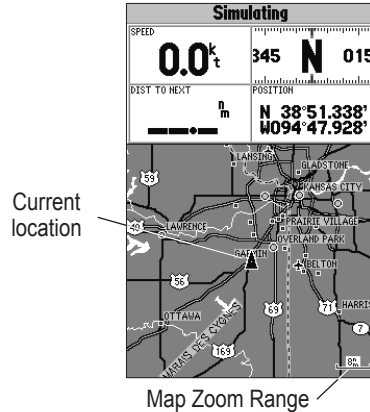

### To pan the map:

1. Use the **IN/OUT** keys to select a map zoom range.
2. Use the **ROCKER** to move the pointer. A data field appears at the top of the screen showing the bearing and distance from your boat to the pointer, along with the latitude/longitude of the pointer.
3. Press **QUIT** to re-center your boat on the Map Page.

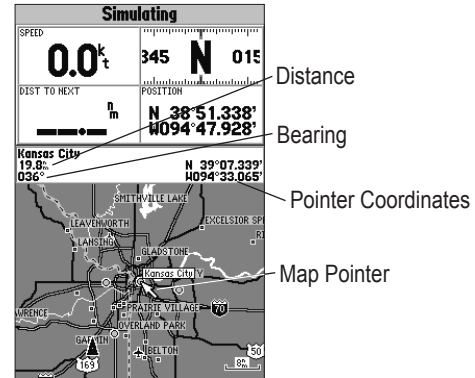

The Map Page actively scrolls or pans enabling you to explore areas around the world and create waypoints and routes. Pressing **QUIT** returns the map to your present location.



**NOTE:** When the pointer reaches the edge of the map, the unit can pause as it loads new map data.

## Creating and Using Waypoints

The Garmin GPSMAP 198C Sounder stores up to 3,000 alphanumeric waypoints with a user-defined symbol, comments, and depth available for each waypoint. Waypoints can be created using two basic methods:

**ENTER/MARK Key**—marks your present location, and provides options to select a map position or map item from the Map Page. Also, you can enter a new waypoint's location coordinates manually.

**Graphically**—defines a new waypoint location from the Map Page using the **ROCKER**.

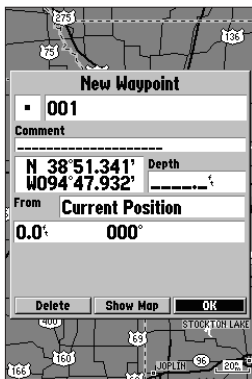

## ENTER/MARK Key

The GPSMAP 198C Sounder's **ENTER/MARK** key quickly captures your present location to create a new waypoint. The unit must have a valid position (2D or 3D) fix to mark your present location. You can also use this option to manually enter waypoint coordinates.

### To mark your present position:

1. Press and hold **ENTER/MARK** until the **New Waypoint** window appears. A default three-digit name and symbol are created for the new waypoint.
2. To accept the waypoint with the default name and symbol, highlight **OK**, and press **ENTER/MARK**.
3. To enter a different name, highlight the name field, and press **ENTER/MARK**. Use the **ROCKER** to enter the new letter/numbers, and press **ENTER/MARK** when finished. You can use up to 10 characters for the name.
4. To select a different symbol, highlight the symbol field to the left of the name, and press **ENTER/MARK**. Use the **ROCKER** to highlight the new symbol, and press **ENTER/MARK**.

5. To enter optional comments or a depth, highlight the **Comments** or **Depth** field to the right of the location coordinates, and press **ENTER/MARK**, use the **ROCKER** to enter a value, and press **ENTER/MARK**.
6. To manually enter a set of coordinates, highlight the coordinates, and press **ENTER/MARK**, use the **ROCKER** to enter the new coordinates, and press **ENTER/MARK** when finished.
7. Use the **ROCKER** to highlight **OK**. When finished, press **ENTER/MARK** to save the waypoint into memory.

### Creating Waypoints Graphically

You create waypoints graphically from the Map Page. To mark a map location or map item, select the location or item with the pointer, and press **ENTER**. When selecting a location or map item, a description of the point, its distance and bearing from your current location, and the latitude/longitude of the pointer is shown along the top of the map.

### To create a new waypoint graphically:

1. Use the **ROCKER** to move the pointer to a map location. If you want to create the new waypoint at an on-screen map item, highlight the map item on the screen.
2. Press and release **ENTER/MARK** to capture the pointer location. Do not hold the button down, doing so marks your present location, not the map location.  
If you are not using a map item to create a waypoint, go to step 4.
3. Highlight **Create Wpt** or **OK**, and press **ENTER/MARK**.
4. To accept the waypoint with the default name and symbol, press **ENTER/MARK**.
5. To change the name, symbol, or add a comment or depth, highlight the appropriate field, and press **ENTER/MARK**. Make your changes, and press **ENTER/MARK** when finished.
6. Move the highlight back to **OK**, and press **ENTER/MARK** to confirm the changes.

## Man OverBoard (MOB)

The GPSMAP 198C Sounder's Man OverBoard function (MOB) simultaneously mark and set a course back to the marked location for quick response to emergency situations.

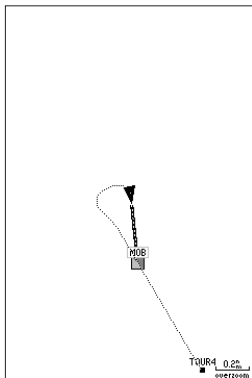

The MOB function allows you to quickly start navigation back to a location.

### To start the MOB function:

1. Press **MOB**.
2. Press **ENTER** to begin navigating to the **MOB** location.
3. To stop navigation to the **MOB** location, press **NAV**, highlight **Stop Navigation**, and press **ENTER**.

When a MOB is active, a MOB waypoint with an international MOB symbol is created and the unit is on an active navigation to that point. Use any of the Navigation Pages to guide you back to the MOB point. The MOB waypoint is stored in the waypoint list and works like any other waypoint.

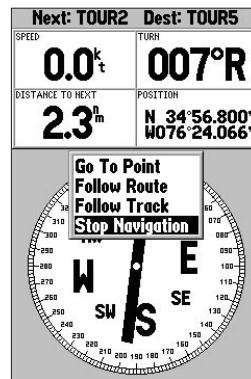

To stop navigation, highlight **Stop Navigation**, and press **ENTER**.



## Reviewing and Editing Waypoints

Waypoints are reviewed, modified, renamed, moved, or deleted at any time through the Waypoint Edit Page. The Waypoint Edit Page is available for any stored waypoint. Select the waypoint on the map or from the waypoint lists in the Main Menu—Points tab.

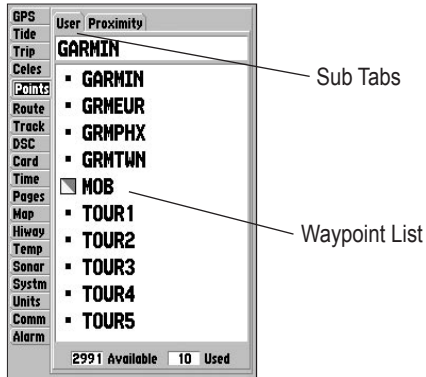

### To access the Waypoint Edit Page:

1. Use the **ROCKER** to highlight the waypoint on the Map Page.  
Or  
Press **MENU** twice, highlight the **Points** tab, and choose a waypoint from the **User** or **Proximity** sub tabs.
2. Press **ENTER** to show the Waypoint Edit Page.

3. From the Waypoint Edit Page, change the name, symbol, comment, location coordinates, or depth for the selected waypoint. When finished, highlight **Next**, and press **ENTER** to save them or press **QUIT**.

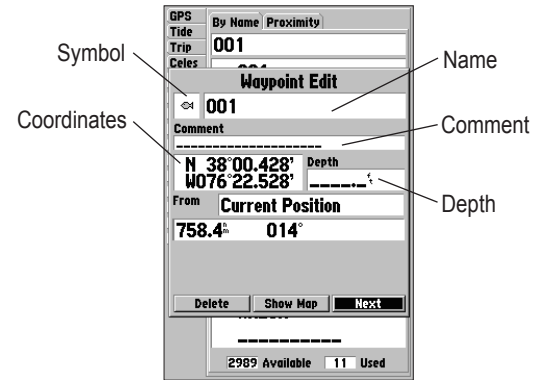

Waypoint Edit Page

### To change the waypoint name:

1. Highlight the waypoint name field, and press **ENTER**.
2. Use the **ROCKER** to enter a new name, and press **ENTER** when finished.

**To change the waypoint symbol:**

1. Highlight the waypoint symbol field to the left of the waypoint name, and press **ENTER**.
2. Use the **ROCKER** to select a new symbol, and press **ENTER**.

**To change the Comment, Location, Coordinates, or Depth:**

1. Highlight a field, and press **ENTER**.
2. Use the **ROCKER** to edit or enter the data. To move to the next line, press right on the **ROCKER**.
3. Press **ENTER** when finished.

**To move the waypoint on the map:**

1. From the Waypoint Edit Page, highlight **Show Map**, and press **ENTER**. Highlight the waypoint, and press **ENTER**. A **MOVE** label now appears under the pointer arrow in addition to a distance, bearing, and coordinate window. You can also use the **IN** and **OUT** keys to zoom the map. The map zoom range appears in the lower right corner.
2. Use the **ROCKER** to point to the new location, and press **ENTER**.
3. To stop the move process, press **QUIT**.

**Navigating to a Destination****Using the Nav Key**

The **NAV** key provides three ways to navigate to a destination: Go To Point, Follow Route, and Follow Track (TracBack). When you are actively navigating, the Map Page shows a straight line from your current location to the destination. The Go To option is the easiest method for selecting a destination. A Go To allows you to select a destination point and quickly set a direct course from your present location. If you have a point highlighted on a list or the map, **Go To <point name>** appears in addition to **Go To Point**. The Go To function is accessed from any list of points or graphically from the Map Page.

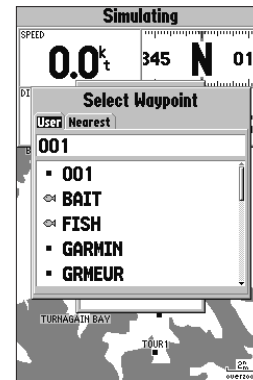

### To start a Go To from a point list:

1. Press **NAV**. Highlight **Go To Point**, and press **ENTER**.
2. From the **Find** menu, highlight **Waypoints** or another menu option, and press **ENTER**.
3. To select a waypoint from the waypoint lists, use the **ROCKER** to highlight either the **By Name** or **Nearest** tab, select a waypoint, and press **ENTER**.

Or

Select a waypoint from the map, highlight either the **User** or **Nearest** tab, and press **MENU**. With **Select From Map** highlighted, press **ENTER**. Use the zoom **IN** and **OUT** keys and the **ROCKER** to select a waypoint, and press **ENTER**.

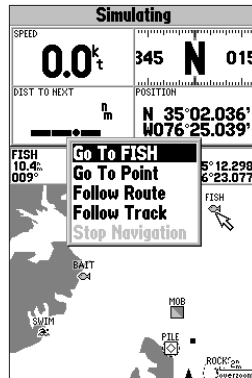

### Selecting a Go To Graphically

A graphical Go To can be used to select one of three items from the Map Page: an existing waypoint, an on-screen map item such as roads, rivers, cities, and nav aids, or a new map point. If you are selecting a map item as the Go To destination, the GPSMAP 198C Sounder automatically uses the name of the map item, but the point is not stored in the waypoint list. See page 21 for creating waypoints using map items. If you are selecting a new map point (non-map item) as the Go To destination, the GPSMAP 198C Sounder automatically creates a waypoint at the pointer location.

### To start an existing waypoint or map item as a Go To from the Map Page:

1. Use the **ROCKER** to highlight the waypoint or on-screen map item, and press **NAV**. **Go To <waypoint name>** appears, then press **ENTER**.  
Or  
Highlight the waypoint or map item, and press **ENTER**.
2. Highlight the **Go To** button at the bottom of the window, and press **ENTER**.

### To Go To a new map point (non-map item):

1. Use the **ROCKER** to move the map pointer to the location.
2. Press **NAV**.
3. With **Go To MAP Point** highlighted, press **ENTER**.



### TracBack Navigation (Navigating a Track)

The TracBack function retraces your path using the track log automatically stored in the receiver's memory. This feature eliminates the need to store waypoints along the way. TracBack routes are created by reducing your track log into a route of up to 254 turns and activating an inverted route along those points. When started, a TracBack route leads you back to the oldest stored track log point, so it is a good idea to clear the existing track log before you start your current trip.

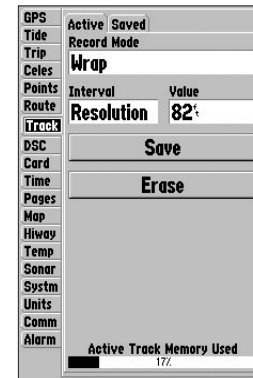
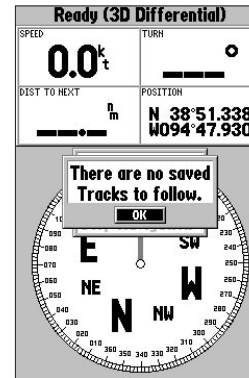

You must save a track before using the **Follow Track** option.

### To clear the track log and define a starting point for a TracBack route:

1. Press **MENU** twice to show the Main Menu.
2. Using the **ROCKER**, highlight the **Track** tab, then highlight the **Active** sub tab.
3. Use the **ROCKER** to select the **Erase** button, and press **ENTER**.
4. Highlight the **OK**, and press **ENTER**.

You must save the track log before you can use **Follow Track**. The Save feature stores up to 15 track logs.

### To save a track log:

1. From the Main Menu, use the **ROCKER** to highlight the **Track** tab, then highlight the **Active** sub tab to the right.
2. Use the **ROCKER** to select **Save**, and press **ENTER**.
3. From the **Save Back Through** window, highlight time, date, or Entire Log, and press **ENTER**. When the track is saved, the **Save Track** window appears. The default name, distance, number of points (500 max), and color are shown in the **Save Track** window.

To change the name of the saved track, highlight the name field, and press **ENTER**. Make your changes and press **ENTER**.

To show the track on the Map and Highway Pages, highlight the check box to the left of **Show on Map and Highway**, and press **ENTER**.

To view the track on the map, highlight Review on Map, and press **ENTER**.

4. Highlight **OK**, and press **ENTER** to save the track. Press **QUIT** to exit.

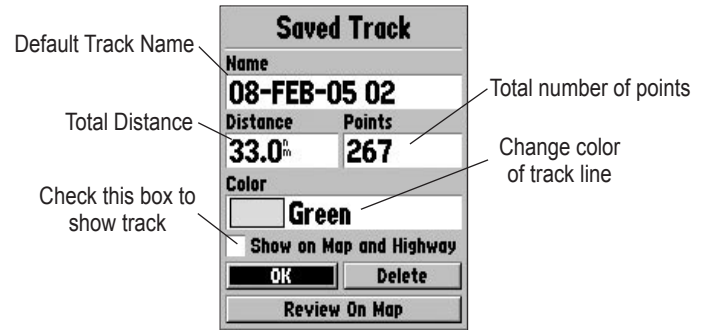

**To start a TracBack using the NAV key:**

1. Press **NAV**, highlight the **Follow Track**, and press **ENTER**.
2. Highlight the track you want to follow, and press **ENTER**.
3. Choose **Original** to navigate from the start to the end of your trip, or **Reverse** to navigate from the end to the start of your trip, and press **ENTER**.
4. To stop TracBack navigation, press **NAV**, highlight **Stop Navigation**, and press **ENTER**.

When a TracBack is active, the GPSMAP 198C Sounder takes the track log currently stored in memory and divides it into segments called legs. Up to 254 temporary turns (BEGIN, TURN 1, TURN 2, TURN 3,....., TURN X, END) are created to mark the most significant features of the track log in order to duplicate your exact path as closely as possible. To get the most out of the TracBack feature, remember the following tips:

- Always clear the track log at the starting point.
- Set the Record Mode option on the track log setup page to Fill or Wrap.
- The track log memory must contain at least two points to create a TracBack route.

- If the track log interval is set to the Time option, the route can not follow your exact path. For best performance, keep the interval set to resolution.
- If the receiver is turned off or satellite coverage is lost during your trip, the TracBack draws a straight line between any point where coverage was lost and where it resumed.
- If the track log's changes in distance and direction are too complex, 254 waypoints can not mark your path accurately. The receiver then assigns the 254 waypoints to the most significant points of your track, and simplifies segments with fewer changes in direction.

For more information on setting up the Track options and saved tracks, see [pages 59](#).

## Routes

You can create and store up to 50 user-defined reversible routes (numbered 1-50), with up to 254 waypoints each. Routes are created and modified in two ways. The first method creates the route using a Map Page. This method selects points on the map. The second method enters the waypoint names as text on the Route Review Page. This method lists the waypoints as you create the route. All of the route functions are accessed through the Main Menu or the NAV key.

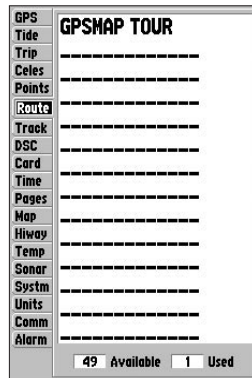

Route Tab

### To create a route using the Route Edit Map Page:

1. Press **MENU** twice to show the Main Menu.
2. Use the **ROCKER** to highlight the **Route** tab, and press **MENU** to show the route options page, or highlight the first available blank route slot, and press **ENTER**. (Skip to step 4 if you use this method.)
3. Select **New Route**, and press **ENTER**.
4. To add an existing waypoint or map item to the route, use the map pointer to select a waypoint or map item, and press **ENTER**. Map items do not appear in the waypoint list. To create a waypoint from a map item, see [page 21](#).
5. To add a new waypoint to the route, use the map pointer to select a map location, and press **ENTER**. Press **ENTER** again to confirm the new waypoint. You can also change the name and symbol of the new waypoint (see [page 8](#)).

As you add each new waypoint to the route, the data window at the top of the Map Page shows the waypoint/map item name, bearing and distance from your location, and coordinates of the pointer. The bottom of the screen shows the number of available and used points. A route line appears on the map to indicate each completed leg, and a dotted line appears indicating the distance and bearing to the arrow pointer from the last route waypoint.

6. Repeat steps 4 and 5 until you have finished defining all route waypoints.
7. When finished, press **QUIT** twice to return to the **Route List** Page. Highlight **Edit as Text**, and press **ENTER** to return to the **Route Review** Page.

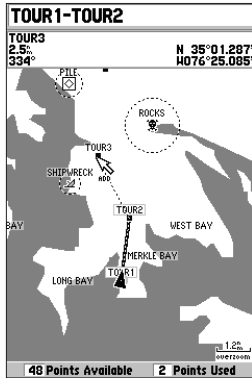

**ADD** appears below the pointer as you insert points.

### To create a route using text on the Route Review Page:

1. Press **MENU** twice to show the Main Menu.
2. Use the **ROCKER** to highlight the **Route** tab, and press **MENU** to show the route options menu, or highlight the first available blank route slot, and press **ENTER**. (Skip to step 4 if you use this method.)
3. Select **New Route**, and press **ENTER**.
4. Press **MENU**, select **Edit as Text**, and press **ENTER**.
5. Use the **ROCKER** to highlight the first field under the word **Waypoint**, and press **ENTER**.

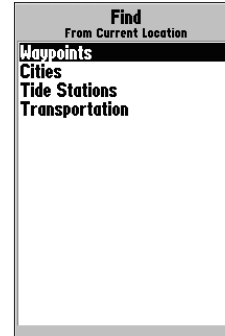

Choose the category you want to add a route point from.



6. From the **Find** menu, highlight **Waypoints** or another menu item, and press **ENTER**. From either the **By Name** or **Nearest** tab lists, choose a waypoint, and press **ENTER**. (See [page 50](#) for searching for waypoints by name.)
7. From the Waypoint Review Page, **OK** is automatically highlighted. You can use **Show Map** to view a point on the map. When finished viewing, then press **QUIT** to return to the Waypoint Review Page. Press **ENTER** to add the point to the route. The next field automatically highlights.
8. Repeat steps 5-7 until all the route points have been entered. Press **QUIT** to return to the Route List Page.

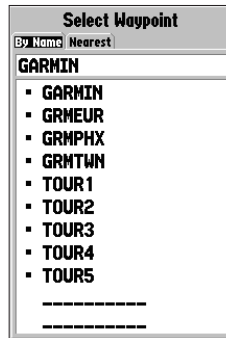

Choose a waypoint from either the **By Name** or **Nearest** tab list.

## Find

The **FIND** key searches the unit for user waypoints, map items, and any optional BlueChart or MapSource information loaded on a data card. Press **FIND** to show a list of available find categories. The default items are Waypoints, Cities, Tide Stations, and Transportation. Additional items, such as Anchorages, Businesses, Exits, Nav aids, Restricted Areas, and Wrecks Obstructions, appear if an optional BlueChart data card inserted into the unit. If you press **FIND** and are in Pan Mode, the unit centers its search from the location where the map pointer is located. Your location or the map pointer must be within a map outline area to search for BlueChart information.

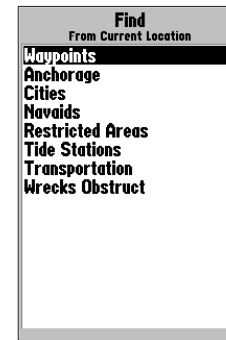

Find Items List

**To Find an item from your current location:**

1. From any page, press **FIND**.
2. Using the **ROCKER**, highlight a category from the list, and press **ENTER**.
3. For Waypoints and Cities, search using **By Name** or **Nearest**. Use the **ROCKER** to highlight a tab. For **By Name**, use the top field to spell out the name, or scroll down through the list. (See [page 8](#) for steps on entering a name.)

**To Find an item from other locations:**

1. From the **Map** Page, use the **ROCKER** to pan select a location, and press **FIND**.
2. Using the **ROCKER**, highlight a category from the list, and press **ENTER**.

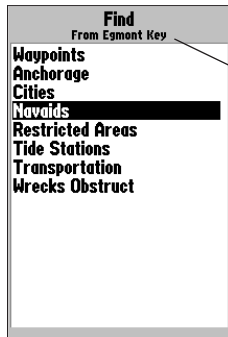

You can also Find from items found on the Find List.

The Find option also supports a “find from” feature that centers your search around an item you have just found. For example, you search for “Restricted Areas” and you find a point named “Anchoring Prohibited.” If you press **FIND** again, “From Anchoring Prohibited” appears as the new search from point.

You can also use the Find feature to center your search from any waypoint, route list entry, map item, or tide station. Highlight the item you want to find from and press **FIND**.

- **Nearest To Boat**—centers search from your boat’s current location.
- **Nearest To Other**—centers your search around another map location.
- **Nearest To Next**—centers search from the next point of your active route.
- **Nearest To Destination**—centers search from the last point of your active route.

**To Find an item using the Find options:**

- 1 From any page, press **FIND**.
- 2 Using the **ROCKER**, highlight a category from the list, and press **ENTER**.
- 3 From the search results list, press **MENU**, highlight an option, and press **ENTER**.

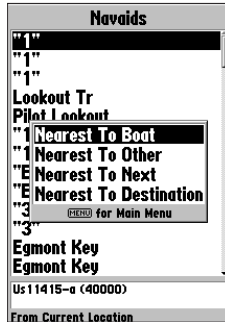

**Find Menu Options**

**Additional Information**

Items located using the Find feature have information about the point available. The information varies depending on the type of data loaded on the optional data card. Sub tabs along the top of the detail window contain the information available for the item. Any additional options are shown along the bottom.

**To view additional information for a Find item:**

1. From the **Find** list, highlight an item, and press **ENTER**.
2. Use the **ROCKER** to highlight the individual tabs, and show the information. To scroll the text, highlight the field, and press **ENTER**. Use the **ROCKER** to scroll.  
Or  
Press **MENU**, and choose a scroll option.

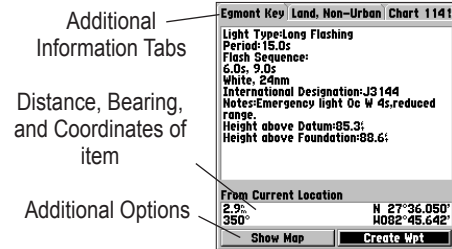

**Information Window**

## DSC

The DSC Page of the Main Menu controls and sets up the Digital Selective Calling (DSC) features on the GPSMAP 198C Sounder.

Digital Selective Calling (DSC) uses marine VHF radio and Global Positioning System (GPS) technologies to transmit and receive location information. The chartplotter repeats the call properties received from the VHF radio on the chartplotter. The GPSMAP 198C Sounder requires input from a DSC enabled VHF radio to show position, and sound/show alerts from a Distress Call or Position Report. Conversely, the VHF radio requires input from a GPS to transmit position coordinates for a Distress Call or Position Report. For connection information, refer to “Connecting the Power/Data Cable” on [page 99](#).

An emergency DSC Distress Call allows a vessel in trouble to transmit a substantial amount of information in a single transmission or call, without the need for voice communication. When any nearby rescuer receives the DSC signal, an alarm sounds and they immediately receive the location of the caller. The rescuer can choose to navigate to the caller’s location to assist, or forward the call on to the Coast Guard. When the Coast Guard receives the call, they can immediately access the caller’s information (such as who they are and the type of vessel) in their database while they are in transit to the caller’s location.

A non-emergency DSC Position Report allows mariners to exchange and show the positions of one another. When a DSC position is received, the mariner can choose to create a waypoint or to show the received location on an electronic map.

Anytime a vessel receives a DSC call, they can store and quickly navigate to that location using a Go To. In order to use DSC, users must first register their VHF radio with the FCC and receive a Maritime Mobile Service Identity (MMSI) number. Garmin does not provide MMSI numbers.

For more information about Digital Selective Calling and Maritime Mobile Service Identity (MMSI) numbers, refer to [page 104](#) in the “Appendix.”

### Understanding Distress Calls

When the GPSMAP 198C Sounder receives a Distress Call from a connected DSC enabled VHF radio, an alert message and notification page are shown, and an alarm tone is sounded. Distress Calls are shown in the DSC Call List, and Log with a checkered symbol.

## Understanding Position Reports

A Position Report is similar to a Distress Call except no alarm is sounded. Position Reports are not broadcast to all DSC users and are shown with a boat symbol.

Distress Call		DSC Position Report	
MMSI	00000001	MMSI	00000001
Name	-----	Name	-----
Receiving Time	29-MAY-03 05:19:28 <sup>h</sup>	Receiving Time	29-MAY-03 05:21:15 <sup>h</sup>
From Current Position		From Current Position	
D: 357 <sup>h</sup>	N 38°51.338'	D: 357 <sup>h</sup>	N 38°51.338'
	W094°47.929'		W094°47.929'
<input type="button" value="Delete"/>	<input type="button" value="Show Map"/>	<input type="button" value="Create Wpt"/>	<input type="button" value="Create Wpt"/>

## Receiving DSC Calls

Each time you receive a Distress Call or Position Report, a Notification Page is shown, and the call is placed in the DSC Call List and Log. The Notification Page contains information about the call including: the type of call (distress or position report), the MMSI number of the caller, a user definable name, the time and date of the call, the Bearing and Distance from your current position, and the coordinates of the caller. To see the callers location on a map, select the **Show Map** button. To create a waypoint at the caller's location, select the **Create Wpt** button. To close the Notification Page, press **QUIT**.

When a Distress Call or Position Report is placed in the Call List and Log, the information on the Notification Page is retained. To review a DSC call or log entry, highlight the entry and press **ENTER**. The DSC Entry Review Page is identical to the Notification Page with one exception, the entry can be deleted.

DSC Entry Review	
MMSI	00000001
Name	-----
Receiving Time	29-MAY-03 05:21:15 <sup>h</sup>
From Current Position	
D: 357 <sup>h</sup>	N 38°51.338'
	W094°47.929'
<input type="button" value="Delete"/>	<input type="button" value="Show Map"/>
	<input type="button" value="Create Wpt"/>

DSC Entry Review Page

### To review a call or log entry:

1. Press **Menu** twice.
2. Open the **Call List** or **Log** from the **DSC** tab.
3. Press up or down on **ROCKER** to highlight the call you want to review.
4. Press **ENTER** to open the **DSC Entry Review Page**.

### **DSC Call List**

The DSC Call List shows the 50 most recent calls, even if the unit is left unattended. The Call List shows the most recent call from a vessel. If a second call from the same vessel is received, it replaces the first call in the Call List. Press **MENU** to sort the list and delete entries.

### **DSC Log**

When DSC calls are received, they are automatically placed in the Log, with the most recent call at the top. The unit can log up to 100 calls. When 100 calls are logged, the oldest log is removed when a new call is received. Press **MENU** to sort the list and delete entries.

### **DSC Directory**

The DSC Directory acts much like a phone book and can hold up to 50 entries. Pressing **MENU** from this page shows options to add a **New Item**, **Delete** a highlighted entry, or **Delete All** entries.

#### **To add a new Directory entry:**

1. Open the **DSC Directory** in the **Main Menu**.
2. Use the **ROCKER** to highlight the first blank space in the directory list, and press **ENTER**.  
Or  
Press **MENU**, highlight **New Item**, and press **ENTER**.

3. Enter the MMSI number, a Name, and any comments.
4. When finished, highlight **OK**, and press **ENTER**.

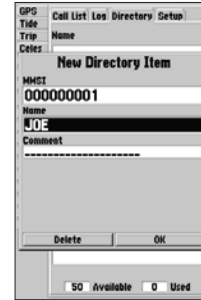

**New Directory Item Page**

When a Distress Call, Position Report, or Directory item is named, the name is attached to that particular MMSI number. If a name is used, all DSC entries of the same MMSI number show the name.

## Navigating to a Position Report or Distress Call

After a Position Report or a Distress Call is received, navigation can be quickly set to the call location.

### To navigate to Position Report or Distress Call:

- 1 Press **NAV**.
  2. With **Go To MMSI/Name** highlighted, press **ENTER**.
- Or
1. Highlight the call on the **Call List** or **Log**, and press **NAV**.
  2. With **Go To MMSI/Name** or **DSC** highlighted, press **ENTER**.

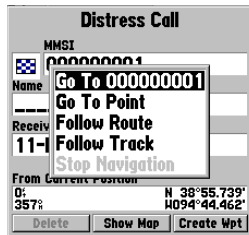

Navigating to a DSC Call

## Setting up DSC

The DSC Setup tab turns DSC chartplotter information screen **On** and **Off**. This Setup tab also allows you to simulate Distress Calls and Position Reports while the unit is in Simulator Mode (see page 3). Simulating calls is helpful for practice before connecting to the real system. The Distress Call simulator also helps to check if alarms are working properly.

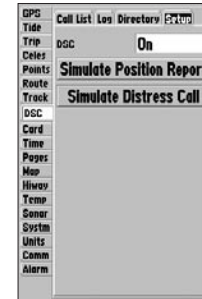

DSC Setup

## MAIN PAGES

There are five main pages that are always available: Map, Sonar, Compass, Numbers, Highway, and Active Route Pages. You can cycle through these pages by pressing either **PAGE** or **QUIT**. For information on the Sonar Page, refer to the “Using Sonar” section on [page 78](#).

With the Map Page shown, press **PAGE** several times. Each time you press **PAGE** the next main page appears. Do the same with the **QUIT** key. **QUIT** acts the same as **PAGE**, except the pages are shown in a reverse sequence.

Each main page has an Options Menu. Options Menus contain the setup options and functions that apply to that page. Press **MENU** to show the Options Menu. Use the **ROCKER** to select an item from the options menu and press **ENTER**. Many of the menus in the GPSMAP 198C Sounder are arranged in a tab layout. Use the **ROCKER** to move left or right from tab to tab.

Notice that either **PAGE** or **QUIT** stops the current function and returns you to the main page. If you find yourself lost in a menu or you start a function you do not want, press **PAGE** or **QUIT**.



Map Page

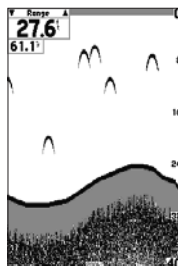

Sonar Page

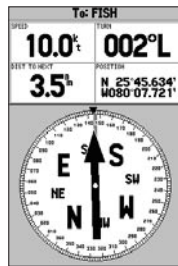

Compass Page

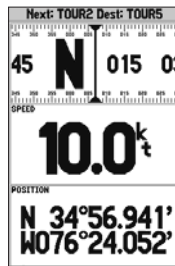

Numbers Page

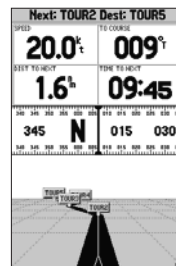

Highway Page

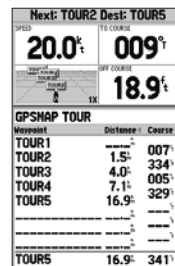

Active Route Page



## Map Page

The GPSMAP 198C Sounder's Map Page provides a comprehensive screen of electronic cartography, plotting, and navigational data. When using the unit with optional BlueChart or MapSource data, the Map Page shows your boat on a digital chart, complete with geographic names, map items, nav aids, and a host of other chart features. It also plots your track and shows any routes and waypoints you create. The map pointer allows you pan and scroll to other map areas, determine the distance and bearing to a location, and perform various route and waypoint functions.

When the map pointer is active, an additional data window appears below the data fields to indicate the location, range, and bearing to the pointer, a selected waypoint, or map item. The map zoom range shown at the bottom right of the page.

The **Zoom IN** and **OUT** keys combined with the **ROCKER**, allows you select zoom ranges and move the pointer. Two basic map operating modes, Position Mode and Pointer Mode, determine what cartography is shown on the Map Page. Position Mode moves the cartography to keep the present position marker within the screen area. Pan Mode moves the cartography to keep the map pointer within the screen area.

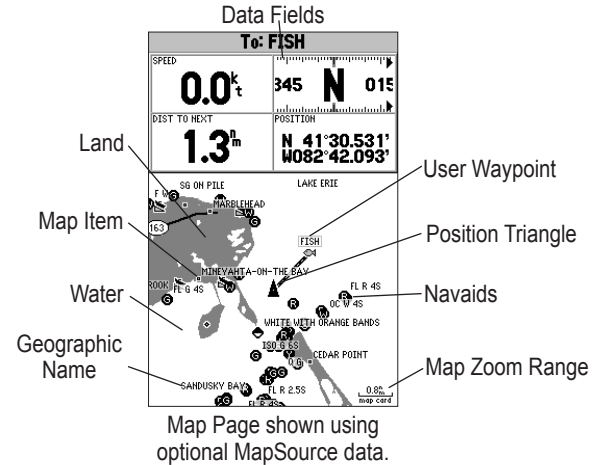

Map Page shown using optional MapSource data.

The GPSMAP 198C Sounder system starts in the Position Mode, with your location centered on the Map Page. When sufficient map coverage is not available to keep your location centered, the position triangle moves toward the edge of the screen.

Pan Mode starts when the **ROCKER** is pressed. The pointer is moved over the Map Page using the **ROCKER**. When the pointer reaches the edge of the screen, the map scrolls forward under the pointer.

## Using the Map Pointer

The pointer pans away from your present location (even outside of your current detail coverage.) As you pan past the edge of the current Map Page, the screen actively scrolls forward to provide continuous map coverage. An hourglass symbol appears by the pointer while the unit is busy drawing new map details.

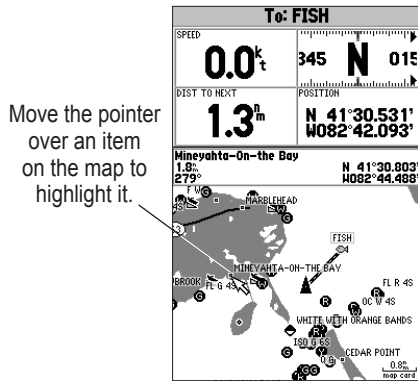

As you move the pointer, the distance and bearing from your present location to the pointer is shown in the data window, along with the pointer's location coordinates. Keep in mind that when the pointer is stationary, the distance and bearing from your present position changes as your location moves. The pointer can also be used to view on-screen waypoint and map item properties directly from the Map Page.

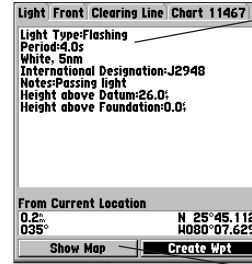

Additional Information Tabs

Pressing **ENTER** while highlighting a map item brings up additional details and options.

Additional Options

### To select an on-screen waypoint or map item with the map pointer:

1. Use the **ROCKER** to move the map pointer to a waypoint or map item. (If there are several waypoints grouped closely together, zoom in closer for a better view.)
2. When a waypoint or map item is selected, it is highlighted on-screen, with the name and location shown. Press **ENTER** to show details of the map item. When using BlueChart or MapSource data, additional information tabs appear. Use the **ROCKER** to highlight the individual tabs, and shows additional information and options.
3. Press **QUIT** to re-center your location on-screen.

Use the pointer to create new waypoints directly from the map.

### To create a waypoint with the pointer:

1. Use the **ROCKER** to move the pointer to the map location.
2. Press **ENTER**, and the New Map Waypoint window appears. If the pointer is on a map item, press **ENTER**, and a new window with details about the item appears.
3. Press **ENTER** again on the highlighted **Create Wpt** option.
4. Press **ENTER** to confirm the new waypoint using the default three-digit name and symbol.

For more information about waypoints, see [page 8](#).

## Selecting Map Zoom Ranges

The Map Page has 28 available range scales from 20 ft to 800 mi (5 m to 1200 km.) The map zoom range is controlled by the **IN** and **OUT** keys, with the current zoom range shown at the bottom right of the data window.

### To select a map zoom range:

Press the **OUT** key to zoom out and the **IN** key to zoom in.



---

**NOTE:** The zoom range value represents the distance from one end of the zoom range bar to the other.

---

3<sup>m</sup>

Using Built-In Basemap

3<sup>m</sup>  
map card

Using BlueChart or MapSource Data

2<sup>m</sup>  
overzoom

Overzoom, no additional data is available

The GPSMAP 198C Sounder's system has a built-in worldwide database to 20 mi, with more detailed coverage available through the use of the optional BlueChart or MapSource data. The GPSMAP 198C Sounder shows cartography as long as there is chart information available for the range you have selected. Map coverage conforms to the following conditions:

- When the selected zoom range is covered by the internal database, BlueChart, or MapSource data, cartography is shown.
- When the selected zoom range is covered by both the internal database and BlueChart/MapSource data, cartography is shown using the data with the best resolution.
- When the selected zoom range exceeds the resolution of the data in use, an **Overzoom** warning appears below the zoom range.

## Map Page Options

Many features of the GPSMAP 198C Sounder are menu driven. Each main page has an options menu, allowing you to customize the corresponding page to your preferences and/or select special features that specifically relate to that page. The data window, located at the top of the main pages, provides a user-selectable layout of various types of useful data. Each data field can be configured to show any one of several data options. The data window layout can be configured to show additional data fields and change the size of the data shown.

The GPSMAP 198C Sounder's Map Page provides access to functions and features relating to the Map Page and layout options.

### To show and select the Map Page options:

1. Press **MENU**.
2. Use the **ROCKER** to highlight an option, and press **ENTER**.

The available options are Full Screen Map/Show Data, Change Numbers, Measure Distance, Show Sonar (If equipped with a transducer, see the "Using Sonar" section on [page 78](#) for details on this feature,) Set up Map and Turn Declutter On/Off. Following are details on using each of these options.

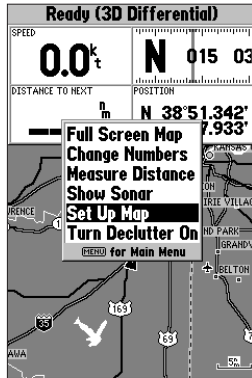

Map Page Options

**Full Screen Map/Show Data**—toggles between the Map Page without or with data fields on the Map Page.

#### To maximize the map/show data fields:

1. Highlight **Full Screen Map**, and press **ENTER**. The Map Page is now maximized with no data fields.
2. To show the data fields again, press **MENU**, highlight **Show Data**, and press **ENTER**.

**Change Numbers**—specifies the type of data shown in each data field used on the Map Page.

#### To change a data field:

1. From the menu, use the **ROCKER** to highlight the **Change Numbers** option, and press **ENTER**.
2. Move the field highlight to the data field you want to change, and press **ENTER**.
3. Move up or down on the list using the **ROCKER** to highlight the data you want to show, and press **ENTER**. To exit, press **QUIT**.

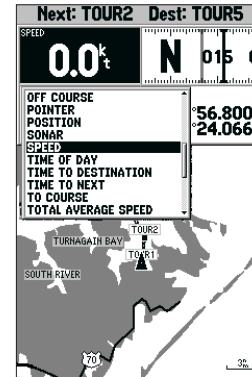

**NOTE:** *Pointer, Highway, Location, and Sonar field options are only available on medium and large sized data fields.*

You can also merge the four medium default data fields to a single, large field for better readability or you can split any or all of the default data fields to show four small data fields.

Single, large data field



Default, medium fields



Split, small fields



**Measure Distance**—measures the bearing and distance between any two points on the Map Page.

**To measure the bearing/distance between two points:**

1. Highlight **Measure Distance**, and press **ENTER**. An on-screen pointer labeled **ENT REF** appears on the Map Page at your present location.
2. Move the pointer to a reference point (the point that you want to measure from), and press **ENTER**.

3. Move the pointer to the end measurement point. The bearing and distance from the reference point and pointer coordinates is shown in the data window at the top of the screen. Press **QUIT** to finish.

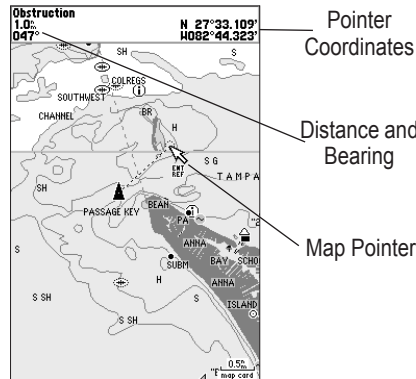

Full screen map shown (with BlueChart data)

**Set up Map**—configures the Map Page preferences, including map detail, map orientation, automatic zoom, and various map items and points. Refer to “Main Menu—Map Tab” on page 64 for more information.

**To change a map setup feature:**

1. From the Map Page menu, highlight **Set up Map**, and press **ENTER**.
2. Press left or right on the **ROCKER** to highlight a tab, then press up or down on the **ROCKER** to highlight the setting you want to change, and press **ENTER**.
3. Press up or down on the **ROCKER** to highlight to a setting, and press **ENTER**. To exit, press **QUIT**.

From the map setup page, you can access the following menu options by pressing **MENU**:

- **Defaults**—restores settings back to factory settings for the tab highlighted.
- **All Map Defaults**—restores settings back to factory settings for all tabs.

**Turn Declutter On/Off**—toggles between showing BlueChart spot soundings and map outlines for easier viewing.

## Compass Page

The Compass Page provides graphic steering guidance to a destination waypoint, with an emphasis on the bearing to your destination and current direction of travel. The middle of the page features a rotating compass ring that shows your course over ground (track) while you are moving, and a bearing pointer that indicates the direction of the destination (bearing) relative to the course over ground. The compass ring and pointer arrow work independently to show—at a glance—the direction of your movement and the direction to your destination. For instance, if the arrow points up, you are going directly to the waypoint. If the arrow points any direction other than up, turn toward the arrow until it points up—then continue in that direction.

The current speed, distance to the next waypoint, turn angle and current location appear at the top of the screen. This page provides better steering guidance when traveling at slower speeds and/or when making frequent directional changes. When you are not navigating to a waypoint, the compass ring shows the current direction of travel but the arrow does not appear.



---

**NOTE:** *The bearing pointer, bearing bug, and compass ring can point in various directions when you are stationary or at very low speeds. Once you start moving, the pointer is correct.*

---

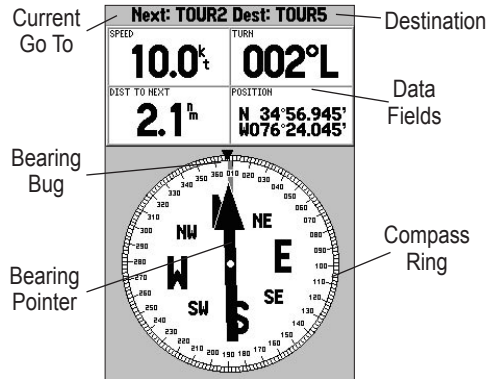

The GPSMAP 198C Sounder's Compass Page features a menu that provides access to layout and data field options. The data window, located at the top of the page, provides a user-selectable layout of various types of useful data. Each data field can be configured to show several data options. The data window layout can be configured to show additional data fields and change the size of the data shown.

### To show and select the Compass Page options:

1. Press **MENU**.
2. Use the **ROCKER** to highlight an option, and press **ENTER**.  
For detailed instructions on changing the data fields and layout of the Compass Page, see [page 31](#).

## Numbers Page

The Numbers Page provides for precision navigation to 1 degree of steering. The default page shows three large numbers fields. You can customize the Numbers Page to show the size and number of fields along with the type data you want to see. See [page 31](#) for instructions on changing the data fields.

The Numbers Page provides a quick reference for the important data you want to show. By default, the page shows three large, user-selectable data fields showing a compass ribbon, speed, and current location coordinates. You can also choose to show the three data fields in large lettering for better readability or you can split any or all of the data fields to show four smaller data fields. See [page 31](#) for detailed instructions on changing the data fields and layout of the Numbers Page.



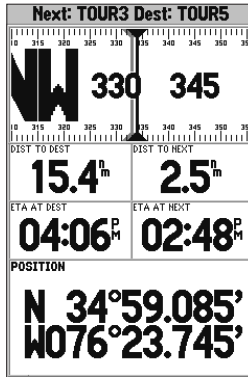

Numbers Page shown with middle data field split into four fields

## Highway Page

The GPSMAP 198C Sounder’s Highway Page provides graphic steering guidance to a destination waypoint, placing greater emphasis on the straight-line course, and the distance and direction you are off course. As you head toward your destination, the middle of the screen provides visual guidance to your waypoint on a moving graphic highway. Your present location is at the bottom center of the Highway Page. The line down the middle of the highway represents your course. As you navigate toward a waypoint, the highway moves—indicating the direction you are off course. To stay on course, steer toward the center of the highway.

### To split the data fields:

1. Press **MENU**, then press **ENTER**. Highlight the data field, and press **MENU**.
2. Highlight Split Numbers, then press **ENTER**. Four new data fields appear. Press **QUIT** to finish.
3. To return to the original configuration, repeat steps 1 and 2, but instead of **Split Numbers**, select either **Merge Numbers** or **Defaults**. Press **QUIT** to finish.

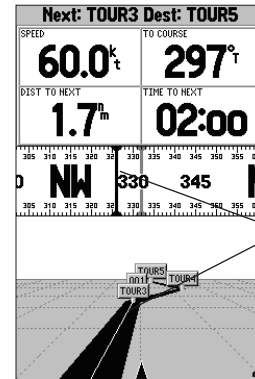

Steer toward the center of the highway or towards the black vertical bar on the compass ribbon to get back on course.

The four data fields at the top of the page provide additional user-selectable guidance information. Additionally, a compass ribbon shows your current heading along with a dark, vertical bar that indicates the direct bearing to the navigation point. When the dark, vertical indicator (or arrow) lines up with the lighter red bar in the middle, you are heading directly to the navigation point. Use the Highway Page as your primary navigation page in lieu of the Compass Page when your main concern is following a defined course.

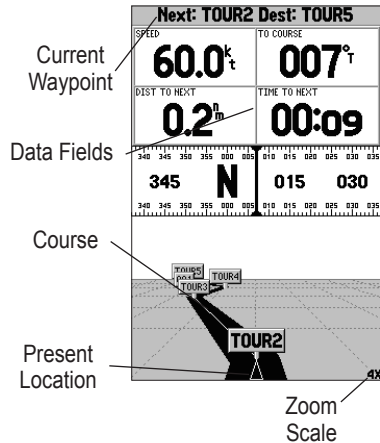

You can zoom in or out on the Highway Page for a smaller or larger view. Five available settings range from 1X to 16X, with a default setting of 8X. The current zoom range appears in the bottom right of the screen.

### To zoom in or out on the Highway Page:

Press either the **IN** or **OUT** key to increase or decrease the zoom range.

### Highway Page Options

The GPSMAP 198C Sounder's Highway options page defines the data fields and selects the waypoints and tracks shown. The data window, located at the top of the page, provides a user-selectable layout of various types of data. Each data field can be configured to show several data options. The data window layout can be configured to show additional data fields and change the size of the data shown.

### To show and select the Highway Page options:

1. Press **MENU**.
2. Using the **ROCKER**, highlight an option, and press **ENTER**.

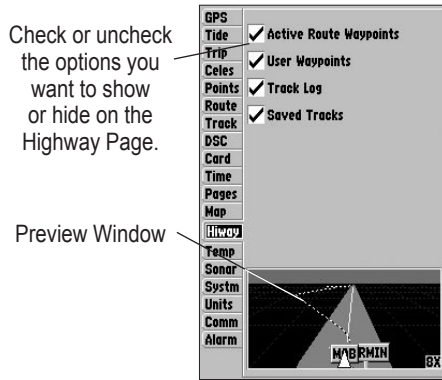

**Highway Page Set up**

The following options are available from the Highway Page menu:

**Set up Highway**—selects what waypoints and tracks are shown on the Highway Page. Use the **ROCKER** and **ENTER** keys to select or deselect the options.

**Change Numbers**—specifies the type of data shown in each data field used. For detailed instructions on changing the data fields and layout of the Highway Page, see [page 31](#).

## Active Route Page

The Active Route Page shows each point of the active route, with the point name, distance and choice of Course, ETA, Fuel, Leg Distance, Leg Fuel, Leg Time, Sunrise, Sunset, or Time To for each point from your present location. The current destination point is marked with an arrow icon. As you navigate a route, the waypoint list automatically updates to indicate the next active point first. The Active Route and Route Review Pages share many of the same features and options. For more information on the Active Route Page, see [page 17](#).



**NOTE:** The Active Route Page only appears when the unit is navigating to a destination using a route, TracBack, or Go To.

Next: TOUR2 Dest: TOUR5		
SPEED	30.0 <sup>t</sup>	TO COURSE
		008 <sup>t</sup>
TOUR1	TOUR4	OFF COURSE
MARCO	FISH	26.6 <sup>t</sup>
		1X
GPSMAP TOUR		
Waypoint	Distance	Course
TOUR1	---	007 <sup>t</sup>
TOUR2	0.2 <sup>n</sup>	334 <sup>t</sup>
TOUR3	2.7 <sup>n</sup>	005 <sup>t</sup>
TOUR4	5.8 <sup>n</sup>	329 <sup>t</sup>
TOUR5	15.6 <sup>n</sup>	
---		
---		
---		
---		

**Active Route Page**

## Active Route Page Options

The following options are available from the Active Route Page:

- **Hide/Show Numbers**—see [page 31](#) for instructions (same as Map Page option).
- **Change Numbers**—see [page 31](#) for instructions.
- **Edit on Map**—see [page 17](#) for instructions.
- **Add Before**—see [page 17](#) for instructions.
- **Remove**—see [page 17](#) for instructions.
- **Invert**—reverses the direction of the route.
- **Re-evaluate**—recalculates and restarts the current route.
- **Invert**—reverses the route.

### To invert an active route:

1. From the **Active Route** Page, press **MENU**.
2. Using the **ROCKER**, highlight **Invert**, and press **ENTER** to reverse the route.

**Re-evaluate**—restarts the current route and selects the route leg closest to your current location as the active leg. The active leg defines the current from and to waypoints.

### To re-evaluate an active route:

1. From the **Active Route** Page, press **MENU**.
2. Using the **ROCKER**, highlight **Re-evaluate** and press **ENTER** to recalculate.

# MAIN MENU

The GPSMAP 198C Sounder’s Main Menu provides access to various waypoint, system, navigation, interface management, and setup menus. The 19 Menu tabs are divided into categories by function. The Main Menu is available from any page in the system, and is accessed by pressing **MENU** twice. See [page 6](#) for additional instructions on changing settings and entering data.

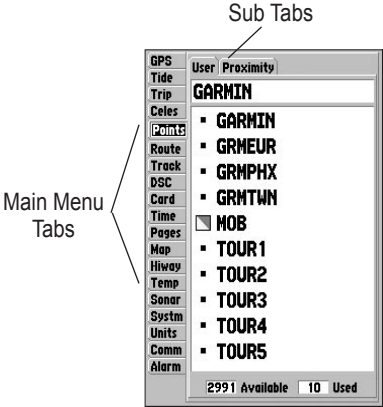

Main Menu

## To select a Menu tab from the Main Menu Page:

1. Press up or down on the **ROCKER** to highlight a tab. The information for the highlighted tab automatically appears to the right. If you want to select any of the sub tab items, press right on the **ROCKER**, then press up or down to select individual items.
2. Either press **MENU** for additional submenu options, or press **ENTER** to make changes to the highlighted item. Press left on the **ROCKER** to get back to the Main Menu.
3. Press **QUIT** to return to the Main Menu.

## GPS Tab

The GPS tab provides a visual reference of satellite acquisition, receiver status, and accuracy. The status information provides an idea of what the receiver is doing at any given moment. The sky view and signal strength bars give you an indication of what satellites are visible to the receiver and whether or not they are being tracked. The signal strength is shown on a bar graph for each satellite, with the satellite number below. As the receiver locks onto satellites, a signal strength bar appears for each satellite in view. The progress of satellite acquisition is shown in three stages:

- **No signal strength bars**—the receiver is looking for the satellites indicated.
- **Light signal strength bars**—the receiver has found the satellite(s) and is collecting data.
- **Dark signal strength bars**—the receiver has collected the necessary data and the satellite(s) are ready for use.

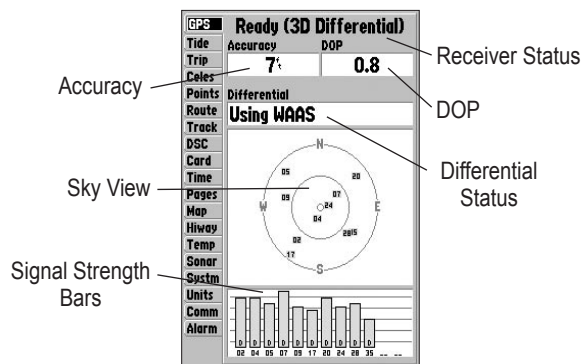

The status field indicates a 2D or 3D, when the GPSMAP 198C Sounder has collected the necessary data from satellites to calculate a fix. The unit then updates the location, date, and time.

You can use the sky view to help determine if any satellites are being blocked, and whether you have a current location fix (indicated by a 2D, 2D Differential, 3D, or 3D Differential in the status field). The sky view shows a bird's-eye view of the position of each satellite relative to the receiver's last known location. The outer circle represents the horizon (north up), the inner circle 45° above the horizon, and the center point a position directly overhead. You can also set the sky view to a Track up configuration, causing the top of the sky view to align along your current track heading.

### WAAS Capability

The GPSMAP 198C Sounder is capable of receiving WAAS (Wide Area Augmentation System) satellite signals. WAAS is an FAA (Federal Aviation Administration) funded project to improve the overall accuracy and integrity of the GPS signal for aviation use, but land/sea based users can also benefit from this system. At this time, the system is still in the development stage and is not fully operational.

There are currently two WAAS satellites that can be received in the U.S.A., one over the Atlantic Ocean and one over the Pacific

Ocean, in a geo-stationary orbit over the equator. Effective use of the WAAS satellite signal can be limited by your geographic location in relation to those satellites, now in developmental service. WAAS satellite signal reception requires an absolute clear view of the sky and works best when there are no nearby obstructions such as buildings, mountains.

WAAS satellites are numbered 33 or higher when viewing the sky view on your GPSMAP 198C Sounder. Initial reception of the WAAS signal can take up to 15-20 minutes, then 1-2 minutes afterwards. When WAAS differential correction has been received for GPS satellites (numbers 32 or below), a D appears in the signal bar of the sky view and 2D or 3D Differential appears in the receiver status. To learn more about the WAAS system, its satellite positions and current state of development, visit the FAA web site (<http://gps.faa.gov>). Since WAAS requires CPU resources of the GPSMAP 198C Sounder to search for and track the satellites, you can disable the WAAS feature to improve unit performance if WAAS reception is not available in your area. Refer to the “Appendix” for more information.

**To Disable/Enable WAAS capability:**

1. From the **GPS** tab, press **MENU**.
2. Use the **ROCKER** to highlight **WAAS Off** or **WAAS On**, and press **ENTER**.

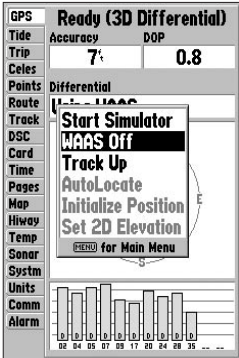

Highlight **WAAS Off**, and press **ENTER** to disable the WAAS capabilities.

- **AutoLocate**—the receiver is looking for any satellite whose almanac has been collected. This process can take up to five minutes.
- **Acquiring Satellites**—the receiver is looking for and collecting data from satellites visible at its last known or initialized position, but has not collected enough data to calculate a fix.
- **2D**—at least three satellites with good geometry have been acquired and a 2 dimensional position fix (latitude and longitude) is being calculated. “2D Differential” appears when you are receiving DGPS corrections in 2D mode and a D shows on the strength bar of satellites being corrected.
- **3D**—at least four satellites with good geometry have been acquired and your location is now being calculated in latitude, longitude and elevation. “3D Differential” appears when you are receiving DGPS corrections in 3D mode and a D shows on the strength bar of satellites being corrected.
- **Poor GPS Coverage**—the receiver is no longer tracking enough satellites for a 2D or 3D fix.
- **Receiver Not Usable**—the receiver is unusable, possibly due to interference or abnormal satellite conditions. Turn the unit off and back on to reset.
- **Simulating**—the receiver is in Simulator Mode.

The Differential Receiver status shows one of the following:

- **Off**—No optional beacon receiver attached or enabled in the Comm menu or WAAS Off.
- **Searching For WAAS**—WAAS is enabled and receiver is searching for WAAS signal
- **Using WAAS**—WAAS capability enabled and unit receiving WAAS corrections.
- **No Beacon Signal**—DGPS receiver attached, but not transmitting RTCM data to GPS.
- **Tuning Beacon**—receiver is tuning manual DGPS frequency.
- **Receiving Beacon**—unit is receiving DGPS corrections.
- **Scanning Beacon**—DGPS receiver is scanning for available frequency.

The Differential SNR (Signal to Noise Ratio) indicates, on a scale to 0-30db with 30db being the best, the strength of the DGPS signal being received. The SNR depends on the mounting of your DGPS receiver and the distance from the DGPS transmitting station. If no optional DGPS receiver is used with the GPSMAP 198C Sounder, the **DGPS Rcvr** field shows **Off**.



## GPS Tab Options

The GPS tab features an options page that provides access to functions and features relating to the GPS Info Page.

### To show and select the GPS Tab options:

1. Press **MENU**.
2. Using the **ROCKER**, highlight an option, and press **ENTER**.



***NOTE:** If a DGPS receiver is attached to the unit and Garmin DGPS, RTCM In/NMEA Out, or Other DGPS is enabled on Port 2, WAAS is automatically disabled (WAAS Off). It is not possible for the GPSMAP 198C Sounder to receive WAAS and DGPS corrections at the same time.*



GPS Tab Options

## Tide Tab

The Tide tab shows a graphical chart that shows tide station information in a 24 hour span starting at midnight station time. You can choose from different dates and more than 3,000 tide stations.

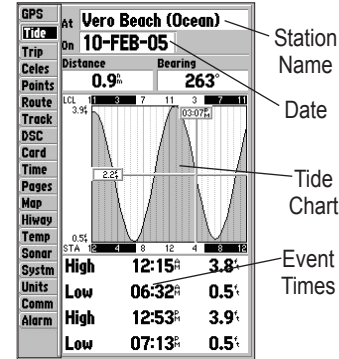

Tide Tab

The top of the page shows the tide station being referenced, below that the date. The top of the chart shows a 24-hour block of local time (LCL) for your location, with the reported station time (STA) appearing at the bottom. Daytime (light bar) and nighttime (dark bar) show across the time scale, with the time progressing from left to right. (Local time scales and sunrise/sunset info can not be available for a few stations). The solid, light vertical lines are

in 4-hour increments, and the light, dotted vertical lines are in 1-hour increments. A solid, vertical line (with the current time box at the top) indicates the time of day when using current date and intersects the tide graph to show their relation.

You can select from a list of nearest stations.



The tide curve shows as a shaded area, with higher tides being taller (blue) and lower tides shorter (red). The solid, horizontal line (with the current tide box on the left) indicates the current tide height. The figure to the left of the line shows the current tide level in feet. The Mean Lower Low Water (MLLW) appears as a solid, horizontal line near the bottom of the chart (This line only appears if the tide ranges to the zero value or below). The numbers directly below/above LCL and STA indicate the maximum/minimum levels, respectively. The four data fields below the chart, indicate event times and levels the tide changes starting in the upper left field, going downward, then to the upper right and down again.

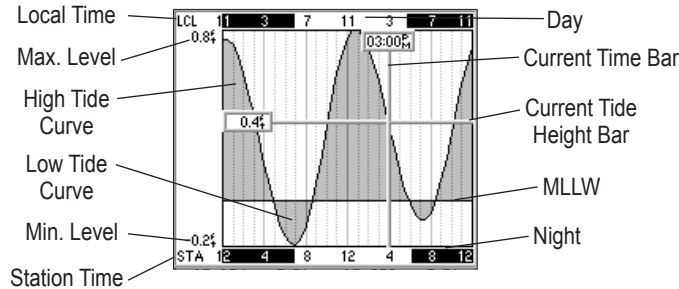

### To select the nearest tide station from you current location:

1. From the **Tide** tab, highlight the **At** field, and press **ENTER**.
2. Highlight the station of the list, and press **ENTER** twice.

Automatically search for the nearest station using a variety of search locations. You must select a location within 100 nm of a tide station. If you are not within this range, you see a message “None Found.” Use the **Nearest To Other** Find option and select a location closer to a tide station.

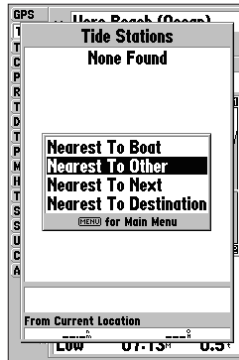

### To select a tide station from the map:

1. When the search results appear, press **FIND**, highlight **Tide Stations**, press **ENTER**, and then press **MENU**.
2. Highlight **Nearest To Other**, and press **ENTER**.
3. Select a location on the map, and press **ENTER**. A list appears showing the nearest tide stations.
4. Highlight the station, and press **ENTER** twice. If the **None Found** message appears, repeat steps 1-4 until you find a station.

### To change the date for the tide chart:

1. Using the **ROCKER**, highlight the **On** field, and press **ENTER**.
2. Enter the date, and press **ENTER**.

### To use the current date:

Press **MENU**, highlight **Use Today's Date**, and press **ENTER**.

Move the time bar on the tide chart in 5 minute increments to show tide heights at various times on the chart.

### To see tide heights at various times on the chart:

1. Press **MENU**, highlight **Move Cursor**, and press **ENTER**.
2. Press left or right on the **ROCKER** to change the time. Press **QUIT** when finished or press **MENU**, highlight **Stop Moving Cursor**, and press **ENTER**.

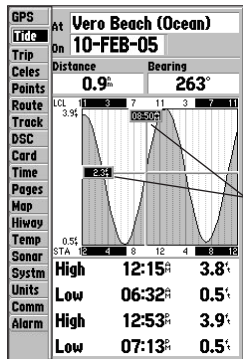

Move the pointer to see tide heights at different times. Tide data shows in a black box when in pointer mode.

## Trip Tab

The Trip tab shows the Trip Odometer, Moving Average speed, Total Average speed, Maximum Speed, Stopped Time, Moving Time, Total Time, and Odometer. To reset the data, choose from Reset Trip, Reset Max Speed, Reset Odometer, or Reset All, and pressing **ENTER**.

GPS	Trip Odometer	Stopped Time
Tide	0.2'	57:18:20
LiFi	Moving Average	Moving Time
Celes	0.1'	02:26:14
Points	Total Average	Total Time
Route	0.0'	59:44:34
Track	Maximum Speed	Odometer
DSC	2.0'	0.2'
Card	Reset Trip	
Time	Reset Max Speed	
Pages	Reset Odometer	
Map	Reset All	
Hiway		
Temp		
Sonar		
Systm		
Units		
Comm		
Alarm		

## Celes (Celestial) Tab

The Celestial tab shows celestial data for sun and moon rise/set, moon phase, and approximate sky view location of the sun and moon. The moon phase shows the current visible portion of the moon as a light color. You can show this data for your current location, a location from the map, or a Find item location. Use the current data, or select a different date and time.

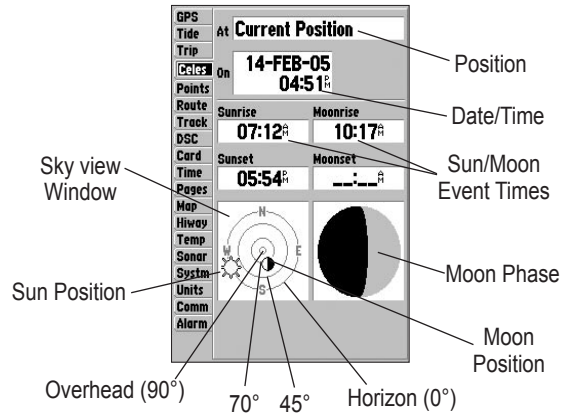

### To choose a position:

1. From the **Celes** tab, highlight the **At** field, and press **ENTER**.
2. From the Find list highlight any category, except Other Location, and press **ENTER**. If you want to reference a Find item, select from the Find list, and press **ENTER**.
3. Select an item from the list or tab lists, and press **ENTER**. For a location from the map, choose **Other Location**, press **ENTER**, select a location on the map, and press **ENTER**.
4. From the Find item detail page, highlight **OK**, and press **ENTER**.

The location the unit is using appears in the Date/Time/Position field. The time tables shown are based on your current time zone. When using a position from another location outside of your time zone, you need to set the Time Zone for that location. See [page 62](#) for more information on setting time zones.

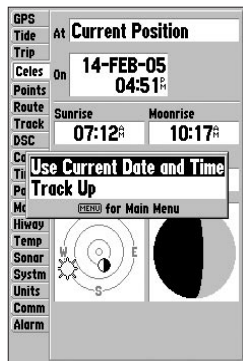

Celestial Tab Menu

### To change the time or date:

1. From the **Celes** tab, use the **ROCKER** to highlight the date or time, and press **ENTER**.
2. Enter a new date or time, and press **ENTER**.

### To use current date and time:

From the **Celes** tab, press **MENU**, use the **ROCKER** to highlight **Use Current Date and Time**, and press **ENTER**.

## Points Tab

The Main Menu Points tab features two waypoint sub tabs, User and Proximity, that manage a large number of waypoints quickly and efficiently. The sub tabs also provide a continuously updated proximity waypoint alarm function that can be used to define an alarm circle around items such as submerged hazards or shallow waters.

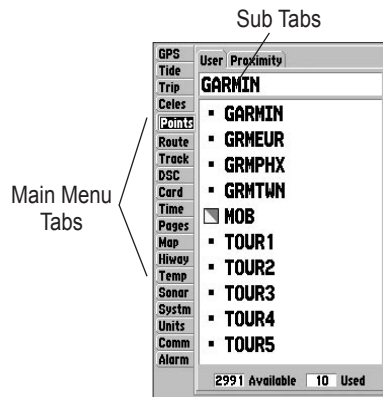

**To select the Points (Waypoint) sub tab:**

1. Use the **ROCKER** to highlight the **Points** menu tab. A list of stored waypoints appear to the right of the Main Menu list.
2. Press right one time on the **ROCKER**. The **User** tab is now highlighted.
3. Press down on the **ROCKER** until a waypoint is highlighted.

**User Waypoint List**

The first waypoint submenu list available from the Points tab is the User list, which shows a master list of all waypoints currently stored in memory. From the User list, you can review, edit, rename or delete individual waypoints, or delete all user waypoints. The total number of stored and available waypoints is shown at the bottom of the User page, with the stored waypoints arranged in alphanumerical order.

The following options are available from the User submenu on the Points tab:

- **Create Waypoint**—allows you to create a waypoint. (See page 8 for creating a waypoint)
- **Delete Waypoint**—deletes selected waypoint from and waypoint list and route.
- **Delete By Symbol**—deletes waypoints that use the same symbol.
- **Delete All**—deletes all waypoints from the unit.



---

**NOTE:** *When a waypoint is deleted from the list, it cannot be recovered from the unit. It is advisable to backup important waypoints to a computer using an optional PC cable and interface software or record them manually.*

---

**To show the waypoint menu options:**

Using the **ROCKER**, highlight the **User** tab, and press **MENU**.

**To scroll through and review the waypoint list:**

1. With the **ROCKER**, highlight the **Points** tab from the **Main Menu**, and then highlight **User**.
2. Use the **ROCKER** to scroll through the list.
3. Press **ENTER** to review the highlighted waypoint on the **Waypoint Edit Page**.
4. Press **ENTER** to return to the list and automatically highlight the next waypoint.

**To search for a waypoint by name:**

1. Highlight the name field, and press **ENTER**.
2. Use the **ROCKER** to select the first letter of the name.
3. Move to the right, and enter the second letter, if you do not see the name in the list below.
4. Repeat this until the name appears. Press **ENTER** when you see the name.
5. Highlight the name on the list, and press **ENTER** again to review the waypoint. When finished, highlight **OK**, and press **ENTER**.

**To delete an individual waypoint from the list:**

1. Use the **ROCKER** to highlight the waypoint to delete, and press **MENU**.
2. Highlight **Delete Waypoint**, and press **ENTER**. You can also highlight the waypoint, press **ENTER**, then highlight **Delete**, and press **ENTER**.
3. Press **ENTER** to confirm the deletion warning.





**To delete waypoints by symbol:**

1. From the **User** sub tab, highlight the waypoint to delete, and press **MENU**. Select **Delete By Symbol**, and press **ENTER**.
2. Use the **ROCKER** to highlight the symbol of the waypoint(s) to delete, and press **ENTER**.
3. Press **ENTER** to confirm. To stop the deletion, choose **Cancel**, or press **QUIT**.

**To delete all waypoints or the entire waypoint list:**

1. Press **MENU** to select the options window.
2. Use the **ROCKER** to highlight **Delete All**, and press **ENTER**.
3. Highlight **OK**, and press **ENTER** to confirm.

**Proximity Waypoint List**

The Proximity list allows you to define an alarm circle around a stored waypoint location, and can be used to help you avoid reefs, rocks, or restricted waters. Up to 10 waypoints can be listed, with a maximum alarm radius of 99.99 nautical or statute miles or kilometers. If a proximity alarm circle overlaps with an existing alarm circle, a “Proximity Overlaps Another Proximity Waypoint” message appears. Because the unit only alerts for one of the overlap points, use caution when navigating in these areas. If you enter an alarm circle overlap, you are only alerted to the closest proximity waypoint.

GPS	User: Proximity
Tide	Proximity Alarm
Trip	
Celes	On
Points	Waypoint Distance
Route	<b>GARMIN</b> 12.00 <sup>n</sup>
Track	-----
DSC	-----
Card	-----
Time	-----
Pages	-----
Map	-----
Hivoy	-----
Temp	-----
Sonar	-----
System	-----
Units	-----
Comm	-----
Alarm	-----

### To add a proximity waypoint:

1. Use the **ROCKER** to highlight an empty space on the Proximity list, and press **ENTER**. The **Find** screen appears. Highlight **Waypoints**, and press **ENTER**.
2. To select a waypoint from the lists, use the **ROCKER** to highlight a waypoint from the **User** or **Nearest** tab.  
To select a waypoint from the map, highlight either the **User** or **Nearest** tab, and press **MENU**. With **Select From Map** highlighted, press **ENTER**. Use the zoom **In** and **Out** keys and the **ROCKER** to highlight a waypoint.
3. Press **ENTER** to confirm. The distance field is now highlighted.
4. Press **ENTER** to begin entry of the proximity radius.
5. Use the **ROCKER** to enter a distance value (to 99.99 units), and press **ENTER**.

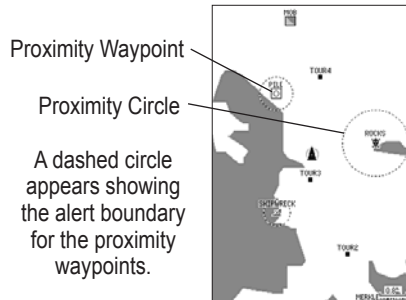

### To turn on or off proximity alarms:

1. Use the **ROCKER** to highlight the field below **Proximity Alarm**, and press **ENTER**.
2. Select a **ON** or **OFF** setting, and press **ENTER**.

### To show the waypoint menu options:

Using the **ROCKER**, highlight the **Proximity** tab, and press **MENU**.

### To clear one or all proximity waypoint(s) from the list:

1. Use the **ROCKER** to highlight the proximity waypoint, and press **MENU**.
2. To clear a single alarm, highlight **Delete Alarm**, and press **ENTER**.
3. To clear all proximity waypoints, select the **Delete All** option, and press **ENTER**.
4. Use the **ROCKER** to highlight **OK**, and press **ENTER**.

The following options are available from the Proximity sub tab of the Points tab:

- **Delete Alarm**—removes a selected waypoint from proximity list.
- **Delete All**—removes all waypoints from proximity list.

## Routes Tab

The GPSMAP 198C Sounder Route List Page shows all the routes currently stored in memory, along with a descriptive name for each route. After a route has been created, it can be started and used for navigation with the **NAV** key. A route can be followed in the same sequence as it was originally created, or you can invert the route and navigate from the end waypoint back to the beginning waypoint. From the Route list menu, you can choose New Route (page 17), Copy Route, Delete Route, or Delete All.

### To start a route with the NAV key:

1. From any page, press **NAV**, using the **ROCKER**, highlight **Follow Route**, and press **ENTER**. If you highlight a route from the **Route List** or **Route Review** Page, and press **NAV**. The window automatically shows, **Follow <the route name>**.
2. Highlight the route you want to navigate, and press **ENTER**.
3. Choose **Activate** or **Invert and Activate**, and press **ENTER**. **Activate** uses the route as is. **Invert and Activate** reverses and starts the route.

If you highlight a route name from the Route List and press **NAV**, the name automatically appears.

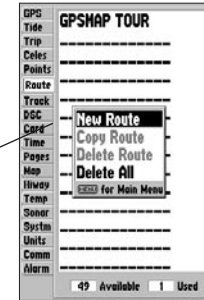

### To stop navigation of a route:

Press **NAV**, highlight **Stop Navigation**, and press **ENTER**.

### To copy or delete a route:

1. From the **Route List**, highlight the route you want to copy or delete using the **ROCKER**, and press **MENU**.
2. Choose either **Copy Route** or **Delete Route** and press **ENTER**. With **OK** highlighted, press **ENTER** again to confirm a deletion. Copy uses the same route name with an additional number, starting at 1, at the end of the route name.

### To delete all routes:

1. From the **Route List**, press **MENU**.
2. Highlight **Delete All**, and press **ENTER**. With **OK** highlighted, press **ENTER** again to confirm the deletion.



When you are on the Route Review Page, you can review the route points (waypoints or map items) one at a time from the list.

**To review individual route points:**

1. Highlight a point, and press **ENTER**.
2. On the waypoint review window, you can choose **Next** (highlight the next point on the route list), **Show Map** (show the point on a map window), **Delete** (permanently delete the waypoint from the unit), and press **ENTER**.

When you are back on the route point list, the next point in the route is automatically highlighted. This allows you to review each point on the route by pressing **ENTER** repeatedly.

GPSMAP TOUR		
Waypoint	Distance	Course
TOUR1	0.0 <sup>m</sup>	007 <sup>°</sup>
TOUR2	2.3 <sup>m</sup>	334 <sup>°</sup>
TOUR3	4.8 <sup>m</sup>	005 <sup>°</sup>
TOUR4	7.9 <sup>m</sup>	329 <sup>°</sup>
TOUR5	17.7 <sup>m</sup>	341 <sup>°</sup>
Edit on Map Add Before Remove Trip Planning (MENU) for Main Menu		
17.7 <sup>m</sup> 341 <sup>°</sup>		

**Route Review Options Menu**

**Route Review Menu Options**

Menu options available from the Route Review Page are Edit on Map, Add Before, Remove, and Trip Planning.

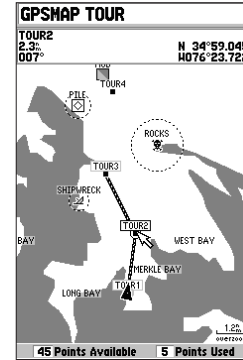

Highlight a point, and press **ENTER** to review it.

**Edit on Map**—allows you to review and modify the route shown for each point (waypoint or map item) on a map page. Use the pointer to insert a new route point on a route leg, review the waypoint, or map item.

**To edit the route on the map:**

From the Route Review Page, press **MENU**, highlight **Edit on Map**, and press **ENTER**.

**To edit a route point:**

Use the **ROCKER** to highlight a route waypoint, and press **MENU**.

**To review a route point:**

Highlight the point, and press **ENTER**. Press **ENTER** again when finished.

A menu of editing choices appear, with options for removing, moving (user waypoints only), or adding turns to the beginning or end of the route.

**To remove a route waypoint:**

Highlight the **Remove** option, and press **ENTER**.

**To move a route waypoint:**

1. Highlight the **Move** option, and press **ENTER**.
2. Move the pointer to the new map location, and press **ENTER**.

**To add turns at the beginning or end of the route:**

1. Select the first (to add waypoints to the beginning of the route) or last (to add waypoints to the end of the route) route waypoint with the map pointer, and press **MENU**.
2. Highlight the **Add** option, and press **ENTER**.
3. Move the pointer to the new point or location, and press **ENTER**.
4. If you are not inserting an existing waypoint, press **ENTER** to confirm the new waypoint.
5. Repeat steps 3 and 4 to insert additional waypoints, or press **QUIT** to finish.

The GPSMAP 198C Sounder's route edit mode also allows you to insert a new route waypoint in any route leg using the map pointer.

**To insert a new waypoint between two existing route waypoints:**

1. Use the **ROCKER** to select the leg you want to insert the new waypoint in (the route line is now highlighted and a dotted line appears when the leg is selected), and press **ENTER**.
2. Move the pointer to the new map location, existing waypoint, or map item (**ADD** is shown below the arrow and the route lines move with the arrow), and press **ENTER**.
3. If you are not inserting an existing point, press **ENTER** to confirm the new waypoint.

**Add Before**—inserts a waypoint into the list of route points or add a point(s) onto the end of the route.

**To insert a point into the route, or add a point to the end:**

1. From either the Route Review or Active Route Pages, use the **ROCKER** to highlight the point you want to insert the new point before (to add a point to the end, highlight the blank field at the bottom of the list), and press **MENU**.
2. Highlight **Add Before**, and press **ENTER**.
3. From the **Find** menu, highlight **Waypoints**, and press **ENTER**. (You can also choose from other points, such as Cities or Tide Stations from this list.) From either the **User** or **Nearest From Current Location** tab lists, choose the waypoint you want and press **ENTER** twice. (See [page 50](#) for searching for waypoints by name.)

Or

To select a waypoint from the map, highlight the **User** or **Nearest** tab and press **MENU**. With **Select From Map** highlighted, press **ENTER**. Use the zoom **IN** and **OUT** keys, and the **ROCKER** to highlight a waypoint on the map, and press **ENTER**.

Drag the route leg to an existing waypoint (shown), map item, or a blank spot on the map to create a new route point.

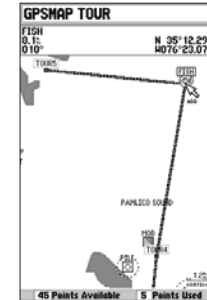

**Remove**—removes a point (waypoint or map item) from a route. This option is available from both the Route Review and Active Route Pages.

**To remove a point from a route:**

1. From either the Route Review or Active Route Pages, use the **ROCKER** to highlight the point to remove, and press **MENU**.
2. Highlight **Remove**, and press **ENTER**.

**Trip Planning**—the Route Review and Active Route Pages also show trip-planning information for each leg or the entire route. Available information includes Course, ETA, Fuel (to point), Leg Distance, Leg Fuel, Leg Time, Sunrise and Sunset (at point location), and Time To (point).

### To use the Trip Planning feature:

1. To select a planning field, highlight a route from the Route List, and press **ENTER** to show the Route Review Page.
2. One of nine available planning fields appears to the right of each route waypoint and its distance. Press left or right on the **ROCKER** to select an item.
3. To enter planning information, from the Route Review Page only, press **MENU**, and select **Trip Planning** from the options list. Enter the figures for Speed, Fuel Flow, Departure Time, and Departure Date. Press **QUIT** to return to the Route Plan Page.

GPSMAP TOUR												
Waypoint	Distance	Leg Dist										
TOUR1	0.0	2.3										
TOUR2	2.3	2.5										
TOUR3	4.8	3.1										
TOUR4	7.9	9.8										
<table border="1"> <thead> <tr> <th colspan="2">Trip Planning</th> </tr> <tr> <th>Speed</th> <th>Depart Time</th> </tr> </thead> <tbody> <tr> <td>0.0</td> <td>02:58</td> </tr> <tr> <th>Fuel Flow</th> <th>Depart Date</th> </tr> <tr> <td>0.0</td> <td>22-APR-01</td> </tr> </tbody> </table>			Trip Planning		Speed	Depart Time	0.0	02:58	Fuel Flow	Depart Date	0.0	22-APR-01
Trip Planning												
Speed	Depart Time											
0.0	02:58											
Fuel Flow	Depart Date											
0.0	22-APR-01											
		17.7 17.7										

Trip  
Planning  
Data Fields



***NOTE:** Fuel flow rates on your unit are measured in units per hour. System setting changes for units of measure (statute, nautical or metric) do not affect the fuel flow measure. You should enter fuel flow rates based on available information for your vehicle's (operator's manual, or performance specifications.) Make note of the units of measure (gallons or liters.)*

**Delete Route**—deletes a route from the Route List. Waypoints and map items are not deleted from unit memory.

### To delete a route:

1. From the Route Review Page, press **MENU**.
2. Highlight **Delete Route**, press **ENTER**, and press **ENTER** again to confirm the deletion.



## Track Tab

The Track tab specifies whether or not to record a track log, define how it is recorded, or save track log data for future use. The Track Logs Page also provides an indicator of the memory used for the active track log and options to clear the track memory or start a TracBack route. See pages 14 for TracBack information. The Track tab is divided in two sub tabs: Active and Saved.

### Active Sub Tab

The Active sub tab is for the active log (the log currently being recorded). It shows track memory used and current settings.

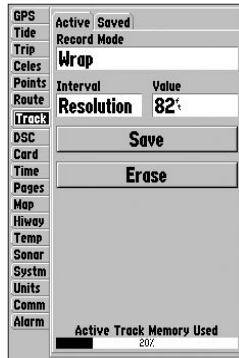

Active Track Tab

### Saved Sub Tab

The Saved sub tab shows and manages a list of any saved track logs, allows for TracBack activation, and Map Page of saved logs. The active log stores up to approximately 2,500 track log points, based on the criteria specified in the Track settings. Up to 15 track logs can be saved in memory, with up to 500 track log points in each saved log. A TracBack can be started from any of the saved tracks on this tab.

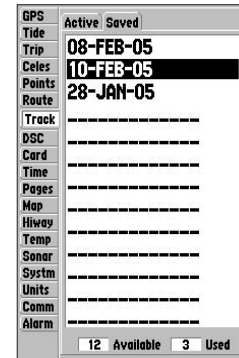

Saved Track Tab

For the Active tab, the following settings are available:

**Record Mode**—contains three track recording options:

- **Off**—the track log is not recorded. Selecting the Off setting prevents you from using the TracBack feature.
- **Fill**—a track log is recorded until the track memory is full.
- **Wrap**—records the track log is continuously recorded, wrapping through the available memory (replacing the oldest track data with new data).

**Interval**—defines the frequency the track plots are recorded. Three interval settings are available:

- **Distance**—records track based on a user-defined distance between points.
- **Time**—records track plot based on a user-defined time interval.
- **Resolution**—records track plot based on a user-defined variance from your course over ground. The resolution option is the default setting and is recommended for the most efficient use of memory and TracBack performance. The distance value (entered in the value field) is the maximum error allowed from the true course before recording a track point.

**Value**—defines the distance or time used to record the track log.

**Save**—saves the current active track log.

**Erase**—clears the active track log stored in memory.

For the Saved tab, the following menu options are available:

**Review On Map**—shows the saved track log on a Track Map Page.

**Delete Track**—deletes highlighted saved track log from memory.

**Delete All**—deletes all saved track logs from memory.

You can use the Review On Map option to show a saved track on a Track Map Page.

**To start a TracBack from the Saved tab list:**

1. Using the **ROCKER**, highlight a track, and press **NAV**.
2. The **Follow <track name>** automatically appears highlighted. Press **ENTER**.
3. Choose either **Original**, which navigates you from the end to the start of your trip, or **Reverse**, which navigates you from the start to the end of your trip, and press **ENTER**.

The track name automatically appears when highlighted on the Saved list and NAV is pressed.

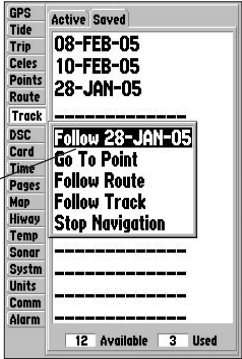

**DSC Tab**

Digital Selective Calling (DSC) uses marine VHF radio and Global Positioning System (GPS) technologies to transmit and receive location information. DSC is used by mariners to assist them in two major areas: Distress Calls and Position Reporting. See [page 22](#) and the “Appendix” for more information on DSC and using it with your GPSMAP 198C Sounder.

## Card Tab

The Card tab contains options for saving waypoints, routes and tracks to a data card. When data is saved to a data card, it can be exchanged with other compatible units and Garmin's MapSource PC program.

### To transfer data to/from a data card:

1. Insert the data card. From the **Card** tab, select the check box next to each type of item you want to transfer.
2. Highlight **Save To Card**, and press **ENTER** to save the selected items to the data card.
3. If transferring data from the card to the unit, highlight **Merge From Card**, and press **ENTER** to combine the selected items with those of your GPS. Highlight **Replace From Card**, and press **ENTER** to overwrite all selected items on your GPS.
4. A **Transfer Complete** message appears after the data is transferred. Press **QUIT**.

## Time Tab

The Time tab shows the current time and date, allows you to adjust the 12 or 24 hour time format, enter a time zone, and adjust for daylight saving time.

The following options are available:

- **Time Format**—choose from 12 or 24 hour (military) time format.
- **Time Zone**—choose your correct time zone to show correct local time or enter a UTC Offset. The UTC (also called Greenwich Time) offset is how many hours you are ahead or behind the time line.
- **Daylight Savings Time**—choose from Auto, On, or Off to adjust for daylight saving time.

## Pages Tab

The Pages tab allows you to turn on/off any of the main pages or Jump To a particular page. You can also set the page that appears first when you turn on the unit or enable/disable the GPS Info on the initial screen.

### To select or deselect a main page:

Use the **ROCKER** to highlight the box to the left of the page name. Pressing **ENTER** selects or deselects that page. When a page is selected, a check mark appears in the box. You must leave at least one page checked.

### To set the first page:

Use the **ROCKER** to highlight the **First page** option, and press **ENTER**. Highlight the page you want to appear first, and press **ENTER**.

You can also press **MENU**, choose from one of the following, and press **ENTER**:

- **All Pages**—selects all pages.
- **Chartplotter Only**—selects the Map Page only.
- **Nav Tools Only**—selects the Compass, Numbers, Highway, and Active Route Pages only.
- **Basic Fishfinder**—selects the Sonar Page only if equipped with a transducer.
- **Defaults**—selects all pages.

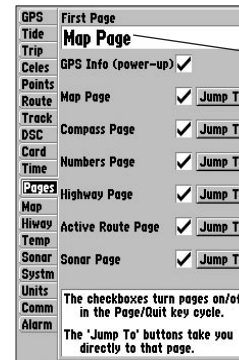

Pages Tab

## Map Tab

The Map tab changes the show properties of the Map Page.

The following pages contain descriptions of the Map tab's eight sub tabs.

### General Sub Tab

General	Source	Waypoints	Points
Detail	Normal		
Orientation	North Up		
AutoZoom	Off		
Color Mode	For Sun		

- **Detail**—Most, More, Normal, Less, Least: controls how much map detail is shown. This setting only applies to map features set to Auto. Features that have a specified zoom range or are turned off are unaffected by this setting.
- **Orientation**—North up: fixes the top of the Map Page to a north heading. Track up: fixes the top of the Map Page to the current track heading. Course up: fixes the map so the direction of navigation is always up.

- **AutoZoom**—On, Off: when On the map automatically adjusts the map zoom range to a lower range as you approach you destination point.
- **Color Mode**—For Sun, For Dark: controls colors change to correct for day and night lighting conditions.

### Source Sub Tab

General	Source	Waypoints	Points
Basemap	On		
Data Card Maps	On		
Data Card Maps			

- **Basemap**—On/Off: turns the built-in base map on or off.
- **Data Card Maps**—On/Off: turns all optional BlueChart/MapSource data loaded on the data card on or off. The Data Card Maps option box shows a list of the optional BlueChart/MapSource data loaded on the data card. Each area is described by name and can be deselected if you do not want to show the data on the Map Page.

### To show the Map Information Page:

1. Highlight the **Data Card Maps** option box, and press **ENTER**.
2. Use the **ROCKER** to scroll through the list of maps.
3. To select or deselect a map, highlight the check box to the left of the name of a map. Press **ENTER** to select or deselect the map. The map is selected and appears on the Map Page when a check mark appears in the box adjacent to that map.
4. To show detailed information and notes for each area, highlight a name, and press **ENTER**. To view the notes for that area, choose **Show Notes**. To scroll through the notes, highlight the notes, press **ENTER**, and use the **ROCKER** to scroll up, down, left, and right, or press **MENU** and choose a scroll option.



### Waypoints Sub Tab

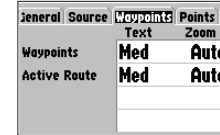

The Waypoints and Active Route options each contain adjustments for Text and Zoom.

- **Text**—None, Small, Medium, and Large: controls the screen size of the name.
- **Zoom**—Auto, Off, 120 ft-800 mi: sets the maximum zoom range features should appear on the Map Page. Some types of data only show up at specific zoom ranges.

## Points Sub Tab

Waypoints	Points	Nav aids	Nav Li
	Text	Zoom	
Spot Soundings	Small	On	
Tide Stations	None	Auto	
Services	None	Auto	

The Spot Soundings, Tide Stations, and Services options each contain adjustments for Text and Zoom.

- **Text**—None (except Spot Snd.), Small, Medium, and Large: controls the screen size of the name.
- **Zoom**—Auto, Off, 120 ft-800 mi: sets the maximum zoom range features should appear on the Map Page. Some types of data only show up to specific zoom ranges.

## Nav aids Sub Tab

Waypoints	Points	Nav aids	Nav Li
		Symbol Set	Auto
		Text Size	Med
		Light Sectors	Auto

- **Symbol Set**—Auto, Garmin, NOAA, International: controls a navaid symbol set.
- **Text Size**—Small, Medium, and Large: controls the screen size of the name.
- **Light Sectors**—Off, Auto, On: controls the drawing light sectors on the map.



## Nav Line Sub Tab

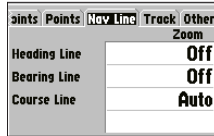

- **Heading Line**—On/Off: draws an extension from the end of the boat icon in the direction of travel.
- **Bearing Line**—On/Off: toggles the black/white line that points to the current navigation point.
- **Course Line**—Auto, Off, 120 ft-800 mi: sets the maximum zoom range the course line appears on the screen.

## Track Sub Tab

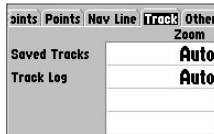

The Saved Tracks and Track Log options each contain adjustments for Zoom.

- **Zoom**—Auto, Off, 120 ft-800 mi: sets the maximum zoom range the feature should appear on the Map Page. Some types of data only show up to specific zoom ranges.

## Other Sub Tab

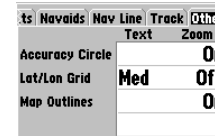

- **Accuracy Circle**—On/Off: toggles the circle On and Off. The circle represents the approximate accuracy of the unit based on EPE, DOP, and basemap quality. Your location is within the circle.
- **Lat/Lon Grid**—Text—None, Small, Medium, and Large: controls the screen size of the name. Zoom—Auto, Off, 120 ft-800 mi: sets the maximum zoom range the feature should appear.
- **Map Outlines**—On/Off: toggles the coverage boxes for BlueChart/MapSource data On and Off.

## Hiway (Highway) Tab

The Hiway tab contains screen settings for the Highway Page. Refer to the “Highway Page” section on [page 35](#).

## Temp (Temperature) Tab

The Temp tab screen the water temperature log. The temperature log requires input from a temperature transducer/sensor. The most recent temperature measured shows on the far right side of the chart with the history trailing to the left. The dotted lines within the chart indicate intervals in the temperature scale and the duration of time.

The following settings are available:

- **Temperature Scale**—controls the temperature range for showing the log. Select Auto to have the unit automatically determine the best range, or select a span of 2, 4, 6, 8, or 10 degrees.
- **Time Duration**—controls the number of temperature readings shown on the log. Shorter time durations shows a greater the number of log points. Use longer time durations to detect temperature trends, instead of immediate readings.

## Sonar Tab

The Sonar tab contains setup options for the Sonar Page. The Sonar Page is not active if you do not have a transducer connected. Refer to the “Using Sonar” section on [page 78](#) for more information on sonar setup options.

GPS	Fish Symbols	Water Type
Tide	Off	Salt
Trip		
Celes	Depth Number	Scale
Points	Fast Update	Overlay
Route	Color Bar	Flasher
Track	Off	Off
DSC		
Card	Keel Offset	
Time	0.0'	
Pages		
Map	Map Split Sonar Detail	
Hiway	Maximum Detail	
Temp	Temperature Graph	
Sonar	Off	
System	Background Color	
Units	Black	
Comm		
Alarm		

## System (System) Tab

The System tab controls system setting for beeper, speed filter, languages, system mode, and simulator controls, restores factory settings, shows software version, and prepares software update cards.

The following settings are available:

- **Beeper**—Off, Alarms Only, Key and Alarm: controls audible beeps for keys and alarms.
- **Speed Filter**—Off, Auto, On: averages speed-readings.
- **Language**—shows the on-screen languages.
- **System Mode**—sets Normal or Simulator Mode.
- **Set Position\***—sets your location while in Simulator Mode. See page 3 for additional instructions.
- **Track Control\***—Auto Track, User Track: controls your heading in Simulator Mode.
- **Track\***—sets your heading in Simulator Mode.
- **Speed\***—sets your speed in Simulator Mode.
- **Transducer\***—sets a transducer type.

\* These fields are only available when the unit is in Simulator Mode.

The following options are also available from the System tab:

- **System Information**—shows the unit's software, basemap version, and electronic serial number.
- **Prepare SW Update Card**—prepares a data card to accept software updates from your computer through the data card programmer.

Press **MENU** for the following options:

- **Defaults**—restores settings on System page to default values.
- **All Unit Defaults**—restores all settings to Garmin's original setup values for the entire unit.

## Units Tab

The Unit tab defines the Position Format, Map Datum, Heading, Distance, Speed, Elevation, Depth, and Temperature units.

The following settings are available:

- **Position Format**—changes the coordinate system. You should only change the position format if you are using a map or chart that specifies a different position format or want to use a format you are familiar with.

For additional information on Loran TD setup, see page 109.



**NOTE:** The Units tab settings affects how navigation information appears on the GPSMAP 198C Sounder. When in doubt, seek assistance. If you are using a map or chart in conjunction with your GPS, make sure the settings under the Units tab of the GPSMAP 198C Sounder match that of the map or chart. This information should appear somewhere on the map or chart. If the information is not present, contact the map or chart maker to determine what position format, datum, heading and units of measure are being used for the map or chart.



**WARNING:** Selecting the wrong map datum can result in substantial position errors. Unless otherwise specified by the navigation documentation you are using, use the default WGS 84 datum for best overall performance.

- **Map Datum**—sets the datum reference used to determine a given location. The default setting is WGS 84. The unit automatically chooses the best datum depending on your chosen position format. Datums are used to describe geographic locations for surveying, mapping, and navigation. You should only change the datum if you are using a map or chart that specifies a different datum.

GPS	Position Format
Tide	hddd' mm.mmm'
Trip	
Celes	Map Datum
Points	WGS 84
Route	Heading
Track	Auto Mag Var 003°E
DSC	
Card	Distance, Speed and Elevation
Time	Nautical (nm, kt, ft)
Pages	
Map	Depth
Hwyay	Feet (ft)
Temp	Temperature
Sonar	Fahrenheit (°F)
System	
<b>UNITS</b>	
Comm	
Alarm	

- **Heading**—selects the reference used in calculating heading information. You can select from Auto Mag Var, True, Grid, and User Mag Var. Auto Mag Var provides magnetic north heading references that are automatically determined from your current location. True provides headings based on a true north reference. Grid provides headings based on a grid north reference (and is used in conjunction with the grid position formats described on [page 70](#)). User Mag Var allows you to specify the magnetic variation at your current location and provides magnetic north heading references based on the variation you enter.

#### To enter a user defined magnetic variation:

1. With the **Heading** field set to **User Mag Var**, highlight the heading reference field (immediately to the right), and press **ENTER**.
2. Use the **ROCKER** to enter the magnetic variation at your current location and press **ENTER**.



**WARNING:** If **User Mag Var** is selected, you must periodically update the magnetic variation as your location changes. Using this setting, the unit does not automatically calculate and update the magnetic variation at your present location. Failure to update this setting can result in substantial differences between the information shown on your unit and external references, such as a magnetic compass.

GPS	Position Format
Tide	hdd°mm.mmm'
Trip	
Celes	Map Datum
Points	WGS 84
Route	Heading
Track	User Mag Var 010E
DSC	
Card	Distance, Speed and Elevation
Time	Nautical (nm, kt, ft)
Pages	Depth
Map	Feet (ft)
Hiway	
Temp	Temperature
Sonar	Fahrenheit (°F)
System	
Units	
Comm	
Alarm	

Manually enter a magnetic variation.

- **Distance, Speed and Elevation**—allows you to select the units of measure for distance, speed, and elevation readouts in Nautical (nm, kt, m), Statute (mi, mh, ft), or Metric (km, kh, m) terms.
- **Depth**—allows you to select the units of measure for depth in Feet (ft), Fathoms (fa) or Meters (m).
- **Temperature**—allows you to select the units of measure for temperature in Fahrenheit (°F) or Celsius (°C).

## Comm (Communications) Tab

The Comm tab controls the input/output format used when connecting your GPSMAP 198C Sounder to external NMEA devices, a DGPS beacon receiver, a personal computer, or another Garmin unit.



---

***NOTE:** If a DGPS receiver is used, WAAS capability is automatically turned to Off. See [pages 99 and 100](#) for wiring and NMEA version information.*

---

The unit supports two input/output ports.

### Port 1

- **Garmin Data Transfer**—is the proprietary format used to upload/download MapSource data, exchange waypoint, route, track, almanac, and proximity data with a PC or another Garmin unit. When you select Garmin Data Transfer, there are 11 Transfer Modes to choose from: Host, Request Almanac, Request Proximity, Request Routes, Request Tracks, Request Waypoints, Send Almanac, Send Proximity, Send Routes, Send Tracks, and Send Waypoints.
- **NMEA In/NMEA Out**—supports the input/output of standard NMEA 0183 data, and sonar NMEA input support for the DPT, MTW and VHW sentences.
- **None**—provides no interfacing capabilities.

### Port 2

- **Garmin DGPS**—supports connections with a Garmin DGPS beacon receiver.
- **Other DGPS**—supports DGPS input using a standard RTCM format, without any output capabilities.
- **NMEA In/NMEA Out**—supports the input/output of standard NMEA 0183 data, and sonar NMEA input support for the DPT, MTW and VHW sentences. You can also adjust the NMEA output.
- **RTCM In/NMEA Out**—supports Differential GPS (DGPS) input using a standard RTCM format and also provides NMEA 0183 output.
- **None**—provides no interfacing capabilities.

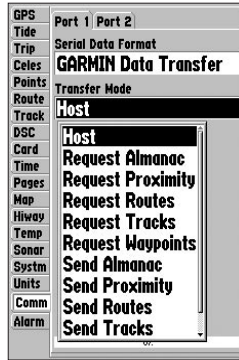

When transferring data between two Garmin units, always set one to Host and use the other unit to either Send or Request the data.

### To select a transfer mode:

1. Use the **ROCKER** to select **Garmin Data Transfer** in the **Serial Data Format** field.
2. Highlight the **Transfer Mode** field, and press **ENTER**.
3. Use the **ROCKER** to select a setting, and press **ENTER**.

Advanced NMEA settings to adjust the NMEA output are available if you have one of the ports set to NMEA In/NMEA. Advanced NMEA settings enable/disable certain sentences and adjust the number of Lat/Lon output precision digits. Settings affects both Port 1 and Port 2 NMEA outputs.

### To select an input/output format:

1. Select **Port 1** or **Port 2**, highlight the **Serial Data Format** field, and press **ENTER**.
2. Use the **ROCKER** to select a setting, and press **ENTER**.

### To adjust the NMEA output:

1. From the **Comm** tab, press **MENU**, highlight **NMEA Setup**, and press **ENTER**.
2. Highlight an option, and press **ENTER**.
3. Use the **ROCKER** to select a setting, and press **ENTER**. Press **QUIT** to return to the **Comm** tab.

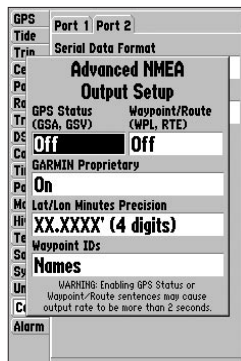

Advanced NMEA Output  
Setup Page

### To restore the Serial Data Format settings back to the default Garmin Data Transfer:

From the **Comm** tab, press **MENU**, highlight **Defaults**, and press **ENTER**.

If **Garmin DGPS** or **RTCM In/NMEA Out** format is selected, additional fields are provided to control a Garmin differential beacon receiver directly from your GPSPMAP 198C Sounder. The unit can automatically scan for the DGPS beacon signal, or you can enter the beacon frequency and bit rate on the unit and the information is used to tune the beacon receiver.

### To have the unit automatically scan for a frequency:

1. With the unit set to **Garmin DGPS** or **RTCM In/NMEA Out**, use the **ROCKER** to highlight the **Beacon** field, and press **ENTER**.
2. Highlight **Scan**, and press **ENTER**. The numbers in the **Frequency** field changes as the unit scans from 284 kHz to 325 kHz, 200 bit rate, then 100 at 6-second intervals.



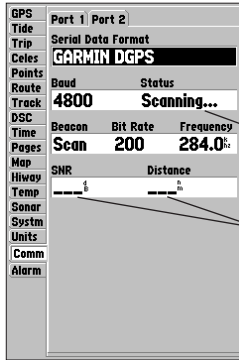

Status Field

SNR and Distance shows data when signal is received.



**NOTE:** The DGPS beacon transmitters are operated by the U.S. Coast Guard (or similar government agency in other countries), and are responsible for their accuracy and maintenance. For DGPS transmitter problems or to find the most updated list of frequencies and coverage areas, contact your local USCG, or see their Web site at <http://www.navcen.uscg.mil/>.

### To restart the scan:

Press **MENU**, highlight **Restart Scan**, and press **ENTER**.

### To manually enter a frequency and bit rate:

1. With the unit set to **Garmin DGPS** or **RTCM In/NMEA Out**, use the **ROCKER** to highlight the **Beacon** field, and press **ENTER**.
2. Highlight **User**, and press **ENTER**.
3. Highlight the **Frequency** or **Bit Rate** field, press **ENTER**, enter a frequency or bit rate, and press **ENTER** when finished.

The Status field shows one of the following:

- **Tuning**—the unit is attempting to tune to the specified frequency and bit rate.
- **Scanning**—the unit is automatically scanning through the frequencies and bit rates.
- **Receiving**—the unit is receiving DGPS signal and ready for operation.
- **Check Wiring**—the unit is not making connection with DGPS receiver.

When the unit is receiving a DGPS signal, the SNR (Signal to Noise Ratio) and Distance fields show data. The SNR range is 0dB to 30dB, with 30 being the best. The Distance can or can not show data, depending on the signal being broadcast from the DGPS site.

## Alarm Tab

The Alarm tab allows you to define the alarm settings. The Alarm tab is divided into three sub tabs: System alarms, Nav alarms, and Sonar alarms.

### System Sub Tab

- **Clock**—provides an alarm for the system clock. Enter a time in the time field, and turn the alarm on and off from the control field menu. Remember to enter alarm times in the same time format (UTC or local) you are using for your system. The unit must be on for the clock alarm to work.
- **Battery**—sets an alarm to sound when the battery is reaching a critical state of discharge.
- **DGPS and Accuracy**—DGPS alarm sounds when the unit loses a differential fix. The accuracy alarm sounds when the GPS position accuracy falls outside the user-set value.

### Nav Sub Tab

- **Anchor Drag**—sets an alarm to sound when you have exceeded a specified drift distance. Enter a value in the distance field, and use the control field to turn the alarm on and off.

- **Arrival**—sets an alarm to sound when at specified distance or time away from a destination waypoint. Enter a distance radius or time for sounding the alarm and use the control field to set the alarm to **Off**, **Dist** (Distance), or **Time**.
- **Off Course**—sets an alarm to sound when you are off the course by a specified distance. Enter a distance in the distance field and use the control field to turn the off course alarm on and off.

### Sonar Sub Tab

You must be receiving sonar NMEA data for these functions to work. See “Using Sonar” [page 78](#) for more information.

- **Shallow Water/Deep Water**—set alarms to sound when you enter an area of specified depth that is too shallow or too deep. Enter a depth in the distance fields and use the control fields to turn the alarms on and off.
- **Water Temperature**—sets an alarm to sound when the transducer reports a temperature either above, below, inside, or outside the specified values.
- **Fish**—sets alarm to sound when unit detects a fish of the specified symbol size.

**To set an alarm:**

1. Use the **ROCKER** to highlight a sub tab.
2. Highlight the field you want to start, and press **ENTER**.
3. Change the mode to the setting, and press **ENTER**.
4. Highlight the next field to the right, press **ENTER**, enter settings, and press **ENTER** to finish.
5. If you want the alarm to appear and beep until acknowledged, highlight the **Persist** box, and press **ENTER**.

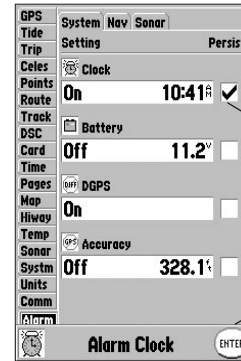

If **Persist** is checked, an alarm stays active until acknowledged.

Press **ENTER** to acknowledge an alarm.

## USING SONAR

This section covers the additional sonar options for the GPSMAP 198C Sounder when used in conjunction with a transducer. Read the *Installation Instructions* to properly install the transducer.



**NOTE:** You **MUST** have a transducer installed and connected to your GPSMAP 198C Sounder to use the sonar features.

## Sonar Page

The Sonar Page is where your GPSMAP 198C Sounder becomes a powerful fishfinder/flasher. To view the Sonar Page, press **PAGE** or **QUIT** repeatedly until it shows. Fish are shown as colored arches or as fish icons. Both fish icons and arches appear in three different sizes. Thermoclines are shown as shades of blue. The area of strongest sonar return shows as solid white (if Whiteline is active). Typically, the bottom is the primary whiteline. A thin whiteline indicates a soft bottom and a thick whiteline follows the contour of the bottom and show any objects of reasonable size. For more information on understanding sonar and the screen, see [page 89](#).

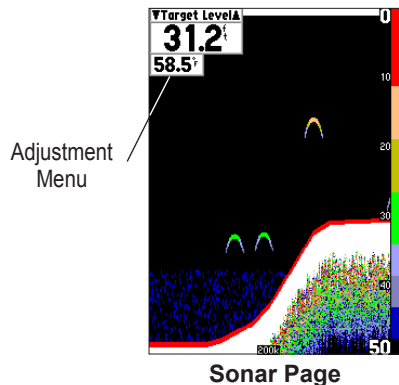

## Using the Adjustment Menu

The Adjustment Menu gives you direct access to the settings and features most commonly used on the Sonar Page. The option selected currently appears in the upper left of the screen.

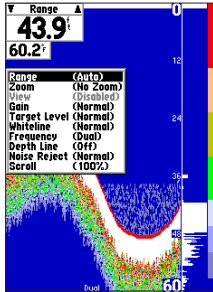

Press **MENU** and highlight **Adjustments** to see a list of all options and their current settings.

### To select an adjustment option from the Sonar Page:

1. Press the **ROCKER** left or right to scroll through the options in the upper left of the screen.
2. Press **ENTER** to access the option's adjustment window.

Or

1. Press **MENU**, highlight **Adjustments** and press **ENTER**. A list of all options and their current settings appears, with the selected option highlighted.

2. Press up or down on the **ROCKER** to select the option, and press **ENTER** to access the adjustment window
3. To exit any of the adjustment options, press **QUIT**.

### To change an Adjustment Menu setting:

1. Select an adjustment option to change using one of the two methods described previously. The adjustment window automatically times out and disappears when the unit is idle for 20 seconds.
2. Press the **ROCKER** up or down to place the pointer or setting bar at the setting, range, or percentage (Off, 1-100%).
3. Press **ENTER** or **QUIT** to exit the adjustment window, or press left or right on the **ROCKER** to view another adjustment window.

### To change a setting back to Normal or Auto:

1. While on the adjustment window for the option, press **MENU**.
2. Select the setting, and press **ENTER**.

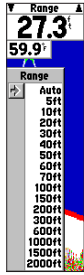

Range Adjustment

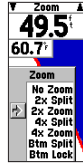

Zoom Adjustment

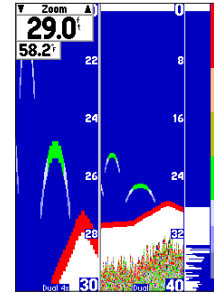

4X Split Zoom (Dual Frequency Mode)

**Range**—sets the screen depth range used for viewing. The unit can be set to automatically track the bottom or set to a user-specified depth range. Auto mode shows the most information possible while continuously showing the bottom.

**Zoom**—used to quickly select a screen zoom scale or split the screen. When a scale other than **No Zoom** is selected, the Adjustment Menu shows a new selection labeled **View**. The Zoom setting is divided into six levels:

- **2X Split**—shows two reduced-size sonar pictures at the same time. The right half of the screen shows the complete sonar picture at its original scale. The left half shows a portion of the original picture at 1/2 depth scale.
- **2X Zoom**—shows the 2X zoomed picture on the full screen and does not show the original depth scale.
- **4X Split**—shows two reduced pictures; the right at the original depth scale and the left at 1/4 the original depth scale.
- **4X Zoom**—shows only the 4X zoomed picture on the full screen. However, if Dual Frequency screen is set to Split, then a 50/200kHz split screen shows.

- **Btm (Bottom) Split**—shows two reduced pictures; the right at the original depth scale and the left showing sonar returns from the bottom up. All target depths read as a distance from the bottom.
- **Btm (Bottom) Lock**—shows only the Bottom Lock picture (returns from the bottom up) on the full screen. However, if Dual Frequency Screen is set to Split, then a 50/200kHz split screen shows.

When started, the zoomed picture becomes the Sonar Page. You can also cycle through the sonar zoom levels by pressing the **IN** or **OUT** keys. The Zoom function can be stopped by pressing the **OUT** key until the No Zoom setting appears.

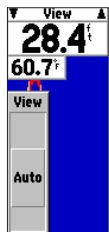

**View Adjustment**

**View/Span**—available when a Zoom scale other than No Zoom is selected. The View or Span setting is used to change the viewing range of a zoomed screen. If the Zoom is set to 2X split or 4X split, only the zoomed portion on the left side of the screen is affected by the change. If the Zoom is set to Bottom Split or Bottom Lock, Span adjusts how far off the bottom the unit shows data. In Zoom mode, you can control the view of the left side of the split.

**Gain**—allows you to control the sensitivity of the unit’s receiver. This provides some flexibility in what is seen on the screen. To see more detail, increase the receiver sensitivity by selecting a higher gain percentage. If there is too much detail or if the screen is cluttered, lowering the sensitivity can increase the clarity of the screen.

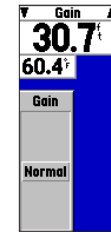

**Gain Adjustment**



**Target Level Selection**

**Target Level**—adjusts how dark or light a return (or target) is shown on-screen. A Color Bar (see page 86) appears on the right side of the screen as you adjust this setting. The higher the percentage, the darker the return appears. This setting does not increase or decrease the unit Gain.

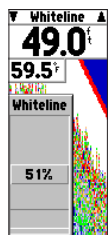

**Whiteline Adjustment**

**Whiteline**—controls how the unit shows information about the bottom type (hard or soft). With the Whiteline Off, the bottom return shows as red and contains no information on bottom hardness. With Whiteline set at Normal or 1-100%, the bottom return becomes white with a red line indicating where the water meets the bottom. To turn the Whiteline Off, press the **ROCKER** down until the setting bar is all the way at the bottom of the range and reads Off. See [page 91](#) for more detail on this feature.

**Frequency**—allows you to choose a transducer frequency. Frequency refers to the pitch of the sound that the transducer sends and receives. You can choose 200kHz, 50kHz, or Dual frequency.

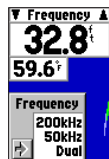

**Frequency Adjustment**

**Depth Line**—adds a horizontal depth line across the screen that is used to measure the depth of underwater objects. The depth of the line appears in a box on the right side of the line. Press up or down on the **ROCKER** to control the position of the line on the graph. The depth shows in a window on the right side of the line. To turn the Depth Line Off, press the **ROCKER** up until the setting bar is all the way at the top of the range and reads Off.

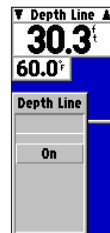

**Depth Line Adjustment**

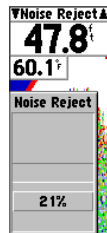

**Noise Reject Adjustment**

**Noise Reject**—helps filter unwanted noise from the graph. The Noise Reject tool can be turned Off, set to Normal (automatically adjusts for optimum viewing), or to a fixed 1-100% setting. When setting the Noise Reject tool: the HIGHER the noise rejection setting, the less likely the unit is to NOT show fish or structure. To turn the Noise Reject Off, press the **ROCKER** down until the setting bar is all the way at the bottom of the range and reads Off.

**Scroll**—adjusts the rate that the graph scrolls from right to left. If you are sitting still or the graph is moving too fast, slowing the scroll rate or pausing it can be beneficial.

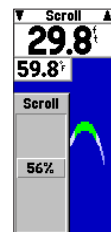

**Scroll Adjustment**



## Sonar Page Options

The GPSMAP 198C Sounder's Sonar Page features a menu that provides access to additional functions and to layout and data field options.

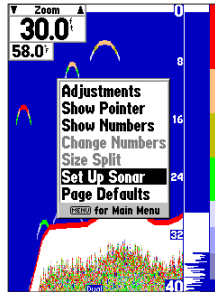

Sonar Page Menu Options

### To show the Sonar Page options:

Press **MENU**.

### To select a menu option:

Use the **ROCKER** to highlight the option, and press **ENTER**.

The following options are available:

**Adjustments**—lists the Adjustment Menu options and their current settings (see [page 79](#)).

### To change an Adjustment setting:

1. While on the **Adjustment options** list, use the **ROCKER** to highlight the option, and press **ENTER**.
2. Use the **ROCKER** to make the change, and press **ENTER**.

**Show/Hide Pointer**—allows you to reference sonar items and mark underwater waypoints. This makes it easier to find and use an object such as a stump for a future fishing location. When using this feature, the Sonar Page pauses. The pointer does not move off the paused screen and cannot show an area that has scrolled off the screen. The depth is updated while the screen is paused, but the unit does not show any new sonar data until the standard Sonar Page is resumed. You can see a discontinuity from where the sonar information stops to where it starts again.

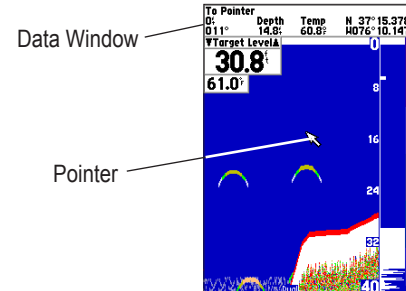

Show Pointer Option

**To mark an underwater waypoint:**

1. From the Sonar Page, press **MENU**, highlight **Show Pointer**, and press **ENTER** to pause the screen movement.
2. Use the **ROCKER** to move the cursor onto the target, such as underwater drop offs and stumps, you want to mark. The data window at the top of the screen shows the cursor's depth, coordinates, bearing and distance from your current position.
3. Press **ENTER/MARK**. The New Waypoint Page appears with the waypoint's coordinates, default three-digit name, and pointer depth automatically filled in.
4. To change the name, symbol or depth, highlight the appropriate field and press **ENTER**. Make your changes and press **ENTER** when finished.
5. When finished, highlight **OK**, and press **ENTER**.
6. To return to the standard Sonar Page, press **QUIT**; or press **MENU**, highlight **Hide Pointer**, and press **ENTER**.

**Show/Hide Numbers**—toggles showing/hiding the data fields on the Sonar Page.

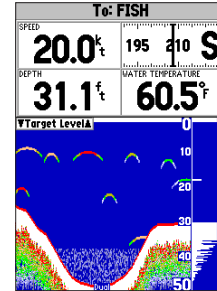

**Show Numbers Option**

**Change Numbers**—allows you to specify the type of data shown in each data field. For detailed instructions on changing the data fields, see [page 31](#).

**Size Split**—enables width adjustment of the Sonar Page split screen. This option is available only when a split screen zoom scale is selected. You can adjust the size of the split window anywhere from 1/4 to 3/4 width of the right half of the Sonar Page.

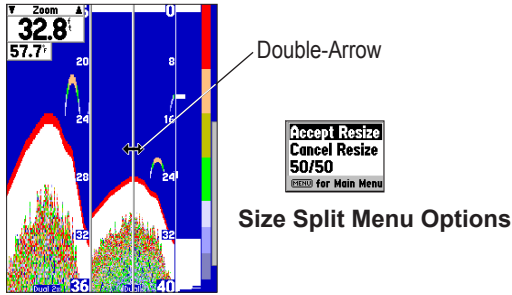

Resizing the Split Sonar Page

## Sonar Tab Options

To access and change a setting on the Sonar tab:

1. Press **MENU** twice to access the Main Menu. Use the **ROCKER** to highlight the Sonar tab.
2. Using the **ROCKER**, highlight the field, and press **ENTER**.
3. Highlight the setting, and press **ENTER**.
4. Press **QUIT** to return to the Sonar Page or a previous page.

**Fish Symbols**—allows you to determine how the graph shows underwater targets and background information. If fish symbols are set to Off, the unit shows all available information about the underwater environment. If a fish symbol is selected, the graph shows only the information related to that symbol. Actual fish returns can not always appear as perfect arches (like in Simulator Mode), due to the speed, fish orientation, or other conditions.

**Off**

Fish Symbols Off— All available information is shown.



Suspended targets show as fish symbols. Background information is shown.



Same as above with the target depth attached.



Suspended targets show as fish symbols. No background information is shown.



Same as above with target depth attached.

**Water Type**—because sound waves travel through fresh and salt water at different rates it is necessary to select the water type to ensure accurate readings on the unit.

**Depth Number**—controls the efficiency of the digital depth update rate. Fast Update updates more quickly and is recommended for low-noise, deeper water (>50 ft) Auto is best for shallow water or high noise areas, and produces a slower screen update. Use Auto when you travel a wide variety of depths.



***NOTE:** If the unit is unable to track the bottom for any reason, the digits in the depth window flash on and off to alert you that the unit is not tracking the bottom.*

GPS	Fish Symbols	Water Type
Tide	Off	Salt
Trip		
Celes	Depth Number	Scale
Points	Fast Update	Overlay
Route	Color Bar	Flasher
Track	Off	Off
DSC		
Card	Keel Offset	
Time	0.0'	
Pages		
Map	Map Split Sonar Detail	
View	Maximum Detail	
Temp	Temperature Graph	
Cont	Off	
System		
Units	Background Color	
Comm	Black	
Alarm		
	Calibrate Water Speed	

**Main Menu—Sonar Tab**

**Scale**—controls the depth Scale shows vertically along the right side of the graph. The depth Scale can be configured to show four different ways: as an Overlay, in the Corners, with Basic, or No Scale.

**Color Bar**—shows a gradient scale of the current Target Level setting (see [page 81](#)).

Depth Scale (Overlay)

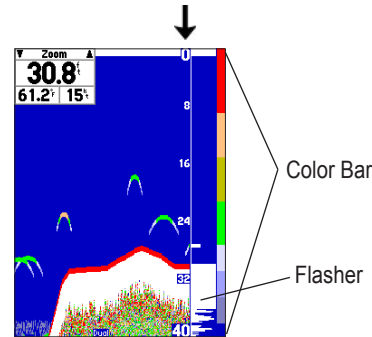

**Flasher**—with the Flasher active, a graphic Flasher representation shows on the far right side of the graph. This graphic Flasher shows structure and bottom returns much the same as a true Flasher. This feature is particularly useful when using Fish Symbols.

**Keel Offset**—used to offset the surface reading for the depth of a keel. This makes it possible to measure depth from the bottom of your keel instead of from the transducer’s location. Enter a positive number to offset for a keel, or enter a negative number to compensate for a large vessel that can draw several feet of water. The Keel Offset reflects in the depth reading.

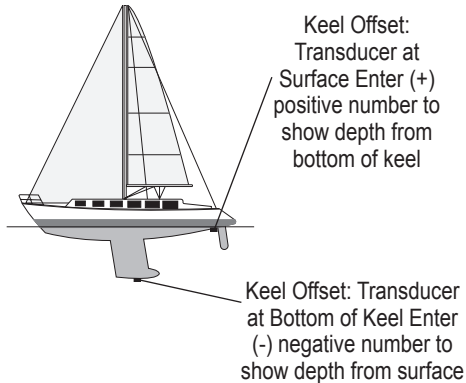

**Map Split Sonar Detail**—controls Map Page sonar split range scale. Full Range shows the entire scale of 2X or 4X left side split of Sonar Page. Maximum Detail shows what is shown on the left side of a split sonar screen.

**Background Color**—sets the background color on the Sonar Page to Black, Blue, or White.

**Calibrate Water Speed**—this is only available if you are using a speed-capable transducer/sensor. Calibration is required to ensure the Water Speed shown on your unit is accurate. The unit automatically use the GPS ground speed, if it is available, for comparison on the calibration. If a GPS ground speed is not available, use either your boat’s speedometer reading (not always accurate) or a stopwatch to determine your speed over a certain distance (distance / time = speed). It is recommended that the calibration take place in water having little or no current.

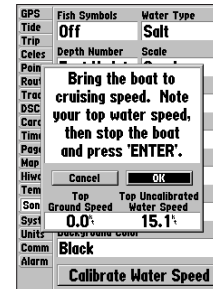

Calibrating the Speed Sensor

### To calibrate the water speed:

1. On the **Sonar** tab, use the **ROCKER** to highlight **Calibrate Water Speed** and press **ENTER**.
2. Bring the boat to a cruising speed. The top ground and uncalibrated water speeds are shown at the bottom of the calibration window. Note your top water speed, then stop the boat and press **ENTER**.
3. By default, the top ground speed automatically shows in the **What was your top water speed?** field. If a ground speed is not available, the top uncalibrated water speed is used instead. If the new speed is correct, highlight **OK** and press **ENTER**. If you want to manually enter a calibration, press **ENTER** on the speed field, enter a new speed, and then press **ENTER**.
4. You can also press **MENU** on the calibration screen and choose **Use Top Ground Speed** to default back to ground speed or **Use No Calibration** to use the speed sensor's uncalibrated speed.



---

***NOTE:** If the boat is not moving fast enough or the speed sensor is not outputting a speed, the message “Boat Is Not Moving Fast Enough To Calibrate” appears at the bottom of the screen. Either verify the speed sensor wheel is moving, or safely increase boat speed. If there is a problem with the speed sensor/unit, or if a speed sensor is not installed, a “Water Speed Sensor Is Not Working” message appears at the bottom of the screen. Check connections of speed sensor cables.*

---

**Page Defaults**—restores the Sonar Page settings to the original factory setup.

#### To restore default settings to the Sonar Tab:

1. Press **MENU**.
2. Highlight **Page Defaults**, and press **ENTER**.

#### To restore default settings to the Sonar Tab:

Press **MENU**. With **Page Defaults** highlighted, press **ENTER**.

## Understanding Sonar

The transducer mounted on your vessel transmits sound waves toward the bottom of a lake, stream, or seabed in a cone-shaped pattern. When a transmitted sound wave strikes an underwater object—such as the bottom, a piece of structure, or a fish—sound is reflected back to the transducer. The transducer collects the reflected sound waves and sends the data to the GPSMAP 198C Sounder to process and show. The underwater data is shown on the Sonar Page in the order that it is returned: first returned is the first on the screen.

Generally speaking, if the only thing between the transducer and the bottom is water, the first strong return comes from the bottom directly below the transducer and sets the bottom level. Weaker secondary returns provide the detailed data. Stronger returns show in darker colors, with red being the strongest return.

## Understanding the Sonar Screen

One of the first things to understand about sonar is that the transducer sends a beam down to the bottom of the water, much like the beam of a flashlight. The beam starts small near your vessel and expands as it gets to the bottom. Refer to “Transducer Coverage” for more detailed information.

The Sonar Page does not show a three-dimensional representation of the underwater environment; the screen is in two-dimensions, much like if you took a picture of an aquarium. Only the depth of the item in the water is shown. The Sonar screen does not show you where an item is located horizontally in the water, as shown in the drawings below. The fish is not directly above the tree in reality, but it can look like it is on the Sonar Page.

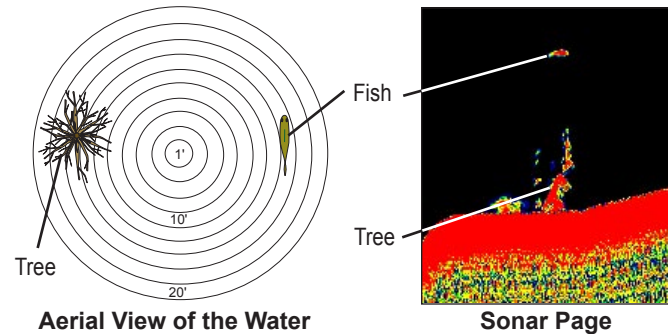

## Transducer Coverage

The area covered by the transmitted sound waves is determined by the cone angle of the transducer and the water depth. The wide cone angles ( $40^\circ$ ) associated with low frequencies (50 kHz) provide a large coverage area for finding fish within a coverage width that is approximately  $2/3$  of the water depth. However, this also means that wide cone angles produce less bottom detail and resolution. As shown in the drawing on the near right, the  $40^\circ$  cone angle produces a coverage area of approximately a 20-foot diameter circle at a 30-foot depth.

The narrow cone angles ( $10^\circ$ ) associated with the high frequencies (200 kHz) provide better bottom resolution and crisper detail, but cannot show a large coverage area for finding fish. The  $10^\circ$  cone angle provides a coverage width that is approximately  $2/10$  of the water depth. As shown in the drawing on the far right, the  $10^\circ$  cone angle produces a coverage area of approximately a 6-foot diameter circle at a 30-foot depth.

Dual frequency mode combines both frequencies to get the best coverage area and contour/depth readings.

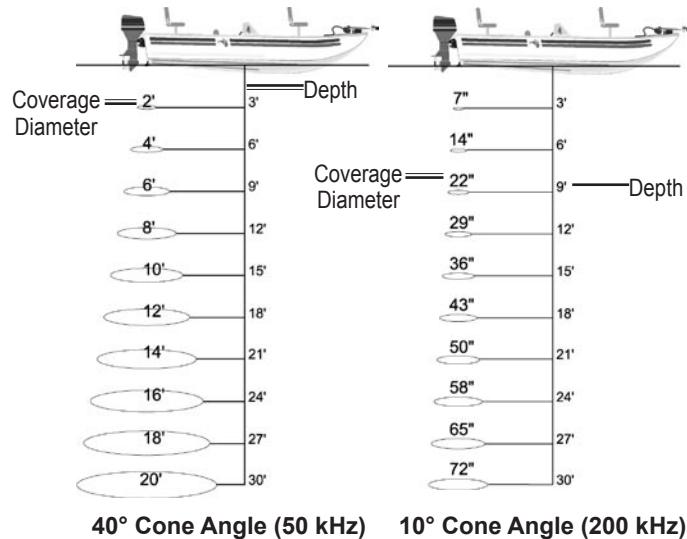



## Whiteline

When the sonar sound waves are reflected back by the bottom, a hard bottom returns a stronger signal than a soft bottom. A thin whiteline indicates a softer bottom, while a thick whiteline indicates a harder bottom. Normally, a red line is used to show the point where water meets the bottom. This line follows the bottom contour, along with any significant objects lying on the bottom. The unit uses the whiteline function to make the bottom layer information easier to distinguish.

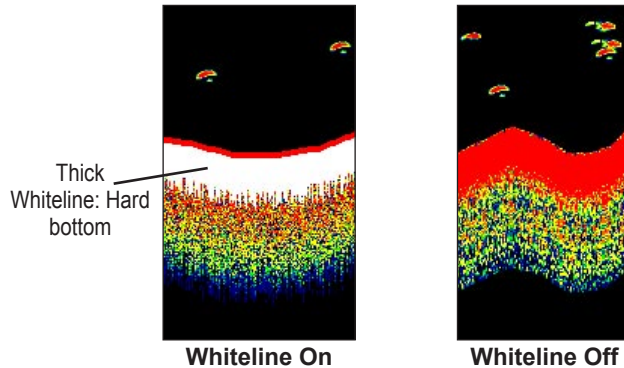

## Thermoclines

A rough definition of a thermocline is a break in water where the water temperature changes faster than the water above it. Thermoclines are shown as the weakest colors.

One of the unique features offered by Garmin is See-Thru<sup>®</sup> technology, which allows the GPSMAP 198C Sounder to hear both weak and strong signals simultaneously so as to identify fish returns under the toughest conditions, such as suspended in thermoclines or even hiding near structures. See-Thru technology allows the transducer to see through thermoclines and locate fish.

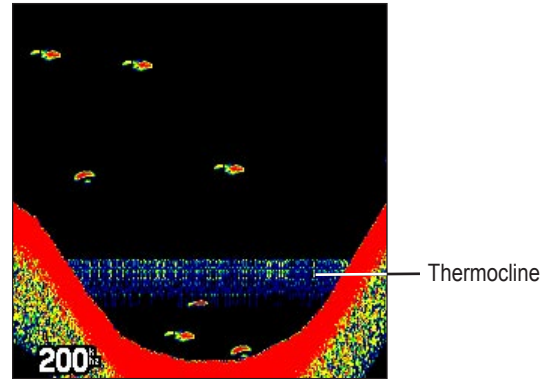

## APPENDIX

### Specifications Physical Specifications

**Size:** 6.2" H x 6.30" W x 3.7" D (15.7 cm x 16.0 cm x 6.7 cm)

**Weight:** Less than 2.0 lb

**Display:** 5.0" diagonal (12.7 cm) 16-color TFT display with backlighting (234 x 320 pixels)

**Case:** Fully gasketed, high-impact plastic alloy, waterproof to IEC 529-IPX-7

**Temp. Range:** 5°F to 158°F (-15°C to 70°C)

### Performance

**Receiver:** Differential-ready 12 parallel channel WAAS capable receiver

### Acquisition Times:

**Warm:** Approx. 15 seconds

**Cold:** Approx. 45 seconds

**AutoLocate:** Approx. 2 minutes

**Update Rate:** 1/second, continuous

### GPS Accuracy:

**Position:** <15 meters (49 feet), 95% typical\*

**Velocity:** 0.05 meters/sec steady state

### DGPS (USCG) Accuracy:

**Position:** 3-5 meters (10-16 feet) with optional Garmin DGPS receiver, 95% typical\*

**Velocity:** 0.05 meters/sec steady state

### DGPS (WAAS) Accuracy:

**Position:** <3 meters (10 feet), 95% typical\*

**Velocity:** 0.05 meters/sec steady state

**Dynamics:** 6gs

\* Subject to accuracy degradation to 100 m 2DRMS under the U.S. DOD-imposed Selective Availability Program.

### Power

**Source:** 10-32 V DC

**Usage:** 14 watts max. at 13.8 vDC

**Fuse:** AGC/3 AG-3 Amp

### Sonar

**Sounder Power:** 500 watts (RMS)  
4000 watts (peak to peak)

**Frequency:** 50/200 kHz (40°/10°)

**Depth:** 1500 foot max depth\*

\* Depth capacity is dependent on water salinity, bottom type, and other water conditions.

## Installing the GPSMAP 198C Sounder

The GPSMAP 198C Sounder must be properly installed according to the following instructions to get the best possible performance. To complete the installation, you need the appropriate fasteners and a 1" x 14-thread marine antenna mount available at most marine dealers.

### Mounting the GPS Antenna

The antenna should be mounted in a location that has a clear, unobstructed view of the sky in all directions to ensure the best reception. Avoid mounting the antenna where it is shaded by the boat's superstructure, a radome antenna, or mast. Sailboat users should avoid mounting the antenna high on the mast to prevent inaccurate speed readings caused by excessive heeling. Most marine VHF and LORAN antennas should not seriously degrade the GPS antenna's reception. Never paint the antenna or clean it with harsh solvents.

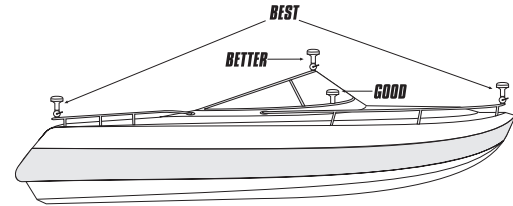

Suggested locations for mounting the external antenna.

The Garmin antenna screws directly onto any standard 1" x 14-thread antenna mount. If you need to raise the antenna to avoid shading, try using a 1" x 14-thread extension mast available at most marine dealers.



**NOTE:** It is possible to route the coaxial cable either through, or outside the antenna mount. It is possible to remove the BNC connector on the coaxial cable and the coaxial cable shortened to ease installation, however, doing so voids the antenna warranty. If the BNC connector is removed, it must be replaced with a new solder-on or crimp BNC connector.



**To install the GPS antenna:**

1. Screw the antenna directly onto the 1" x 14-thread mount.
2. Route the cable to the mounting location of the unit. Use the appropriate tie-wraps, fasteners, and sealant to secure the cable along the route and through any bulkhead or deck.
3. After the GPSMAP 198C Sounder unit is installed, connect the cable to the antenna connector on the back of the unit. Make sure that you turn the antenna cable connector 1/4 turn clockwise to lock the cable into place.

**Mounting the GPSMAP 198C Sounder****Using the Gimble Mount**

The GPSMAP 198C Sounder's compact, waterproof case is suitable for mounting in exposed locations or at the nav station. The unit comes with a gimbal bracket that can be used for surface or overhead mounting. When choosing a location for the unit, consider the following conditions:

- There should be at least a 3" (7 cm) clearance behind the case to allow connection of the antenna and power/data cables.
- The mounting surface should be heavy enough to support the unit and protect it from excessive vibration and shock.



---

**NOTE:** *The temperature range for the GPSMAP 198C Sounder is 5°F to 158°F (-15°C to 70°C). Extended exposure to temperatures exceeding this range (in storage or operating conditions) can cause failure of the screen. This type of failure and related consequences are NOT covered by the manufacturer's limited warranty.*

---

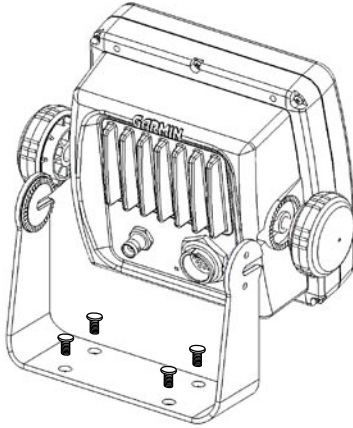

### To install the GPSMAP 198C Sounder:

1. Select a location for the mounting bracket.
2. Mark and drill the four mounting holes for the fastener you are using.
3. Fasten the bracket to the surface using the appropriate fastener.
4. Insert the GPSMAP 198C Sounder into the mounting bracket. The bracket is designed for a tight fit to provide additional support when swiveling the unit.

5. Screw the two mounting knobs through the bracket and into the screen case.
6. Connect the power/data and antenna cables (external antenna only) to the back of the unit, making sure the locking rings are fully tightened on both connectors.

### Flush Mounting the GPSMAP 198C Sounder

The GPSMAP 198C Sounder can be flush mounted on a flat panel. When flush mounting the GPSMAP 198C Sounder, be sure to choose an appropriately sized location for the unit (see unit dimensions on [page 93](#)) and leave 1.25" (32 mm) clearance below the data card slot for inserting or removing data cards. A Flush Mount Template is provided in the package. Use the instructions on the template to complete the flush mount installation.

## Installing the Transducer

The transducer acts as the eyes and ears of your new sonar. Proper transducer installation is critical to the operation of your unit. The transducer transmits sound waves toward the bottom in a cone shape. The larger the cone angle, the larger the coverage area at a given depth.

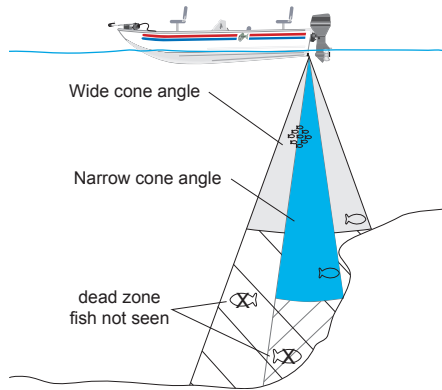

A wide cone angle transducer works best in shallow water. The wide cone angle provides a large coverage area, but at a decreased bottom resolution. In deeper water this can result in a large dead zone where fish cannot be seen. A narrow cone angle transducer is better suited to deep-water installations. The narrow cone angle provides a smaller viewing area (compared to a wide cone angle transducer at the same depth) with improved bottom resolution and a smaller dead zone. Dual frequency transducers give you the best of both wide and narrow cone angles.

A 50/200 kHz dual frequency 40°/10° cone angle, temperature sensing, transom mount transducer is included in the GPSMAP 198C Sounder (with transducer) package. This transducer provides good all-around performance.

## Transom Mount Transducer

The following diagram is for mounting the transducer included with the GPSMAP 198C Sounder with transducer package. If the transducer lead is too short, extension cables are available from your Garmin dealer. **DO NOT** cut the transducer lead or any part of the transducer cable, as this will void your warranty. The cable cannot be spliced and connected to any existing (Garmin or non-Garmin) transducer cables.



**NOTE:** *DO NOT* mount the transducer behind strakes, struts, fittings, water intake, or discharge ports, or anything that creates air bubbles or causes the water to become turbulent. It is important that the transducer is in clean (non-turbulent) water for optimal performance.

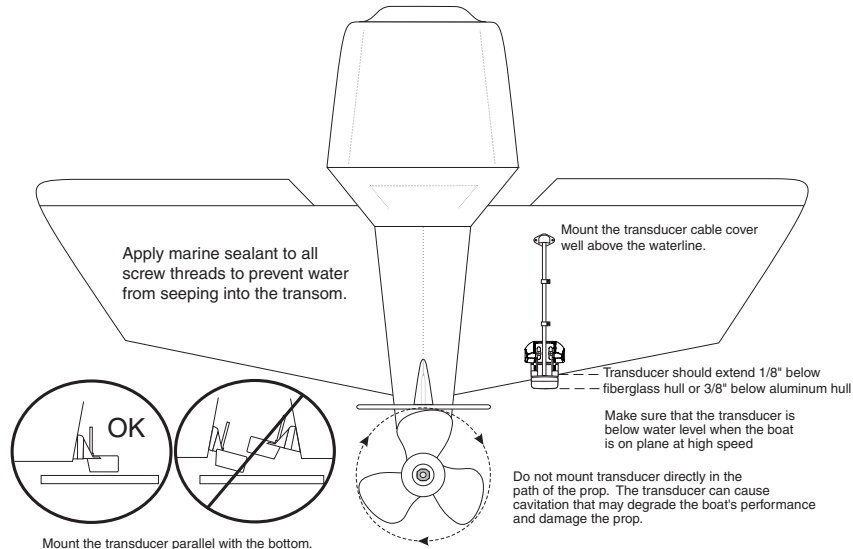

## Care Information

### Cleaning the Unit

The GPSMAP 198C Sounder is constructed of high quality materials and does not require user maintenance other than cleaning. Clean the unit using a cloth dampened with a mild detergent solution and then wipe dry. Avoid chemical cleaners and solvents that can damage plastic components.

### Storing the GPSMAP 198C Sounder

Do not store the GPSMAP 198C Sounder where prolonged exposure to temperature extremes can occur (such as in the trunk of a car) as permanent damage can result. User information, such as waypoints and routes are retained in the unit's memory without the need for external power. It is always a good practice to back up important user data by manually recording it or downloading it to a PC (transferring it to MapSource.)

### Immersing the Unit in Water

The GPSMAP 198C Sounder is waterproof to IEC Standard 60529 IPX7. It can withstand immersion in 1 meter of water for 30 minutes. Prolonged submersion can cause damage to the unit. After submersion, be certain to wipe and air dry the unit before reuse.

To resolve problems that cannot be remedied using this manual, contact Garmin Product Support in the U.S. at 800/800-1020 or Garmin Europe at 44/0870-8501241.



## Connecting the Power/Data Cable

The power/data cable connects the GPSMAP 198C Sounder to a DC system and provides interface capabilities for connecting external devices. The color code in the diagram below indicates the appropriate harness connections. Replacement fuse is a AGC/3AG - 3 Amp fuse.



**NOTE:** During a typical installation, only the Red and Black wires are used. The other wires do not have to be connected for normal operation of the unit.

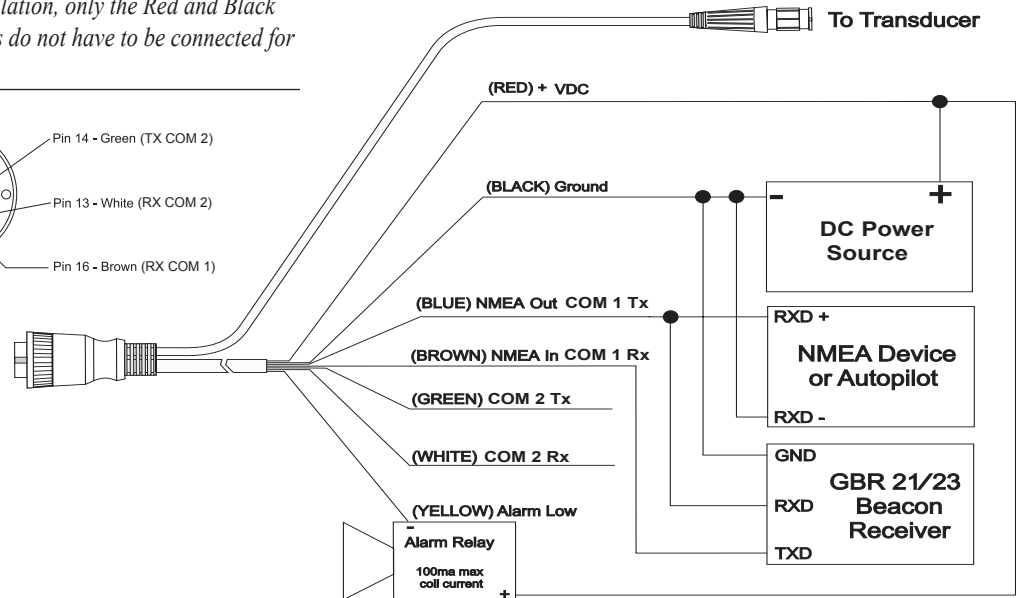
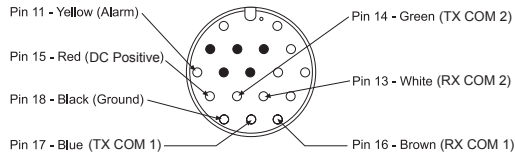

## Interfacing

The following formats are supported for connection of external devices:

Garmin proprietary Differential GPS (DGPS), NMEA 0183 versions 2.3, ASCII Text Output, RTCM SC-104 input (vs. 2.0).

The following are the sentences for NMEA 0183, vs. 2.3 output:

**Approved sentences**—GPRMC, GPGGA, GPGSA, GPGSV, GPGLL, GPBOD, GPRTE, and GPWPL.

**Proprietary sentences**—PGRME, PGRMZ, and PSLIB. The GPSMAP 198C Sounder accepts NMEA input with support for the DBT, DPT, MTW, and VHW sentences.

The GPSMAP 198C Sounder also includes NMEA input with support for the WPL sentence and sonar NMEA input with support for the DPT (Depth), MTW (Water Temp) and VHW (Water Speed & Heading) sentences. If connecting to COM 2 for sonar NMEA input, the unit interface must be set to NMEA In/NMEA Out. If connecting to COM 1, the unit must be set to NMEA In/NMEA Out.

You can download a copy of Garmin's proprietary communication protocol on the Help and Support section of our Web site at [www.garmin.com](http://www.garmin.com).

Complete information regarding NMEA and RTCM formats is available for purchase at [www.nmea.org](http://www.nmea.org)

## Installing and Removing Data Cards

The GPSMAP 198C Sounder uses optional Garmin marine BlueChart and MapSource data cards to show digital charts and maps on-screen. Data cards are installed in the card slot located at the bottom right of the unit. Data cards can be installed or removed at any time, whether the unit is on or off.

### To install a data card:

1. Open the card door by pressing together on the two handles at the bottom of the door and lifting it up and open.
2. Insert the card, with the label facing front and the handle bottom, into the slot.
3. Firmly push the card into the unit. It is not necessary to force the card and about 1/2" is still exposed when it is properly inserted. If the unit is on, a confirmation tone sounds and a message shows on-screen noting the card details when the card is properly installed and accepted.
4. Close the cover.

If you insert a data card and get a "card format not recognized" message, try removing the card and reinserting it. If the card is still not recognized, contact Garmin Support or your Garmin dealer for assistance. Data cards are not waterproof and should not be exposed to moisture or excessive static charges. Data cards should be stored in the case supplied with the card.

### To remove a data card:

1. Open the card door by pressing together on the two handles at the bottom of the door and lifting it up and open.
2. Grasp the card handle at the bottom and pull down firmly.
3. If the unit is on, a confirmation tone sounds when the data card has been removed.

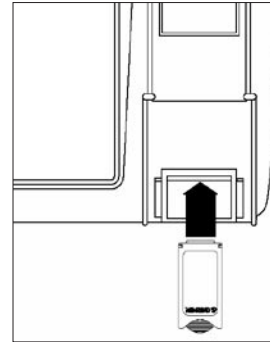

The first time you insert a data card, the unit takes a few seconds to read the card.

After the data card is read, a summary screen appears. Press **ENTER** to acknowledge.

## Satellite Information

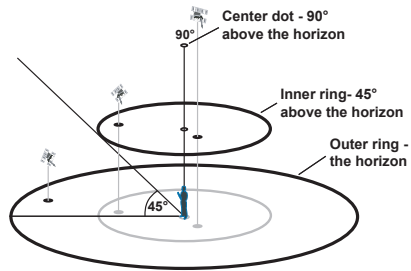

**Satellite Sky View**

## Satellite Location

The location of each available satellite shows over two location rings on the Satellite Information Page. The outer ring represents the horizon, the inner ring represents 45° above the horizon, and the center represents directly overhead. When the unit is using a satellite for navigation, the satellite number is highlighted on the location rings. The unit can be set to show satellite location with North or your current track at the top of the screen.

## Satellite Strength Indicator Bars

The Satellite Strength Indicator Bars show the strength of the signal being received, and the status of the signal. The bars are either shaded or filled. The gray bar means the GPS is in the process of storing orbital data it is receiving from the satellite signal. When the bar turns solid, the GPS is using the satellite signal for navigation. A “D” in or above the bar means that differential corrections (WAAS or DGPS) are being applied to that satellite.

## Date, Time, and Current Location

The GPS gets date and time information from the satellite’s on-board atomic clock. When the GPS receiver has achieved a 2D or 3D GPS location, the current location appears in the selected location format.

## What is WAAS?

The Wide Area Augmentation System (WAAS) is an F.A.A. funded project to improve the overall integrity of the GPS signal. It is a space-based system that broadcasts integrity information and correction data as determined by ground reference stations. WAAS testing completed in September 2003 confirmed an accuracy of 2 to 3 vertical meters throughout the majority of the continental U.S. and portions of Alaska. For more information, go to <http://gps.faa.gov/Programs/WAAS/waas.htm>.



---

**NOTE:** *If you are using the GPSMAP 198C Sounder outside of the U.S.A., we recommend you turn off WAAS for the most accurate location fix.*

---

## What is Differential GPS (DGPS)?

The U.S. and Canadian governments (among others) have set up Differential GPS (DGPS) stations to transmit correction signals. They are operational in coastal areas and on many navigable river systems. The DGPS system is available for use without a fee.

Refer to the U.S. Coast Guard's Web site, <http://www.navcen.uscg.gov/> for locations and the status of the differential sites. Using DGPS requires additional equipment.

## What is a Maritime Mobile Service Identity (MMSI)?

Maritime Mobile Service Identity (MMSI) basically allows a VHF radio to act like a phone. In order to make a “call” on a phone, you first need a phone number to dial. The 9-digit MMSI number acts like a phone number when used in a Position Report and as a unique identifier to the Coast Guard when used in an emergency Distress Call. In order to obtain a Maritime Mobile Service Identity (MMSI) number, users must register their VHF radio with the FCC (Form 605). Garmin does not supply this number.

## How ARE MMSI assignments obtained?

Non-commercial users (for example, recreational users who remain in domestic waters and only carry VHF, EPIRB (Emergency Position Indicating Radio Beacons), and Radar) are not required to have a FCC ship station license. The FCC and Coast Guard have authorized some second and third party vendors to assign MMSI numbers. This service is limited to registering recreational vessels only. To receive information on how to obtain a recreational MMSI number, contact: <http://www.uscg.mil/rescue21/links/mmsi.htm> or <http://wireless.fcc.gov/marine/>.

**U.S Non-Federal User:** Commercial users, or those who travel outside the U.S. or Canada, must apply for a ship station license, or an amendment to a ship station license. To find out if you require a Ship Station license contact: <http://wireless.fcc.gov/marine/fctsh14.html>. If your vessel requires licensing by the FCC you obtain a MMSI during the application/licensing process when you file FCC Forms 159 and 605.

**U.S. Federal User:** Federal users can obtain MMSI assignments from their agency radio spectrum management office. These procedures are currently under review by the NTIA (National Telecommunications and Information Administration).

**Outside the U.S.:** Users can obtain an MMSI assignment from their telecommunications authority or ship registry, often by obtaining or amending their ship station license.

**In Canada:** Industry Canada is responsible for assigning MMSI numbers to commercial and recreational vessels. Information is available at the following web site: <http://apollo.ic.gc.ca/english/mmsi.html>.

For information regarding MMSI's visit:  
<http://www.navcen.uscg.gov/marcomms/gmdss/mmsi.htm>.

## Navigation Terms

**Avg Speed**—the average of all second-by-second speed readings since last reset.

**Bearing (BRG)**—the compass direction from your current location to a destination.

**Course**—the course between the active from and to waypoints.

**Depth**—the depth below transducer. This field is active only if a transducer is connected to the GPSMAP 198C Sounder.

**Distance (Dist)**—the distance from the current location to a destination.

**Dist to Destination**—the distance from the current location to a Go To destination, or the final waypoint in a route.

**Dist to Next**—the distance from current location to a Go To destination, or the next waypoint in a route.

**DOP (Dilution of Precision)**—reflects the quality of the GPS signals and satellite geometry.

**Elevation**—height above mean sea level (MSL).

**ETA (Estimate Time of Arrival)**—the time you estimate to reach your destination waypoint, based on current speed and track.

**ETA at Destination**—the time you estimate to reach a Go To destination or the final waypoint in a route.

**ETA at Next**—the time you estimate to reach a Goto destination or the next waypoint in a route.

**Fuel**—the fuel required to travel from current location to the indicated route waypoint.

**GPS Accuracy**—estimated accuracy of the GPS location.

**Leg Dist**—the distance between two route waypoints.

**Leg Fuel**—the fuel required to travel from a route waypoint to the next waypoint (in sequence) in the route.

**Leg Time**—the time required to travel from a route waypoint to the next waypoint (in sequence) in the route.

**Max Speed**—the maximum second-by-second speed recorded since last reset.

**Moving Average Speed**—average speed while the unit is moving.

**Moving Trip Timer**—total time the unit has been moving.

**Odometer**—a running tally of distance travelled, based on the distance between second-by-second position readings.

**Off Course**—the distance you are off course in either direction, left or right.

**Pointer**—an arrow pointing to your destination.

**Speed**—the current velocity at which you are travelling, relative to a ground position. Also referred to as ground speed.

**Sunrise**—the current day's time of sunrise.

**Sunset**—the current day's time of sunset.

**Time Of Day**—the current time.

**Time To**—the estimated time required to reach a Goto destination, or the next waypoint in a route. Also known as “estimated time en route.”

**Time to Dest**—the estimated time required to reach a Goto destination, or the final waypoint in a route.

**Time to Next**—the estimated time required to reach a Goto destination, or the next waypoint in a route.

**To Course**—the recommended direction to steer to reduce course error or stay on course. Provides the most efficient heading to get back to the course and proceed along your route.

**Track**—the direction of movement relative to a ground position. Also referred to as “ground track.”

**Trip Odometer**—a running tally of distance travelled since last reset. See also “Odometer.”

**Total Average Speed**—average speed of unit for both moving and stopped speeds since last timer reset.

**Total Trip Timer**—total time the unit has been in operation since last reset of the trip timers.

**Turn**—the angle difference between the bearing to your destination and your current track. “L” indicates you should turn left; “R” indicates you should turn right.

**VMG (Velocity Made Good)**—the speed you are closing in on a destination along a course. Also referred to as the vector velocity to your destination.

**Voltage**—current voltage reading being received by unit.

**Water Speed**—the speed through the water. This field is only active if the GPSMAP 198C Sounder is receiving speed readings from a NMEA device.

**Water Temp**—the water temperature. This field is only active if the GPSMAP 198C Sounder is receiving speed readings from a NMEA device.

**Waypoint Destination**—the final waypoint in the route, or the destination waypoint.

**Waypoint Next**—the next waypoint in the route.



## Messages

**Approaching Turn**—you are nearing a turn in a route.

**Arriving at Destination**—you are nearing your destination.

**Batteries Low**—you have less than 10 minutes of battery left.

**Can't Unlock Maps**—no applicable unlock code for one or more maps was found.

**Cannot display all found, use city or postal code**—the unit found too many items to show. Narrow the search using the city or postal code.

**Database Error**—internal problem with the unit. Contact your dealer or Garmin Product Support to have the unit repaired.

**Deep Water**—the water is deeper than the amount set in the Deep Water Alarm.

**Dragging Anchor**—the distance set in the Anchor Alarm is exceeded.

**Lost Satellite Reception**—the unit is unable to continue receiving satellite signals.

**Memory Full**—unit memory is full; no further data can be saved.

**Near Proximity Point**—you are nearing a proximity waypoint.

**No Diff GPS Location**—RTCM is selected but no DGPS data is being received.

**No Tide Stations for that Area**—no tide stations within 100 miles of the area.

**None Found**—no data matched the search criteria.

**Off Course**—you are off course the distance set in the “Off Course” alarm.

**Proximity Memory Full**—no additional proximity waypoints can be saved.

**Proximity Radius Overlaps**—the radii of two proximity waypoints overlap.

**Route Already Exists**—you have entered a route name that already exists.

**Route Memory Full**—no additional routes can be saved.

**Route Truncated**—uploaded route from another device has more than 50 waypoints.

**Route Waypoint Memory Full**—no additional route waypoints can be saved.

**Shallow Water**—the water is shallower than the depth set in the Shallow Water Alarm.

**Track Already Exists**—a saved track with the same name already exists.

**Track Memory Full**—no more track data can be stored without deleting old data.

**Track Log Full**—the track log is full and track recording has been turned off. To record more track points, you need to clear the track log and turn track recording on. This only appears when the track recording setting is set to “Stop When Full.”

**Track Truncated**—a complete uploaded track does not fit in memory. The oldest track log points have been deleted.

**Transfer Complete**—data transfer has been completed.

**Waypoint Already Exists**—a waypoint with the same name already exists.

**Waypoint Memory Full**—the unit has stored the maximum number of waypoints.

## LORAN TD System

LORAN C is a radio navigation aid operated and maintained in the United States by the United States Coast Guard. The name LORAN is an acronym for “LOng RANGE Navigation.” The LORAN system covers the entire United States and the U.S. Coastal Confluence Zone. From the perspective of a mariner, the system is used for ocean and coastal navigation. It can be used as a supplemental system for harbor and harbor approach navigation, and it is used for inland navigation by recreational vehicles.

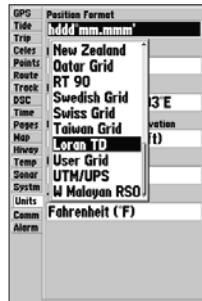

Change to Loran TD from the Units tab on the Main Menu.

## LORAN TD Feature

The LORAN TD (Time Delay) feature eases the transition from using LORAN to using GPS. The GPSMAP unit automatically converts GPS coordinates to LORAN TDs for those who have a collection of LORAN fixes for favorite fishing spots and other waypoints recorded as TDs. You can show your position as a TD or enter waypoints as TDs. The accuracy to be expected from this conversion is approximately 30 meters. When the unit is placed in the LORAN TD format mode, it simulates the operation of a LORAN receiver. Position coordinates can show as TDs, and all navigation functions can be used as if the unit was actually receiving LORAN signals.

## Using the LORAN TD Format

When creating new waypoints using LORAN TD coordinates, you must set the correct LORAN chain number and secondary stations in the Setup TD field before storing the waypoint. After the waypoint is stored in unit memory, it always references the LORAN chain number and secondary stations currently selected in the Setup TD field. If you enter a different LORAN chain number or change the secondary stations or offsets in the Setup TD field, the active waypoint information reflects those changes. Since the GPSMAP 198C Sounder does not rely on the LORAN signal for navigation, it can reference a different GRI chain and/or secondary stations and still navigate to the location stored in memory.

The LORAN Position Format field is located under the Setup—Location tab in the Main Menu. The **LORAN TD Setup** window contains the fields to select the Loran GRI-Chain Number, Primary and Secondary Stations, and TD Offsets.

### To set up Loran TD from the Main Menu:

1. Press **MENU** twice to show the Main Menu.
2. Using the **ROCKER**, highlight the **Position Format** field on the **Units** tab, and press **ENTER**.
3. Highlight **Loran TD**, and press **ENTER**.
4. Highlight **Setup**, and press **ENTER**.
5. To change the settings of any of the five fields, highlight the field, press **ENTER**, select or enter a setting, then press **ENTER**.
6. When finished, highlight **Save**, and press **ENTER**.

Loran TD Setup	
Loran Chain Number	
GRI_8970	
TD Station 1	TD Offset 1
W	0.0
TD Station 2	TD Offset 2
Y	0.0

Loran TD Setup Page

If the active GRI Chain, secondary stations, or offsets have been changed since the waypoint was created, the waypoint now references the active GRI-chain and secondary stations. You must adjust the TD coordinates accordingly. Remember that the GPS is not relying on the LORAN signal for navigation and actually converts the TD coordinate to a useful LAT/LON coordinate before storing the waypoint to memory or using it for navigation. Because of this, the unit can navigate to a TD coordinate anywhere in the world.

You must know your GRI chain number and secondary stations to create a LORAN TD position. For more information, read our LORAN TD Position Format Handbook, available at the Garmin Web site ([www.garmin.com/support/userManual.jsp](http://www.garmin.com/support/userManual.jsp).)

## Optional Accessories

The following optional accessories are designed to enhance the operation of the GPSMAP 198C Sounder.

To obtain replacement parts and optional accessories, contact your Garmin Dealer, Garmin Product Support in the U.S.A. at 800-800-1020, or Garmin Europe at 44-0870-8501241.



---

**WARNING:** *Garmin accessories have been designed and specifically tested for use with Garmin products. Accessories offered by other manufacturers have not been tested or approved for use with Garmin products. Use of such accessories could cause damage to the GPSMAP 198C Sounder and void the warranty.*

---

**MapSource Software CD-ROMs**—enhances the basemap, create waypoints and routes from your PC. MapSource offers several detailed mapping options that are compatible with the GPSMAP 198C Sounder, including MetroGuide, BlueChart, and Fishing Hot Spots.

**Programmable Data Cards**—blank data cards are available in 8 MB, 16 MB, 32 MB, 64 MB, and 128 MB sizes. Download street-level map detail, points of interest, business addresses and phone numbers, marine data, topographical information, and more from MapSource CD-ROMs to a data card, either directly through your GPSMAP 198C Sounder using the PC Interface Cable, or with the Data Card Programmer.

**USB Data Card Programmer**—programs blank data cards at high speed through a PC.

**Pre-Programmed Data Cards**—data cards pre-programmed with either Garmin BlueChart or Fishing Hot Spots map data.

**A/C Adapter**—powers the unit using a standard AC house current.

**PC Interface Cable with vehicle Power Adapter**—connects the GPSMAP 198C Sounder to a vehicle's electrical system on one end, and a PC, beacon receiver, marine autopilot, or other compatible device on the other end.

## Software License Agreement

BY USING THE GPSMAP 198C SOUNDER, YOU AGREE TO BE BOUND BY THE TERMS AND CONDITIONS OF THE FOLLOWING SOFTWARE LICENSE AGREEMENT. PLEASE READ THIS AGREEMENT CAREFULLY.

Garmin grants you a limited license to use the software embedded in this device (the “Software”) in binary executable form in the normal operation of the product. Title, ownership rights, and intellectual property rights in and to the Software remain in Garmin.

You acknowledge that the Software is the property of Garmin and is protected under the United States of America copyright laws and international copyright treaties. You further acknowledge that the structure, organization, and code of the Software are valuable trade secrets of Garmin and that the Software in source code form remains a valuable trade secret of Garmin. You agree not to decompile, disassemble, modify, reverse assemble, reverse engineer, or reduce to human readable form the Software or any part thereof or create any derivative works based on the Software. You agree not to export or re-export the Software to any country in violation of the export control laws of the United States of America.

## Product Registration

Help us better support you by completing our online registration today! Have the serial number of your GPSMAP 198C Sounder handy and connect to our Web site (<http://www.garmin.com>). Look for the Product Registration link on our Home Page.

Use this area to record the serial number (8-digit number located on the back of the box) in case your GPSMAP 198C Sounder unit is lost, stolen, or needs service. Be sure to keep your original sales receipt in a safe place or attach a photocopy inside the manual.

Serial Number: \_\_\_\_ \_

## Contact Garmin

If you should encounter any difficulty while using your GPSMAP 198C Sounder, or if you have any questions, in the U.S.A. contact Garmin Product Support by phone: 913-397-8200 or 800-800-1020, Monday–Friday, 8 AM–5 PM Central Time, or by e-mail at [sales@garmin.com](mailto:sales@garmin.com).

In Europe, contact Garmin (Europe) Ltd. at 44-0870.8501241.

## Limited Warranty

This Garmin product is warranted to be free from defects in materials or workmanship for one year from the date of purchase. Within this period, Garmin will at its sole option repair or replace any components that fail in normal use. Such repairs or replacement will be made at no charge to the customer for parts or labor, provided that the customer shall be responsible for any transportation cost. This warranty does not cover failures due to abuse, misuse, accident or unauthorized alteration or repairs.

THE WARRANTIES AND REMEDIES CONTAINED HEREIN ARE EXCLUSIVE AND IN LIEU OF ALL OTHER WARRANTIES EXPRESS OR IMPLIED OR STATUTORY, INCLUDING ANY LIABILITY ARISING UNDER ANY WARRANTY OF MERCHANTABILITY OR FITNESS FOR A PARTICULAR PURPOSE, STATUTORY OR OTHERWISE. THIS WARRANTY GIVES YOU SPECIFIC LEGAL RIGHTS, WHICH MAY VARY FROM STATE TO STATE.

IN NO EVENT SHALL GARMIN BE LIABLE FOR ANY INCIDENTAL, SPECIAL, INDIRECT OR CONSEQUENTIAL DAMAGES, WHETHER RESULTING FROM THE USE, MISUSE, OR INABILITY TO USE THIS PRODUCT OR FROM DEFECTS IN THE PRODUCT. Some states do not allow the exclusion of incidental or consequential damages, so the above limitations may not apply to you.

Garmin retains the exclusive right to repair or replace the unit or software or offer a full refund of the purchase price at its sole discretion. SUCH REMEDY SHALL BE YOUR SOLE AND EXCLUSIVE REMEDY FOR ANY BREACH OF WARRANTY.

To obtain warranty service, contact your local Garmin authorized dealer or call Garmin Product Support for shipping instructions and an RMA tracking number. The unit should be securely packed with the tracking number clearly written on

the outside of the package. The unit should then be sent, freight charges prepaid, to any Garmin warranty service station. A copy of the original sales receipt is required as the proof of purchase for warranty repairs.

Garmin International, Inc.  
1200 E 151st Street, Olathe, Kansas 66062 U.S.A.  
Tel. 913/397.8200  
Fax. 913/397.8282

Garmin (Europe) Ltd.  
Unit 5, The Quadrangle, Abbey Park Industrial Estate, Romsey, SO51 9DL U.K.  
Tel. 44/0870.8501241  
Fax 44/0870.8501251

**Online Auction Purchases:** Products sold through online auctions are not eligible for rebates or other special offers from Garmin. Online auction confirmations are not accepted for warranty verification. To obtain warranty service, an original or copy of the sales receipt from the original retailer is required. Garmin will not replace missing components from any package purchased through an online auction.

**International Purchases:** A separate warranty is provided by international distributors for units purchased outside the United States. This warranty is provided by the local in-country distributor and this distributor provides local service for your unit. Distributor warranties are only valid in the area of intended distribution. Units purchased in the United States or Canada must be returned to the Garmin service center in the United Kingdom, the United States, Canada, or Taiwan for service.

The Garmin GPSMAP 198 Sounder has no user-serviceable parts. Should you ever encounter a problem with your unit, please take it to an authorized Garmin dealer for repairs.

## FCC Compliance

The GPSMAP 198C Sounder complies with Part 15 of the FCC interference limits for Class B digital devices FOR HOME OR OFFICE USE. These limits are designed to provide more reasonable protection against harmful interference in a residential installation, and are more stringent than “outdoor” requirements.

Operation of this device is subject to the following conditions: (1) This device may not cause harmful interference, and (2) this device must accept any interference received, including interference that may cause undesired operation.

This equipment generates, uses, and can radiate radio frequency energy and may cause harmful interference to radio communications if not installed and used in accordance with the instructions. However, there is no guarantee that interference will not occur in a particular installation.

If this equipment does cause harmful interference to radio or television reception, which can be determined by turning the equipment off and on, the user is encouraged to try to correct the interference by one of the following measures:

- Reorient or relocate the receiving antenna.
- Increase the separation between the equipment and the receiver.
- Connect the equipment into an outlet on a circuit different from that to which the receiver is connected.
- Consult the dealer or an experienced radio/TV technician for help.

The GPSMAP 198C Sounder does not contain any user-serviceable parts. Repairs should only be made by an authorized Garmin service center. Unauthorized repairs or modifications could result in permanent damage to the equipment, and void your warranty and your authority to operate this device under Part 15 regulations.



# INDEX

## Symbols

- 2D Differential 42
- 2D GPS Location 89, 102
- 3D Differential 42
- 3D GPS Location 102

## A

- Accessories 111
- Accuracy 39
- Accuracy Alarm 76
- Accuracy Circle 67
- Active Route Page 37
  - Options 38
- Alarms
  - Accuracy 76
  - Anchor Drag 76
  - Arrival 76
  - Battery 76
  - Clock 76
  - DGPS 76
  - DSC 25
  - Fish 76
  - Off Course 76
  - Shallow/Deep Water 76
  - Temperature 76
- Alarm Tab 76

- Anchor Drag Alarm 76
- Arrival Alarm 76

## B

- Backlight 4
- Base Map 64
- Battery Alarm 76
- Bearing Line 67
- Bottom Split 81

## C

- Card Tab 62
- Celestial Tab 47
- Cleaning 98
- Clock Alarm 76
- Color Mode 64
- Communication Tab 72
- Correction Signals 103
- Course Line 67
- Course Up 64

## D

- Data Cards 101
- Data Entry 6
- Data Fields
  - Change Numbers 31
  - Show 31
  - Split Fields 35
- Date/Time 102
- Daylight Saving Time 62

- Delete
  - DSC Directory Item 24
- Depth Line 82
- DGPS 103
  - Alarm 76
- Differential GPS 103
- Dilution of Precision 105
- Distance 60
- Distress Calls 22, 22–25
- DOP 105
- DSC 22
  - Call List 24
  - Directory 24
  - Log 24
  - Setting Up 25
- DSC Tab 61

## E

- Edit
  - Route 56
  - Waypoint 11
- Enter/Mark Key 5, 8

## F

- FCC Compliance 114
- Features 5
- Find 19
  - Additional Information 21
- Find Key 5, 19

- Fish Alarm 76
- Flasher 86

## G

- Gain 81
- Garmin Data Transfer 72
- Go To 13
  - Distress Call 25
  - Position Report 25
- GPS Tab 39
  - Options 43

## H

- Heading Line 67
- Highway Page 35
  - Options 36
  - Setup 37
- Highway Tab 68

## I

- Initializing 1
- Installation 93
- Interface Keys 5
- Interfacing 100
- In Zoom Key 5

## K

- Keel Offset 87
- Keypad Usage 5
- Key Beeps 69

**L**

Language 69  
License Agreement 112  
LORAN TD 109

**M**

Magnetic Variation 71  
Main Menu 39  
Main Pages 26  
Man OverBoard 10  
MapSource 62  
Map Datum 70  
Map Detail 64  
Map Information Page 65  
Map Page 27  
    Options 30  
    Setup Map 33  
Map Pointer 7, 28  
Map Scales 29  
Map Tab 64  
Maritime Mobile Service Identity 104  
Mark Key 5  
Measure Distance 32  
Menu Key 5  
Merge From Card 62  
Messages 107  
MMSI 22, 104  
MOB 10  
MOB Key 5

**N**

NAV/MOB Key 5, 12  
Nav aids 66  
Navigating 12  
    Distress Call 25  
    Go To 13  
    Position Report 25  
    Routes 53  
    TracBack 14  
Navigation Terms 105  
NMEA 74  
Noise Reject 82  
North Up 64  
Numbers Page 34

**O**

Off Course Alarm 76  
Orientation 64  
Out Zoom Key 5  
Overzoom 29

**P**

Pages Tab 63  
Page Key 5  
Pointer Page 33  
    Options 34  
Points Tab 48  
Position Format 70  
Position Reports 23  
Power Key 5

Power On/Off 1  
Proximity Waypoints 52

**Q**

Quit Key 5

**R**

Receiving a DSC Call 25  
Replace From Card 62  
Review  
    DSC Call 23  
    Waypoints 11  
Rocker Key 5  
Routes 17  
    Copy 53  
    Create 17  
    Delete 53  
    Delete All 53  
    Edit 56  
Routes Tab 53  
Route Review Page 54  
    Options 55  
RTCM 74

**S**

Satellite Location 102  
Satellite Sky View 102  
Selecting Options 6  
Shallow/Deep Water Alarm 76  
Simulator Mode 3

Software Update Card 69  
Sonar 78

    Depth Line 82  
    Gain 81  
    Noise Reject 82  
    Understanding 89  
    View/Span 81  
    Whiteline 82  
Sonar Page 78  
    Adjustment Menu 79  
    Bottom Split 81  
    Options 83  
Sonar Tab 68  
    Options 85  
Specifications 92  
Speed Filter 69  
Spot Sounding 66  
Storage 98  
System Information 69  
System Tab 69

**T**

Temperature Scale 68  
Temperature Tab 68  
Thermoclines 91  
Tide Stations 43  
Tide Tab 43  
Time Format 62  
Time Tab 62  
Time Zone 62

TracBack 14  
  Activate 16  
Track Logs  
  Clear 15  
  Save 15  
Track Tab 59  
  Active 59  
  Saved 59  
Track Up 64  
Transducer 90, 96  
Trip Planning 58  
Trip Tab 46

**U**  
Underwater Waypoints 84  
Units Tab 70  
Unit Defaults 69

**W**  
WAAS 40, 103  
  Disable/Enable 41  
Waterproof 98  
Water Speed 87  
Water Temperature Alarm 76

Waypoints  
  Creating 8  
  Creating Graphically 9  
  Editing 11  
  Enter/Mark 8  
  Move 12  
  Proximity 52  
  Reviewing 11  
  Underwater 84  
Waypoint Lists  
  Proximity 51  
  User 49  
Whiteline 82, 91  
Wide Area Augmentation System 40,  
  103  
Wiring Installation 99

**Z**  
Zoom Keys 5  
Zoom Range 29  
Zoom Settings 29





**For the latest free software updates (excluding map data) throughout the life of your  
Garmin products, visit the Garmin Web site at [www.garmin.com](http://www.garmin.com).**



© Copyright 2005 Garmin Ltd. or its subsidiaries

Garmin International, Inc.  
1200 East 151<sup>st</sup> Street, Olathe, Kansas 66062, U.S.A.

Garmin (Europe) Ltd.  
Unit 5, The Quadrangle, Abbey Park Industrial Estate, Romsey, SO51 9DL, U.K.

Garmin Corporation  
No. 68, Jangshu 2<sup>nd</sup> Road, Shijr, Taipei County, Taiwan

[www.garmin.com](http://www.garmin.com)

Part Number 190-00541-00 Rev. B

## Free Manuals Download Website

<http://myh66.com>

<http://usermanuals.us>

<http://www.somanuals.com>

<http://www.4manuals.cc>

<http://www.manual-lib.com>

<http://www.404manual.com>

<http://www.luxmanual.com>

<http://aubethermostatmanual.com>

Golf course search by state

<http://golfingnear.com>

Email search by domain

<http://emailbydomain.com>

Auto manuals search

<http://auto.somanuals.com>

TV manuals search

<http://tv.somanuals.com>