

GPSMAP® **2106/2110** *color chartplotter*



© Copyright 2006 Garmin Ltd. or its subsidiaries

Garmin International, Inc.
1200 East 151st Street,
Olathe, Kansas 66062, U.S.A.
Tel. 913/397.8200 or 800/800.1020
Fax 913/397.8282

Garmin (Europe) Ltd.
Unit 5, The Quadrangle, Abbey Park Industrial Estate, Romsey,
SO51 9DL, U.K.
Tel. 44/0870.8501241
Fax 44/0870.8501251

Garmin Corporation
No. 68, Jangshu 2nd Road, Shijr, Taipei County, Taiwan
Tel. 886/2.2642.9199
Fax 886/2.2642.9099

All rights reserved. Except as expressly provided herein, no part of this manual may be reproduced, copied, transmitted, disseminated, downloaded or stored in any storage medium, for any purpose without the express prior written consent of Garmin. Garmin hereby grants permission to download a single copy of this manual onto a hard drive or other electronic storage medium to be viewed and to print one copy of this manual or of any revision hereto, provided that such electronic or printed copy of this manual must contain the complete text of this copyright notice and provided further that any unauthorized commercial distribution of this manual or any revision hereto is strictly prohibited.

Information in this document is subject to change without notice. Garmin reserves the right to change or improve its products and to make changes in the content without obligation to notify any person or organization of such changes or improvements. Visit the Garmin Web site (www.garmin.com) for current updates and supplemental information concerning the use and operation of this and other Garmin products.

Garmin®, GPSMAP®, AutoLocate®, TracBack®, BlueChart®, BlueChart® g2™ and MapSource®, See-Thru®, DynaColor™, and Ultrascroll™ are registered trademarks or trademarks of Garmin Ltd. or its subsidiaries and may not be used without the express permission of Garmin.

INTRODUCTION

Thank you for choosing the Garmin® GPSMAP® 2106/2110. The GPSMAP 2106/2110 uses the proven performance of Garmin GPS and full-featured mapping to create an unsurpassed marine Multi-Function Display (MFD). Take a moment now to compare the contents of this package with the packing list on the outside of the box. If any pieces are missing, contact your Garmin dealer immediately.

Installing Your GPSMAP 2106/2110

To install the GPSMAP 2106/2110, refer to the *GPSMAP 2106/2110 & GPS 17 Installation Instructions*. To complete the installation, you need the appropriate fasteners, tools, and mounts listed in each section. Installation items not provided by Garmin should be available at most marine dealers. If you experience difficulty installing the unit, contact Garmin Product Support or an installation professional in your area.

The GPSMAP 2106/2110 is CANet compatible. See the *GPSMAP 2106/2110 & GPS 17 Installation Instructions* for more information.

About This Manual

To get the most out of your new chartplotter, read this manual and learn the operating procedures for your unit in detail. This manual is organized into the following sections:

The **Introduction** contains the Table of Contents, Product Registration, and the Software License Agreement.

The **Getting Started** section provides a unit overview and information that provides basic working knowledge needed to use the GPSMAP 2106/2110.

The **Basic Operation** section provides you with details and step-by-step instructions such as creating and using waypoints, navigating a route, and using the **FIND** key.

The **Main Pages** section provides detailed explanations about each page in the GPSMAP 2106/2110 and step-by-step directions on using the pages.

The **Main Menu** section provides detailed explanations about the Main Menu and how to use it to configure your unit.

See the **Using Sonar** section if you have either a Garmin GSD 21 or GSD 22 sounder connected to your GPSMAP 2106/2110.

The **Appendix** contains specifications, regulatory information, unit care information, optional accessories, and maintenance information. You can also find warranty and FCC information in the Appendix.

An **Index** is provided at the end of the manual for reference.

Manual Conventions

This manual uses the term **Warning** to indicate a potentially hazardous situation, which, if not avoided, could result in death or serious injury.

This manual uses the term **Caution** to indicate a potentially hazardous situation, which, if not avoided, may result in minor injury or property damage. It may also be used without the symbol to alert you to avoid unsafe practices.

TABLE OF CONTENTS

Introduction	i	Creating and Using Waypoints	13
Installing Your GPSMAP 2106/2110	i	Creating Waypoints Using the ENTER/MARK Key	13
About This Manual	i	Creating Waypoints Using the Map	13
Manual Conventions	i	Creating Waypoints Manually	14
Product Registration	v	Reviewing and Editing Waypoints	15
Contact Garmin.....	v	Moving a Waypoint	16
Software License Agreement	v	Using Waypoint Lists	17
Warning	iv	User Waypoints.....	17
Caution	iv	Proximity Waypoints	18
Getting Started	1	Navigating to a Destination	19
Unit Overview	1	Selecting a Map Item Go To Destination	20
Using the GPSMAP 2106/2110 Keypad	2	Follow Track and TracBack Navigation	20
Using Soft Keys.....	3	TracBack Tips.....	22
Using Data Entry/Shortcut Keys	3	Man OverBoard (MOB)	23
Status Bar.....	3	Creating and Using Routes	23
Turning on the GPSMAP 2106/2110	4	Creating a New Route.....	23
Adjusting the Backlight	4	Navigating a Saved Route	24
Initializing the GPS Receiver	5	Creating a Quick NAV Route	25
Receiver Status and Accuracy	6	Copying a Route	25
GPS Setup.....	6	Deleting a Route	26
Using Simulator Mode	7	Editing a Route	26
Basic Operation	8	Planning Routes.....	29
Using the GPSMAP 2106/2110	8	Main Pages	30
Selecting Options and Entering Data.....	9	Configuring Main Pages	31
Using Additional Map Data.....	10	Using Function Windows	33
Using the Map Pointer	10	Function Window Adjustments	33
Finding an Item	12	Viewing a Main Page in Full-Screen Mode.....	34
		Map Page	34
		Selecting Map Ranges	35
		Cartography	36
		Map Page Options	37

Map Split Page	39	System Tab	58
Compass Page	40	Update Sub Tab	63
Highway Page	41	Network Tab	64
Changing the Highway Perspective Range	41	Pages Tab	64
Highway Page Options	41	Map Tab	65
Showing or Hiding Cartography	42	AIS Sub Tab	69
Main Menu	43	Temp (Temperature) Tab	70
GPS Tab	43	Sonar Tab	71
Tide Tab	44	Highway Tab	71
Tide Sub Tab	44	Using Sonar	72
Current Sub Tab	46	Understanding Sonar	72
Celestial Tab	47	Using Dual Frequency	72
Trip Tab	48	Using Dual Beam	72
Points Tab	49	Understanding the Sonar Display	73
Routes Tab	50	Sonar Page	74
Tracks Tab	50	Configuring the Sonar Page	75
DSC (Digital Selective Calling) Tab	52	Using the Sonar Adjustment Menu	76
Understanding DSC Distress Calls	52	Using the Pointer on the Sonar Page	78
Understanding Position Reports	52	Marking an Underwater Waypoint	78
Review DSC Waypoint	53	Sonar Tab	78
Setting Up DSC	54	General Sub Tab	79
Using the NAV Key	54	Graph Sub Tab	80
Card Tab	54	Water Temp Sub Tab	81
Messages Tab	55		
Viewing Detailed Message Information	55		
Alarms Tab	56		
System Alarms	57		
Nav (Navigation) Alarms	57		
Sonar Alarms	58		

Appendix	82	Caring for the GPSMAP 2106/2110	87
Specifications	82	Navigation Terms	88
Installing and Removing Data Cards	83	Messages and Alarms	90
What is WAAS/EGNOS?	84	Optional Accessories	92
WAAS Capability	84	Limited Warranty	93
Digital Selective Calling (DSC)	85	FCC Compliance	94
What is DSC?	85	Declaration of Conformity (DoC)	94
LORAN TD System	86	Index	95

Product Registration

Help us better support you by completing our online registration today! Connect to our Web site at www.garmin.com/registration/.

Use this area to record the serial number (8-digit number located on the back of the GPSMAP 2106/2110) in case your GPSMAP 2106/2110 needs service. Keep the original sales receipt, or a photocopy, in a safe place.

Serial Number: ____ _

Contact Garmin

Contact Garmin if you have any questions while using your GPSMAP 2106/2110. In the U.S.A. contact Garmin Product Support by phone: 913/397.8200 or 800/800.1020, Monday–Friday, 8 AM–5 PM Central Time; or go to www.garmin.com/support/, and click **Product Support**.

In Europe, contact Garmin (Europe) Ltd. at 44/0870.8501241.

Software License Agreement

BY USING THE GPSMAP 2106/2110, YOU AGREE TO BE BOUND BY THE TERMS AND CONDITIONS OF THE FOLLOWING SOFTWARE LICENSE AGREEMENT. PLEASE READ THIS AGREEMENT CAREFULLY.

Garmin grants you a limited license to use the software embedded in this device (the “Software”) in binary executable form in the normal operation of the product. Title, ownership rights, and intellectual property rights in and to the Software remain in Garmin.

You acknowledge that the Software is the property of Garmin and is protected under the United States of America copyright laws and international copyright treaties. You further acknowledge that the structure, organization, and code of the Software are valuable trade secrets of Garmin and that the Software in source code form remains a valuable trade secret of Garmin. You agree not to decompile, disassemble, modify, reverse assemble, reverse engineer, or reduce to human readable form the Software or any part thereof or create any derivative works based on the Software. You agree not to export or re-export the Software to any country in violation of the export control laws of the United States of America.



Warning

Failure to avoid the following potentially hazardous situations could result in an accident or collision resulting in death or serious injury.

When navigating, carefully compare information displayed on the GPSMAP 2106/2110 to all available navigation sources, including information from visual sightings, and maps. For safety, always resolve any discrepancies or questions before continuing navigation.

Use the electronic chart in the GPSMAP 2106/2110 only to facilitate, not to replace, the use of authorized government charts. Official government charts and notices to mariners contain all information needed to navigate safely.

Use terrain and obstacle data only as an aid to situational awareness.

WARNING: This product, its packaging, and its components contain chemicals known to the State of California to cause cancer, birth defects, or reproductive harm. This Notice is being provided in accordance with California's Proposition 65. If you have any questions or would like additional information, please refer to our Web site at <http://www.garmin.com/prop65>.



Caution

Failure to avoid the following potentially hazardous situations may result in injury or property damage.

Use the GPSMAP 2106/2110 only as a navigational aid. Do not attempt to use the GPSMAP 2106/2110 for any purpose requiring precise measurement of direction, distance, location, or topography.

The Global Positioning System (GPS) is operated by the United States government, which is solely responsible for its accuracy and maintenance. The government's system is subject to changes which could affect the accuracy and performance of all GPS equipment, including the GPSMAP 2106/2110. Although the GPSMAP 2106/2110 is a precision navigation device, any navigation device can be misused or misinterpreted and, therefore, become unsafe.

Map Data Information: One of the goals of Garmin is to provide customers with the most complete and accurate cartography that is available to us at a reasonable cost. We use a combination of governmental and private data sources, which we identify in product literature and copyright messages displayed to the consumer. Virtually all data sources contain inaccurate or incomplete data to some extent. In some countries, complete and accurate digital data is either not available or is prohibitively expensive.

NOTICE: This Category II radiocommunication device complies with Industry Canada Standard RSS-310.

GETTING STARTED

Unit Overview

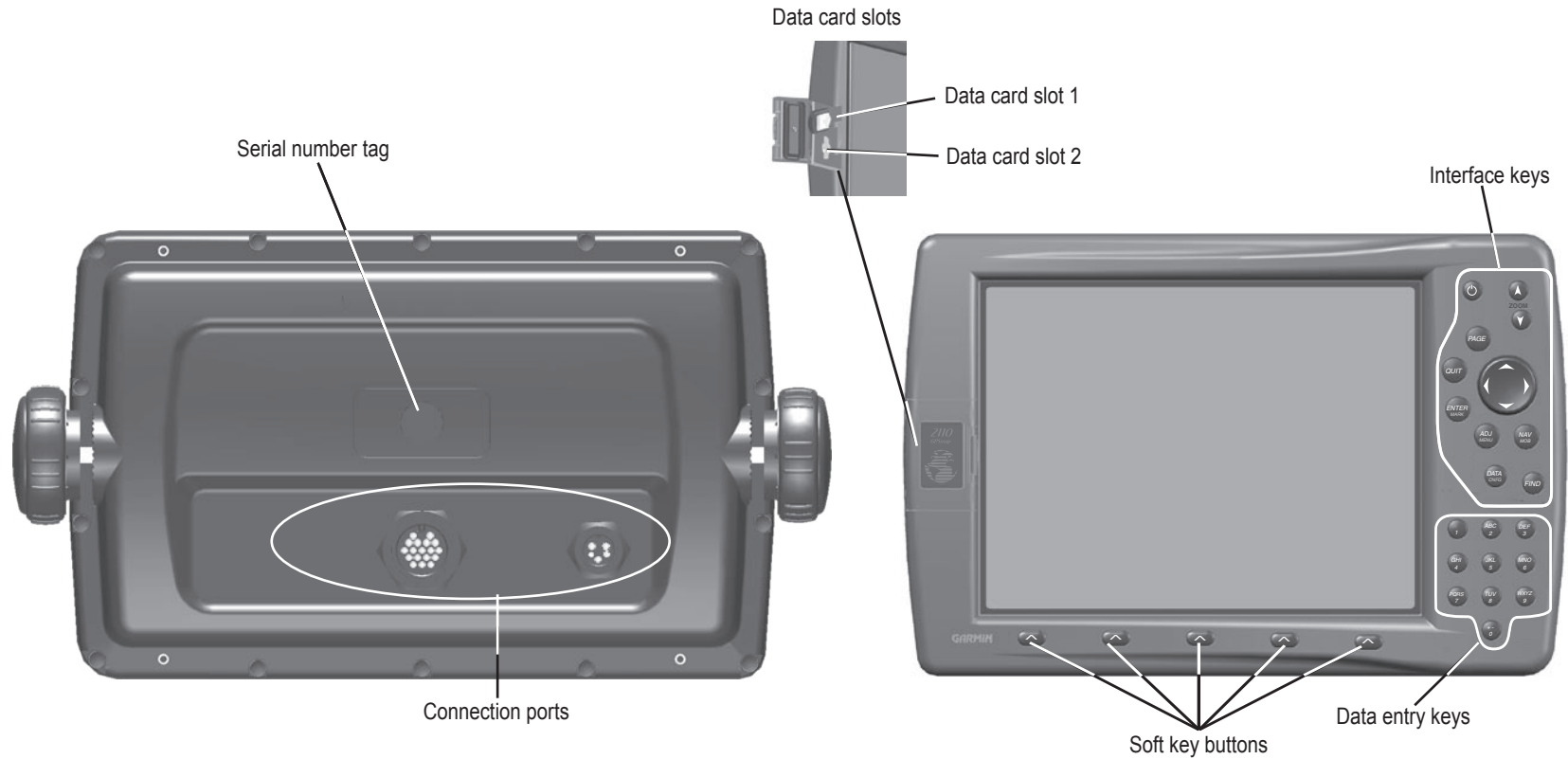

GPSMAP 2110 Shown

Using the GPSMAP 2106/2110 Keypad

POWER/BACKLIGHT Key

- Press and hold to turn the unit on or off.
- Press and release to adjust backlighting.

PAGE Key

- Press to cycle through the main pages in sequence.
- Press to end an operation in progress and return to the main page.

QUIT Key

- Press to cancel data entry or exit a page.

ENTER/MARK Key

- Press and release to enter highlighted items and data or confirm on-screen messages.
- Press and hold to mark your current location as a waypoint.

DATA/CNFG Key

- Press to toggle the display of a main page with or without function windows and data fields.
- Press and hold to open the Configuration window.



ZOOM Keys

- Press to zoom in or out on the map.

ROCKER Key

- Press up, down, right, or left to move through lists, highlight fields, enter data, or move the map pointer.

ADJ/MENU Key

- Press and release to view options for a page.
- Press and hold to open the Main Menu.

NAV/MOB Key

- Press to open the Navigation menu.
- Press and hold to mark a MOB waypoint and create a track back to the marked location.

FIND Key

- Press to search for points, such as user waypoints, cities, and services.

Using Soft Keys

Soft keys are located along the bottom of the display and are used as shortcuts to select the most commonly used options for the selected page, window, or tab. To select a soft key, press the soft key button (↖) directly below it.

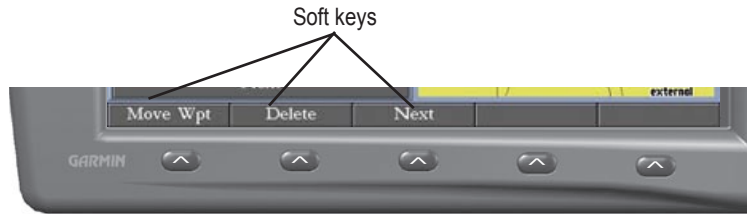

Using Data Entry/Shortcut Keys

Use the data entry keys to enter alphanumeric data into the unit, such as a waypoint name. Use data entry keys in conjunction with the **ROCKER**. Press the key once to select the first letter on the key, twice to select the second letter on the key, three times to select the third letter on the key, or four times to select the number on the key. For keys 7, 8, and 9, press the key five times to select the number on the key. When you have selected the correct letter or number, pause, and the unit advances the cursor to the next character automatically.



Use the shortcut keys to jump to main pages, or select menu and list options by pressing the corresponding number of the selection. For numbers 1-9, press the number to choose the selection. For numbers 10 and higher, press the first digit, then press the second digit within one second.

Status Bar

At the top of each page, the status bar provides current status information for connected devices and several of the MFD functions.

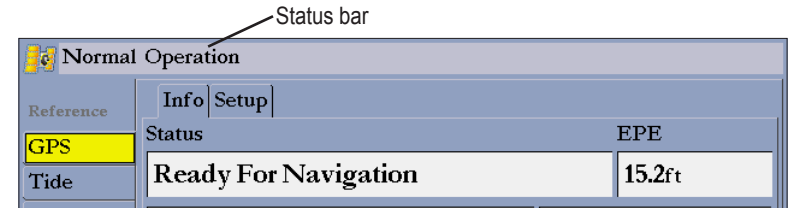

Alarm alerts also appear on the status bar. To acknowledge an alarm, press **QUIT**. If an alarm condition persists, it appears on the status bar until the alarm condition no longer exists. For more information about alarms, see pages [56-58](#).



Turning on the GPSMAP 2106/2110

Before you turn on the GPSMAP 2106/2110, make sure the unit and GPS 17 antenna are correctly installed on your vessel according to the instructions in the *GPSMAP 2106/2110 & GPS 17 Installation Instructions*.

The first time you turn on the GPSMAP 2106/2110, the GPS 17 receiver must collect satellite data and determine its current location. To ensure proper initialization, the GPSMAP 2106/2110 is shipped from the factory in AutoLocate mode.

To turn on the GPSMAP 2106/2110:

1. Press and hold the **POWER** key until the unit turns on.
2. When **I Agree** is highlighted on the Warning Page, press **ENTER** to open the Map Page.

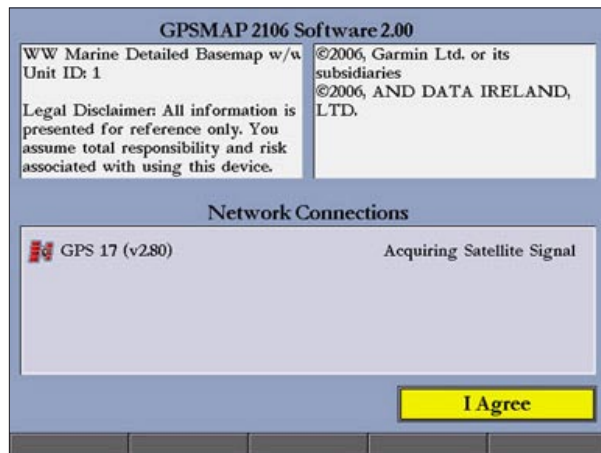

NOTE: The first time you turn on the unit, you are asked if you want to start the retail demonstration. Select **No**, and press **ENTER**.

To turn off the GPSMAP 2106/2110:

Press and hold the **POWER** key until the unit turns off.

Adjusting the Backlight

You can adjust the screen backlighting on the GPSMAP 2106/2110 from any page by using the **POWER/BACKLIGHT** key.

To adjust the backlight level:

1. Press and release the **POWER/BACKLIGHT** key.
2. Press up on the **ROCKER** to increase the brightness, or press down to decrease.



TIP: After you open the Backlight adjustment window, press the **POWER/BACKLIGHT** key repeatedly to cycle through the three backlight settings: Highest, Middle, and Lowest.

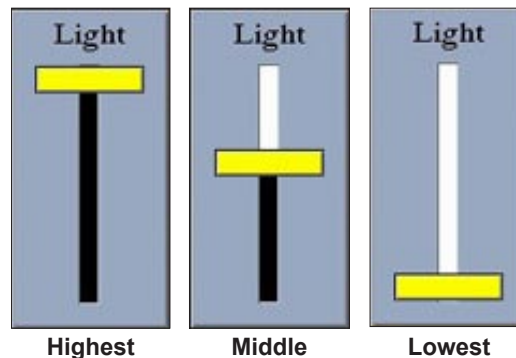

3. Press **ENTER** or **QUIT** to close the Backlight adjustment window.

Initializing the GPS Receiver

When you turn on the GPSMAP 2106/2110, a Warning Page appears, showing unit information, network connections (attached devices), and important information regarding the proper use of the unit. It takes a few seconds for the GPSMAP 2106/2110 to search for attached devices. When the search is complete, the **I Agree** button is highlighted. After reading the warning, press **ENTER**.

Next, you see the first of the main pages, the Map Page. The GPSMAP 2106/2110 begins searching for GPS satellites. The first time the unit acquires satellites takes several minutes. Afterward, acquisition times are quicker during normal use. The GPS status icon on the left side of the status bar shows the progress of the satellite acquisition process.

GPS status icon colors are:

- **Red**—acquiring satellites/lost satellite reception.
- **Orange**—ready for navigation/ready for navigation with WAAS.
- **Gray**—lost GPS connection. (Check GPS antenna wiring connections.)

A detailed visual reference of the satellite acquisition, GPS receiver status, and accuracy is available on the **GPS** tab on the Main Menu.

To view the GPS tab information:

1. Press and hold **ADJ/MENU** to open the Main Menu.
2. Use the **ROCKER** to highlight the **GPS** tab.

When viewing the GPS Info sub tab, a signal strength bar for each satellite in view appears on the right of the page, with the appropriate satellite number underneath each bar. The numbers below each bar represent the particular satellite that is being received. Numbers above 33 indicate WAAS satellites. For more information about WAAS, see the “[Appendix](#).”

The sky view shows a birds-eye view of the location of each satellite relative to the receiver’s last known location. The outer circle represents the horizon (north up), the inner circle 45° above the horizon, and the center point a location directly overhead. You can also set the sky view to track up, which causes the top of the sky view to align along your current track heading.

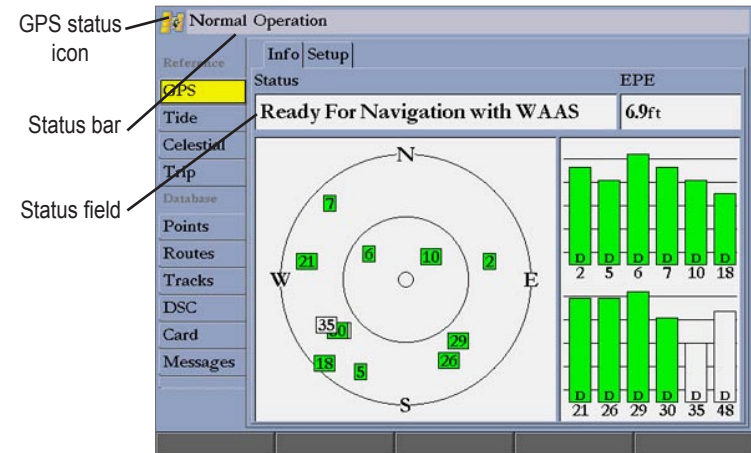

GPS Tab

The progress of satellite acquisition is shown in three stages:

- **No signal strength bars**—the receiver is looking for the satellites indicated.
- **Hollow signal strength bars**—the receiver has found the indicated satellite(s) and is collecting data.
- **Solid green signal strength bars**—the receiver has collected the necessary data and the satellite(s) are ready for use.

Receiver Status and Accuracy

The Status field on the Info sub tab shows the receiver status. Current accuracy is shown in the EPE (Estimated Position Error) field. Accuracy uses the number of received GPS satellites, signal strength, and satellite orientation, to calculate location accuracy in feet or meters. The Status field shows one of the following conditions:

- **Searching for Satellites**—the receiver is looking for any satellites and collecting data from satellites visible at its last known or initialized location, but has not collected enough data to calculate a fix. This process can take up to five minutes.
- **Ready For Navigation**—at least three satellites with good geometry were acquired, and your location is now being calculated in latitude and longitude; or at least four satellites were acquired and your location is being calculated in latitude, longitude, and elevation. “Ready For Navigation with WAAS” appears when you are receiving WAAS satellite corrections in 2D or 3D, and a D appears on the strength bar of satellites being corrected.

After the receiver has collected information from at least three satellites, the **Status** field shows either “Ready for Navigation” or “Ready for Navigation with WAAS.” The GPSMAP 2106/2110 is now ready for use. Press **QUIT** to return to the Map Page.

GPS Setup

The **Setup** sub tab provides access to functions and features relating to initializing the GPS receiver.

To access the GPS Setup sub tab:

1. Press and hold **ADJ/MENU** to open the Main Menu.
2. Highlight the **GPS** tab, and then highlight the **Setup** sub tab.

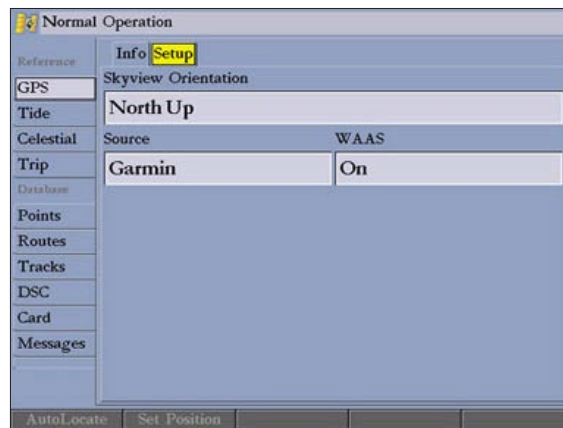

Setup Sub Tab

The Setup sub tab contains the following options:

Skyview Orientation—allows you to select a sky view orientation, either **North Up** or **Track Up**, for the GPS Info sub tab only.

Source—set to **Garmin** when using a Garmin sensor (GPS 17); set to **NMEA** when using any other GPS NMEA source.

WAAS—turns WAAS on or off.

The following soft keys are active only when the unit is not receiving satellites and the Source is not set to **Garmin**:

- **AutoLocate**—allows the receiver to find your location automatically. This process can take up to five minutes.
- **Set Position**—allows you to initialize the receiver from the Map Page to initially help the receiver acquire satellites more quickly.

Using Simulator Mode

Simulator Mode is great for practicing with the unit if you are indoors and satellite signals are not available. When the GPSMAP 2106/2110 is in Simulator Mode, the GPS receiver is turned off. You cannot use the unit for actual navigation.



NOTE: Do not try to navigate in Simulator Mode. While in Simulator Mode, the GPS receiver is turned off. Any satellite signal strength indicators shown are only simulations and do not indicate the strength of actual satellite signals.

To turn on Simulator Mode:

1. Press and hold **ADJ/MENU** to open the Main Menu.
2. Press up or down on the **ROCKER** to highlight the **System** tab.
3. Press right on the **ROCKER** to highlight the **General** sub tab.
4. Highlight the **System Mode** field, and press **ENTER**.
5. Highlight **Simulator**, and press **ENTER**.

When Simulator Mode is active, the message “Simulating Operation” appears in the status bar at the top of each page.

To set up Simulator Mode:

Highlight the **Setup** button, and press **ENTER**. The Simulator Setup window appears. The following options are available:

- **Current Time/Current Date**—enter a simulated date and time.
- **Speed**—enter a simulated speed.
- **Track Control**—select track control. **Auto Track** steers to the current navigation point; **User Track** allows you to enter a heading in the **Track** field.
- **Track**—enter a simulated heading.
- **Set Position**—set your location while in Simulator Mode.



Use the **Set Position** soft key to set your location while in Simulator Mode.

You can also control the speed and track from the Compass or Highway Page. Press up or down on the **ROCKER** to increase or decrease the speed; press left or right to change the heading.

To turn off Simulator Mode:

1. Press and hold **ADJ/MENU** to open the Main Menu.
2. Press up or down on the **ROCKER** to highlight the **System** tab.
3. Press right on the **ROCKER** to highlight the **General** sub tab.
4. Highlight the **System Mode** field, and press **ENTER**.
5. Highlight **Normal**, and press **ENTER**.

When Normal Mode is active, the message “Normal” appears in the status bar at the top of each page.

BASIC OPERATION

Using the GPSMAP 2106/2110

The advanced keypad system on the GPSMAP 2106/2110 is designed to allow you to select options and enter data quickly and conveniently. As you progress through this owner's manual, you are directed to press a specific key or highlight a field on the screen. When you are directed to press a key, you should press and quickly release the key. If you need to hold down the key for a period of time to activate a secondary function, the instructions tell you to do so. The location of the highlight is controlled by the **ROCKER**. When a field is selected on the screen, it is highlighted in yellow.

The following terms are used throughout this manual:

- **Highlight**—move the highlighted area on the screen up, down, left, or right with the **ROCKER** to select individual fields. Moving the highlight to a given location allows you to make a selection, begin data entry, or scroll through a list.
- **Field**—the location on a page where data or an option can be entered and displayed. Highlight a field using the **ROCKER** to begin entering data or selecting options.
- **Soft keys**—located along the bottom of the screen, soft keys are used as shortcuts to select the most commonly used options for the selected page, window, or tab. To select a soft key, press the soft key button (⏏) directly below it.
- **On-Screen button**—use the **ROCKER** to highlight an on-screen button, and press **ENTER** to select the button.

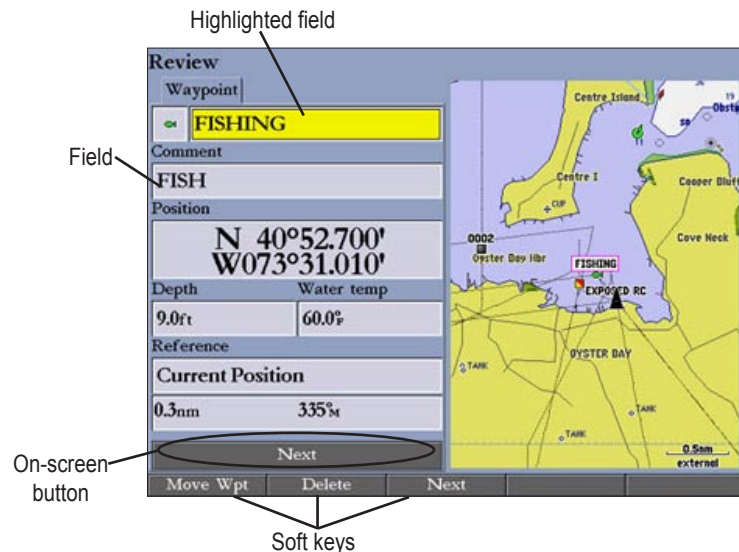

- **Scroll bar**—When viewing a list of items too long to show on the screen, a scroll bar appears along the right side of the list. To scroll through a list, press up or down on the **ROCKER**. Press right or left on the **ROCKER** to scroll one page at a time.
- **Default**—the factory setting saved in the unit's memory. You can change the settings, but you can also revert to the factory (default) settings when you press the **Factory Defaults** soft key on the System-General sub tab.

Selecting Options and Entering Data

To select options and enter data, use the **ROCKER** to highlight or select an item in a list or a field on the screen. Use the **ENTER** key, soft keys, data entry keys, and the **ROCKER** to select options, enter names and numbers in data fields, and activate your selections.

To select an optional feature:

- From any page, press **ADJ**. The adjustment menu shows a list of optional features specific to that page.

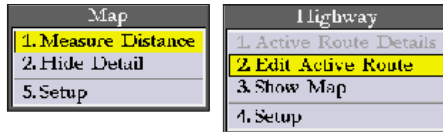

- Use the **ROCKER** to move the highlight up, down, left, or right to the selection you want, and press **ENTER** to select the option.
OR
Press the soft key below the option you want to select.

To select an on-screen button:

On a page with on-screen buttons, use the **ROCKER** to highlight an on-screen button, and press **ENTER**.

To select an option using soft keys:

Press the soft key  button below the soft key you want to select.

To select an option using data entry shortcut keys:

- From any page, press **ADJ**. The adjustment menu for the current page or selected function appears.
- Press the data entry key that corresponds to the option you want to select. For numbers 10 and higher, press the first digit, and then press the second digit within one second.

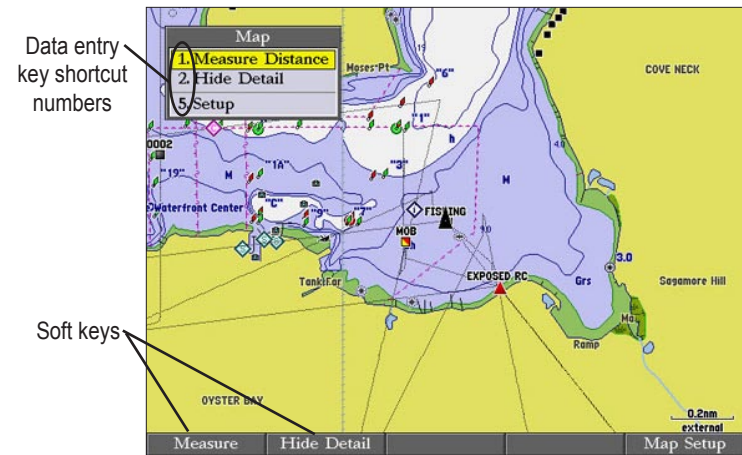

To exit a menu or return to the previous setting:

Press **QUIT**. The **QUIT** key moves backward through your steps. Press **QUIT** repeatedly to return to the starting page.

To enter data in a data field:

- Use the **ROCKER** to highlight the data field, and press **ENTER**.
- Press up or down on the **ROCKER** to select characters. Press and release the **ROCKER** to move character by character through the list; press and hold the **ROCKER** to move rapidly through the list.
- Press right on the **ROCKER** to move to the next character on the line or press left to move back to the previous character. Press left on the **ROCKER** from the first character position to clear the field. If there are more than two lines of data, keep pressing right on the **ROCKER** to go to the next line.
- Press **ENTER** to accept data and move to the next field.

Not all data fields are programmable. When moving about a page with these fields, the highlight skips them.

Using Additional Map Data

The GPSMAP 2106/2110 comes standard with a built-in basemap showing cities, interstates, coastline detail, and U.S. Tide stations. Optional preprogrammed Garmin data cards and MapSource CD-ROMs enhance the versatility of your GPSMAP 2106/2110. With optional BlueChart cartography, you can access marine nav aids, wrecks, obstructions, anchorage locations, shaded depth contours, intertidal zones, spot soundings, port plans, and more.

The GPSMAP 2106/2110 supports Garmin's new BlueChart® g2™ technology. This cartography features integrated mapping, 2-D or 3-D map perspective, tide and current data, improved IALA symbols, nav aids, marinas, boat ramps, roads, and more. You can also access additional data including highly detailed coastal roads and points of interest such as restaurants, lodging, and local attractions. Full-color aerial photographs of ports, marinas, bridges, and navigational landmarks are also included on many preprogrammed BlueChart g2 data cards.

See your Garmin dealer or visit the Garmin Web site (www.garmin.com) for more information on available preprogrammed Garmin data cards and other MapSource programs.

Using the Map Pointer

Use the map pointer to pan away from your current location and scroll to other map areas around the world (even outside of your current detail coverage). As you pan past the edge of the current map display, the screen actively scrolls forward to provide continuous map coverage. An hourglass symbol appears by the pointer while the unit is busy drawing new map detail.

Controlled by the **ROCKER**, the map pointer is an important tool that can be used to pan to other map locations, mark and edit waypoints and routes, and review location data of on-screen map items and waypoints.

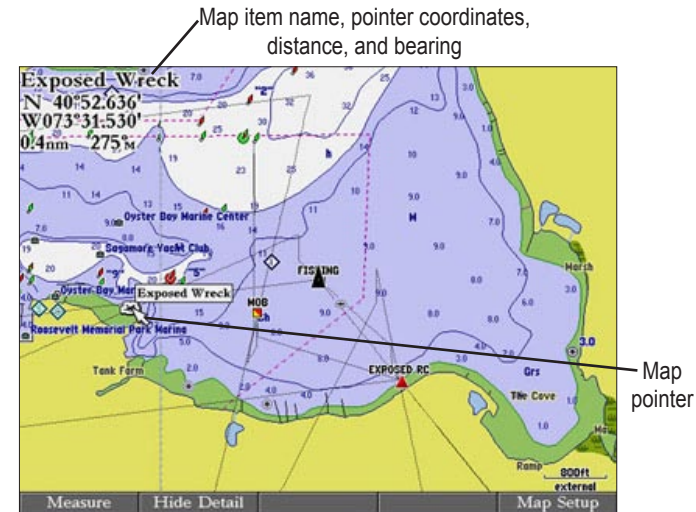

Using the Map Pointer (BlueChart Data Shown)

To move the map pointer:

Press the **ROCKER** to move the map pointer up, down, left, right, or diagonally.

As you move the map pointer, the distance and bearing from your present location to the map pointer are shown in the upper-left corner of the map, with the map pointer's location coordinates. Keep in mind that when the map pointer is stationary, the distance and bearing from your present location changes as your boat moves. The map pointer can also be used to snap to on-screen waypoints and map items, allowing you to review a selected location directly from the map.

To select an on-screen waypoint or map item with the map pointer:

1. Use the **ROCKER** to move the pointer to the waypoint or map item. When a waypoint or map item is selected, it is highlighted on-screen with the name and location shown.
2. Press **ENTER** to view details of the map item. When using BlueChart or MapSource data, or if waypoints are grouped tightly together due to the Range setting, additional tabs appear on the Review Waypoint Page. Use the **ROCKER** to highlight the individual tabs to view the information and additional options.

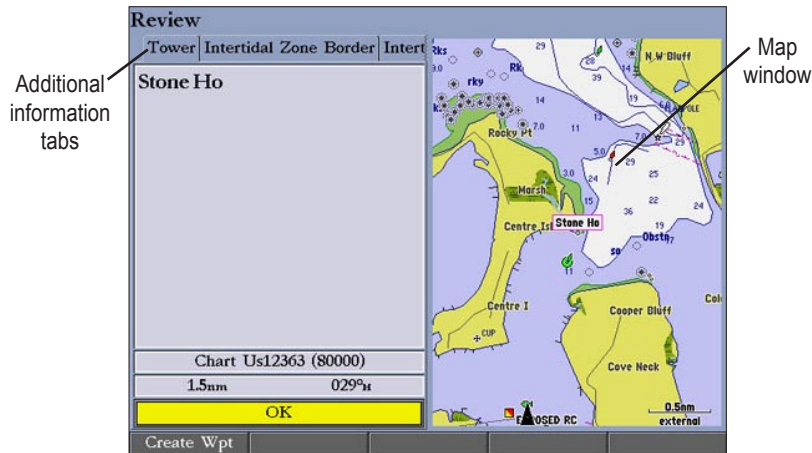

Viewing Additional Information (BlueChart Data Shown)

To eliminate the pointer and re-center your location on the map:
Press **QUIT**.

To view additional BlueChart or Bluechart g2 chart notes:

1. Select an on-screen BlueChart map item, and press **ENTER**.
2. Use the **ROCKER** to highlight the **Chart <name>** tab. A chart summary appears below the tab.
3. Highlight the **Notes** soft key, and press **ENTER**. Notes for the chart appear.

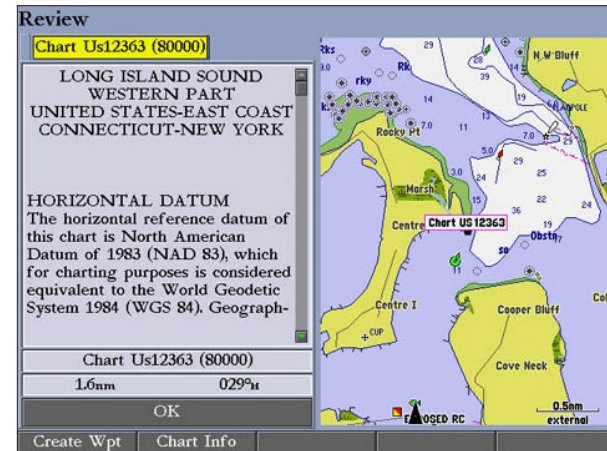

BlueChart Notes

4. Highlight the notes field, and press **ENTER**.
5. Use the **ROCKER** to scroll the text up or down.
6. Press **QUIT** to exit.

Finding an Item

Press **FIND** to search for items including waypoints, cities, geographic points, celestial information, tides, and currents. If you pan around on the map window and press **FIND**, the unit centers its search from the map pointer location. When using BlueChart, BlueChart g2, or MapSource data, your location or the map pointer must be within the map outline area to search for information from that area.

To find an item from your current location:

1. From any page, press **FIND** to open the Find From Current Position Page.

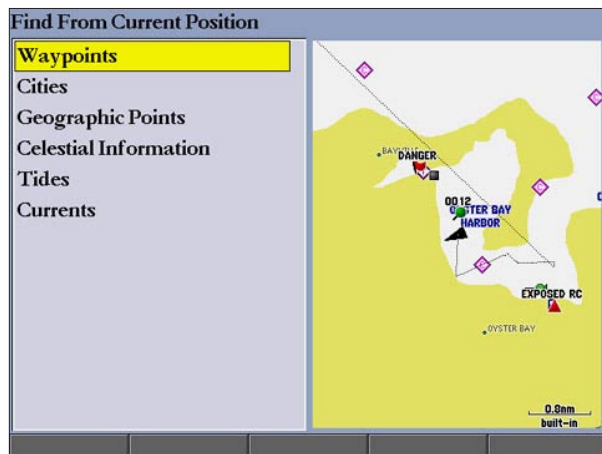

2. Highlight a category, and press **ENTER**. Select a subcategory, if necessary.
3. Some items have a **By Name** tab. For **By Name**, select the top field to spell out the name, or scroll through the list.

4. Some items have a **Filter List** button that allows you to enter letters or numbers of the item name. The search result shows only items matching the entered letters or numbers. Highlight the **Filter List** button, and press **ENTER**. Enter data, as needed, to narrow your search.

To find an item from another location on the map:

1. Open the Map Page. Use the **ROCKER** to pan to the location you want, and then press **FIND**. The Find From (Location) Page appears.
2. Using the **ROCKER**, highlight a category, and press **ENTER**.

To view details about an item:

Highlight an item in the search results list, and press **ENTER**. The Review Page appears, showing item information, map location, chart name, distance/bearing, and options for creating a waypoint or viewing the next item in the search results list.

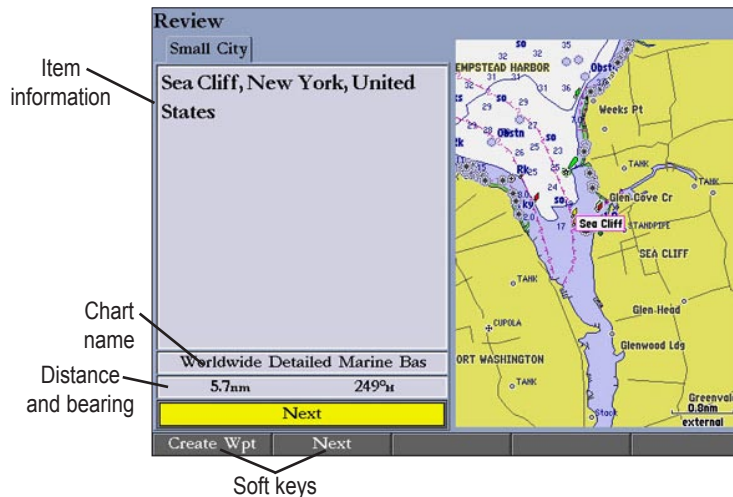

Creating and Using Waypoints

The GPSMAP 2106/2110 stores up to 4,000 alphanumeric waypoints, each with a user-defined icon, comment, depth, and water temperature.



NOTE: If you are using a Garmin GSD 21 or GSD 22 sounder module, the **Depth** and **Water Temp** fields fill in automatically.

You can create waypoints using three basic methods:

- **ENTER/MARK**—use the **ENTER/MARK** key to quickly mark your current location.
- **Graphically**—use the map display to define a new waypoint location.
- **Manually**—enter new waypoint coordinates manually.

Creating Waypoints Using the ENTER/MARK Key

Use the **ENTER/MARK** key to capture your current location (or pointer or map item location) to create a new waypoint. You must have a valid position fix to mark your current location.

To mark your current location:

1. Press and hold **ENTER/MARK** until the Review Waypoint Page appears. The GPSMAP 2106/2110 captures its current location and creates a default name and symbol for the new waypoint.
2. To accept the waypoint with the default name and symbol, press **ENTER**. To change any of the available waypoint information, see page 16.

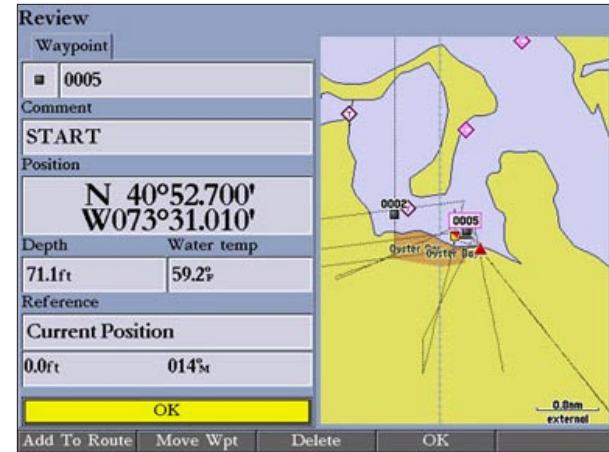

Review Waypoint Page (BlueChart Data Shown)

Creating Waypoints Using the Map

You can create a waypoint by using the map pointer to point to any map location or map feature. When you move the pointer over a map item, you see a highlighted description of the item.

To create a new waypoint using a map location:

1. Use the **ROCKER** to move the pointer to the map location you want.
2. Press and quickly release **ENTER/MARK** to capture the pointer location. Do not hold the button down; doing so marks your current location, not the map location. The Review Waypoint Page appears.
3. To accept the waypoint with the default information, press **ENTER**.
OR
To change any waypoint information, highlight the appropriate field and press **ENTER**. After entering your changes, press the **OK** soft key.

To create a new waypoint from a map feature:

1. Use the **ROCKER** to move the map pointer and highlight the map feature you want.
2. Press **ENTER/MARK** to capture the pointer location. The Review Page for the selected map feature appears.
3. Press the **Create Wpt** soft key to open the Review Waypoint Page.
4. To accept the waypoint with the default information, press **ENTER**.
OR

To change any waypoint information, highlight the appropriate field and press **ENTER**. After entering your changes, press the **OK** soft key.

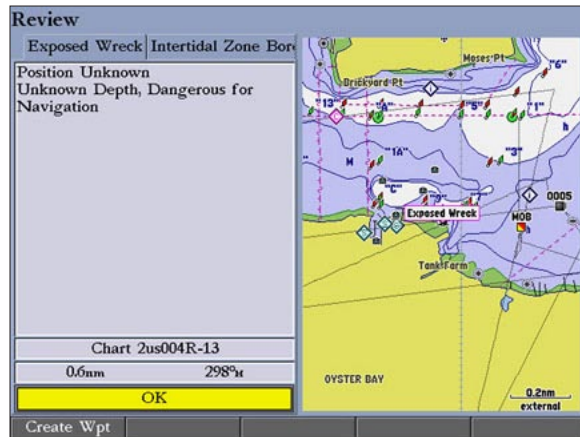

Creating a Waypoint from a Map Feature
(BlueChart g2 Data shown)



Creating Waypoints Manually

You can manually enter position coordinates to create a waypoint using the Points tab on the Main Menu. This method is useful for creating a waypoint at a specific latitude/longitude position from a chart or other source.

CAUTION: When entering a waypoint manually, be sure that the unit is set to the same position format and map datum as the paper chart or coordinates source. Entering coordinates into the GPSMAP 2106/2110 while it is set to a datum different from the datum in which the coordinates were created can result in an incorrect waypoint location.

Enter location coordinates manually.



Review Waypoint Page

To create a new waypoint by entering position coordinates:

1. Press and hold **ADJ/MENU** to open the Main Menu.
2. Highlight the **Points** tab. You can also mark your present location using the steps on page 13, and then proceed to step 4.

- Press the **New Waypoint** soft key. The Review Waypoint Page appears with the next available waypoint number and the receiver's last known location as the default name and location.
- Use the **ROCKER** to highlight the **Position** field, and press **ENTER**.
- Enter position coordinates using the **ROCKER** or data entry keys, and press **ENTER**.
- To accept the waypoint with the default information, press the **OK** soft key
OR
To change any waypoint information, highlight the appropriate field and press **ENTER**. After entering your changes, press the **OK** soft key.

Two other options are available on the Review Waypoint Page:

- Add to Route**—adds the new waypoint to the end of a route.
- Move Wpt** (waypoint)—moves or projects the waypoint to a new location on the map display.

To add a new waypoint to a route:

- Press the **Add To Route** soft key. The Select Route Page appears.
- Highlight a route or **New Route**, and press **ENTER**.
- Press the **OK** soft key to add the waypoint to the route.

For more information about using routes, see “[Creating and Using Routes](#),” beginning on page 23.

Reviewing and Editing Waypoints

After you create a waypoint, you can modify, review, rename, move, or delete it using the Review Waypoint Page. This page shows waypoint details, and a map window that you can pan or zoom in and out.

To access the Review Waypoint Page:

Use the **ROCKER** to highlight a waypoint on the Map Page, and press **ENTER**.

To access the Review Waypoint Page from a waypoint list:

- Press and hold **ADJ/MENU** to open the Main Menu. Use the **ROCKER** to highlight the **Points** tab, and then highlight a waypoint from the list.
- Press **ENTER** to open the Review Waypoint Page.



NOTE: Additional information tabs do not appear in this mode.

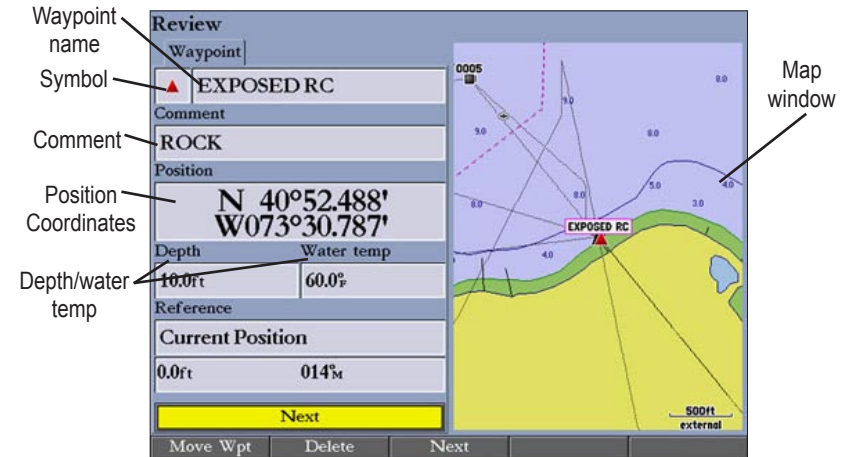

Review Waypoint Page

To change the waypoint name:

1. Highlight the waypoint name field, and press **ENTER**.
2. Use the **ROCKER** to enter a new name, and press **ENTER**.

To change the waypoint symbol:

1. Highlight the waypoint symbol field to the left of the waypoint name, and press **ENTER**.
2. Use the **ROCKER** to select a different symbol, and press **ENTER**.

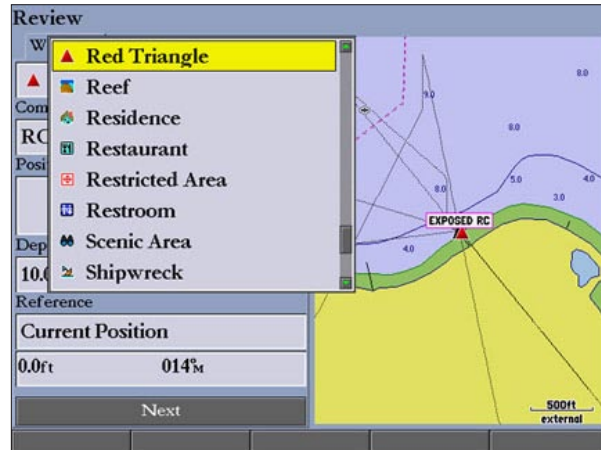

Waypoint Symbol List

To change the Comment, Position, Depth, or Water temp:

1. Highlight the **Comment**, **Position**, **Depth**, or **Water temp** field, and press **ENTER**.
2. Use the **ROCKER** to enter new data, and press **ENTER**.

To zoom in or out on the map window the Review Waypoint Page:

Press the Zoom Up or Zoom Down keys.

Moving a Waypoint

You can modify a waypoint by moving or “projecting” the distance and bearing from its present location to a new location.

To move the waypoint on the map:

1. Press the **Move Wpt** soft key. The map window on the right side of the page is highlighted with the selected waypoint centered and highlighted on a map display. The word **MOVE** appears below the pointer.
2. Use the **ROCKER** to move the waypoint to the new location. The distance and bearing from the waypoint’s current location appears in the upper-left corner of the map window.
3. Press **ENTER** to accept the new waypoint location.

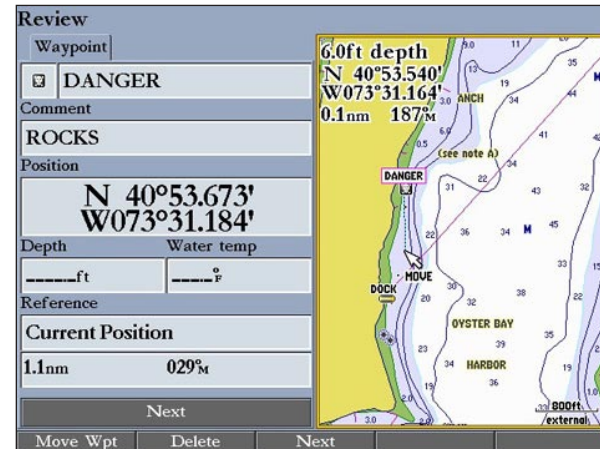

Using Waypoint Lists

The Points tab on the Main Menu has two sub tabs, **User** and **Proximity**, which allows you to manage a large number of waypoints quickly and efficiently. The Proximity sub tab also provides a continuously updated proximity waypoint alarm that you can use to define an alarm circle around submerged hazards or shallow waters.

To access the Points tab from the Main Menu:

1. Press and hold **ADJ/MENU** to open the Main Menu.
2. Use the **ROCKER** to highlight the **Points** tab, and highlight either the **User** or **Proximity** sub tab.

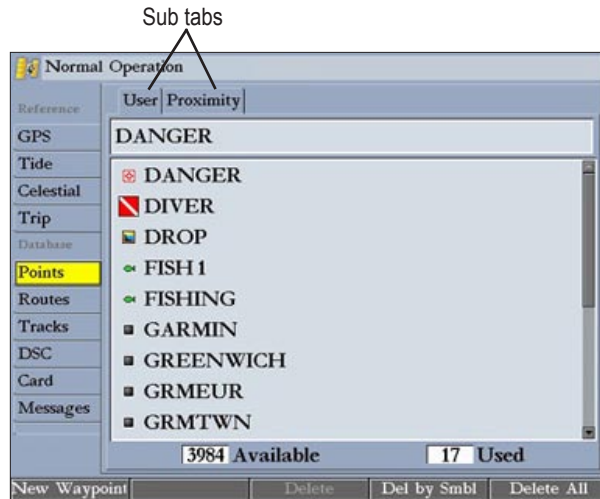

User Waypoints

The User sub tab on the Points tab shows a master list of all waypoints currently stored in memory. From the User sub tab, you can review, edit, rename, or delete individual waypoints, or delete all user waypoints. The number of available and used waypoints are shown at the bottom of the User sub tab. Stored waypoints are arranged in alphanumeric order.

To scroll through and review the waypoint list:

1. Use the **ROCKER** to highlight the **Points** tab on the Main Menu, and then highlight the **User** sub tab.
2. Press up or down on the **ROCKER** to scroll through the list of waypoints; press right or left on the **ROCKER** to scroll by page.
3. Press **ENTER** to review the highlighted waypoint on the Review Waypoint Page. See page 15 for information on reviewing and editing waypoints.
4. Press the **Next** soft key to return to the waypoint list. The next waypoint in the list is automatically highlighted.

Deleting Waypoints

The following soft keys are available when you highlight a waypoint on the User sub tab:

- **New Waypoint**—creates a new waypoint.
- **Delete**—deletes the selected waypoint from the list and from any route in which the waypoint was used.
- **Del by Smb1**—deletes waypoints that use the same symbol.
- **Delete All**—deletes all waypoints from the unit.



NOTE: When you delete a waypoint from the list, it cannot be recovered from the unit. Save important waypoints to a data card, or write them down.

To delete a single waypoint from the User sub tab:

1. Use the **ROCKER** to highlight the waypoint you want to delete, and then press the **Delete Waypoint** soft key. A confirmation message appears.
2. Highlight **OK**, and press **ENTER** to delete the selected waypoint.

To delete waypoints by symbol:

1. On the **User** sub tab, highlight the waypoint you want to delete.
2. Press the **Delete By Symbol** soft key.
3. Use the **ROCKER** to highlight the symbol of the waypoints you want to delete, and press **ENTER**.
4. Highlight **OK**, and press **ENTER** to delete the waypoints by symbol. Otherwise, highlight **Cancel**, and press **ENTER** to return to the User sub tab without deleting any waypoints.

To delete all user waypoints:

1. On the **User** sub tab, press the **Delete All** soft key.
2. Highlight **OK**, and press **ENTER** to delete all user waypoints.

Proximity Waypoints

Use the Proximity sub tab to define an alarm circle around a stored waypoint. The alarm circle can help you avoid reefs, rocks, or restricted waters. You can add proximity alarms to a maximum of 10 waypoints or on-screen map items, with a maximum alarm radius of 99.99 nautical or statute miles, or kilometers.

If a proximity alarm circle overlaps an existing alarm circle, the message “Proximity Overlaps Another Proximity Waypoint” appears. Because the unit only alerts for one of the overlap points, use caution when navigating in these areas. If your boat enters a red proximity circle overlap, you are alerted only to the closest proximity waypoint.

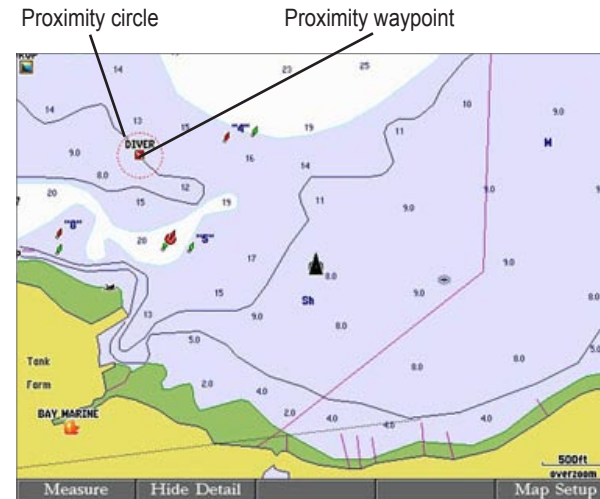

To add a proximity waypoint:

1. Press the **New Alarm** soft key on the **Proximity** sub tab. The Find From Current Position Page appears.
2. Highlight a category, and press **ENTER**.
3. Use the **ROCKER** to highlight a waypoint or map item, and press **ENTER**. The Review Page appears for the selected waypoint or map item within a red circle.
4. Press the **OK** soft key. The Proximity sub tab appears with the **Distance** highlighted.
5. Press **ENTER**, and use the **ROCKER** to enter a proximity radius (up to 99.99 units).
6. Press **ENTER** when finished.

To turn proximity alarms on or off:

1. Use the **ROCKER** to highlight the field below **Proximity Alarm** on the **Proximity** sub tab, and press **ENTER**.
2. Select **ON** or **OFF**, and press **ENTER**.

To clear one or all proximity waypoints from the list:

1. Use the **ROCKER** to highlight the proximity waypoint you want to clear.
2. To clear a single alarm, press the **Delete** soft key.
OR
To clear all proximity waypoints, press the **Delete All** soft key. A confirmation message appears.
3. Press the **OK** soft key to delete the proximity waypoint. Otherwise, press the **Cancel** soft key, or press **QUIT** to cancel.

Navigating to a Destination

Using the **NAV** key, the GPSMAP 2106/2110 provides four ways to navigate to a destination: Go To Point, Follow Track, TracBack, and Follow Route. When you are actively navigating, you see a straight line on the Map Page that always runs from your current location to the destination. The easiest method for selecting a destination is the Go To function, which allows you to select a destination point, and then set a direct course to it from your present location. If you highlight a point on a list or the map and press **NAV**, **Go To <point name>** appears in addition to **Go To Point**. The Go To function can be accessed from any list of points or from the map display.

**Navigating to a Destination**

To Go To a point:

1. Press **NAV**.
2. Highlight **Go To Point**, and press **ENTER**. The Find From Current Position Page opens.
3. Highlight **Waypoints**, and press **ENTER**. (You can also choose to go to other points from this list, such as cities or Tide Stations.)
4. Select a waypoint, and press **ENTER** to open the Review Waypoint Page for the selected waypoint.
5. Press the **Go To** soft key to begin navigation. A magenta line appears on the map display showing the course from your present location to the Go To point.

To stop navigation:

1. Press **NAV**.
2. Highlight **Stop Navigation**, and press **ENTER**.

Selecting a Map Item Go To Destination

A Go To can be used to select one of three items from the map display—an existing waypoint, on-screen map items such as rivers, cities, nav aids, or a new map point. If you select a map item as the Go To destination, the GPSMAP 2106/2110 automatically uses the name of the map item, but the point is not stored in the waypoint list. If you select a new map point (non-map item) as the Go To destination, the GPSMAP 2106/2110 automatically creates a waypoint named **MAP** at the pointer location.

To Go To an existing waypoint or map item from the map display:

1. Use the **ROCKER** to highlight the waypoint or map item to which you want to navigate on the Map Page, and press **NAV**.
2. On the Navigation menu, highlight **Go To <waypoint name>**, and press **ENTER**.

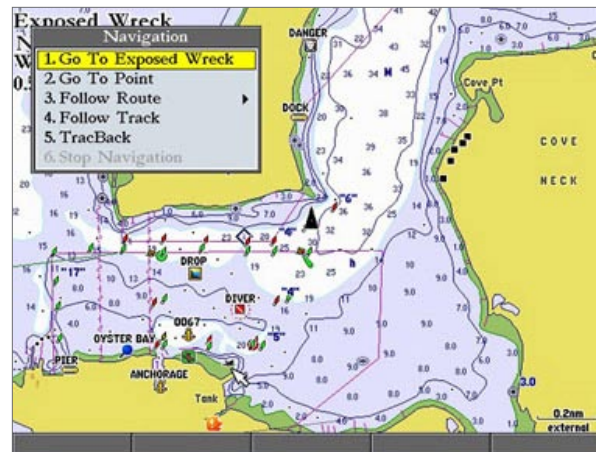
**To Go To a new map point (non-map item) from the map display:**

1. Use the **ROCKER** to move the pointer to the location you want to go to, and press **NAV**.
2. With **Go To MAP Point** highlighted, press **ENTER**.

To stop navigation:

1. Press **NAV**.
2. Highlight **Stop Navigation**, and press **ENTER**.

Follow Track and TracBack Navigation

A track is an electronic breadcrumb trail recording or history of your path. The track currently being recorded is the “active” track. An active track can be stored or saved in the unit. Both the Follow Track and TracBack options navigate in the same way. Follow Track uses stored or “saved” tracks; TracBack uses your current or “active” track.

TracBack allows you to retrace your path using the track log stored in the receiver's memory, which eliminates the need to store waypoints along the way. TracBack routes are created by reducing your track log into a route and activating an inverted route. When active, a TracBack route leads you through your stored track log points, so it is a good idea to clear the existing track log before you start your current trip.

To clear the track log:

1. Press and hold **ADJ/MENU** to open the Main Menu.
2. Using the **ROCKER**, highlight the **Tracks** tab, and then highlight the **Active** sub tab.
3. Press the **Clear** soft key. A confirmation message appears.
4. Press the **OK** soft key to clear the track log.

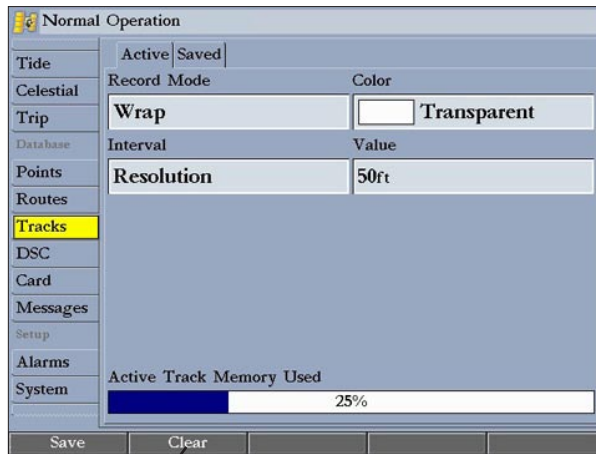

Clear soft key

Saving a Track Log

You must save a track log before you can use the Follow Track feature. You can store up to 15 track logs from certain times and dates.

To save a track log:

1. Press and hold **ADJ/MENU** to open the Main Menu.
2. Use the **ROCKER** to highlight the **Tracks** tab, and then highlight the **Active** sub tab.
3. Press the **Save** soft key, and press **ENTER**. The Save Back Through window appears.
4. Highlight the time or date of the track you want to save, or highlight **Entire Log**, and press **ENTER**. The track begins saving, and then the Saved Track Page appears. The default name, distance, number of points (700 maximum), and a map overview are shown.

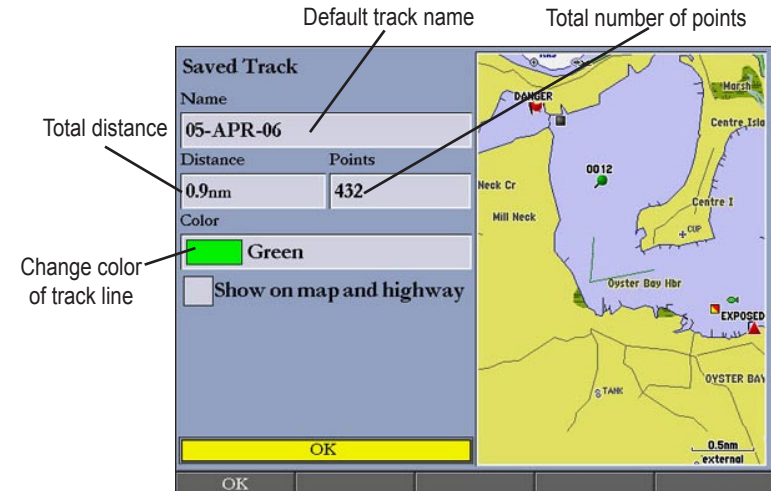

5. To change the name of the saved track, highlight the **Name** field and press **ENTER**, make any changes, and press **ENTER** again.
6. To specify the color used to show the saved track line on the map and highway, highlight the **Color** field and press **ENTER**, choose a color, and press **ENTER** again.
7. To show the track on the Map and Highway Pages, highlight the check box to the left of **Show on map and highway**, and press **ENTER**.
8. Press the **OK** soft key to save the track log.

To review and edit a track:

1. On the **Saved** sub tab, highlight a track and press **ENTER** to open the Saved Track Page.
2. Make any changes, and then press **QUIT**.

Initiating a Follow Track

You must save a track before using the Follow Track option. If there are no saved tracks, the message “There are no Saved Tracks to follow” appears.

To follow a track using the NAV key:

1. Press **NAV**, highlight **Follow Track**, and press **ENTER**. The Select Track Page appears.
2. Highlight the track you want to follow, and press **ENTER**.
3. To invert the Follow Track (navigate it in the reverse direction), press **NAV**, highlight **Invert Route**, and press **ENTER**.

To start a TracBack using the NAV key:

1. Press **NAV** to open the **Navigation** menu.
2. Highlight **TracBack**, and press **ENTER**. The TracBack Through window appears.
3. Highlight the time, date, or **Entire Log**, and press **ENTER**.

To stop TracBack navigation:

1. Press **NAV**.
2. Highlight **Stop Navigation**, and press **ENTER**.

TracBack Tips

When a TracBack is active, the GPSMAP 2106/2110 takes the track log stored in memory and divides it into segments called legs. Up to 300 temporary turns (BEGIN, TURN 1, TURN 2, ..., TURN X, END) are created to mark the most significant features of the track log to duplicate your exact path as closely as possible. To get the most out of the TracBack feature, remember the following tips:

- Always clear the track log at the starting point.
- The Record Mode option on the track log setup page must be set to **Fill** or **Wrap**.
- At least two track log points must be stored in memory to create a TracBack route.
- If the track log Interval field is set to **Time**, the route may not follow your exact path (keep the interval set to **Resolution** for best performance).
- If the receiver is turned off or satellite coverage is lost during your trip, TracBack draws a straight line between any point where coverage was lost and where it resumed.
- If your track log’s changes in distance and direction are too complex, 300 waypoints might not mark your path accurately. The receiver then assigns the 300 waypoints to the most significant points of your track, and simplifies segments with fewer changes in direction.

Man OverBoard (MOB)

Use the Man OverBoard function to simultaneously mark and set a course to a location for quick response to emergency situations.

To initiate the MOB function:

1. Press and hold the **NAV/MOB** key.
2. Press the **Yes** soft key to confirm and begin navigating to the MOB location.

When a MOB is initiated, a MOB waypoint with an international MOB symbol () is created, and the unit is on an active navigation to that point. Use any of the navigation pages to guide you back to the MOB point. The MOB waypoint is stored in the waypoint list, and you can delete or edit it like any other waypoint.

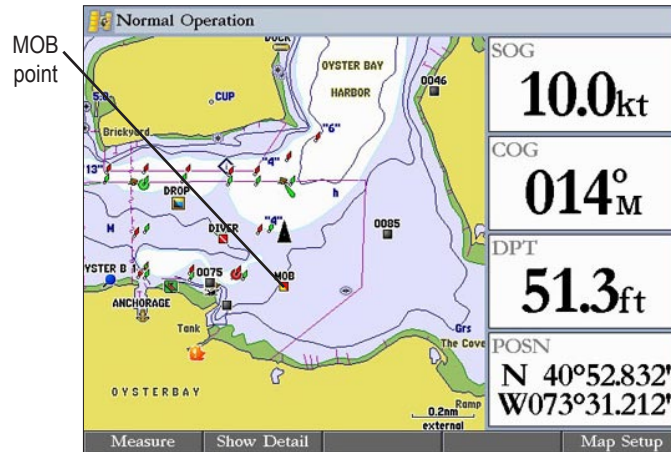

To stop navigation to the MOB location:

1. Press **NAV/MOB** to open the Navigation menu.
2. Highlight **Stop Navigation**, and press **ENTER**.



Creating and Using Routes

You can create and store up to 50 reversible routes (numbered 1–50), with up to 300 points each.

Creating a New Route

Using the Route tab on the Main Menu, you can create a new route in one of two ways. You can select waypoints or map items on the map window, allowing you to see each route point on the screen as you create the route, or you can select waypoints from the waypoint list, allowing you to see a list of the route points as you create the route.

To create a new route using the map window:

1. Press and hold **ADJ/MENU** to open the Main Menu.
2. Use the **ROCKER** to highlight the **Routes** tab.
3. Press the **New Route** soft key. The Route map window appears, and the position marker () changes to the map pointer () with "ADD" underneath it.
4. Use the **ROCKER** to highlight the location you want to add to your route, and press **ENTER**. As you add each new waypoint to the route, the upper-left corner of the screen shows the waypoint name. The bottom of the screen shows you the number of available points. Repeat this step until you finish defining all route waypoints.



NOTE: If you select an area of the map that is not a feature or waypoint, a new waypoint is created for that location.

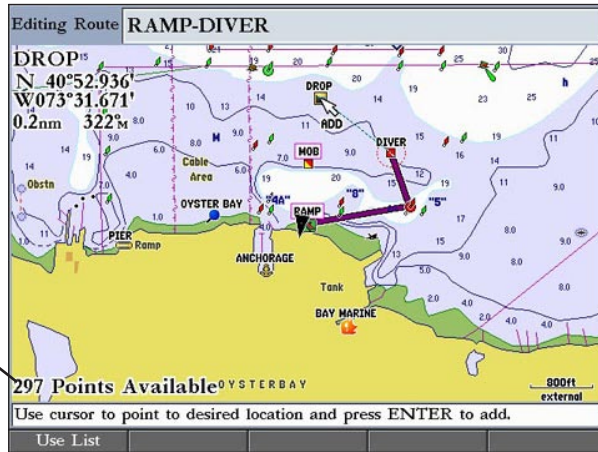

Editing Route RAMP-DIVER			
Waypoint	Distance	Course	ETA
RAMP	0.0ft		08:51AM
"6"	0.2nm	094°M	08:52AM
DIVER	0.3nm	355°M	08:52AM
-----	-----nm	-----°M	-----AM
		0.3nm	063°M

Route List with Information

To create a new route using the Route list:

1. Press and hold **ADJ/MENU** to open the Main Menu.
2. Use the **ROCKER** to highlight the **Routes** tab.
3. Press the **New Route** soft key to open the Route map window.
4. Press the **Use List** soft key to open the Route list.
5. Use the **ROCKER** to highlight the first field under the word "Waypoint," and press **ENTER**. The Find From Current Position Page appears.
6. Highlight **Waypoints**, and press **ENTER**. (You can also choose from other points, such as Cities or Nav aids.)
7. Select a waypoint to add to the route, and press **ENTER**. The Review Waypoint Page appears.
8. Press the **OK** soft key to add the point to the route. As you add each new waypoint to the route, the Route list shows the waypoint or map item name, leg distance, course between points, and a selectable column to show other route information.

9. Repeat steps 5–8 until all route points are entered. Press **QUIT** to return to the Route Page.

Navigating a Saved Route

After you create a route, press the **NAV** key to navigate it. You can follow a route in the same sequence as it was originally created, invert and follow the route from the end point back to the beginning point, or re-evaluate it.

To navigate a saved route:

1. From any page, press **NAV**, and then highlight **Follow Route** on the Navigation menu.
2. Press the **Pick Saved** soft key to select a saved route. The Select Route window opens.
3. Use the **ROCKER** to highlight the route you want to navigate, and press **ENTER**. The selected route is shown on the Map Page.



To stop navigating a route:

Press **NAV**, highlight **Stop Navigation** on the Navigation menu, and press **ENTER**.

The following options are available on the Navigation menu by pressing **NAV** while navigating a route:

- **Invert Route**—reverses the route so you can follow it from the end point back to the beginning.
- **Re-Evaluate Route**—recalculates and reactivates the current route data; and it selects the route leg closest to your current location as the active leg (the active leg defines the current from and to waypoints).

Creating a Quick NAV Route

Use the **Create QUICK** soft key to create a quick route that you can begin navigating immediately.

To create and navigate a QUICK NAV route:

1. Press **NAV/MOB**, and highlight **Follow Route**.
2. Press the **Create QUICK** soft key.
3. Use the map pointer to select a waypoint or map item, and press **ENTER**.
As you add each new waypoint to the route, the data window at the top of the Map Page shows the waypoint or map item name, bearing and distance from your location, and coordinates of the map pointer. The bottom of the screen shows the number of available points. A route line appears on the map to indicate each completed leg, and a dotted line appears indicating the distance and bearing to the arrow pointer from the last route waypoint.
4. Repeat step 3 until you finish adding all route waypoints.
5. Press **QUIT** twice to start your quick nav route.

Copying a Route

Use the **Copy** soft key on the Route tab to copy an existing route.

To copy a route:

1. Press and hold **ADJ/MENU** to open the Main Menu, and then highlight the **Routes** tab.
2. Use the **ROCKER** to select the route you want to copy, and press the **Copy** soft key. The map window for the new route opens. The copied route uses the same route name with an additional number (starting at 1) at the end of the route name.

Deleting a Route

Use the Route tab on the Main Menu to delete an individual route or delete all routes.

To delete an individual route:

1. Press and hold **ADJ/MENU** to open the Main Menu, and then highlight the **Routes** tab.
2. Use the **ROCKER** to select the route you want to delete, and then press the **Delete** soft key. A confirmation message appears.
3. Highlight **OK**, and press **ENTER** to delete the route.

To delete all routes:

1. Press and hold **ADJ/MENU** to open the Main Menu, and then highlight the **Routes** tab.
2. Press the **Delete All** soft key. A confirmation message appears.
3. Highlight **OK**, and press **ENTER** to delete all routes.

Editing a Route

After you create or copy a route, use the Route tab to add, edit, or delete points from a route or rename a route.

To change the name of a route:

1. On the **Routes** tab, highlight the route you want to edit, and press **ENTER**. The map window opens showing the selected route.
2. Press the **Rename Route** soft key. The first character in the **Editing Route** field is highlighted.

Editing
Route field

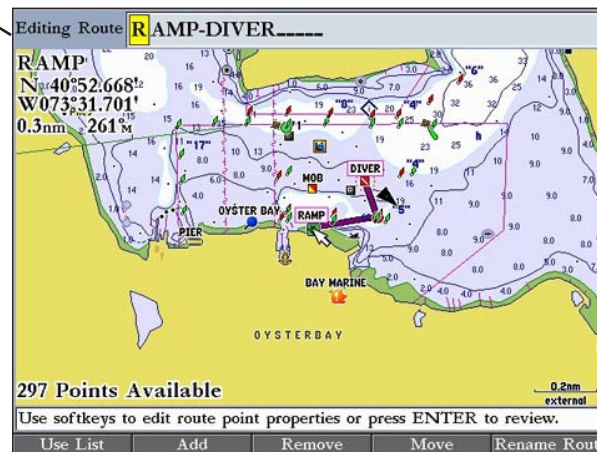

3. Use the **ROCKER** or data entry keys to change the route name, and press **ENTER** when finished.

To review individual route points on the map:

1. On the **Routes** tab, highlight the route you want to edit, and press **ENTER**. The map window opens showing the selected route.
2. Highlight a point on the route, and press **ENTER** to open the Review Waypoint Page.

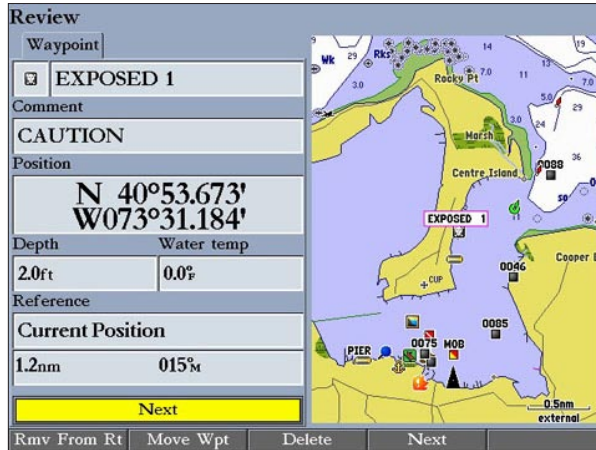

Review Waypoint Page

3. Press the **Rmv From Rt** soft key to remove the point from the route, press the **Move Wpt** soft key to move the waypoint, press the **Delete** soft key to permanently delete the waypoint from the unit, or press the **Next** soft key to highlight the next point on the route list. If the selected route point is a user waypoint, you can edit any of the waypoint properties on the Review Waypoint Page.

To add points to a route:

1. On the **Routes** tab, highlight the route you want to edit, and press **ENTER**. The map window opens, showing the selected route.
2. Move the map pointer to the leg of the route where you want to add the new point. The selected route leg turns yellow.

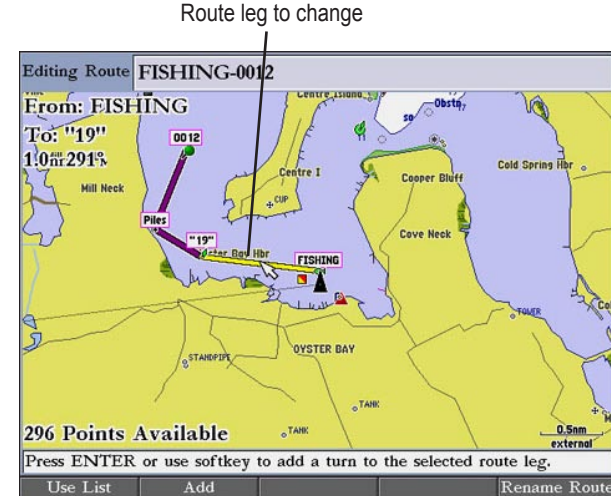

3. Press the **Add** soft key. The color of the selected route leg changes to magenta and the word "ADD" appears below the map pointer.

4. Use the **ROCKER** to drag the map pointer to the location where you want to add a route point.
5. Press **ENTER** to add the point to the route.

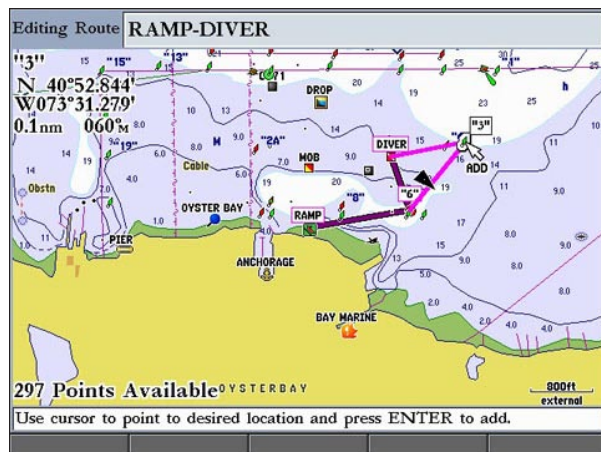

To remove a point from a route:

1. On the **Routes** tab, highlight the route you want to edit, and press **ENTER**. The map window opens showing the selected route.
2. Select the point you want to remove from the route, and press the **Remove** soft key.

To graphically edit a route on the map:

1. On the **Routes** tab, highlight the route you want to edit, and press **ENTER**. The map window opens showing the selected route.
2. Use the **ROCKER** to highlight a point to review (waypoint or map item).
3. Press the **Move** soft key to move the selected point. The word "MOVE" appears below the map pointer.

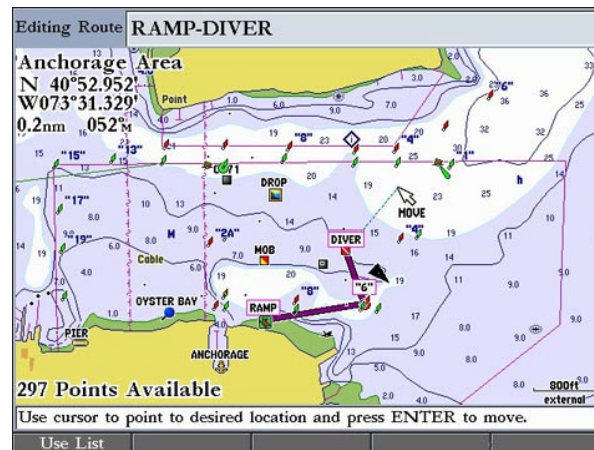

4. Use the **ROCKER** to drag the map pointer to the location where you want to move the route point, and then press **ENTER** to move the route point.

Planning Routes

After you create a route, you can enter information on the Plan Route window such as your speed, departure time, fuel flow, and departure date so your GPSMAP 2106/2110 can estimate information about your trip.

To plan your route:

1. Press the **Plan** soft key on the Route list to open the Plan Route window.
2. Enter planning data for speed and fuel flow. You can also enter the date and time of your departure. As you enter planning information, the fields on the Route list are automatically calculated.



NOTE: Fuel flow rates are measured in units per hour. System setting changes for units of measure (statute, nautical, or metric) do not affect the fuel flow measure. You should enter fuel flow rates based on available information for your boat (operators manual, performance specifications) and note the units of measure (gallons, liters, and so on).

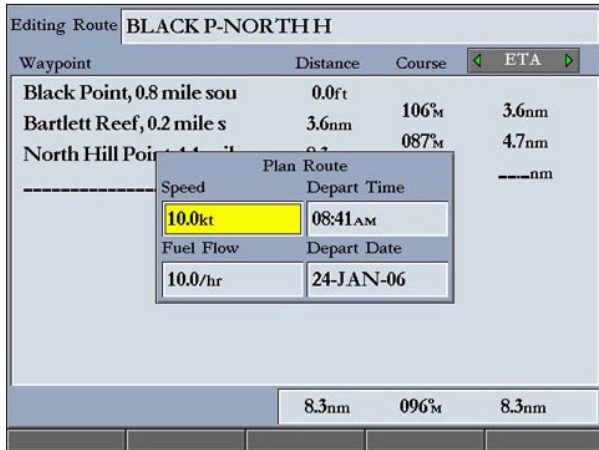

3. Press **QUIT** to return to the Route List.

To change the data column (Plan Route feature):

1. On the Route list, highlight the adjustment button to the right of the **Course** column header, and press **ENTER**. The middle title is highlighted.

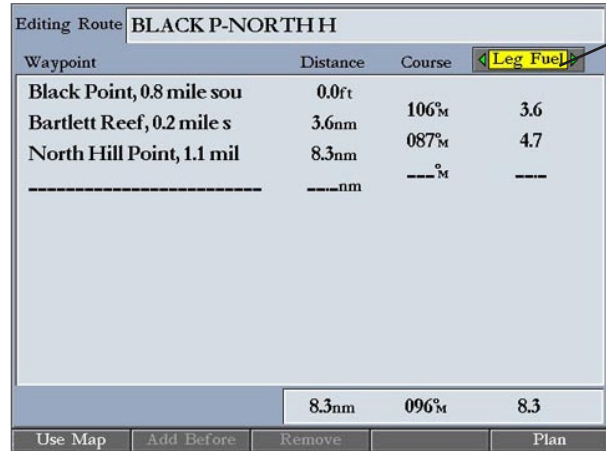

Planning features

2. Press left or right on the **ROCKER** to select one of nine available planning features, including **ETA** (Estimated Time of Arrival at point), **Fuel** (to point), **Leg Dist**, **Leg Fuel**, **Leg Time**, **Sunrise**, **Sunset** (at point location), and **Time To** (point).
The unit automatically recalculates each waypoint in the route based on the planning feature selected.
3. Press **ENTER** when you are finished.

MAIN PAGES

The GPSMAP 2106/2110 has four main pages that are always available: Map Page, Map Split Page, Compass Page, and Highway Page. For more information, see page 74. If you have a GSD 20, GSD 21, or GSD 22 with transducer connected to the GPSMAP 2106/2110, a Sonar Page is added to the page sequence. Press **PAGE** to cycle through the main pages in order.



Map Page



Map Split Page

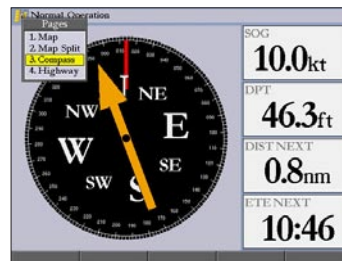

Compass Page

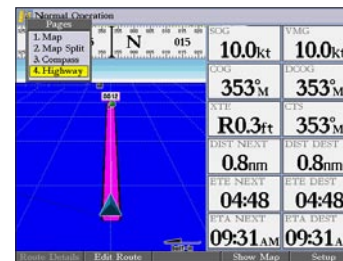

Highway Page

To go to a specific main page:

1. Press **PAGE**. The Pages menu shows the list of available main pages and their corresponding shortcut numbers. The active main page is highlighted.
2. Press up or down on the **ROCKER** to highlight a main page, or press the data entry key that corresponds to the shortcut number of the main page you want to view, and press **ENTER**.

Configuring Main Pages

Use the Configuration window to customize each main page to fit your navigational needs. You can show other functions, such as a compass, temperature log (if inputting Garmin or NMEA sonar data), or a second map (Map Split Page only) on a main page. You can also change the type of data shown in the Digital 1 and Digital 2 data fields.

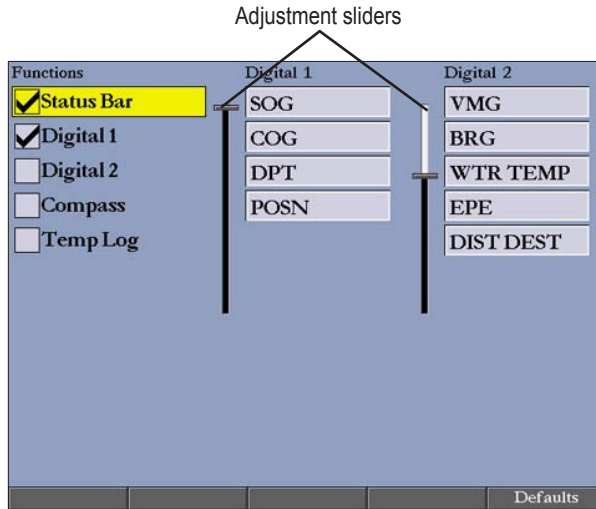

Configuration Window

To add or remove functions on a main page:

1. Press and hold **DATA/CNFG** to open the Configuration window.
2. Using the **ROCKER**, highlight the function you want to add or remove, and press **ENTER**. Only functions with a check mark in the check box to the left of the name appear on the main page.
3. When finished, press **QUIT** to return to the main page.

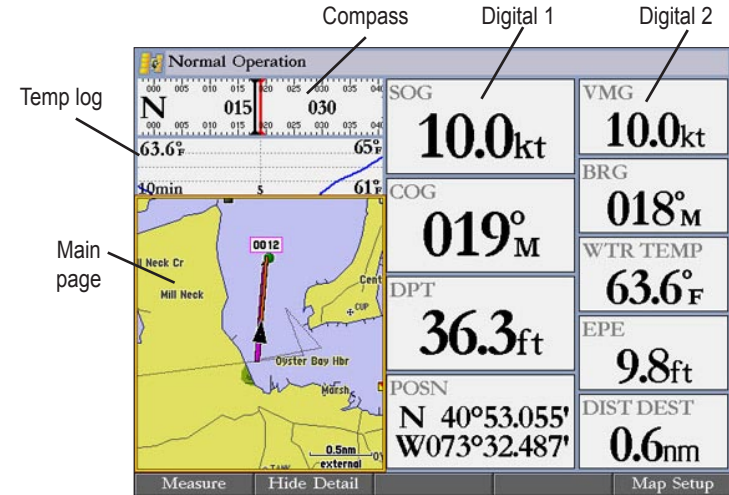

Map Page with Additional Functions

To change the size of the Digital data fields:

1. Press and hold **DATA/CNFG** to open the Configuration window.
2. Using the **ROCKER**, highlight the **Digital 1** or **Digital 2** adjustment slider, and press **ENTER**.
3. Press up on the **ROCKER** to show larger text with fewer data fields; press down on the **ROCKER** to show smaller text with more data fields. As you adjust the data field size, the configurable data fields automatically appear in the Digital 1 and Digital 2 lists.
4. Press **QUIT** to exit the slider adjustment. Press **QUIT** again to return to the main page.



To change Digital 1 or Digital 2 data fields:

1. Press and hold **DATA/CNFG** to open the Configuration window.
2. Highlight the data field you want to change, and press **ENTER**.

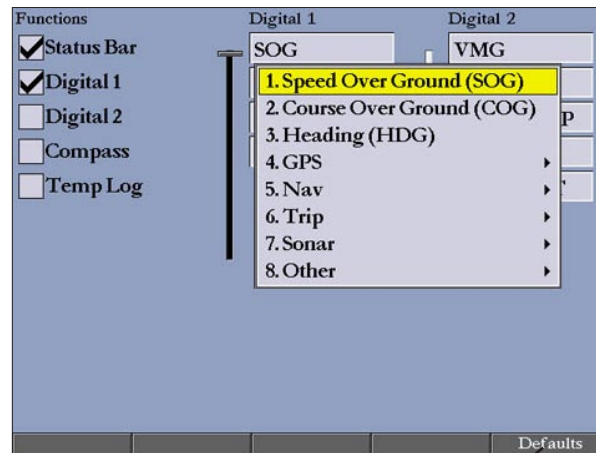

Defaults soft key

3. Press up or down on the **ROCKER** to highlight the type of data you want to show, and press **ENTER**.
4. Press **QUIT** to exit.

To restore the factory default configuration:

1. Press and hold **DATA/CNFG** to open the Configuration window.
2. Press the **Defaults** soft key.

Using Function Windows

You can add a second function window to the Map Split Page.

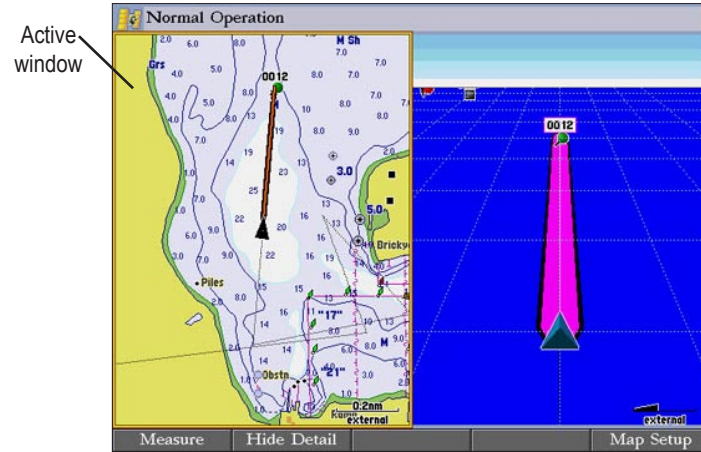

Map Split Page with Highway Page

To switch between function windows on a main page:

1. Press **ADJ**, press down on the **ROCKER** to highlight Function, and then press right to view the list of function windows. .
2. Press up or down on the **ROCKER** to select the window, and then press **ENTER**. The active window is highlighted with a yellow box.



NOTE: You can view only two windows at a time. Functions that are not available appear dimmed and cannot be selected.

Function Window Adjustments

Each active function window (except the Compass) has specific adjustment (**ADJ** key)/soft key options and main page features. You can use options from the adjustment menu or soft keys to access adjustments or features for the active (highlighted) function window.

To show adjustment options for the active function window:

1. Press **ADJ**. The adjustment menu appears for the highlighted or active function window.
2. Press the data entry shortcut key, or use the **ROCKER** to highlight an option, and press **ENTER**.

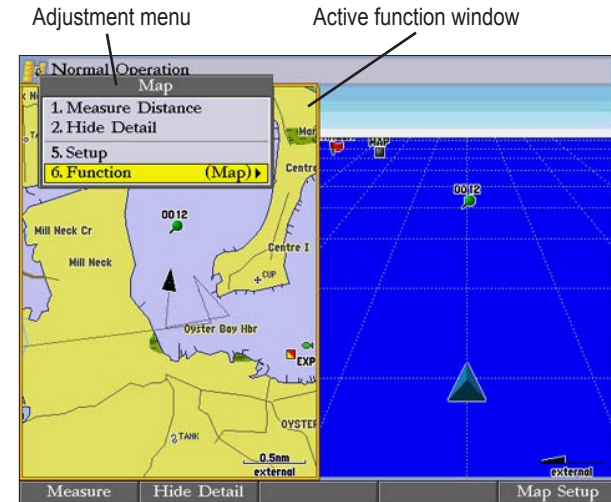

Viewing a Main Page in Full-Screen Mode

Use the **DATA** key to view the main page in full-screen mode, without functions, the status bar, or Digital Data fields. Press **DATA** again to return to the previous view.

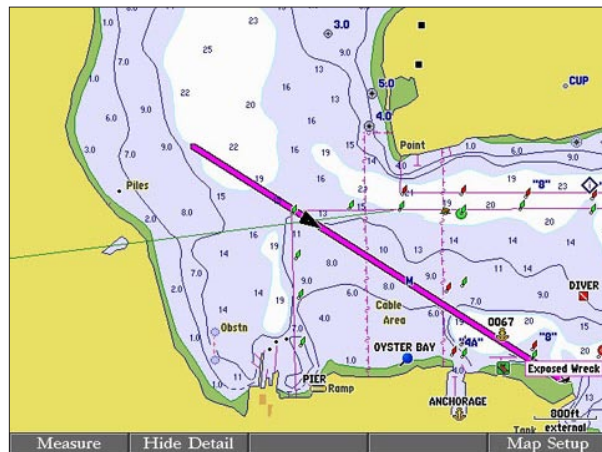

Map Page in Full-Screen Mode

Map Page

The Map Page provides comprehensive electronic cartography, plotting, and navigational data. When using the GPSMAP 2106/2110 with the optional BlueChart data or MapSource maps, the map display shows your boat on a digital chart, complete with geographic names, map items, nav aids, and other chart features. You can use the optional preprogrammed BlueChart g2 data cards with your GPSMAP 2106/2110 to view detailed roads and photographs.

When the map pointer is active, information appears in the upper-left corner of the map to indicate location, any identifying text, range, and bearing to the pointer or a selected waypoint or map item. The map range is shown in the lower-right corner of the map.

Map information

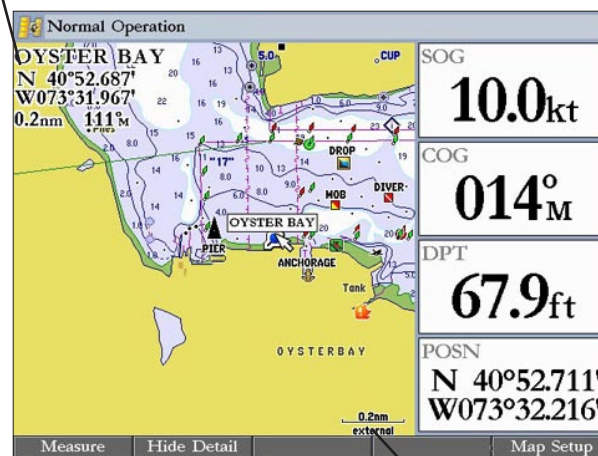

Map range

Use the **Up** and **Down** keys and the **ROCKER** to select zoom ranges and move the map pointer. Two basic map operating modes, Position mode and Pointer mode, determine what cartography (map data) is shown on the Map Page. Position mode pans the cartography to keep the current position marker within the display area, whereas Pointer mode pans the cartography to keep the map pointer within the display area.

The GPSMAP 2106/2110 starts in Position mode, with your location centered on the map.

Press up, down, left, or right on the **ROCKER** to enter Pointer mode. In Pointer mode:

- You can move the map pointer over the map display using the **ROCKER**.
- When the map pointer reaches the edge of the display, the map scrolls forward under the pointer. Keep in mind that the boat icon moves with the map scrolling and may go off the screen (you might not be able to see your current location).
- When the map pointer is stationary, a fixed coordinate location appears in the position field. The distance and bearing change as the boat's location changes.
- When you change the range in Pointer mode, the map pointer is centered on the screen.
- To return to Position mode, press **QUIT**.



NOTE: When the map pointer reaches the edge of the map, the unit may pause as it loads new map data.

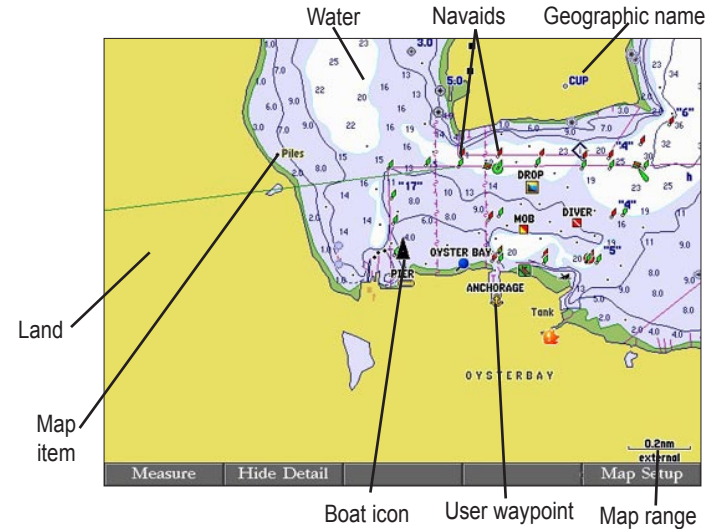

Selecting Map Ranges

The map display has 28 available range scales from 20 ft to 800 mi (5 m to 1,200 km). The map range is controlled by the **Up** and **Down** keys, with the current range shown at the lower-right corner of the Map Page.

To select a map range:

Press the **Up** key to zoom out or the **Down** key to zoom in.



NOTE: The scale value represents the distance from one end of the scale bar to the other.

Cartography

The GPSMAP 2106/2110 has a built-in worldwide database, with more detailed coverage available through the use of optional BlueChart or MapSource data. The unit shows cartography as long as chart information is available for the selected range.

The GPSMAP 2106/2110 accepts preprogrammed data cards and is compatible with the latest BlueChart g2 series marine cartography, which features integrated mapping, 2-D or 3-D map perspective, tide and current data, improved IALA symbols, nav aids, marinas, boat ramps, and roads.

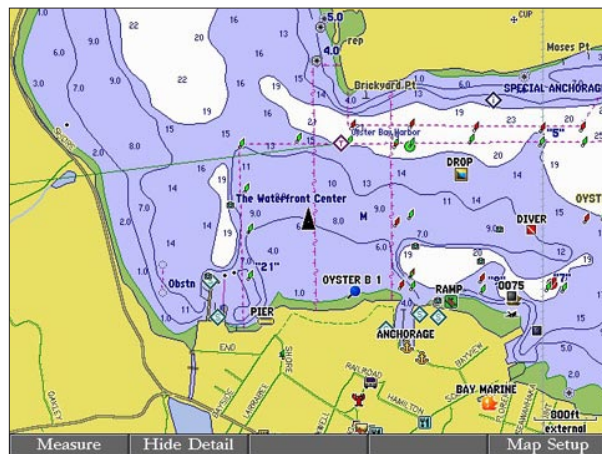

Map Page with BlueChart g2 Cartography

Map coverage conforms to the following conditions:

- Cartography appears when the selected zoom range is covered by either the internal database, BlueChart, or BlueChart g2 data.
- When the selected zoom range is covered by both the internal database and BlueChart or BlueChart g2 data, the cartography with the best resolution appears.
- When the selected zoom range exceeds the resolution of the data in use, overzoom cartography appears and an overzoom warning appears below the range.

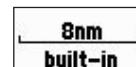

Using Built-In Basemap



Using BlueChart/BlueChart g2/MapSource Data

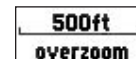

Overzoom, No Additional Data

Map Page Options

The Map Page provides access to functions and features relating to the Map Page (or Map function window) using the **ADJ** key and soft key options. The available options are: **Measure (Distance)**, **Hide (Show) Detail**, and **Setup**.

You can customize the Map Page to show other functions and different sizes or types of Digital Data fields.

Measuring Distance

Use the **Measure (Distance)** option to you to measure the distance and bearing between two points.

To measure the distance and bearing between two points:

1. Press the **Measure** soft key. An on-screen pointer appears on the map display at your present location with a blue thumbtack symbol to show the "From" reference point.
2. Using the **ROCKER**, move the pointer to the reference point (the point from which you want to measure), and press **ENTER**. The blue thumbtack symbol now appears at that point.
3. Move the pointer to the point that you want to measure to. The bearing and distance from the reference point and pointer coordinates appear in the upper-left corner of the Map Page.
4. Press **QUIT** to finish.

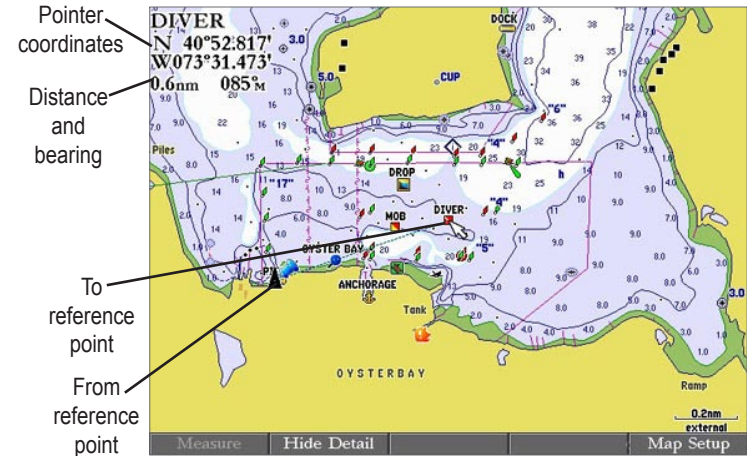

Measuring Distance
(BlueChart Data Shown)

Hiding and Showing Map Details

Use the **Hide Detail (Show Detail)** soft key to show or hide Spot Soundings and Map Outlines for easier viewing.



NOTE: This setting only affects the currently selected map. If you have a second map window shown, you can set one map to show detail and one map to hide detail.

To hide (show) map details:

Press the **Show Detail** soft key to show map details; press the **Hide Detail** soft key to hide map details.

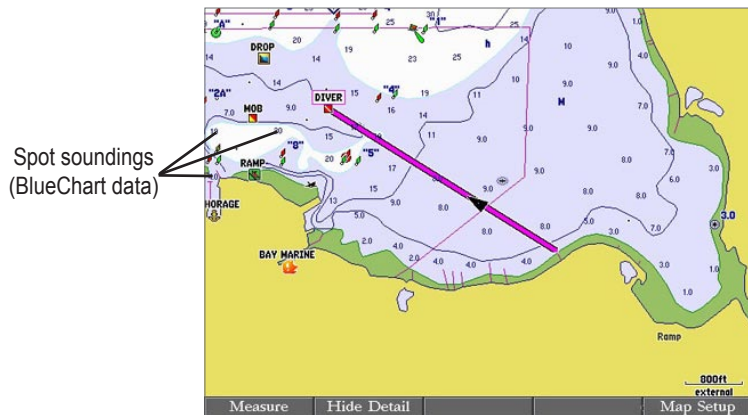

Map with Detail Shown



Map Page with Detail Hidden

Changing Map Setup Features

You can configure the map display preferences, including map detail, map orientation, automatic zoom, and various map items and points. When you select **Map Setup**, the Main Menu appears with the **Map** tab selected. The setup options are arranged in a horizontal, easy-to-use sub tab format, making it easier to organize and use the various settings. Changes made from the Map Setup option affect all maps.

To change a Setup feature:

1. Press the **Map Setup** soft key. The Main Menu appears with the Map tab highlighted.

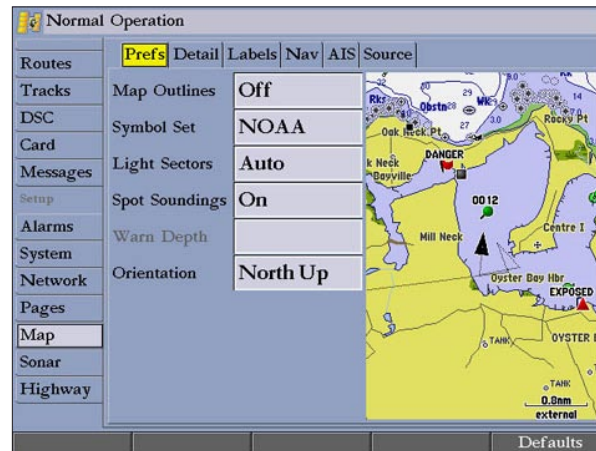

2. Press left or right on the **ROCKER** to highlight a sub tab, press up or down to highlight the setting you want to change, and press **ENTER**.
3. Press up or down on the **ROCKER** to select a different setting, and press **ENTER**.

Map Split Page

Use the Map Split Page to view two pages at the same time. You can show two different views of the Map Page, or to show a split view of the Map and Highway pages. If you have a Garmin sonar module connected, you can set up the Map Split Page to show the Map Page and Sonar Page.



Map Split Page with Map and Highway Pages

To configure the Map Split Page:

1. Press **PAGE** until the Map Split Page is shown.
2. Press and hold the **DATA/CNFG** key to open the Functions window.



3. Select the pages and options you want to show on the Map Split Page.



NOTE: You can display only two pages at a time. When two are selected, the other options are unavailable.

4. Press **QUIT** to close the Function window and return to the Map Split Page.

Compass Page

The GPSMAP 2106/2110 features two different navigation pages: Compass and Highway. Whenever you are following a route or TrackBack, the Compass Page guides you to your destination with digital readouts and a compass display, which includes a Bearing Pointer.

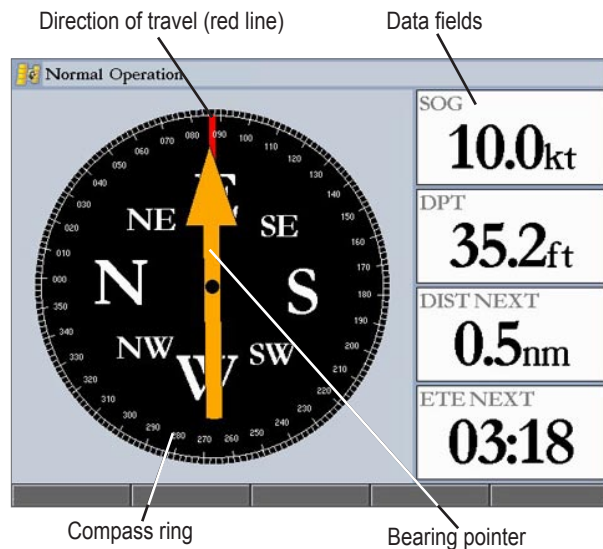

For the compass to work, the GPS must be moving. When you are moving, the orange Bearing Pointer points toward your destination, while the Compass Ring reflects the direction you are traveling by a red vertical line at the top of the Compass Ring. When you are headed directly toward your destination, the Bearing Pointer points toward the top of the screen, aligned with the red vertical line at the top of the Compass Ring. If you are not heading toward your destination, the Bearing Pointer turns, continuing to point toward your destination. To head toward your destination, turn until the Bearing Pointer is aligned with the red vertical line in the Compass Ring.

Along the right side of the screen are the default data fields; the top field is speed. Also shown are the distance to your waypoint (DIST NEXT) and estimated time en route (ETE NEXT). The distance and en route time decrease as you near your destination.

The Bearing Pointer or Compass Ring may point in various directions when you are stationary or at very low speeds. When you start moving, the pointer is correct.

You can customize the Compass Page to show other functions and different sizes or types of Digital Data fields.

Highway Page

The Highway Page provides 3-D graphic steering guidance to a destination waypoint, placing greater emphasis on the straight-line course, and the distance and direction you are off course. As you head toward your destination, the middle of the screen guides you to your waypoint on a moving highway. Your present location is at the bottom-center of the Highway Page. Three-dimensional cartography provides situational awareness while navigating. The line down the middle of the highway represents your course.

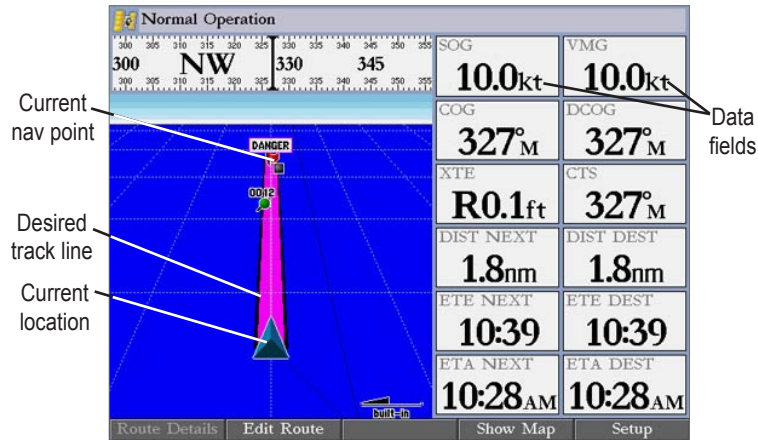

As you head toward your destination, the highway perspective moves to indicate your progress to the waypoint and which direction you should steer to stay on course. If you are navigating a route, the Highway Page shows each route waypoint in sequence connected by a magenta “road” with a line down the middle. As you navigate toward a waypoint, the highway moves, indicating the direction you are off course. To stay on course, steer toward the center of the highway. You can also view Routes details, nearby waypoints not in the active route, Track Log points, and Saved Tracks.

Changing the Highway Perspective Range

You can zoom the highway perspective range in or out to show a larger or smaller view of the highway.

To change the highway perspective range:

Press the **Up** key to zoom out, or press the **Down** key to zoom in.

Highway Page Options

The Highway Page provides access to functions and features relating to the Highway Page (or Highway function window) using the **ADJ** key and soft key options.

The available **ADJ** soft key options are **Route Details**, **Edit Active Route**, **Show (Hide) Map**, and **Setup**. You can also customize the Highway Page to show other functions and different sizes or types of Digital Data fields.

- **Active Route Details (Route Details)**—shows details such as distance, course, and other useful information for each waypoint of the active route.
- **Edit Active Route (Edit Route)**—allows you to review and modify the Active Route from either a list of the route points or on a map.
- **Show (Hide) Map**—allows you to show or hide the map on the Highway Page.
- **Setup**—allows you to select what waypoints and tracks are shown on the Highway Page. Use the **ROCKER** and **ENTER** keys to select or clear options. The following options are available:
 - **Active Route Waypoints**—shows all active route waypoints.
 - **User Waypoints**—shows only nearby waypoints.
 - **Track Log**—shows the current active track log.
 - **Saved Tracks**—shows any saved track logs.

Showing or Hiding Cartography

When using BlueChart g2 data, you can view the map on the Highway Page.

To view the map on the Highway Page:

1. Press the **Show Map** soft key to show the map on the Highway Page.

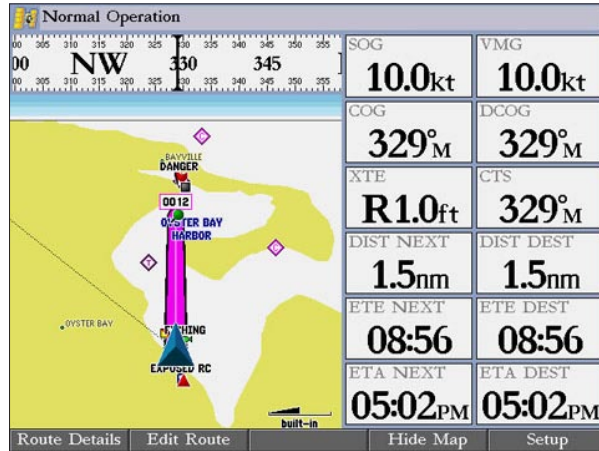

Show Map View on the Highway Page

2. Press **Hide Map** to return to the highway view.

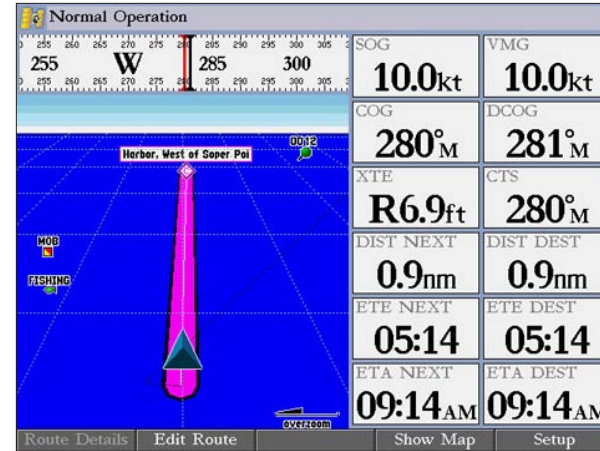

Highway Page with Map Hidden

MAIN MENU

The Main Menu provides access to various waypoint, system, navigation and interface management, and setup menus in an easy-to-use tab format. The Main Menu is accessible from any page by pressing **ADJ/MENU**.

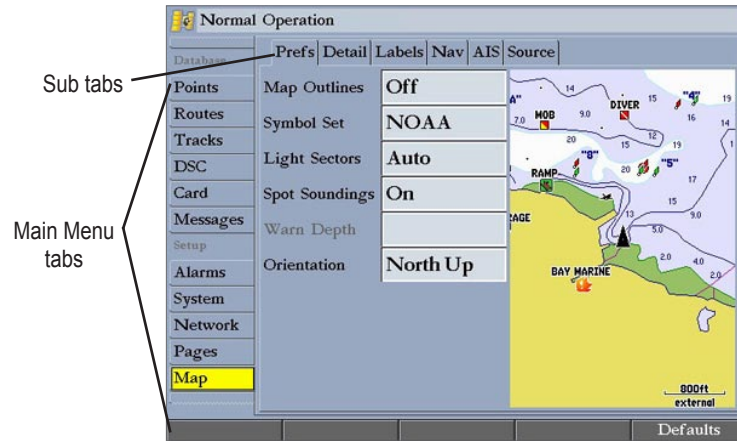

To select a tab from the Main Menu:

1. Press and hold **ADJ/MENU** to open the Main Menu.
2. Press up or down on the **ROCKER** to highlight the tab you want to view. (The highlight wraps around when you reach the top or bottom of the list.) The information for the highlighted tab automatically appears to the right. If you want to highlight any of the sub tabs, press left or right on the **ROCKER**, and then press up or down to select individual fields.

GPS Tab

The GPS tab provides a visual reference of satellite acquisition, receiver status, and accuracy. The sky view and signal strength bars give you an indication of what satellites are visible to the receiver and whether or not they are being tracked. For more information about GPS, see pages 5-6. For more information about WAAS, see page 84.



Tide Tab

Use the Tide tab to view tide and current information. The Tide tab contains two sub tabs: Tide and Current.

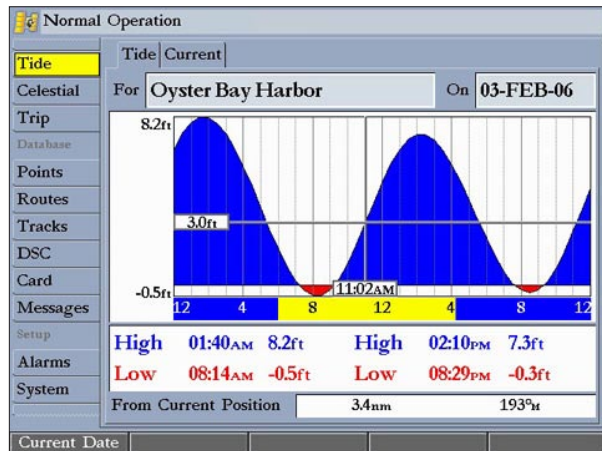

Tide Sub Tab

The Tide sub tab contains a graphical chart that shows Tide Station information in a 24-hour span starting at midnight. You can choose from different dates and more than 3,000 Tide Stations around the U.S.A. coastline, Alaska, Hawaii, western Canada, and several of the Caribbean islands. The top of the Tide sub tab shows the Tide Station and the date. The bottom of the Tide sub tab shows the distance and bearing from your location.

The bottom of the Tide chart shows a 24-hour block of local time for your location. Daylight (yellow bar) and nighttime (blue bar) at the Tide Station are shown across the time scale, with the time progressing from left to right (sunrise and sunset information might not be available for some Tide Stations). The solid, light vertical lines are in 4-hour increments, and the light, dotted vertical lines are

in 1-hour increments. A solid, vertical line (with the local time at the top) indicates the tide height corresponding to the time shown in the local time box.

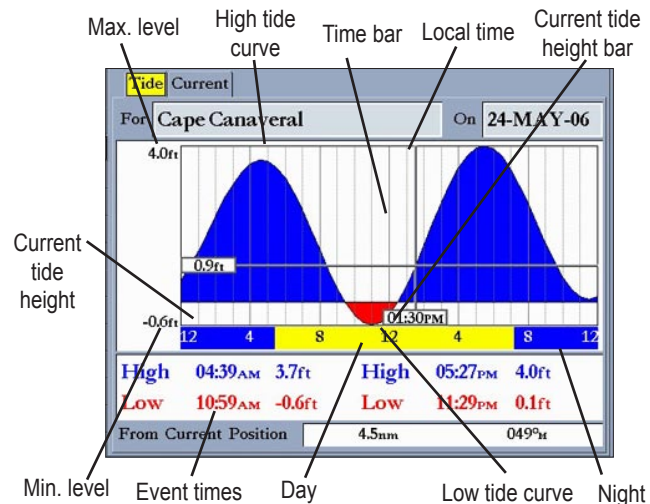

The Tide curve is shown as a shaded area, where higher tides are taller (blue) and lower tides are shorter (red). The solid, horizontal line indicates the tide height. The figure to the left of the line shows the present tide level. The Mean Lower Low Water (MLLW) appears as a solid, horizontal line near the bottom of the chart (this line appears only if the tide height range is zero or below). The numbers on the top and bottom of the left side indicate the maximum and minimum levels. The four data fields below the chart indicate event times and levels at which the tide changes, starting in the upper-left field, going downward, then to the upper-right, and down again. When comparing with other tide tables, verify that the depth unit's value is the same for both sources. The bottom of the chart shows the amount of time (in hours and minutes) until the next low tide and high tide.

To select the Tide Station nearest to your location:

1. Highlight the **For** field, and press **ENTER** to open the Find Tides Page.
2. Highlight **Current Position**, and press **ENTER** to open the Find Near Current Position Page.
3. Select a Tide Station from the list, and press **ENTER**. As you move the highlight over each Tide Station in the list, the station is highlighted on the map window. The distance and bearing from your location to the highlighted Tide Station are shown at the bottom of the list.

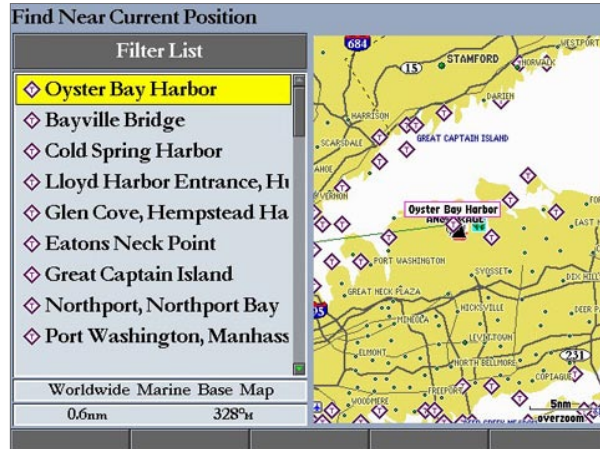

Tide Stations Near Your Location

If you are not within this range, the message “None Found” appears. Use the Map Position option to select a location closer to a Tide Station.

To select a Tide Station from a map location:

1. Highlight the **For** field, and press **ENTER** to open the Find Tides Page.
2. Highlight **Map Position**, and press **ENTER** to open the Find Near Current Position Page.

3. Press up or down on the **ROCKER** to move the map pointer to a map location, and press **ENTER**. The Find Near Other Position Page shows a list of Tide Stations near the selected map location.
4. Select a Tide Station, and press **ENTER**. If the “None Found” message appears, repeat steps 1–3 until you find a Tide Station.

Viewing Tide Information

You can change the date to see tide charts for other days or move the time bar in approximately five minute increments to show tide heights at various times.

To change the date of the tide chart:

1. Using the **ROCKER**, highlight the **On** field, and press **ENTER**.
2. Enter a date, and press **ENTER**. The tide chart is updated to show tide information for the selected date.
3. Press the **Current Date** soft key to return.

To view tide heights at various times on the tide chart:

1. Highlight the tide chart.
2. Press left or right on the **ROCKER** to change the time and day. The day changes as you move past the edge of the tide chart.

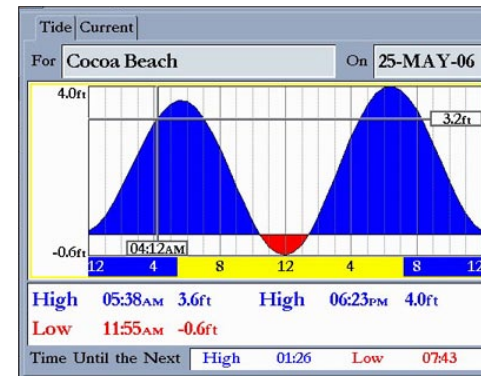

Current Sub Tab

The Current sub tab shows information for currents in a 24-hour span, starting at midnight. You can choose from different dates and more than 3,000 Current Stations around the U.S.A. coastline, Alaska, Hawaii, western Canada, and several of the Caribbean islands. The top of the Current sub tab shows the Current Station and the date. The bottom of the tab shows the distance and bearing from your location.

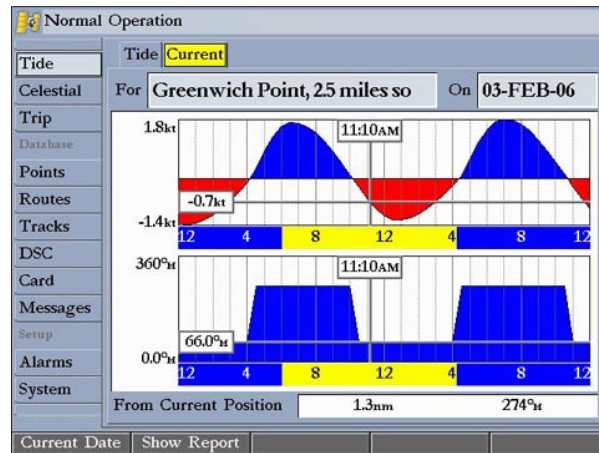

The Current sub tab contains two charts, one for speed and one for direction.

The top chart is the speed chart, which shows the speed of a given current at any point during the day. The shaded area is blue (Flood Current) when the current is heading toward shore; the shaded area is red (Ebb Current) when the current is heading away from shore.

The bottom chart is the direction chart, which shows the direction of the current at any given point during the day (based on the north reference, not true north).

The bottom of each chart shows a 24-hour block of local time for your location. Day (yellow bar) and night (blue bar) at the Current Station appear across the time scale, with the time progressing from left to right (sunrise and sunset information may not be available for some stations). The solid, light vertical lines are in 4-hour increments, and the light, dotted vertical lines are in 1-hour increments. A solid, vertical line (with the local time at the top) indicates the strength of the current that corresponds to the time shown in the local time box.

To select the Current Station nearest to your location:

1. Highlight the **For** field, and press **ENTER** to open the Find Currents Page.
2. Highlight **Current Position**, and press **ENTER** to open the Find Near Current Position Page.

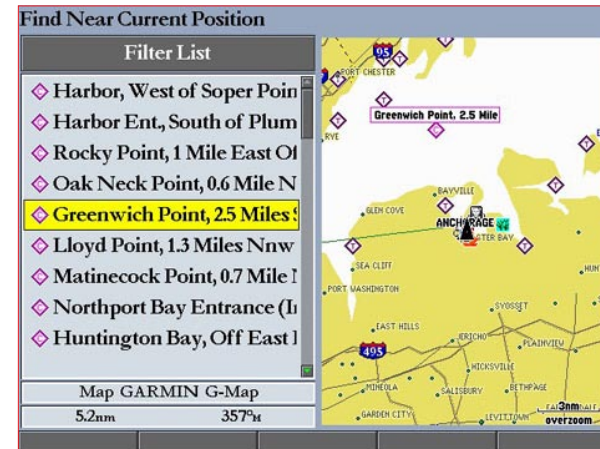

3. Select a Current Station from the list, and press **ENTER**. As you move the highlight over each Current Station in the list, the station is highlighted on the map window. The distance and bearing from your location to the highlighted station are shown at the bottom of the list.

To select a Current Station from a map location:

1. Highlight the **For** field, and press **ENTER** to open the Find Currents Page.
2. Highlight **Map Position**, and press **ENTER** to open the Find Near Current Position Page.
3. Press up or down on the **ROCKER** to move the map pointer to a map location, and press **ENTER**. The Find Near Other Position Page shows a list of Current Stations near the selected map location.
4. Select a Current Station, and press **ENTER**. If the “None Found” message appears, repeat steps 1–3 until you find a Current Station.

Viewing a Current Report

Press the **Show Report** soft key on the Current sub tab to view a detailed report of all times and values for all the minimum and maximum current flows throughout the day, including Flood, Slack, and Max Ebb times and strengths.

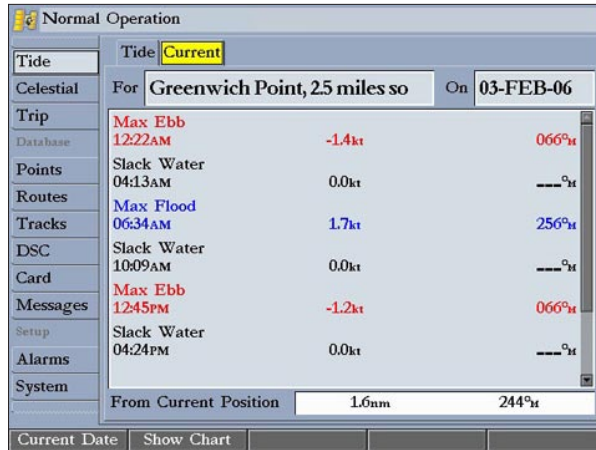

Celestial Tab

The Celestial tab shows celestial data for sun and moon rise and set, moon phase, and the approximate sky view location of the sun and moon. The moon phase shows the current visible portion of the moon as a light color. You can show this data for your current location, a location from the map, or a Find item location. Also, you can select a different date and time, or use the current date and time. The timetables shown are based on your current time zone.

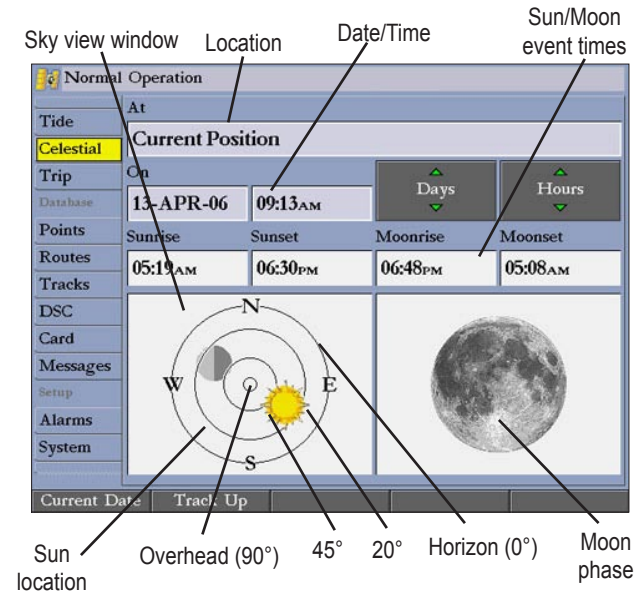

The Celestial tab contains the following soft keys:

- **Current Date**—press to show Celestial information for today’s date.
- **North Up/Track Up**—fixes the sky view display to a north heading or to the current track heading.

To view celestial information for a different location:

1. On the **Celestial** tab, highlight the **At** field, and press **ENTER**. The Find Celestial Information Page appears.

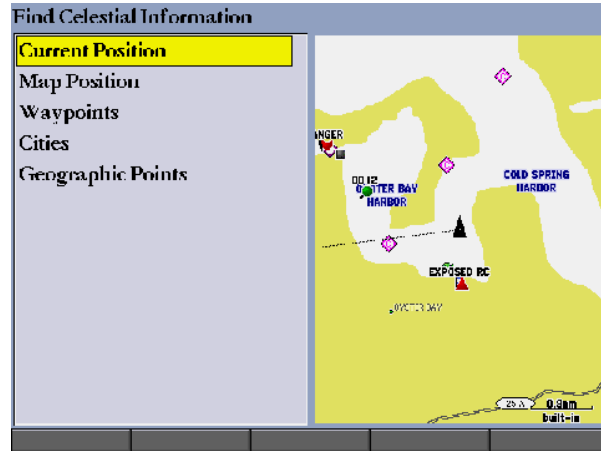

2. Make a selection and press **ENTER** repeatedly until the information for that location appears on the **Celestial** tab.

To change the time or date:

1. On the **Celestial** tab, use the **ROCKER** to highlight the **Days** or **Hours** button, and press **ENTER**. Press up or down on the **ROCKER** to change the days or hours. Press **QUIT** to exit.
OR
Highlight the **On** field, and press **ENTER**.
2. Enter a new date or time, and press **ENTER**.
3. To return to the current date and time, press the **Current Date** soft key.

Trip Tab

The Trip tab shows data for Trip Odometer, Moving Average speed, Total Average speed, Maximum Speed, Stopped Time, Moving Time, Total Time, and Odometer.

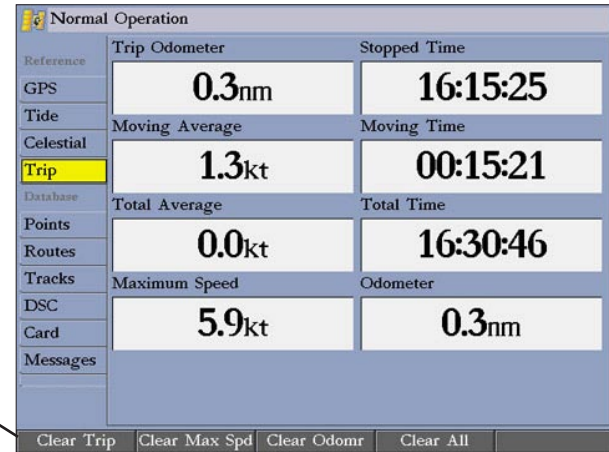

Soft keys

The Trip tab contains the following soft keys:

- **Clear Trip**—clears all trip data.
- **Clear Max Spd**—resets the value in the Maximum Speed field to **0.00**.
- **Clear Odometer**—resets the value in the Odometer field to **0.00**.
- **Clear All**—resets the values in all fields.

Points Tab

The Points tab contains two sub tabs, User and Proximity, which allow you to manage a large number of waypoints quickly and efficiently. The sub tabs also provide continuously updated proximity waypoint alarms that can be used to define items, such as submerged hazards or shallow waters.

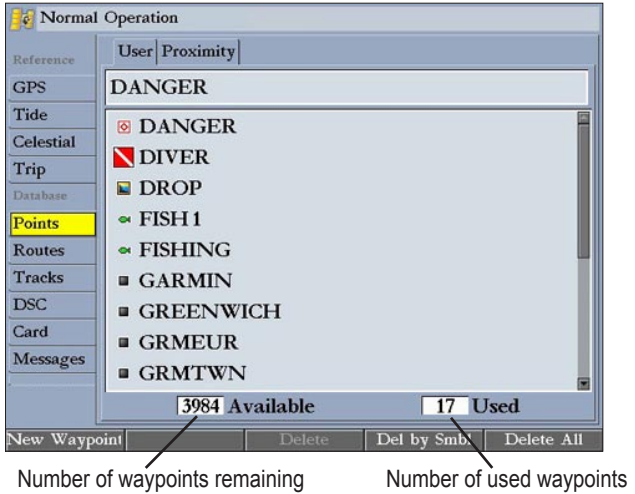

Number of waypoints remaining Number of used waypoints

User Sub Tab

The User sub tab on the Points tab displays a master list of all waypoints currently stored in memory. From the User list, you can review, edit, rename, or delete individual waypoints, or delete all user waypoints. The total number of stored and available waypoints appears at the bottom of the User sub tab, with the stored waypoints arranged in alphanumeric order.

Proximity Sub Tab

Use the Proximity sub tab on the Points tab to define an alarm circle around a stored waypoint. The alarm circle can help you avoid reefs, rocks, or restricted waters. You can add proximity alarms to up to 10 waypoints, with a maximum alarm radius of 99.99 nautical or statute miles or kilometers.

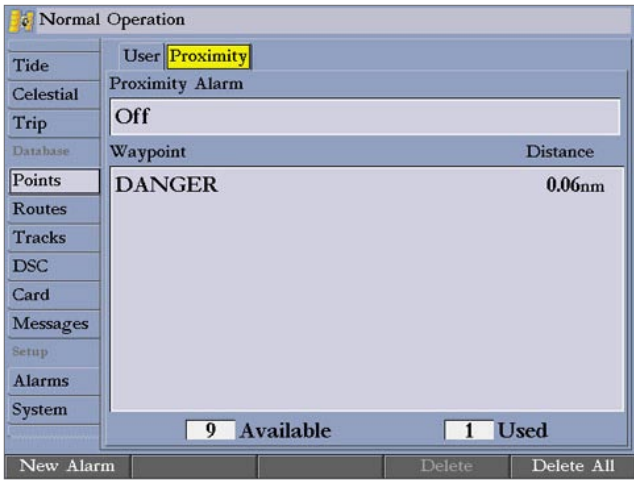

The total number of stored and available proximity waypoints appears at the bottom of the Proximity sub tab, with the stored waypoints arranged in alphanumeric order.

Routes Tab

The Routes tab contains a list of available routes. See the “[Creating and Using Routes](#)” section beginning on page 23 for more information about creating routes.

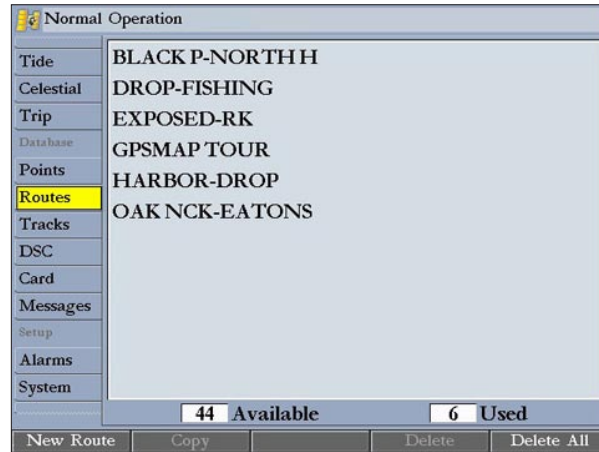

Tracks Tab

Use the Tracks tab to specify whether or not to record a track log, define how it is recorded, or save track log data for future use. The Tracks tab also provides an indicator of the memory used for the active track log and allows you to clear the track memory. The Track tab is divided in two sub tabs: Active and Saved.

For more information setting up track options and saved tracks, see pages 21-22.

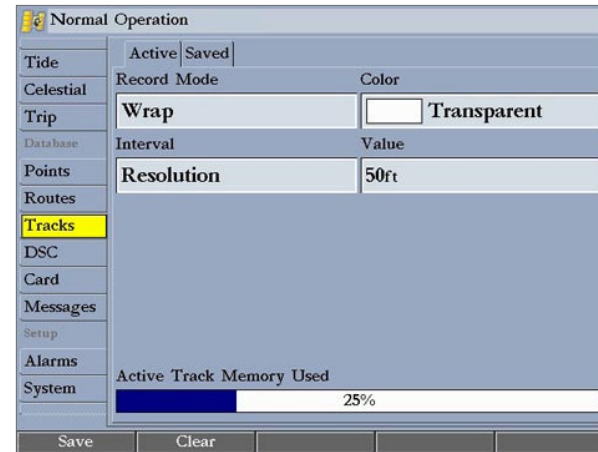

Active Sub Tab

The **Active** sub tab shows the amount of track memory used and current settings for the active log (the log currently being recorded). The active log stores up to approximately 10,000 track log points, based on the criteria specified in the Track settings.

The following settings are available:

- **Record Mode**—allows you to select one of three track recording options:
 - **Off**—No track log is recorded. If you select **Off**, you cannot use the TracBack feature.
 - **Fill**—a track log is recorded until the track memory is full.
 - **Wrap**—a track log is continuously recorded, wrapping through the available memory (replacing the oldest track data with new data).
- **Color**—allows you to specify a color used to show the active track log on the Map and Highway Pages.
- **Interval**—defines the frequency at which the track plot is recorded. Three interval settings are available:
 - **Distance**—records the track based on a user-defined distance between points.
 - **Time**—records track plot based on a user-defined time interval.
 - **Resolution**—records the track plot based on a user-defined variance from your course over ground or changes in water depth/temp (if equipped). The Resolution option is the default setting and is recommended for the most efficient use of memory and TracBack performance. The distance value (entered in the value field) is the maximum error allowed from the true course before recording a track point.
- **Value**—defines the distance or time used to record the track log.

The following soft keys are available:

- **Save**—saves the current active track log.
- **Clear**—clears the active track log currently stored in memory.

Saved Sub Tab

The **Saved** sub tab shows a list of all saved track logs. It also allows you to use a track for TracBack or display it on a map. You can save up to 15 track logs in memory with up to 700 track log points in each saved log.

On the Saved sub tab, the following soft keys are available:

- **Review Map**—opens the Saved Track window so you can review the selected track.
- **Delete**—deletes the highlighted saved track log from memory.
- **Delete All**—deletes all saved track logs from memory.

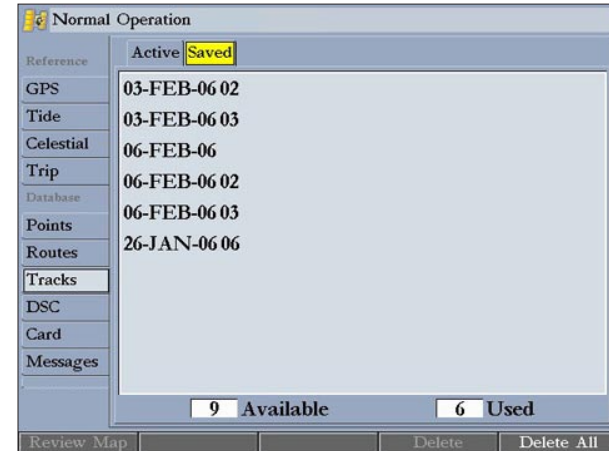

DSC (Digital Selective Calling) Tab

Use the DSC tab to control and set up DSC features on the GPSMAP 2106/2110. DSC uses marine VHF radio and GPS technologies to transmit and receive location information. DSC is used by mariners for two major operations—distress calls and position reporting.

For more information about DSC and Maritime Mobile Service Identity (MMSI) numbers, see page 85 in the “Appendix.”

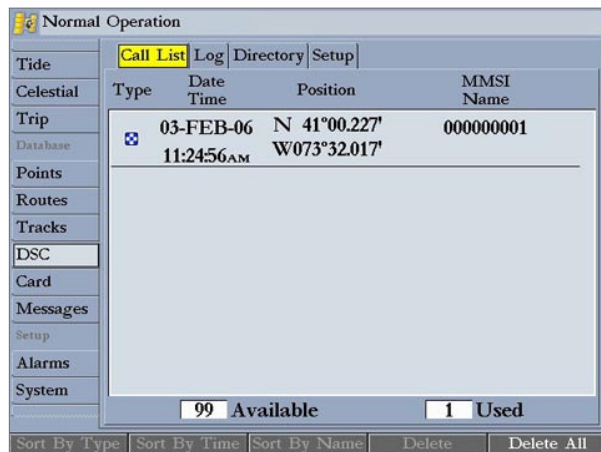

When the GPSMAP 2106/2110 is connected to a VHF radio with DSC support, the GPS unit displays a call list, log, and a directory that stores incoming information received from another user’s DSC-capable VHF/GPS combination. Basic wiring is required for the Garmin unit and VHF radio to send and receive NMEA data from each other. See the *GPSMAP 2106/2110 & GPS 17 Installation Instructions* for more information.

Understanding DSC Distress Calls

With your GPSMAP 2106/2110 properly connected to a VHF radio with DSC output, you can receive any DSC distress call within range. An alert message appears, and an alarm sounds (if enabled) when a distress call is received. The alarm sounds only for a distress call; position reports do not sound an alarm. Distress calls are broadcasted to all DSC users in radio range and appear with a blue and white checkered icon on the DSC tab’s Call List and Log sub tabs.

You can enter a caller’s name, if it is known. The caller’s name replaces the MMSI number as a reference, when entered.

Understanding Position Reports

The position report operates similarly to the distress call. This type of contact is like a phone call; no emergency alarms are set off, and the call is specific to the receiver. Position reports are not broadcasted to all DSC users and appear with a gold boat icon.

Call List Sub Tab

The Call List sub tab shows the 100 most recent calls, even if the unit is left unattended. You can select any entry from the Call List to show an Entry Review.

Log Sub Tab

When DSC calls are received, they are automatically stored in the log, with the latest call at the top. The unit can store up to 100 calls; after 100 calls are received, the oldest is removed when a new call is received.

The Call List and Log sub tabs both show the call type, date/time, position, and MMSI/Name. Pressing the Sort By (Call) Type, Sort By Time, Sort By Name, Delete (only after highlighting a particular call), and Delete All soft keys allows you to sort and delete calls.

To review a call or log entry:

1. From the **DSC** tab, highlight the **Call List** or **Log** sub tab.
2. Press up or down on the **ROCKER** to highlight the call you want to review.
3. Press **ENTER**.

Review DSC Waypoint

The Review DSC Waypoint Page operates similarly to the Distress Page and Position Report Page. From this page you can delete the displayed call. On the DSC Review Waypoint Page, press the **Delete** soft key to delete the entry, or press the **Create Wpt** soft key to create a waypoint.

Review	
DSC Waypoint	
000000001	
Name	
CALL	
Position	
N 40°52.678' W073°31.529'	
Reference	
Current Position	
0.0ft	014M
Modified	
02:11PM	14-FEB-06
Next	
Create Wpt	Delete
Next	

Review DSC Waypoint**DSC Directory**

The DSC Directory acts like a phone book and can save up to 100 contacts. The directory lists all contacts by name and MMSI number. Press **ADJ** from this page to delete a highlighted entry or delete all entries.

To add a new directory item:

1. Press the **New Item** soft key. The Directory Item Review window allows you to enter information of a known contact.
2. Highlight the **MMSI**, **Name**, or **Comment** field, and press **ENTER**.
3. Press up or down on the **ROCKER** to enter information, and press **ENTER**.

Directory Item Review	
MMSI	00000022
Name	SS HENRY
Comment	SHIP
OK	

4. Press the **OK** soft key to save the entry.

After creating a New Directory Item entry, the name created is attached to that particular MMSI number. If you return to the log, the new name appears under the corresponding MMSI number.

Another way to enter a name is from the Entry Review Page or the DSC Distress Call or DSC Position Report pages. The Name field is only available in the GPS. Names cannot be sent like the MMSI numbers to other DSC users.

Setting Up DSC

Use the DSC Setup sub tab to turn DSC on and off. If you have more than one chartplotter and you only want DSC to show on one chartplotter, turn off DSC on all units but one.

You can use the **Setup** sub tab to simulate distress calls or position reports on this page while the unit is in Simulator Mode (see [page 7](#)). Press either the **Sim Dstrs Call** or **Sim Posn Rpt** soft key to simulate a Distress Call or a Position Report. This is helpful practice before connecting to the real system. The Distress Call simulator also helps to determine whether alarms are working properly.

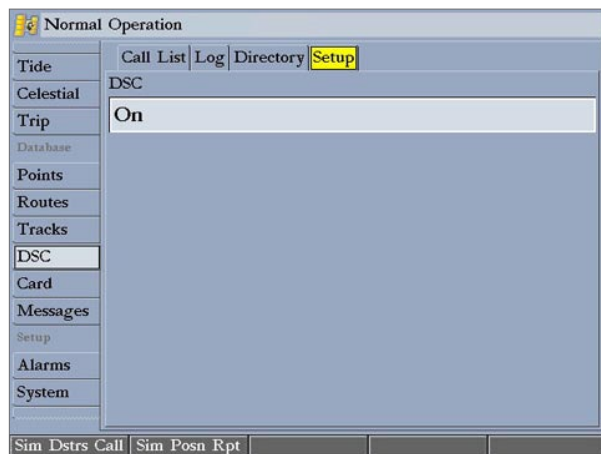

DSC Setup (Simulator Mode Shown)

Using the NAV Key

If you receive a distress call or position report, you can quickly navigate to the caller using the NAV key. When the call is logged, press NAV, and select **Go To <MMSI number>** or **Go To <Name>**.

Card Tab

Use the Card tab to transfer waypoints, routes, and tracks to and from a data card. When data is saved to a data card, it can be exchanged with other compatible units or transferred Garmin's MapSource software program on your computer.

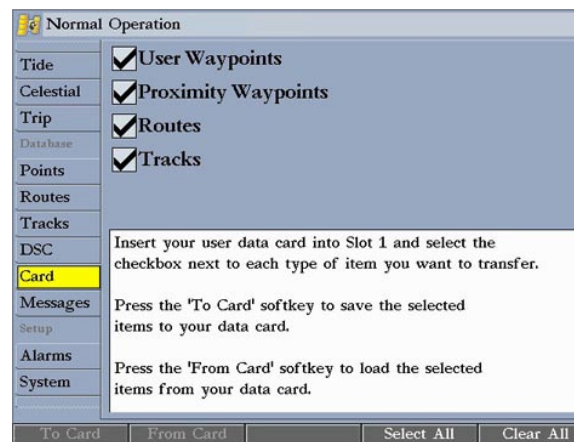

To transfer data to or from a data card:

1. Insert the data card. If there is already user data on the card, highlight **Manage User Card**, and press **ENTER**. The Main Menu appears with the Card tab selected.
2. Select the check box next to each type of item you want to transfer (user waypoints, proximity waypoints, routes, or tracks).
3. Press the **To Card** soft key to save the selected items to the data card.
4. If transferring data from the card to the GPSMAP 2106/2110, press the **Merge From Card** soft key to combine the selected items with existing GPS data.
OR
Highlight **Replace From Card**, and press **ENTER** to overwrite all selected items on your GPS.
5. A "Transfer Complete" message appears in the status bar after the data is transferred. Press **QUIT**.

Messages Tab

The Messages tab shows a list of messages generated by the GPSMAP 2106/2110. Use the **ROCKER** to scroll through the messages. The date and time when each message occurred is shown at the bottom of the tab.

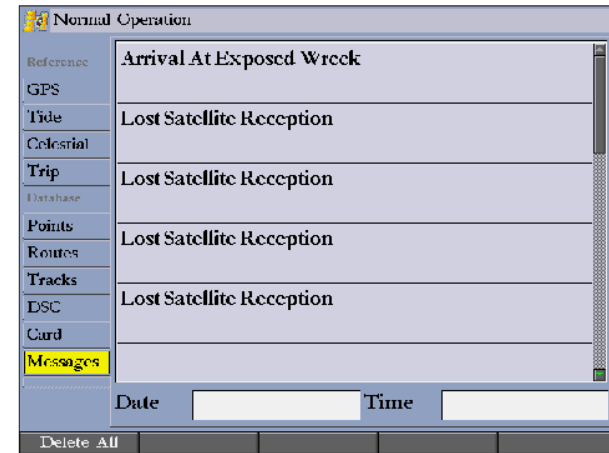
**Viewing Detailed Message Information**

You can view detailed information about the message, such as date, time, position, speed, course, and heading.

To view detailed information:

Highlight a message, and press **ENTER**. A window opens, showing detailed information for the selected message.

Distress Call	
Date	Time
03-FEB-06	11:24AM
Position	
N 41°00.227' W073°32.017'	
Ground Speed	Water Speed
10.0kt	8.7kt
Course	Heading
014°M	014°M
Depth (DPT)	Water Temp
35.2ft	58.8°
OK	

Alarms Tab

Use the Alarms tab to define alarm settings. The Alarms tab is divided into three sub tabs: System, Nav, and Sonar.

Alarm messages appear in red across the status bar or change the appearance of a data field if that field shows alarm-related data (for example, depth or voltage). Press **QUIT** to acknowledge an alarm message. The status bar and data field remain red while the alarm condition persists.

Normal Operation			
	System	Nav	Sonar
Celestial	Clock	Off	12:00AM
Trip	Battery	Off	11.2v
Database	GPS Accuracy	Off	328.1ft
Points			
Routes			
Tracks			
DSC			
Card			
Messages			
Setup			
Alarms			
System			

To set an alarm:

1. Use the **ROCKER** to highlight the **System**, **Nav**, or **Sonar** sub tab.
2. Highlight the field next to the alarm you want to set, and press **ENTER**.
3. Change the mode to the setting you want, and press **ENTER**.
4. Repeat steps 1–3 to set additional alarms, and then press **ENTER** when finished.

System Alarms

Use the System sub tab to set alarms for the system clock, batteries, and GPS accuracy.

System	Nav	Sonar
Clock	Off	12:00AM
Battery	Off	11.2v
GPS Accuracy	Off	328.1ft

The System sub tab contains the following alarms:

- **Clock**—provides an alarm for the system clock. Enter a time in the time field and turn the alarm on and off from the control field menu. Remember to enter alarm times in the same time format (UTC or local) you are using for your system. The unit must be on for the clock alarm to work.
- **Battery**—sets an alarm to sound when the battery reaches a user-determined low voltage.
- **GPS Accuracy**—sets an alarm to sound when the GPS location accuracy falls outside the user-determined value.

Nav (Navigation) Alarms

Use the Nav sub tab to set navigational alarms, including anchor drag, arrival, and off course.

System	Nav	Sonar
Anchor Drag	Off	0.0ft
Arrival	Time	00:00:15
Off Course	Off	0.00nm

- **Anchor Drag**—sets an alarm to sound when a specified drift distance is exceeded. Enter a value in the distance field, and use the control field to turn the alarm on and off.
- **Arrival**—sets an alarm to sound when a specified distance or time away from a destination waypoint is exceeded. Enter a distance, radius, or time for sounding the alarm, and use the control field to set the alarm to **Off**, **Dist** (distance), or **Time**.
- **Off Course**—sets an alarm to sound when you are off course by a specific distance. Enter a distance in the distance field, and use the control field to turn the alarm on and off.

Sonar Alarms*

Use the Sonar sub tab to set sonar alarms, including shallow or deep water, water temperature, and fish.

System	Nav	Sonar
Shallow Water	On	20.0ft
Deep Water	On	100.0ft
Water Temperature	Above	70.0°
Fish	🐟🐟🐟	

- **Shallow Water/Deep Water**—sets an alarm to sound when you enter an area of specified depth that is too shallow or too deep. You must be receiving sonar data for this function to work.
- **Water Temperature**—sets an alarm to sound when the transducer reports a temperature either above, below, inside, or outside the specified values.
- **Fish** —sets an alarm to sound when the unit detects a fish of the specified symbols.

*You must be receiving NMEA sonar data or using a GSD 20, GSD 21, or GSD 22 for the sonar alarms to function.

System Tab

The **System** tab consists of five sub tabs: General, Units, Time, Comm, and Update.

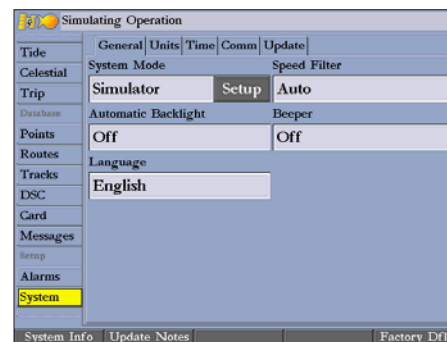

General Sub Tab

Use the **General** sub tab to control system settings for system mode, speed filter, automatic backlight, beeper, language, simulator controls, restore factory default settings, and to view the software version.

The following settings and options are available:

- **System Mode**—select **Normal** (normal navigation) or **Simulator** (for practice only). For more information about Simulator Mode, see “[Simulator Mode](#)” on page 8.
- **Speed Filter**—averages speed readings. Select **Off**, **Auto** (automatically controls filtering), or **On** (allows you to enter a value from **1** to **255** seconds).
- **Automatic Backlight**—automatically adjusts the display brightness to a specified level at sunrise and sunset. You can specify offset minutes for before sunrise and after sunset.

- **Beeper**—controls the audible beep. Select **Off**, **Alarms Only** (sounds for alarms/messages), or **Key and Alarm** (sounds for key presses and alarms/messages).
- **Language**—sets the language for the unit's on-screen text.

The following soft keys are available:

- **System Info**—shows the unit's software, basemap version, and electronic serial number.
- **Update Notes**—shows software notes for the current software version.
- **Factory Dflts**—restores all settings to Garmin's original setup values for all devices on the network.

To adjust the automatic backlight settings:

1. Highlight the **Automatic Backlight** field, and press **ENTER**.
2. Using the **ROCKER**, highlight **On**, and press **ENTER**.
3. Highlight the **Setup** button, and press **ENTER** to open the Adjust Backlight window.
4. To adjust the backlight levels **For Day** and **For Night**, highlight the corresponding slider, and press **ENTER**.

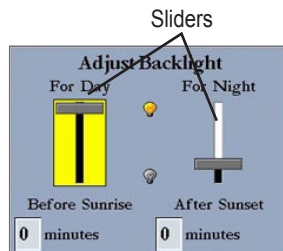

5. Press up or down on the **ROCKER** to increase or decrease the backlight level, and press **ENTER**.
6. To adjust the offset minutes, select the **minutes** field, and press **ENTER**.
7. Enter the offset minutes for **Before Sunrise** or **After Sunset**. If zero, the unit automatically changes to the specified level at sunrise/sunset. Press **QUIT** to exit.

Units Sub Tab

Use the Units sub tab to define settings for Position Format, Depth, Map Datum, Temperature, Distance, Speed, and Elevation, Pressure, and Heading.



WARNING: The Units sub tab settings affect how navigation information appears on the GPSMAP 2106/2110. If you are using a map or chart with your GPS, make sure the settings on the Units sub tab match that of the map or chart. This information should be shown somewhere on the map or chart. If not, contact the map or chart maker to determine what position format, datum, heading, and units of measure are used for the map or chart.



The following settings are available:

- **Position Format**—used to change the coordinate system in which a given location reading appears. Only change the position format if you are using a map or chart that specifies a different position format or you want to use a format you are familiar with. The default format is latitude and longitude in degrees, minutes, and thousandths of a minute (hddd°mm.mmm').
- **Depth**—select the units of measure for depth in Feet (ft), Fathoms (fa), or Meters (m). You must be receiving NMEA Sonar depth data or using a Garmin Sonar Module for the depth to appear.

- **Map Datum**—manually select the datum reference used to determine a given location. The default setting is **WGS 84**. The unit automatically selects the best datum depending on your chosen position format. Datums are used to describe geographic locations for surveying, mapping, and navigation and are not actual maps built in the unit. Although more than 100 datums are available, you should change the datum only if you are using a map or chart that specifies a different datum.



WARNING: Selecting the wrong map datum can result in substantial position errors. When in doubt, use the default WGS 84 datum for best overall performance.

- **Temperature**—set the units of measure for temperature in Fahrenheit (°F) or Celsius (°C). You must be receiving NMEA Sonar temperature data or using a Garmin Sonar Module for the Temperature to appear.
- **Distance, Speed, and Elevation**—set the units of measure for distance, speed and elevation readouts in Nautical (nm, kt, ft), Nautical (nm, kt, m), Statute (mi, mh, ft), or Metric (km, kh, m) terms.
- **Pressure**—set the units of measure you want to use for weather readouts in Inches Mercury (in), Millibars (mb), or Hectopascals (hPa). You must be using a Garmin weather product for this data to appear.
- **Heading**—set the reference used in calculating heading information. You can select **Auto Mag Var**, **True**, **Grid**, and **User Mag Var**. Auto Mag Var provides magnetic north heading references that are automatically determined from your present location. True provides headings based on a true north reference. Grid provides headings based on a grid north reference. User Mag Var allows you to specify the magnetic variation at

your present location and provides magnetic north heading references based on the variation you enter.



WARNING: If you select **User Mag Var**, you must periodically update the magnetic variation as your location changes. When using this setting, the GPSMAP 2106/2110 unit does not automatically calculate and update the magnetic variation at your present location. Failure to update this setting can result in substantial differences between the information displayed on your unit and external references, such as a magnetic compass.

To enter a user-defined magnetic variation:

1. With the **Heading** field set to **User Mag Var**, highlight the heading reference field (immediately to the right), and press **ENTER**.
2. Enter the magnetic variation at your current location, and press **ENTER**.

Time Sub Tab

Use the Time sub tab to adjust the time format, enter a time zone, and adjust for daylight saving time to show the correct local time.

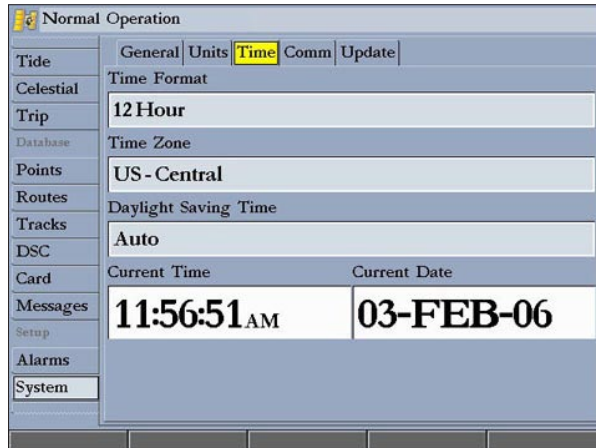

The following options are available:

- **Time Format**—select 12 Hour, 24 Hour (military), or UTC (also called Greenwich Time) time format.
- **Time Zone**—select your time zone to show correct local time or enter a UTC Offset (how many hours you are ahead or behind the time line).
- **Daylight Saving Time**—select **Auto**, **On**, or **Off** to adjust for daylight saving time.

Comm (Communications) Sub Tab

The Comm sub tab controls the input/output format used when connecting your GPSMAP 2106/2110 to external NMEA devices or a personal computer. The unit supports two input/output ports.



NOTE: See the *GPSMAP 2106/2110 & GPS17 Installation Instructions* for more information on wiring and NMEA information.

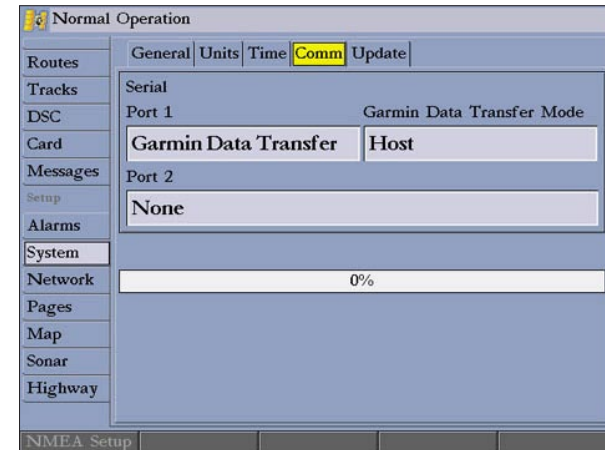

Port 1

- **Garmin Data Transfer**—the proprietary format used to upload or download MapSource data, exchange waypoint, route, track, and proximity data with a computer or another Garmin unit. When you select **Garmin Data Transfer**, you can choose from nine Garmin Data Transfer Modes.
- **NMEA In/NMEA Out**—supports the input or output of standard NMEA 0183 data, DSC, and sonar NMEA input support for the DPT, MTW, and VHW sentences. You can also adjust the NMEA output.
- **NMEA High Speed**—supports the input or output of standard 0183 data for most AIS receivers.
- **None**—provides no interfacing capabilities.

Port 2

- **NMEA In/NMEA Out**—supports the input or output of standard NMEA 0183 data, DSC, and sonar NMEA input support for the DPT, MTW, and VHW sentences. You can also adjust the NMEA output.
- **None**—provides no interfacing capabilities.

You can also adjust the NMEA output to enable or disable certain sentences and adjust the number of **Lat/Lon** output precision digits. You must have one of the ports set to **NMEA In/NMEA Out** to use this option. Settings affect both Port 1 and Port 2 NMEA outputs.

NMEA Interface

If you are going to use the GPSMAP 2106/2110 with a NMEA device (such as a radio or autopilot), the unit needs to be set to input/output NMEA data. See the *GPSMAP 2106/2110 & GPS 17 Installation Instructions* for information on wiring and NMEA data.

To activate the NMEA data:

1. Highlight the **Port 1** or **Port 2** field, and press **ENTER**.
2. Highlight **NMEA In/NMEA Out**, and press **ENTER**.

When transferring data between two Garmin units, always set one to **Host** and use the other unit to send or request the data.

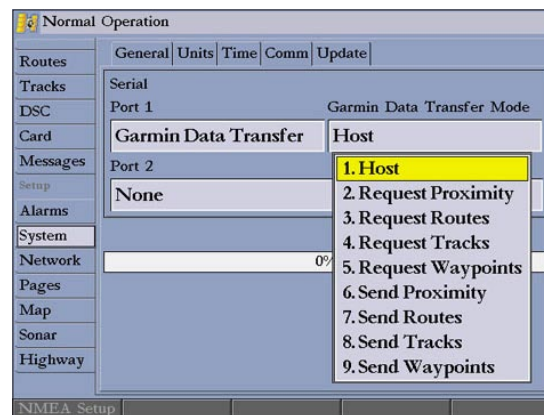

Advanced NMEA Output Setup

The GPSMAP 2106/2110 NMEA data transmission can be customized to change the precision of the **Lat/Lon** minutes, set up the waypoint IDs, and keep the output rate at two seconds. If the unit is set up to output all of the available NMEA sentences, the output rate may exceed two seconds.

Use the Advanced NMEA Setup Page to turn the GPS status (GSA, GSV), Waypoint/Route (WPL, RTE), and the Garmin proprietary sentences on or off. Check any other equipment's owners manual to see what sentences are required to be enabled for functionality.

Lat/Lon Minutes Precision allows you to adjust the number of digits to the right of the decimal point for transmission of NMEA Output, either 2, 3, or 4 digits. Use the **Waypoint ID** setting to output the waypoint identifiers as names or numbers.

Advanced NMEA Setup Page

To change the advanced NMEA settings:

1. Press the **NMEA Setup** soft key to open the Advanced NMEA Setup Page.
2. To change, enable, or disable NMEA output sentences, highlight the sentence, and press **ENTER** to select or clear the check box. Only selected sentences are output.

Update Sub Tab

The Update sub tab shows the status of any software you are uploading to your unit.

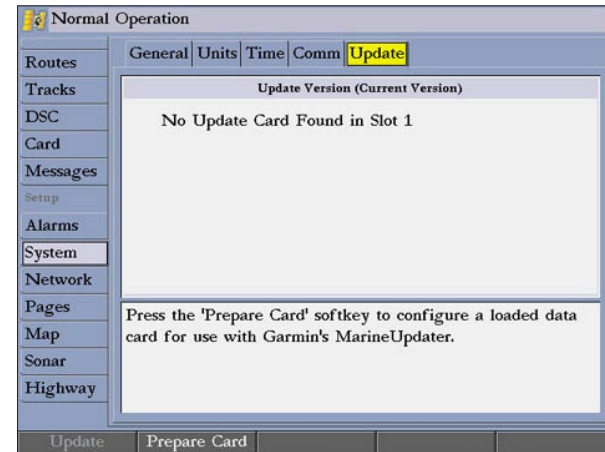

- **Update**—updates software on your unit.
- **Prepare Card**—updates software for devices connected to your GPSMAP 2106/2110. When selected, information about your network installation is collected and saved to a data card. Use the data card with Marine Updater on your personal computer to download software updates for your system. Using Marine Updater, you can put all of the software updates on a data card. When you put the data card into the unit, it updates the software for all devices on the network. Check the Garmin Web site (www.garmin.com) for future updates and announcements.

Network Tab

The Network tab shows all devices connected to your GPSMAP 2106/2110, and the status of each. You can assign a name or identifier to each device.

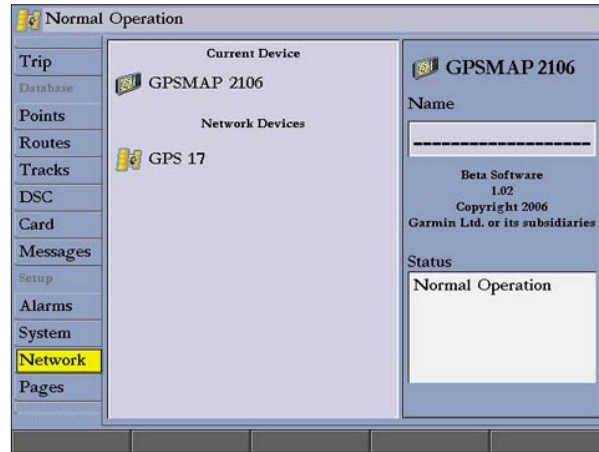

To check the status of a device:

Use the **ROCKER** to highlight the device. The status of the network device is shown in the Status window.

To assign a name to a device on the network

1. Use the **ROCKER** to highlight the device, and then press **ENTER** to highlight the **Name** field.
2. Use the **ROCKER** or data entry keys to enter a name for the device.
3. Press **ENTER** when finished.

Pages Tab

Use the Pages tab to change the page sequence, or add or remove pages.

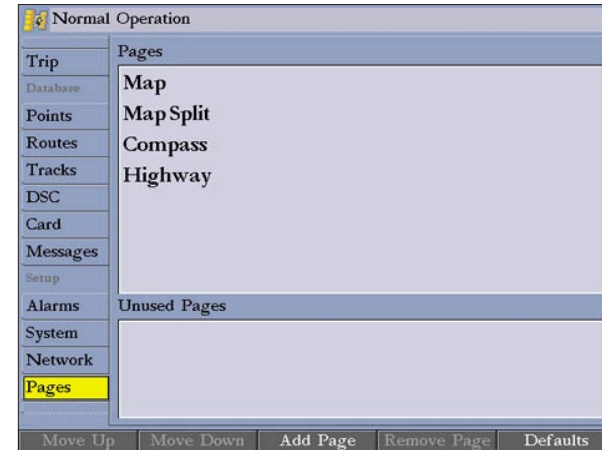

To change the page sequence:

1. Use the **ROCKER** to highlight the page you want to move in the Pages list.
2. Press the **Move Up** soft key to move the page up, or press the **Move Down** soft key to move the page down in the list.
3. Repeat steps 1–2 to change the page sequence for additional pages.

To add a page to the page sequence:

1. Press the **Add Page** soft key.
2. Highlight the page you want to add in the Unused Pages list, and press **ENTER**. The page is added to the Pages list and appears on the Pages menu when you press the **ADJ** key. Press the **Move Up** or **Move Down** soft key to change page sequence.

To remove a page from the page sequence:

1. Highlight the page in the Pages list.
2. Press the **Remove Page** soft key. The selected page is moved to the Unused Pages list.

To restore page defaults:

Press the **Restore Defaults** soft key to restore the pages list to the default setting.

Map Tab

Use the Map tab change map settings, including map detail, map orientation, and automatic zoom. Changes made to the Map tab sub tabs affect all maps.

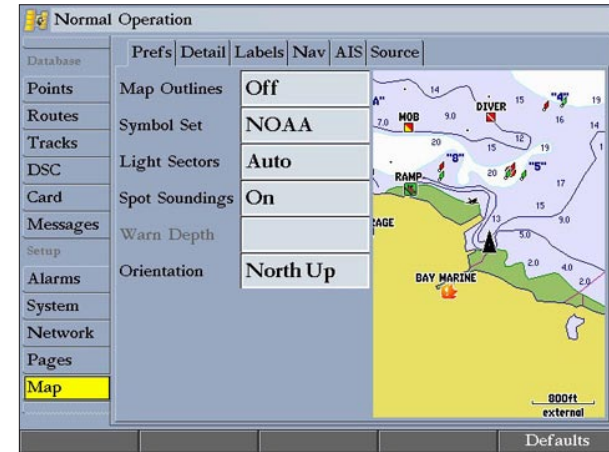
**To change a Map Setup feature:**

1. On a Map function window, press the **Map Setup** soft key to open the Main Menu. The **Map** tab is highlighted.
2. Press left or right on the **ROCKER** to highlight a sub tab; press up or down on the **ROCKER** to highlight the setting you want to change, and press **ENTER**.
3. Press up or down on the **ROCKER** to select the setting you want, and press **ENTER**.
4. Press **QUIT** to exit.

The **Map** tab has six sub tabs—Prefs, Detail, Labels, Nav, AIS, and Source.

Prefs Sub Tab

Use the Prefs sub tab to select map preferences.

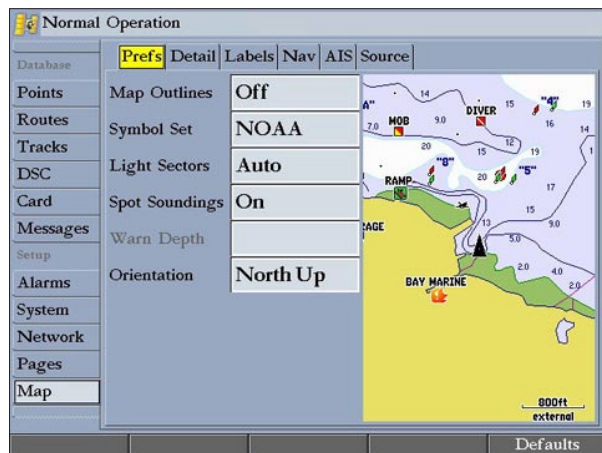

- **Map Outlines**—turns coverage boxes on or off for BlueChart/MapSource data.
- **Symbol Set**—controls the navaid symbol set:
 - **NOAA**—all maps are drawn using a symbol set similar to NOAA/NIMA.
 - **International**—all maps are drawn using a symbol set similar to the IALA symbol set.
- **Light Sectors**—controls the drawing line sectors on the map. Select **Off**, **Auto**, or **On**.

- **Spot Soundings**—turns on the depth spot sounding data. Select **On**, **Warn Depth**, or **Off**.
- **Warn Depth**—shows the spot sounding below the set value in red. This field is available only when **Warn Depth** is selected in the Spot Soundings field.
- **Orientation**—sets the orientation of the map display:
 - **North Up**—fixes the top of the map display to a north heading.
 - **Track Up**—fixes the top of the map display to the current track heading. Set to **All Ranges** for constant Track Up. The numeric value is the map range at which the unit switches to North Up when zooming out.
 - **Course Up**—fixes the map so the direction of navigation is always up and turns the course line vertical on the screen.
- **Defaults**—restores map settings to factory defaults for all tabs. Press the **Defaults** soft key to restore original settings.

Detail Sub Tab

Use the Detail sub tab to control the amount of detail for charts, waypoints, active routes, Tide Stations, services, saved tracks, and track logs shown on the Map Page.

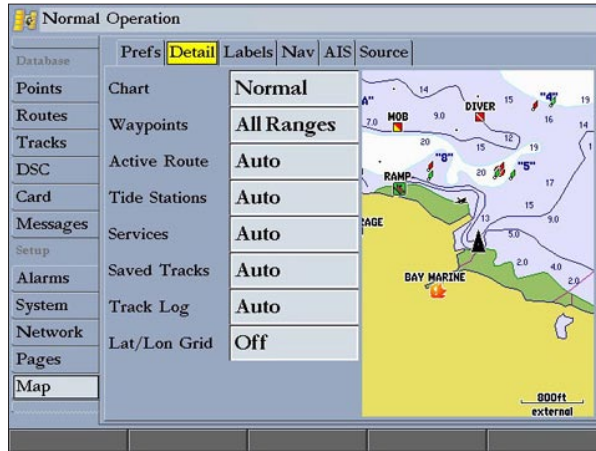

- **Chart**—controls how much map detail you see and which charts the unit chooses to use for a particular zoom range. Select **Most**, **More**, **Normal**, **Less**, or **Least**.
- **Chart**, **Waypoints**, **Active Route**, **Tide Stations**, **Services**, **Lat/Lon Grid**—sets the maximum scale at which the feature should appear on-screen. Select **Off**, **All Ranges**, **Auto**, or **<30 ft to <800 nm**.



NOTE: Some types of data only show up to certain zoom scales.

Labels Sub Tab

Use the Labels sub tab to select the screen size of the text for a given map item.

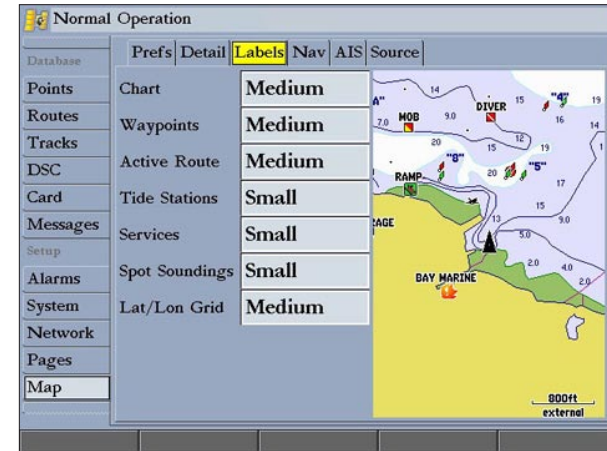

Chart, **Waypoints**, **Active Route**, **Tide Stations**, **Services**, **Spot Soundings**, **Lat/Lon Grid**—controls the screen size of the text for a given map item. Select **None**, **Small**, **Medium**, or **Large**.

Nav Sub Tab

Use the Nav sub tab to show or hide certain navigational features on the Map Page and the scale at which they appear.

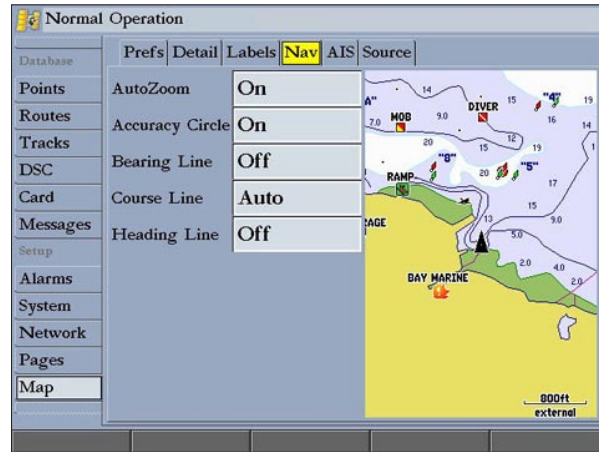

The Nav sub tab contains the following options:

- **AutoZoom**—toggles the automatic zoom on or off. When **On**, the map automatically adjusts the map to a lower range as you approach your destination point.
- **Accuracy Circle**—toggles the circle on or off. The circle represents the approximate accuracy of the GPS position based on EPE (Estimated Position Error) and map data quality. Your actual location is somewhere within the circle.

- **Bearing Line**—sets the maximum scale at which the feature appears on the screen and toggles the red/yellow line that continually points to the current navigation point. Select **Off**, **All Ranges**, **Auto**, or **<30 ft to <800 nm**.
- **Course Line**—sets the maximum zoom scale at which the course line appears on-screen. Select **Auto**, **Off**, or **<120 ft to <800 nm**.
- **Heading Line**—draws an extension from the end of the boat icon in the direction of travel. For **Distance**, enter the numeric distance value to which you want the line to extend. For **Time**, enter the numeric time value for which you want the line to extend. The Time line length automatically adjusts as your speed changes.

AIS Sub Tab

AIS (Automatic Identification System) alerts you to area traffic. AIS provides ship IDs, position, course, and speed for ships equipped with a transponder within range.



NOTE: You must set your chartplotter communication to NMEA In/NMEA Out with a baud rate of 38,400 to receive AIS information.

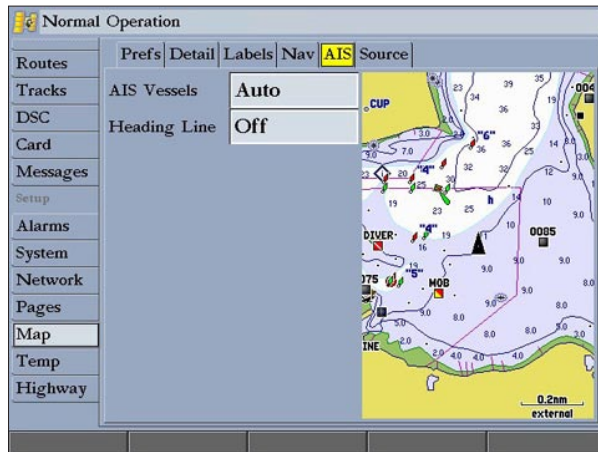

The AIS sub tab contains the following options:

- **AIS Vessels**—sets the maximum zoom scale at which AIS vessels appear on-screen. Select **Off**, **Auto**, **All Ranges**, or **<30 ft to <800 nm**.
- **Heading Line**—draws an extension from the end of the boat icon in the direction of travel. For **Time**, enter the numeric time value for which you want the line to extend. The **Time** line length automatically adjusts as your speed changes.

Source Sub Tab

Use the Source sub tab to turn basemaps and card maps on or off.

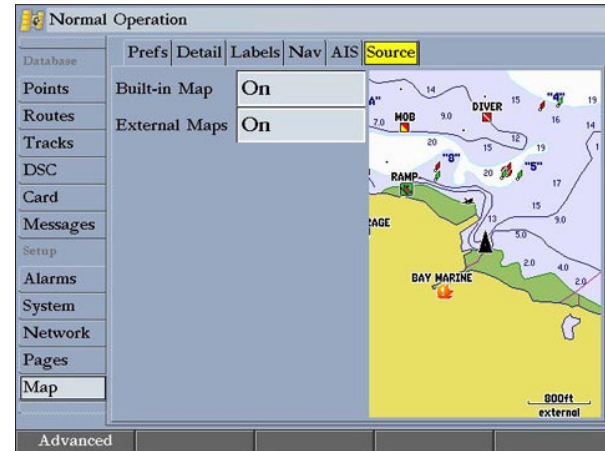

- **Built-in Map**—turns the built-in basemap on or off.
- **External Maps**—turns all optional BlueChart g2 or MapSource data on the data card on or off.

Use the **Advanced** soft key to show a list of the optional BlueChart or MapSource data loaded on the data card. Each map family (or type) is described by name and can be hidden if you do not want to show the data on the Map Page.

To show the Advanced Map Card Setup:

1. Press the **Advanced** soft key to open the Advanced Map Card Setup window.
2. Use the **ROCKER** to highlight a map family in the Map Family Name list.

- Press the **Off** soft key to select or hide the map family, or press the **On** soft key to show the map family. The map appears on the Map Page when a check mark appears in the box adjacent to the map.
OR
Press the **Show All** soft key to show all map families. Press the **Show None** soft key to clear all check boxes.

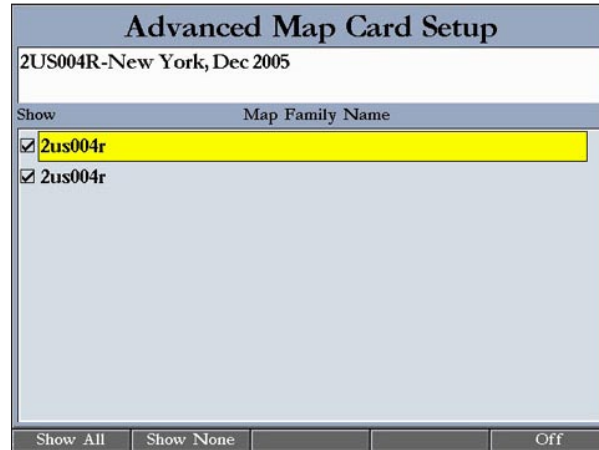

- To view the notes or chart information for that map area, highlight the map name, and press **ENTER**.
- Press the **Chart Info** soft key to view chart information. Press the **Notes** soft key to view chart notes.
- To scroll through the notes, highlight the **Notes** fields, press **ENTER**, and use the **ROCKER** to scroll up, down, left, and right.
- Press **QUIT** to exit.

Temp (Temperature) Tab

The Temp tab displays the water temperature log (if equipped with a temperature sensing transducer or receiving NMEA Sonar temperature data). The chart reads from right to left, so that the most recent temperature measured appears on the far right side of the chart. The dotted grid lines within the chart indicate intervals in the temperature scale and the duration of time.



- Log and Graph Scale**—sets the temperature range (in degrees) for the log. Select **Auto** to have the unit automatically determine the best range, or select a span of 2, 4, 6, 8, or 10 degrees. Use the **Reset** button in Auto mode to reset the automatic range.
- Log Duration**—sets how fast or slow the temperature log scrolls (the shorter the time duration, the faster the temperature log scrolls). Select a duration from 1 minute to 2.5 hours.

Sonar Tab

The Sonar tab contains setup options for the Sonar Page. See the “Using Sonar” section on page 72 for more information.

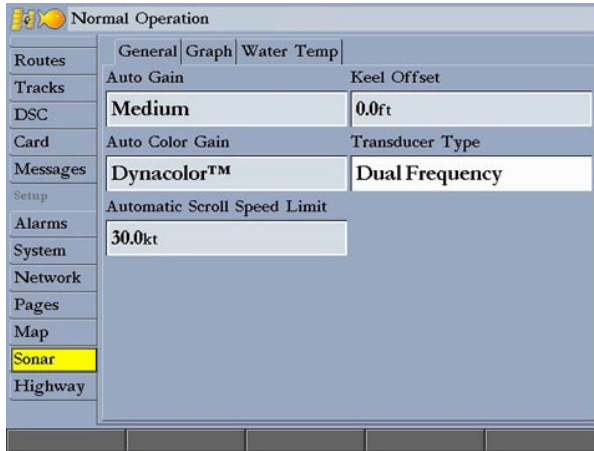

Highway Tab

Use the **Highway** tab to select whether waypoints and tracks are shown on the Highway Page. Use the **ROCKER** and the **ENTER** key to select or clear options.



- **Active Route Waypoints**—show all active route waypoints.
- **User Waypoints**—show only nearby waypoints.
- **Track Log**—show current active track log.
- **Saved Tracks**—show any saved track logs.

USING SONAR

This section covers the additional options for the GPSMAP 2106/2110 when used with a GSD 20, GSD 21, or GSD 22 Sounder Module. Read the installation instructions included with your Garmin Sounder Module to install it.



NOTE: You must have a GSD 20, GSD 21, or GSD 22 Sounder Module installed and connected to your GPSMAP 2106/2110 to use the sonar features.

Understanding Sonar

The transducer mounted on your vessel sends sound waves down into the water in a cone shape, similar to a flashlight beam (covering a smaller circular area at the top and angling out to a larger circular area at the bottom). These sound waves reflect off of any object that they hit, and then the waves travel back up to the transducer. These objects could be fish, branches, the bottom, or any other object that has a density that is different from the water. The transducer receives the sound wave information and then sends the information to the GSD 20, GSD 21, or GSD 22 sounder module and then to the GPSMAP 2106/2110. The GPSMAP 2106/2110 displays the information on the screen for you to see and interpret. The type of transducer and the settings that you choose determine how the information appears on the screen.

Using Dual Frequency

Dual frequency works best for deep water (off-shore) applications. The 200 kHz frequency allows you access to great detail about what is underneath your boat. The 50 kHz frequency provides less detailed information, but penetrates to greater depths with the same power. You can choose either or both frequencies to get the information that you want. If you choose dual frequency, the transducer alternates between the 50 kHz and 200 kHz signals. This capability allows you to see the best picture available at any depth.

Using Dual Beam

Dual beam works best for shallow water (for example, inland) applications. A dual beam transducer can transmit a narrow or a wide beam. The water area covered by the transmitted sound waves is determined by the beam width of the transducer and the water depth. The narrow beam provides crisp detail of what is under your boat, and is very helpful if you are fishing in deeper water where the beam covers more area (for example, at a 30-foot depth, the narrow beam covers the area of about a 7-foot circle).

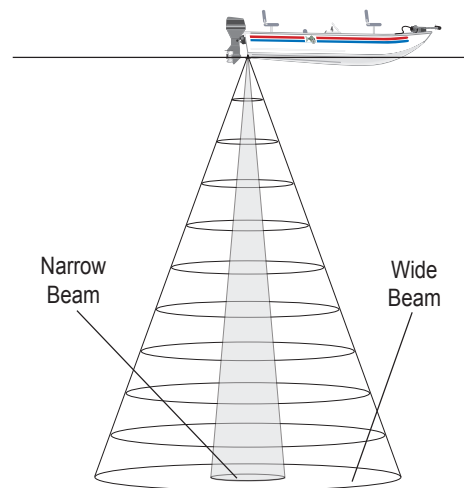

The wide beam is more helpful in shallow water, because it gives you a much wider view of objects in the water, including areas beyond the sides of your boat. At a 30-foot depth, the wide beam covers the area of approximately a 20-foot circle.

Understanding the Sonar Display

One of the first things to understand about sonar is that the transducer sends a beam down to the bottom of the water, much like the beam of a flashlight. The beam starts small near your vessel and expands as it gets to the bottom.

The Sonar Page does not show a 3-D representation of the underwater environment. Instead, the display is in two dimensions, much like if you took a picture of an aquarium. Only the depth of the item in the water is shown.

The strongest sonar returns appear on your screen as the most intense solid color (depending on your selected color scheme; red is the default). The weakest returns appear as the less intense, less solid colors (blue is the default).

The bottom of the water will always be the strongest signal, and therefore the most intense color. The bottom is the continuous, intensely-colored line running across the bottom of the screen. The GPSMAP 2106/2110 uses the latest technology in interpreting bottom signals; it can see through fish, structures, and thermoclines (shown in the weakest colors). However, large schools of fish or dense structures close to the bottom can affect water depth return readings.



NOTE: If the GPSMAP 2106/2110 is unable to track the bottom for any reason, the digits in the depth window flash on and off to alert you that the unit is not tracking the bottom.

At the top of the screen, you might see a grouping of intense colors. This area is surface clutter, which can be caused by waves or any other sonar interference at the surface of the water. Too much surface clutter can obscure your view of fish. You can turn down the Gain setting to reduce this surface clutter.

Between the bottom and the surface clutter, the fish appear as arches. Actual fish returns might not always appear as perfect arches, due to the speed, fish orientation, or other conditions. You can turn on the Fish Symbols setting if you want to see on-screen fish in a fish shape.

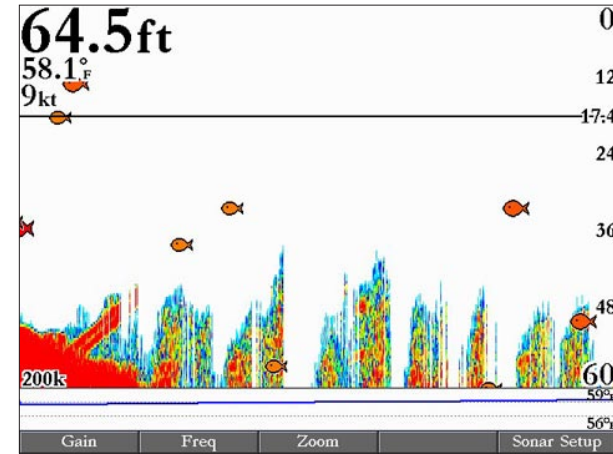

Fish Symbols Turned On

The strength of the sonar return can also help you interpret the hardness of the bottom of the water (the thicker the bottom line, the harder the bottom).

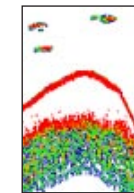

Hard Structure

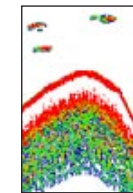

Soft Structure

Sonar Page

The Sonar Page is where your GPSMAP 2106/2110 becomes a powerful fishfinder/flasher. If a GSD 20, GSD 21, or GSD 22 sounder module is not attached, the Sonar Page appears only when the GPSMAP 2106/2110 is in Simulator Mode or if the **Sonar** check box is selected on the System tab.

To view the Sonar Page:

Press **PAGE** repeatedly until the Sonar Page appears.

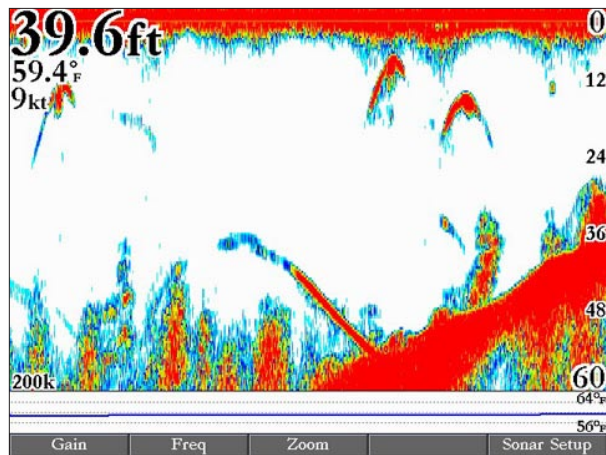

The sonar function window contains a right-to-left moving sonar image of the water beneath your boat. Items appear as they pass under the transducer. The most recent data is shown on the right side of the screen. The right side of the screen contains a scale reflecting the depth of the area being shown. The top-left corner shows the depth, water temperature, and speed through water (if equipped with a temperature or speed sensor).

Use the **Fish Symbols** option to view the actual sonar data, fish symbols, or a combination of both. Fish symbols appear as red.

You can set the sonar display to show a split screen view of a zoomed portion of the sonar, split frequencies, bottom lock (display scaled from the bottom up) or a combination of these options. For example, you can choose to show dual frequency at a 2X zoom (Dual 2X) on one half and normal range dual frequency (Dual) returns on the other half. The display mode appears at the bottom of each sonar display.

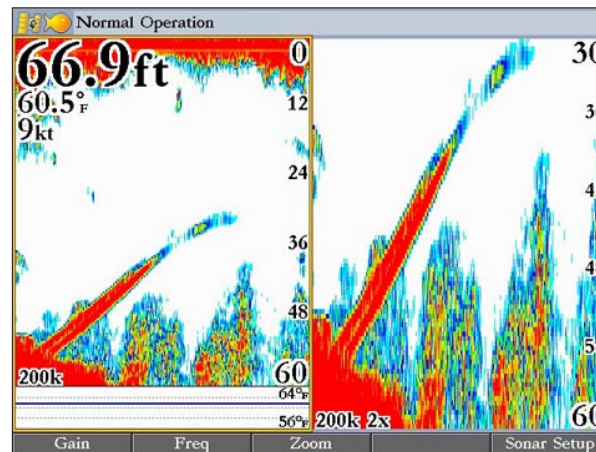

Sonar Page with Split Screen

Configuring the Sonar Page

You can customize the Sonar page to fit your navigational needs See “[Configuring Main Pages](#)” on page 31 for more information.

To add or remove functions on the Sonar Page:

1. Open the Sonar Page, and then press and hold the **DATA/CNFG** key to open the Configuration window.



2. Using the **ROCKER**, highlight the function you want to add or remove, and press **ENTER**. Only functions with a check mark in the check box next to them appear on the Sonar Page.

To split the screen:

1. On the Configuration window, press the **Split Zoom** soft key to show a split screen view of a zoomed portion of the sonar.
OR
Press the **Split Freq** soft key to show two different frequencies.
2. Press **QUIT** to return to the Sonar Page.

Using the Flasher

If you prefer the appearance of flasher sonars, select the **Flasher** function on the Configuration window for the Sonar Page. It provides an almost instantaneous return of what is below your boat.

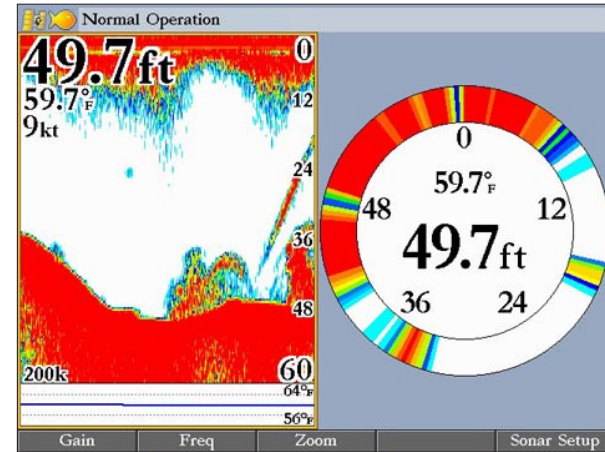

Sonar Page and Flasher

The most intense, constant signal on the Flasher is the actual depth and bottom. The colors indicate the different strength of the signals.

- A soft bottom (such as silt or mud) creates a signal that is narrow and more faint.
- A hard bottom (such as sand or rock) creates a signal that is wider.

Using the Sonar Adjustment Menu

Use the Sonar adjustment menu to access the settings and features most commonly used on the Sonar Page.

To select an adjustment option from the Sonar Page:

1. Press **ADJ** to open the Sonar adjustment menu.

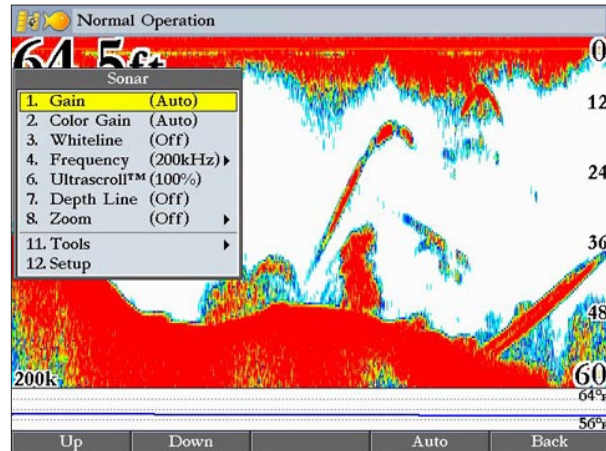

2. Press up or down on the **ROCKER** to highlight the option you want to change, and press **ENTER**.
3. Use the soft keys to make adjustments.
4. To exit any of the adjustment options, press the **Back** soft key, or press **QUIT**.

To change a Sonar adjustment menu setting:

1. Select an adjustment menu option using the method described previously.
2. Press up or down on the **ROCKER** to change the setting, range, or percentage (Off, 1-100%).
3. Press **ENTER** to accept the change, or **QUIT** to close the Sonar adjustment menu.

The Sonar adjustment menu contains the following options:

- **Gain**—controls the sensitivity of the sonar receiver. **Auto** (default) is the recommended setting. It automatically sets the sonar sensitivity. You can also set the gain manually. To see more detail on the screen, increase the receiver sensitivity by selecting a higher gain. If there is too much detail or if the screen is cluttered, lower the sensitivity (lower the gain) to increase the clarity of the screen. If Frequency is set to **Dual**, you can set the Gain separately for each frequency (50 kHz and 200 kHz).
- **Color Gain**—controls what colors are applied to the objects on the screen. **Auto** (default) is the recommended setting. It automatically sets the colors, based on your Auto Color Gain setting. You can also set the Color Gain manually. If Frequency is set to **Dual**, you can set the Color Gain separately for each frequency (50 kHz and 200 kHz).
- **Whiteline**—controls how the unit shows information about the bottom type (hard or soft). With the Whiteline Off, the bottom return shows as red and contains no information on bottom hardness. With Whiteline set at Normal or 1-100%, the bottom return becomes white with a red line, in the default color scheme, indicating where the water meets the bottom. To turn the Whiteline Off, press the **ROCKER** down until the setting bar is all the way at the bottom of the range and reads Off.

- **Frequency**—only appears when using a dual frequency transducer. This allows you to choose a sonar operation frequency. You can choose **200 kHz**, **50 kHz** or **Dual** frequency (to alternate between the two frequencies).
- **Ultrascroll™/Scroll**—adjusts the rate at which the Sonar Pages scroll from right to left. **Ultrascroll™** (default) is used when you select a scroll rate from 90% to 100%. **Auto** automatically adjusts the scroll rate according to the boat's speed.
- **Depth Line**—adds a horizontal depth line across the screen that is used to measure the depth of underwater objects. The depth of the line appears on the right side of the line. Press up or down on the **ROCKER** to control the position of the line on the Sonar Page. To turn the Depth Line off, press the **ROCKER** up until the setting bar is all the way at the top of the range and reads **Off**.

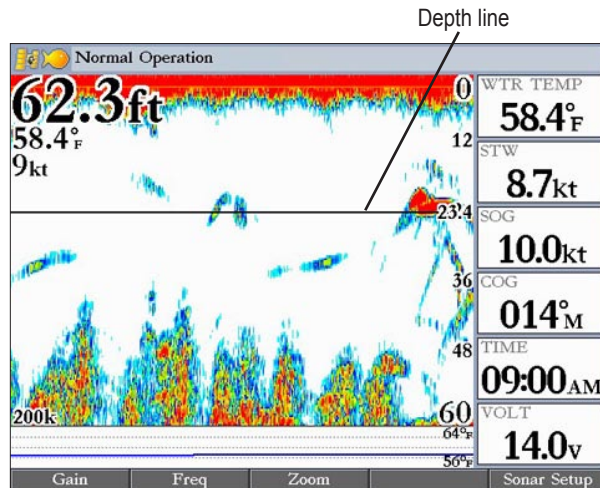

- **Zoom**—sets a screen zoom scale. The following settings are available:
 - **Off**—turns off the Zoom function.
 - **2x Zoom**—displays the 2x zoomed picture.
 - **4x Zoom**—displays the 4x zoomed picture.
 - **Btm (Bottom) Lock**—displays returns from the bottom up. When using this setting, “BL” appears at the bottom of the screen.
- **Zoom View**—available when you select a Zoom scale other than **Off**. You can use the Zoom View setting to change the viewing range of a zoomed display. **Auto** follows the water bottom. If the display is set to **Bottom Lock**, the Span setting adjusts how far off the bottom the unit shows data.
- **Tools**—controls the display of useful sonar tools. The following options are available:
 - **A-scope**—when you turn on A-scope, a vertical flasher bar appears on the far-right side of the screen. This flasher displays structure and bottom returns much the same as the Flasher Page. The horizontal width of the A-scope signal indicates the strength of the signal.
 - **Color Bar**—shows a gradient scale of the current Color Gain setting.
 - **Temp Graph**—appears only if you have a temperature-capable transducer. When on, this setting displays a temperature graph on the bottom of a Sonar Page that matches the scrolling data.
- **Setup**—opens the Sonar tab.

To adjust the range:

On the Sonar Page, press the up **RANGE** key to decrease the range, or press the down **RANGE** key to increase the range.

The unit can be set to automatically track the bottom (Auto) or set to a user-specified depth range.

Using the Pointer on the Sonar Page

You can display the pointer (arrow) to reference sonar items and mark underwater waypoints. This makes it easier to find and use an object such as a stump as a future fishing location.

When using this feature, the Sonar Page pauses. The depth continues to update while the display is paused, but the unit does not show any new sonar data until the Sonar Page resumes scrolling. Discontinuity is possible from where the sonar information stops and where it starts again.

Marking an Underwater Waypoint

You can mark waypoints that are under the surface of the water.

To mark an underwater waypoint:

1. On the Sonar Page, use the **ROCKER** to move the pointer to the location you want.
2. Press and release **ENTER/MARK**. The Review Waypoint Page appears with the waypoint's coordinates, default name, and pointer depth automatically filled in.
3. To change the name, symbol, or depth, highlight the appropriate field, and press **ENTER**. Make any changes, and press **ENTER** when finished.
4. Highlight **OK**, and press **ENTER** to return to the Sonar Page.
5. Press **QUIT** to resume scrolling.

Sonar Tab

When a GSD 20, GSD 21, or GSD 22 is connected to the GPSMAP 2106/2110, the Sonar tab appears on the Main Menu.

Use the Sonar tab to set up the Sonar Page. The Sonar tab has three sub tabs: General, Graph, and Water Temp.

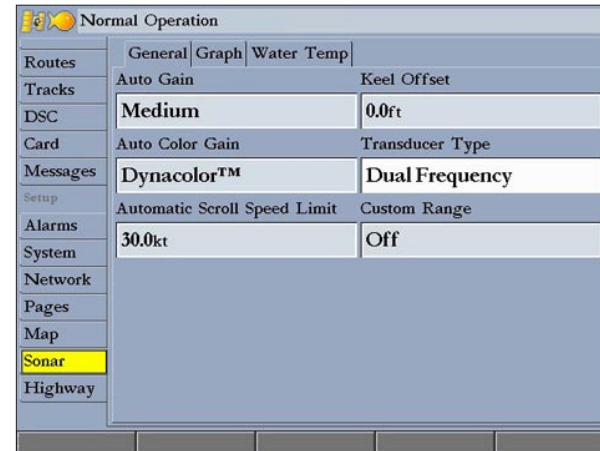

To access and change a setting on the Sonar tab:

1. Press the **Sonar Setup** soft key to open the Main Menu. The Sonar tab is automatically selected.
2. Highlight the setting you want to change, and press **ENTER**.
3. Press **QUIT** to return to the Sonar Page.

General Sub Tab

Use the **General** sub tab to select the water type, depth number, automatic scroll speed limit, scale, keel offset, and transducer type. The available General sub tab options are as follows:

- **Auto Gain**—controls the aggressiveness of the Auto Gain when the Gain option is set to **Auto**. The higher the setting, the greater the number of targets appear on the screen. The lower the setting, the less clutter on the screen. The settings are **Low**, **Medium** (default), and **High**.
- **Auto Color Gain**—controls what colors are applied to the objects on the screen when the Color Gain option is set to **Auto**. **Color DCG™** is based on depth and makes it easier to spot subtle changes in bottom conditions or fish sizes. **DynaColor™** (default) represents the latest in sonar data presentation and is recommended for all applications. The presentation is based on bottom strength. It makes the bottom and the fish easier to see and requires fewer adjustments.
- **Automatic Scroll Speed Limit**—automatically adjusts the Scroll rate with the speed of your vessel. Entering your maximum cruising speed produces a 100% scroll rate when you reach that speed. One half of that speed produces a 50% scroll rate, and so on. The default is **30.0 kt**.
- **Keel Offset**—allows you to offset the surface reading for the depth of a keel. This makes it possible to measure depth from the bottom of your keel instead of from a transducer's location near the water line. Enter a positive number to offset for a keel. You can also enter a negative number to compensate for a large vessel that may draw several feet of water, requiring the transducer to be submerged if you want to measure from the water line. The **Keel Offset** is reflected in the depth reading.

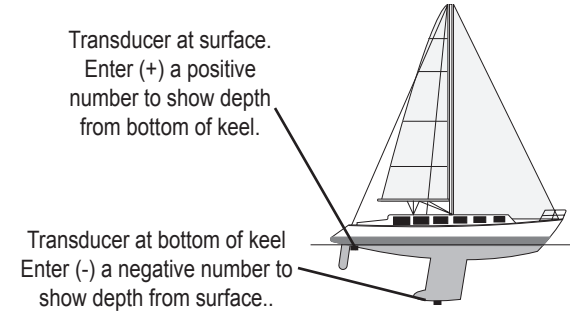

- **Transducer Type**—allows you to specify what type of transducer you are using, either **Dual Beam** or **Dual Frequency**.
- **Calibrate Water Speed**—this is available only if you are using a speed-capable transducer/sensor. Calibration is required to ensure that the Water Speed shown on your unit is accurate. The unit automatically uses the GPS ground speed, if it is available, for comparison on the calibration. If a GPS ground speed is not available, use either your boat's speedometer reading (not always accurate) or a stopwatch to determine your speed over a certain distance ($\text{distance} / \text{time} = \text{speed}$). It is recommended that you calibrate in water having little or no current.

To calibrate the water speed:

1. On the **Sonar** tab, press the **Cal Water Spd** soft key.
2. Bring the boat to cruising speed. Both the top ground and uncalibrated water speeds are shown at the bottom of the calibration window. Note your top speed, stop the boat, and press **ENTER**.
3. By default, the top ground speed automatically appears in the “**What was your top water speed?**” field. If a ground speed is not available, the top uncalibrated water speed is used instead. If the new speed is correct, highlight **OK**, and press **ENTER**. If you want to manually enter a calibration, press **ENTER** on the speed field, enter a new speed, and press **ENTER**.

Graph Sub Tab

Use the Graph sub tab to select the color scheme, fish symbols, and scale.

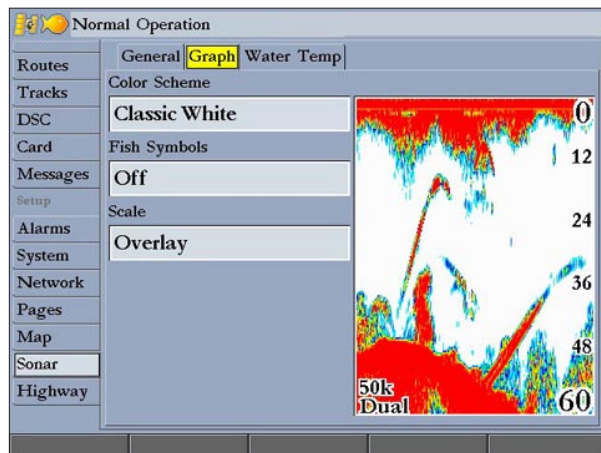



The available Graph sub tab options are:

- **Color Scheme**—sets the colors for the Sonar and Flasher Pages.
- **Fish Symbols**—sets how the Sonar Page interprets suspended targets and background information. If you select a fish symbol, the GPSMAP 2106/2110 identifies some returns for you by replacing them with fish symbols (in large, medium, and small sizes based on the size of the sonar return). If you are using dual beam, fish symbols from the narrow beam (directly underneath your boat) are solid, and the returns from the wide beam (out to the sides of your boat) are hollow.

Off The Sonar Page does not interpret the sonar return data.

 Suspended targets appear as symbols. No background information appears

 Same as previous with the target depth shown.

 Suspended targets appear as symbols. Background information appears, making the distinction between fish and structure easier.

 Same as previous with target depth shown.

- **Scale**—controls the appearance of the depth scale shown vertically along the right side of the graph. You can configure the depth scale to appear in one of four different ways: as an **Overlay**, in the **Corners**, **Basic**, or **No Scale**.

Water Temp Sub Tab

The Water Temp sub tab enables you to control the temperature log (if your boat is equipped with a temperature transducer/sensor). The graph reads from right to left, so that the most recent temperature measured appears on the far-right side of the log. The dotted lines within the graph indicate intervals in the temperature scale and the duration of time.

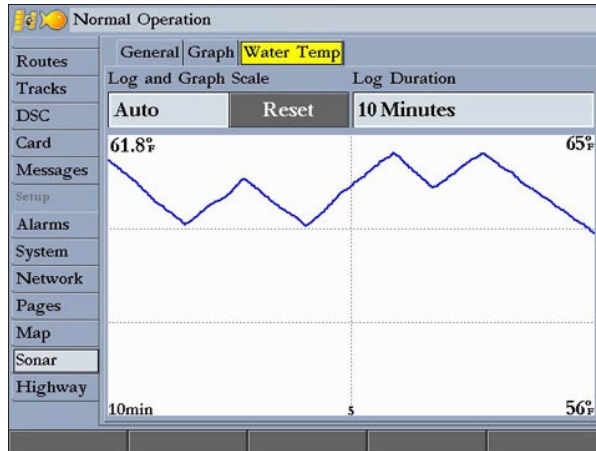

The following settings are available:

- **Log and Graph Scale**—sets the temperature range (in degrees) to display on the log and on the Sonar Pages. Select **Auto** to have the unit automatically determine the best range, or select a Span of **2, 4, 6, 8, or 10** degrees.
- **Log Duration**—sets how fast or slow the temperature log scrolls (the shorter the time duration, the faster the temperature log scrolls). Select a duration from **1 Minute to 2.5 Hours**. **10 Minutes** is the default.
- **Temperature Log**—records the water temperature as you move through the water so that you can look for temperature changes over a period of time.

APPENDIX

Specifications

Physical Specifications

Size: GPSMAP 2106: 6.5" H x 10.3" W x 3.3" D (16.5 x 26.2 x 8.4 cm)
GPSMAP 2210: 8.8" H x 13.1" W x 3.0" D (22.4 x 33.3 x 7.6 cm)

Weight: GPSMAP 2106: 3.0 lbs (1.4 kg)
GPSMAP 2110: 5.0 lbs (2.3 kg)

Display: GPSMAP 2106: 6.4" diagonal (16.3 cm)
GPSMAP 2110: 10.4" diagonal (26.4 cm)
High resolution, 256-color TFT (640 x 480 pixels), full VGA, with adjustable backlighting

Case: Fully gasketed, high-impact plastic alloy, waterproof to IEC 60529-IPX 7

Temp. Range: 5°F to 122°F (-15°C to 50°C)

GPS Performance (with GPS 17)

Receiver: Differential-ready 12 parallel channel WAAS-capable receiver

Acquisition Times:

Warm: Approx. 15 seconds

Cold: Approx. 45 seconds

AutoLocate: Approx. 2 minutes

Update Rate: 1/second, continuous

GPS Accuracy:

Position: <15 meters (49 feet), 95% typical*

Velocity: 0.05 meters/sec steady state

WAAS Accuracy:

Position: <3 meters (10 feet), 95% typical*

Velocity: 0.05 meters/sec steady state

Dynamics: 6gs

Power

Source: 10-33 V DC

Usage: 25 watts max. at 10 V DC

Fuse: AGC-3 - 3.0 Amp

Installing and Removing Data Cards

The GPSMAP 2106/2110 uses optional Garmin BlueChart® and MapSource® data cards. You can use optional preprogrammed BlueChart g2™ data cards.

Insert data cards in the card slots located on the left side of the unit. You can install or remove data cards at any time, whether the unit is on or off.

To install a data card:

1. Open the card door by pressing the locking tab on the door toward the outside (left) of the unit and lifting the door open from right to left.
2. Insert the card into the slot, with the label facing to the right and the handle facing toward you.
3. Push the card into the unit. It is not necessary to force the card, and about 1/2" is still exposed when it is properly inserted. If the unit is on, a confirmation tone sounds, and a message appears on the screen noting the card details when the card is properly installed and accepted.
4. Close the cover until it locks.

If you insert a data card and receive a “card format not recognized” message, remove the card and reinsert it. If the card is still not recognized, contact Garmin Product Support or your Garmin dealer for assistance.



NOTE: Data cards are not waterproof, should not be exposed to moisture or excessive static charges, and should be stored in the case supplied with the card.

The first time you insert a data card, the unit takes a few seconds to read the card. After the data card is read, a summary page appears. Press **ENTER** to acknowledge.



To remove a data card:

1. Open the card door by pressing the locking tab on the door toward the outside (left) of the unit and lifting the door open from right to left.
2. Grasp the card handle, and pull out firmly.
3. If the unit is on, a confirmation tone sounds when the data card is removed.

What is WAAS/EGNOS?

The Wide Area Augmentation System (WAAS) is an FAA-funded service to improve the overall integrity of the GPS signal for users in North America. In Europe, WAAS is referred to as EGNOS.

The system is made up of satellites and approximately 25 ground reference stations positioned across the United States that monitor GPS satellite data. Two master stations, located on either coast, collect data from the reference stations and create a GPS data correction message.

According to the FAA's Web site, testing of WAAS in September 2002 confirmed an accuracy performance of 1–2 meters horizontal and 2–3 meters vertical throughout the majority of the continental United States and portions of Alaska.

WAAS is just one service provider that adheres to the Minimum Operational Performance Standard (MOPS) for global Satellite Based Augmentation Systems (SBAS). Eventually there will be several services of worldwide geostationary communication satellites that broadcast integrity information and differential correction data as transmitted by ground reference stations.

All SBAS systems use the same receiver frequency; therefore any operational SBAS system should be capable of providing your GPS unit with increased accuracy at any location in the world.

Currently, enabling WAAS on your GPSMAP 2106/2110 in regions that are not supported by ground stations may not improve accuracy, even when receiving signals from an SBAS satellite. In fact, it can degrade the accuracy to less than that provided by GPS satellites alone. For this reason, when you enable WAAS on your Garmin GPS receiver, the receiver automatically uses the method that achieves the best accuracy.

For more information, go to <http://gps.faa.gov>.

WAAS Capability

The GPSMAP 2106/2110 is capable of receiving WAAS satellite signals. Effective use of the WAAS satellite signal may be limited by your geographic location in relation to those satellites, now in developmental service. WAAS satellite signal reception requires an absolute clear view of the sky and works best when there are no nearby obstructions such as buildings or mountains.

WAAS satellites are numbered 33 or higher when viewing the sky view on your GPSMAP 2106/2110. Initial reception of the WAAS signal may take up to 15-20 minutes, then 1–2 minutes afterwards. When WAAS differential correction has been received for GPS satellites (numbers 32 or below), a “D” appears in the signal bar of the sky view and “Ready For Navigation with WAAS” appears in the Status field. To learn more about the WAAS system, its satellite locations and current state of development, visit the FAA web site (<http://gps.faa.gov>). Because WAAS requires CPU resources of the GPSMAP 2106/2110 to search for and track the satellites, you can disable the WAAS feature to improve unit performance if WAAS reception is not available in your area.

To disable or enable WAAS capability:

1. On the **GPS** tab, highlight the **Setup** sub tab.
2. Use the **ROCKER** to highlight the **WAAS** field, and press **ENTER**.
3. Highlight **On** or **Off**, and press **ENTER**.

Digital Selective Calling (DSC)

When your GPSMAP 2106/2110 is connected to a VHF radio with DSC support, the GPS unit displays a Call List, Log, and a Directory to store incoming information received from another user's DSC capable VHF/GPS combination. Basic wiring is required for the Garmin unit and VHF radio to send and receive NMEA data from each other. See the *GPSMAP 2106/2110 & GPS 17 Installation Instructions*.

What is DSC?

Digital Selective Calling (DSC) uses marine VHF radio and Global Positioning System (GPS) technologies to transmit and receive location information. DSC is used by mariners to assist them in two major areas: distress calls and position reporting.

A non-emergency DSC position report allows mariners to exchange and display the positions of one another. When a DSC position is received, the mariner can choose to create a waypoint or show the received position on an electronic map.

An emergency DSC distress call allows a vessel in trouble to transmit a substantial amount of information in a single transmission or "call" without the need for voice communication. When any nearby rescuer receives the DSC signal, an alarm sounds, and they immediately receive the position of the caller.

The rescuer can then choose to navigate (Go To) the caller's position to assist or forward the call on to the Coast Guard. When the Coast Guard receives the call, they can immediately access the caller's information (such as who they are and the type of vessel) in their database while they are in transit to the caller's location.

Any time a vessel receives a DSC call, the vessel can store that location and quickly navigate to that position using a Go To. This makes DSC a time-saver, especially in an emergency situation. To use DSC, users must first register their VHF radio with the FCC and receive a Maritime Mobile Service Identity (MMSI) number.

What is a Maritime Mobile Service Identity (MMSI)?

Maritime Mobile Service Identity (MMSI) allows a VHF radio to act like a phone. To make a "call" on a phone, you first need a phone number to dial. The 9-digit MMSI number acts like a phone number when used in a Position Report and as a unique identifier to the Coast Guard when used in an emergency distress call. To obtain a Maritime Mobile Service Identity (MMSI) number, users must register their VHF radio with the FCC (Form 605). **Garmin does not supply this number!**

How Are MMSI Assignments Obtained?

Non-commercial users (recreational users who remain in domestic waters and only carry VHF, EPIRB (Emergency Position Indicating Radio Beacons, and Radar)) are not required to have a FCC ship station license. The FCC and Coast Guard have authorized some second and third-party vendors to assign MMSI numbers. This service is limited to registering recreational vessels only. To receive information on how to obtain a recreational MMSI number, visit <http://www.uscg.mil/rescue21/links/mmsi.htm> or <http://wireless.fcc.gov/marine/>.

Non-Federal Users in the United States

Commercial users, or those who travel outside the U.S.A. or Canada, must apply for a ship station license, or an amendment to a ship station license. To find out if you require a Ship Station license, visit <http://wireless.fcc.gov/marine/ftsht14.html>. If your vessel requires licensing by the FCC, you can obtain a MMSI during the application/licensing process when you file FCC Forms 159 and 605.

Federal Users in the United States

Federal users can obtain MMSI assignments from their agency radio spectrum management office. These procedures are currently under review by the NTIA (National Telecommunications and Information Administration).

Users Outside the United States

Users can obtain an MMSI assignment from their telecommunications authority or ship registry, often by obtaining or amending their ship station license.

Users in Canada

Industry Canada is responsible for assigning MMSI numbers to commercial and recreational vessels. Information is available at the following Web site:

<http://apollo.ic.gc.ca/english/mmsi.html>.

For more information regarding MMSIs visit:

<http://www.navcen.uscg.gov/marcomms/gmdss/mmsi.htm>.

How Can Garmin Help You with DSC?

To receive Distress Calls or Position Reports, you must have a DSC-equipped chartplotter as well as a VHF radio with DSC support. During normal, non-emergency Position Report communication, Channel 70 (156.525 MHz) has been set aside as the VHF/DSC digital call channel.

For a Distress Call, a mariner presses the MayDay button on the VHF radio. The call transmits on an emergency channel with the MMSI number attached to the call (if you have DSC support). Any DSC-equipped mariner (on sea or land) within range can receive the call.

LORAN TD System

LORAN-C is a radio navigation aid operated and maintained in the U.S.A by the United States Coast Guard. The LORAN (LOng RAnge Navigation) system covers the entire U.S.A. and the U.S. Coastal Confluence Zone. From the perspective of a mariner, the system is used for ocean and coastal navigation. It can be used as a supplemental system for harbor and harbor approach navigation, and it is used for inland navigation by recreational vehicles.

LORAN TD Feature

The LORAN TD (Time Delay) feature eases the transition from using LORAN to using GPS. The GPSMAP unit automatically converts GPS coordinates to LORAN TD for those who have a collection of LORAN fixes for favorite fishing spots and other waypoints recorded as TDs. You can show your position as a TD or enter waypoints as TDs. The expected accuracy from this conversion is approximately 30 meters. When the unit is placed in the LORAN TD format mode, it simulates the operation of a LORAN receiver. Position coordinates can be displayed as TDs, and you can use all navigation functions as if the unit was actually receiving LORAN signals.

Using the LORAN TD Format

When creating new waypoints using LORAN TD coordinates, you must set the correct LORAN chain number and secondary stations in the Setup TD field before storing a waypoint. You must have the correct chain number and the secondary station identifiers to use this option correctly. These values vary for each coordinate set or geographical location. Failure to enter correct information could result in inaccuracies for the desired destination. After the waypoint is stored in the unit's memory, it always references the LORAN chain number and secondary stations currently selected in the Setup TD field. If you enter a different LORAN chain number, change the secondary stations or offsets in the Setup TD field, the active waypoint information reflects those changes. Because

the GPSMAP 2106/2110 unit does not rely on the LORAN signal for navigation, it can reference a different GRI chain or secondary stations and still navigate to the location stored in memory. The LORAN Position Format field is located on the Units sub tab on the Main Menu—System tab. The Loran TD Setup window contains the fields to select the LORAN Chain Number, Primary and Secondary Stations, and TD Offsets.

To set up LORAN TD from the Main Menu:

1. Using the **ROCKER**, highlight the **System** tab, press right on the **ROCKER** to highlight the **Units** sub tab. Highlight the **Position Format** field, and press **ENTER**.
2. Highlight **Loran TD**, and press **ENTER**, and then highlight the **Setup** button to the right, and press **ENTER** again.
3. To change the settings of any of the five fields, highlight the field, press **ENTER**, select the setting you want, and press **ENTER** again.

If the active GRI Chain, secondary stations, or offsets were changed since the waypoint was created, the waypoint now references the active GRI-chain and secondary stations and adjusts the TD coordinates accordingly. Remember that the GPS is not relying on the LORAN signal for navigation and actually converts the TD coordinate to a useful latitude/longitude coordinate before storing the waypoint to memory or using it for navigation. Because of this, the unit can navigate to a TD coordinate anywhere in the world.

For more information on LORAN TDs, you can download Garmin's *Loran TD Position Format Handbook* from the Garmin Web site.

Caring for the GPSMAP 2106/2110

The GPSMAP 2106/2110 case is constructed of high-quality materials and does not require user maintenance except cleaning.

Cleaning the Case

Clean the unit's outer casing (except for the screen) using a cloth dampened with a mild detergent solution. Wipe dry. Avoid chemical cleaners and solvents that may damage plastic components.

Cleaning the Screen

The GPSMAP 2106/2110 lens is coated with a special anti-reflective coating that is sensitive to skin oils, waxes, and abrasive cleaners. Cleaners containing ammonia, alcohol, abrasives, or anti-grease detergents will harm the anti-reflective coating. It is important to clean the lens using an eyeglass lens cleaner that is specified as safe for anti-reflective coatings and a clean, lint-free cloth.

Storage

Do not store the GPSMAP 2106/2110 where prolonged exposure to extreme temperatures may occur (such as in the trunk of a car) because permanent damage may result. User information, such as waypoints and routes, are retained in the unit's memory without the need for external power. It is always a good practice to back up important user data by manually recording it, loading it to a computer (transferring it to MapSource), or storing it on a data card.

Water Immersion

The GPSMAP 2106/2110 is waterproof to IEC Standard 60529 IPX7. It can withstand immersion in 1 meter of water for 30 minutes. Prolonged submersion can cause damage to the unit. After submersion, be certain to wipe and air dry the unit before reuse.

Navigation Terms

Avg Speed—the average of all second-by-second speed readings since the last reset.

Bearing (BRG)—the compass direction from your current location to a destination.

Course—the course between the active from and to waypoints.

Depth—the depth below the transducer. This field is active only if the GPSMAP 2106/2110 is connected to a Garmin Sounder Module or if NMEA depth is available.

Distance (Dist)—the distance from the current location to a destination.

Dist to Destination—the distance from the current location to a Go To destination or the final waypoint in a route.

Dist to Next—the distance from current location to a Go To destination or the next waypoint in a route.

DOP (Dilution of Precision)—reflects the quality of the GPS signals and satellite geometry.

Elevation—the altitude (height) above mean sea level (MSL).

ETA (Estimate Time of Arrival)—the time you estimate to reach your destination waypoint, based on current speed and track.

ETA at Destination—the time you estimate to reach a Go To destination or the final waypoint in a route.

ETA at Next—the estimated time to reach a Go To destination or the next waypoint in a route.

Fuel—the fuel required to travel from your current location to the indicated route waypoint.

GPS Accuracy—estimated accuracy of the GPS position.

Leg Dist—the distance between two route waypoints.

Leg Fuel—the fuel required to travel from a route waypoint to the next waypoint in the route.

Leg Time—the time required to travel from a route waypoint to the next waypoint in the route.

Max Speed—the maximum second-by-second speed recorded since last reset.

Moving Average Speed—the average speed while the unit is moving.

Moving Trip Timer—the total time the unit has been moving.

Odometer—a running tally of the distance traveled, based on the distance between second-by-second position readings.

Off Course—the distance you are off course in any direction, left or right.

Pointer—the arrow indicating the direction to travel to the next point on the route.

Speed—the current velocity at which you are traveling, relative to ground position.

Sunrise—the time at which the sun rises on this day.

Sunset—the time at which the sun sets on this day.

Time Of Day—the current time.

Time To—the estimated time required to reach a Go To destination or the next waypoint in a route. Also known as “estimated time en route” (ETE).

Time to Dest—the estimated time required to reach a Go To destination or the final waypoint in a route.

Time to Next—the estimated time required to reach a Go To destination or the next waypoint in a route.

To Course—the recommended direction to steer to reduce course error or stay on course. Provides the most efficient heading to get back to the course and proceed along your route.

Track—the direction of movement relative to the ground. Also known as “ground track.”

Trip Odometer—a running tally of distance traveled since the last reset. See also “Odometer.”

Total Average Speed—the average speed of the unit for both moving and stopped speeds since the last timer reset.

Total Trip Timer—total time the unit has been in operation since the last reset of the trip timers.

Turn—the angle difference between the bearing to your destination and your current track. **L** indicates you should turn left; **R** indicates you should turn right.

VMG (Velocity Made Good)—the speed with which you are closing in on a destination along a course. Also referred to as the vector velocity to your destination.

Voltage—the current voltage reading being received by unit.

Water Speed—the speed through the water. This field is active only if the GPSMAP 2106/2110 is receiving speed readings from a NMEA device or a Garmin Sounder Module.

Water Temp—the water temperature. This field is active only if the GPSMAP 2106/2110 is receiving temp readings from a NMEA device or a Garmin Sounder Module.

Waypoint Destination—the final waypoint in the route or the destination waypoint.

Waypoint Next—the next waypoint in the route.

Messages and Alarms

The GPSMAP 2106/2110 uses an on-screen message system to notify you of events and alert you to problems. Press **QUIT** to acknowledge a message.

Accuracy Alarm—the GPS accuracy has fallen outside of the user-set value.

Alarm Clock—the alarm clock has sounded.

Anchor Drag Alarm—you have drifted out of the specified distance range.

Approaching Turn—you are nearing a turn in a route.

Approaching <Waypoint>—you are a specified distance from a destination waypoint.

Arrival At <Waypoint>—you have arrived at the destination waypoint.

Battery Alarm—battery voltage has fallen below the value specified in the Battery field on the Alarms tab.

Battery Voltage Is Too High—too much input voltage; the unit will shut off in 10 seconds. Decrease the input voltage to less than 32 volts.

Boat is not Moving Fast Enough to Calibrate—the boat is not moving fast enough for the speed wheel to provide a valid speed.

Can't Read User Card—error reading card; remove and reinsert. Contact your dealer or Garmin Product Support if the problem persists.

Can't Read Voltages That High, Limited To Top Of Range—voltage range must be between 10.0 and 33.0 volts for the GPSMAP 2106/2110.

Can't Read Voltages That Low, Limited To Bottom Of Range—voltage range must be between 10.0 and 33.0 volts for the GPSMAP 2106/2110.

Can't Send Waypoint—the unit cannot transmit the waypoint using the NMEA WPL sentence. Check the wiring.

Can't Unlock Maps—the data on the data card is not unlocked for the unit. Contact your dealer or Garmin Product Support.

Can't Write User Card—error writing to the card; remove and reinsert. Contact your dealer or Garmin Product Support if the problem persists.

Database Error—internal problem with the unit. Contact your dealer or Garmin Product Support to have the unit serviced.

Deep Water Alarm—the depth has changed by the amount of the Drift Alarm value.

Directory Item With This MMSI Already Exists—the MMSI number is already in the DSC directory. Use a different number.

Directory Memory is Full Can't Create Entry—the DSC directory has reached the maximum of 100 contacts. Delete unneeded contacts to add new ones.

Distress Call—a DSC distress call has been received. Take appropriate action.

Drift Alarm—the depth has changed by the amount of the Drift Alarm value.

Fish Alarm—shows an icon and beeps (if enabled) when a fish is detected. This alarm does not show a message banner.

Invalid MMSI—enter a valid MMSI.

Lost Remote GPS Connection—there is a problem with the GPS antenna wiring. Check the connections.

Lost Satellite Reception—the unit has lost satellite signals. Check the antenna connections or try moving to a location with a clear view of the sky.

NMEA Depth Is Below Transducer—you must enter an appropriate Keel Offset for the transducer.

No Proximity Waypoints/Routes/Tracks/User Waypoints Found—you attempted to transfer user data from a data card that does not contain the specified type of data. Make sure there is data to transfer on data card.

None Found—no data matched the search criteria.

Not All Maps Fit, Some Maps will not be drawn—the maximum number of individual maps on the data card was exceeded.

Off Course Alarm—you exceeded the specified off-course distance.

Proximity Alarm Memory is Full—you used all available proximity waypoints.

Proximity Alarm: <Waypoint>—you entered the alarm radius for the proximity waypoint indicated.

Proximity Overlaps Another Proximity Waypoint—the alarm radius specified overlaps the area specified for another proximity waypoint. Adjust the distance.

Route Already Exists: <route name>—you entered a route name that already exists in memory. Modify the route name or delete the previous route name.

Route Is Full—you attempted to add more than 300 points to a route. Reduce the number of points or create a second route.

Route Memory Is Full, Can't Create Route—the maximum amount of 300 routes is already in the unit's memory, and no additional routes can be added until existing ones are removed.

Route Truncated—an uploaded route from another device has more than 300 points and was truncated to fit.

Route Waypoint Memory Full—no additional route waypoints can be saved.

Shallow Water Alarm—the Shallow Water Alarm depth has been reached.

Simulating Operation—the unit is in Simulator Mode. Do not use this mode for normal navigation!

Sonar Failed, Unit Needs Repair—there is an internal problem with the unit. Contact your dealer or Garmin Product Support to have the unit serviced.

Sonar Service Incompatible—the external sonar device you are connected to needs a software update.

Sonar Service Lost—the external sonar device you were connected to has either been disconnected, or the GPSMAP 2106/2110 has lost communication with the sonar device for some other reason.

Timer Alarm—the Timer has reached to 00:00:00.

Track Already Exists: <track name>—you entered a saved track name that already exists in memory. Modify the track name or delete the existing track.

Track Memory Is Full, Can't Create Track—the track log memory is full. No additional track log data can be stored without deleting old data.

Track Truncated—a complete uploaded track does not fit into memory. The oldest track log points were deleted to make space for the most recent data.

Transducer Disconnected, Sonar Turned Off—no transducer is attached, the cable/transducer is bad, or the transducer cable was disconnected. If the transducer cable is removed while the unit is on, reconnect and cycle power.

Transfer Complete—the unit has finished uploading or downloading information to the connected device.

User Card Not Found—you attempted to transfer user data without a data card in the data card slot.

Water Speed Sensor is not Working—the speed sensor is not detected. Check the connections.

Water Temperature Alarm—sonar has reported a temperature above, below, inside, or outside the specified values.

Waypoint Already Exists: <Waypoint>—you entered a waypoint name that already exists in memory. Modify the waypoint name or delete the existing waypoint.

Waypoint Memory Is Full, Can't Create Waypoint—you have used all 4,000 waypoints available. Delete unwanted waypoints to make space for new entries.

Optional Accessories

The following accessories are designed to enhance the operation of your GPSMAP 2106/2110 chartplotter.

To obtain replacement parts and optional accessories, contact your Garmin Dealer, Garmin Product Support in the U.S.A. at 800-800-1020, or Garmin Europe at 44-0870-8501241.



WARNING: Garmin accessories have been designed and specifically tested for use with Garmin products. Accessories offered by other manufacturers have not been tested or approved for use with Garmin products. Use of such accessories could cause damage to the GPSMAP 2106/2110 and void the warranty.

Bluechart g2 Preprogrammed Data Cards—enhance the basemap; featuring additional data including highly detailed coastal roads and points of interest such as restaurants, lodging, local attractions and more. Full-color aerial photos of ports, marinas, bridges, and navigational landmarks are also included on many data cards.

GSD 21 and GSD 22 Remote Sounder Module and Transducers—provides sonar capabilities to the GPSMAP 2106/2110.

MapSource Software CD-ROMs—enhances the basemap and creates waypoints and routes from your computer. MapSource offers several detailed mapping options that are compatible with the GPSMAP 2106/2110, including BlueChart.

Programmable Data Cards—blank data cards are available in 16 MB, 32 MB, 64 MB, and 128 MB sizes. Download street-level map detail, points of interest, business addresses and phone numbers, marine data, topographical information, and more from MapSource CD-ROMs to a data card, either directly through your GPSMAP 2106/2110 using the PC Interface Cable, or with the Data Card Programmer.

USB Data Card Programmer—programs blank data cards and downloads maps to a data card at high speed using the USB port on your computer.

Preprogrammed Data Cards—data cards that are preprogrammed with either Garmin BlueChart or Fishing Hot Spots map data.

Limited Warranty

This Garmin product is warranted to be free from defects in materials or workmanship for one year from the date of purchase. Within this period, Garmin will at its sole option repair or replace any components that fail in normal use. Such repairs or replacement will be made at no charge to the customer for parts or labor, provided that the customer shall be responsible for any transportation cost. This warranty does not cover failures due to abuse, misuse, accident or unauthorized alteration or repairs.

THE WARRANTIES AND REMEDIES CONTAINED HEREIN ARE EXCLUSIVE AND IN LIEU OF ALL OTHER WARRANTIES EXPRESS OR IMPLIED OR STATUTORY, INCLUDING ANY LIABILITY ARISING UNDER ANY WARRANTY OF MERCHANTABILITY OR FITNESS FOR A PARTICULAR PURPOSE, STATUTORY OR OTHERWISE. THIS WARRANTY GIVES YOU SPECIFIC LEGAL RIGHTS, WHICH MAY VARY FROM STATE TO STATE.

IN NO EVENT SHALL GARMIN BE LIABLE FOR ANY INCIDENTAL, SPECIAL, INDIRECT OR CONSEQUENTIAL DAMAGES, WHETHER RESULTING FROM THE USE, MISUSE, OR INABILITY TO USE THIS PRODUCT OR FROM DEFECTS IN THE PRODUCT. Some states do not allow the exclusion of incidental or consequential damages, so the above limitations may not apply to you.

Garmin retains the exclusive right to repair or replace the unit or software or offer a full refund of the purchase price at its sole discretion. SUCH REMEDY SHALL BE YOUR SOLE AND EXCLUSIVE REMEDY FOR ANY BREACH OF WARRANTY.

To obtain warranty service, contact your local Garmin authorized dealer or call Garmin Product Support for shipping instructions and an RMA tracking number. The unit should be securely packed with the tracking number clearly written on the outside of the package. The unit should then be sent, freight charges prepaid, to any Garmin warranty service station. A copy of the original sales receipt is required as the proof of purchase for warranty repairs.

Garmin International, Inc.
1200 E 151st Street, Olathe, Kansas 66062 U.S.A.
Tel. 913/397.8200
Fax. 913/397.8282

Garmin (Europe) Ltd.
Unit 5, The Quadrangle, Abbey Park Industrial Estate, Romsey,
SO51 9DL U.K.
Tel. 44/0870.8501241
Fax 44/0870.8501251

Online Auction Purchases: Products sold through online auctions are not eligible for rebates or other special offers from Garmin. Online auction confirmations are not accepted for warranty verification. To obtain warranty service, an original or copy of the sales receipt from the original retailer is required. Garmin will not replace missing components from any package purchased through an online auction.

International Purchases: A separate warranty is provided by international distributors for units purchased outside the United States. This warranty is provided by the local in-country distributor and this distributor provides local service for your unit. Distributor warranties are only valid in the area of intended distribution. Units purchased in the United States or Canada must be returned to the Garmin service center in the United Kingdom, the United States, Canada, or Taiwan for service.

The Garmin GPSMAP 2106/2110 has no user-serviceable parts. Should you ever encounter a problem with your unit, please take it to an authorized Garmin dealer for repairs.

The GPSMAP 2106/2110 is fastened shut with screws. Any attempt to open the case to change or modify the unit in any way will void your warranty and may result in permanent damage to the equipment.

FCC Compliance



The GPSMAP 2106/2110 complies with Part 15 of the FCC interference limits for Class B digital devices FOR HOME OR OFFICE USE. These limits are designed to provide more reasonable protection against harmful interference in a residential installation, and are more stringent than “outdoor” requirements.

Operation of this device is subject to the following conditions: (1) This device may not cause harmful interference, and (2) this device must accept any interference received, including interference that may cause undesired operation.

This equipment generates, uses, and can radiate radio frequency energy and may cause harmful interference to radio communications if not installed and used in accordance with the instructions. However, there is no guarantee that interference will not occur in a particular installation. If this equipment does cause harmful interference to radio or television reception, which can be determined by turning the equipment off and on, the user is encouraged to try to correct the interference by one of the following measures:

- Reorient or relocate the receiving antenna.
- Increase the separation between the equipment and the receiver.
- Connect the equipment into an outlet on a circuit different from that to which the receiver is connected.
- Consult the dealer or an experienced radio/TV technician for help.

The GPSMAP 2106/2110 does not contain any user-serviceable parts. Repairs should only be made by an authorized Garmin service center. Unauthorized repairs or modifications could result in permanent damage to the equipment, and void your warranty and your authority to operate this device under Part 15 regulations.

Declaration of Conformity (DoC)

Hereby, Garmin declares that this GPSMAP 2106/2110 is in compliance with the essential requirements and other relevant provisions of Directive 1999/5/EC.

To view the full Declaration of Conformity, see the Garmin Web site for your Garmin product: <http://www.garmin.com/products/gpsmap2106/>. Click **Manuals** and then select the **Declaration of Conformity**.

INDEX

Symbols

200 kHz frequency 72
 2X zoom 77
 4X zoom 77
 50 kHz frequency 72

A

A-scope 77
 accessories 92
 accuracy 6
 accuracy circle 68
 acquiring satellites 5
 active track log 50
 ADJ/MENU key 2
 advanced map card setup 69
 alarms
 navigation 57
 system 57
 Alarms tab 56
 anchor drag 57
 arches 73
 arrival alarm 57
 AutoLocate 6
 automatic backlight 58

B

backlight 4, 58
 adjusting 4
 basic operation 8
 battery alarm 57
 Bearing pointer 40
 beeper 59
 BlueChart 11
 BlueChart g2 36, 92

bottom of the water 73
 btm (bottom) lock 77

C

Card tab 54
 cartography 36
 Celestial tab 47
 chart 67
 cleaning 87
 clock alarm 57
 clutter 73
 color 73
 color bar 77
 color gain 76
 Comm tab 61
 Compass Page 40
 course up 66
 create
 routes 24
 waypoints 13
 creating waypoints
 graphically 13
 manually 14
 currents 46

D

DATA/CNFG key 2
 data cards
 installing 83
 removing 83
 transferring data to/from 55
 data card slots 1
 data entry keys 3
 using 9
 data fields 32
 data transfer 62
 datums 60

daylight saving 61
 Declaration of Conformity (DoC) 94
 deep water alarm 58
 default settings 8
 delete
 routes 26
 tracks 51
 waypoints 17
 delete by symbol 17
 depth 60
 depth line 77
 digital data fields 32
 digital selective calling. *See* DSC
 Dilution of Precision 88
 distance units 60
 distress calls 85
 DOP 88
 DSC 52, 85
 directory 53
 distress call 52, 86
 log 52
 position report 52, 86
 setup 54
 DSC Item Review 53
 DSC tab 52
 dual beam 72
 dual frequency 72

E

edit
 routes 26
 waypoints 15
 elevation units 60
 ENTER/MARK key 2, 13
 entering data 9

F

factory defaults 32, 59
 FCC compliance 94
 FIND key 2
 fish symbols 74, 80
 flasher 75
 follow track 20
 frequency 77
 200 kHz 72
 50 kHz 72
 function adjustments 33
 function windows 33

G

gain 76
 gain setting 73
 Go To Point 20
 GPS accuracy alarm 57
 GPS receiver
 initializing 5
 GPS status icon 5
 GPS tab 5, 43
 GSD 20 i, 58, 72
 GSD 21 58, 72
 GSD 22 i, 58, 72

H

hardness of the bottom 73
 hard structure 73
 heading 60
 highlight 8
 Highway Page 41
 options 41

I

installation i
 invert route 25

L

labels 67
 language 59
 leg distance 29
 leg time 29
 limited warranty 93
 log, temperature 81
 log and graph scale 81
 log duration 70
 LORAN TD 86–87
 setting up 87
 using 86

M

magnetic north 61
 Main Menu 43–71
 Card tab 54
 Celestial tab 47
 GPS tab 43
 Highway tab 71
 Messages tab 55
 Network tab 64
 overview 43
 Pages tab 64
 Points tab 49
 Routes tab 50
 Sonar tab 71
 System tab 58
 Temp tab 70
 Tide tab 44
 Tracks tab 50
 Trip tab 48
 main pages
 Compass Page 40
 configuring 31
 Highway Page 41
 Map Page 34–37

Map Split Page 39
 manage user card 55
 manual conventions i
 MapSource 54, 83
 map data 10
 map datums 60
 map outlines 66
 Map Page 34–37
 distance and bearing 37
 options 37
 ranges 35
 map pointer 10
 moving 10
 map ranges 35
 Map Split Page 39
 Map tab 65–69
 AIS sub tab 69
 detail sub tab 67
 nav sub tab 68
 prefs sub tab 66
 source sub tab 69
 Maritime Mobile Service Identity. *See* MMSI
 merge from card 55
 messages 90
 Messages tab 55
 MMSI number 85
 MOB 23
 moon phase 47
 moon rise/set 47

N

narrow beam 72
 NAV/MOB Key 2, 19, 22, 54
 navigating a saved route 24
 navigation terms 90
 Nav alarms 57
 Network tab 64

NMEA 62
 NMEA interface 62
 NMEA output setup 62
 north reference 60

O

off course alarm 57
 on-screen buttons 9
 options
 selecting 9
 orientation 66

P

Pages tab 64
 PAGE key 2
 pointer mode 35
 position format 60
 position mode 35
 position report 52, 85
 POWER key 2
 pressure 60
 product registration v, 93
 proximity alarms 19
 proximity waypoints 19
 clearing 19
 proximity waypoint list 18

Q

QUICK NAV route 25
 QUIT key 2

R

re-evaluate route 25
 receiver status 6
 replace from card 55
 review waypoint page 15
 ROCKER key 2

routes 23–29
 copying 25
 creating 23
 deleting 26
 editing 26
 navigating 24
 planning 29
 quick nav 25
 Routes tab 50

S

saved tracks 51
 scale, log and graph 81
 scroll bar 8
 serial number
 electronic 59
 Setup tab 58
 set position 6
 shallow water alarm 58
 shortcut keys 3
 simulator 58
 simulator mode 7
 setting up 7
 turning off 7
 turning on 7
 simulator set position 7
 simulator track 7
 simulator track control 7
 skyview orientation 6
 software license agreement v
 software version 59
 soft keys 3, 9
 soft structure 73
 Sonar
 understanding 72–81
 sonar alarms 58
 Sonar Page 74–77

- adjustment menu 76
- configuring 75
- Sonar tab 78–81
- sound waves 72
- source, GPS 6
- specifications 82
- speed filter 58
- speed units 60
- status bar 3, 5
- storage 87
- strongest sonar returns 73
- sun rise/set 47
- surface clutter 73
- symbol set 66
- system alarms 57
- system information 59
- system mode 58
- System tab 58
 - comm sub tab 61
 - general sub tab 58
 - time sub tab 61
 - units sub tab 59

T

- temperature 60, 70
- temperature graph 77
- temperature log 81
- temperature scale 70
- Temp tab 70
- tides 44
- Tide Stations 45
- Tide tab 44
- time duration 81
- time format 61
- time zone 61
- TracBack 20, 22
- Tips 22

- Tracks
 - deleting 51
 - reviewing 22
 - saving 21
- Tracks tab 50
- track color 51
- track logs 21, 50
- track up 66
- track value 51
- Trip tab 48
- turn unit on and off 4

U

- Ultrascroll 77
- underwater waypoints 78
- user waypoint list 17

W

- WAAS 6, 84
- Warning Page 5
- water immersion 87
- water speed 79, 89
- water temperature alarm 58
- waypoints 13–25
 - creating 13
 - deleting 18
 - editing 15
 - marking 13, 78
 - moving 16
 - proximity 18
 - reviewing 15
 - underwater 78
 - using 13
- waypoint list 17
- waypoint name
 - changing 16
- waypoint symbol

- changing 16
- weakest returns 73
- whiteline 74, 76
- Wide Area Augmentation System. *See* WAAS
- wide beam 72

Z

- zoom 35, 41, 77

**For the latest free software updates (excluding map data) throughout the life of your
Garmin products, visit the Garmin Web site at www.garmin.com.**



© Copyright 2006 Garmin Ltd. or its subsidiaries

Garmin International, Inc.
1200 East 151st Street, Olathe, Kansas 66062, U.S.A.

Garmin (Europe) Ltd.
Unit 5, The Quadrangle, Abbey Park Industrial Estate, Romsey, SO51 9DL, U.K.

Garmin Corporation
No. 68, Jangshu 2nd Road, Shijr, Taipei County, Taiwan

www.garmin.com

190-00677-00 Rev. B

Free Manuals Download Website

<http://myh66.com>

<http://usermanuals.us>

<http://www.somanuals.com>

<http://www.4manuals.cc>

<http://www.manual-lib.com>

<http://www.404manual.com>

<http://www.luxmanual.com>

<http://aubethermostatmanual.com>

Golf course search by state

<http://golfingnear.com>

Email search by domain

<http://emailbydomain.com>

Auto manuals search

<http://auto.somanuals.com>

TV manuals search

<http://tv.somanuals.com>