

Magnum 700X Mini-Concentrator

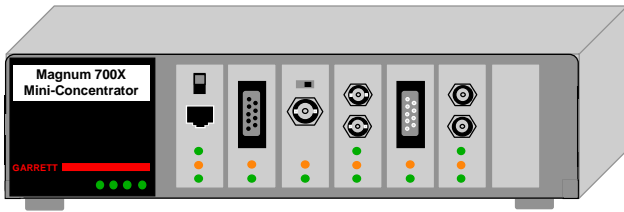

Installation and User Guide

GARRETT

Magnum™ 700X

Mini-Concentrator

Installation and User Guide

Part #: 84-00017 (R5/98)

Trademarks

UL is a registered trademark of Underwriters Laboratories

Ethernet is a trademark of Xerox Corporation

Velcro is a trademark of Velcro USA

UL is a registered trademark of Underwriters Laboratories

Magnum is a trademark of Garrett Communications, Inc.

Important: Magnum 700X Mini-Concentrators contain no user serviceable parts. Attempted service by unauthorized personnel shall render any and all warranties null and void. If problems are experienced with a Magnum 700X, consult Section 5, Troubleshooting, of this User Guide.

©1998 Garrett Communications, Inc. All rights reserved. No part of this publication may be reproduced without prior written permission from Garrett Communications, Inc.

Printed in the United States of America.

Contacting Garrett Communications

Please use the mailing address and phone and fax numbers listed below:

Garrett Communications

47823 Westinghouse Drive

Fremont, CA 94539

Phone (510) 438-9071

Fax (510) 438-9072

WWW: <http://www.garrettcom.com>

E-mail: support@garrettcom.com

Federal Communications Commission

Radio Frequency Interference Statement

This equipment generates, uses and can radiate frequency energy and if not installed and used properly, that is in strict accordance with the manufacturer's instructions, may cause interference to radio communication. It has been tested and found to comply with the limits for a Class A computing device in accordance with the specifications in Subpart J of Part 15 of FCC rules, which are designed to provide reasonable protection against such interference when operated in a commercial environment. Operation of this equipment in a residential area is likely to cause interference, in which case the user at his own expense will be required to take whatever measures may be required to correct the interference.

Table of Contents

1.0 SPECIFICATIONS	1
1.1 Technical Specifications	1
1.2,3 Specifications - Port Modules (RPMs and BPMs)	3
1.4 Ordering Information	4
2.0 INTRODUCTION	5
2.1 Inspecting the Package and Product	5
2.2 Product Description	5
2.2.1 Magnum 700X and 700X-Br ** Chassis	6
2.3 Magnum 700X - Repeater Port Modules (RPMs)	7
2.3.1 RPM-BNC	7
2.3.2 RPM-AUI	8
2.3.3 RPM-DTE	10
2.3.4 RPM-FST (Fiber ST, Twist-lock Connector)	10
2.3.5 RPM-FSC (Fiber SC, Snap-in Connector)	11
2.3.6 RPM-SMF (Single Mode Fiber)	11
2.3.7 RPM-TP (Twisted Pair)	13
2.3.8 PM-FP	13
2.4 Magnum 700X and 700X-Br ** - Bridge Port Modules (BPMs)	14
2.4.1 BPM-BNC	14
2.4.2 BPM-AUI	15
2.4.3 BPM-FST	15
2.4.4 BPM-TP	16
2.5 Features and Benefits	17
2.6 Applications	18
3.0 INSTALLATION	19
3.1 Locating Magnum 700X Mini-Concentrators	19
3.2 Connecting Ethernet Media	19
3.2.1 Connecting ThinNet 10BASE2 (BNC)	20
3.2.2,3 Connecting ThickNet 10BASE5 (AUI and DTE)	20
3.2.4,5,6 Connecting Fiber Optic (3 types)	20,21
3.2.7 Connecting Twisted Pair (RJ-45, Unshielded or Shielded)	22
3.3 Removing the PM Face Plate	22
3.4 Installing PM Cards	24
3.5 Removing PM Cards	25
4.0 OPERATION	26
4.1 Repeater Functionality	26
4.2 BPM Local Bridge Functionality **	26
4.3 Powering the Magnum 700X Mini-Concentrator	29
4.4,5 Chassis LEDs, PM LEDs	30
5.0 TROUBLESHOOTING	31
5.1 Before Calling for Assistance	31
5.2 When Calling for Assistance	32
5.3 Return Material Authorization (RMA) Procedure	32
5.4 Shipping and Packaging Information	33
APPENDIX A: WARRANTY INFORMATION	34

** CHANGES MADE IN THIS REVISION

MAGNUM™**ETHERNET CONNECTIVITY PRODUCTS**

"DESIGNED AND MANUFACTURED IN THE USA"

Overview

Garrett Communications offers the Magnum line of Ethernet LAN physical layer connectivity products with industry-standard functionality. Magnum products are available worldwide through OEMs, integrators, representatives, retailers and international distributors.

Dual Speed 8-port & 16-port Stackable, 10/100 auto-sensing per port Stackable Hubs, SNMP Optional

10Mb series and 100Mb series, both with optional port modules
Switching Hubs, unmanaged 500-Series and managed 5000-Series

Two-Port Switches

100Mb RJ-45port + 10 / 100Mb combo port, or +FDX fiber port

Workgroup Hubs

10Mb series and 100Mb series, both with optional port modules

Personal Hubs®, 100Mb

100Mb 4-port with up-link, 6-port with one switched 10/100Mb

Personal Hubs, 10Mb series

8-port + AUI, stackable to 5 high, + optional BNC or fiber port
 8 or 9-port and 4 or 5-Port Personal Hubs, w/ man. up-link sw.

Media Converters, 10Mb and 100Mb series

All media combinations, incl. fiber ST, SC, mm., single mode

The "X-line" of configurable MiXed Media products:

Stackable Concentrators, SNMP optional, 13-Ports

Mini-Concentrators, 7 Ports, Repeaters, 2-Ports

Repeater Port Modules (RPMs), 6 types for Ethernet media

Bridge Port Modules (BPMs), 4 types, for segment isolation

Workgroup Bridges, 10Mb series

Local segmentation for all media types

Fan-Outs, 10Mb series

2, 4 and 8 Port Models

Transceivers, 10Mb and 100Mb series

10Mb Mini-Transceivers and Coax Models, All Types

100Mb MII-TX and MII-FX models

May, '98

1.0 SPECIFICATIONS

This chapter gives the specifications of the Magnum 700X mixed-media concentrator, as well as those of the various Port Modules (PMs).

1.1 Technical Specifications

Performance

Data Rate: 10 Mbps

RPM Partitioning: Enforced after 32 consecutive collisions.

RPM Reconnect: Occurs after 512 bits error-free transmission.

BPM Auto-learning Address List: 256 node capacity.

BPM Filtering and Forwarding Rate: 14,880 pps max.

Maximum Ethernet Segment Lengths

DTE (AUI Drop Cable)	- 50 m (164 ft)
10BASE-T (twisted pair)	- 100 m (328 ft)
Shielded twisted pair	- 150m (492 ft)
10BASE2 ThinNet (BNC)	- 185 m (607 ft)
10BASE5 ThickNet	- 500 m (1,640 ft)
FOIRL multi-mode Fiber optic	- 1 km (3,281 ft)
10BASE-FL multi-mode Fiber optic	- 2 km (6,562 ft)
Single-mode Fiber optic	- 10 km (32,810 ft)

Network Standards

Ethernet V1.0/2.0 IEEE 802.3: 10BASE-T, 10BASE5, 10BASE2, 10BASE-FL & FOIRL, and DTE

(The Magnum 700X Mini-Concentrator is a physical layer standard Ethernet product, and operates independently of all software.)

Operating Environment

Ambient Temperature: 32°F to 122°F (0°C to 50°C)

Storage Temperature: -20°C to 60°C

Ambient Relative Humidity: 10% to 95% (non-condensing)

Power Supply (Internal)

AC Power Connector: IEC-type, male recessed, rear of chassis

Input Voltage: 90 to 260 vac (auto-ranging)

Input Frequency: 47 to 63 Hz (auto-ranging)

Power Consumption: 40 watts max

(1.1 Technical Specifications, continued)**Connectors**

Seven Magnum PM ports on the front. BPMs are available with BNC, AUI, FST, and STP connectors. The following are available as RPM configurations.

RJ-45:	Shielded, 8-Pin Female (Note: <i>Shielded 10BASE-T connectors accept either unshielded or shielded wiring plugs for standard twisted pair media wiring.</i>)
Fiber Optic:	ST (Twist-Lock Connector, for single or multi-mode)
Fiber Optic:	SMA (screw-on Connector, for multi-mode, by special order only)
ThinNet:	BNC
AUI:	D-Sub 15-Pin Female (with slide lock)
DTE:	D-Sub 15-Pin Male (with lock posts)

Note: Port Modules are also used with the Magnum 3000X, and as the Bonus Port modules for Magnum Stackable and Workgroup Hubs. All Port Modules should be installed at the factory or by trained technicians.

Packaging

Enclosure: High strength sheet metal.
 Suitable for wiring closet shelf, wall or desktop mounting.
 Port Module Slots: 7
 Dimensions: 6.0 in x 10.0 in. x 3.5 in. (15.25 cm x 25.4 cm x 8.89 cm)
 Weight: 2.5 lb. (1.1 Kg)
 Port Slot Cut-out: 2.2 in. x .75 in. (5.6 cm x 1.9 cm)
 Cooling method: Convection

LED Indicators on Chassis

Four chassis LEDs monitor the general status of the unit including network traffic.

PWR - Power, Green LED, steady ON indicates there is AC power.

RX - Receive, Green LED, blinks to indicate network activity, data being received from any of the PMs.

JAB - Jabber, Amber LED, illuminates when jabber condition (illegal packet size) is detected on any port; affected port is partitioned temporarily until jabber stops.

COL - Collision, Yellow LED, flashes when a collision is detected on any of the PMs.

For the LEDs on each PM, see "Product Description" of the PMs.

Agency Approvals

UL Listed (UL 1950), cUL, CE

Emissions: meets FCC Part 15, Class A

Warranty

Three years, return to factory

Made in USA

1.2 Specifications - Repeater Port Modules (RPMs)

RPM Type :	BNC	AUI	DTE	Fiber-mm	Fiber-sgl.m	TP*
Front Access	yes	yes	yes	yes	yes	yes
Connector Type	BNC-f	DB-15 f	DB-15 m	ST or SC	Fiber-ST	RJ-45
Partition (PART)LED	yes	yes	yes	yes	yes	yes
Receive (RX) LED	yes	yes	yes	yes	yes	yes
LINK LED	n.a.	n.a.	n.a.	yes	yes	yes
Switch on Face Plate	yes**	n.a.	n.a.	n.a.	n.a.	yes***

“Fiber-mm” is multi-mode cable, normally used for 10BASE-FL installations, up to 2.0Km.

“Fiber-sgl.m” is single-mode cable, used for distant installations, up to 10.0Km.

* The RJ-45 connector is shielded; it accepts RJ-45 eight-pin plugs for unshielded and shielded twisted pair wiring.

** Internal termination switch for BNC, no "T" connector is required.

*** MDI-X (Media Dependent Interface - Crossover) switch for RJ-45 up-link, no crossover cable is required.

1.3 Specifications - Bridge Port Modules (BPMs)

BPM Type :	BNC	AUI	Fiber	TP*
Connector Type	BNC(f)	DB-15(f)	ST	RJ-45
Switch on FP	yes**	n.a.	n.a.	yes***
FWD-I LED	yes	yes	yes	yes
FWD-X LED	yes	yes	yes	yes
LINK LED	n.a.	n.a.	yes	yes

* The RJ-45 connector is shielded; it accepts RJ-45 eight-pin plugs for unshielded and shielded twisted pair wiring.

** Internal termination switch for BNC, no "T" connector is required.

*** MDI-X (Media Dependent Interface - Crossover) switch for RJ-45 up-link, no crossover cable is required.

NOTE: As of May, 1998, multiple BPMs (up to six) may be installed in a 700X chassis to provide parallel bridging for the BPM's attached segments. This will increase network performance in applications where there is significant local traffic on the bridged segments. (see Section 4.2) Any mix of RPM and BPM types may be configured together in a 700X, with a maximum of 6 BPMs and 7 total PMs per unit..

1.4 Ordering Information

Magnum 700X Mini-Concentrator

Magnum 700X	Base chassis with 7 slots for RPMs and BPMs, power supply
Magnum 700X-Br	Multi-Bridge chassis with one RJ-45 RPM for the common port, and 6 slots for BPMs and other RPMs, power supply. Includes 5 face plates.
Magnum RPM-BNC	Repeater Module with 1 BNC connector, internal termination switch
Magnum RPM-TP	Repeater Module w/ 1 shielded female RJ-45 connector + up-link switch
Magnum RPM-AUI	Repeater Module with 1 AUI (DB-15 female) connector, with slide lock
Magnum RPM-DTE	Repeater Module with 1 DTE (DB-15 male) connector, with lock posts
Magnum RPM-FST	Repeater Module w/ mm* Fiber ST "twist" 10BASE-FL dual connector
Magnum RPM-SMF	Repeater Module w/ single mode Fiber connector
Magnum RPM-FSM**	Repeater Module w/ mm* Fiber SMA "screw-on" 10BASE-FL connector
Magnum BPM-BNC	Local Bridge Module with 1 BNC connector
Magnum BPM-AUI	Local Bridge Module with 1 AUI connector
Magnum BPM-FST	Local Bridge Module with mm* Fiber ST connector
Magnum BPM-TP	Local Bridge Module with 1 RJ-45 connector + up-link switch
Magnum PM-FP	Face Plate - cover for unused slots

NOTE: All RPMs and BPMs have LEDs for status information. Refer to Product Description for details.

* mm = multi-mode

** This item is available by special order only.

Note: All PMs are interchangeable for use with the Magnum 3000X Stackable Concentrators and Magnum 3000 Stackable Hubs bonus ports, and the Magnum 1000 Workgroup Hubs bonus ports. The same PMs are also used in the Magnum 30X Workgroup Bridges and the Magnum 200X and 20X Two-port Repeaters.

Garrett Communications reserves the right to change specifications, performance characteristics and/or model offerings without notice.

2.0 INTRODUCTION

This chapter describes the functionality of the Magnum 700X and its Port Modules.

2.1 Inspecting the Package and Product

Examine the shipping container for obvious damage prior to installing this product; notify the carrier of any damage which you believe occurred during shipment or delivery. Inspect the contents of this package for any signs of damage and ensure that the items listed below are included.

This package should contain:

- 1 Magnum 700X Mini-Concentrator Unit
- 1 AC Power Cord (U.S. and other 115 vac only)
- 1 Installation and User Guide
- 1 Product Registration Card

Note: PMs that are purchased with the 700X unit are usually factory configured and installed, and may be included as part of the 700X unit.

Remove the Magnum 700X Mini-Concentrator from the shipping container. Be sure to keep the shipping container should you need to ship the unit at a later date. To validate the product warranty please complete and return the enclosed Product Registration Card to Garrett Communications as soon as possible.

In the event there are items missing or damaged contact your supplier. If you need to return the unit use the original shipping container. Refer to Chapter 5, Troubleshooting, for specific return procedures.

2.2 Product Description

The 700X Mini-Concentrator is a highly versatile, cost-effective mixed-media Ethernet concentrator that provides seven (7) slots for Ethernet media connectivity. Any combination of standard Ethernet media segments are supported. It operates as the central concentrator for multiple backbone or user segments in mixed-media environments of small and medium-sized networks.

Each Magnum 700X unit is a complete operational unit with an internal power supply enclosed in a lightweight, compact, rugged metal enclosure. The media connectors and the status LEDs are conveniently accessed from the front. The unit is easily installed and is suitable for wiring closet shelf, table-top or vertical mounting.

Magnum 700X units operate as multi-port repeaters and provide full repeater functionality per IEEE 802.3 specifications in compliance with Ethernet V1.0/2.0 standards. They may also be optionally configured with one or more Bridge Port Modules (BPMs) in order to isolate the 700X and its attached nodes from the up-stream connected segments for increased network performance.

2.2.1 Magnum 700X Chassis

The Magnum 700X functions as a seven (7) slot master chassis. Each slot supports a single Port Module (RPM or BPM) to provide 10BASE-FL, FOIRL, 10BASE2, 10BASE5, or 10BASE-T LAN connectivity. The RPMs are used for one Ethernet segment each and provide full IEEE 802.3 repeater functionality. The individual BPMs are self-learning and filter and forward packets at full Ethernet wire speed. A BPM can be used to provide local bridge isolation between the 700X and the connected segment. Each PMs is equipped with one media interface connector. Any PM can be installed in any slot of the Magnum 700X chassis.

To simplify media connections, each media interface connector is accessible from the front of the unit, along with the LEDs. No rear access is required except for the AC power plug.

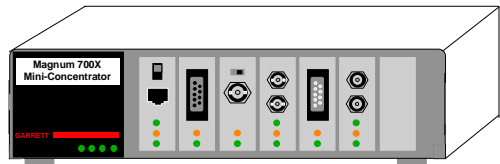

Figure 2.2.1: Magnum 700X Mini-Concentrator

When configured with multiple RPMs for single- or mixed-media applications, the total combination of all RPMs will operate as a single repeater. As an example, when the Magnum 700X is fully configured with seven RPMs connecting seven Ethernet segments, the entire unit operates as a single repeater. In addition to the typical standard Ethernet interfaces, RPMs with a DTE connector and RPMs with single-mode fiber connector are also available.

When configured with BPMs, all RPMs and their locally attached nodes will operate as a single repeater which is isolated from the up-stream segments connected via the local bridge. The BPMs are self-learning and filter / forward packets for their attached segment.

The internal power supply is auto-ranging to handle any AC power type worldwide. Power input may range from 90 to 260 vac, with a frequency rating of 47 to 63 Hz. The unit is equipped with a rear mounted IEC-type recessed male AC power connector. (When shipped for use in areas other than 115 vac, a power cord will not be included). The 700X unit is convection cooled for silent operation.

2.3 Magnum 700X - Repeater Port Modules (RPMs)

There are a total of six different RPM cards and each is designed with its own media cable connector type. A seventh module is used as a face plate when front slot is not used.

The assortment of standard network connector types for RPMs includes BNC (ThinNet or 10BASE2), AUI (10BASE5 or ThickNet, DB-15 female for most transceiver connections), DTE (DB-15 male-AUI for direct connects), ST (Ethernet multi-mode Fiber ST), SC (Ethernet multi-mode Fiber SC), SMF (Ethernet single-mode Fiber) and RJ-45 (10BASE-T UTP and STP). They are shown in Figure 2.3. Each RPM is usually factory installed, or may be field installed by trained technicians as described in Section 3.0, Installation.

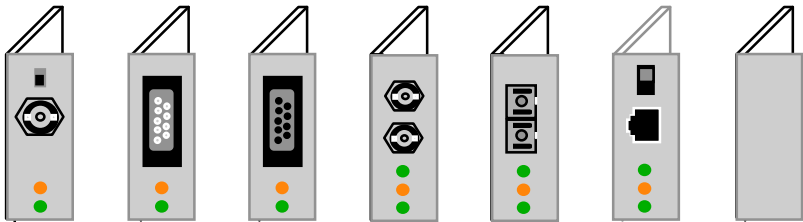

Figure 2.3: Magnum RPM Cards: RPM-BNC, RPM-AUI, RPM-DTE, RPM-FST, RPM-FSC, RPM-TP, & PM-FP

Each of the individual RPMs are described in detail in this section.

2.3.1 RPM-BNC

The Magnum RPM-BNC repeater module is equipped with a standard 10BASE2 coax connector. This RPM performs full IEEE 802.3 repeater functionality and is used for 10BASE2 ThinNet (commonly referred to as BNC) connections.

The RPM-BNC module is designed with a special switch-selectable internal termination function that eliminates the need for a "tee" connector and a 50 ohm terminator. To

take advantage of internal termination, the slide switch should be in the "DOWN" (or right-side) position. In this configuration, the 10BASE2 segment is directly attached to the BNC port where it is internally terminated. When the switch is in the "UP" (or left-side) position, the BNC port requires a "tee" connector (not supplied) and a 50 ohm terminator for proper termination. Certain applications may require a "tee" connector, used as a tap, to allow the 10BASE2 coax segment to continue on past the RPM-BNC connection.

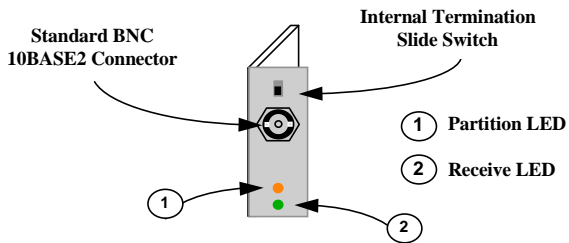

Magnum RPM-BNC

The RPM-BNC module includes one partition (PART) and one receive (RX) LED, which are visible from the front. The PART LED flashes AMBER to indicate that the segment has been automatically partitioned. As soon as normal transmission resumes, the segment will be automatically re-established. The RX LED illuminates GREEN intermittently to indicate data is being received.

Important Note: for the RPM-BNC Termination Switch -
DOWN (or right): Internally Terminated
UP (or left): Requires "T" Connector.

(To recall the right BNC switch position, remember "tee up" . . . as in golf !)

2.3.2 RPM-AUI

This module is equipped with a 15 pin female AUI connector and a slide-lock, and performs full IEEE 802.3 repeater functionality. It is used to provide connectivity with a 10BASE5 (ThickNet) backbone or to any AUI segments. A transceiver is required when connecting to a ThickNet segment and the RPM-AUI supports this convention. The RPM-AUI is also a "universal" Ethernet media interface as it may be used with a variety of different mini-transceivers

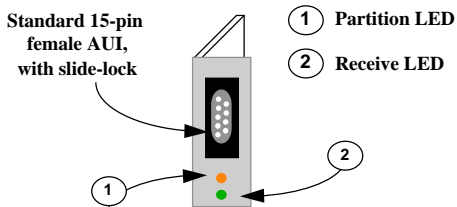

Magnum RPM-AUI

to provide connectivity to any media type.

The RPM-AUI card is equipped with Partition (PART) and Receive (RX) LEDs which function the same as the identical LEDs on the RPM-BNC (Section 2.3.1 above).

The Magnum RPM-AUI card is also used for connecting Ethernet devices using standard AUI cabling. In this situation, it is important to consider the AUI segment length or distance to the attached device.

The maximum transmission distance between a backbone transceiver equipped with an AUI connector and the Magnum RPM-AUI card will vary. When an AUI cable is used to connect the Magnum RPM-AUI directly to a backbone transceiver, the maximum AUI segment length is allowed. If the Magnum RPM-AUI is connected to a transceiver that has been cascaded from another transceiver, the maximum AUI segment length is reduced.

According to Ethernet standards, the maximum distance from the transceiver AUI connector and the attached device (Magnum RPM-AUI) is 50m (165 ft.). The AUI segment maximum length is reduced in cascaded configurations. See the following note.

Important Note: The maximum transmission distance is decreased by 6m (20 ft.) for every additional level of network transceiver device "dropped" or "cascaded" from the original backbone transceiver tap.

The RPM-AUI connector supports standard IEEE signals, summarized in Table 2.3.2.

Table 2.3.2: AUI Pin Assignments

Pin	Function	Pin	Function
1	Control In Circuit Shield	10	Data Out Circuit B
2	Control In Circuit A	11	Data Out Circuit Shield
3	Data Out Circuit A	12	Data In Circuit B
4	Data In Circuit Shield	13	Voltage Plus (+)
5	Data In Circuit A	14	Voltage Shield
6	Voltage Common	15	Control Out Circuit B
7	Control Out Circuit A	SHELL	Protective Ground
8	Control Out Circuit Shield (conductive shell)		
9	Control In Circuit B		

- NOTES:**
- 1) Voltage Plus (pin #13) and Voltage Common (pin # 6) use a single twisted pair in the AUI cable.
 - 2) Pins 4, 8, 11 and 14 may be connected to pin #1.

2.3.3 RPM-DTE

The Magnum RPM-DTE is a module equipped with a 15-pin male DTE connector with lock posts. (The RPM-DTE is a mating connector for the RPM-AUI which has a 15-pin female connector and slide locks. The pin assignments of the two are the same). The RPM-DTE card is designed to support direct connections (no transceiver required) using AUI drop cables to any device that is equipped with an AUI port. Examples of such devices include servers, routers, bridges, hubs, and UNIX workstations.

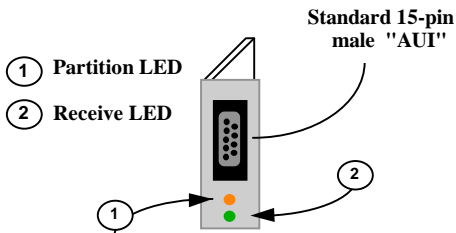

Magnum RPM-DTE

2.3.4 RPM-FST (Fiber ST, Twist-lock Connector)

The Magnum RPM-FST is a multi-mode fiber optic module equipped with a dual ST-type connector. It functions as an IEEE 802.3 full repeater to support 10BASE-FL and FOIRL network segments. When used for 10BASE-FL segments, this module supports fiber optic transmission distances up to 2000m. For FOIRL applications, it supports fiber segments of up to 1000m in length. The RPM-FST includes full transceiver functionality and does not require an external transceiver device. In addition to Partition (PART) and Receive (RX) LEDs, a LINK LED indicates proper connectivity with the remote device.

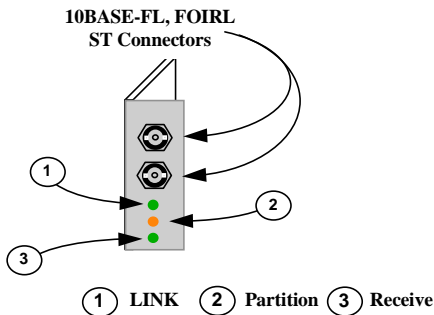

Magnum RPM-FST

NOTE: The RPM-FST circuit board contains a six pin jumper which controls the intensity of the transmitted signal. By default, the jumper is placed across pins 5 & 6. The jumper may be set as follows, to accommodate distances of up to 4 km:

(continued on next page)

JUMPER ACROSS DISTANCES SUPPORTED

1 - 2	0 - 2 km
3 - 4	0.5 - 3 km*
5 - 6	1.5 - 4 km*

When fiber cable distances of 2 km or less are needed, the jumper should be placed across pins 1 and 2.

* When fiber cable distances of more than 2 km are selected, the minimum cable length must also be increased, as shown in the table above.

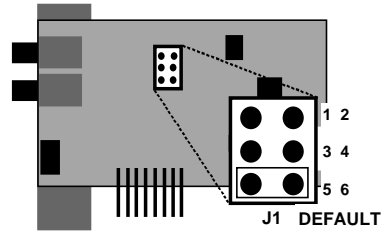

2.3.5 RPM-FSC (Fiber SC, Snap-in Connector)

The Magnum RPM-FSC is also a multi-mode fiber optic repeater module, similar to the RPM-FST. It has the same LEDs indicating port partitioned (PART), receive activity (RX), and link operational (LINK). It has the same jumper settings for extra distance in certain circumstances.

While the functionality of these two modules is the same, the RPM-FSC is equipped with an SC-type "snap-in" connector instead of an ST-type "twist-lock" connector.

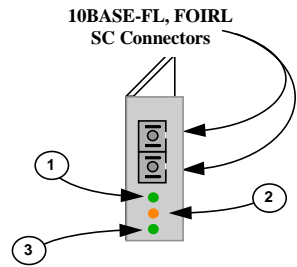

Magnum RPM-FSC

2.3.6 RPM-SMF (Single-mode Fiber)

The Magnum RPM-SMF is a single-mode fiber optic module equipped with a dual ST-type connector. It functions as a full repeater to support single-mode fiber networks. The RPM-SMF supports fiber optic transmission distances of up to 10 Km. The RPM-SMF includes full transceiver functionality and does not require an external transceiver device.

This module is equipped with PART, RX, and LINK LEDs identical to those of the RPM-FST.

(continued on next page)

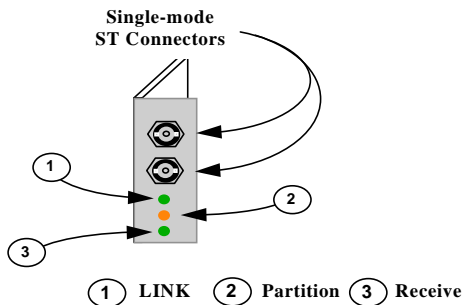

Magnum RPM-SMF

2.3.6 RPM-SMF (Single-mode Fiber) - continued

Note: Be sure to use single-mode fiber optic cable with this module.

Single-mode fiber has a smaller diameter than multi-mode fiber (2/15 - 8/60 microns for single-mode, 50/125 or 62.5/125 microns for multi-mode, where xx/xx are the diameters of the core and the core plus the cladding respectively).

NOTE: The RPM-SMF circuit board contains a six pin jumpers, but the jumper is only to be placed across pins 5 & 6. (Chg. 11/98) Others are not used.

JUMPER ACROSS DISTANCES SUPPORTED

1 - 2	not used
3 - 4	not used
5 - 6	0 - 10 km

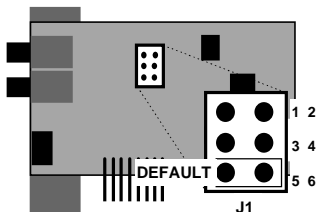

2.3.7 RPM-TP (Twisted Pair)

The Magnum RPM-TP card supports Ethernet twisted pair segments of any standard length. It is equipped with a single RJ-45 connector. The RJ-45 connector is shielded to minimize emissions and will allow both unshielded twisted pair (UTP) and shielded twisted pair (STP) segment connections.

The RPM-TP module is also equipped with a slide switch to allow for cascaded or up-link connections. This feature eliminates the need for a special twisted pair crossover cable.

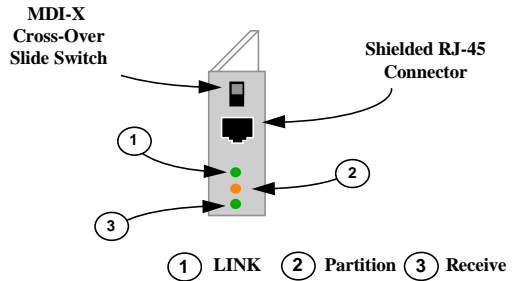

Magnum RPM-TP

With the switch in the UP position, the RPM-TP port is used for up-link connections (i.e.: a connection to another repeater or hub typically.) When used for segments going to workstations and other user device connections, the switch should be in the DOWN position.

The RPM-TP will support 10BASE-T unshielded twisted pair wiring (UTP) environments with maximum segment distances up to 100m (325 ft.), or shielded twisted pair wiring (STP) of 150m (500 ft.). This module is designed with internal transceiver functionality. The RPM-FST has LINK, PART, and RX LEDs.

Important Note: For the RPM-TP MDI-X Crossover Switch - DOWN(or Right) for workstations and user connections. UP (or Left) for Up-Link connections to other hubs, etc.

The RJ-45 pins normally (TP crossover switch DOWN) are per the standard for hubs-to-users twisted pair wiring: 1 = receive+, 2 = receive-, 3 = transmit+, 6 = transmit-, other pins not used. When the TP crossover switch is UP, the pins of the RJ-45 port are per the standard for up-links using twisted pair wiring, i.e., the transmit and the receive pairs are exchanged: 1 = transmit+, 2 = transmit-, 3 = receive+, 6 = receive-, other pins not used.

2.3.8 PM-FP

The PM-FP is a blank face plate that is installed in any empty PM slot. When the Magnum 700X chassis contains less than seven front-mounted PMs, the empty front slots must be covered with the PM-FP face plate in order to maintain proper cooling air flow, and for safety.



Note: The Magnum PM-FP must be installed in each empty PM slot.

Magnum PM-FP

2.4 Bridge Port Modules (BPMs)

To provide optional local segment isolation, individual Bridge Port Modules (BPMs) are available for Magnum 700Xs. For flexibility, any port of a Magnum 700X may be configured with a BPM. Multiple (up to 6) BPMs may be configured in one 700X chassis..

There are four different BPM cards and each is designed with its own media connector type. BPMs are available for the following Ethernet media types: BNC (ThinNet or 10BASE2), AUI (10BASE5 or ThickNet, DB-15 female for most transceiver connections), ST (Ethernet multi-mode Fiber ST), and RJ-45 (10BASE-T UTP and STP). They are shown in Figure 2.4. Each BPM is usually factory installed, but may be field installed by trained technicians as described in Section 3.0, Installation.

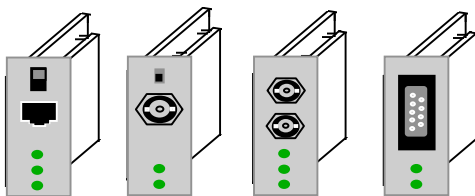

Figure 2.4: Magnum BPM Cards: BPM-TP, BPM-BNC, BPM-ST, BPM-AUI

Each of the individual BPMs are described in detail in this section.

2.4.1 BPM-BNC

The Magnum BPM-BNC bridge module is equipped with a standard 10BASE2 coax connector. This BPM is self-learning and filters and forwards packets at full Ethernet wire speed. This module is used for 10BASE2 ThinNet (commonly referred to as BNC) connections and is designed to isolate the local segment (i.e., the users and devices connected to the Magnum unit housing the BPM) from the connecting network (i.e., the users and devices connected through the BPM’s media connector).

The BPM-BNC module is designed with a special switch -selectable internal termination function that eliminates the need for a "tee" connector and a 50 ohm terminator. For switch details, refer to

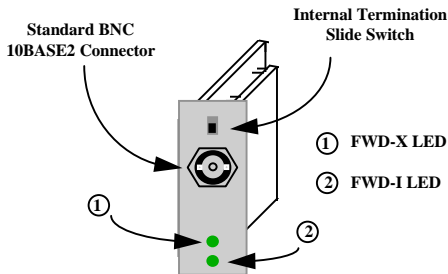

Magnum BPM-BNC

the RPM-BNC section, 2.3.1. The BPM-BNC module includes an FWD-I LED and an FWD-X LED, which are visible from the front. The FWD-I LED blinks GREEN to indicate that packets are being forwarded INTO the local Magnum hub or stack.. The FWD-X LED blinks GREEN to indicate that packets are being forwarded OUT of the local Magnum hub or stack.

2.4.2 BPM-AUI

This local-bridge module is equipped with a 15 pin female AUI connector and a slide-lock. It is self-learning and filters and forwards packets at full Ethernet wire speed. It is used to provide segment isolation from a 10BASE5 (ThickNet) backbone or any AUI segments. A transceiver is required when connecting to a ThickNet segment and the BPM-AUI supports this convention.

The BPM-AUI card is equipped with one FWD-I LED and one FWD-X LED, which are identical to those of the BPM-BNC

(see Section 2.4.1).

The RPM-AUI connector supports standard IEEE signals, which are summarized in Table 2.3.2 of Section 2.3.2.

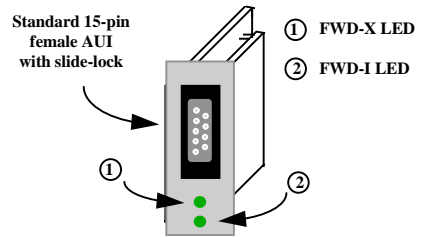

Magnum BPM-AUI

2.4.3 BPM-FST

The Magnum BPM-FST is a multi-mode fiber optic local-bridge module equipped with a dual ST-type connector. It is self-learning and filters and forwards packets at full Ethernet wire speed. When used for 10BASE-FL segments, this module supports fiber optic transmission distances up to 2000m. For FOIRL,

it supports fiber segments of up to 1000m in length. The BPM-FST includes full transceiver functionality and does not require an external transceiver device. The BPM-FST has three status LEDs. FWD-I and FWD-X are identical to those of the BPM-BNC (Section 2.4.1). In addition, this module has a GREEN LINK LED, that is always on when the link is operational.

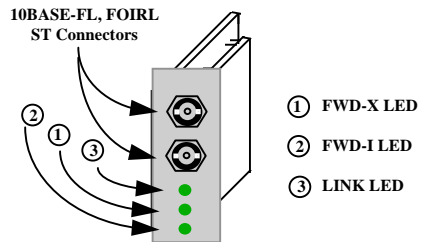

Magnum BPM-FST

2.4.4 BPM-TP

The Magnum BPM-TP card is equipped with a single RJ-45 connector and supports Ethernet twisted pair segments of any standard length. The RJ-45 connector is shielded to minimize emissions and will allow both unshielded twisted pair (UTP) and shielded twisted pair (STP) segment connections.

The BPM-TP module is also equipped with a Media Dependent Interface-Crossover (MDI-X) slide switch to allow for cascaded connections. This feature eliminates the need for a special twisted pair crossover cable. For MDI-X switch details, refer to the RPM-TP section, 2.3.7.

The BPM-TP will support 10BASE-T unshielded twisted pair wiring (UTP) environments with maximum segment distances up to 100m (325 ft.), or shielded twisted pair wiring (STP) of 150m (500 ft.). This module is designed with internal transceiver functionality. The LINK, FWD-I, and FWD-X LEDs of this BPM are the same as those of the BPM-FST (Section 2.4.3).

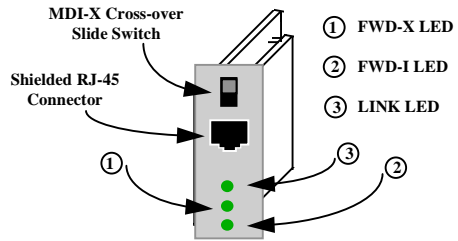

Magnum BPM-TP

2.5 Features and Benefits

■ Seven Ethernet Segments in a Single Unit

The Magnum 700X allows any mix of standard Ethernet media to reside in one unit, up to seven different segments, to expand and reconfigure any Ethernet network installation.

■ RPMs (Repeater Port Modules) for All Standard Ethernet Media

Multiple RPMs support all of the various IEEE 802.3 standards including, 10BASE-FL, FOIRL, 10BASE2, 10BASE5 and 10BASE-T.

■ Optional Bridge Port Modules (BPMs)

The Magnum 700X can be optionally configured with one or more BPMs. Each BPM contains a miniature, self-learning local bridge module capable of filtering and forwarding packets at full Ethernet speed. A BPM may be used to bridge-isolate local nodes having significant local inter-node traffic, thus boosting overall network performance. These modules are available with BNC, AUI, multi-mode Fiber-ST, and RJ-45 media connectors.

■ Multiple Mixed-Media Segments Form One Repeater

When configured with two or more RPMs supporting a single- or mixed-media application, the Magnum 700X functions as one multi-port repeater.

■ Front Mounted Connectors and LEDs

The installation of Magnum 700X units only requires front access for network connections. Similarly, the status LEDs are all readily visible from the front for ease of monitoring network operational status over time. This is especially convenient when the Magnum 700X is mounted on a shelf or in a wiring closet.

■ Internal "Universal" Power Supply with Auto-ranging

An internal auto-ranging power supply with a female IEC power cord connector allows the Magnum 700X to be used throughout the world. No external power supply unit is required.

■ LEDs for Chassis, and for each PM Cards

The Magnum 700X chassis and each individual PM card are equipped with front-mounted traffic activity and segment status LEDs. The Magnum 700X chassis features a Power (PWR), Receive (RX), Collision (COL), and Jabber (JAB) LEDs.

2.6 Applications

The Magnum 700X provides connectivity between multiple and various Ethernet media types from a single chassis device, and includes support for the following IEEE 802.3 10 Mbps standards: 10BASE5, 10BASE2, 10BASE-T, 10BASE-FL, FOIRL. Where more than one type of Ethernet media is required, the Magnum 700X easily integrates a mixed media network. Also, the Magnum 700X can be optionally configured with BPMs to offer local-bridge isolation for any segments.

Figure 2.6 illustrates a Magnum 700X being used to support an existing ThinNet (10BASE2) network of just a few users, the addition of a new 10BASE-T segment to handle up to eight more user stations, the future expansion of the network using fiber (10BASE-FL), and an AUI/DTE drop cable segment to an attached server.

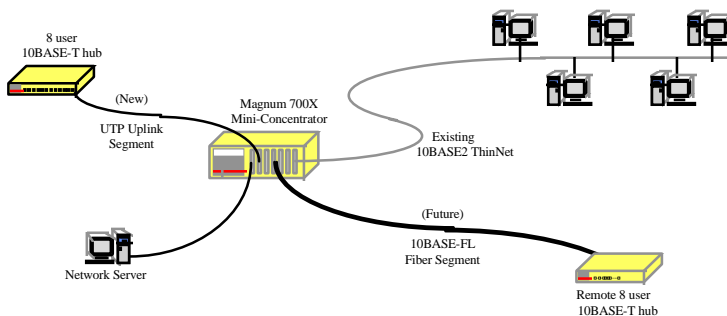

Figure 2.6: Magnum 700X brings together mixed Ethernet media

Magnum 700X Mini-Concentrators will function properly when the network installation follows IEEE standards for the various Ethernet media. Each media type has different installation limitations based on IEEE 802.3 standards, and those specifications should be adhered to for all applications. A summary of each Ethernet media type and the corresponding Magnum PM is presented here:

<u>IEEE Standard</u>	<u>Reference</u>	<u>Max. Distance</u>	<u>Taps</u>	<u>PM Type</u>
Drop Cable	AUI	50m (165 ft)	n/a	RPM-AUI, RPM-DTE, BPM-AUI
10BASE5	ThickNet	500m (1640 ft)	100	RPM-AUI, BPM-AUI
10BASE2	ThinNet 185m	(607 ft)	30	RPM-BNC, BPM-BNC
10BASE-T	Twisted Pair	100m (328 ft)	n/a	RPM-TP, BPM-TP
FOIRL	mm ¹ Fiber	1.0km(3,281 ft)	n/a	RPM-FST, RPM-FSM, BPM-FST
10BASE-FL	mm ¹ Fiber	2.0km(6,562 ft)	n/a	RPM-FST, RPM-FSM, BPM-FST
*	sgl.m ² Fiber	10.0km(65,620ft)	n/a	RPM-SMF

¹ mm = multi-mode * not currently standardized by IEEE, typically used up to only 4Km distance
² sgl.m = single-mode

3.0 INSTALLATION

This chapter provides instructions for installing the Magnum 700X mixed-media concentrator and each of the available Port Modules (PMs).

3.1 Locating Magnum 700X Mini-Concentrators

The location of the Magnum 700X Mini-Concentrator is dependent on the physical layout of the network and the area to be served. The unit should be set-up in a location that will accommodate easy and equal access to planned network devices and/or segment connections. The Magnum 700X is typically shelf mounted either in a wiring closet or in an open area.

Locate an AC receptacle that is within six feet (2 meters) of the intended Magnum 700X site. The rugged metal case of the Magnum 700X will normally protect it from accidental damage in a wiring closet or in a workplace setting. Keep an open area around the unit so that convection cooling can occur while the unit is in operation.

3.2 Connecting Ethernet Media

The Magnum 700X Mini-Concentrator is specifically designed to support all Ethernet media types within a single unit. This is accomplished by using a family of Port Modules (PMs). The various media types supported along with the corresponding IEEE 802.3 standards and connector types are as follows:

<u>Media</u>	<u>IEEE Standard</u>	<u>Connector</u>	<u>PM type</u>
ThinNet	10BASE2	BNC	RPM-BNC, BPM-BNC
ThickNet	10BASE5	AUI (female)	RPM-AUI, BPM-AUI
Drop Cable	10BASE5	DTE (male)	RPM-DTE
Twisted Pair	10BASE-T	RJ-45	RPM-TP, BPM-TP
Fiber (mm ¹)	FOIRL	ST or SMA	RPM-FST, RPM-FSM, BPM-FST
Fiber (mm ¹)	10BASE-FL	ST or SMA	RPM-FST, RPM-FSM, BPM-FST
Fiber (sgl.m ²)	*	ST	RPM-SMF

¹ mm = multi-mode

² sgl.m = single-mode

* not currently standardized by IEEE, typically used up to 4Km actual distance

3.2.1 Connecting ThinNet 10BASE2 (BNC)

Connect the ThinNet coax cable to the BNC connector on the Magnum RPM-BNC or BPM-BNC card in the same manner as is done for any standard BNC connection. The PM-BNC port is specially equipped with an internal termination switch on the front of the card (see Section 4.1 for a description of this switch). This eliminates the need to use a "tee" connector when the BNC cable is ending at the connection to this PM. Some applications may require a "tee" connector, used as a tap, to allow the 10BASE2 coax segment to continue on past the PM-BNC connection.

3.2.2 Connecting ThickNet 10BASE5 (AUI)

Using the steps below as a guide, attach a new or existing 10BASE5 ThickNet drop-cable directly to the AUI connector on the RPM-AUI or BPM-AUI port.

1. Plug the male end of the cable into the female AUI connector on the PM-AUI card.
2. Engage the AUI connector slide lock to insure maximum connectivity.
3. Connect the opposite end of the cable into a network AUI port. (This could be a network backbone transceiver, a hub or fan-out with an AUI backbone port, or an AUI module in a concentrator.)

The Magnum PM-AUI card may also be used for connecting to other Ethernet devices using standard AUI cabling. In this type of situation, it is important to consider the AUI segment length to the attached device, including any cascading. (See Chapter 2 for detailed information on the PM-AUI card, connector pins, and cable lengths.)

3.2.3 Connecting Drop Cable 10BASE5 (DTE)

Using the steps below as a guide, attach the 10BASE5 drop-cable directly to the DTE connector on the RPM-DTE port.

1. Plug the female end of the cable into the male DTE connector on the RPM-DTE card.
2. Engage the AUI connector slide lock (on the cable) to insure maximum connectivity.
3. Connect the opposite end of the cable into a network AUI port. (This could be a server, router, bridge, hub, or UNIX workstation.)

3.2.4 Connecting Fiber Optic 10BASE-FL and FOIRL (ST-type, "Twist-Lock")

The following procedure applies to FOIRL and 10BASE-FL applications using an RPM-ST or BPM-ST card with ST-type fiber connectors. (The primary difference between FOIRL and

10BASE-FL for users is the maximum distance allowed. 10BASE-FL is used for a fiber segment length of up to 2000m, while FOIRL is used for fiber segments of up to 1000m in length.)

1. Before connecting the fiber optic cable, remove the protective dust caps from the tips of the connectors on the PM-ST. Save these dust caps for future use.
2. Wipe clean the ends of the dual connectors with a soft cloth or lint-free lens tissue dampened in alcohol. Make certain the connectors are clean before connecting.

Note: **One strand of the duplex fiber optic cable is coded using color bands at regular intervals; you must use the color-coded strand on the associated ports at each end of the fiber optic segment.**

3. Connect the Transmit (TX) port (light colored post) on the Magnum PM-FST to the Receive (RX) port of the remote device. Begin with the color-coded strand of the cable for this first TX-to-RX connection.
4. Connect the Receive (RX) port (dark colored post) on the PM-FST to the Transmit (TX) port of the remote device. Use the non-color coded fiber strand for this.
5. The LINK LED on the front of the PM-FST will illuminate when a proper connection has been established at both ends (and when power is ON in the unit). If LINK is not lit after cable connection, the normal cause is improper cable polarity. Swap the fiber cables at the Port Module connector to remedy this situation.

3.2.5 Connecting Fiber Optic (SC-type, "Snap-in")

The same five-step procedure as for fiber ST-type applies to 10BASE-FL applications using an RPM-FSC card used with SC-type fiber connectors. Follow the five steps as described in the paragraph above. See Section 2.3.5 for a view of the SC-type connector.

When connecting fiber media to SC connectors, be sure that the fiber cable goes to another device operating at 10Mb Ethernet speed. (The SC-type fiber connectors are frequently used at 100Mb speeds, but is rare at 10Mb speed and may be confusing accordingly).

3.2.6 Connecting Single-Mode Fiber Optic (SMF)

When using the RPM-SMF, be sure to use single-mode fiber cable. Single-mode fiber cable has a smaller diameter than multi-mode Fiber cable (2/15 - 8/60 microns for single-mode, 50/125 or 62.5/125 microns for multi-mode where xx/xx are the diameters of the core and the core plus the cladding respectively). Because of this, single-mode fiber allows full bandwidth at longer distances, and may be used to connect nodes up to 10km apart (but note that collisions increase for distances over 4Km, a maximum-sized collision domain at 10Mb Ethernet speed).

The same five-step procedure for multi-mode fiber ST-type applies to single-mode fiber connectors. Follow the five steps listed in Section 3.2.4 above.

3.2.7 Connecting Twisted Pair (RJ-45, Unshielded or Shielded)

The following procedure describes how to connect a 10BASE-T twisted pair segment to the RJ-45 port on the RPM-TP or BPM-TP. The procedure is the same for both unshielded and shielded twisted pair segments.

1. Using standard 10BASE-T media, insert either end of the cable with an RJ-45 plug into the RJ-45 connector of the PM-TP. Note that, even though the PM-TP connector is shielded, either unshielded or shielded 10BASE-T cables and wiring may be used.
2. Connect the other end of the cable to the corresponding device.

The Magnum PM-TP is equipped with a cross-over slide switch to accommodate repeater-to-repeater connections without special cross-over connectors.

Set the slide switch to the "down" position for normal twisted pair cable segments from the PM-TP to a user device. Set the slide switch to the "up" position for cascaded or up-link segment connections to another repeater or hub in the network.

To help recall the right slide switch position, remember "up for up-link" !

3.3 Removing the PM Face Plate

The Magnum 700X is normally received from the factory configured with all required PM modules installed. There may be situations where additional PM cards need to be added or, in some cases, replaced. In cases where additional PM cards are needed, the face plate for an available slot must be removed. The following procedure describes this operation.

1. Removing Chassis Cover

STOP!!!

**Be sure the power cord is unplugged
from the chassis before attempting to remove
and/or replace an PM card.
Failure to do so may result in damage to the unit
and will void the warranty.**

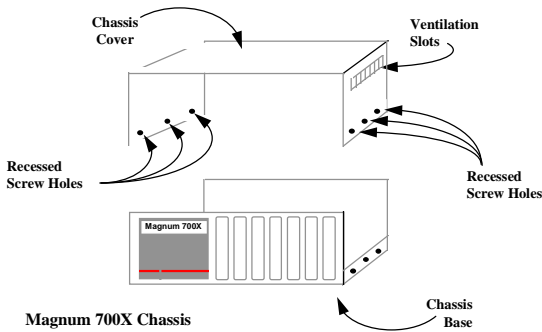

Figure 3.3a: Removing Magnum 700X Chassis Cover

There are three screws located on the left and right side of the unit. Remove all screws. Once removed the chassis cover is easily lifted off the chassis base, and the interior of the unit is exposed. (See Figure 3.3a).

Caution: Be careful not to disturb the power supply.

Looking down into the Magnum 700X unit, notice there are individual PM connector sockets for each PM card. (See Figure 3.3b).

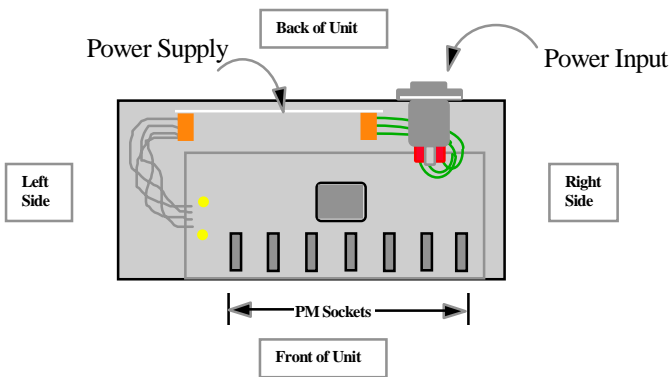

Figure 3.3b: Top View of 700X with Chassis Cover Off

2. Remove PM Retaining Screws

On the front of the unit there are two retaining screws for each PM card slot. These screws are used to secure the face plate in position. These screws are also used to secure individual PM modules. (See Figure 3.3c).

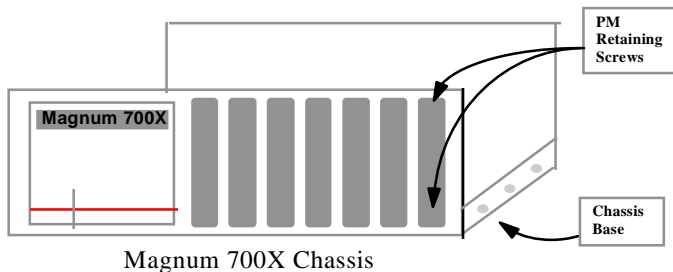

Figure 3.3c: Front Panel View - PM Retaining Screws

Once the face plate or PM has been removed, proceed to Section 3.4 and install the PM card.

3.4 Installing PM Cards

Up to seven assorted PM (Port Module) cards are easily installed in the Magnum 700X Mini-Concentrator chassis. The installation procedure for PMs is described below.

1. Removing 700X Chassis Cover and PM Retaining Screws

Follow the procedure described for Face Plates in Section 3.3, Steps 1 and 2, above.

2. Installing the PM Card

Each PM card fits easily into any available connector socket slot. Align the connector pins on the PM card with the connector socket inside the unit.

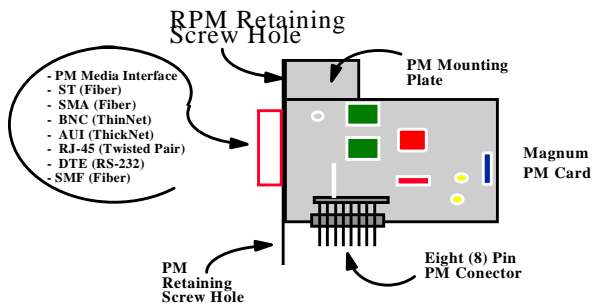

Side View of PM Card

Slowly and firmly push the PM into position. Once inserted, secure the PM card using the two screws on the front panel of the unit. Once all PM cards needed have been installed (including face plates for empty slots), replace the chassis cover.

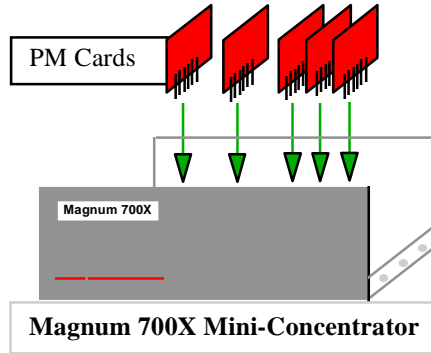

NOTE: All PM slots need not be filled in order for the unit to be operational. When leaving PM slots empty, always use a face plate (Magnum PM-FP) to cover the opening in the front panel to keep the unit clean, and for safety.

3.5 Removing PM Cards

To properly remove a PM card from the Magnum 700X Mini-Concentrator, follow the steps below.

1. Removing 700X Chassis Cover and PM Retaining Screws

Follow the procedure described for Face Plates in Section 3.3, Steps 1 and 2, above.

2. Removing PM Card

Gently pull the PM card up and out of the connector socket. If the slot from which the PM card has been removed is to remain open be sure to install an PM face plate. If another PM card is replacing the one that has been removed, follow the steps as described for installing an PM card discussed on the preceding pages.

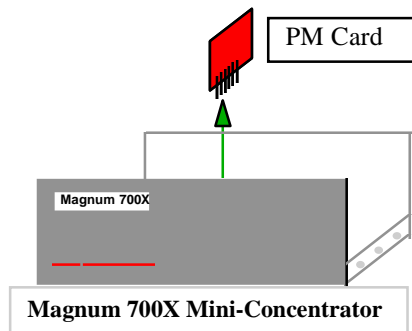

NOTE: Use a face plate (Magnum PM-FP) to cover the opening in the front panel if you are leaving any 700X Mini-Concentrator slots empty.

4.0 OPERATION

This chapter describes the function and operation of the Magnum 700X mixed-media concentrator and its various Port Modules (PMs).

4.1 Repeater Functionality

The Magnum 700X operates as an Ethernet mini-concentrator or repeater to support the interconnection of multiple (two to seven) segments. The segments may be individually selected to be of any media type. The 700X is compliant with IEEE 802.3 specifications and supports all IEEE-defined Ethernet standard media, inclusive of 10BASE-T, 10BASE-FL, 10BASE2, FOIRL, 10BASE2, and 10BASE5.

The following describes the basic functionality of the Magnum 700X Mini-Concentrator.

- 1. Repeater Functions:** Each RPM port operates in conjunction with the controller functions of the Magnum 700X base unit, functioning together as a fully compliant Ethernet repeater. The entire 700X unit counts as a single repeater.
- 2. Collisions:** When a collision is detected at a port other than the original receiving port, it generates a jam pattern to the other ports. When a collision signal is detected at a receiving port, it generates a jam pattern to the other port. The sequence of jam signals depends on the sequence and location of collisions.
- 3. Partitioning and Re-connection:** A Magnum 700X will automatically disconnect (partition) any segment (port) when 64 consecutive collisions occur or after 6.5 ms of continuous transmissions. Network integrity is checked every 800 ms and segment (port) reconnection occurs after a 512-bit packet is transmitted without error.
- 4. Link Status:** Magnum 700X RPMs indicate link integrity for fiber optic and twisted pair segments. Broken cables or a loss of power at any point in twisted pair and fiber segments will turn off the LINK LED indicator on the associated RPM.

4.2 BPM Local Bridge Functionality

When configured with BPMs, the network traffic on the Magnum 700X and its RPM-attached devices is effectively isolated from the network segment connected through each of the BPMs. The local bridge functionality of the BPM bridge modules is described here.

1. Bridge Functions: Each BPM card contains a compact local bridge module which filters and forwards packets at full Ethernet wire speed. These micro-bridges are self learning and have small (256 user) address tables.

Packet filter/forward decisions are made based on whether the packet source is internal (originates within the local Magnum Hub/Stack) or external (originates from upstream on the attached segment). If the packet's source is internal, it is forwarded to the outside only if the destination address is not in the address table. Figure 4.2a shows an internal packet being forwarded to the external segment.

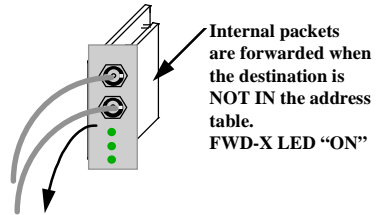

Figure 4.2a: Internal Packet Forwarded

Figure 4.2b show the cases where an internal packet is filtered. When the packet's source is external, it is forwarded to the inside only if the destination address is in the address table.

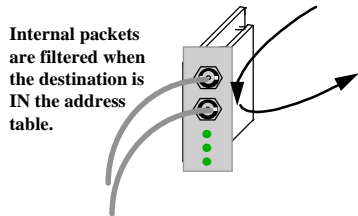

Figure 4.2b: Internal Packets Filtered

The filter/forward handling of external packets are shown in figures 4.2c and 4.2d respectively. When an internal packet's source address is not already in the address table, it is written there. This happens when a node first sends a packet upon bridge initialization.

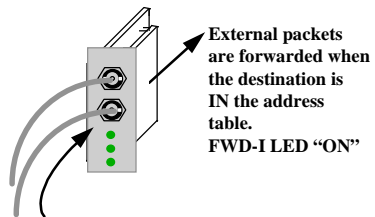

Figure 4.2c: External Packet Forwarded

Note, therefore, that the address table automatically learns addresses, specifically, it learns those connected via the RPMs in the front of the 700X, a number typically well under the 256 table addresses size.

Should the table become full, the BPM will clear all entries in the table by reinitializing itself.

When an external packet's source address is in the address table, it is purged. This can occur if a node has physically moved to a different location.

External packets are filtered when the destination is NOT IN the address table.

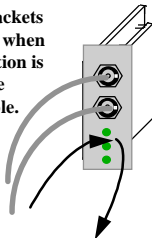

Figure 4.2d: External Packet Filtered

A summary of the filtering, forwarding, and address table maintenance performed by the BPMs is shown in Table 4.2.

Table 4.2: BPM Functionality

Packet Source	Source Address	Destination Address	Address Table Maintenance	Filter/Forward Action
Internal	Not in table	Not in table	Add source to table	Forward
Internal	Not in table	In table	Add source to table	Filter
Internal	In table	Not in table	Nothing	Forward
Internal	In table	In table	Nothing	Filter
External	Not in table	Not in table	Add source to table	Filter
External	Not in table	In table	Add source to table	Forward
External	In table	Not in table	Purge source from table	Filter
External	In table	In table	Purge source from table	Forward

2. Throughput Increase: By using a BPM to isolate a user group segment having significant local traffic, it is possible to increase overall network throughput. For example, a segment containing a group of workstations and servers may have heavy local traffic, but only a small amount of traffic that is directed outside the segment. A BPM connecting this segment to the rest of the network, as shown in Figure 4.2e, will keep the local segment traffic isolated from the rest of the network, thus increasing the effective bandwidth on both the local segment and the rest of the network.

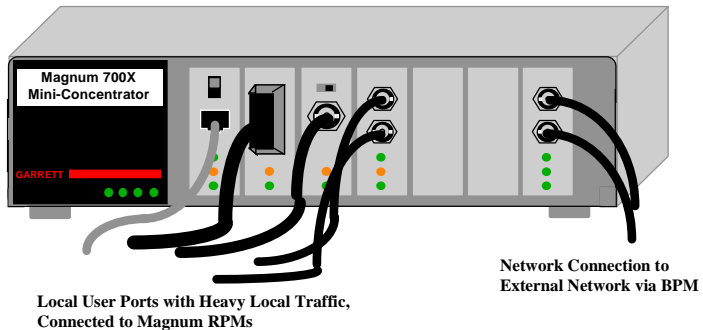

Figure 3.12.2e: Local Isolation with Bridge Port Module

3. Bridge Transparency: The BPMs are transparent to both the user and the application software.

4. LINK and Traffic Status: The Magnum BPM-TP and BPM-FST indicate link integrity with an LED. This LINK LED is normally lit. An unlit LINK LED indicates a broken cable or loss of power at some point in the segment. All BPMs have FWD-I and FWD-X status LEDs. The FWD-I LED flashes when packets are forwarded into the local segment. The FWD-X LED flashes when packets are forwarded out of the local segment.

5. Self-test Diagnostics: A BPM requires about 15 seconds upon power-up before bridging services are available. During this time, the BPM performs an internal self-test.

4.3 Powering the Magnum 700X Mini-Concentrator

The Magnum 700X incorporates an internal universal power supply, and has a female IEC connector for the AC power cord at the right-rear. A six foot 115 vac power cord is supplied with each unit. (Except units being shipped from the GCI factory outside the United States and Canada will not include a 115 vac power cord.)

The Magnum 700X supports installation environments where the AC voltage is from 90 to 260 volts with a power input frequency between 47 and 63 Hz, and will consume no more than a maximum of 40 watts. The power connector is located on the back of the unit. In order to

power down the unit, simply unplug the power cable from either the wall socket, power strip or power connector on the back of the unit.

When connecting various Ethernet media, there is no need to power down the unit. Individual segments of any media type can be connected or disconnected without concern for AC power-related problems or damage to the unit.

4.4 Chassis LEDs

The Magnum 700X Mini-Concentrator is equipped with four LEDs located on the front of the chassis unit. These LEDs include Power (PWR), Receive (RX) Collision (COL) and Jabber (JAB). They are used to provide visual indication about the operational condition and traffic activity of the 700X unit and associated PM cards.

Magnum 700X chassis unit LEDs

<u>LED</u>	<u>Description</u>
PWR	Illuminates GREEN to indicate that the 700X unit is receiving power.
RX	GREEN, ON when data is being received on one or more PM ports.
COL	Flashes YELLOW to indicate a collision has occurred.
JAB	Illuminates AMBER to indicate a jabber condition has occurred.

4.5 PM LEDs

For information on the status LEDs of a particular Port Module, please refer to the cards corresponding section of Chapter 2

5.0 TROUBLESHOOTING

All Magnum Ethernet products are designed to provide reliability and consistently high performance in all network environments. The installation of Magnum 700X Mini-Concentrators is a simple procedure (see Section 3.0, INSTALLATION); operation is very simple and is described in Section 4.0, OPERATION.

Should problems develop during installation or operation, this section should help to locate, identify and correct such problems. Please follow the suggestions listed below prior to contacting your supplier. However, if you are unsure of any procedure described in this section, or if the Magnum 700X is not operating as expected, do not attempt to repair or alter the unit. Contact your supplier (or if unknown, contact Garrett Communications) for assistance.

5.1 Before Calling for Assistance

1. If difficulty is encountered when installing or operating the Magnum 700X Mini-Concentrators, refer back to Section 3.0, Installation and Section 4.0, Operation. Check to make sure that the various other components of the network are operable.
2. Check the cables and connectors to ensure that they have been properly connected and the cables/wires have not been crimped or in some way impaired during installation. (About 90% of network downtime can be attributed to wiring and connector problems.)
3. Be certain that the AC power cord is plugged into a functioning electrical outlet. Make sure that the AC power cord is properly plugged into the 700X unit. Use the PWR LEDs to verify the unit is receiving proper power.
4. If the problem is isolated to a network device other than the Magnum 700X, it is recommended that the problem device be replaced with a known good device. Verify whether or not the problem is corrected. If not go to Step 5 below. If the problem is corrected, the Magnum 700X and its associated cables are functioning properly.
5. If the problem continues after completing Step 4 above, contact your supplier of the Magnum 700X unit (or if unknown, contact Garrett Communications) by fax or by phone for assistance.

5.2 When Calling for Assistance

Please be prepared to provide the following information.

1. A complete description of the problem, including the following points:
 - a. The nature and duration of the problem;
 - b. Situations when the problem occurs;
 - c. The components involved in the problem;
 - d. Any particular application that, when used, appears to create the problem;
2. An accurate list of Garrett Communications product model(s)involved, with serial number(s). Include the date(s) that you purchased the products from your supplier.
3. It is useful to include other network equipment models and related hardware, including personal computers, workstations, terminals and printers; plus, the various network media types being used.
4. A record of changes that have been made to your network configuration prior to the occurrence of the problem. Any changes to system administration procedures should all be noted in this record.

5.3 Return Material Authorization (RMA) Procedure

All returns for repair must be accompanied by a Return Material Authorization (RMA) number. To obtain an RMA number, call Garrett Communications Customer Service at (510) 438-9071 during business hours in California. When calling, please have the following information readily available:

- Name and phone number of your contact person.
- Name of your company / institution
- Your shipping address
- Product name
- Serial Number (or Invoice Number)
- Packing List Number (or Sales Order Number)
- Date of installation
- Failure symptoms, including a full description of the problem.

Garrett Communications will carefully test and evaluate all returned products, will repair products that are under warranty at no charge, and will return the warranty-repaired units to the sender with shipping charges prepaid (see Warranty Information, Appendix A, for complete details). However, if the problem or condition causing the return cannot be duplicated by Garrett Communications, the unit will be returned as:

No Problem Found.

Garrett Communications reserves the right to charge for the testing of non-defective units under warranty. Testing and repair of product that is not under warranty will result in a customer (user) charge.

5.4 Shipping and Packaging Information

Should you need to ship the unit back to Garrett Communications, please follow these instructions:

1. Package the unit carefully. It is recommended that you use the original container if available. Units should be wrapped in a "bubble-wrap" plastic sheet or bag for shipping protection. (You may retain all connectors and this Installation Guide.)

CAUTION

Do not pack the unit in Styrofoam "popcorn" type packing material. This material may cause electro-static shock damage to the unit.

2. Clearly mark the Return Material Authorization (RMA) number on the outside of the shipping container.
3. Garrett Communications is not responsible for your return shipping charges.
4. Ship the package to:

**Garrett Communications
47823 Westinghouse Drive
Fremont, CA 94539
Attn.: Customer Service**

Appendix A: Warranty Information

Garrett Communications warrants its products to be free from defects in materials and workmanship for a period of three (3) years from the date of shipment by Garrett Communications.

During this warranty period, Garrett Communications will repair or, at its option, replace components in the products that prove to be defective at no charge other than shipping and handling, provided that the product is returned pre-paid to Garrett Communications.

This warranty will not be effective if, in the opinion of Garrett Communications, the product has been damaged by misuse, misapplication, or as a result of service or modification other than by Garrett Communications.

Garrett Communications reserves the right to make a charge for handling and inspecting any product returned for warranty repair which turns out not to be faulty.

Please complete the warranty card as this acts as a product registration, and mail it to Garrett Communications within two weeks of your purchase.

Free Manuals Download Website

<http://myh66.com>

<http://usermanuals.us>

<http://www.somanuals.com>

<http://www.4manuals.cc>

<http://www.manual-lib.com>

<http://www.404manual.com>

<http://www.luxmanual.com>

<http://aubethermostatmanual.com>

Golf course search by state

<http://golfingnear.com>

Email search by domain

<http://emailbydomain.com>

Auto manuals search

<http://auto.somanuals.com>

TV manuals search

<http://tv.somanuals.com>