

Gateway EC14T/EC18T Series

Service Guide

Service guide files and updates are available on the ACER/CSD web; for more information, please refer to <http://csd.acer.com.tw>

PRINTED IN TAIWAN

Revision History

Please refer to the table below for the updates made on this service guide.

Date	Chapter	Updates

Copyright

Copyright © 2009 by Acer Incorporated. All rights reserved. No part of this publication may be reproduced, transmitted, transcribed, stored in a retrieval system, or translated into any language or computer language, in any form or by any means, electronic, mechanical, magnetic, optical, chemical, manual or otherwise, without the prior written permission of Acer Incorporated.

Disclaimer

The information in this guide is subject to change without notice.

Acer Incorporated makes no representations or warranties, either expressed or implied, with respect to the contents hereof and specifically disclaims any warranties of merchantability or fitness for any particular purpose. Any Acer Incorporated software described in this manual is sold or licensed "as is". Should the programs prove defective following their purchase, the buyer (and not Acer Incorporated, its distributor, or its dealer) assumes the entire cost of all necessary servicing, repair, and any incidental or consequential damages resulting from any defect in the software.

Acer is a registered trademark of Acer Corporation.

Intel is a registered trademark of Intel Corporation.

Pentium and Pentium II/III are trademarks of Intel Corporation.

Other brand and product names are trademarks and/or registered trademarks of their respective holders.

Conventions

The following conventions are used in this manual:

SCREEN MESSAGES	Denotes actual messages that appear on screen.
NOTE	Gives bits and pieces of additional information related to the current topic.
WARNING	Alerts you to any damage that might result from doing or not doing specific actions.
CAUTION	Gives precautionary measures to avoid possible hardware or software problems.
IMPORTANT	Reminds you to do specific actions relevant to the accomplishment of procedures.

Preface

Before using this information and the product it supports, please read the following general information.

1. This Service Guide provides you with all technical information relating to the BASIC CONFIGURATION decided for Acer's "global" product offering. To better fit local market requirements and enhance product competitiveness, your regional office MAY have decided to extend the functionality of a machine (e.g. add-on card, modem, or extra memory capability). These LOCALIZED FEATURES will NOT be covered in this generic service guide. In such cases, please contact your regional offices or the responsible personnel/channel to provide you with further technical details.
2. Please note WHEN ORDERING FRU PARTS, that you should check the most up-to-date information available on your regional web or channel. If, for whatever reason, a part number change is made, it will not be noted in the printed Service Guide. For ACER-AUTHORIZED SERVICE PROVIDERS, your Acer office may have a DIFFERENT part number code to those given in the FRU list of this printed Service Guide. You MUST use the list provided by your regional Acer office to order FRU parts for repair and service of customer machines.

System Specifications	1
Features	1
System Block Diagram	3
Your Notebook Tour	4
Front View	4
Closed Front View	5
Left View	6
Right View	6
Base View	7
Rear View	8
Indicators	8
TouchPad Basics	9
Using the Keyboard	10
Lock Keys and embedded numeric keypad	10
Windows Keys	11
Hot Keys	12
Special Keys	13
Hardware Specifications and Configurations	14
 System Utilities	 23
BIOS Setup Utility	23
Navigating the BIOS Utility	23
Information	24
Main	25
Security	26
Boot	29
Exit	30
BIOS Flash Utility	31
DOS Flash Utility	32
WinFlash Utility	33
Remove HDD/BIOS Password Utilities	34
Removing BIOS Passwords:	35
Miscellaneous Utilities	36
 Machine Disassembly and Replacement	 39
Disassembly Requirements	39
General Information	39
Pre-disassembly Instructions	39
Disassembly Process	40
External Module Disassembly Process	41
External Modules Disassembly Flowchart	41
Removing the Dummy Card	42
Removing the Battery Pack	42
Removing the SIM Card	44
Removing the Module Cover	45
Removing the Hard Disk Drive Module	46
Removing the DIMM Module	48
Removing the WLAN Board	49
Removing the 3G Module	50
Main Unit Disassembly Process	52
Main Unit Disassembly Flowchart	52
Removing the Keyboard	54
Removing the Hinge Covers	56
Removing the Upper Cover	58

Table of Contents

Removing the Bluetooth Module	62
Removing the Button Board	63
Removing the I/O Board	67
Removing the LED Board	69
Removing the CRT Board	71
Removing the Mainboard	74
Removing the Thermal Module	77
Removing the RTC Battery	78
Removing the Speaker Modules	78
Removing the LCD Module	80
LCD Module Disassembly Process	82
LCD Module Disassembly Flowchart	82
Removing the LCD Bezel	84
Removing the Camera Board	87
Removing the Microphone	88
Removing the LCD Panel	89
Removing the LCD Cable	91
Removing the LCD Brackets	93
Removing the Touchscreen Board	94
Removing the Hinge	95
Removing the Antennas	97
LCD Reassembly Procedure	101
Replacing the Antennas	101
Replacing the Hinge	103
Replacing the Touchscreen Board.	104
Replacing the LCD Brackets	105
Replacing the LCD Cable	106
Replacing the LCD Panel	108
Replacing the Microphone.	110
Replacing the Camera Board	111
Replacing the LCD Bezel	112
Main Unit Reassembly Process	115
Replacing the LCD Module	115
Replacing the RTC Battery	117
Replacing the Thermal Module	117
Replacing the Speakers.	118
Replacing the Mainboard	120
Replacing the CRT Board.	123
Replacing the LED Board	124
Replacing the I/O Board	126
Replacing the Button Board	129
Replace the Bluetooth Module	133
Replacing the Upper Cover	134
Replacing the Hinge Covers	137
Replacing the Keyboard	138
Replacing the 3G Module	139
Replacing the WLAN Module	141
Replacing the DIMM	142
Replacing the Hard Disk Drive	142
Replacing the Module Cover	144
Replacing the SIM Card	146
Replacing the Battery	146
Replacing the Dummy Card	147

Troubleshooting	149
Common Problems	149
Power On Issue	150
No Display Issue	151
Random Loss of BIOS Settings	152
LCD Failure	153
Built-In Keyboard Failure	154
TouchPad Failure	155
Internal Speaker Failure	156
Internal Microphone Failure	157
HDD Not Operating Correctly	158
USB Failure (Right up/down side)	159
Other Failures	159
Intermittent Problems	160
Undetermined Problems	160
Post Codes	161
Jumper and Connector Locations	171
Mainboard Top View	171
Mainboard Bottom View	172
Clearing Password Check and BIOS Recovery	173
Mainboard CMOS Discharge	173
BIOS Recovery by Crisis Disk	174
FRU (Field Replaceable Unit) List	175
Exploded Diagrams	175
LCD	175
Main Chassis	176
FRU List	178
Model Definition and Configuration	187
Test Compatible Components	193
On-line Support Information	197
Index	199

Table of Contents

System Specifications

Features

Below is a brief summary of the computer's many features:

Operating System

- Genuine Windows® 7

Platform

- Intel® Core™2 Duo processor*
- Intel® Pentium® mobile processor*
- Intel® Celeron® mobile processor*
- Mobile Intel® GS45 Express Chipset

System Memory

- Dual-Channel SDRAM support
- Up to 4 GB of DDR3 1066 MHz memory, upgradeable to 8 GB using two soDIMM modules

Display and graphics

- 11.6" HD 1366 x 768
- Convertible display
- Mobile Intel® GS45 Express Chipset

Storage subsystem

- 2.5" hard disk drive
- Multi-in-1 card reader

Audio subsystem

- Optimized 2nd Generation Dolby® Sound Room® audio enhancement
- High-definition audio support
- S/PDIF (Sony/Philips Digital Interface) support for digital speakers
- MS-Sound compatible
- Built-in microphone

Communication

- Integrated webcam*
- WWAN: UMTS/HSPA at 850/900/1900/2100 MHz and quad-band GSM/GPRS/EDGE (850/900/1800/1900 MHz)*

-
- WLAN:
 - Intel® WiFi Link 5100 802.11a/b/g/Draft-N*
 - Intel® WiFi Link 5100 802.11a/b/g*
 - Intel® WiFi Link 1000*
 - WPAN: Bluetooth® 2.1+Enhanced Data Rate*
 - LAN: Gigabit Ethernet; Wake-on-LAN ready

Privacy control

- BIOS user, supervisor, HDD passwords
- Kensington lock slot

Dimensions and Weight

- 285 (W) 208.9 (D) 28.5/34.5 (H) mm (11.22 x 8.22 x 1.12/1.36 inches)
- 1.72 kg (3.79 lbs.) (non-3G SKU)

Power subsystem

- ACPI 3.0
- 62.16 W 5600 mAh
- 3-pin 30 W AC adapter
- ENERGY STAR®*

Special keys and controls

- 84-/85-/88-key keyboard
- Multi-gesture touchpad pointing device

I/O interface

- Multi-in-1 card reader (SD/MMC/MS/MS PRO/xD)
- USB 2.0 port
- HDMI™ port with HDCP support
- External display (VGA) port
- Headphones/speaker/line-out jack with S/PDIF support
- Microphone-in jack
- Ethernet (RJ-45) port
- DC-in jack for AC adapter

Environment

- Temperature:
 - Operating: 5 °C to 35 °C
 - Non-operating: -20 °C to 65 °C
- Humidity (non-condensing):
 - Operating: 20% to 80%
 - Non-operating: 20% to 80%

NOTE: The specifications listed above are for reference only. The exact configuration of the PC depends on the model purchased.

System Block Diagram

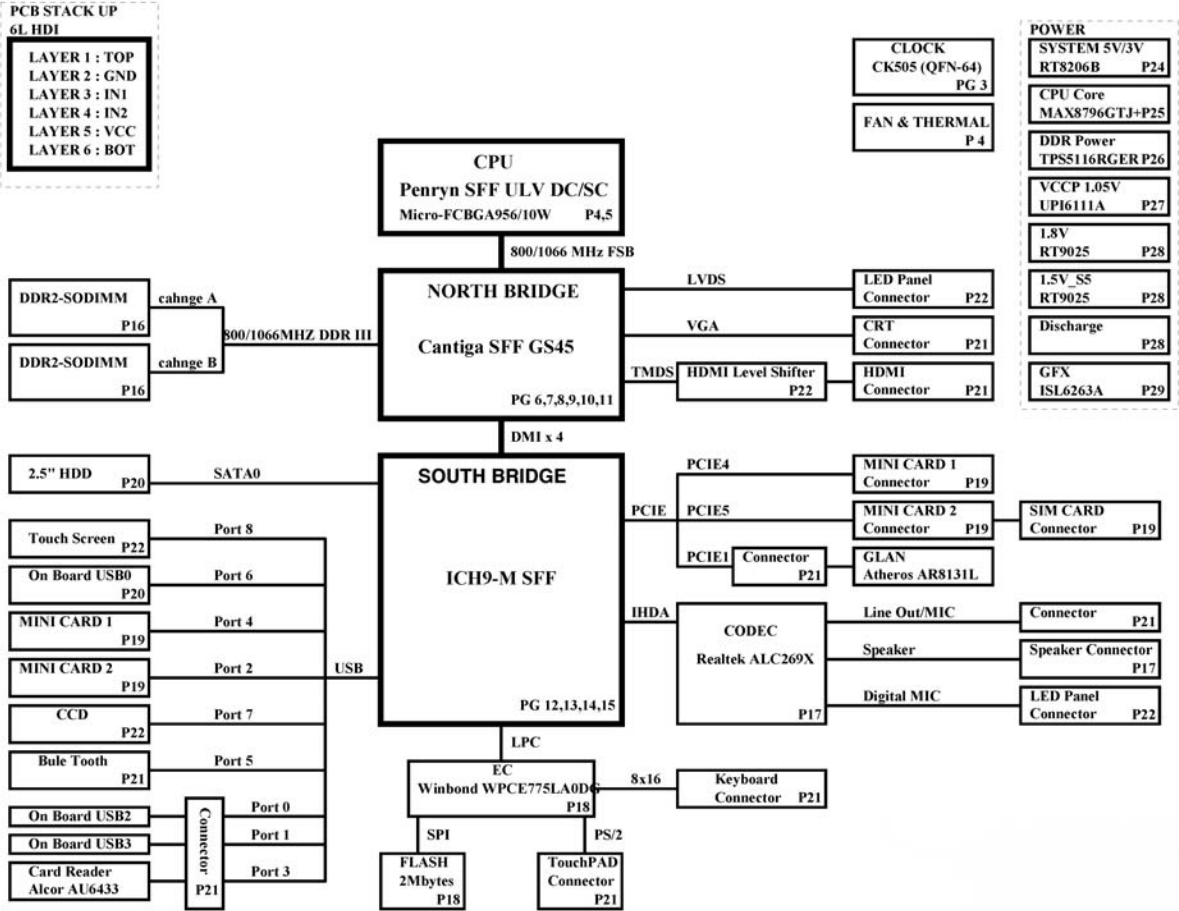





Your Notebook Tour

This section provides an overview of the features and functions of the notebook.

Front View



No.	Icon	Item	Description
1		Webcam	Web camera for video communication
2		Display screen	Also called Liquid-Crystal Display (LCD), displays computer output (Configuration may vary by models).
3	P	Programmable key	Launch predefined programs or user defined programs at the push of a button.
4		Backup key	Press to start automatic backup procedure.
5		HDD	Indicates when the hard drive is active.
		Num Lock	Lights up when the Num Lock is activated.
		Caps Lock	Lights up when Caps Lock is activated.
6		Power	Indicated the computer's power status.

No.	Icon	Item	Description
		Battery	Indicates the computer's battery status. 1. Charging: The light shows amber when the battery is charging. 2. Fully charged: The light shows blue when in AC mode.
		Bluetooth communication indicator	Indicates the status of Bluetooth communication. (only for certain models)
		Communication indicator	Indicates the status of WLAN / 3G communication.
7		Click buttons (left and right)	The left and right buttons function like the left and right mouse buttons.
8		Touchpad	Touch-sensitive pointing device which functions like a computer mouse.
9		Palmrest	Comfortable support area for your hands when you use the computer.
10		Keyboard	For entering data into your computer.
11		Stylus	A pen tool for entering data into your computer
12		Microphone	Internal microphone for sound recording
13		Magnetic lock	A lock that snaps into place to prevent the screen from inadvertently rotating.

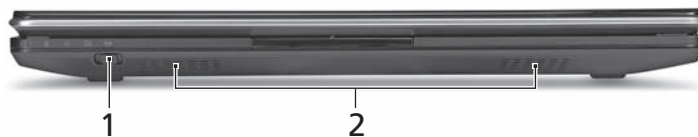

Closed Front View



No.	Icon	Item	Description
1		Communication key	Enables / disables the WLAN / 3G functions.
2		Speakers	Left and right speakers deliver stereo audio output.

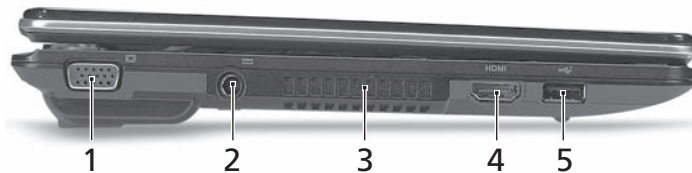



Left View



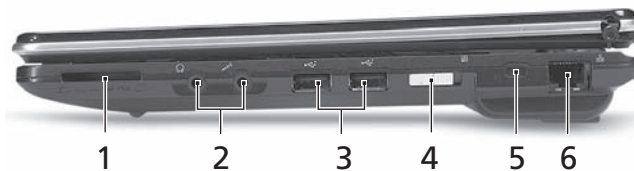

No.	Icon	Item	Description
1		External display (VGA) port	Connects to a display device (e.g. external monitor, LCD projector).
2		DC-in jack	Connects to an AC adapter
3		Ventilation slots	Enable the computer to stay cool, even after prolonged use.
4	HDMI	HDMI port	Supports high definition digital video connections.
5		USB 2.0 port	Connect to USB 2.0 devices (e.g., USB mouse, USB camera).

Right View







No.	Icon	Item	Description
1		Multi-in-1 card reader	Accepts Secure Digital (SD), MultiMediaCard (MMC), Memory Stick (MS), Memory Stick PRO (MS PRO), xD-Picture Card (xD). Note: Push to remove/install the card. Only one card can operate at any given time.
2		Headphones/speaker/line-out jack with S/PDIF support	Connects to audio line-out devices (e.g., speakers, headphones).
		Microphone-in jack	Accepts inputs from external microphones.
3		USB 2.0 port	Connects to USB 2.0 devices (e.g., USB mouse, USB camera).
4		Power button / indicator	Slide the power button to turn the computer on and off. / Indicates the computer's power status.

5		Kensington lock slot	Connects to a Kensington-compatible computer security lock. Note: Wrap the computer security lock cable around an immovable object such as a table or handle of a locked drawer. Insert the lock into the notch and turn the key to secure the lock. Some keyless models are also available.
6		Ethernet (RJ-45) port	Connects to an Ethernet 10/100/1000-based network.

Base View



No.	Icon	Item	Description
1		Battery bay	Houses the computer's battery pack.
2		Hard disk bay	Houses the computer's hard disk (secured with screws).
3		Memory compartment	Houses the computer's main memory.
4		Ventilation slots and cooling fan	Enable the computer to stay cool, even after prolonged use. Note: Do not cover or obstruct the opening of the fan.
5		Battery lock	Locks the battery in position.
6		Battery release latch	Releases the battery for removal.



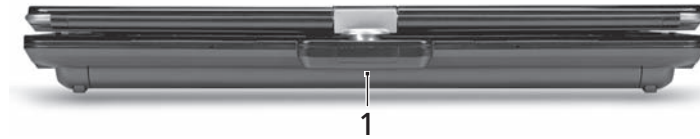



Rear View



No.	Icon	Item	Description
1		Battery bay	Houses the computer's battery pack.

Indicators

The computer has several easy-to-read status indicators. The battery indicator is visible even when the computer cover is closed.

Icon	Function	Description
	Bluetooth	Indicates the status of Bluetooth communication.
	Wireless LAN	Indicates the status of Wireless LAN/3G communication.
	HDD	Indicates when the hard disk drive is active.
	Num Lock	Lights up when Num Lock is activated.
	Caps Lock	Lights up when Caps Lock is activated.
	Battery	Indicates the computer's battery status.

NOTE: 1. **Charging:** The battery light shows amber when the battery is charging. 2. **Fully charged:** The light shows green when in AC mode.

TouchPad Basics

The following items show you how to use the TouchPad:

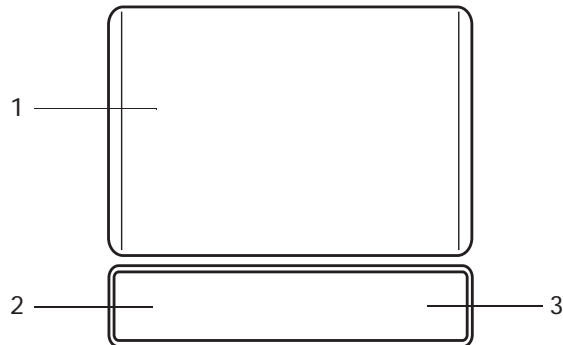

- Move your finger across the TouchPad (1) to move the cursor.
- Press the left (2) and right (3) buttons located beneath the TouchPad to perform selection and execution functions. These two buttons are similar to the left and right buttons on a mouse. Tapping on the TouchPad is the same as clicking the left button.

Function	Left Button (2)	Right Button (3)	Main TouchPad (1)
Execute	Quickly click twice.		Tap twice (at the same speed as double-clicking a mouse button).
Select	Click once.		Tap once.
Drag	Click and hold, then use finger on the TouchPad to drag the cursor.		Tap twice (at the same speed as double-clicking a mouse button); rest your finger on the TouchPad on the second tap and drag the cursor.
Access context menu		Click once.	

NOTE: When using the TouchPad, keep it - and your fingers - dry and clean. The TouchPad is sensitive to finger movement; hence, the lighter the touch, the better the response. Tapping too hard will not increase the TouchPad's responsiveness.

Using the Keyboard

This computer has a close-to-full-sized keyboard and an embedded numeric keypad, separate cursor, lock, function and special keys.

Lock Keys and embedded numeric keypad

The keyboard has three lock keys which you can toggle on and off.













Lock key	Description
Caps Lock	When Caps Lock is on, all alphabetic characters typed are in uppercase.
Num Lock <Fn> + <F11>	When Num Lock is on, the embedded keypad is in numeric mode. The keys function as a calculator (complete with the arithmetic operators +, -, *, and /). Use this mode when you need to do a lot of numeric data entry. A better solution would be to connect an external keypad.
Scroll Lock <Fn> + <F12>	When Scroll Lock is on, the screen moves one line up or down when you press the up or down arrow keys respectively. Scroll Lock does not work with some applications.

The embedded numeric keypad functions like a desktop numeric keypad. It is indicated by small characters located on the upper right corner of the keycaps. To simplify the keyboard legend, cursor-control key symbols are not printed on the keys.

Desired access	Num Lock on	Num Lock off
Number keys on embedded keypad	Type numbers in a normal manner.	
Cursor-control keys on embedded keypad	Hold <Shift> while using cursor-control keys.	Hold <Fn> while using cursor-control keys.
Main keyboard keys	Hold <Fn> while typing letters on embedded keypad.	Type the letters in a normal manner.

Windows Keys













The keyboard has two keys that perform Windows-specific functions.

Key	Description
 Windows key	<p>Pressed alone, this key has the same effect as clicking on the Windows Start button; it launches the Start menu. It can also be used with other keys to provide a variety of functions:</p> <ul style="list-style-type: none"><  >: Open or close the Start menu<  > + <D>: Display the desktop<  > + <E>: Open Windows Explore<  > + <F>: Search for a file or folder<  > + <L>: Lock your computer (if you are connected to a network domain), or switch users (if you're not connected to a network domain)<  > + <M>: Minimizes all windows<  > + <R>: Open the Run dialog box<  > + <U>: Open Ease of Access Center<  > + <BREAK>: Display the System Properties dialog box<  > + <TAB>: Cycle through programs on the taskbar<CTRL> + <  > + <F>: Search for computers (if you are on a network) <p>Note: Depending on your edition of Windows 7, some shortcuts may not function as described.</p>
 Application key	This key has the same effect as clicking the right mouse button; it opens the application's context menu.

Hot Keys

The computer employs hotkeys or key combinations to access most of the computer's controls like screen brightness and volume output.

To activate hotkeys, press and hold the <Fn> key before pressing the other key in the hotkey combination.

Hotkey	Icon	Function	Description
<Fn> + <F1>		Power management	Launch Windows power management.
<Fn> + <F2>		System Properties	Display the System Properties dialog box.
<Fn> + <F3>		Bluetooth communication switch	Enables/disables the Bluetooth function.
<Fn> + <F4>		Sleep	Puts the computer in Sleep mode.
<Fn> + <F5>		Display toggle	Switches display output between the display screen, external monitor (if connected) and both.
<Fn> + <F6>		Screen blank	Turns the display screen backlight off to save power. Press any key to return.
<Fn> + <F7>		Touchpad toggle	Turns the internal touchpad on and off.
<Fn> + <F8>		Speaker toggle	Turns the speakers on and off.
<Fn> + <▷>		Brightness up	Increases the screen brightness.
<Fn> + <◁>		Brightness down	Decreases the screen brightness.
<Fn> + <△>		Volume up	Increases the sound volume.
<Fn> + <▽>		Volume down	Decreases the sound volume.

Special Keys

You can locate the Euro symbol and the US dollar sign at the upper-center and/or bottom-right of your keyboard.

The Euro symbol

1. Open a text editor or word processor.
2. Hold <Alt Gr> and then press the <5> key at the upper-center of the keyboard.

NOTE: Some fonts and software do not support the Euro symbol. See www.microsoft.com/typography/faq/faq12.htm for more information.

The US dollar sign

1. Open a text editor or word processor.
2. Hold <Shift> and then press the <4> key at the upper-center of the keyboard.

NOTE: This function varies according to the language settings.

Hardware Specifications and Configurations

Processor

Item	Specification
CPU type	Intel Penryn SFF (ULV)
CPU package	Micro-FCBGA 956 balls
Features	<ul style="list-style-type: none"> • Supports Intel architecture with Dynamic execution. • On-die, primary 32-kB instruction cache and 32-kB write-back data cache. • On-die, up to 3MB second level shared cache with advanced transfer cache architecture. • Streaming SIMD Extensions 2 (SSE2), Streaming SIMD Extensions 3 (SSE3) • Supplemental streaming SIMD extensions 3 (SSSE3) and SSE4.1 instruction sets. • 800MHz source-synchronous front side bus (FSB) • Advanced power management features including Enhanced Intel SpeedStep® • Technology and dynamic FSB frequency switching. • Digital thermal sensor (DTS). • Execute disable bit support for enhanced security. • Intel® Dynamic Acceleration Technology and Enhanced Multi Threaded • Thermal Management (EmTTM). • Support enhanced Intel Virtualization Technology.
Core Logic	• Mobile Intel® GS45 Express Chipset

Processor Specifications

Item	CPU Speed	Cores	Cache Size	Package	Core Voltage	Acer P/N
SU7300	1.4GHz	1	3MB	Micro-FCBGA 956 balls	1.050V-1.150V	C2DSU7300B
SU4100	1.3GHz	2	2MB	Micro-FCBGA 956 balls	1.050V-1.150V	PMDSU4100B
SU2300	1.2GHz	2	1MB	Micro-FCBGA 956 balls	1.050V-1.150V	CMSU2300B

CPU Fan True Value Table

CPU Temperature (Celsius)	Fan Speed (RPM)	SPL Spec (dBA)
38	2400	On
43	3300	26
49	4000	29
56	4500	31

Throttling 50%: On = 88°C; Off = 85°C

EC shut down at 95°C; H/W shut down at 98°C

North Bridge Specifications

Item	Specification
Chipset	Intel Crestline GS45 SFF
Package	FCBGA 1363 balls

Item	Specification
Features	<ul style="list-style-type: none"> Processor host bus supports 667/800/1066Mhz FSB support. Supports Dual Channel DDR3 SD-RAM at 800/1066MHz. Integrated SDRAM controller up to *GB (2 SODIMM support) DMI x2 and DMI x4 for connection between GMCH and ICH9M.

South Bridge Specifications

Item	Specification
Chipset	ICH9M SFF
Package	BGA 676 balls
Features	<ul style="list-style-type: none"> Upstream accelerated Hub architecture interface for access to GMCH. PCI Express Base Specification, Revision 1.1 support. PCI 2.3 interface. (4 PCI Request/Grant pairs). ACPI Power Management Logic Support. Enhanced DMA controller, interrupt controller, timers functions. Integrated Serial ATA host controllers with independent DMA operation on six ports and AHCI support. USB 1.1 & USB 2.0 Host controllers. Supports Intel High Definition Audio (Intel HD Audio) Interface. Supports Intel® Matrix Storage Technology. Supports Intel® Active Management Technology. Low Pin Count (LPC) interface. 6 PCIe ports.

System Memory

Item	Specification
Memory size	0MB (No on-board Memory)
DIMM socket number	2 sockets
Supports memory size per socket	2GB
Supports maximum memory size	4GB for 64bit OS (with two 2GB SO-DIMM)
Supports DIMM type	DDR3 Synchronous DRAM
Supports DIMM Speed	800 MHz
Supports DIMM voltage	1.5V
Supports DIMM package	204-pin DDR3-800 SO-DIMM
Module Combination	Any combination permissible within the above specifications.

Hard Disk Drive Interface

Item	Specifications					
Vendor & Model Name	Hitachi HTS545050B 9A300	Hitachi HTS545032B 9A300	Hitachi HTS545025B 9A300	Hitachi HTS545016B 9A300	Hitachi HTS543225L 9A300	Hitachi HTS543216L9 SA00
Capacity (GB)	500	320	250	160	250	160
Bytes per sector	512					
Data heads	4	3	2	2	3	2
Drive Format						

Item	Specifications					
Disks	2	2	1	1	2	1
Spindle speed (RPM)	5400					
Performance Specifications						
Buffer size	8MB					
Interface	SATA					
Internal transfer rate (Gbits/sec., max)	3GB/s maximum					1.5GB/s maximum
I/O data transfer rate (Mbytes/sec max)	875 Mbits/s maximum			845 Mbits/s maximum	775Mbits/s maximum	729Mbits/s maximum
DC Power Requirements						
Voltage	+5.0V ± 5%.					

Item	Specifications			
Vendor & Model Name	Toshiba MK1655GSX	Toshiba MK2555GSX	Toshiba MK3255GSX	Toshiba MK5055GSX
Capacity (GB)	160	250	320	500
Bytes per sector	512	512	512	512
Data heads	2	2	4	4
Drive Format				
Disks	1	1	2	2
Spindle speed (RPM)	5400			
Performance Specifications				
Buffer size	8MB			
Interface	SATA			
Internal transfer rate (Mbits/sec, max)	363 – 952 typical			
I/O data transfer rate (Mbytes/sec max)	300			
DC Power Requirements				
Voltage	5V ±5%			

Item	Specifications			
Vendor & Model Name	Western Digital WD1600BEVT-22ZCT0	Western Digital WD2500BEVT-22ZCT0	Western Digital WD3200BEVT-22ZCT0	Western Digital WD5000BEVT-22ZAT0
Capacity (GB)	160	250	320	500
Bytes per sector	512			
Data heads	2	4	3	4

Item	Specifications			
Drive Format				
Disks	1	2	2	2
Spindle speed (RPM)	5400			
Performance Specifications				
Buffer size	8 MB			
Interface	SATA			
Internal transfer rate (Mbits/sec, max)	N/A			
I/O data transfer rate (Mbytes/sec max)	300			
DC Power Requirements				
Voltage	5V ±5%			

BIOS

Item	Specification
BIOS vendor	Insyde
BIOS ROM type	W25X16AVSSIG
BIOS ROM size	16Mb
BIOS package	8 PIN SOIC
Supported Protocols	SPI
BIOS password control	Set by setup manual

LCD 11.6"

Item	Specifications			
Vendor/model name	AUO B116XW02	Chi Mei N116B6-L02	LG LP116WH1	Samsung LTN116AT01-A01
Screen Diagonal (mm)	293.83			
Active Area (mm)	256.125 (H) x 144.00 (V)			
Display resolution (pixels)	1366x3(RGB) x 768			
Pixel Pitch (mm)	0.1875 x 0.1875			0.2265(H) x 0.2265(V)
Typical White Luminance (cd/m ²) also called Brightness	200 typ. (5 points average)			
Contrast Ratio	500:1 typ			
Response Time (Optical Rise Time/Fall Time) msec	8 typ / 16 Max	8 typ / 16 Max	9 typ / 16 max	16 typ / 25 max
Typical Power Consumption (watt)	4.0 max. (Include Logic and Blu power)	N/A	3.18 W Typ.	N/A
Weight (without inverter)	255g max.	240g max	255g max.	
Physical Size (mm)	268L x 161.5W x 5.0T			

Item	Specifications			
Electrical Interface	1 channel LVDS	3.3V LVDS	LVDS	LVDS
Viewing Angle (degree)				
Horizontal (Right) / (Left)	45/45	45/45	30/30	45/45
Vertical (Upper) / (Lower)	10/30	20/45	10/20	15/35

Bluetooth

Item	Specification
Bluetooth Controller	Foxconn T60H928.33
Features	<ul style="list-style-type: none"> Fully Qualified Bluetooth v2.1 with Class 2 specification RF output power. Enhanced Data Rate (EDR) compliant. Full Piconet and Scatternet operation. Integrated PIFA Antenna with better RF performance. USB 2.0 compliant interface. F/W upgradable via Flash downloads. Very low power consumption. Support Coexistence with Intel WCS (Wireless Coexistence System) & AFH (Adaptive Frequency Hopping)
Radio Technology	FHSS
Operating Frequency	2.402GHz ~ 2.480GHz
Channel Numbers	79 channels with 1MHz BW
Transmitter Output Power	-6~-4dBm output power for BT class 2 operation
Coverage	10m (Varies depending on operating environment)
Receiver Sensitivity	-75dBm, BER<0.1%
Maximum Receiver Signal	-10dBm
Operating Voltage	3.3V+/-0.3V
Working Temperature	Operating temp: 0 °C to +70 °C (+32 °F to +158 °F) Non-operating temp: -10 °C to +75°C (+14 °F to +167 °F)
Interface	USB2.0 with JST SM08B-SURS-TF connector
Weight	1.75g

Audio Interface

Item	Specification
Codec Controller	Realtek ALC269X
Compatibility	<ul style="list-style-type: none"> Headphone-out S/PDIF, Line-In and Microphone-In. 2 stereo ADCs support 16/20/24-bit PCM format recording simultaneously.
Sampling Rate	<ul style="list-style-type: none"> All DACs supports 16/20/24-bit, 44.1k/48k/96k/192kHz sample rate. Two independent S/PDIF-OUT converters support 16/20/24-bit, 44.1k/48k/88.2k/96k/192kHz sample rate. One for normal S/PDIF output, the other one output an independent digital stream to HDMI transmitter.
Internal Microphone	<ul style="list-style-type: none"> Digital MICRO PHONE ZK2(HFM-M101-006-L19-G) Digital MICRO PHONE ZK2(A-OA2408FM-018)
Internal Speakers	<ul style="list-style-type: none"> Two Med-High Speakers (1W/4Ω)

LAN Interface

Item	Specification
LAN Chipset	Atheros AR8131L
Package	48pin QFN
Features	<ul style="list-style-type: none">• It is an ultra-high performance, ultralow cost, and ultralow power fully integrated 10/100/1000 Mbps NIC/LOM Ethernet.• The AR8131L combines a 10/100/1000BASE-T GbE media access controller (MAC), a triplespeed Ethernet physical layer transceiver (PHY), and a PCI Express bus interface.• The AR8131L is compliant with IEEE 802.3u specification for 10/100 Mbps Ethernet and IEEE 802.3ab specification for 1000 Mbps Ethernet.• The AR8131L device combines pulse shaping, Tx/Rx PCS, echo canceller, NEXT canceller, equalizer, decoder, and timing recovery functions to deliver robust signal performance in noisy environments.• The AR8131L GbE controller supports checksum off-load features for IP, TCP, and UDP, lowering CPU utilization and optimizing network performance.

Keyboard

Item	Specification
Keyboard Controller	Winbond WPCE775LA0DG
Total number of keypads	US: 86 UK: 86 UI: 86 GERMAN: 86
Windows logo key	Yes
Internal & external keyboard work simultaneously	Plug USB keyboard to the USB port directly: Yes
Features	<ul style="list-style-type: none">• Plug USB keyboard to the USB port directly: Yes

Media Card Reader

Item	Specification
Chipset	Alcor AU6433
Features	<ul style="list-style-type: none">• Fully compatible with USB2.0 High Speed and backward compatible with USB1.1 specifications• Supports multiple flash card interfaces, including SD/MMC/xD/MS.• Supports single LUN• 48-pin LQFP

Item	Specification
Compliance	<ul style="list-style-type: none"> Complies with USB Device Class Definition for Mass Storage and Bulk-Transport V1.0 Complies with Secure Digital Card (SD) specification up to ver. 2.0(SDHC) Complies with MultiMedia Card (MMC) specification up to ver. 4.2 Complies with Memory Stick (MS) specification up to ver. 1.43 Complies with Memory Stick PRO (MS_Pro) specification up to ver. 1.03 Complies with Memory Stick PRO-HG (MS PRO-HG) specification up to ver. 1.01 Complies with Memory Stick Interface Guideline for PC peripheral devices with Memory Stick Slot ver. 1.16-00 Complies with xD-Picture Card (xD) specification up to version 1.2
Interface	<ul style="list-style-type: none"> USB 2.0
Power	<ul style="list-style-type: none"> 3.3V

Camera

Item	Specifications		
Vendor and model	Chicony CNF9011/9048	Lite-on 09P2SF001	Suyin CN0316-S30C-OV06-1
Interface	USB 2.0		
Optical aperture	N/A		
Focusing range	17.4 cm - infinity	19 CM - infinity	40 CM - infinity
Dimensions (L x W x H mm)	68 X 8 X 3.64 mm	68 X 8 X 3.84 mm	65 X 7.9 X 3.8 mm
Sensor type	CMOS		
Pixel resolution	640X480		

Wireless LAN

Item	Specification	Specification	Specification	Specification
Manufacturer	Foxconn	Foxconn	Intel	Intel
Type	Atheros AR9283	T77H121.01	WiFi Link 1000	Shirley Peak
PHY Mode Supported	b,g,n.	b,g,n.	b, g, n.	a, b, g, n.

Item	Specification	Specification
Manufacturer	Intel	Lite-on
Type	Wifi Link 5000	Atheros AR5B93
PHY Modes Supported	a, b, g, n.	b, g, n.

3G Module

Item	Specifications
3G Module	<ul style="list-style-type: none"> Qualcomm Gobi1000 Huawei EM770W
Technical Standard	GSM / GPRS/ EGPRS MSC 12 / DTM Item/ WCDMA R5 / HSDPA 7.2Mbps / HSUPA 5.76Mbps

Item	Specifications
Interface	USB 2.0
Antenna	1 x 2

Embedded Controller

Item	Specifications
Chipset	Winbond WPCE775LA0DG
Features	<ul style="list-style-type: none"> • Shared SPI BIOS flash memory with page programming support. • High-accuracy, high-speed ADC. • Up to 95 GPIO ports (including keyboard scanning) with a variety of wake-up events (up to 42 wake-up inputs). • 16-bit RISC core, with up to 4 Mbytes of external address space, running at up to 25 MHz. • 128-pin LQChipFP

Battery

Item	Specifications
	6 Cell
Vendor & model name	SIMPLO UM09F70 3S2P SANYO UM09F36 3S2P
Battery Type	Li-ion
Pack capacity	SANYO 6 cell 5600mAh SAMSUNG 6 cell 5600mAh LGC 6 cell 5600mAh
Number of battery cell	6
Package configuration	3 cells in series, 2 series in parallel
Normal voltage	11.1
Charge voltage	12.6

System Utilities

BIOS Setup Utility

The BIOS Setup Utility is a hardware configuration program built into your computer's BIOS (Basic Input/Output System).

Your computer is already properly configured and optimized, and you do not need to run this utility. However, if you encounter configuration problems, you may need to run Setup. Please also refer to Chapter 4 Troubleshooting when problem arises.

To activate the BIOS Utility, press **F2** during POST (when **Press <F2> to enter Setup** message is prompted on the bottom of screen).

Press **F2** to enter setup. The default parameter of F12 Boot Menu is set to "disabled". If you want to change boot device without entering BIOS Setup Utility, please set the parameter to "enabled".

Press **<F12>** during POST to enter multi-boot menu. In this menu, user can change boot device without entering BIOS SETUP Utility.

Navigating the BIOS Utility

There are six menu options: Information, Main, Advanced, Security, Power, Boot, and Exit.

Follow these instructions:

- To choose a menu, use the left and right arrow keys.
- To choose an item, use the up and down arrow keys.
- To change the value of a parameter, press **F5** or **F6**.
- A plus sign (+) indicates the item has sub-items. Press **Enter** to expand this item.
- Press **Esc** while you are in any of the menu options to go to the Exit menu.
- In any menu, you can load default settings by pressing **F9**. You can also press **F10** to save any changes made and exit the BIOS Setup Utility.

NOTE: You can change the value of a parameter if it is enclosed in square brackets. Navigation keys for a particular menu are shown on the bottom of the screen. Help for parameters are found in the Item Specific Help part of the screen. Read this carefully when making changes to parameter values. **Please note that system information is subject to different models.**

Information

The Information screen displays a summary of your computer hardware information.

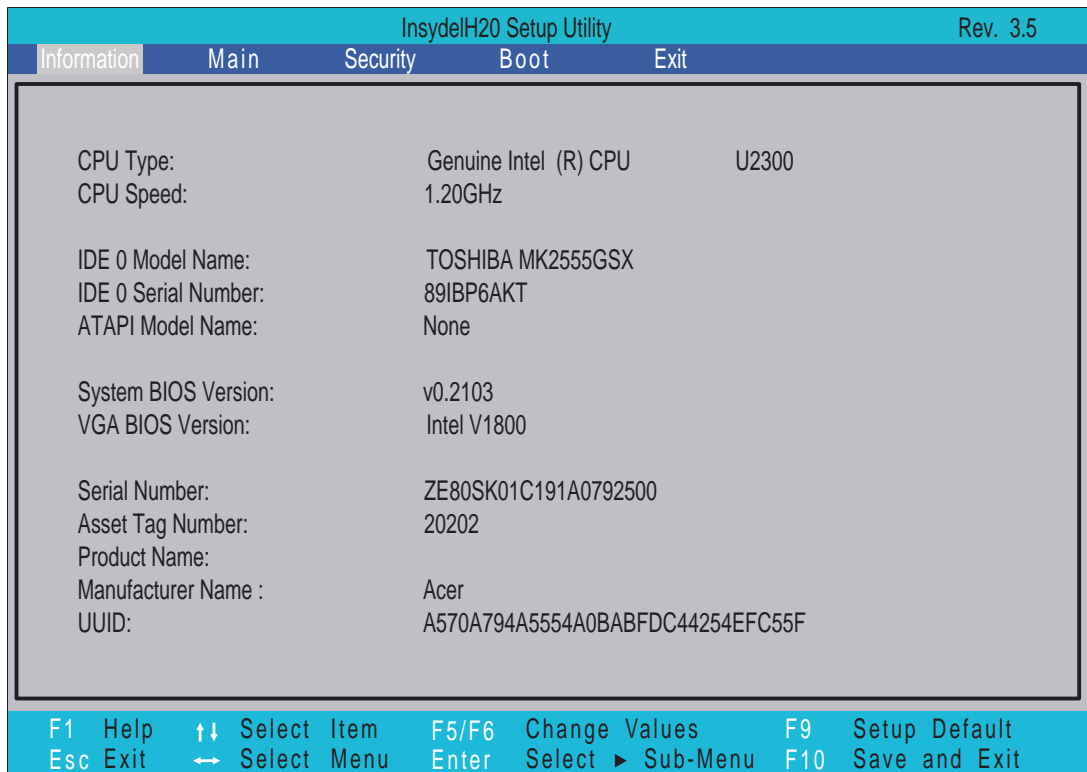

NOTE: The system information is subject to different models.

Parameter	Description
CPU Type	This field shows the CPU type and speed of the system.
CPU Speed	This field shows the speed of the CPU.
HDD Model Name	This field shows the model name of HDD installed on primary IDE master.
HDD Serial Number	This field displays the serial number of HDD installed on primary IDE master.
ATAPI Model Name	This field displays the model name of the installed ODD drive.
System BIOS Version	Displays system BIOS version.
VGA BIOS Version	This field displays the VGA firmware version of the system.
Serial Number	This field displays the serial number of this unit.
Asset Tag Number	This field displays the asset tag number of the system.
Product Name	This field shows product name of the system.
Manufacturer Name	This field displays the manufacturer of this system.
UUID Number	Universally Unique Identifier (UUID) is an identifier standard used in software construction, standardized by the Open Software Foundation (OSF) as part of the Distributed Computing Environment (DCE).

Main

The Main screen allows the user to set the system time and date as well as enable and disable boot option and recovery.

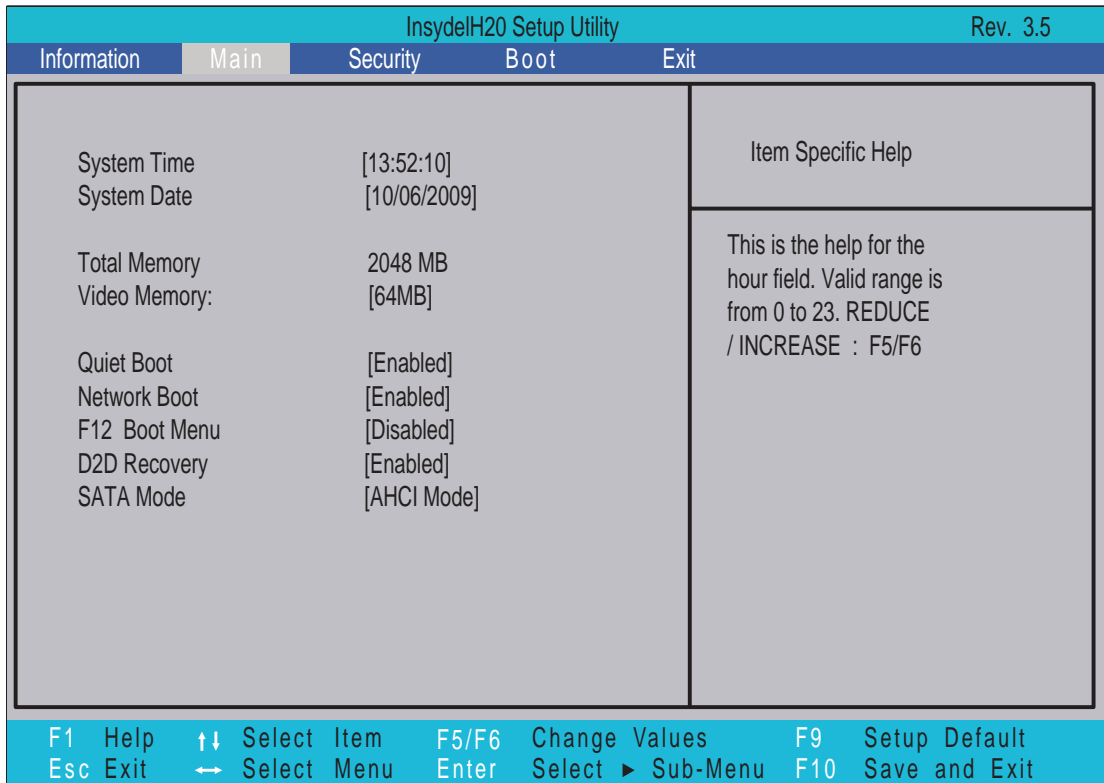

NOTE: The screen above is for your reference only. Actual values may differ.

The table below describes the parameters in this screen. Settings in **boldface** are the default and suggested parameter settings.

Parameter	Description	Format/Option
System Time	Sets the system time. The hours are displayed with 24-hour format.	Format: HH:MM:SS (hour:minute:second)
System Date	Sets the system date.	Format MM/DD/YYYY (month/day/year)
Total Memory	This field reports the memory size of the system. Memory size is fixed to 2048 MB.	N/A
Video Memory	Shows the video memory size. VGA Memory size=32 MB	N/A
Quick Boot	Allows startup to skip certain tests while booting, decreasing the time needed to boot the system.	Option: Enabled or Disabled
Network Boot	Enables, disables the system boot from LAN (remote server).	Option: Enabled or Disabled
F12 Boot Menu	Enables, disables Boot Menu during POST.	Option: Enabled or Enabled
D2D Recovery	Enables, disables D2D Recovery function. The function allows the user to create a hidden partition on hard disc drive to store operation system and restore the system to factory defaults.	Option: Enabled or Disabled
SATA Mode	Control the mode in which the SATA controller should operate.	Option: AHCI or IDE

Security

The Security screen contains parameters that help safeguard and protect your computer from unauthorized use.

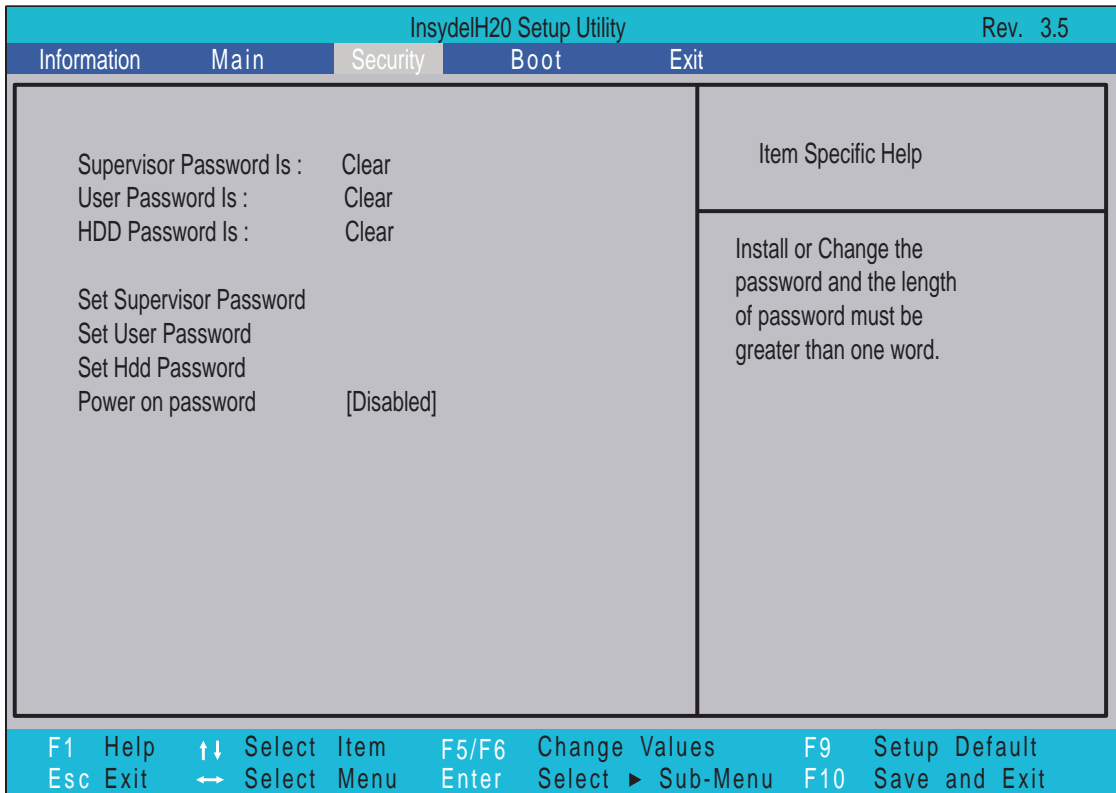

The table below describes the parameters in this screen. Settings in **boldface** are the default and suggested parameter settings.

Parameter	Description	Option
Supervisor Password Is	Shows the setting of the Supervisor password	Clear or Set
User Password Is	Shows the setting of the user password.	Clear or Set
Set Supervisor Password	Press Enter to set the supervisor password. When set, this password protects the BIOS Setup Utility from unauthorized access. The user can not either enter the Setup menu nor change the value of parameters.	
Set User Password	Press Enter to set the user password. When user password is set, this password protects the BIOS Setup Utility from unauthorized access. The user can enter Setup menu only and does not have right to change the value of parameters.	
Set Hdd Password	Enter HDD password.	
Power on password	Defines whether a password is required or not while the events defined in this group happened. The following sub-options are all requires the Supervisor password for changes and should be grayed out if the user password was used to enter setup.	Enabled or Disabled

NOTE: When you are prompted to enter a password, you have three tries before the system halts. Don't forget your password. If you forget your password, you may have to return your notebook computer to your dealer to reset it.

Setting a Password

Follow these steps as you set the user or the supervisor password:

1. Use the ↑ and ↓ keys to highlight the Set Supervisor Password parameter and press the **Enter** key. The Set Supervisor Password box appears:

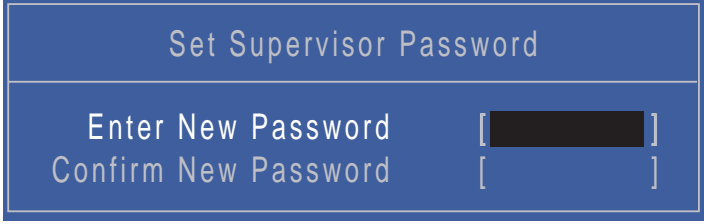

Set Supervisor Password	
Enter New Password	[██████████]
Confirm New Password	[]

2. Type a password in the “Enter New Password” field. The password length can not exceeds 8 alphanumeric characters (A-Z, a-z, 0-9, not case sensitive). Retype the password in the “Confirm New Password” field.

IMPORTANT: Be very careful when typing your password because the characters do not appear on the screen.

3. Press **Enter**. After setting the password, the computer sets the User Password parameter to “Set”.
4. If desired, you can opt to enable the Password on boot parameter.
5. When you are done, press F10 to save the changes and exit the BIOS Setup Utility.

Removing a Password

Follow these steps:

1. Use the ↑ and ↓ keys to highlight the Set Supervisor Password parameter and press the **Enter** key. The Set Password box appears:



Set Supervisor Password	
Enter Current Password	[██████████]
Enter New Password	[]
Confirm New Password	[]

2. Type the current password in the Enter Current Password field and press **Enter**.
3. Press **Enter** twice **without** typing anything in the Enter New Password and Confirm New Password fields. The computer then sets the Supervisor Password parameter to “Clear”.
4. When you have changed the settings, press u to save the changes and exit the BIOS Setup Utility.

Changing a Password

1. Use the ↑ and ↓ keys to highlight the Set Supervisor Password parameter and press the **Enter** key. The Set Password box appears.



Set Supervisor Password	
Enter Current Password	[██████████]
Enter New Password	[]
Confirm New Password	[]

2. Type the current password in the Enter Current Password field and press **Enter**.
3. Type a password in the Enter New Password field. Retype the password in the Confirm New Password field.
4. Press **Enter**. After setting the password, the computer sets the User Password parameter to “Set”.
5. If desired, you can enable the Password on boot parameter.
6. When you are done, press **F10** to save the changes and exit the BIOS Setup Utility.

If the verification is OK, the screen will display as following.



Setup Notice
Changes have been saved.
Continue

The password setting is complete after the user presses **Enter**.

If the current password entered does not match the actual current password, the screen will show you the Setup Warning.



Setup Warning
Invalid Password.
Continue

If the new password and confirm new password strings do not match, the screen displays the following message.



Setup Warning
Passwords do not match. Re-enter password.
Continue

Boot

This menu allows the user to decide the order of boot devices to load the operating system. Bootable devices includes the USB diskette drives, the onboard hard disk drive and the DVD drive in the module bay.

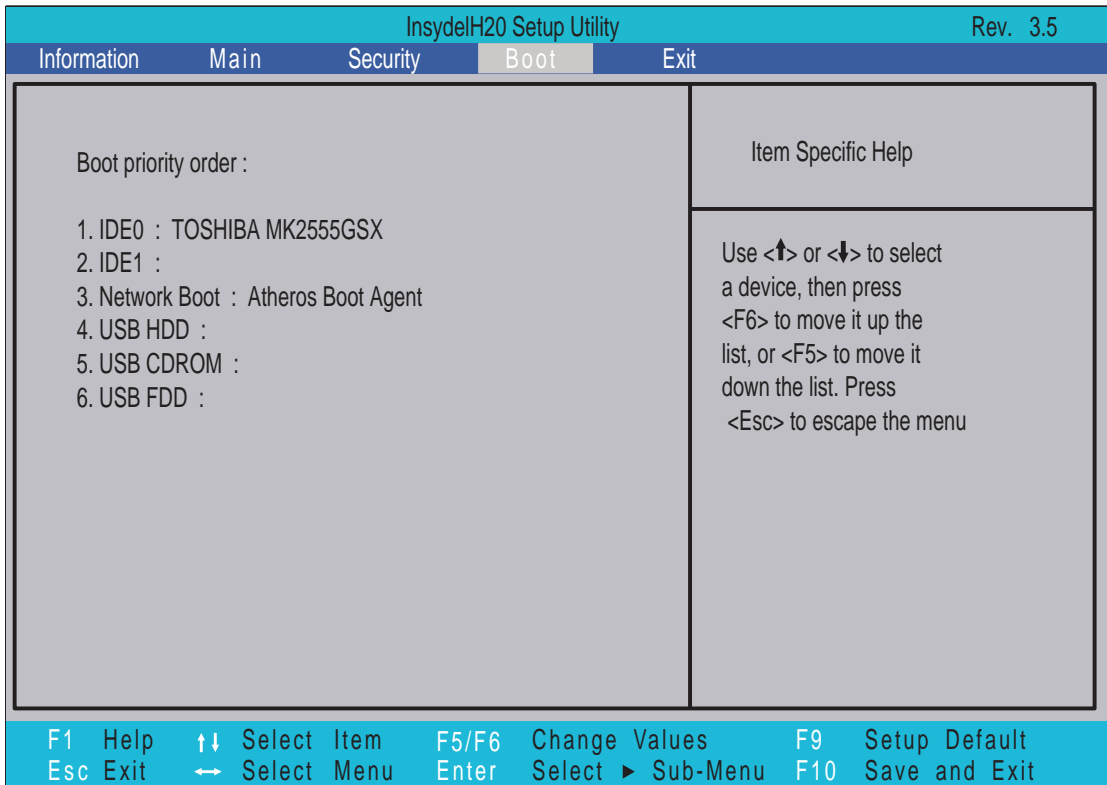

Follow the on-screen instructions to adjust the order in which the devices boot.

Exit

The Exit screen allows you to save or discard any changes you made and quit the BIOS Utility.

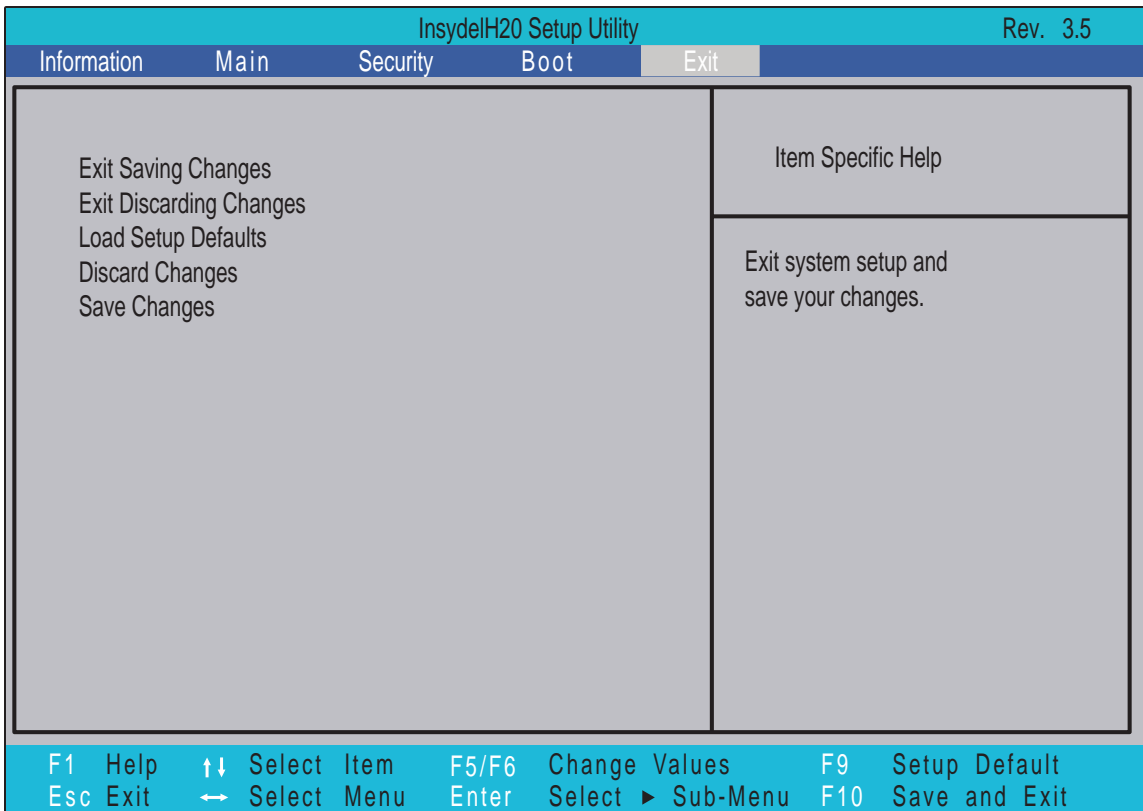

The table below describes the parameters in this screen.

Parameter	Description
Exit Saving Changes	Exit System Setup and save your changes to CMOS.
Exit Discarding Changes	Exit utility without saving setup data to CMOS.
Load Setup Default	Load default values for all SETUP item.
Discard Changes	Load previous values from CMOS for all SETUP items.
Save Changes	Save Setup Data to CMOS.

BIOS Flash Utility

The BIOS flash memory update is required for the following conditions:

- New versions of system programs
- New features or options
- Restore a BIOS when it becomes corrupted.

To run the BIOS flash utility:

1. Copy the BIOS flash tool and the BIOS into a USB flash disk.
2. Set the computer to boot from the USB flash disk. See “Boot” on page 29.
3. On boot-up enter at the DOS prompt:

C:\> flashit.exe v3106.fd /dc /beep:2000

DOS Flash Utility

Perform the following steps to use the DOS Flash Utility:

1. Press F2 during boot to enter the Setup Menu.
2. Select **Boot Menu** to modify the boot priority order, for example, if using USB HDD to Update BIOS, move USB HDD to position 1.

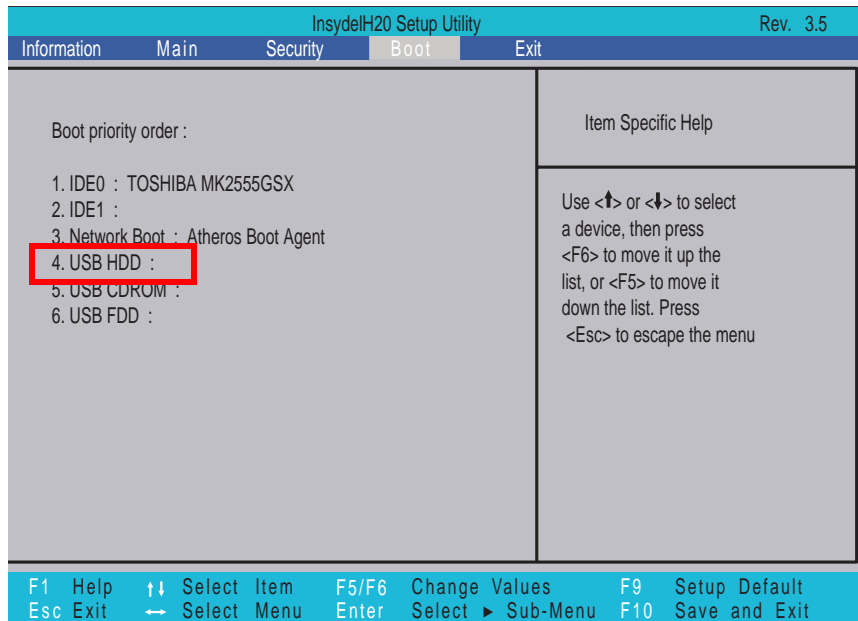

3. Execute the **FLASH.BAT** batch file to update BIOS.

The flash process begins as shown.



4. In flash BIOS, the message **Please do not remove AC Power Source** displays.

NOTE: If the AC power is not connected, the following message displays.



Plug in the AC power to continue.

5. Flash is complete when the message Flash programming complete displays.

WinFlash Utility

Perform the following steps to use the WinFlash Utility:

1. Put the BIOS:ZE8_v3106.fd file under WinFlash file root.

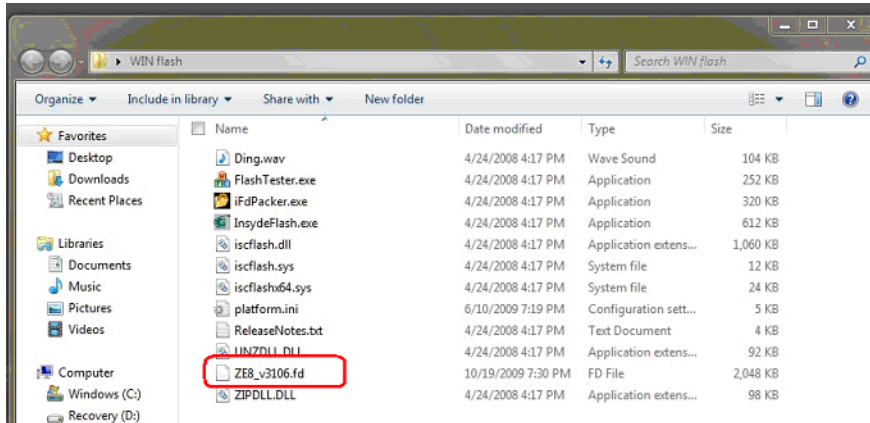

1. Double click the WinFlash executable.

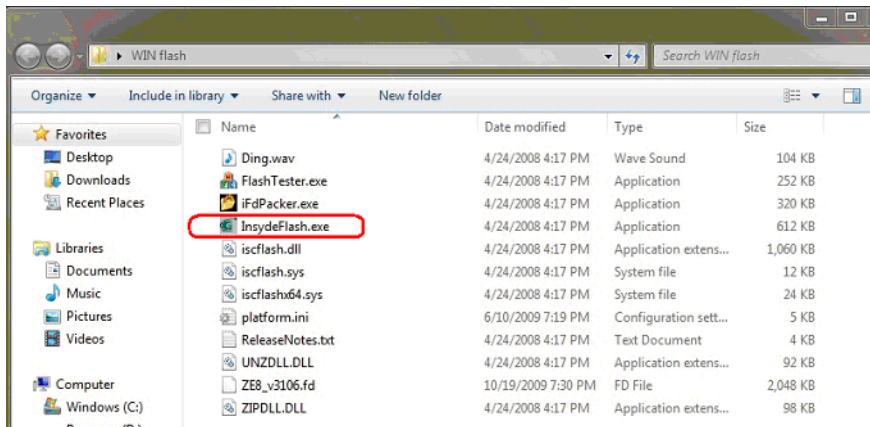

2. Click **OK** to begin the update. A progress screen displays.



3. When the process is complete, close all programs and applications and reboot the system.

Remove HDD/BIOS Password Utilities

This section provide you with removing HDD/BIOS method:

Remove HDD Password:

When the user keys in the wrong password three times, the system reports the following error code to user.

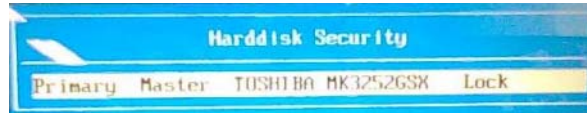

To unlock the HDD password, perform the following steps:

1. Press **Enter** to display the Select Item screen.

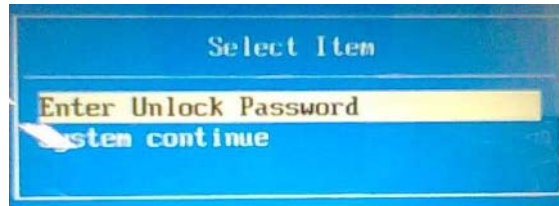

2. Select **Enter Unlock Password** and press **Enter**.

An Unlock Password displays.



3. Make a note of the key, **76943488** in the example.
4. Boot up the system to a removable bootable drive containing DOS and the UnlockHD.EXE program and open a DOS prompt. For instructions on changing boot priority see "Boot" on page 29.
5. Enter the **UnlockHD.EXE** command and input the key to create an unlock code. Make a note of the result, for example **46548274**.
6. Reboot to the hard disk and wait for the error code to reappear.
7. Press **Enter** to display the Select Item screen.
8. Select **Enter Unlock Password** and press **Enter**.
9. Enter the unlock code generated by UnlockHD.EXE.
10. Save and exit the BIOS to complete the process.

Removing BIOS Passwords:

If you key in the wrong Supervisor Password three times, System Disabled displays on the screen. See the image below.

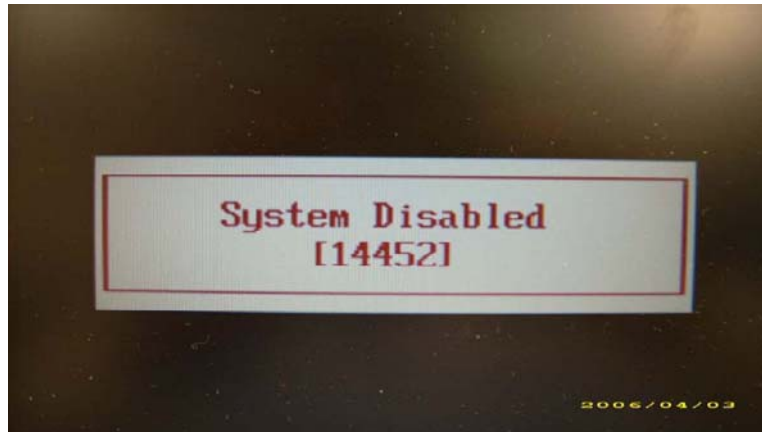

To reset the BIOS password, run clnpwd.exe as follows:

1. From a DOS prompt, Execute **clnpwd.exe**

```
d:\Clnpwd>clnpwd
ACER Clean Password Utility V1.00
Press 1 or 2 to clean any password shown as below
    1.User Password
    2.Supervisor Password

Clean User Password Successfully!
```

2. Press 1 or 2 to clean the desired password shown on the screen.

The onscreen message determines whether the function is successful or not.

Miscellaneous Utilities

Using Boot Sequence Selector

Boot Sequence Selector allows the boot order to be changes without accessing the BIOS. To use Boot Sequence Selector, perform the following steps:

1. Enter into DOS.
2. Execute BS.exe to display the usage screen.

```
d:\B00TSEQ>bs
*** Boot Sequence Selector Version 0.03 ***
Create by Rockwell Chuang 10/01/2005.
Usage:
      BS [ 1 | 2 | 3 | 4 ]
BS 1 : [ Floppy ] => [HardDisk] => [ CD-ROM ] => [ LAN   ]
BS 2 : [HardDisk] => [ CD-ROM ] => [ LAN   ] => [ Floppy ]
BS 3 : [ CD-ROM ] => [HardDisk] => [ LAN   ] => [ Floppy ]
BS 4 : [ LAN   ] => [ Floppy ] => [HardDisk] => [ CD-ROM ]
d:\B00TSEQ>
```

3. Select the desired boot sequence by entering the corresponding sequence, for example, enter BS2 to change the boot sequence to HDD|CD ROM|LAN|Floppy.

Using DMITools

The DMI (Desktop Management Interface) Tool copies BIOS information to eeprom to be used in the DMI pool for hardware management.

When the BIOS displays **Verifying DMI pool data** it is checking the table correlates with the hardware before sending to the operating system (Windows, etc.).

To update the DMI Pool, perform the following steps:

1. Enter into DOS.
2. Execute **dmitools.exe**. The following messages show dmitools usage:

```
*** Compal DMI String R/W Utility Ver1.40 for 2006/03/14 ***

Usage:

DMITOOLS [ /R | /WP | /WS | /WU ] [ STRING ]

[R]   : Read DMI Information from Memory
[WM]  : Write Manufacturer Name to EEPROM. (Max.= 16 characters)
[WP]  : Write Product Name to EEPROM.      (Max.= 16 characters)
[WS]  : Write Serial Number to EEPROM     (Max.= 22 characters)
[WU]  : Write UUID to EEPROM.              (Ignore String   )
[WA]  : Write Asset Tag to EEPROM.        (Max.= 32 characters)
```

IMPORTANT:The following write examples (2 to 5) require a system reboot to take effect

Example 1: Read DMI Information from Memory

Input:

```
dmitools /r
```

Output:

```
Manufacturer (Type1, Offset04h): Acer  
Product Name (Type1, Offset05h): Aspire one xxxxx  
Serial Number (Type1, Offset07h): 01234567890123456789  
UUID String (Type1, Offset08h): xxxxxxxx-xxxx-xxxx-xxxx-xxxxxxxxxxxx  
Asset Tag (Type3, Offset04h): Acer Asstag
```

Example 2: Write Product Name to EEPROM

Input:

```
dmitools /wp Acer
```

Example 3: Write Serial Number to EEPROM

Input:

```
dmitools /ws 01234567890123456789
```

Example 4: Write UUID to EEPROM

Input:

```
dmitools /wu
```

Example 5: Write Asset Tag to EEPROM

Input:

```
dmitools /wa Acer Asstag
```

Using the LAN MAC Utility

Perform the following steps to write MAC information to eeprom:

1. Use a text editor, for example Notepad, to edit the MAC.CFG file as shown:

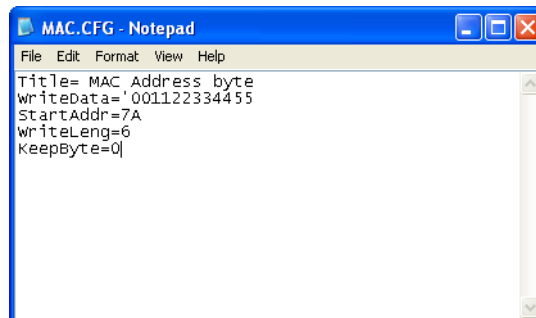

- WriteData= '001122334455' <----- MAC value
 - StartAddr=7A <----- MAC address
 - WriteLeng=6 <----- MAC value length
 - KeepByte=0 <----- can be any value
2. Boot into DOS.
 3. Execute **MAC.BAT** to write MAC information to eeprom.

Machine Disassembly and Replacement

This chapter contains step-by-step procedures on how to disassemble the notebook computer for maintenance and troubleshooting.

Disassembly Requirements

To disassemble the computer, you need the following tools:

- Wrist grounding strap and conductive mat for preventing electrostatic discharge
- Flat screwdriver
- Philips screwdriver
- Plastic flat screwdriver
- Plastic tweezers

NOTE: The screws for the different components vary in size. During the disassembly process, group the screws with the corresponding components to avoid mismatch when putting back the components.

Related Information

The product previews seen in the disassembly procedures may not represent the final product color or configuration.

IMPORTANT: Cable paths and positioning may not represent the actual model. During the removal and replacement of components, ensure all available cable channels and clips are used and that the cables are replaced in the same position.

General Information

Pre-disassembly Instructions

Before proceeding with the disassembly procedure, make sure that you do the following:

1. Turn off the power to the system and all peripherals.
2. Unplug the AC adapter and all power and signal cables from the system.



3. Place the system on a flat, stable surface.
4. Remove the battery pack.

Disassembly Process

The disassembly process is divided into the following sections:

- External components disassembly
- Main unit disassembly
- LCD module disassembly

The flowcharts provided in the succeeding disassembly sections illustrate the entire disassembly sequence. Observe the order of the sequence to avoid damage to any of the hardware components. For example, if you want to remove the Mainboard, you must first remove the Keyboard, and LCD Module then disassemble the inside assembly frame in that order.

Main Screw List

Screw	Quantity	Part Number
M2*2.5	11	86.TPK07.001
M2*3	9	86.ARE07.002
M2*3 (Nickel)	4	86.W0907.001
M2*4	7	86.W0107.003
M2*5	33	86.TG607.004

External Module Disassembly Process

NOTE: The product previews seen in the disassembly procedures may not represent the final product color or configuration.

External Modules Disassembly Flowchart

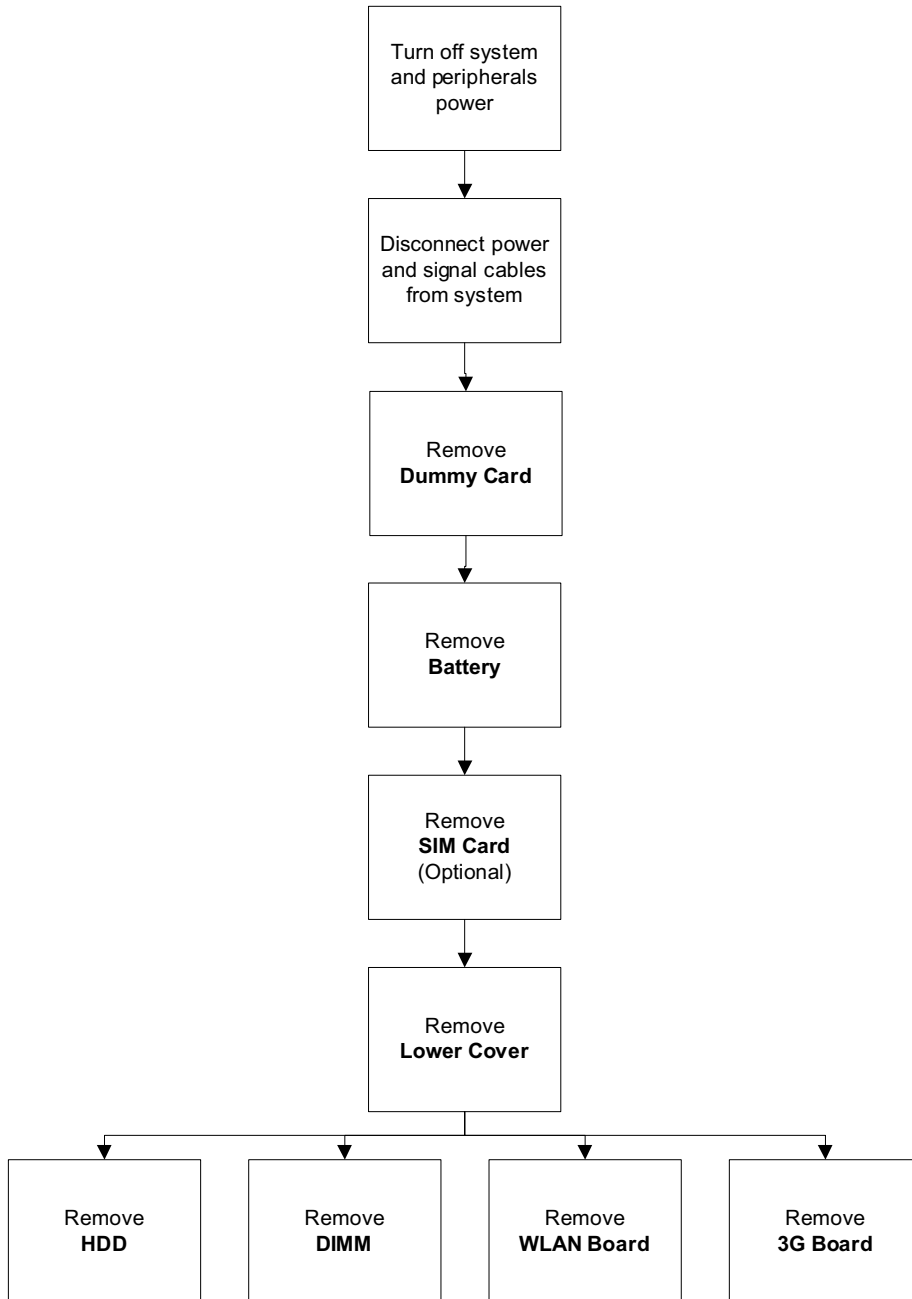

Screw List

Step	Screw	Quantity	Part No.
WLAN	M2*3	1	86.ARE07.002
3G Module	M2*3	1	86.ARE07.002

Removing the Dummy Card

1. Press the card in to allow it to spring out.



2. Pull the dummy card out.



Removing the Battery Pack

1. Turn the computer over.
2. Slide the battery lock/unlock latch to the unlock position.



-
3. Slide and hold the battery release latch to the release position (1), grasp the battery edge closest to the release latch and pull the battery up and away (2).

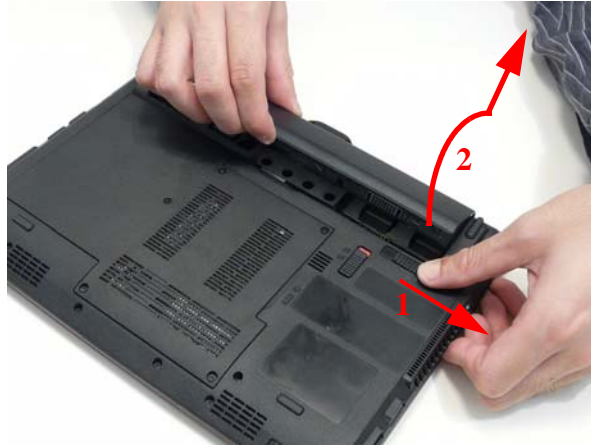

Removing the SIM Card

1. See "Removing the Battery Pack" on page 42.
2. Press the SIM card in to allow it to spring out.



3. Remove the SIM card.



Removing the Module Cover

1. See "Removing the Battery Pack" on page 42.
2. Loosen the five (5) captive screws.



3. Pry up the cover in the location indicated.

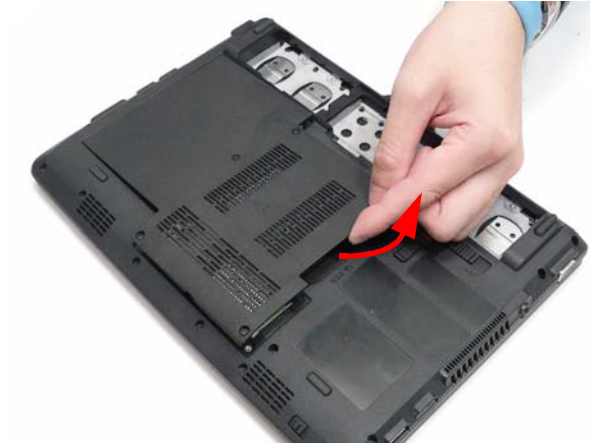

4. Lift the cover up and away.



Removing the Hard Disk Drive Module

1. See "Removing the Module Cover" on page 45.
2. Pry up the HDD FPC lock.

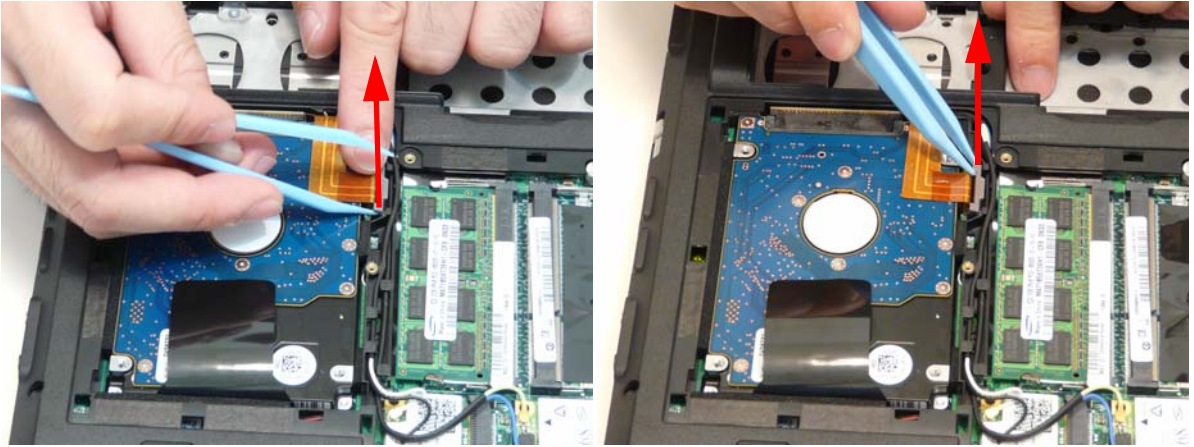

3. Lift out the HDD FPC.

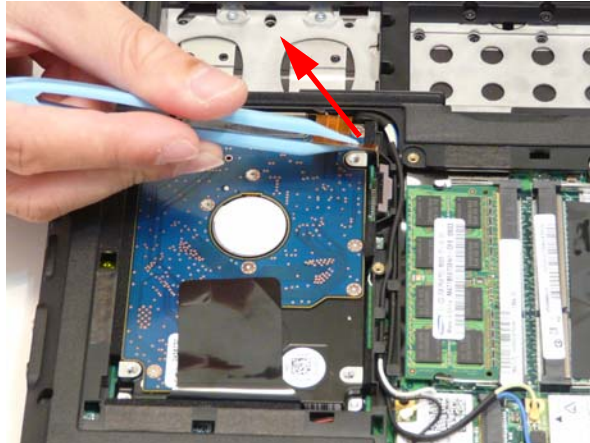

4. Peel the adhesive black tape off the HDD.



5. Grasp the black tape, pulling up the HDD.



6. Lift the HDD out of the bay.



7. Remove the HDD cable from the HDD.

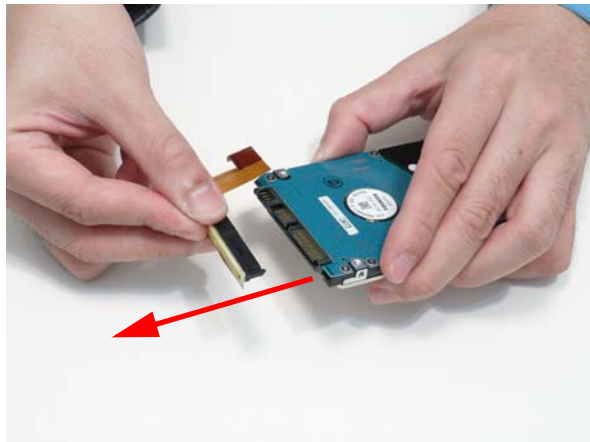

Removing the DIMM Module

1. See “Removing the Battery Pack” on page 42.
2. See “Removing the Module Cover” on page 45.
3. Push out the release latches on both sides of the DIMM socket to release the DIMM module.

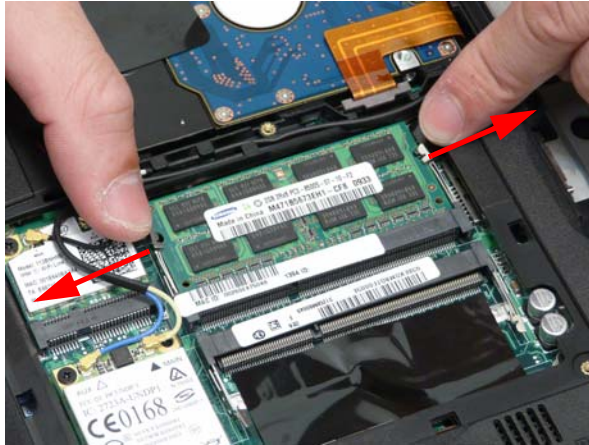

4. Lift the DIMM module out.

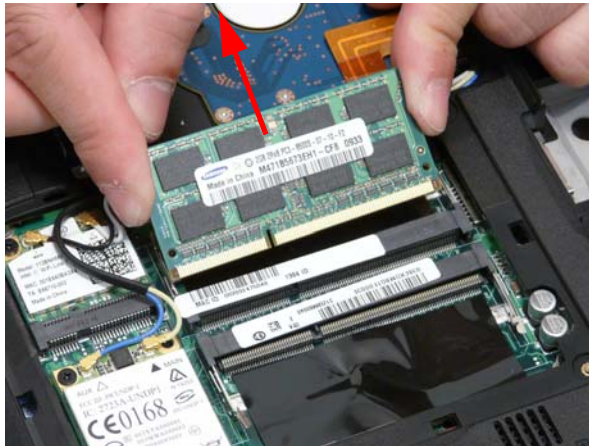

5. Repeat steps 3 and 4 for any remaining DIMM modules.

Removing the WLAN Board

1. See "Removing the Battery Pack" on page 42.
2. See "Removing the Module Cover" on page 45.
3. Detach the two (2) cables.



4. Remove the one (1) screw.



Step	Screw	Quantity	Screw Type.
WLAN	M2*3	1	

5. Remove the WLAN board.



Removing the 3G Module

1. See “Removing the Battery Pack” on page 42.
2. See “Removing the Module Cover” on page 45.
3. Detach the two cables.



4. Remove the one (1) screw.



Step	Screw	Quantity	Screw Type.
3G Module	M2*3	1	

5. Remove the 3G module.



Main Unit Disassembly Process

IMPORTANT: Cable paths and positioning may not represent the actual model. During the removal and replacement of components, ensure all available cable channels and clips are used and that the cables are replaced in the same position.

NOTE: The product previews seen in the disassembly procedures may not represent the final product color or configuration.

Main Unit Disassembly Flowchart

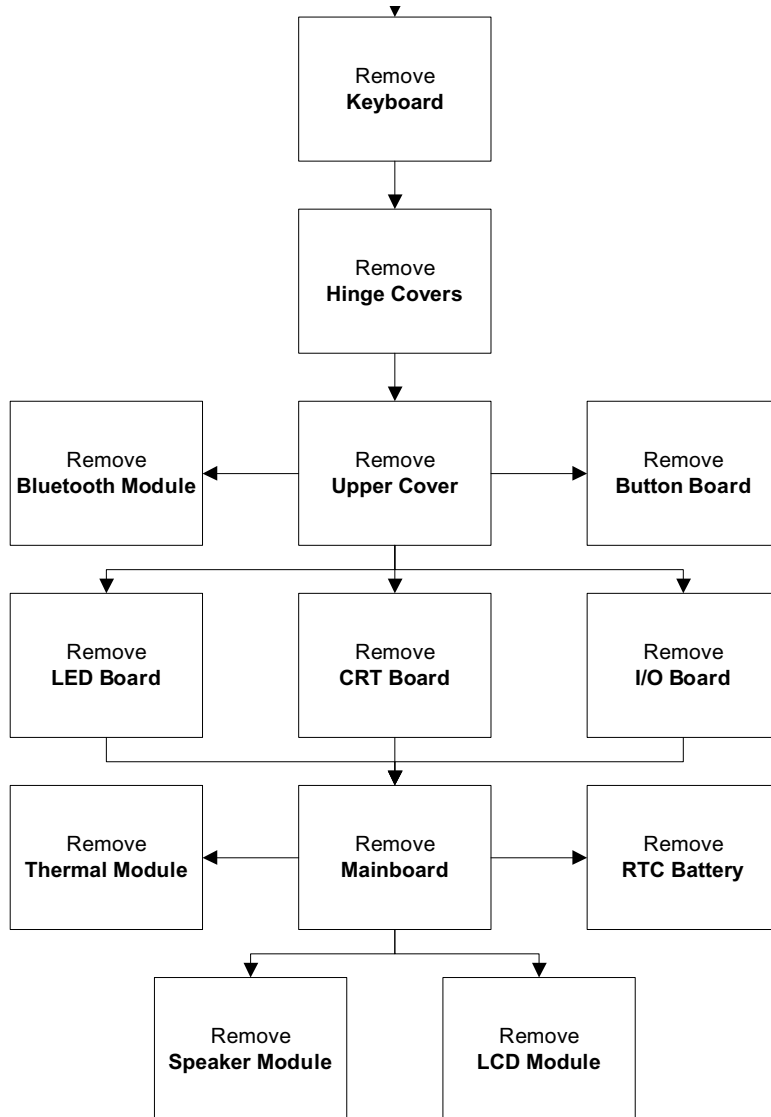

Screw List

Step	Screw	Quantity	Part No.
Lower Cover	M2*5	18	86.TG607.004
	M2*3 Ni	4	86.W0907.001

Step	Screw	Quantity	Part No.
Upper Cover	M2*5	6	86.TG607.004
	M2*2.5	3	86.TPK07.001
Hinge Cover	M2*5	2	86.TG607.004
Button Board	M2*3	2	86.ARE07.002
I/O Board	M2*5	1	86.TG607.004
LED Board	M2*5	2	86.TG607.004
CRT Board	M2*5	1	86.TG607.004
Mainboard	M2*5	2	86.TG607.004
Speaker	M2*3	2	86.ARE07.002
LCD Module	M2*5	2	86.TG607.004
	M2*3	3	86.ARE07.002

Removing the Keyboard

IMPORTANT: The keyboard is easily warped or damaged during the removal process. Take care not to use excessive force when removing the keyboard and replace if any damage occurs.

1. See "Removing the Dummy Card" on page 42.
2. Push in the four (4) latches on the top edge of the keyboard.



3. Lift the keyboard up and flip over.



4. Unlock the FPC.



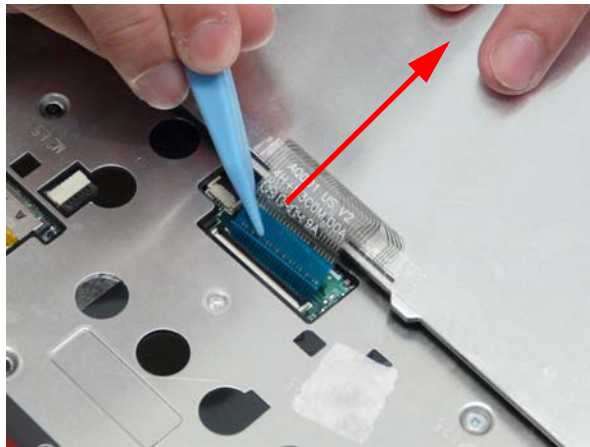

5. Remove the FPC and keyboard.

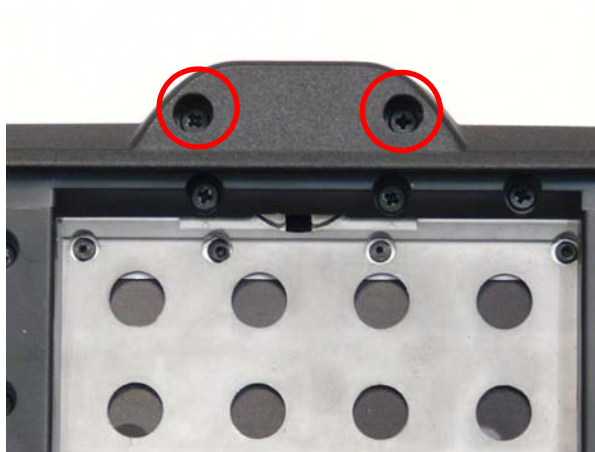

Removing the Hinge Covers

1. Remove the two (2) screws in the lower case.



Step	Screw	Quantity	Screw Type.
Hinge Cover	M2*5	2	

2. Remove the hinge bezel.



3. Loosen the hinge cap.



-
4. Partially open the LCD module.



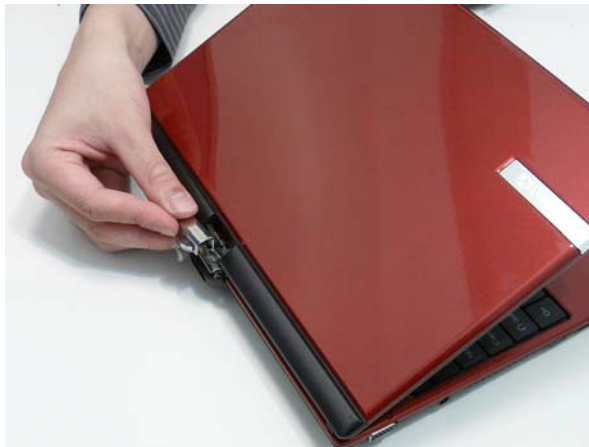

5. Remove the hinge cap.

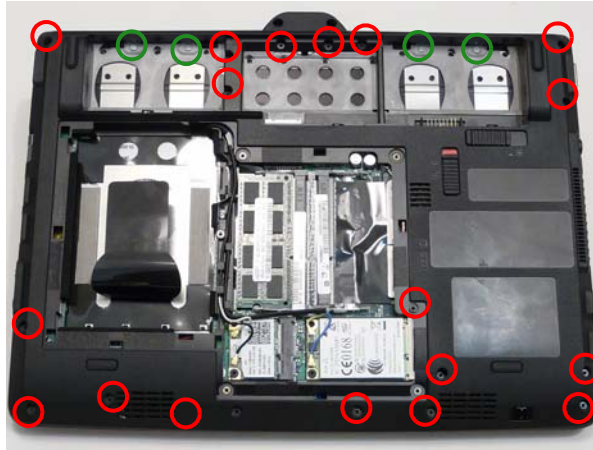

Removing the Upper Cover

1. See "Removing the Keyboard" on page 54.
2. See "Removing the Hinge Covers" on page 56.
3. Remove the twenty-two (22) screws in the lower cover.



Step	Screw	Quantity	Screw Type.
Lower Cover	M2*5 (Red Call Out)	18	
	M2*3 Nickel (Green Call Out)	4	

4. Turn the computer over and unlock the button board cable.

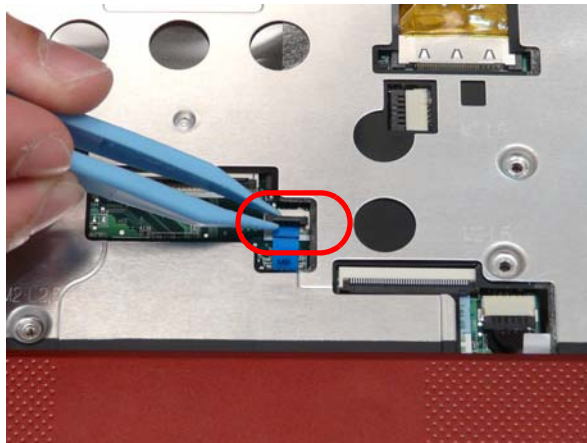

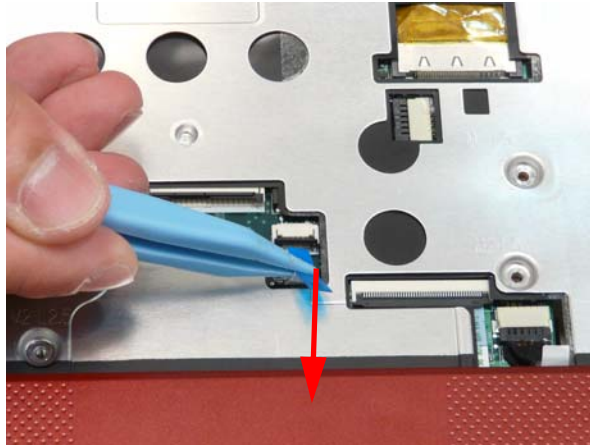

5. Disconnect the button board cable.



6. Remove the ten (10) screws in the upper cover.



Step	Screw	Quantity	Screw Type.
Upper Cover	M2*5 (Red Call Out)	6	
	M2*2.5 (Green Call Out)	3	

7. Pry the upper and lower covers apart at the location shown.



8. Hold the underside and pry the front side open.

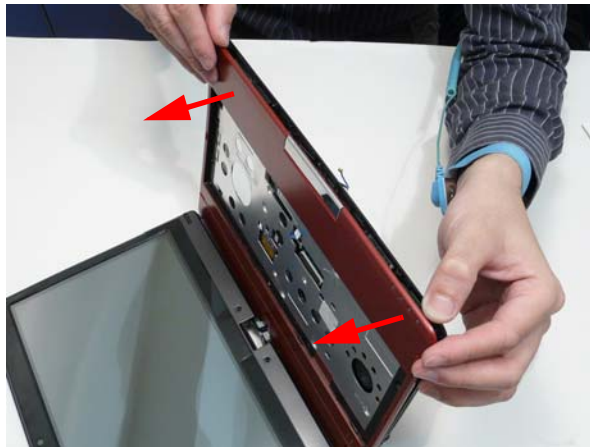

9. Hold the underside and pry the right side open.



WARNING:The cover is still connected to the Bluetooth module. Do not attempt to pull away.

10. Loosen the upper cover. Do not remove.



11. Reach under the upper cover to disconnect the Bluetooth cable from the mainboard.



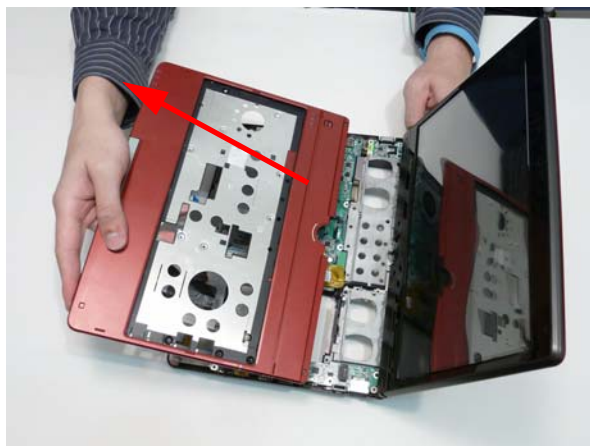

12. Remove the upper cover

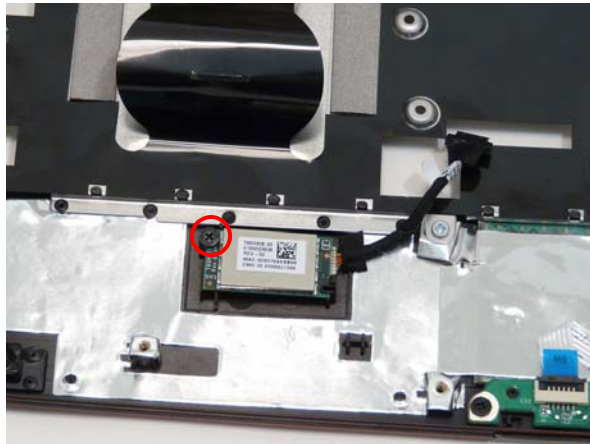

Removing the Bluetooth Module

1. Remove the one (1) screw.



Step	Screw	Quantity	Screw Type.
Bluetooth Module	M2*3	1	

2. Pry the Bluetooth module from the adhesive.

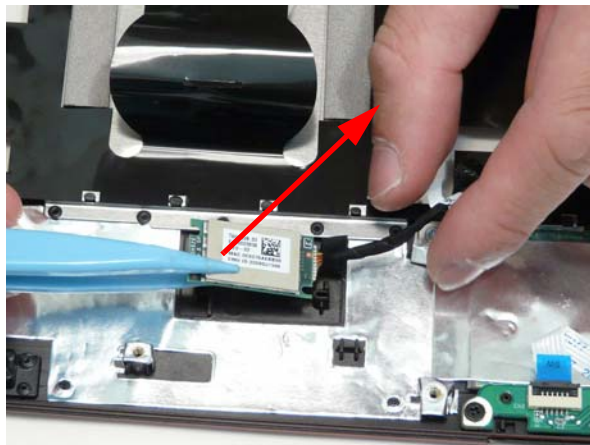

3. Remove the Bluetooth cable.

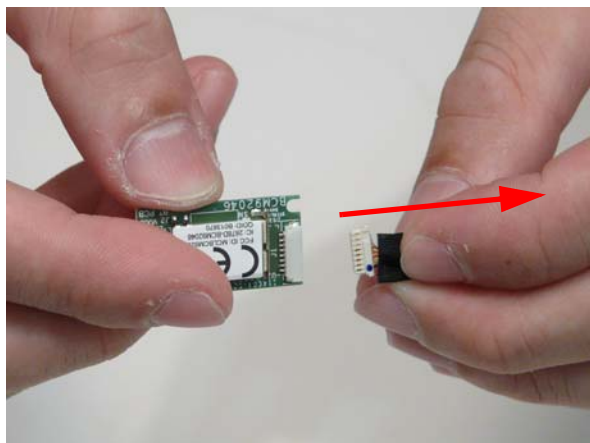

Removing the Button Board

IMPORTANT: The Touchpad Board cannot be removed individually. To replace the Touchpad Board, replace the entire Upper Cover.

1. See "Removing the Upper Cover" on page 58.
2. Unlock the button board cable.

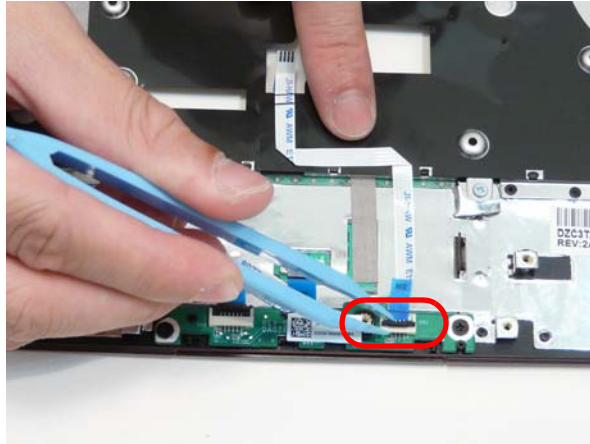

3. Disconnect the button board cable.

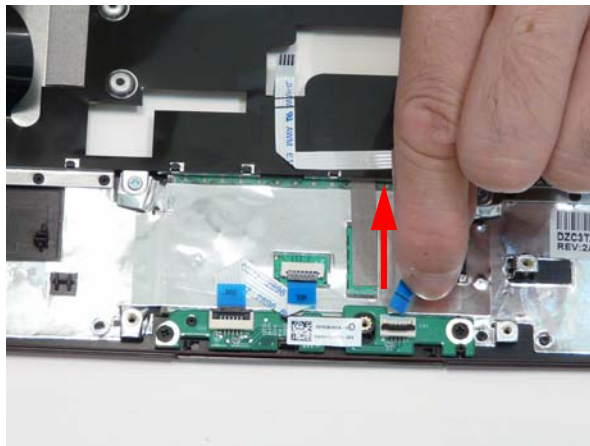

4. Pull the button board cable off the adhesive.

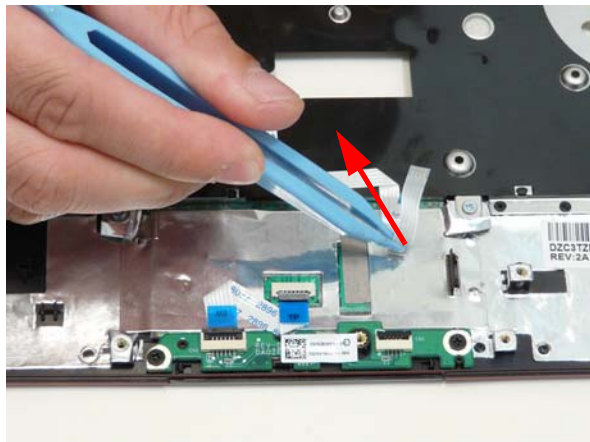

5. Remove the button board cable.

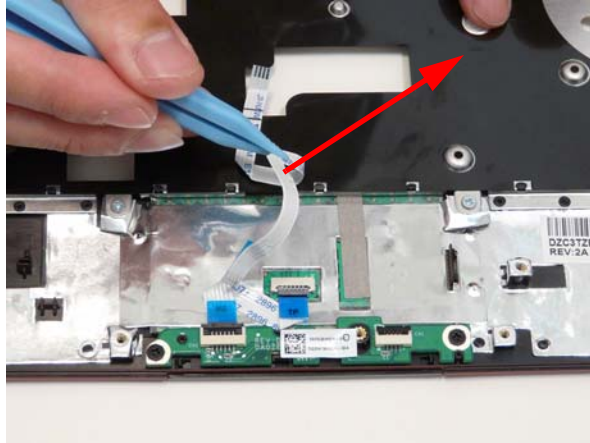

6. Unlock the touchpad cable from the button board.

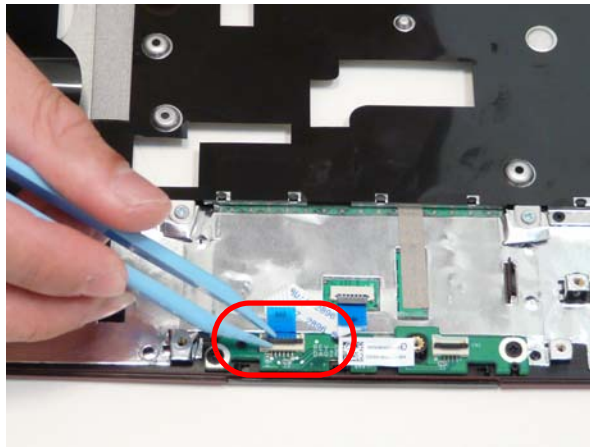

7. Disconnect the touchpad cable.

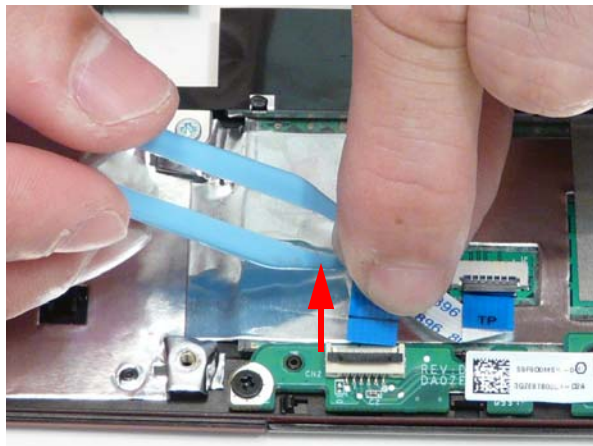

8. Pull the touchpad cable off the adhesive.

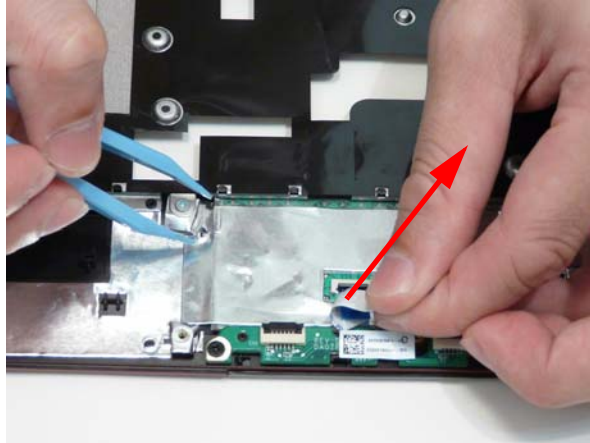

9. Unlock the touchpad cable from the touchpad.

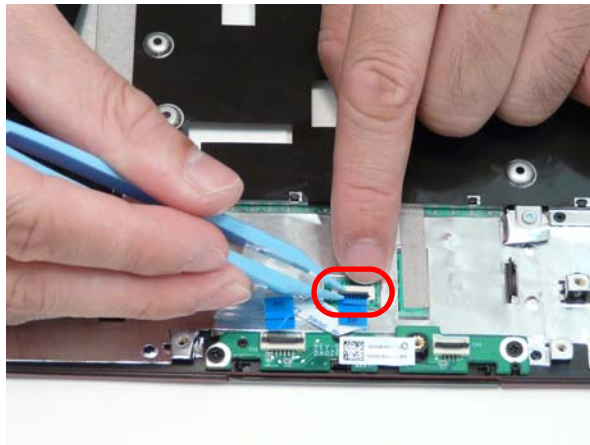

10. Remove the touchpad cable.

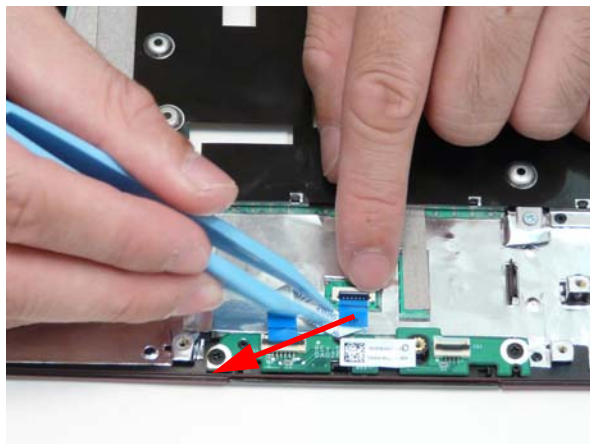

11. Remove the two (2) screws.

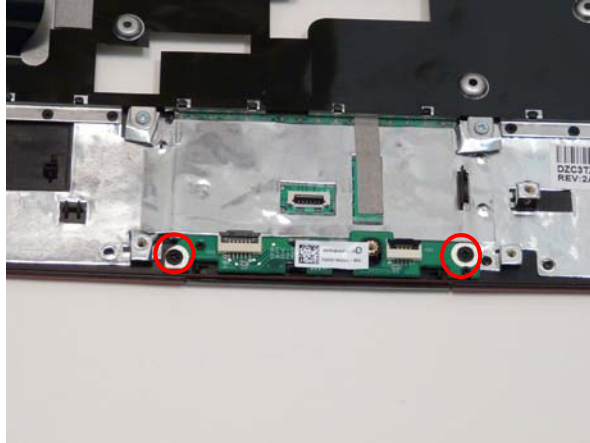

Step	Screw	Quantity	Screw Type.
Button Board	M2*3	2	

12. Remove the button board.

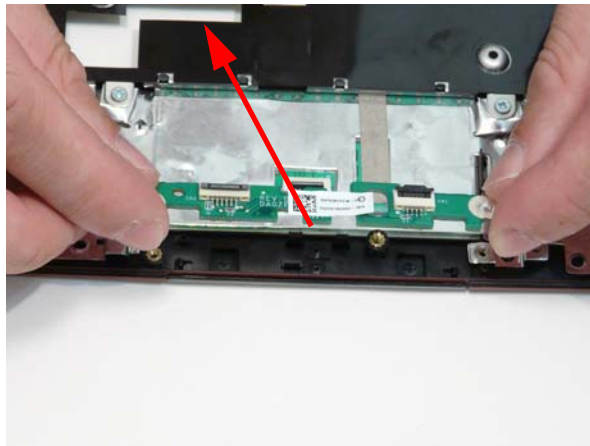

Removing the I/O Board

1. See "Removing the Upper Cover" on page 58.
2. Unlock the I/O cable I/O board connector.

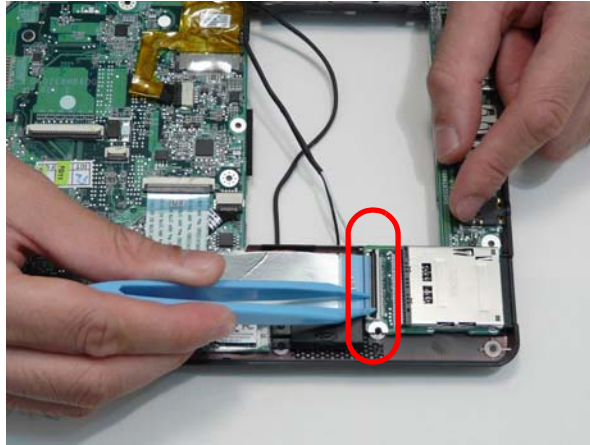

3. Disconnect the IO cable from the I/O board.

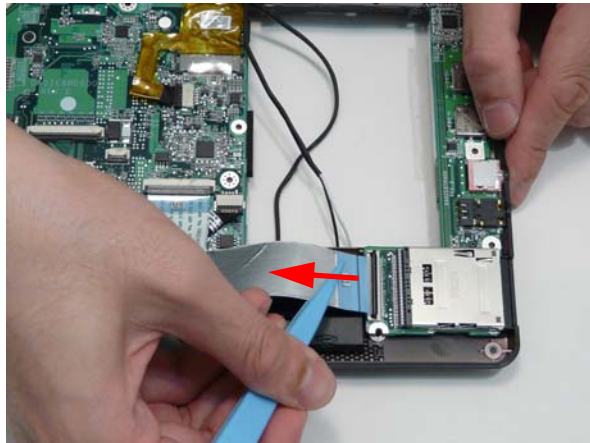

4. Unlock the I/O cable mainboard connector.

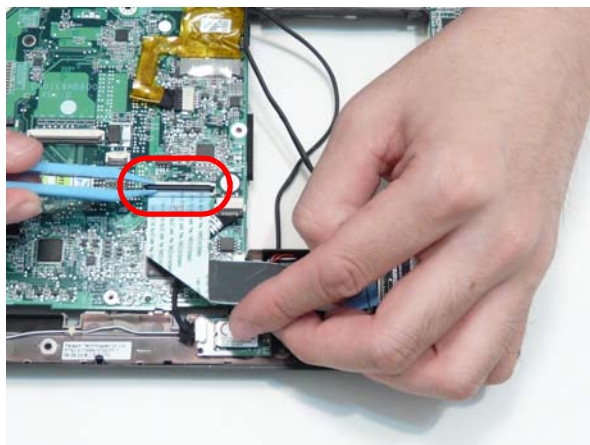

5. Remove the IO cable.

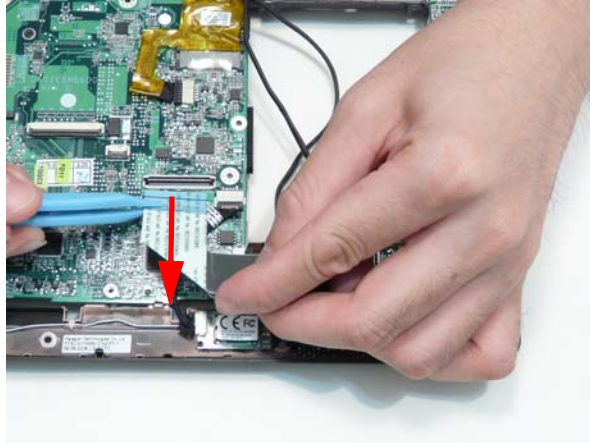

6. Turn the LCD module to expose the I/O board screw underneath.

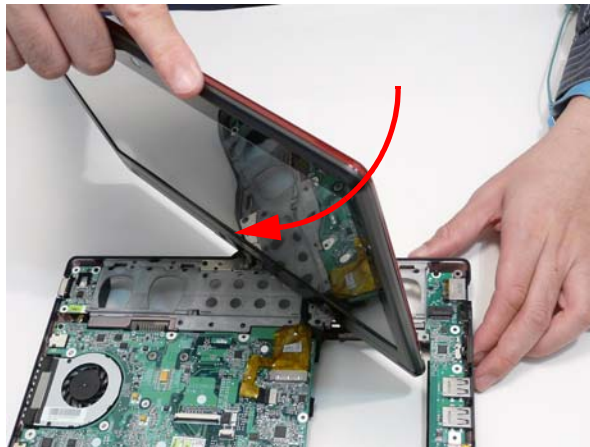

7. Remove the one (1) screw.

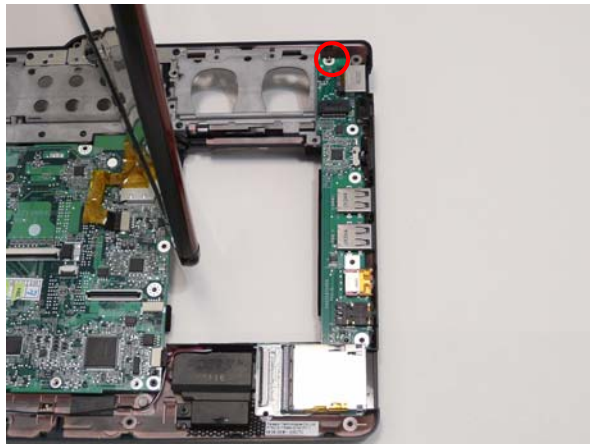

Step	Screw	Quantity	Screw Type.
I/O Board	M2*5	1	

8. Lift the inside edge of the I/O board and pull the I/O board away.

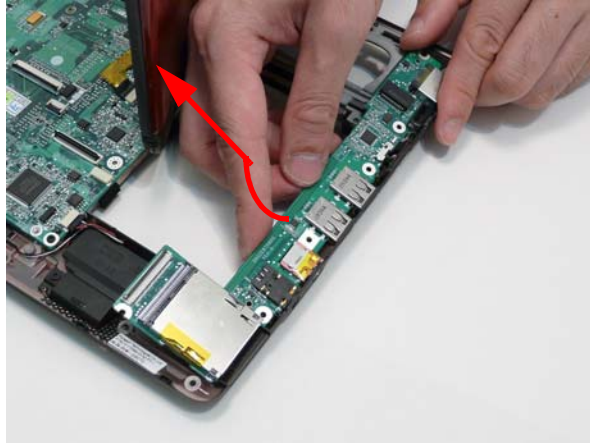

Removing the LED Board

1. See "Removing the Upper Cover" on page 58.
2. Unlock the LED cable LED board connector.

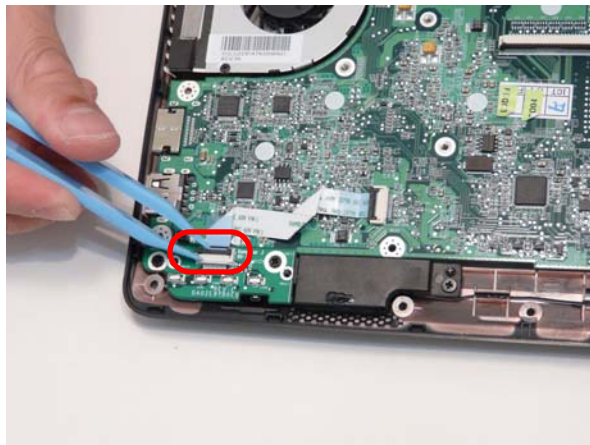

3. Disconnect the LED cable from the LED board connector.

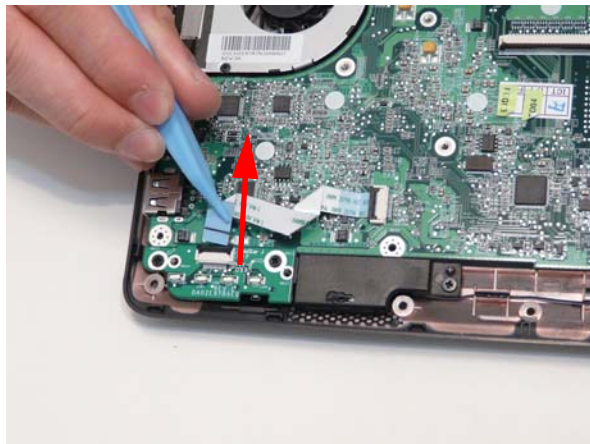

4. Unlock the LED cable mainboard connector.

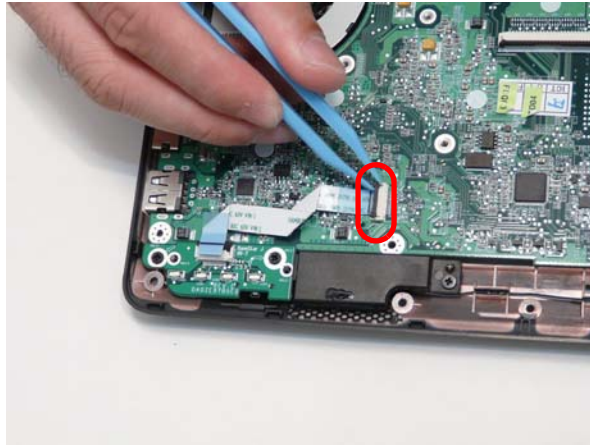

5. Remove the LED cable.

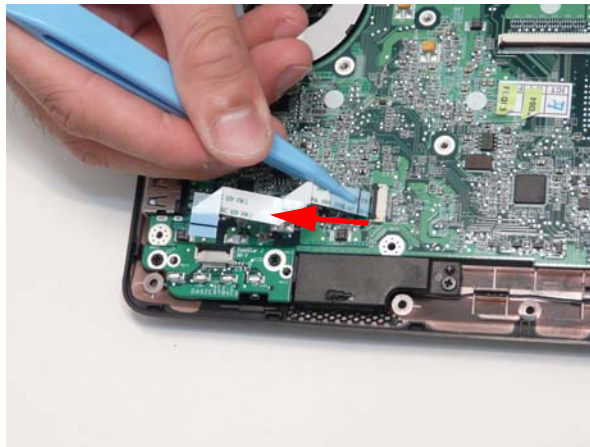

6. Remove the two (2) screws.

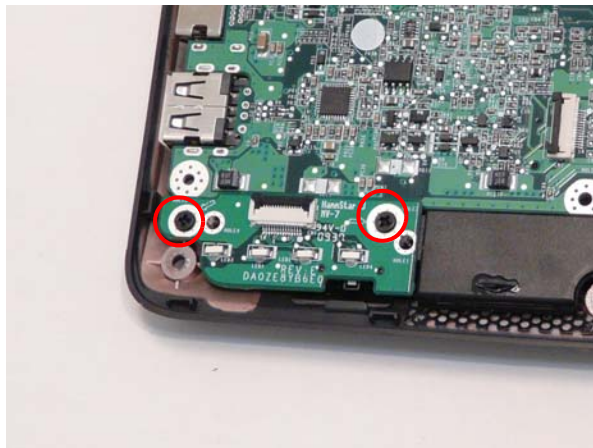

Step	Screw	Quantity	Screw Type.
LED Board	M2*5	2	

-
7. Remove the LED board.

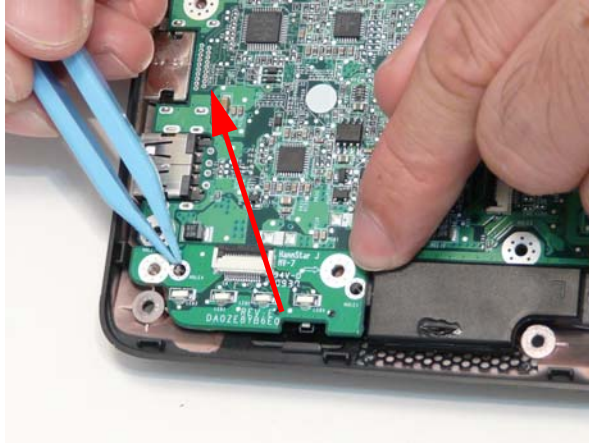

Removing the CRT Board

1. See “Removing the Upper Cover” on page 58.
2. Turn the LCD module to expose the CRT board.

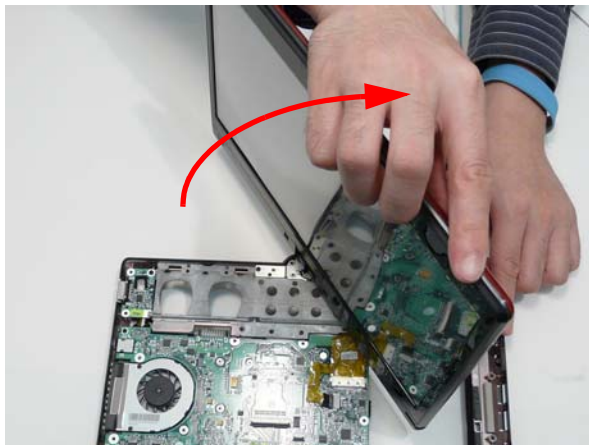

3. Remove the one (1) screw.



Step	Screw	Quantity	Screw Type
CRT Board	M2*5	1	

4. Lift the CRT board up one (1) centimeter (0.5 inch).

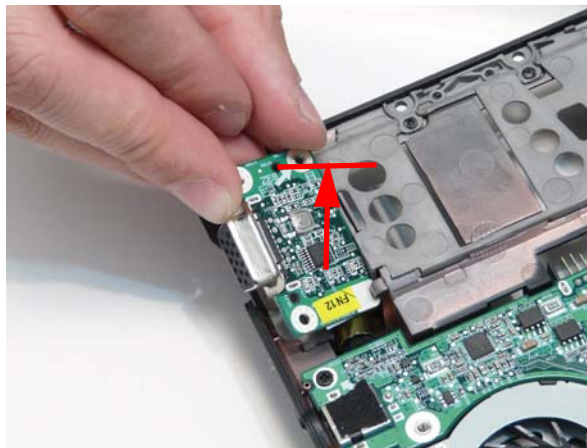

CAUTION: Do not lift too high and strain the cable and connector still attached.

5. Turn the CRT board over.

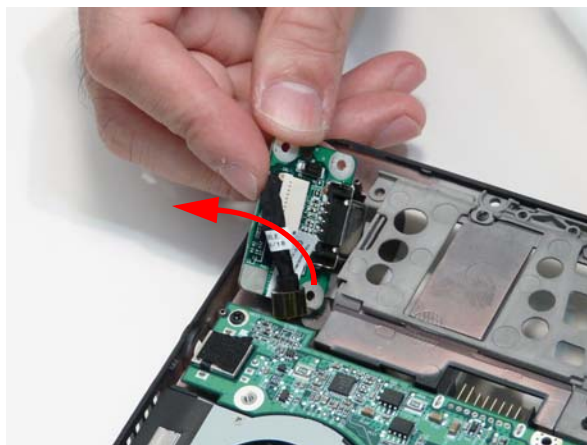

6. Remove the CRT cable.

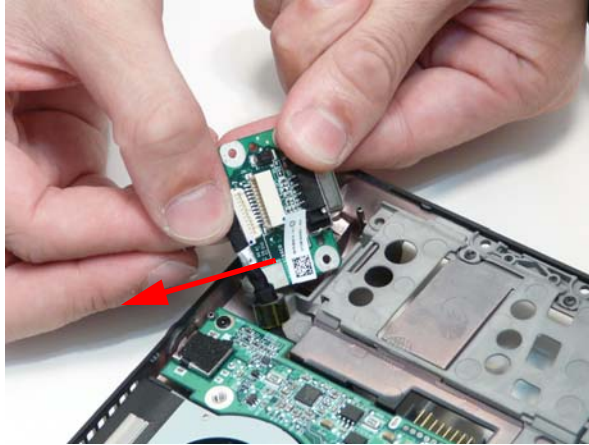

Removing the Mainboard

1. See "Removing the Upper Cover" on page 58.
2. See "Removing the I/O Board" on page 67.
3. See "Removing the LED Board" on page 69.
4. See "Removing the CRT Board" on page 71.
5. Remove the LCD connector cable clear protective cover.

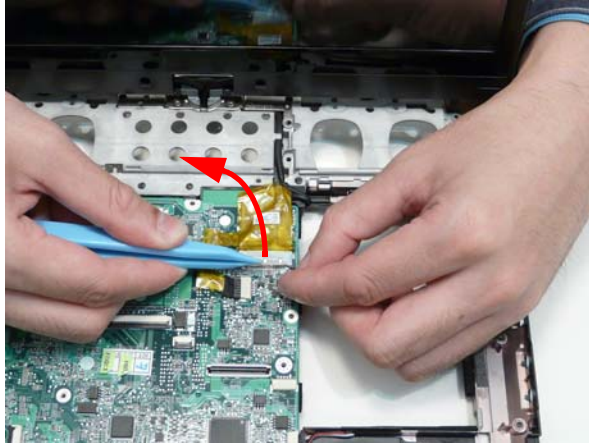

6. Disconnect the LCD cable.

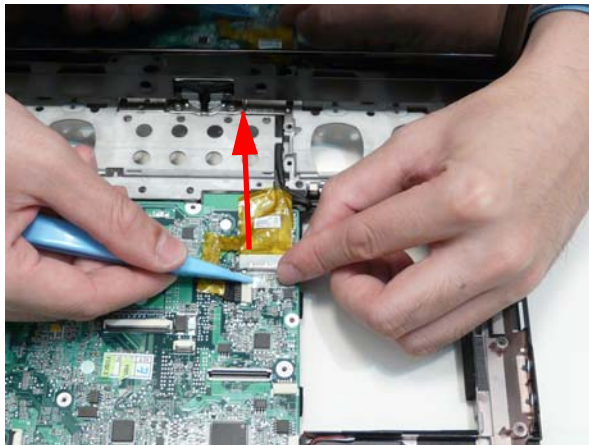

7. Disconnect the touchscreen cable.

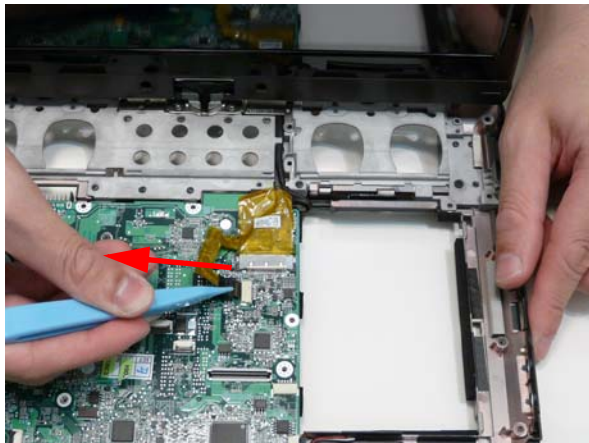

- Turn the computer over and remove the antenna cables from the retention guides, well clear of the mainboard.



- Turn the computer over and remove the antenna cables from the retention guides, well clear of the mainboard.

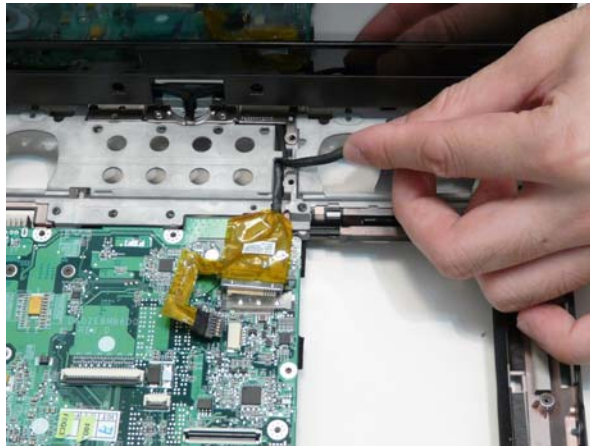

- Disconnect the speaker cable.

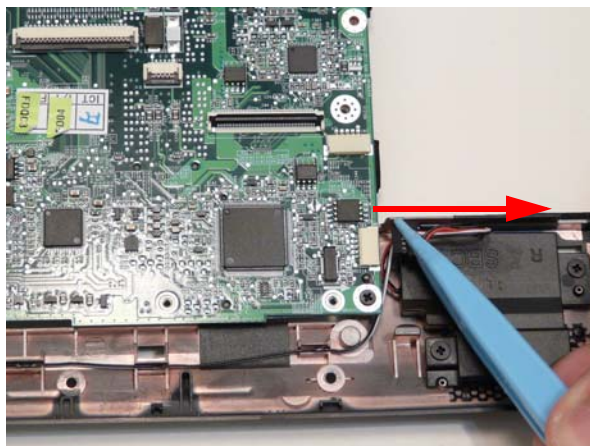

11. Remove the two (2) screws.



Step	Screw	Quantity	Screw Type.
Mainboard	M2*5	2	

12. Lift up the mainboard from the inside edge and pull away.



13. Remove the CRT cable.

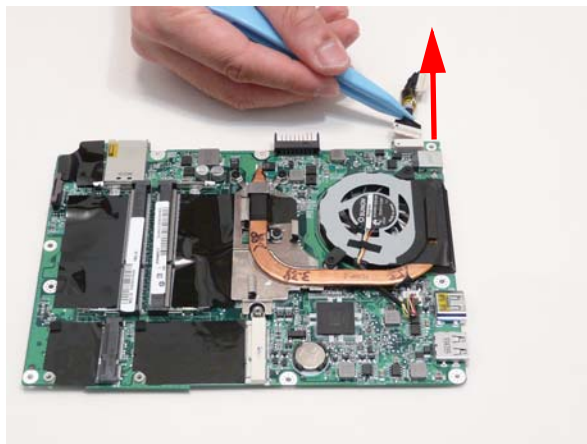

Removing the Thermal Module

1. See "Removing the Mainboard" on page 74.
2. Disconnect the thermal module cable.

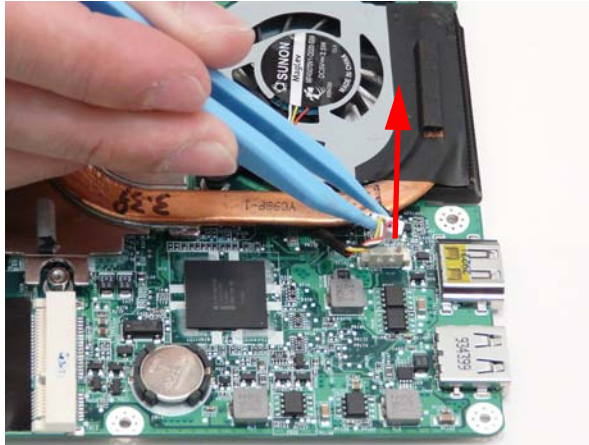

3. Loosen the five (5) captive screws. The three (3) captive screws for the CPU connection marked 1,2,3 must be loosened in reverse order: first 3, then 2, then 1.

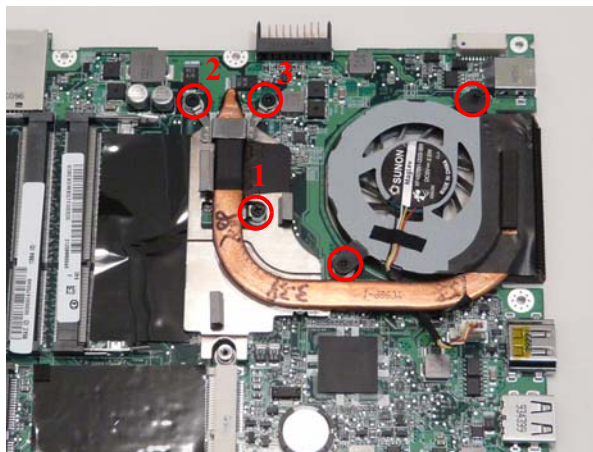

4. Remove the thermal module.

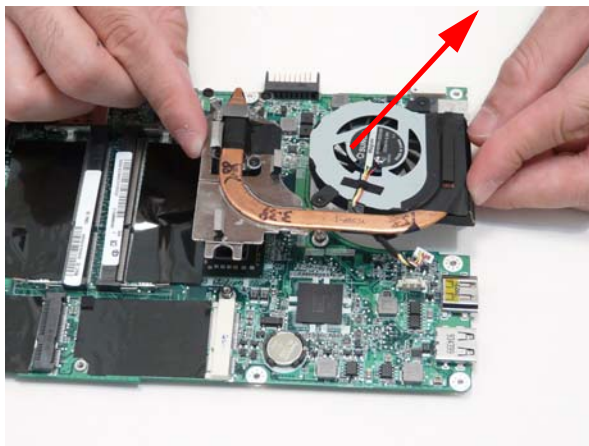

Removing the RTC Battery

1. See "Removing the Mainboard" on page 74.
2. Carefully lift the battery out of the mainboard.

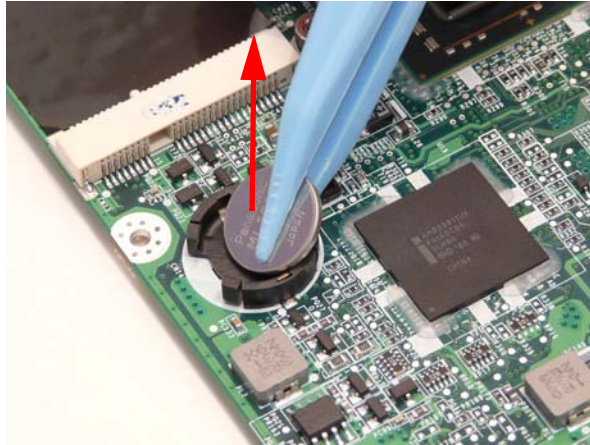

Removing the Speaker Modules

1. See "Removing the Mainboard" on page 74.
2. Remove the three (3) screws.

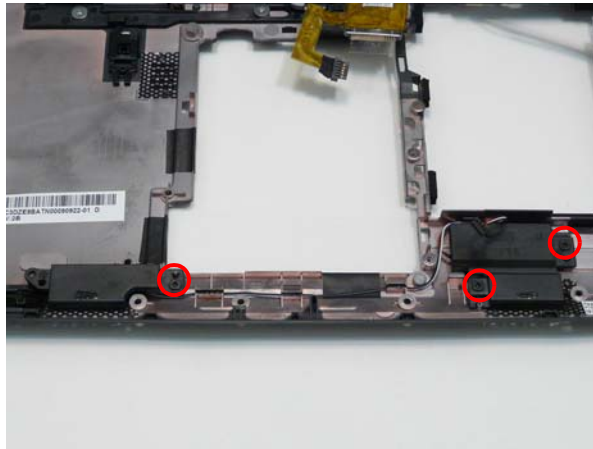

Step	Screw	Quantity	Screw Type.
Speaker	M2*3	3	

-
3. Grasp the speaker housings, pull the cables free of the adhesive, removing the speaker module.

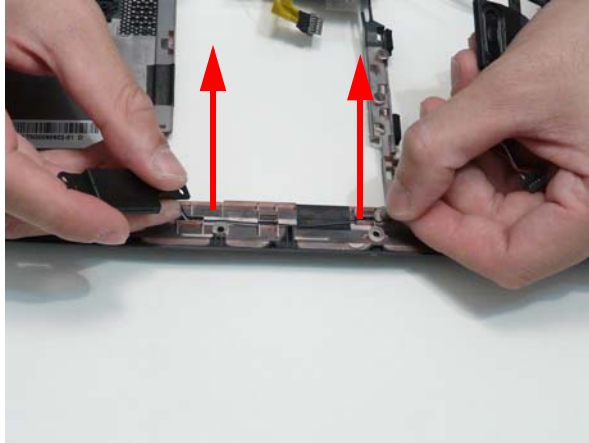

Removing the LCD Module

1. See "Removing the Mainboard" on page 74.
2. Remove the three (3) screws in lower case.



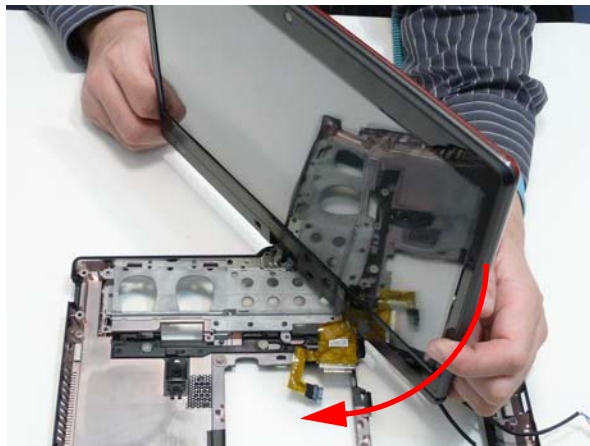

Step	Screw	Quantity	Screw Type
LCD Module	M2*3	3	

3. Open the LCD module and turn the LCD module ninety (90) degrees to expose the hinge.

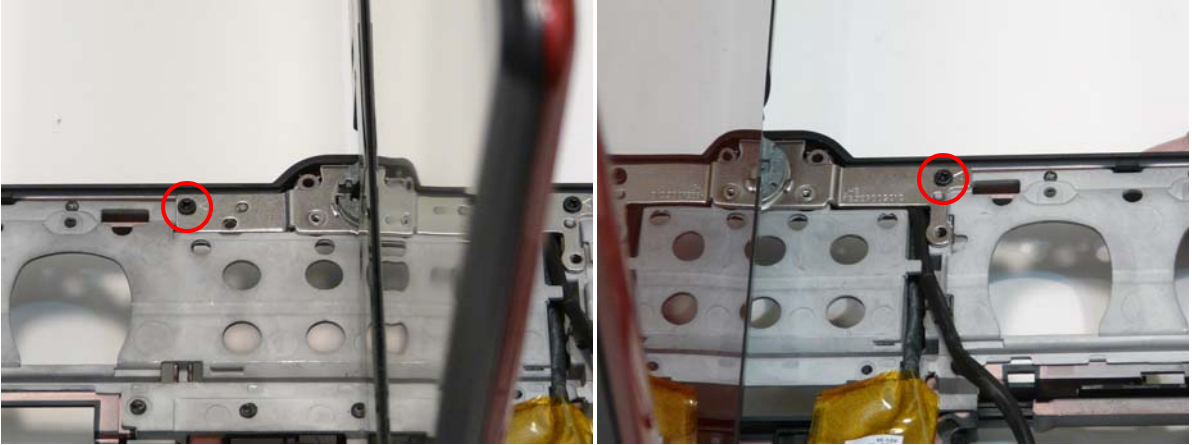

4. Remove the two (2) screws in the LCD module hinges.



Step	Screw	Quantity	Screw Type.
LCD Module	M2*5	2	

5. Lift the LCD module away from the chassis.

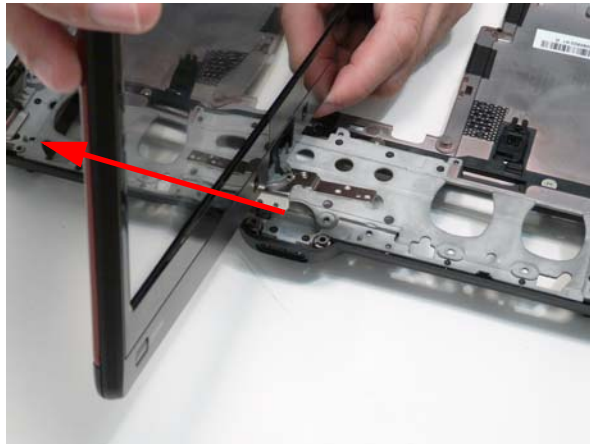

LCD Module Disassembly Process

IMPORTANT: Cable paths and positioning may not represent the actual model. During the removal and replacement of components, ensure all available cable channels and clips are used and that the cables are replaced in the same position.

NOTE: The product previews seen in the disassembly procedures may not represent the final product color or configuration.

LCD Module Disassembly Flowchart

IMPORTANT: See “Removing the LCD Module” on page 80. This details how the LCD module is removed from the Main Unit.

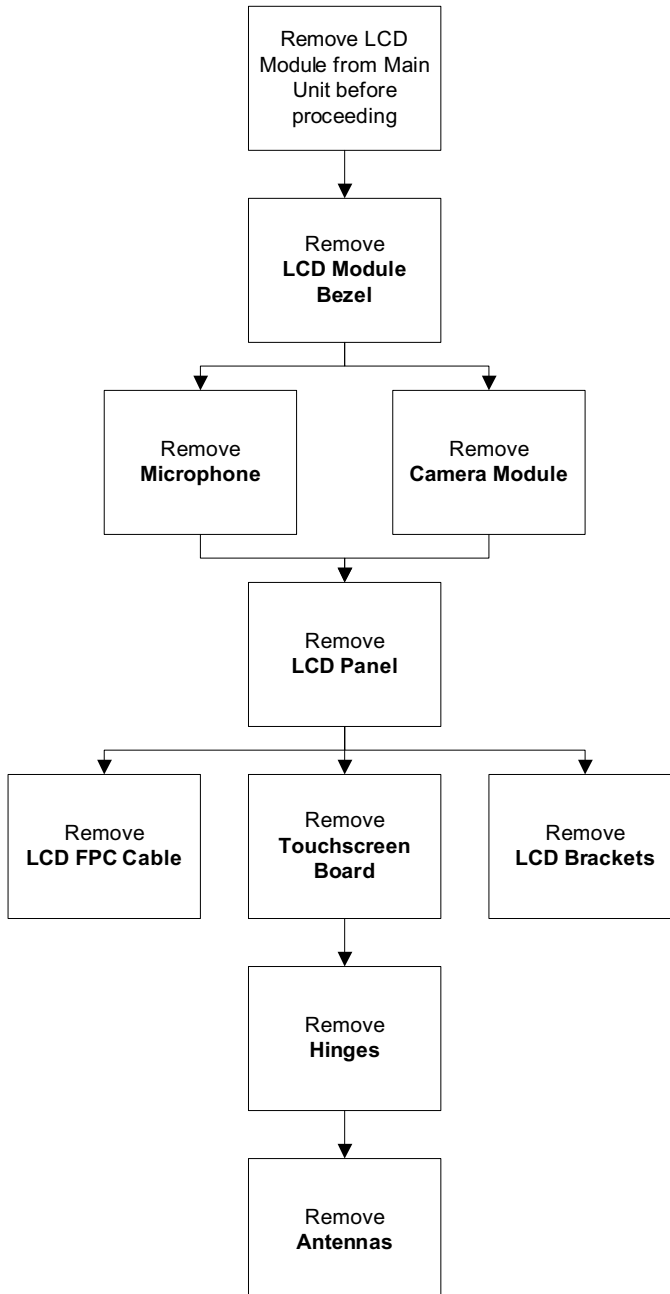

Screw List

Step	Screw	Quantity	Part No.
LCD Bezel	M2*5	2	86.TG607.004
LCD Panel	M2*4	4	86.W0107.003
LCD Brackets	M2*2.5	4	86.TPK07.001
Touchscreen Board	M2*4	3	86.W0107.003
Hinge	M2*5	3	86.TG607.004

Removing the LCD Bezel

1. See "Removing the LCD Module" on page 80.
2. Remove the stylus.

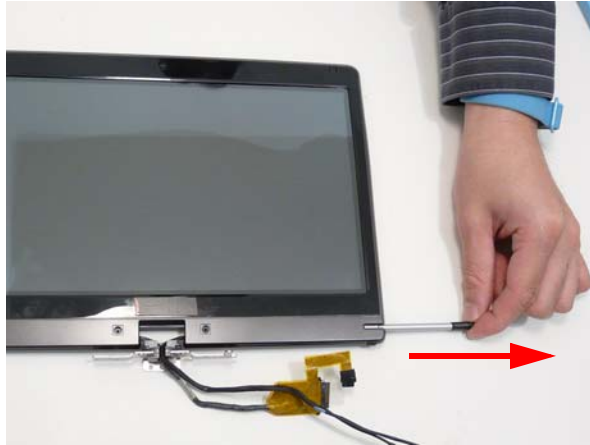

3. Remove the screw covers



4. Remove the two (2) screws.



Step	Screw	Quantity	Screw Type.
LCD Bezel	M2*5	2	

5. Pry up the bezel from the top edge.



6. Pry up the bezel sides.

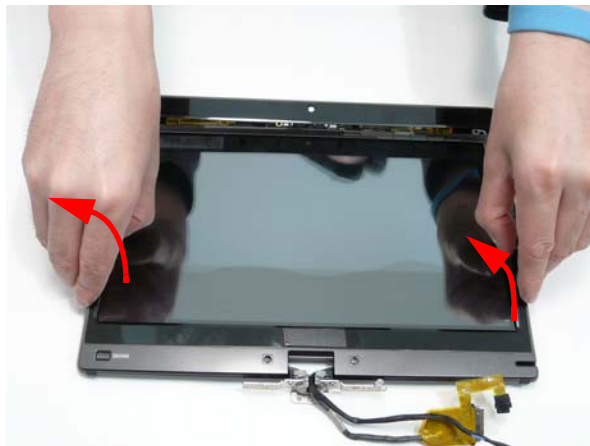

7. Pry up the bezel bottom edge.



8. Remove the bezel.

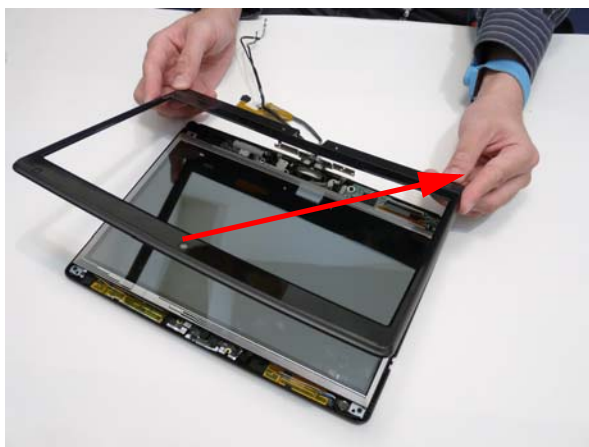

Removing the Camera Board

1. See "Removing the LCD Bezel" on page 84.
2. Pry up the camera board from the adhesive.

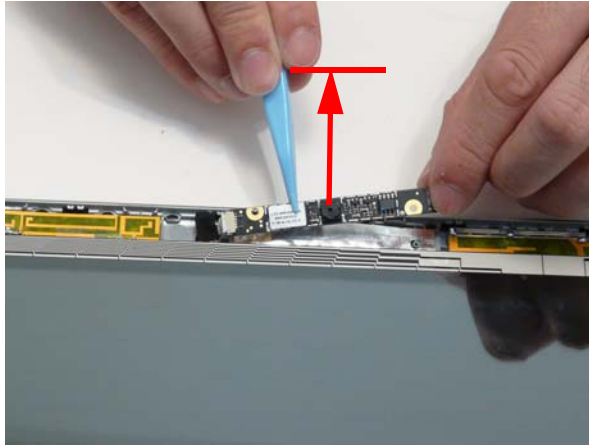

3. Disconnect the camera cable.

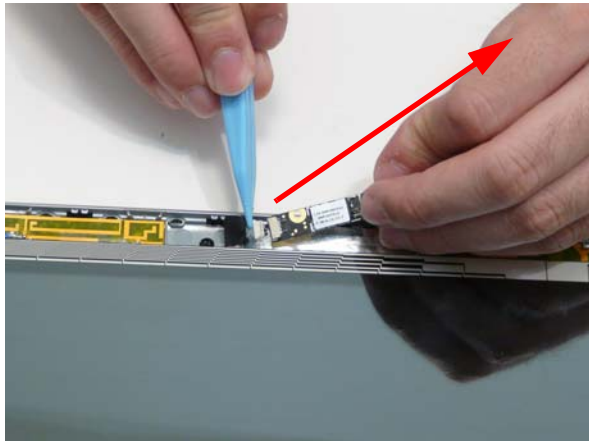

Removing the Microphone

1. See "Removing the LCD Bezel" on page 84.
2. Disconnect the microphone cable.



3. Pry up the microphone from the adhesive.

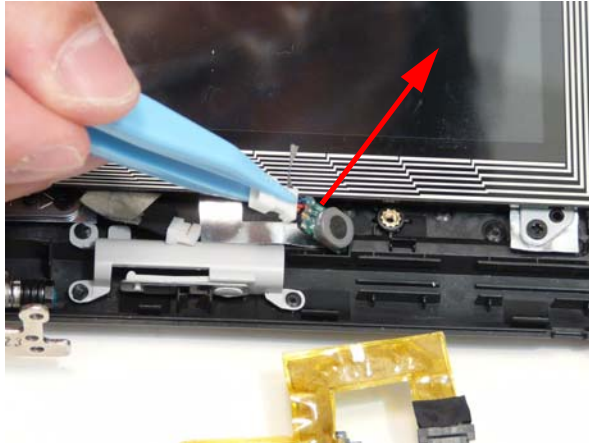

Removing the LCD Panel

1. See "Removing the Camera Board" on page 87.
2. See "Removing the Microphone" on page 88.

WARNING: The edges of the touchscreen surface are sharp and care should be taken when handling the panel.

3. Unlock the touchscreen FPC.



4. Remove the four (4) screws.



Step	Screw	Quantity	Screw Type.
LCD Panel	M2*4	4	

5. Lift the panel up a short distance from the top edge.



6. Disconnect the touchscreen cable.

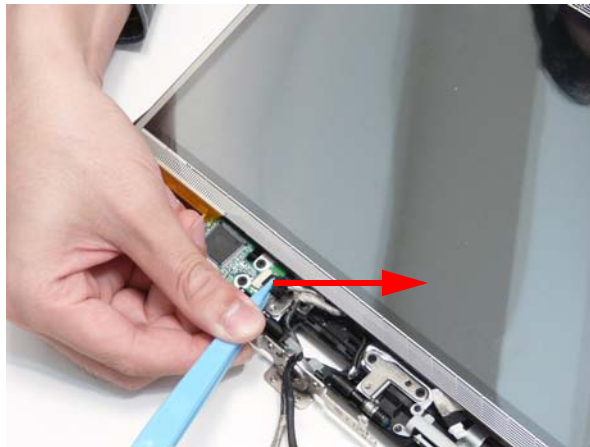

7. Lift up the panel (1) and disconnect the touchscreen FPC (2).



8. Remove the LCD cable from the retention guide hook, removing the panel.

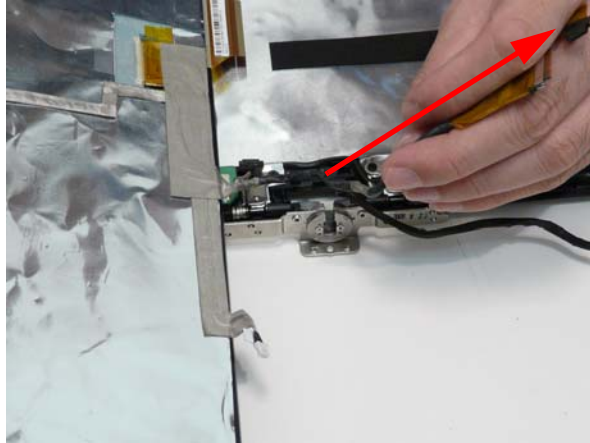

Removing the LCD Cable

1. See “Removing the Microphone” on page 88.
2. Turn the LCD panel face down on a dry clean soft surface.
3. Pull the camera cable from the adhesive.

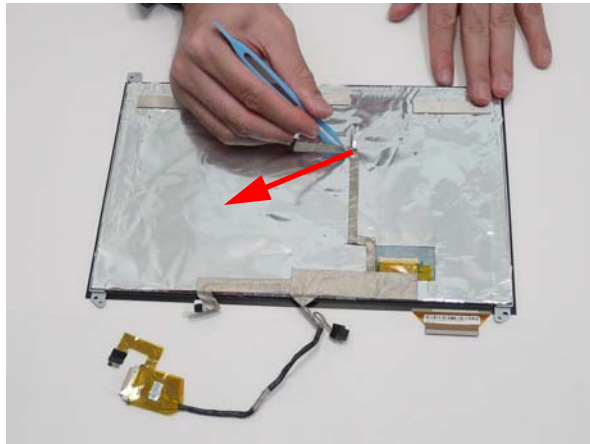

4. Lift up the LCD connector clear protective cover.

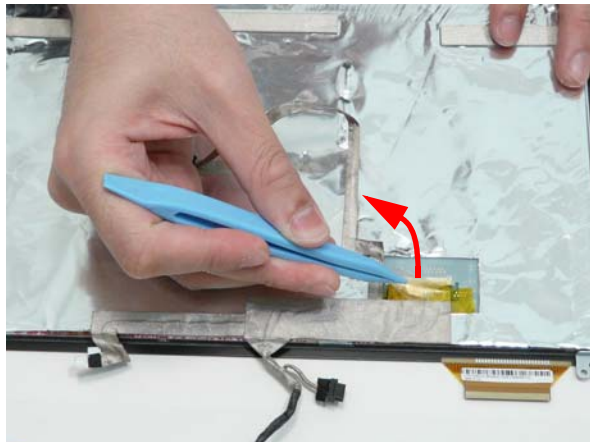

5. Disconnect the LCD connector.

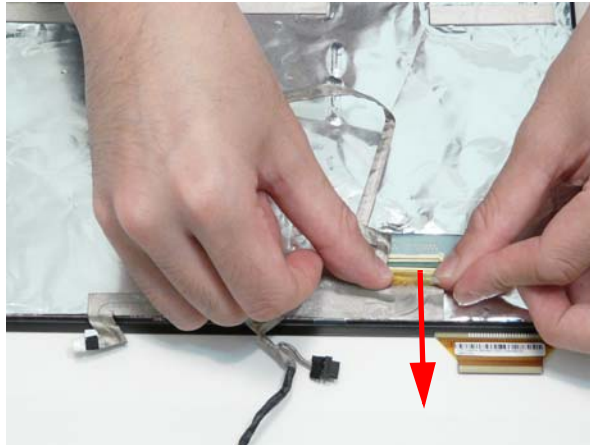

6. Pull up the LCD cable from the adhesive.

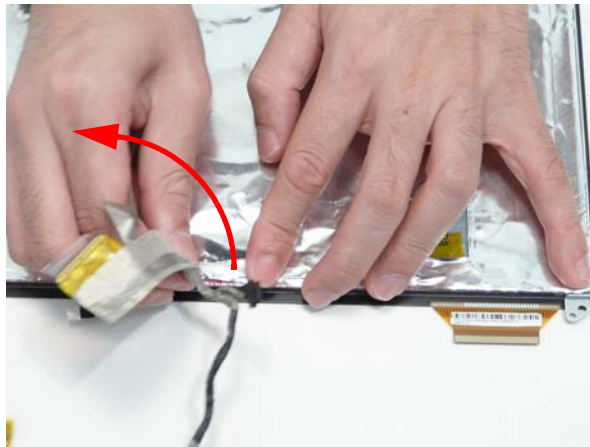



7. Pull the touchscreen cable from the adhesive.

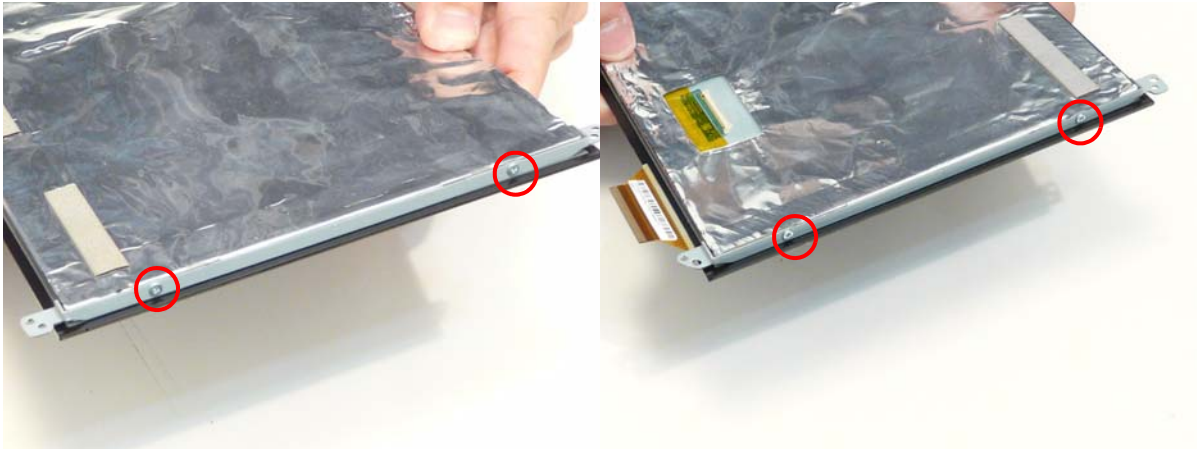

Removing the LCD Brackets

1. See "Removing the Microphone" on page 88.
2. Remove the four (4) screws from the left and right brackets.



Step	Screw	Quantity	Screw Type.
LCD Panel Brackets	M2*2.5	4	

3. Remove the brackets.



Removing the Touchscreen Board

1. See "Removing the LCD Panel" on page 89.
2. Remove the three (3) screws.

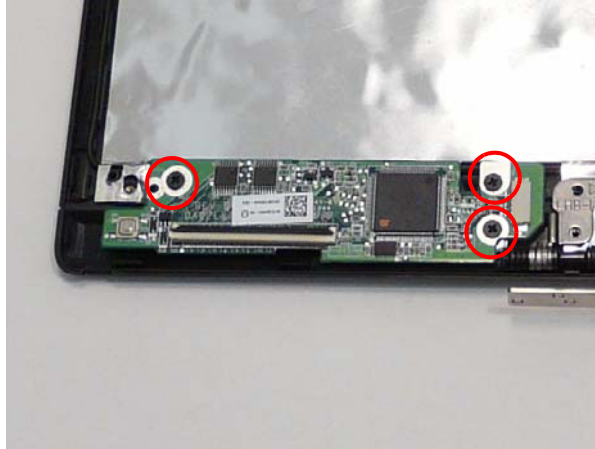

Step	Screw	Quantity	Screw Type.
Touchscreen Board	M2*4	3	

3. Remove the touchscreen board.

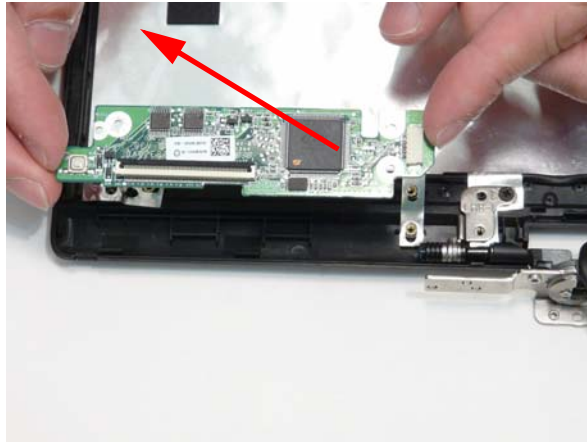

Removing the Hinge

1. See "Removing the LCD Panel" on page 89.
2. Remove the three (3) screws.

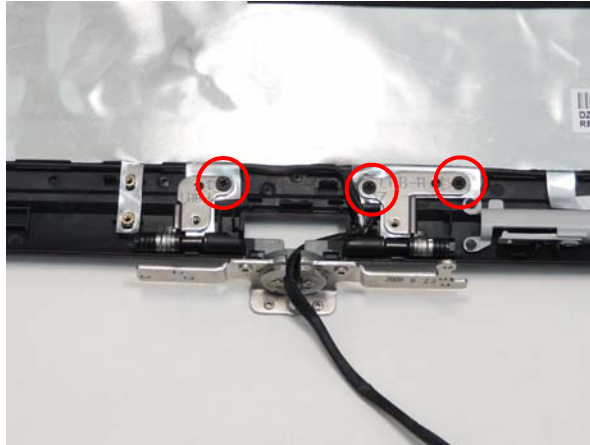

Step	Screw	Quantity	Screw Type.
Hinge	M2*4	3	

3. Pull the cables clear of the hinge.

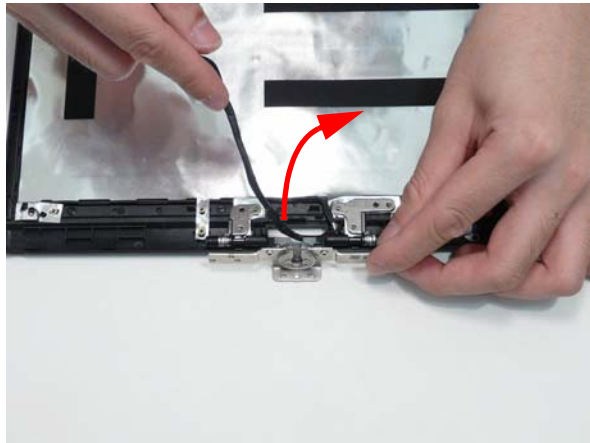

4. Remove the hinge.

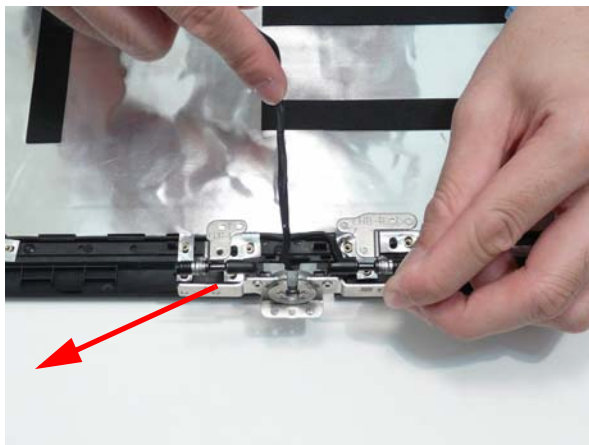

Removing the Antennas

1. See “Removing the Microphone” on page 88.
2. See “Removing the Touchscreen Board” on page 94.
3. See “Removing the Hinge” on page 95.
4. Lift up the foil tabs over the cables.

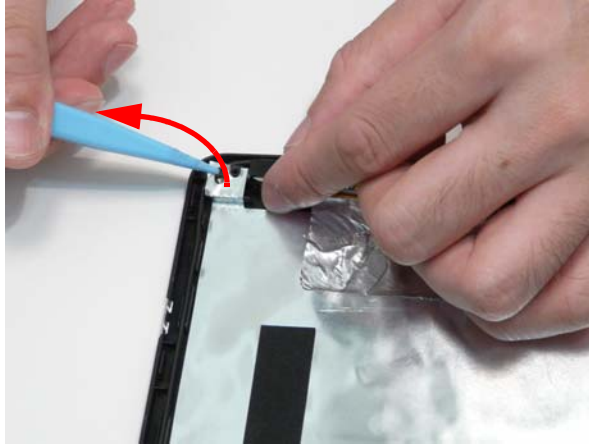

5. Peel the antenna foil off the cover.

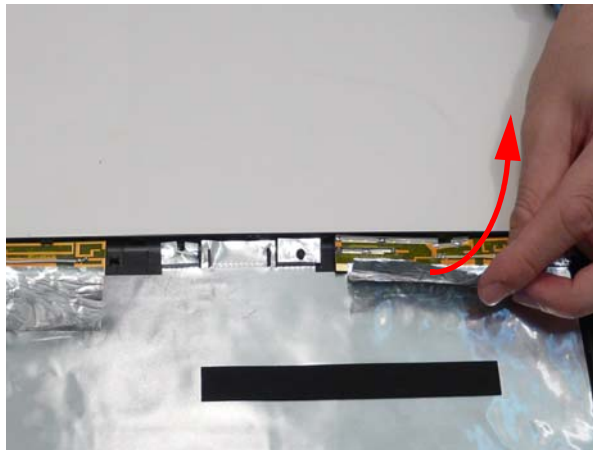

6. Peel the right antenna off the adhesive.

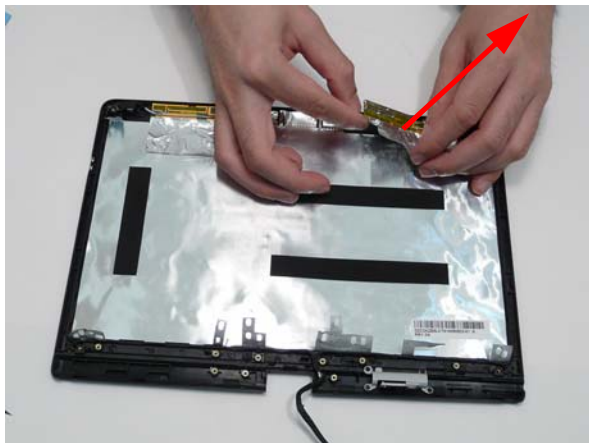

7. Remove the antenna cable from the retention guide hooks.

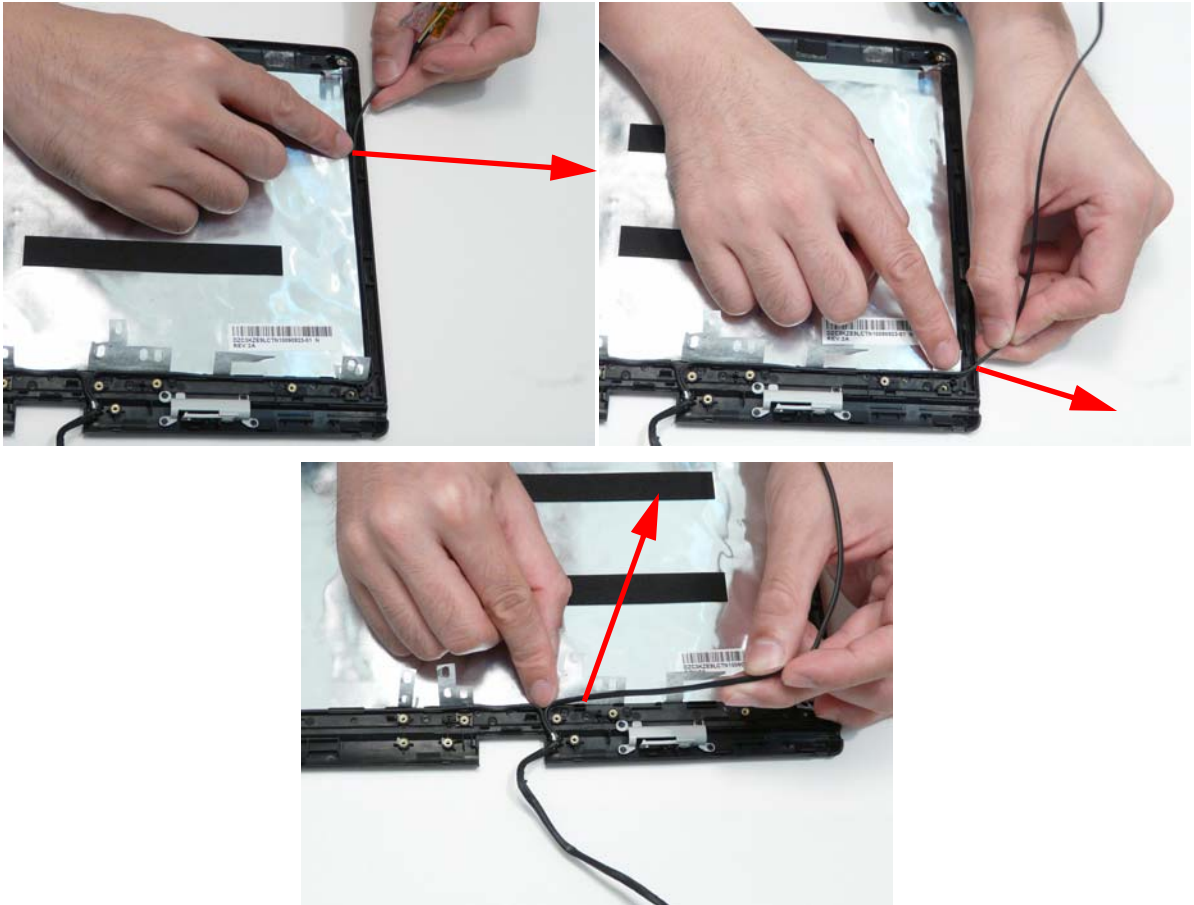

8. Peel the left antenna foil off the cover.

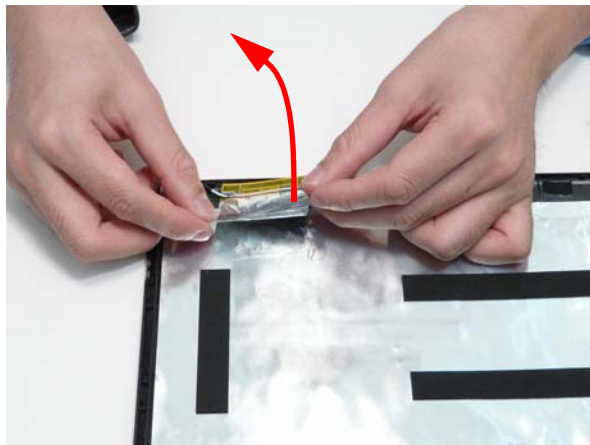

9. Peel the antenna off the adhesive.



10. Remove the antenna cable from the retention guide hooks.

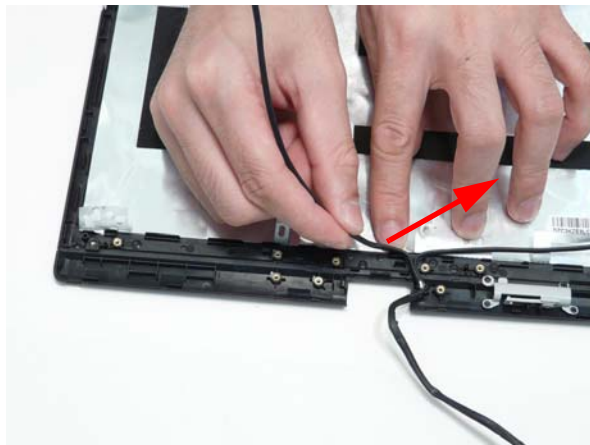
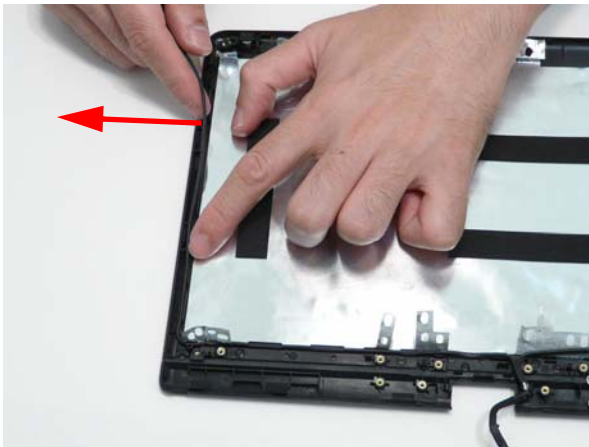

11. Remove both antenna cables from the cover.

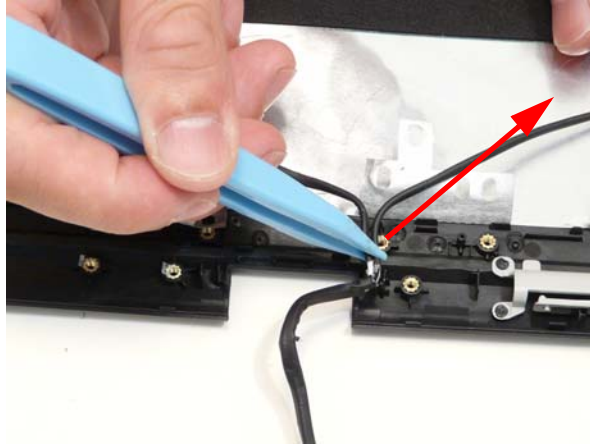

LCD Reassembly Procedure

Replacing the Antennas

1. Lay the two cables under the retention guide exit hook.

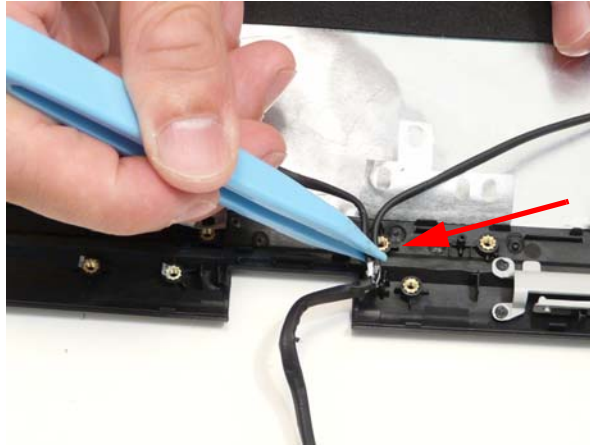

2. Lay the left side cable under the retention guide hooks.



3. Adhere the left antenna pad (black cable) to the cover.

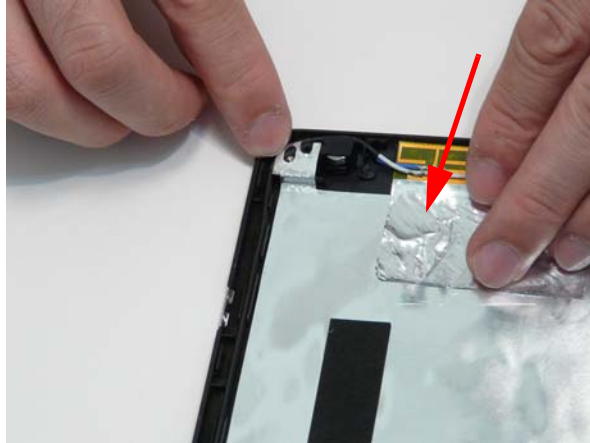

4. Lay the right side cable under the retention guide hooks.

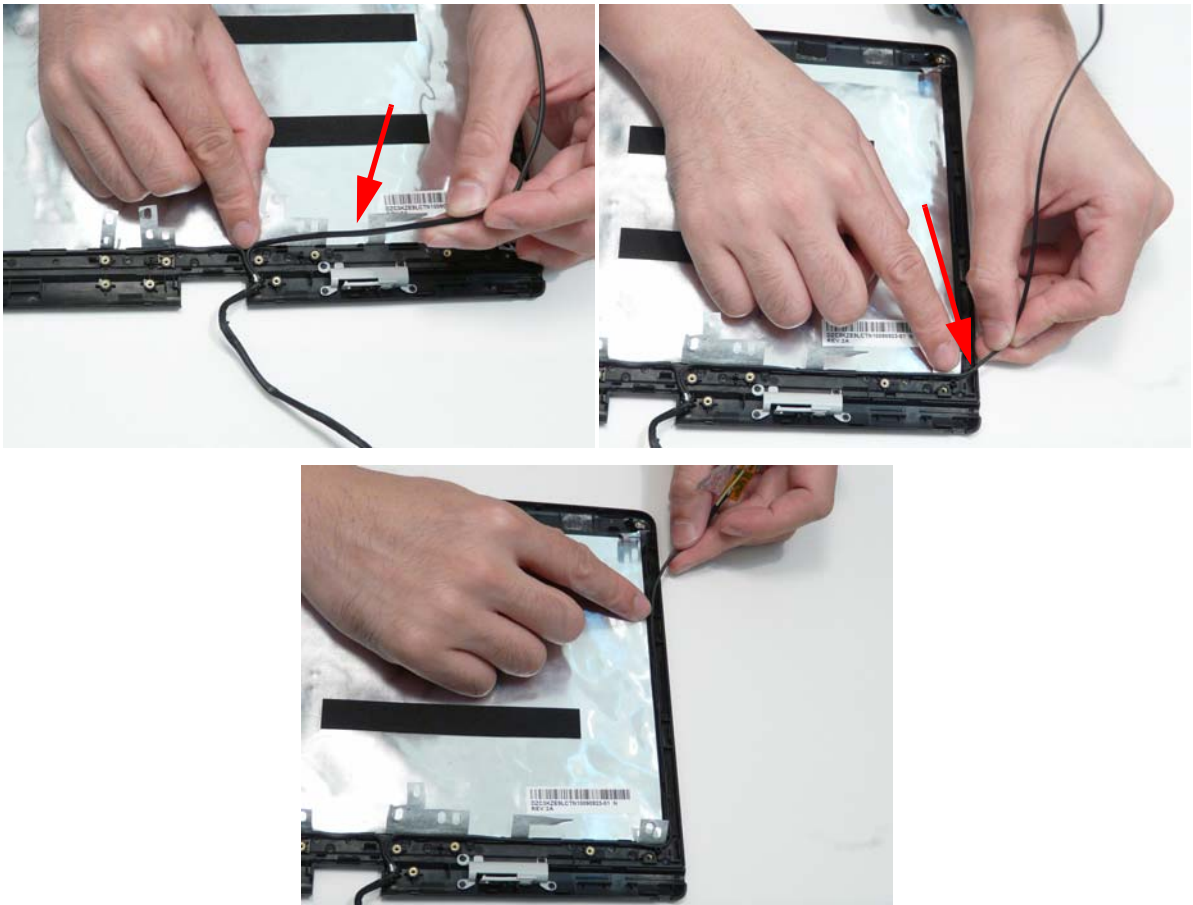

5. Adhere the right side antenna pad (yellow cable) to the cover.

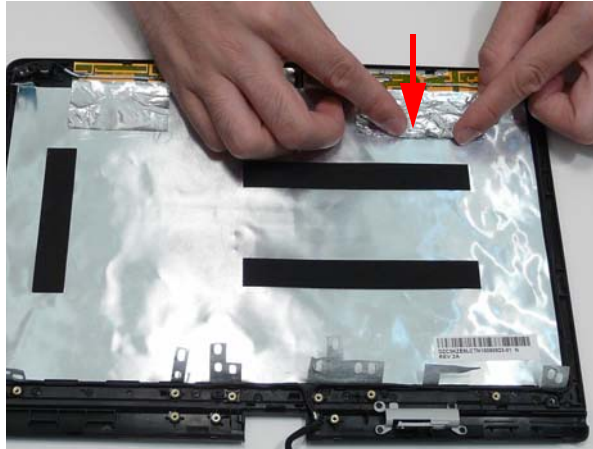

6. Replace the foil tabs over the cables.

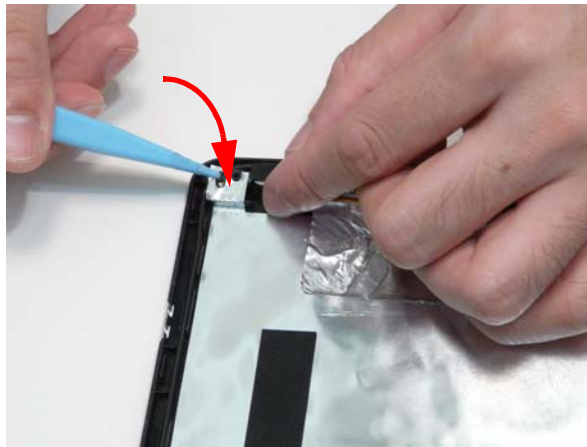

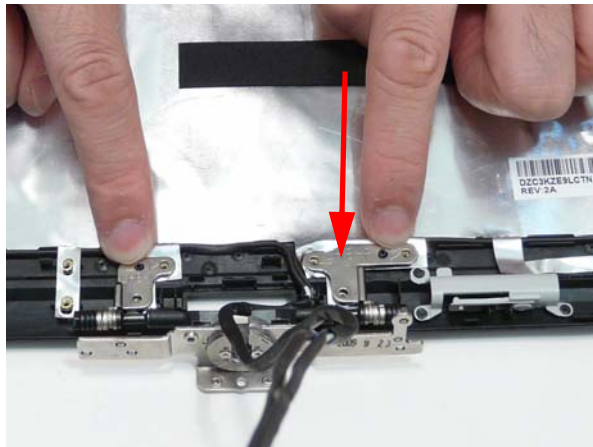

Replacing the Hinge

1. Place the hinge on the cover.

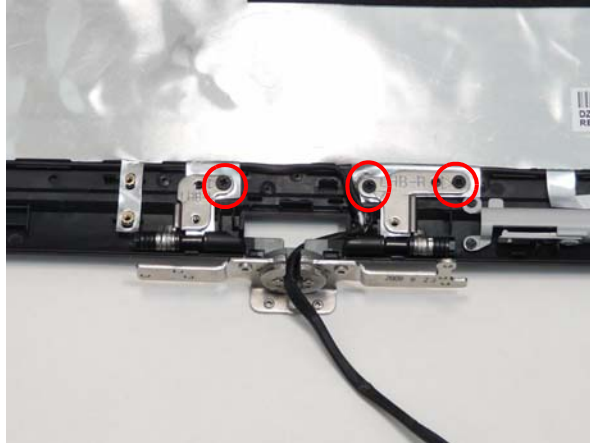

2. Replace the three (3) screws.



Step	Screw	Quantity	Screw Type.
LCD Hinge	M2*4	3	

Replacing the Touchscreen Board.

1. Place the touchscreen board onto the cover.

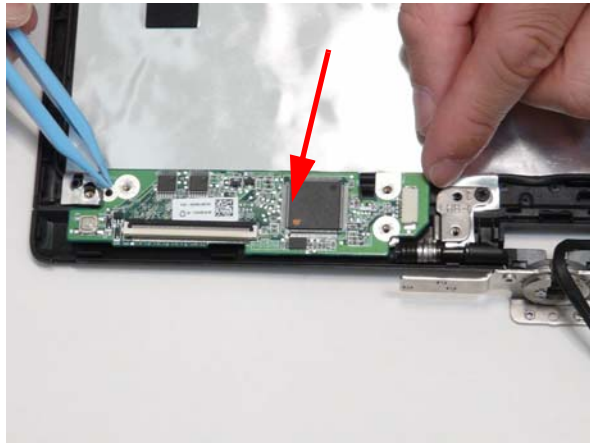

2. Replace the two (2) screws.

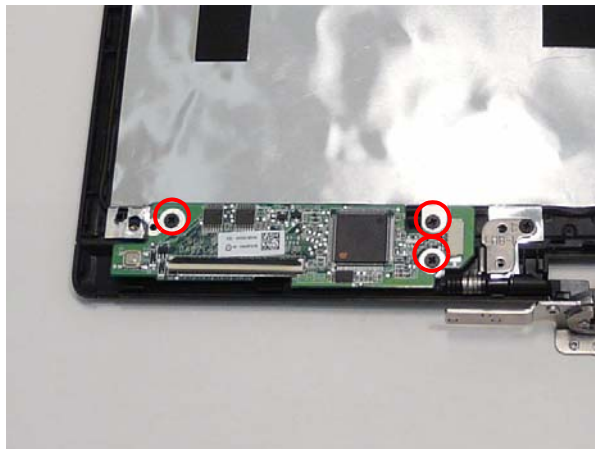

Step	Screw	Quantity	Screw Type.
Touchscreen Board	M2*4	3	

Replacing the LCD Brackets

1. Place the two brackets on the panel paying attention to the correct orientation.



2. Replace the four (4) screws (red call outs).

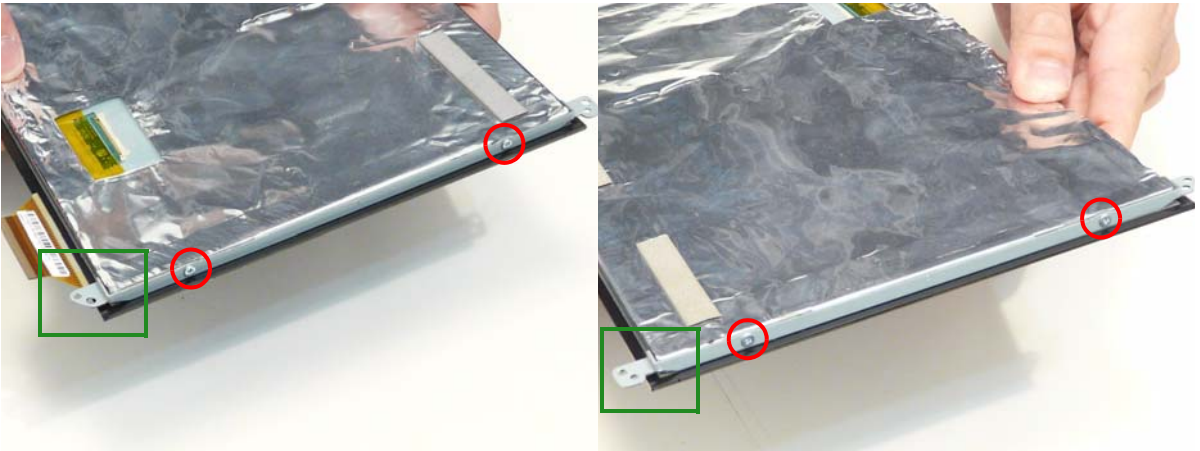

NOTE: The alignment of the brackets (green call outs).

Step	Screw	Quantity	Screw Type.
LCD Panel Brackets	M2*2.5	4	

Replacing the LCD Cable

1. Adhere the touchscreen cable to the panel.

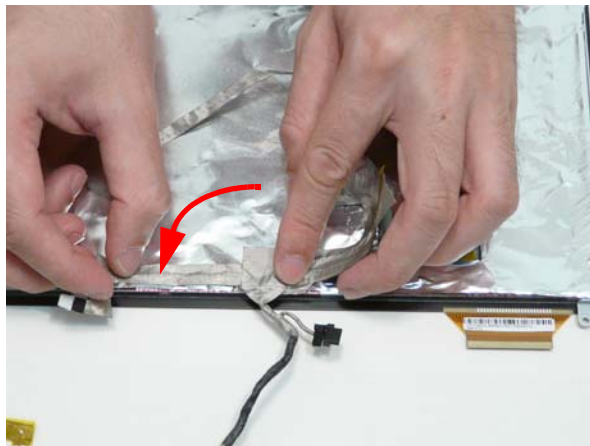

2. Adhere the LCD cable to the panel.

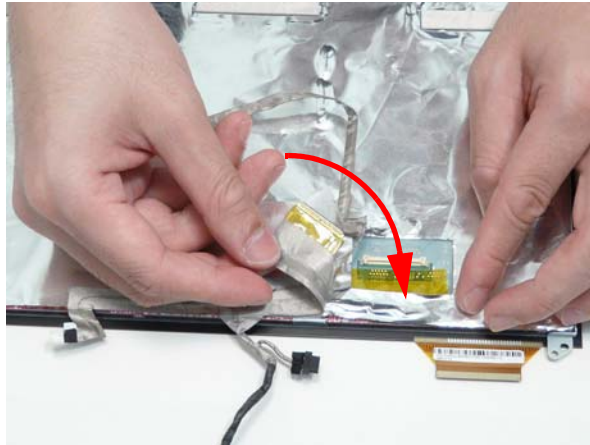

3. Connect the LCD connector to the panel.

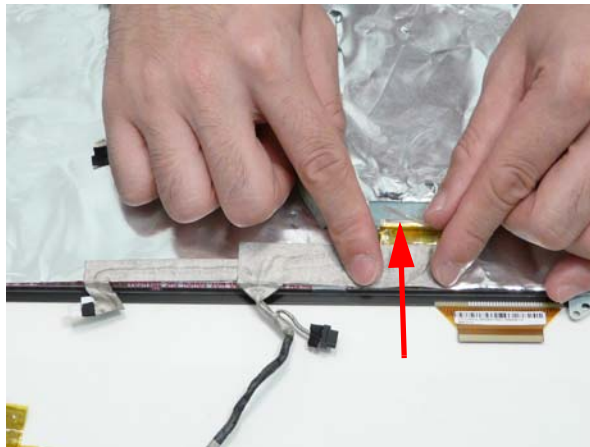

4. Adhere the clear protective cover over the LCD connector.

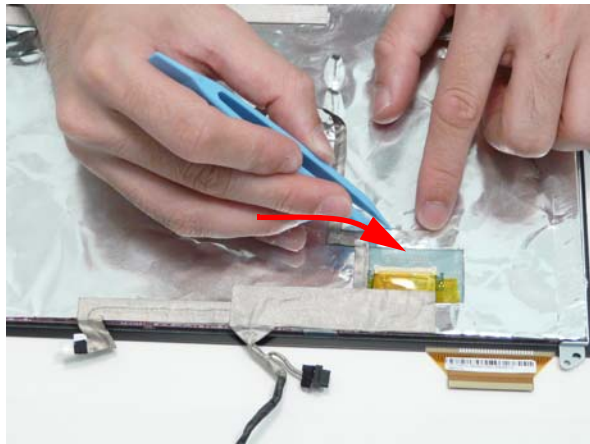

5. Adhere the camera cable to the panel.

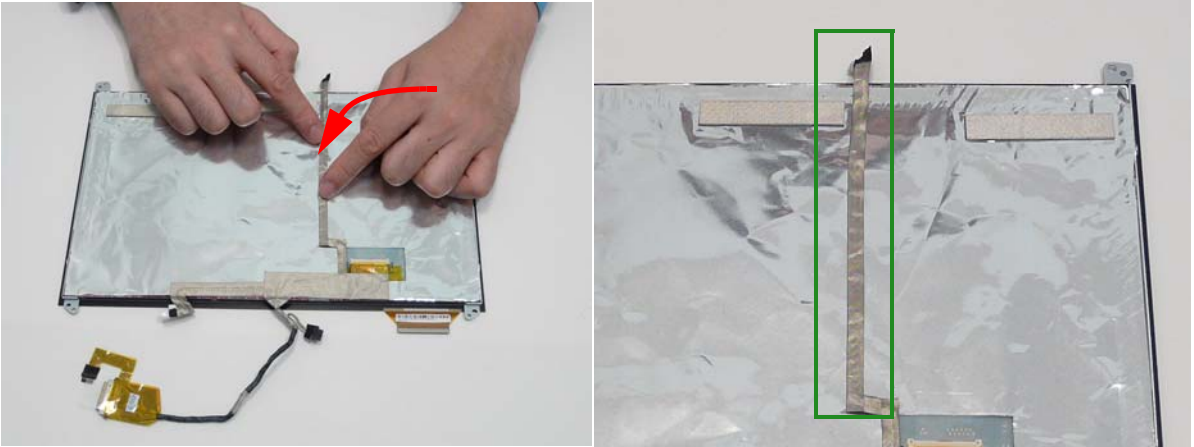

NOTE: The correct location of the webcam connector (green call out).

Replacing the LCD Panel

1. Lay the LCD cable first through the hinge.

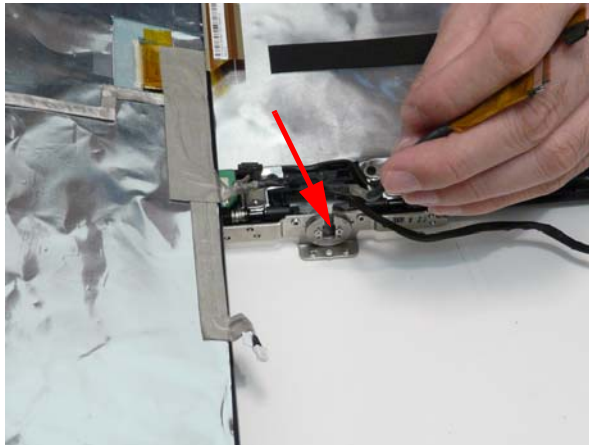

2. Lay the antenna cable through the hinge.

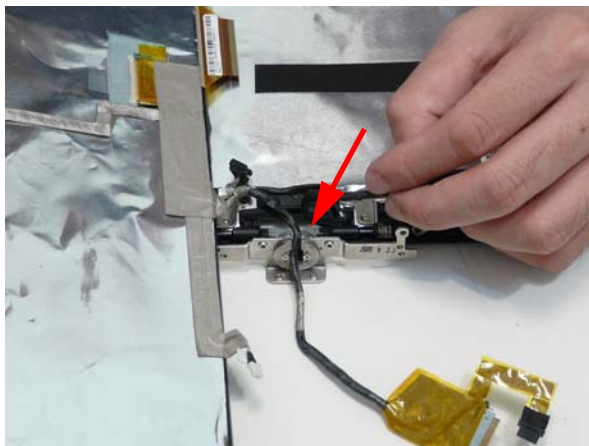

NOTE: The correct cable arrangement as follows.

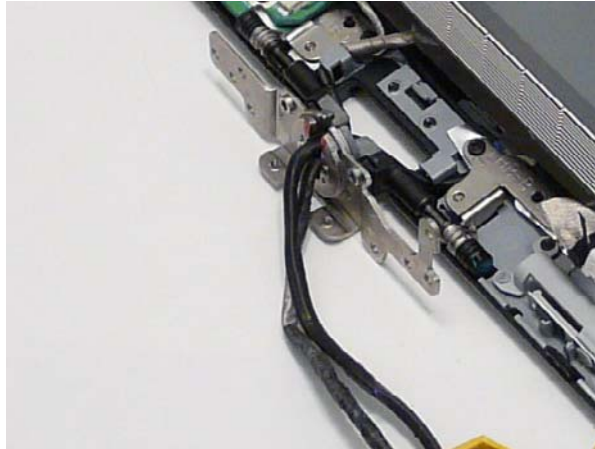

3. Connect the touchscreen FPC (1) and lay the panel down in the cover (2).

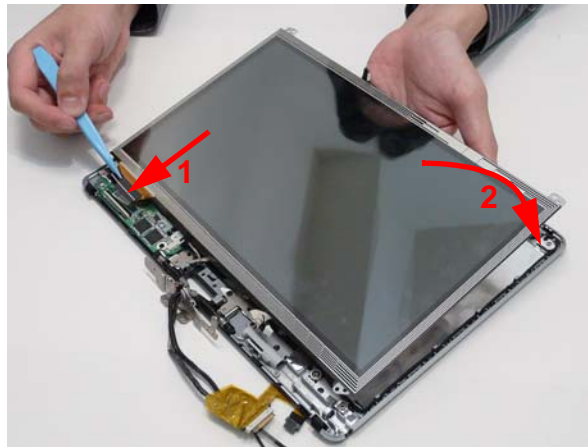

4. Replace the four (4) screws.



Step	Screw	Quantity	Screw Type.
LCD Panel	M2*4	4	

5. Connect the touchscreen cable.

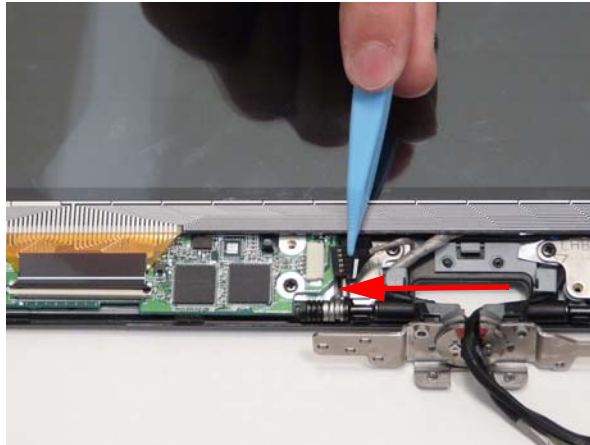

6. Lock the touch screen FPC.

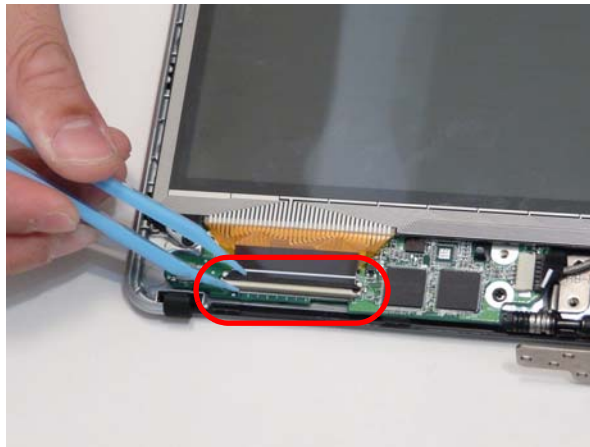

Replacing the Microphone.

1. Adhere the microphone to the cover.



2. Connect the microphone cable.



3. Make sure the cable tie is tucked securely under the panel.

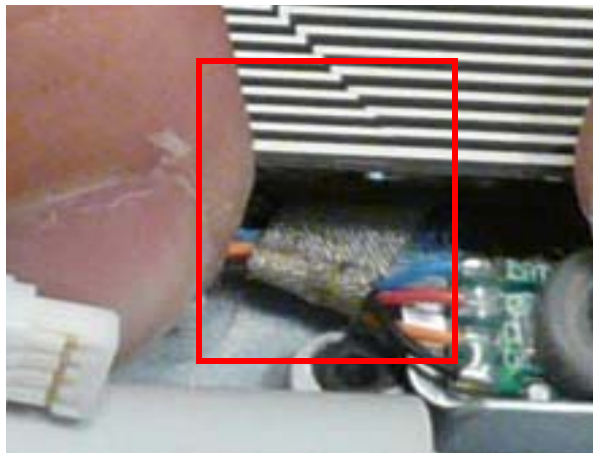

Replacing the Camera Board

1. Connect the cable to the camera board.

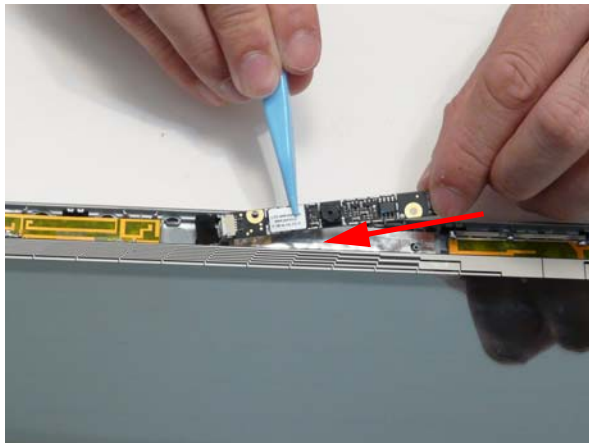

2. Adhere the camera board to the cover.

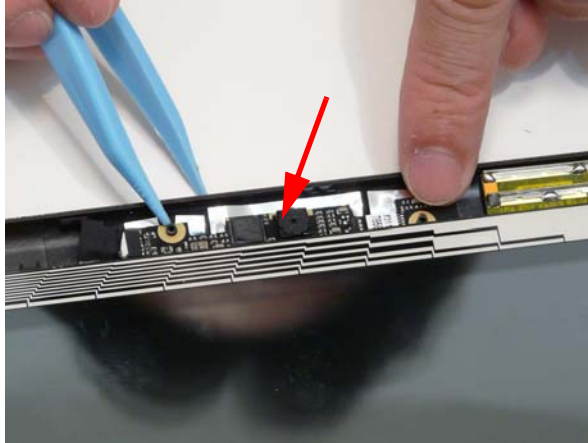

Replacing the LCD Bezel

1. Place the bezel on the cover.



2. Press down on the bezel bottom edge.



3. Press down the bezel sides.



4. Press down the bezel top edge.

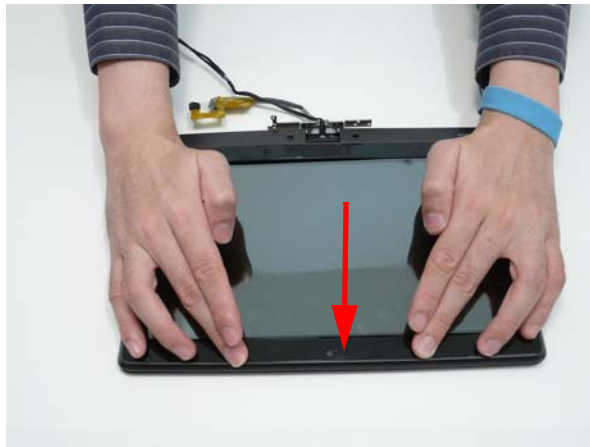

5. Replace the two screws.



Step	Screw	Quantity	Screw Type.
LCD Bezel	M2*5	2	

6. Replace the screw covers.



7. Insert the stylus.

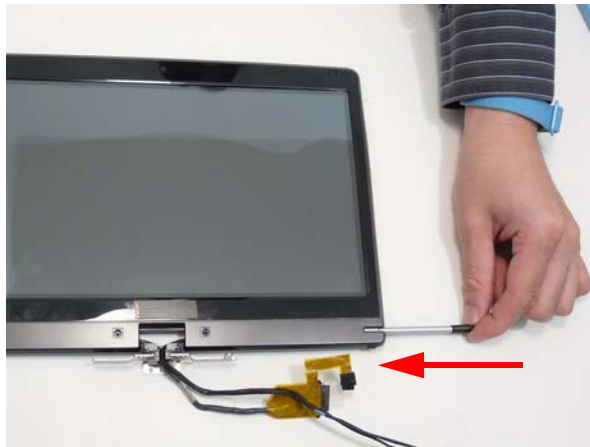

Main Unit Reassembly Process

Replacing the LCD Module

1. Lay the LCD cable into the retention guide.

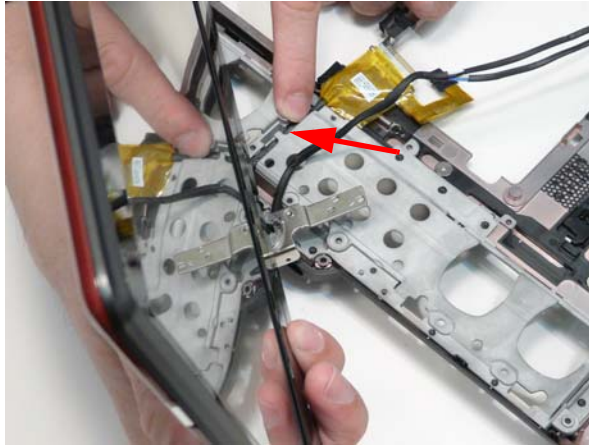

2. Lay the antenna cable into the retention guide.

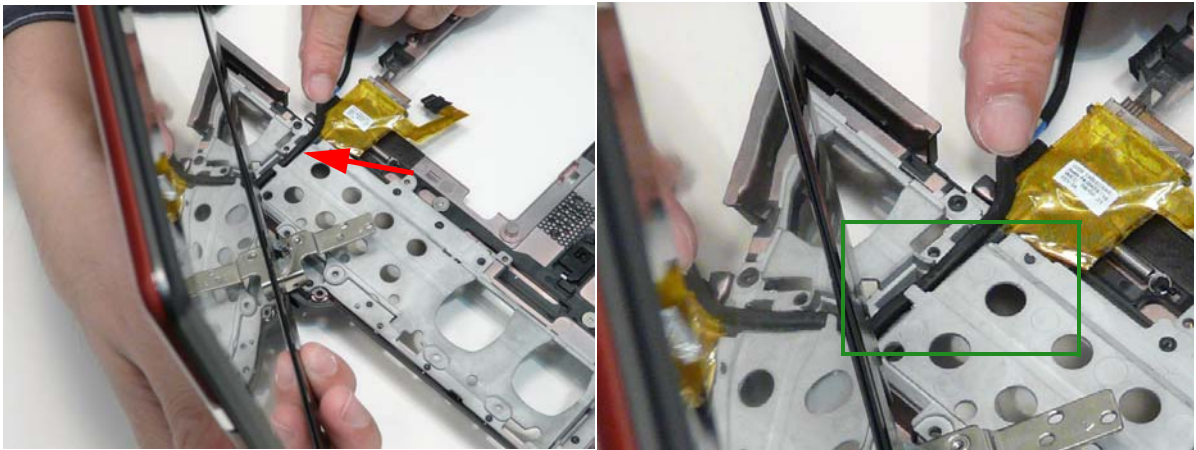

NOTE: The location of the retention hook (green call out).

3. Replace the two (2) screws in the hinge. Left side 1, right side 2.

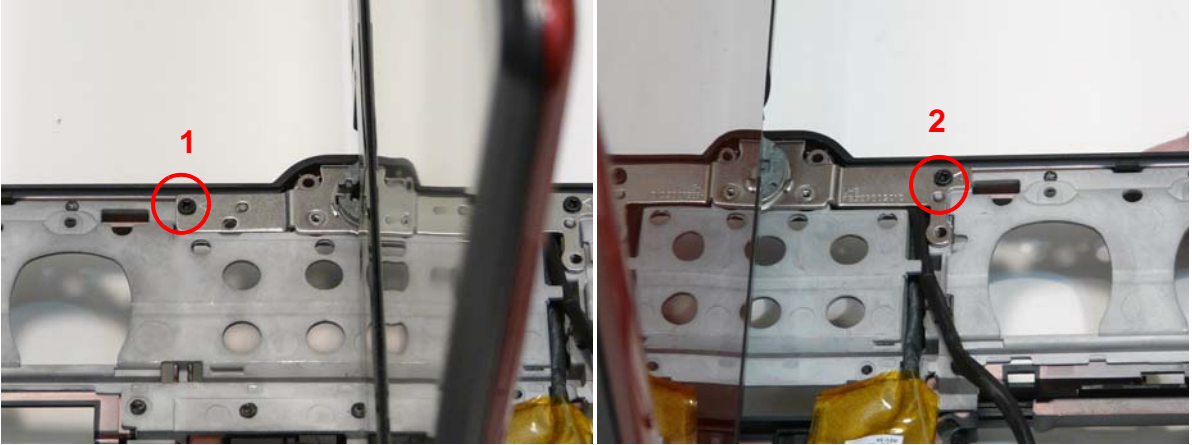

Step	Screw	Quantity	Screw Type.
LCD Module	M2*5	2	

4. Close the LCD module and replace the three (3) screws in the lower cover rear side.

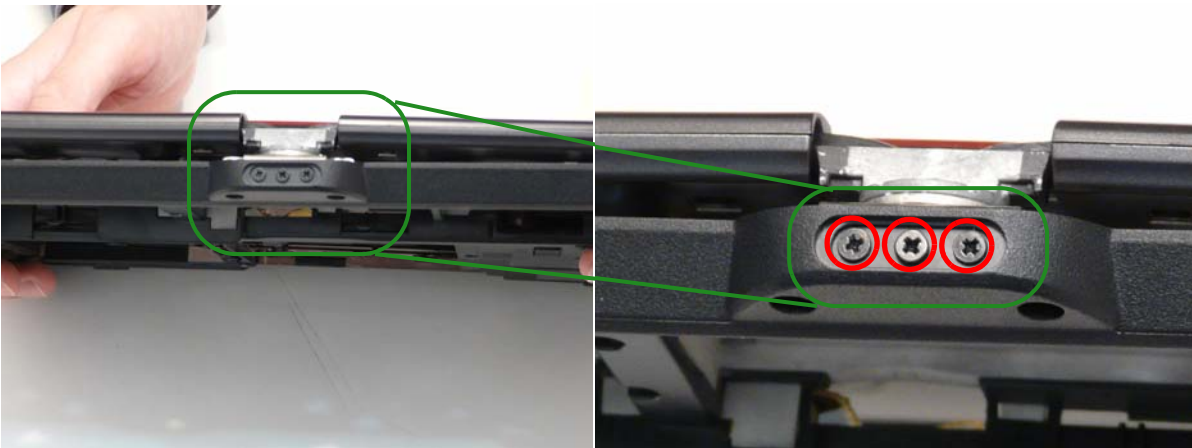

Step	Screw	Quantity	Screw Type.
LCD Module	M2*4	3	

Replacing the RTC Battery

1. Push the RTC battery into the holder.

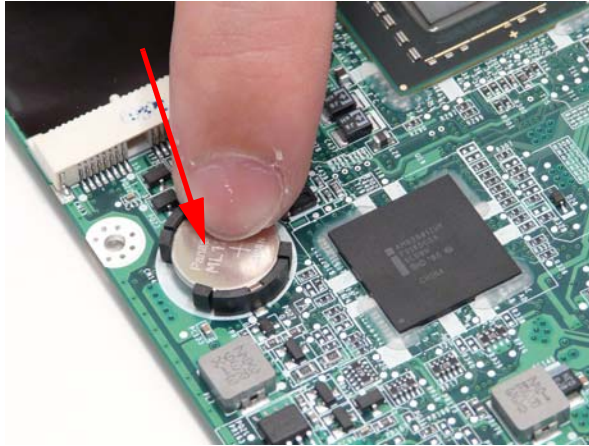

Replacing the Thermal Module

IMPORTANT: Ensure all heat pads are in place before replacing the Thermal Module.

The following thermal pads are approved for use:

- Eapus XR-PE
1. Remove all traces of thermal grease or pad adhesive from the CPU and thermal module using a lint-free cloth or cotton swab and Isopropyl Alcohol, Acetone, or other approved cleaning agent.
 2. Place the thermal module on the mainboard.

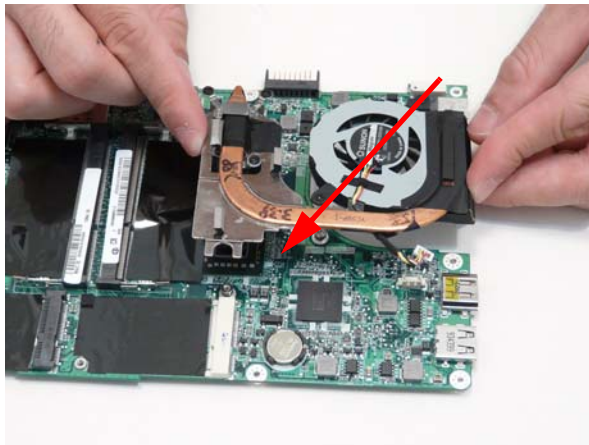

3. Tighten the five (5) captive screws. First tighten the CPU captive screws in order: 1 then 2 then 3. Then tighten the two (2) other screws.

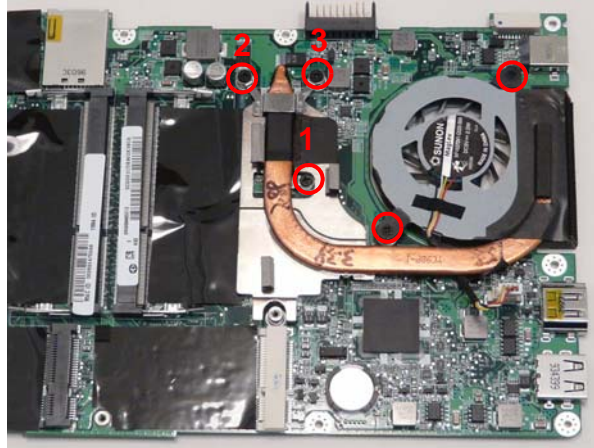

4. Connect the thermal module cable.



Replacing the Speakers.

5. Place the speaker modules onto the bottom cover.

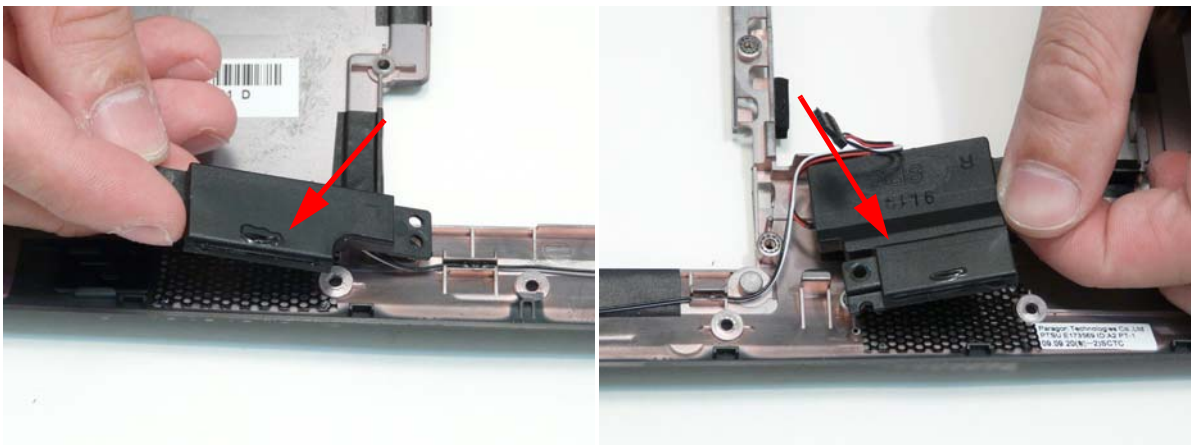

1. Lay the speaker cables into the retention guides and apply glue on the retention guide locations.

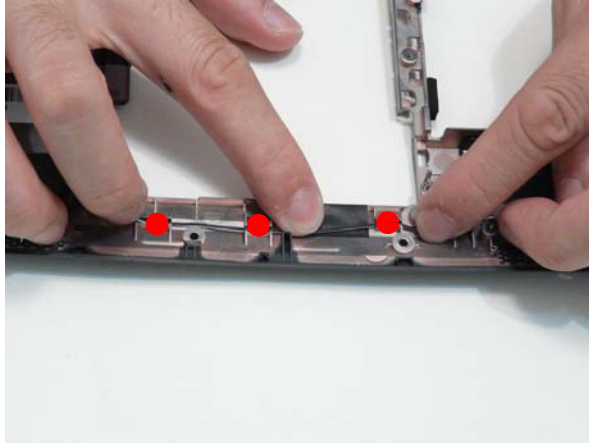

2. Replace the three (3) screws.

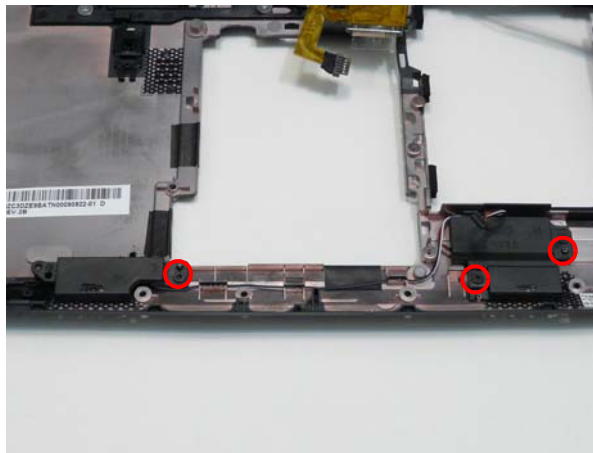

Step	Screw	Quantity	Screw Type.
Speaker	M2*3	3	

Replacing the Mainboard

1. Connect the CRT board cable.

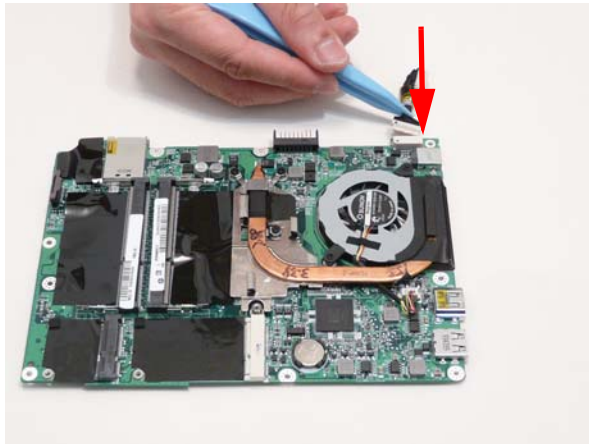

2. Replace the mainboard into the bottom cover inserting the external connector side first.

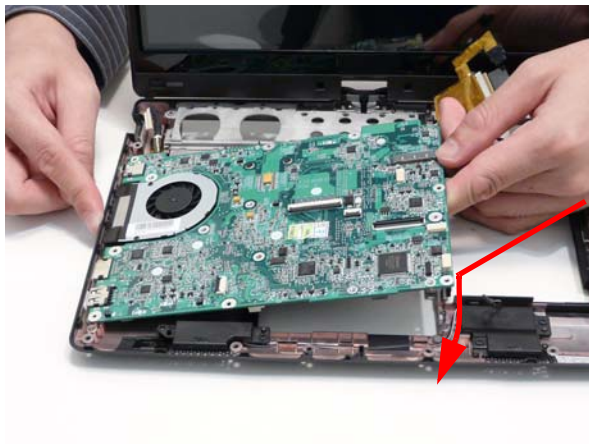

3. Replace the two (2) screws.



Step	Screw	Quantity	Screw Type.
Mainboard	M2*4	2	

4. Connect the speaker connector.

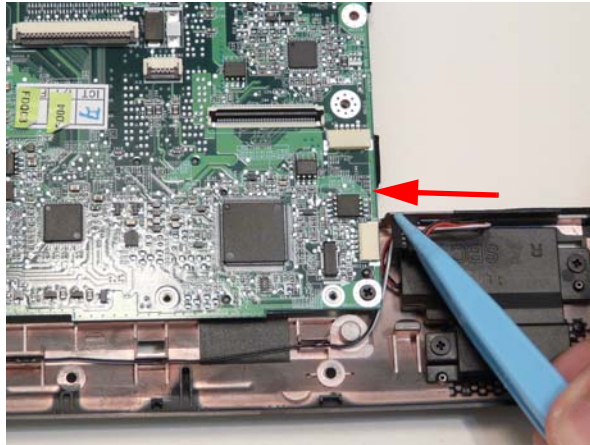

5. Lay the LCD cable through the retention guides so it matches the mainboard connector locations.

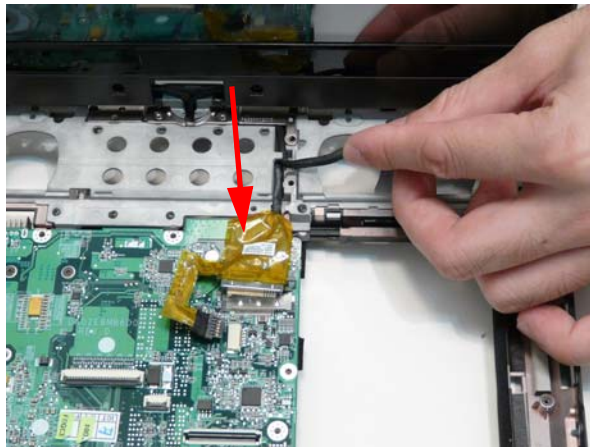

6. Turn the computer over and lay the antenna cable in the retention guides.

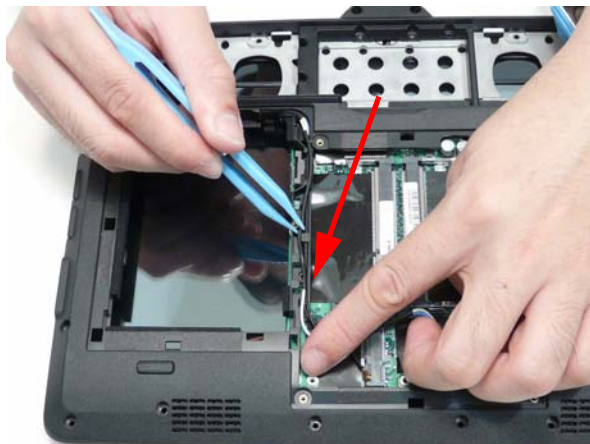

7. Turn the computer over and connect touchscreen cable.

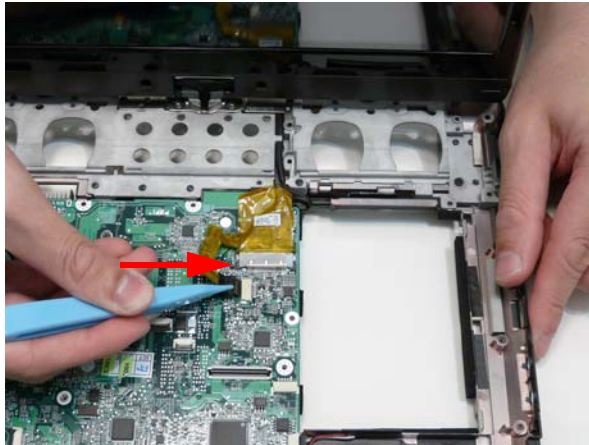

8. Connect the LCD cable.

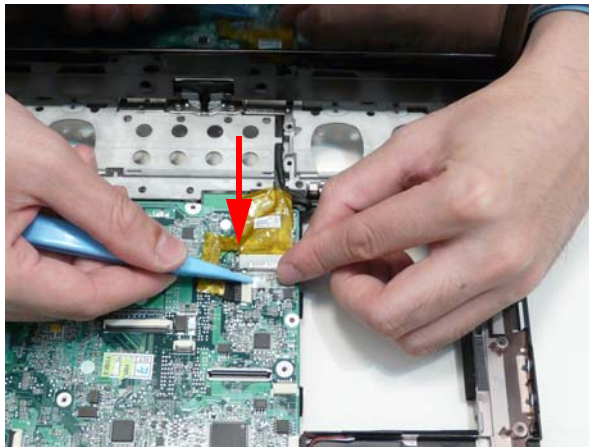

9. Adhere the clear protective LCD connector cover.

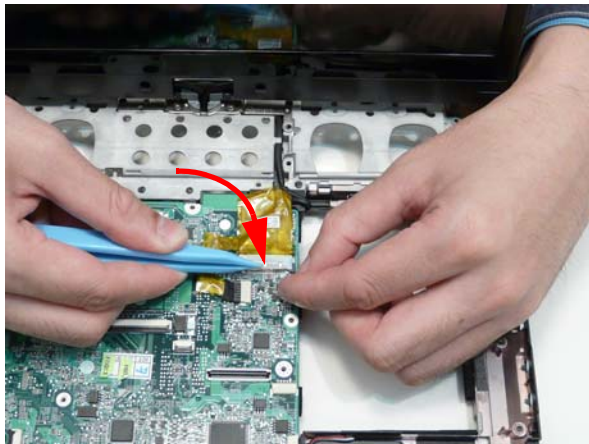

Replacing the CRT Board.

1. Connect the CRT cable.

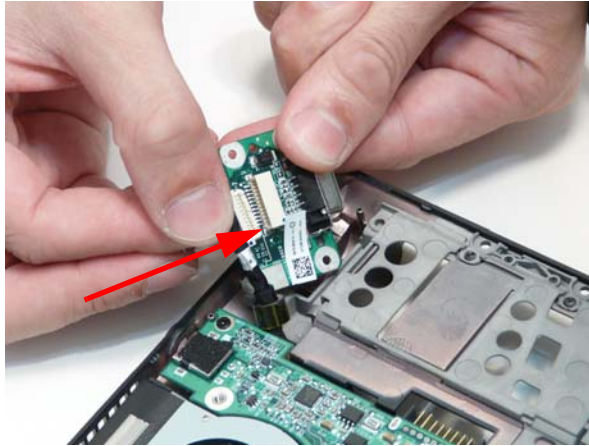

2. Turn the CRT board over.

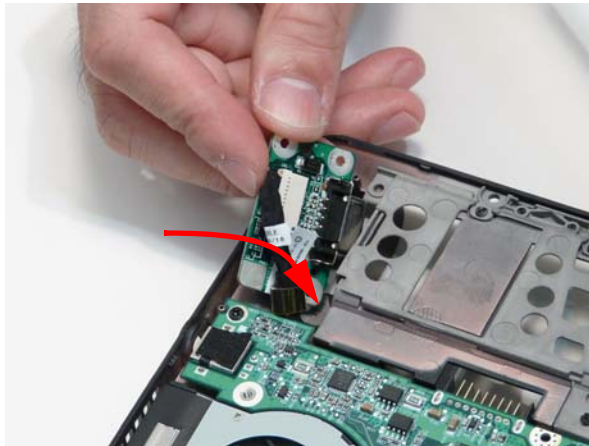

3. Place the CRT board into the cover.

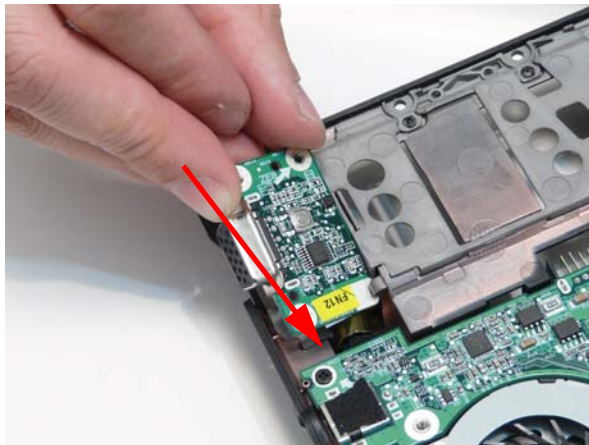

4. Replace the one (1) screw.



Step	Screw	Quantity	Screw Type.
CRT Board	M2*4	1	

Replacing the LED Board

1. Place the LED board onto the cover.

IMPORTANT: Take special care that the slider switch is properly aligned in the bottom case switch cover.

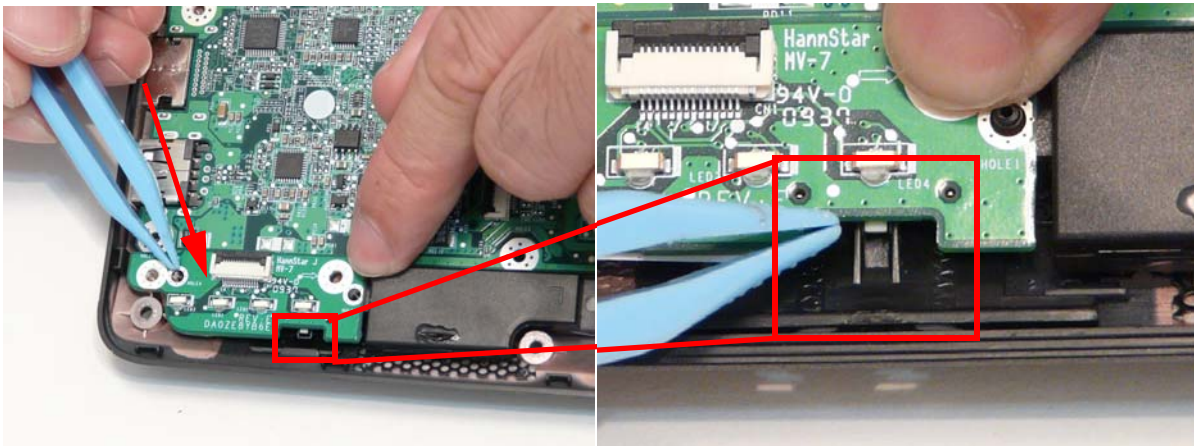

2. Replace the two (2) screws.



Step	Screw	Quantity	Screw Type.
LED Board	M2*4	2	

3. Replace the LED board cable in the mainboard connector.

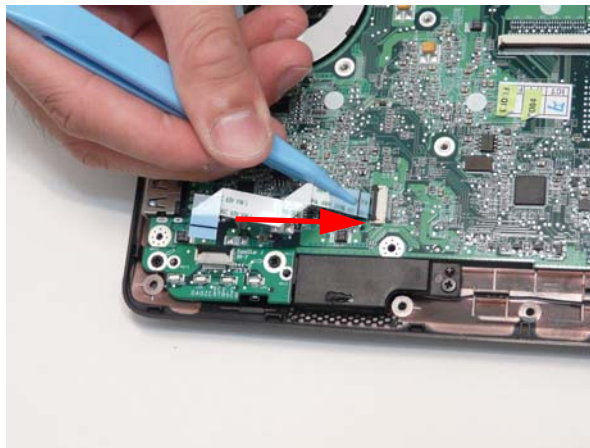

4. Lock the mainboard connector.

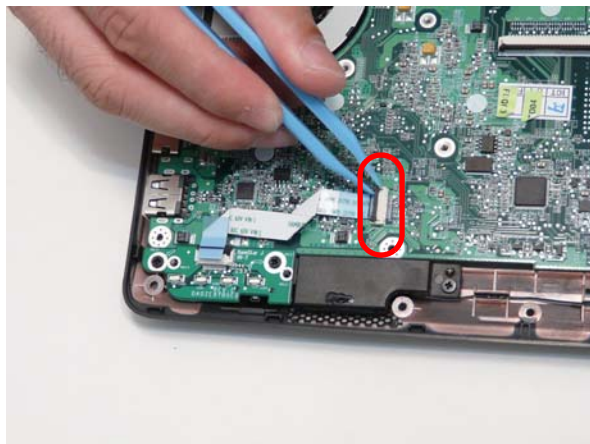

5. Replace the LED board cable in the LED board connector.



6. Lock the LED board connector.

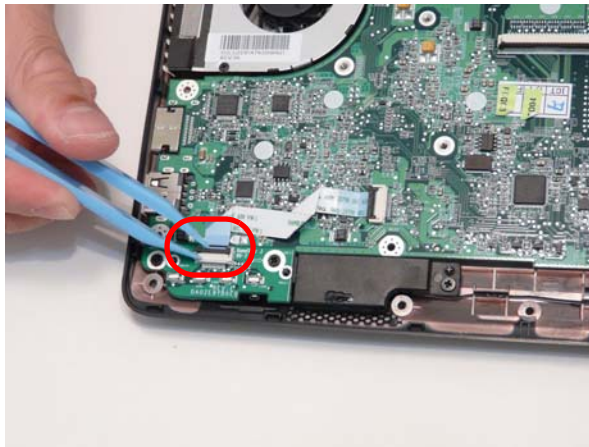

Replacing the I/O Board

1. Replace the I/O board inserting the external port side first.

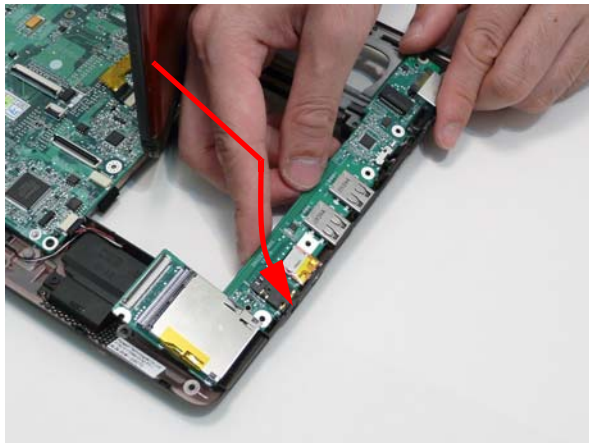

2. Replace the one (1) screw.



Step	Screw	Quantity	Screw Type.
IO Board	M2*4	1	

3. Turn the LCD module.

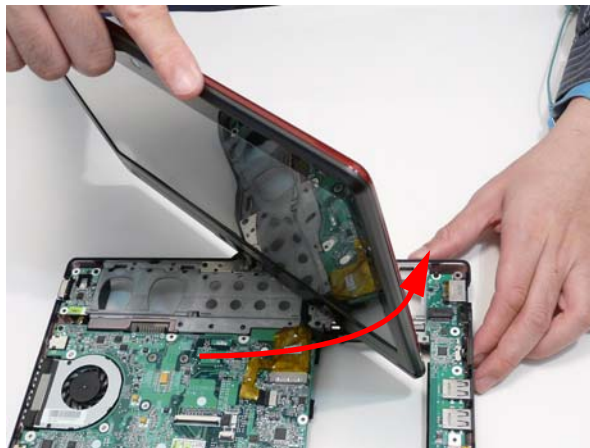

4. Replace the I/O cable in the I/O board connector.

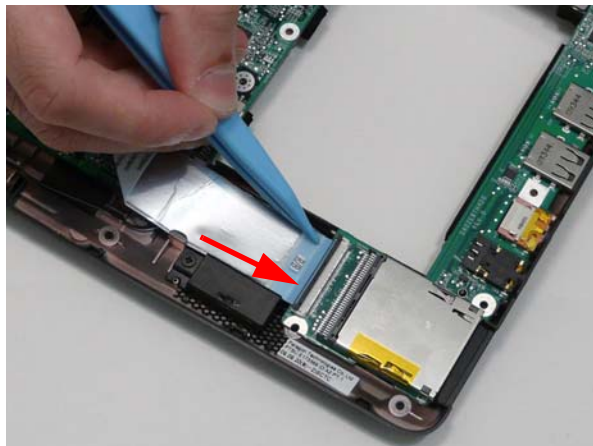

5. Lock the I/O board connector.

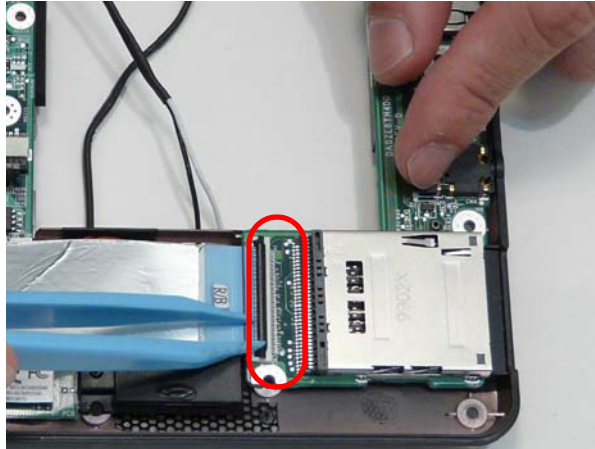

6. Insert the I/O cable under the retention guide hook.

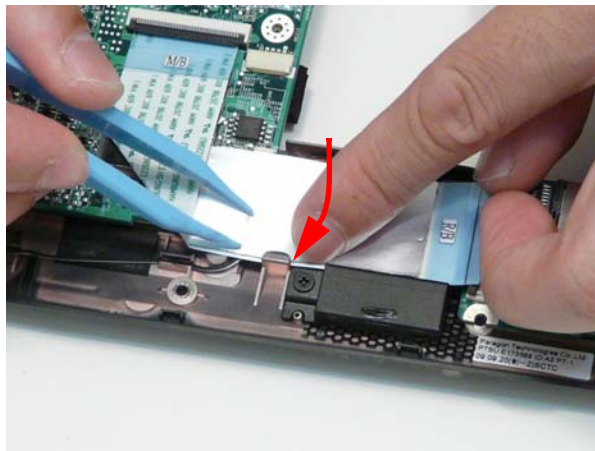

7. Replace the I/O cable in the IO board.

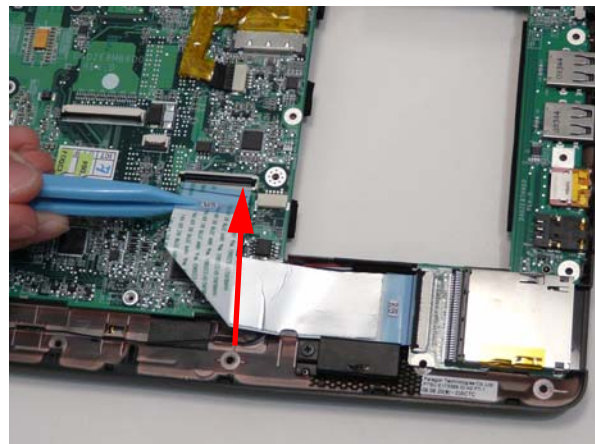

8. Lock the I/O board connector.

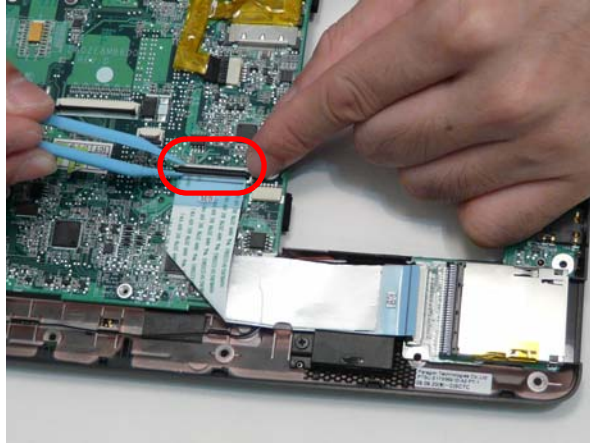

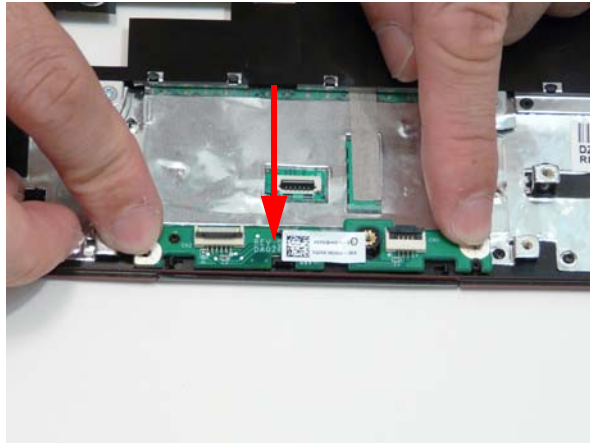

Replacing the Button Board

1. Replace the button board.

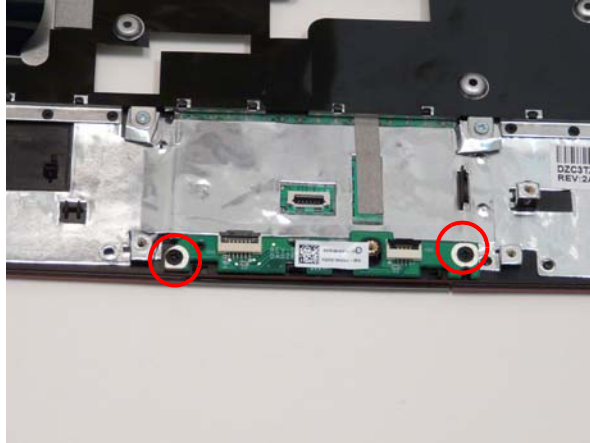

2. Replace the two (2) screws.



Step	Screw	Quantity	Screw Type.
Button Board	M2*3	2	

3. Replace the touchpad cable in the touchpad connector.

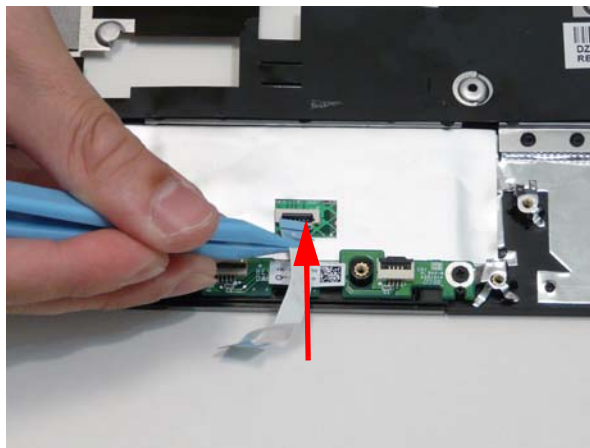

4. Lock the touchpad connector.

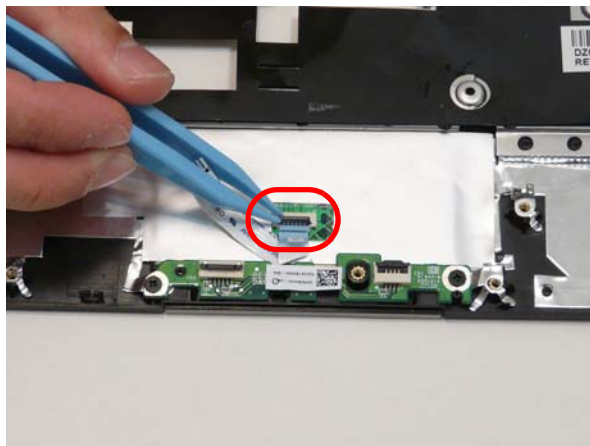

5. Adhere the touchpad cable to the top cover.

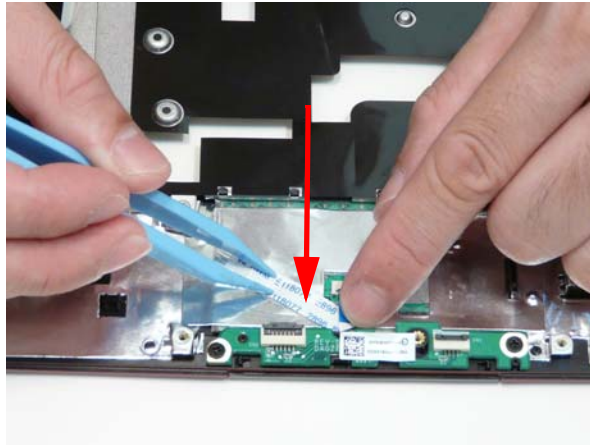

6. Connect the touchpad cable to the button board.

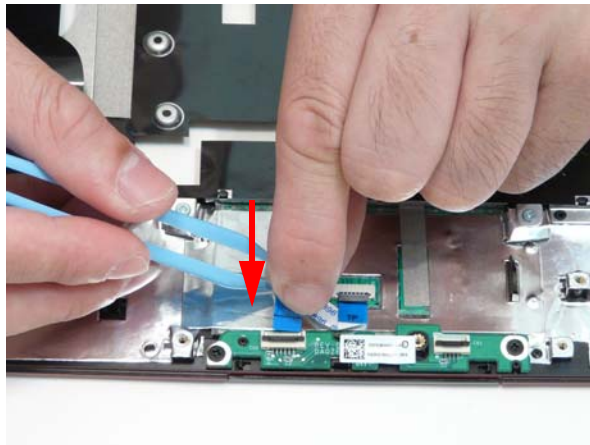

7. Lock the button board connector.

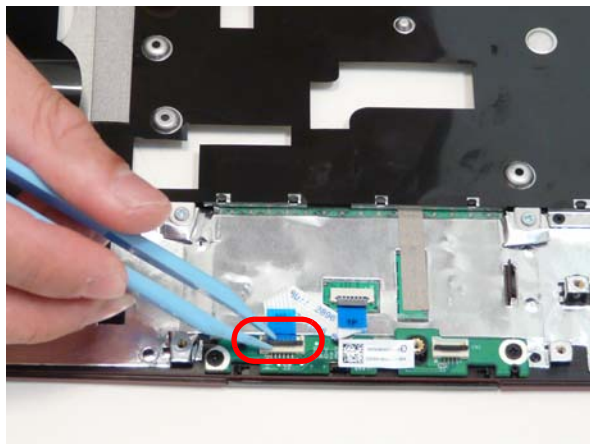

8. Adhere the button board cable to the upper cover.

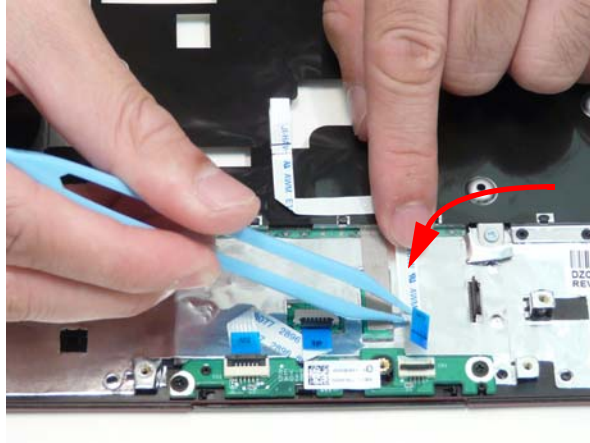

9. Replace the button board cable in the button board connector.

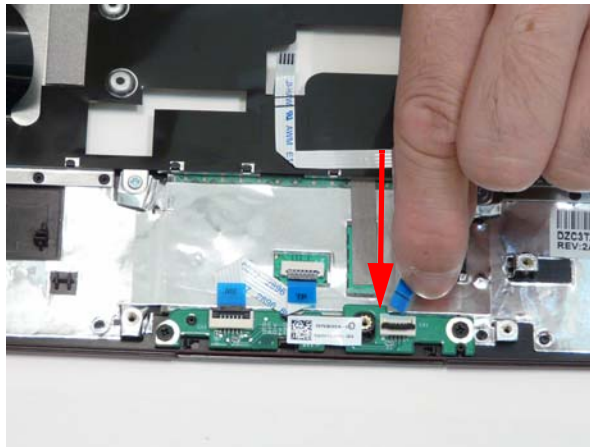

10. Lock the button board connector.

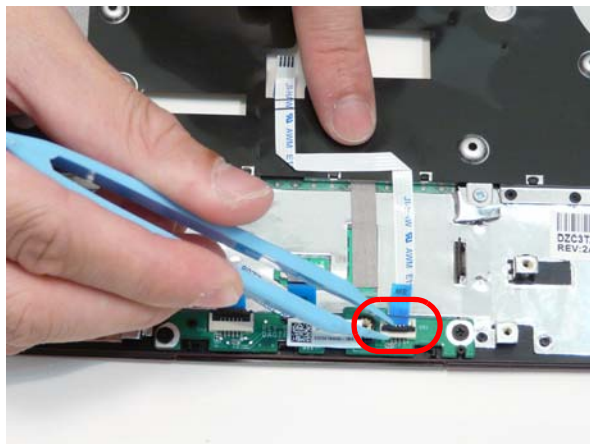

Replace the Bluetooth Module

1. Replace the Bluetooth cable.

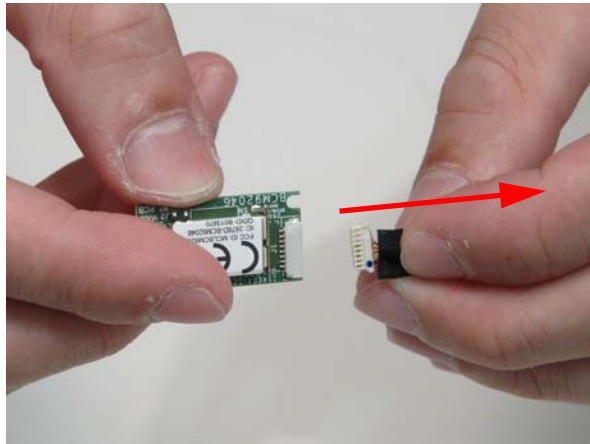

2. Replace the Bluetooth module onto the upper cover.

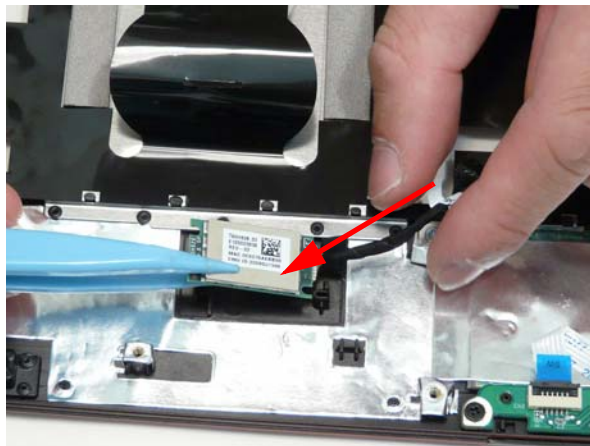

3. Replace the one screw.



Step	Screw	Quantity	Screw Type.
Bluetooth Module	M2*4	1	

Replacing the Upper Cover

1. Replace the upper cover.



2. Connect the Bluetooth cable to the mainboard.



3. Press down on the upper cover sides.



4. Press down on the upper cover bottom edge.



5. Connect the button board cable.

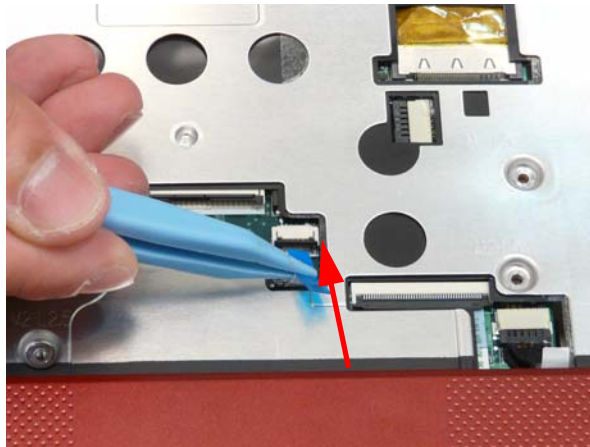

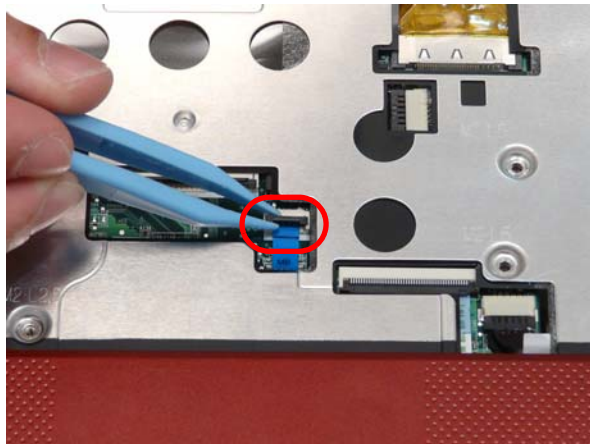

6. Lock the button board cable.





7. Replace the nine (9) screws in the upper cover.

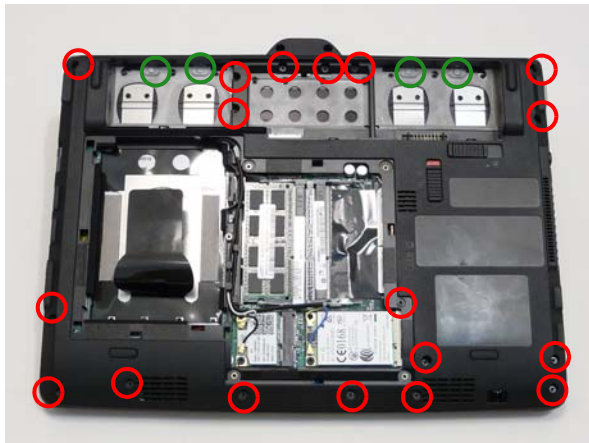

Step	Screw	Quantity	Screw Type.
Upper Cover	M2*5 (Red Call Out)	6	
	M2*2.5 (Green Call Out)	3	

8. Turn the computer over and replace the twenty-two (22) screws in the lower cover.



Step	Screw	Quantity	Screw Type.
Lower Cover	M2*5 (Red Call Out)	18	
	M2*4 (Green Call Out)	4	

Replacing the Hinge Covers

1. Replace the hinge cap.



2. Replace the hinge bezel.



3. Replace the two (2) screws.

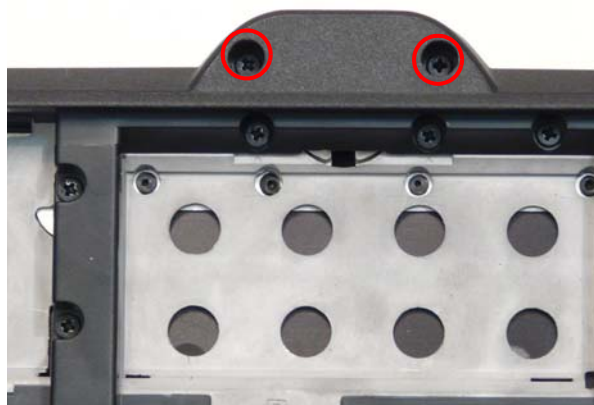

Step	Screw	Quantity	Screw Type.
Hinge Covers	M2*5	2	

Replacing the Keyboard

1. Replace the keyboard FPC.

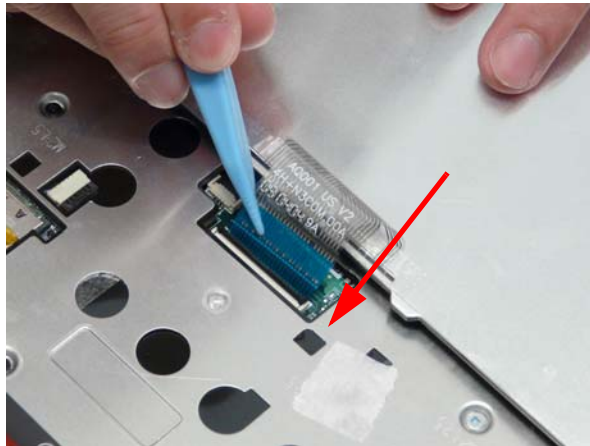

2. Lock the keyboard FPC.



3. Flip the keyboard over and insert the front edge of the keyboard.



-
4. Press down the keyboard top edge.



Replacing the 3G Module

1. Replace the 3G module.



2. Replace the one (1) screw.



Step	Screw	Quantity	Screw Type.
3G Module	M2*3	1	

3. Connect the cables (Blue cable connects to Aux).



Replacing the WLAN Module

1. Replace the WLAN card.



2. Replace the one (1) screw.



Step	Screw	Quantity	Screw Type.
WLAN	M2*3	1	

3. Connect the cables (Black cable connects to Main).



Replacing the DIMM

1. Replace the DIMM module.

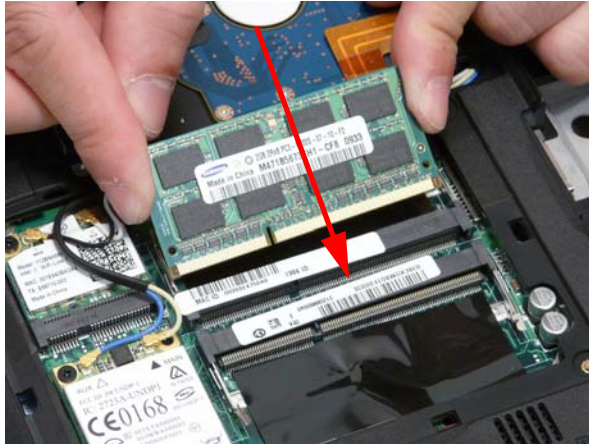

2. Press down the DIMM module to lock into place.



Replacing the Hard Disk Drive

1. Replace the HDD FPC.

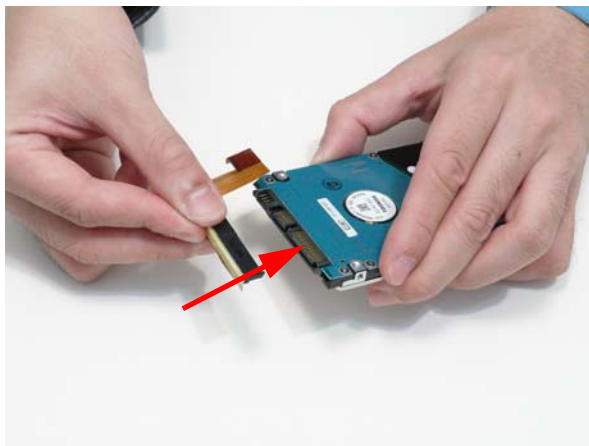

2. Replace the HDD in the bay.

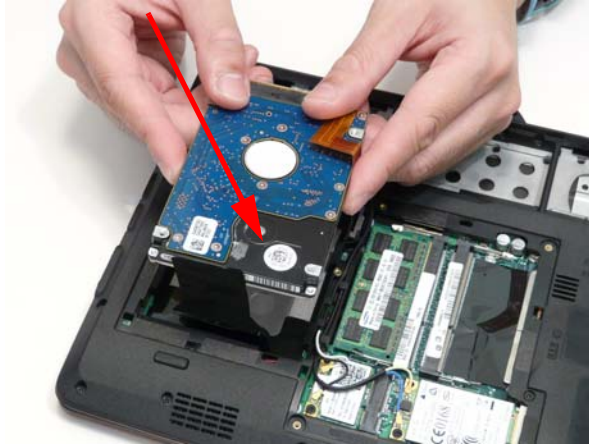

3. Adhere the black tape.

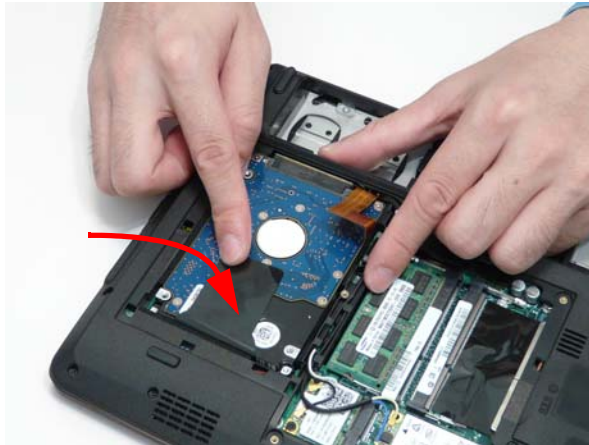

4. Replace the HDD FPC.

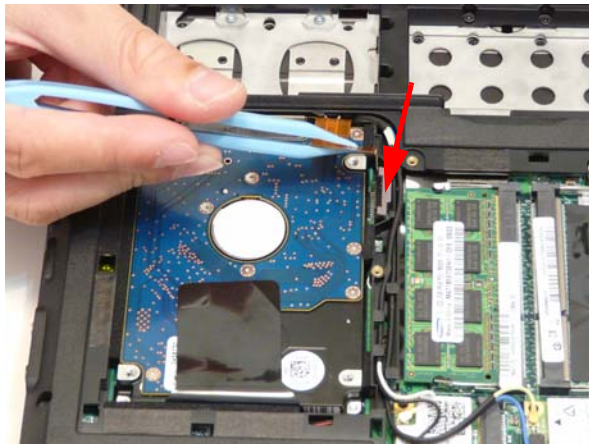

5. Lock the HDD FPC.

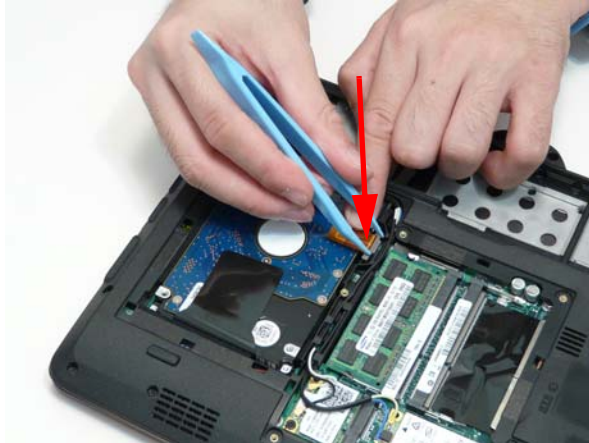

Replacing the Module Cover

1. Insert the side of the module cover into the outside edge slots (1) and lower into place (2).

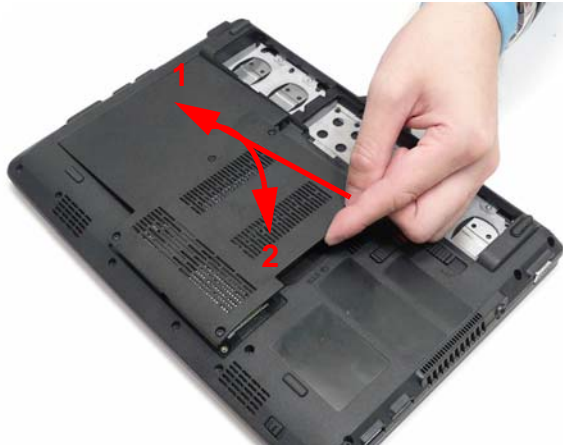

2. Press firmly around the edges of the module cover.

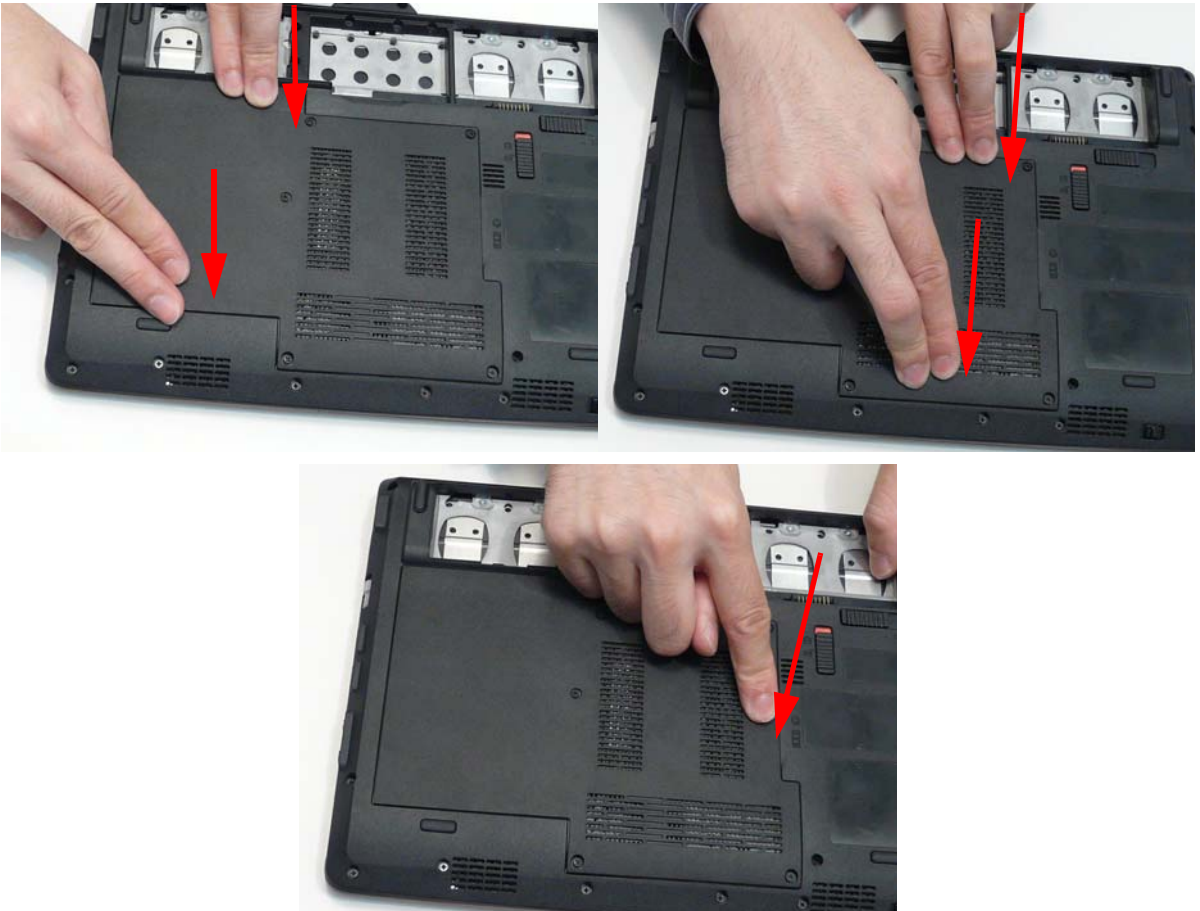

3. Tighten the five (5) captive screws.



Replacing the SIM Card

1. Insert the SIM card into the slot until you hear an audible click.

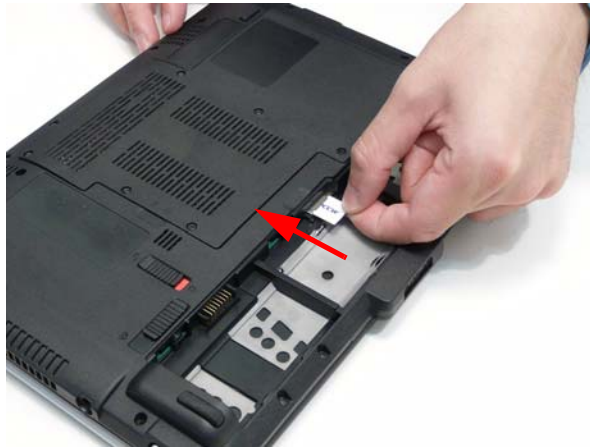

NOTE: The gold chip in the SIM card is face down.

Replacing the Battery

1. Insert the battery outer edge into the slots.



2. Push the battery down into place.



3. Lock the battery.



Replacing the Dummy Card

1. Insert the dummy card into the slot.



Troubleshooting

Common Problems

Use the following procedure as a guide for computer problems.

NOTE: The diagnostic tests are intended to test only Acer products. Non-Acer products, prototype cards, or modified options can give false errors and invalid system responses.

1. Obtain the failing symptoms in as much detail as possible.
2. Verify the symptoms by attempting to re-create the failure by running the diagnostic test or by repeating the same operation.
3. Use the following table with the verified symptom to determine which page to go to.

Symptoms (Verified)	Go To
Power On Issue	Page 150
No Display Issue	Page 151
LCD Failure	Page 153
Internal Keyboard Failure	Page 154
TouchPad Failure	Page 155
Internal Speaker Failure	Page 156
Internal Microphone Failure	Page 157
USB Failure	Page 159
Other Function Failure	Page 159

4. If the Issue is still not resolved, see "Online Support Information" on page 165.

Power On Issue

If the system doesn't power on, perform the following actions one at a time to correct the problem. Do not replace non-defective FRUs:

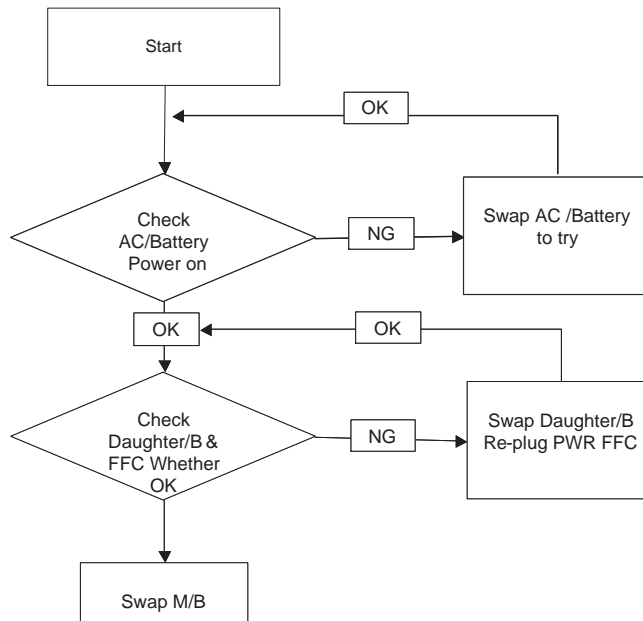

Computer Shuts down Intermittently

If the system powers off at intervals, perform the following actions one at a time to correct the problem.

1. Check the power cable is properly connected to the computer and the electrical outlet.
2. Remove any extension cables between the computer and the outlet.
3. Remove any surge protectors between the computer and the electrical outlet. Plug the computer directly into a known good electrical outlet.
4. Remove all external and non-essential hardware connected to the computer that are not necessary to boot the computer to the failure point.
5. Remove any recently installed software.
6. If the Issue is still not resolved, see "Online Support Information" on page 165.

No Display Issue

If the **Display** doesn't work, perform the following actions one at a time to correct the problem. Do not replace non-defective FRUs:

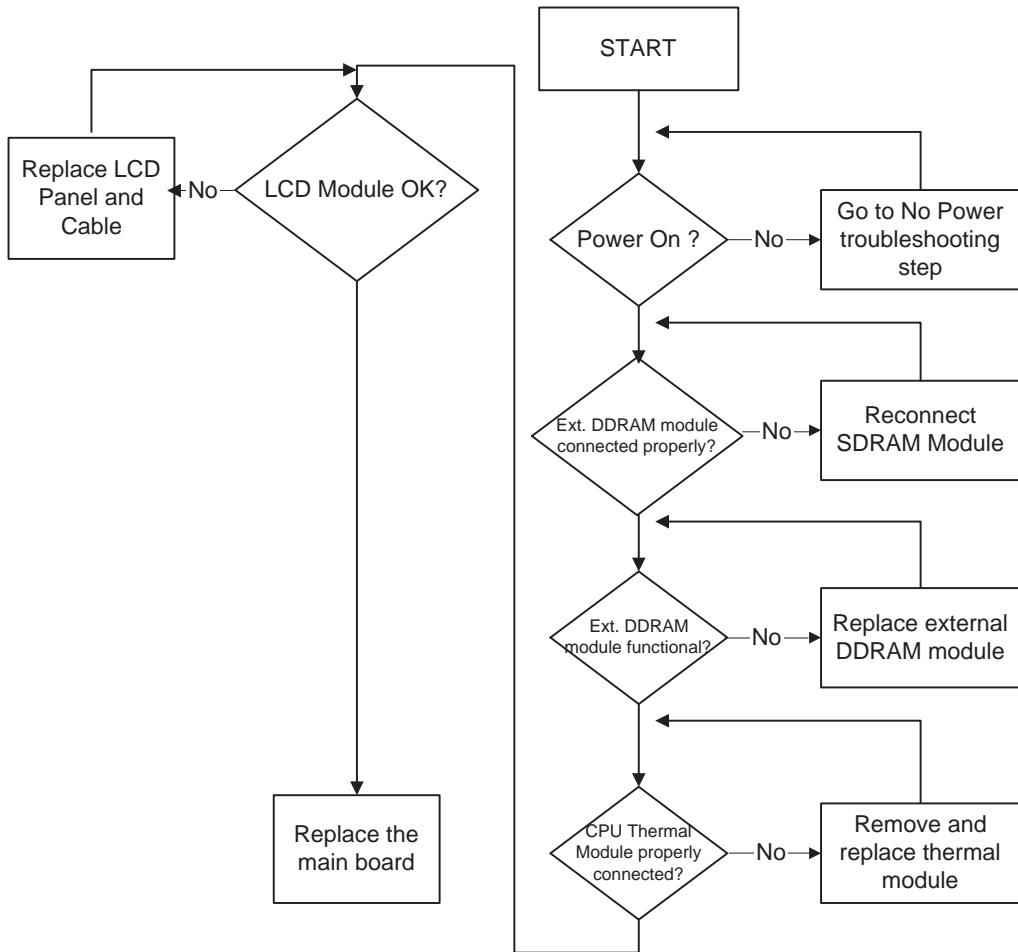

No POST or Video

If the POST or video doesn't display, perform the following actions one at a time to correct the problem.

1. Make sure that the internal display is selected. On this notebook model, switching between the internal display and the external display is done by pressing **Fn+F5**. Reference Product pages for specific model procedures.
2. Make sure the computer has power by checking at least one of the following occurs:
 - Fans start up
 - Status LEDs light up

If there is no power, see "Power On Issue" on page 150.

3. Drain any stored power by removing the power cable and battery and holding down the power button for 10 seconds. Reconnect the power and reboot the computer.
4. Connect an external monitor to the computer and switch between the internal display and the external display is by pressing **Fn+F5** (on this model).

If the POST or video appears on the external display, see "LCD Failure" on page 153.

5. Disconnect power and all external devices including port replicators or docking stations. Remove any memory cards and CD/DVD discs. Restart the computer.

If the computer boots correctly, add the devices one by one until the failure point is discovered.

6. Reseat the memory modules.
7. Remove the drives (see “Disassembly Process” on page 34).
8. If the Issue is still not resolved, see “Online Support Information” on page 165.

Abnormal Video Display

If video displays abnormally, perform the following actions one at a time to correct the problem.

1. Reboot the computer.
2. If permanent vertical/horizontal lines or dark spots display in the same location, the LCD is faulty and should be replaced. See “Disassembly Process” on page 34.
3. If extensive pixel damage is present (different colored spots in the same locations on the screen), the LCD is faulty and should be replaced. See “Disassembly Process” on page 34.
4. Adjust the brightness to its highest level. See the User Manual for instructions on adjusting settings.
NOTE: Ensure that the computer is not running on battery alone as this may reduce display brightness.

If the display is too dim at the highest brightness setting, the LCD is faulty and should be replaced. See “Disassembly Process” on page 34.

5. Check the display resolution is correctly configured:
 - a. Minimize or close all Windows.
 - b. If display size is only abnormal in an application, check the view settings and control/mouse wheel zoom feature in the application.
 - c. If desktop display resolution is not normal, right-click on the desktop and select **Personalize**→ **Display Settings**.
 - d. Click and drag the Resolution slider to the desired resolution.
 - e. Click **Apply** and check the display. Readjust if necessary.
6. Roll back the video driver to the previous version if updated.
7. Remove and reinstall the video driver.
8. Check the Device Manager to determine that:
 - The device is properly installed. There are no red Xs or yellow exclamation marks.
 - There are no device conflicts.
 - No hardware is listed under Other Devices.
9. If the Issue is still not resolved, see “Online Support Information” on page 165.
10. Run the Windows Memory Diagnostic from the operating system DVD and follow the onscreen prompts.
11. If the Issue is still not resolved, see “Online Support Information” on page 165.

Random Loss of BIOS Settings

If the computer is experiencing intermittent loss of BIOS information, perform the following actions one at a time to correct the problem.

1. If the computer is more than one year old, replace the CMOS battery.
2. Run a complete virus scan using up-to-date software to ensure the computer is virus free.
3. If the computer is experiencing HDD or ODD BIOS information loss, disconnect and reconnect the power and data cables between devices.

If the BIOS settings are still lost, replace the cables.

4. If HDD information is missing from the BIOS, the drive may be defective and should be replaced.
5. Replace the Motherboard.

6. If the Issue is still not resolved, see "Online Support Information" on page 165.

LCD Failure

If the **LCD** fails, perform the following actions one at a time to correct the problem. Do not replace non-defective FRUs:

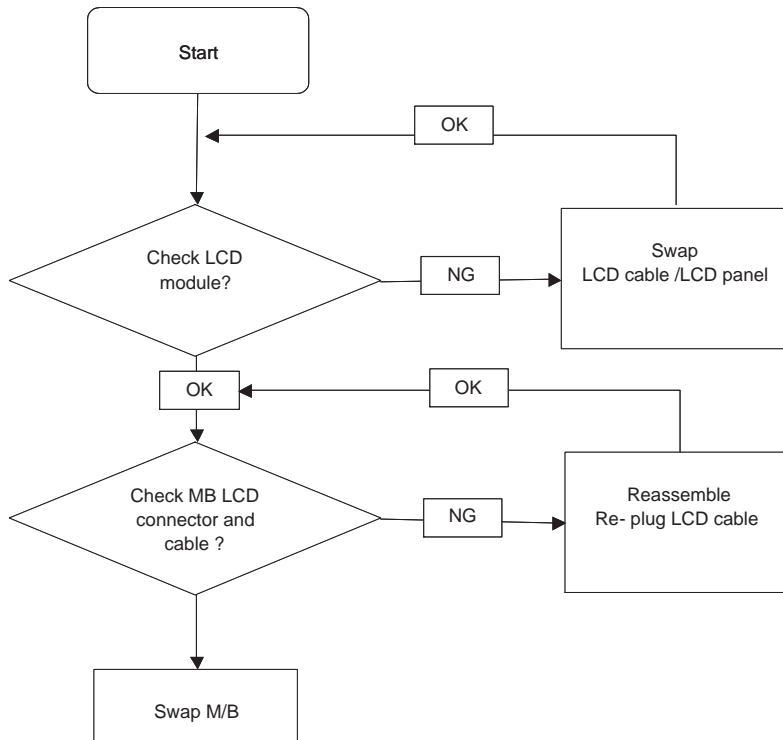

Built-In Keyboard Failure

If the built-in **Keyboard** fails, perform the following actions one at a time to correct the problem. Do not replace non-defective FRUs:

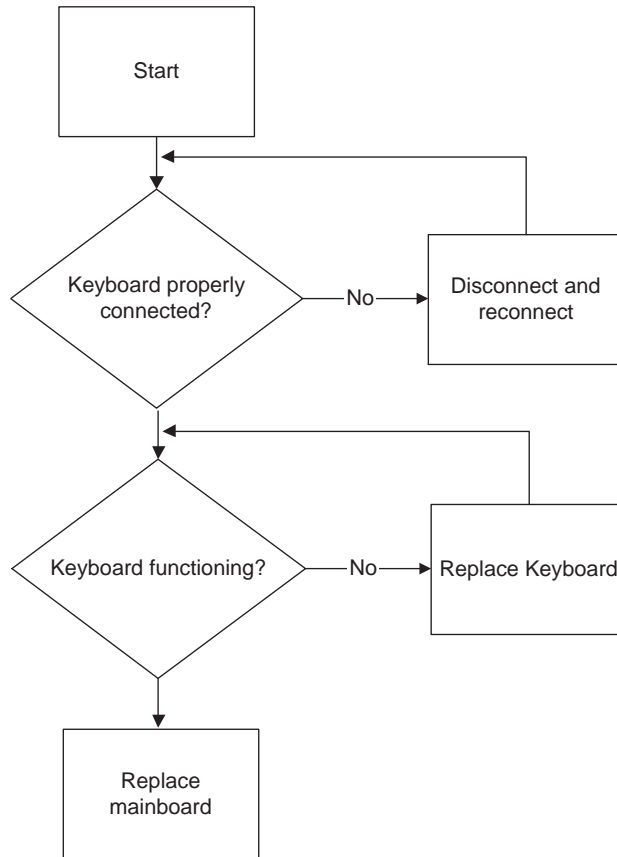

TouchPad Failure

If the **TouchPad** doesn't work, perform the following actions one at a time to correct the problem. Do not replace non-defective FRUs:

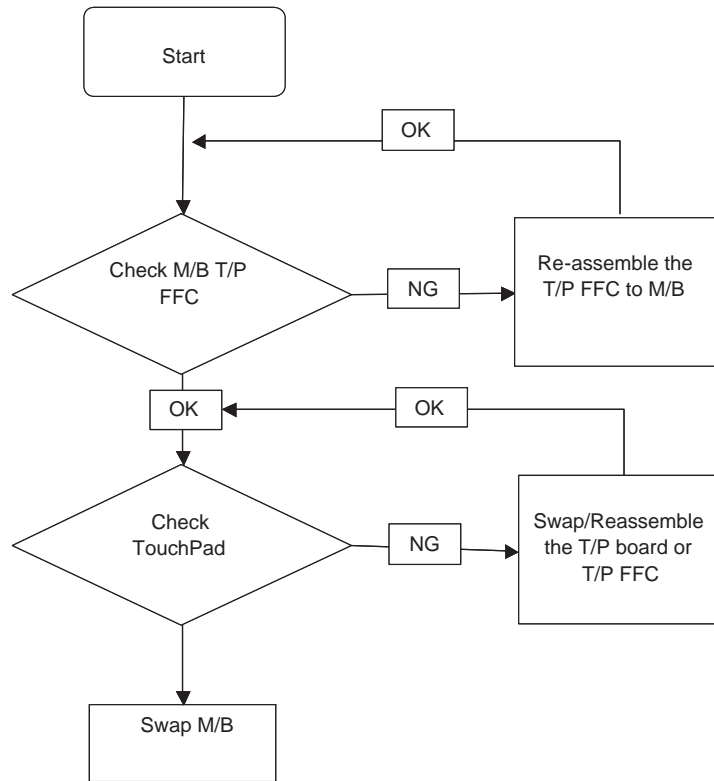

Internal Speaker Failure

If the internal **Speakers** fail, perform the following actions one at a time to correct the problem. Do not replace non-defective FRUs:

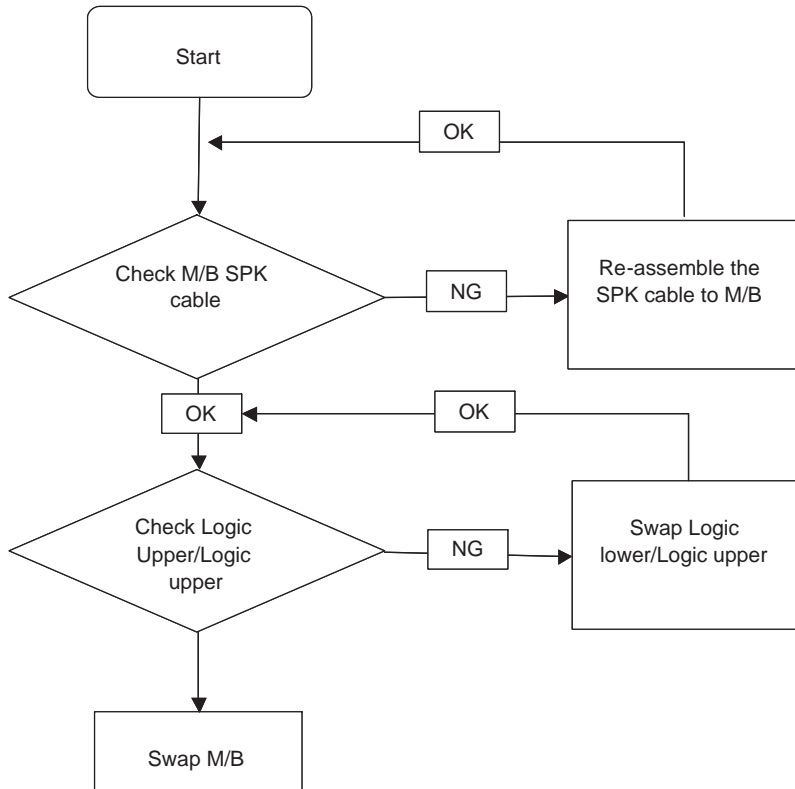

Sound Problems

If sound problems are experienced, perform the following actions one at a time to correct the problem.

1. Reboot the computer.
2. Navigate to **Start** → **Control Panel** → **System and Maintenance** → **System** → **Device Manager**. Check the Device Manager to determine that:
 - The device is properly installed.
 - There are no red Xs or yellow exclamation marks.
 - There are no device conflicts.
 - No hardware is listed under Other Devices.
3. Roll back the audio driver to the previous version, if updated recently.
4. Remove and reinstall the audio driver.
5. Ensure that all volume controls are set mid range:
 - a. Click the volume icon on the taskbar and drag the slider to 50. Ensure that the volume is not muted.
 - b. Click Mixer to verify that other audio applications are set to 50 and not muted.
6. Navigate to **Start** → **Control Panel** → **Hardware and Sound** → **Sound**. Ensure that Speakers are selected as the default audio device (green check mark).

NOTE: If Speakers does not show, right-click on the **Playback** tab and select **Show Disabled Devices** (clear by default).
7. Select Speakers and click **Configure** to start **Speaker Setup**. Follow the onscreen prompts to configure the speakers.

8. Remove and recently installed hardware or software.
9. Restore system and file settings from a known good date using **System Restore**.
If the issue is not fixed, repeat the preceding steps and select an earlier time and date.
10. Reinstall the Operating System.
11. If the Issue is still not resolved, see “Online Support Information” on page 165.

Internal Microphone Failure

If the internal **Microphone** fails, perform the following actions one at a time to correct the problem. Do not replace non-defective FRUs:

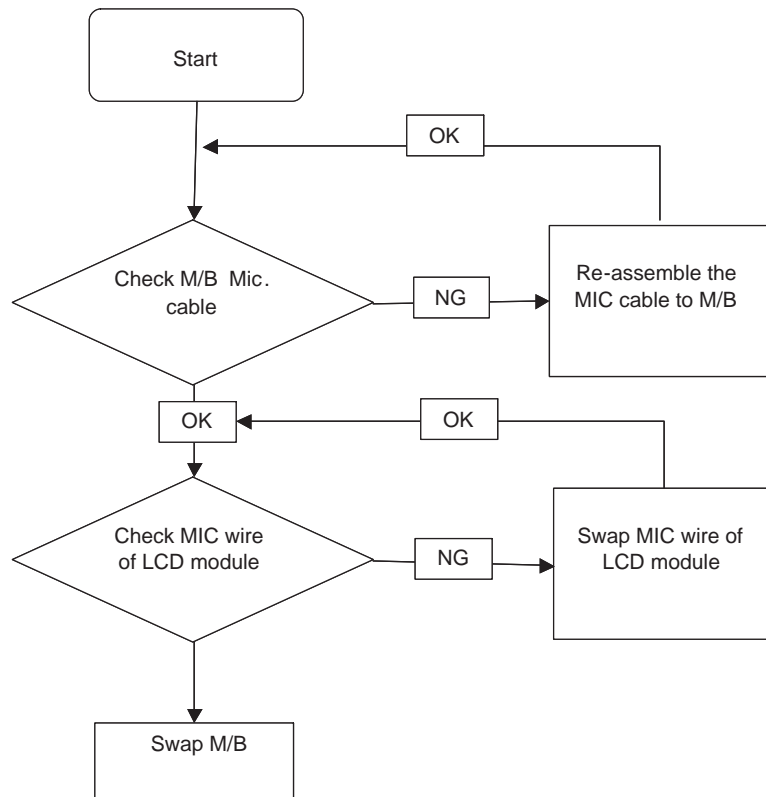

Microphone Problems

If internal or external **Microphones** do not operate correctly, perform the following actions one at a time to correct the problem.

1. Check that the microphone is enabled. Navigate to **Start** → **Control Panel** → **Hardware and Sound** → **Sound** and select the **Recording** tab.
2. Right-click on the **Recording** tab and select **Show Disabled Devices** (clear by default).
3. The microphone appears on the **Recording** tab.
4. Right-click on the microphone and select **Enable**.
5. Select the microphone then click **Properties**. Select the **Levels** tab.
6. Increase the volume to the maximum setting and click **OK**.
7. Test the microphone hardware:
 - a. Select the microphone and click **Configure**.
 - b. Select **Set up microphone**.

-
- c. Select the microphone type from the list and click **Next**.
 - d. Follow the onscreen prompts to complete the test.
8. If the Issue is still not resolved, see “Online Support Information” on page 165.

HDD Not Operating Correctly

If the **HDD** does not operate correctly, perform the following actions one at a time to correct the problem.

1. Disconnect all external devices.
2. Run a complete virus scan using up-to-date software to ensure the computer is virus free.
3. Run the Windows Vista Startup Repair Utility:
 - a. insert the Windows Vista Operating System DVD in the ODD and restart the computer.
 - b. When prompted, press any key to start to the operating system DVD.
 - c. The **Install Windows** screen displays. Click **Next**.
 - d. Select **Repair your computer**.
 - e. The **System Recovery Options** screen displays. Click **Next**.
 - f. Select the appropriate operating system, and click **Next**.

NOTE: Click **Load Drivers** if controller drives are required.

- g. Select **Startup Repair**.
- h. Startup Repair attempts to locate and resolve issues with the computer.
- i. When complete, click **Finish**.

If an issue is discovered, follow the onscreen information to resolve the problem.

4. Run the Windows Memory Diagnostic Tool. For more information see Windows Help and Support.
5. Restart the computer and press F2 to enter the BIOS Utility. Check the BIOS settings are correct and that CD/DVD drive is set as the first boot device on the Boot menu.
6. Ensure all cables and jumpers on the HDD and ODD are set correctly.
7. Remove any recently added hardware and associated software.
8. Run the Windows Disk Defragmenter. For more information see Windows Help and Support.
9. Run Windows Check Disk by entering **chkdsk /r** from a command prompt. For more information see Windows Help and Support.
10. Restore system and file settings from a known good date using **System Restore**.

If the issue is not fixed, repeat the preceding steps and select an earlier time and date.
11. Replace the HDD. See “Disassembly Process” on page 34.

USB Failure (Right up/down side)

If the rightside **USB** port fails, perform the following actions one at a time to correct the problem. Do not replace non-defective FRUs:

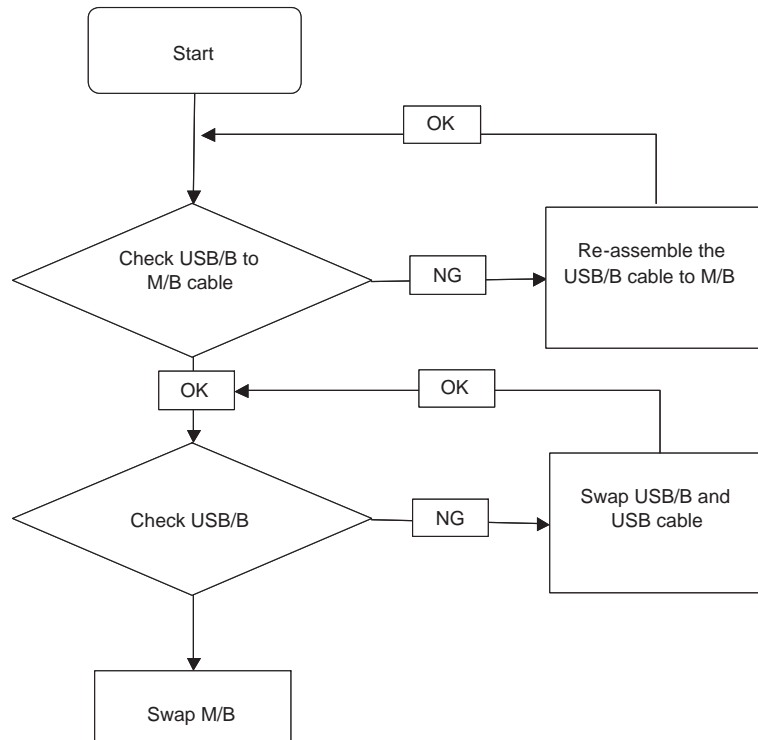

Other Failures

If the VGA board, LAN Port, external MIC or Speakers, PCI Express Card, 5-in-1 Card Reader or Volume Wheel fail, perform the following general steps to correct the problem. Do not replace non-defective FRUs:

1. Check whether the drive is OK.
2. Verify that the Test Fixture is ok.
3. Swap the mainboard and retest.

Intermittent Problems

Intermittent system hang problems can be caused by a variety of reasons that have nothing to do with a hardware defect, such as: cosmic radiation, electrostatic discharge, or software errors. FRU replacement should be considered only when a recurring problem exists.

When analyzing an intermittent problem, do the following:

1. Run the advanced diagnostic test for the system board in loop mode at least 10 times.
2. If no error is detected, do not replace any FRU.
3. If any error is detected, replace the FRU. Rerun the test to verify that there are no more errors.

Undetermined Problems

The diagnostic problems does not identify which adapter or device failed, which installed devices are incorrect, whether a short circuit is suspected, or whether the system is inoperative.

Follow these procedures to isolate the failing FRU (do not isolate non-defective FRU).

NOTE: Verify that all attached devices are supported by the computer.

NOTE: Verify that the power supply being used at the time of the failure is operating correctly. (See "Power On Issue" on page 150.):

1. Power-off the computer.
2. Visually check them for damage. If any problems are found, replace the FRU.
3. Remove or disconnect all of the following devices:
 - Non-Acer devices
 - Printer, mouse, and other external devices
 - Battery pack
 - Hard disk drive
 - DIMM
 - CD-ROM/Diskette drive Module
 - PC Cards
4. Power-on the computer.
5. Determine if the problem has changed.
6. If the problem does not recur, reconnect the removed devices one at a time until you find the failing FRU.
7. If the problem remains, replace the following FRU one at a time. Do not replace a non-defective FRU:
 - System board
 - LCD assembly

Post Codes

These tables describe the Post Codes and components of the POST process.

Sec:

NO_EVICTION_MODE_DEBUG EQU 1 (CommonPlatform\sec\la32\SecCore.inc)

0x C2	MTRR setup
0x C3	Enable cache
0x C4	Establish cache tags
0x C5	Enter NEM, Place the BSP in No Fill mode, set CR0.CD = 1, CR0.NW = 0.
0xCF	Cache Init Finished

Memory:

DEBUG_BIOS EQU 1 (Chipset\Alviso\MemoryInitAsm\IA32\IMEMORY.INC)

0x A0	First memory check point
0x 01	Enable MCHBAR
0x 02	Check for DRAM initialization interrupt and reset fail
0x 03	Verify all DIMMs are DDR or DDR2 and unbuffered
0x 04	Detect an improper warm reset and handle
0x 05	Detect if ECC SO-DIMMs are present in the system
0x 06	Verify all DIMMs are single or double sided and not asymmetric
0x 07	Verify all DIMMs are x8 or x16 width
0x 08	Find a common CAS latency between the DIMMS and the MCH
0x 09	Determine the memory frequency and CAS latency to program
0x 10	Determine the smallest common TRAS for all DIMMs
0x 11	Determine the smallest common TRP for all DIMMs
0x 12	Determine the smallest common TRCD for all DIMMs
0x 13	Determine the smallest refresh period for all DIMMs

0x 14	Verify burst length of 8 is supported by all DIMMs
0x 15	Determine the smallest tWR supported by all DIMMs
0x 16	Determine DIMM size parameters
0x 17	Program the correct system memory frequency
0x 18	Determine and set the mode of operation for the memory channels
0x 19	Program clock crossing registers
0x 20	Disable Fast Dispatch
0x 21	Program the DRAM Row Attributes and DRAM Row Boundary registers
0x 22	Program the DRAM Bank Architecture register
0x 23	Program the DRAM Timing & and DRAM Control registers
0x 24	Program ODT
0x 25	Perform steps required before memory init
0x 26	Program the receive enable reference timing control register Program the DLL Timing Control Registers, RCOMP settings
0x 27	Enable DRAM Channel I/O Buffers
0x 28	Enable all clocks on populated rows
0x 29	Perform JEDEC memory initialization for all memory rows
0x 30 0x 31	Perform steps required after memory init Program DRAM throttling and throttling event registers
0x 32	Setup DRAM control register for normal operation and enable
0x 33	Enable RCOMP
0x 34	Clear DRAM initialization bit in the SB
0x 35	Initialization Sequence Completed, program graphic clocks
0x AF	Disable access to the XMM registers

BDS & Specific action:

0x0 0	Report the legacy boot is happening
0x1 2	Wake up the APs
0x1 3	Initialize SMM Private Data and relocate BSP SMBASE
0x2 1 0x2 7	PC init begin at the stage1 Report every memory range do the hard ware ECC init
0x2 8	Report status code of every memory range
0x5 0	Get the root bridge handle
0x5 1	Notify pci bus driver starts to program the resource
0x5 8	Reset the host controller
0x5A	IdeBus begin initialization
0x7 0	Simple Text Output Protocol Functions(VGA class reset)
0x7 1	Report that VGA Class driver is being disabled
0x7 2	Report that VGA Class driver is being enabled
0x7 8	Terminal Console In reset and Console Out reset
0x7 9	Report that the remote terminal is being disabled
0x7A	Report that the remote terminal is being enabled
0x9 0	Keyboard reset
0x9 1	USB Keyboard disable
0x9 2	Keyboard detection
0x9 3	Report that the usb keyboard is being enabled
0x9 4	Clear the keyboard buffer
0x9 5	Init Keyboard
0x9 8	Mouse reset

0x99 0x9A	Mouse disable Detect PS2 mouse
0x9B	Report that the mouse is being enabled
0xB8	Peripheral removable media reset(ex:IsaFloppy, USB device)
0xB9	Peripheral removable media disable
0xBB	Peripheral removable media enable
0xE4	Report Status Code here for DXE_ENTRY_POINT once it is available
0xF8	Report that ExitBootServices() has been called
0xF9	Runtime driver set virtual address map

Each PEIM entry point used in 80_PORT

0x00	
0x01	PEI_EVENT_LOG
0x02	PEI_OEM_SERVICE
0x03	PEI_SIO_INIT
0x04	PEI_MONO_STATUS_CODE
0x05	PEI_CPU_IO_PCI_CFG
0x06	PEI_CPU_IO
0x07	PEI_PCI_CFG
0x08	PEI_CPU_PEIM
0x09	PEI_PLATFORM_STAGE1
0x0A	PEI_VARIABLE
0x0B 0x0C	PEI_SB_INIT PEI_CAPSULE
0x0D	PEI_PLATFORM_STAGE2
0x0E	PEI_SB_SMBUS_ARP_DISABLED
0x0F	PEI_HOST_TO_SYSTEM
0x10	PEI_MEMORY_INIT

0x11	PEI_S3_RESUME
0x12	PEI_CLOCK_GEN
0x13	PEI_OP_PRESENCE
0x14	PEI_TPM_TCG
0x15	PEI_FIND_FV
0x16	PEI_H2O_DEBUG_IO
0x17	PEI_H2O_DEBUG_COMM
0x18	PEI_SMM_CONTROL
0x19~0x1F	PEI_RESERVED
0x20~0x2E	PEI_OEM_DEFINED
0x2F	PEI_DXE_IPL

Each Driver entry point used in 80_PORT

0x30	RESERVED
0x31	DXE_CRC32_SECTION_EXTRACT
0x32	SCRIPT_SAVE
0x33	ACPI_S3_SAVE
0x34	SMART_TIMER
0x35	JPEG_DECODER
0x36	PCX_DECODER
0x37	HT_CPU / MP_CPU
0x38	LEGACY_METRONOME
0x39	FTWLITE
0x3A	RUN_RIME
0x3B	MONOTONIC_COUNTER
0x3C	WATCH_DOG_TIMER

0x3D	SECURITY_STUB
0x3E	DXE_CPU_IO
0x3F	CF9_RESET
0x40	PC_RTC
0x41	STATUS_CODE
0x42	VARIABLE
0x43	EMU_VARIABLE
0x44	DXE_CHIPSET_INIT
0x45	DXE_ALERT_FORMAT
0x46	PCI_HOST_BRIDGE
0x47	PCI_EXPRESS
0x48	DXE_SB_INIT
0x49	IDE_CONTROLLER
0x4A 0x4B	SATA_CONTROLLER SB_SM_BUS
0x4C	ISA_ACPI_DRIVER
0x4D	ISA_BUS
0x4E	ISA_SERIAL
0x4F	IDE_BUS
0x50	PCI_BUS
0x51	BOOT_PRIORITY
0x52	FVB_SERVICE
0x53	ACPI_PLATFORM
0x54	PCI_HOT_PLUG
0x55	DXE_PLATFORM

0x56	PLATFORM_IDE
0x57	SMBIOS
0x58	MEMORY_SUB_CLASS
0x59	MISC_SUB_CLASS
0x5A	CON_PLATFORM
0x5B	SAVE_MEMORY_CONFIG
0x5C	ACPI_SUPPORT
0x5D	CON_SPLITTER_UGA_VGA / CON_SPLITTER
0x5E	VGA_CLASS
0x5F	DATA_HUB
0x60	DISK_IO
0x61 0x62	MEMORY_TEST CRISIS_RECOVERY
0x63	LEGACY_8259
0x64	LEGACY_REGION
0x65	LEGACY_INTERRUPT
0x66	BIOS_KEYBOARD
0x67	BIOS_VEDIO
0x68	MONITER_KEY
0x69	LEGACY_BIOS
0x6A	LEGACY_BIOS_PLATFORM
0x6B	PCI_PLATFORM
0x6C	ISA_FLOOPY
0x6D	PS2_MOUSE
0x6E	USB_BOT
0x6F	USB_CBIO

0x70	USB_CBI1
0x71	USB_KB
0x72	USB_MASS_STORAGE
0x73	BUS_PCI_UHCI
0x74	USB_MOUSE
0x75	USB_BUS
0x76	SETUP_UTILITY
0x77	FW_BLOCK_SERVICE
0x78 0x79	USB_LEGACY_PLATFORM GRAPHICS_CONSOLE
0x7A	TERMINAL
0x7B	DATA_HUB_STD_ERR
0x7C	FAT
0x7D	PARTITION
0x7E	ENGLISH
0x7F	FRENCH
0x80	HII_DATABASE
0x81	SETUP_BROWSER
0x82	OEM_SETUP_BROWSER
0x83	OEM_BADGING_SUPPORT
0x84	LEGACY_MOUSE
0x85	BIOS_SNP16
0x86	BUS_PCI_UNDI
0x87	SETUP_MOUSE
0x88	OEM_SETTING

0x89	MONITOR_KEY
0x8A	PLATFORM_BDS
0x8B	FAULT_TOLERANT_WRITE
0x8C	UPDATE_DISPATCHER
0x8D	CHINESE
0x8E	TPM_S3_Resume
0x8F 0x90	USB_EHCI SNP_32_64
0x91	PXE_BC
0x92	PXE_DHCP4
0x93	EBC
0x94~0x9F	RESERVED
0xA0	DXE_H2O_DEBUG_IO
0xA1	DXE_H2O_DEBUG_IO
0xA2	DXE_TPM_TCG
0xA3	DXE_TPM_PHYSICAL_PRESENCE
0xA4	DXE_OEM_SERVICE
0xA5	DXE_EVENT_LOG
0xA6 0xA7	DXE_SECURITY_HDD_PASSWORD_SERVICE DXE_LAN_ASF_INIT
0xA8	DXE_BUS_PCI_SERIAL
0xA9	DXE_LAN_IDER_CONTROLLER
0xAA	DXE_LAN_AMT
0xAB	DXE_SECURITY_SYSTEM_PASSWORD_SERVICE
0xAC	DXE_SECURITY_PASSWORD_CONSOLE
0xAD	DXE_DATA_HUB_RECORD_POLICY
0xAE	DXE_TPM_DRIVER
0xAF	RESERVED
0xB0 0xB1	JAPANESE DXE_UNICODE_COLLATION

Each SmmDriver entry point used in 80_PORT

0xC0	SMM_ACCESS
-------------	------------

0xC1	SMM_CONTROL
0xC2	SMM_BASE
0xC3	SMMAP
0xC4	SMMCORE
0xC5	SMM_DISPATCH
0xC6	SMM_START
0xC7	SMM_RUNTIME
0xC8	SB_SMM_DISPATCH
0xC9	SMM_THUNK
0xCA	SMM_ACPI_SW_CHILD
0xCB	SMM_SB_S3_SAVE
0xCC	SMM_PLATFORM
0xCD 0xCE	SMM_GMCH_MBI SMM_FW_BLOCK_SERVICE
0xCF	SMM_VARIABLE
0xD0	SMM_IHISI
0xD1	SMM_INT15_MICROCODE
0xD2	SMM_PNP
0xD3	SMM_USB_LEGACY
0xD4	SMM_INT13_HDD
0xD5	SMM_INIT_PPM
0xD6	SMM_OHCI1394
0xD7	SMM_SECURITY_HDD_PASSWORD_SERVICE
0xD8	SMM_OEM_SERVICE
0xD9	SMM_PPM
0xDA	SMM_DIGITAL_THERMAL_SENSOR

Jumper and Connector Locations

Mainboard Top View

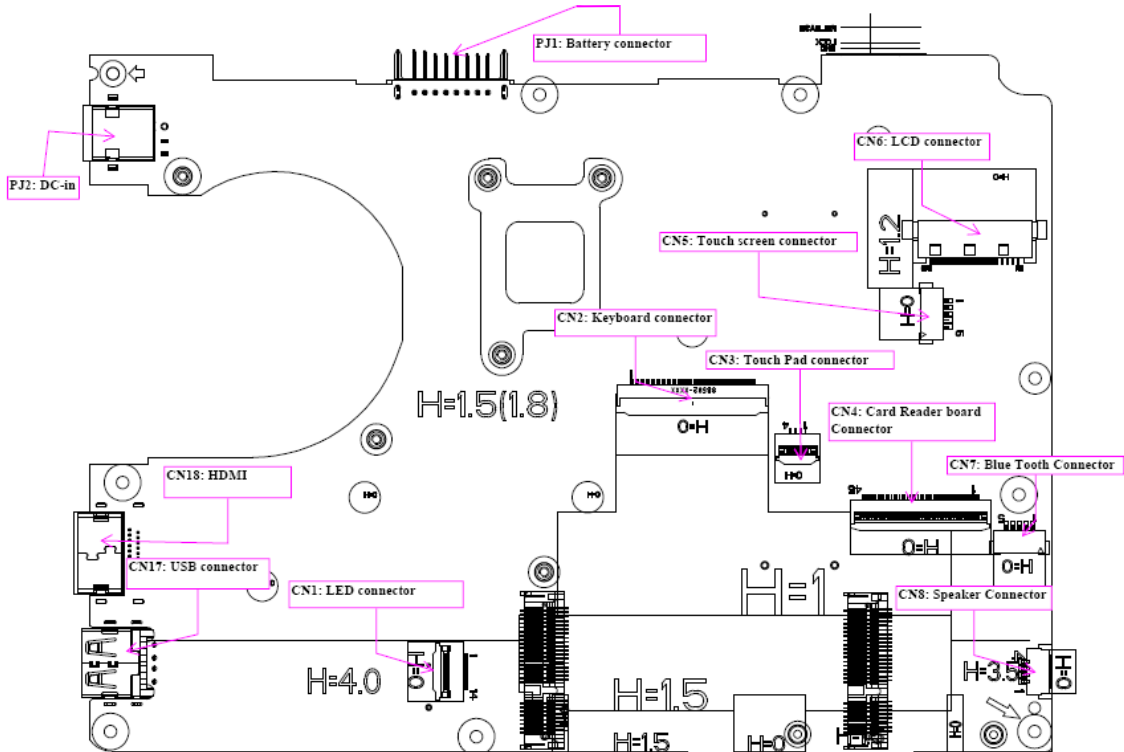

Item	Description	Item	Description
PJ2	DC-in	CN1	LED connector
PJ1	Battery connector	CN17	USB connector
CN6	LCD connector	CN18	HDMI
CN5	Touchscreen connector	CN2	Keyboard connector
CN7	Bluetooth connector	CN3	Touchpad connector
CN8	Speaker connector	CN4	Card reader board connector

Mainboard Bottom View

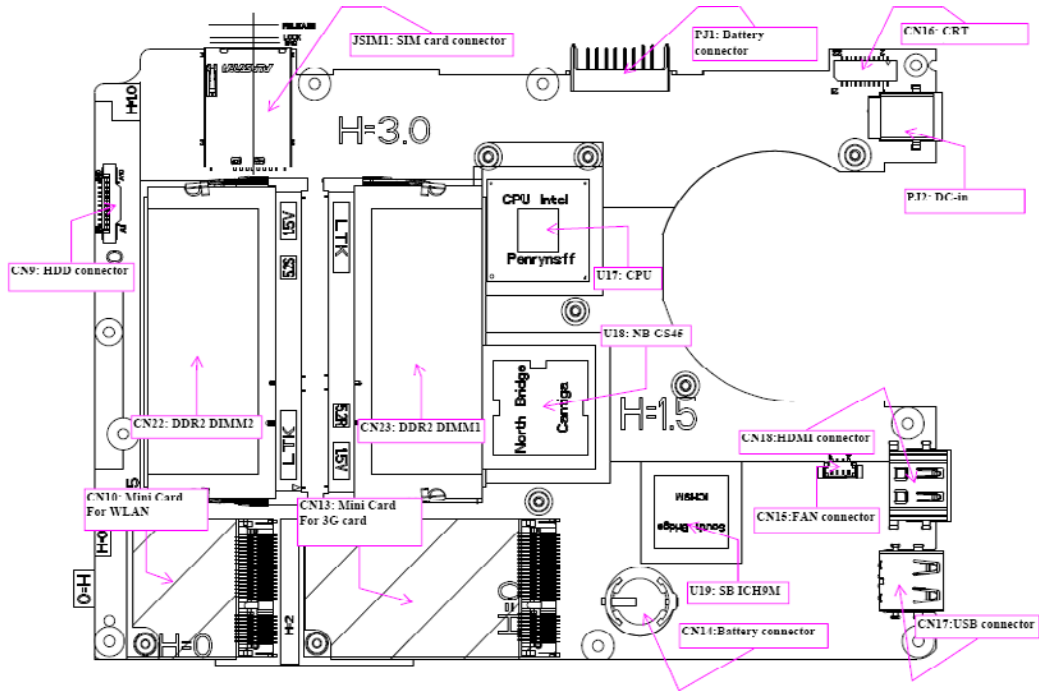

Item	Description	Item	Description
CN9	HDD connector	CN17	USB connector
JSIM1	SIM card connector	CN14	RTC battery connector
PJ1	Battery connector	CN13	Mini-card for 3G
CN16	CRT	CN10	Mini-card for WLAN
PJ2	DC-in	CN22	DDR2 DIMM2
U17	CPU	CN23	DDR2 DIMM1
U18	North Bridge GS45	U19	SB ICH9M
CN18	HDMI connector	CN15	Fan connector

Clearing Password Check and BIOS Recovery

This section provides a procedure for clearing the password and BIOS. The Hardware Open Gap on the mainboard clears the CMOS of all user settings and restores factory defaults.

Mainboard CMOS Discharge

Discharging the CMOS clears all user settings.

1. Disassemble the notebook and take out the Mainboard. See “Removing the Mainboard” on page 69.
2. Remove the RTC battery. See “Removing the RTC Battery” on page 73.

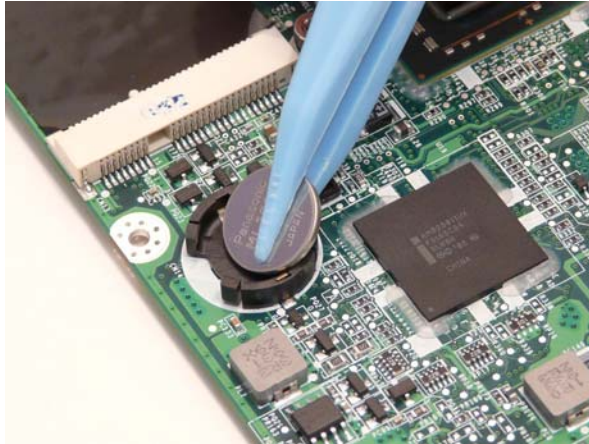

3. Turn the mainboard over, lift up the DIMM protective cover, and short the G3 pad.

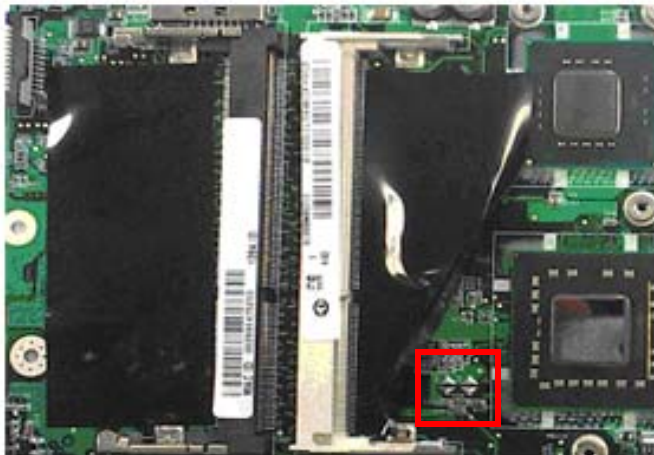

4. Reconnect the RTC battery and reassemble the unit.

BIOS Recovery by Crisis Disk

BIOS Recovery Boot Block

The BIOS Recovery Boot Block is a special block of BIOS. It is used to boot up the system with minimum BIOS initialization. Users can enable this feature to restore the BIOS firmware to the factory settings if a BIOS flash process fails.

BIOS Recovery Hotkey

The system provides a function hotkey: **Fn+Esc**, to enable the BIOS Recovery process when a system is powered on during BIOS POST. To use this function, it is strongly recommended to have the AC adapter and Battery present. If this function is enabled, the system will force the BIOS to enter a special BIOS block, called Boot Block.

Steps for BIOS Recovery from USB Storage

Before performing this procedure, prepare a Crisis USB key. The Crisis USB key can be made by executing the Crisis Disk program in a functioning system with a Windows XP, Vista or 7 OS.

IMPORTANT:The Crisis Disk program will overwrite all data on any drive that you use as a crisis disk.

Follow the steps below:

1. Modify the archive name from **ZE8 bios** to **ZE8X64.fd**
2. Save ROM file (file name: **ZE8X64.fd**) to the root directory of the USB storage.
3. Plug the USB storage into a USB port of the machine to have the crisis utility run on.
4. Remove the battery and AC adaptor of the machine.
5. While pressing the **Fn + ESC** buttons plug in the AC adaptor and then press Power. Keep pressing **Fn+ESC** till the power button flashes.
The LED of the USB flash disk flashes for three (3) to seven (7) minutes.
When CRISIS is complete, the system auto restarts with a workable BIOS.
6. Update the latest version BIOS for this machine by the regular BIOS flashing process.

FRU (Field Replaceable Unit) List

This chapter gives you the FRU (Field Replaceable Unit) listing in global configurations of the computer. Refer to this chapter whenever ordering for parts to repair or for RMA (Return Merchandise Authorization).

Please note that WHEN ORDERING FRU PARTS, you should check the most up-to-date information available on your regional web or channel. For whatever reasons a part number change is made, it will not be noted on the printed Service Guide. For ACER AUTHORIZED SERVICE PROVIDERS, your Acer office may have a DIFFERENT part number code from those given in the FRU list of this printed Service Guide. You MUST use the local FRU list provided by your regional Acer office to order FRU parts for repair and service of customer machines.

NOTE: To scrap or to return the defective parts, you should follow the local government ordinance or regulations on how to dispose it properly, or follow the rules set by your regional Acer office on how to return it.

Exploded Diagrams

LCD

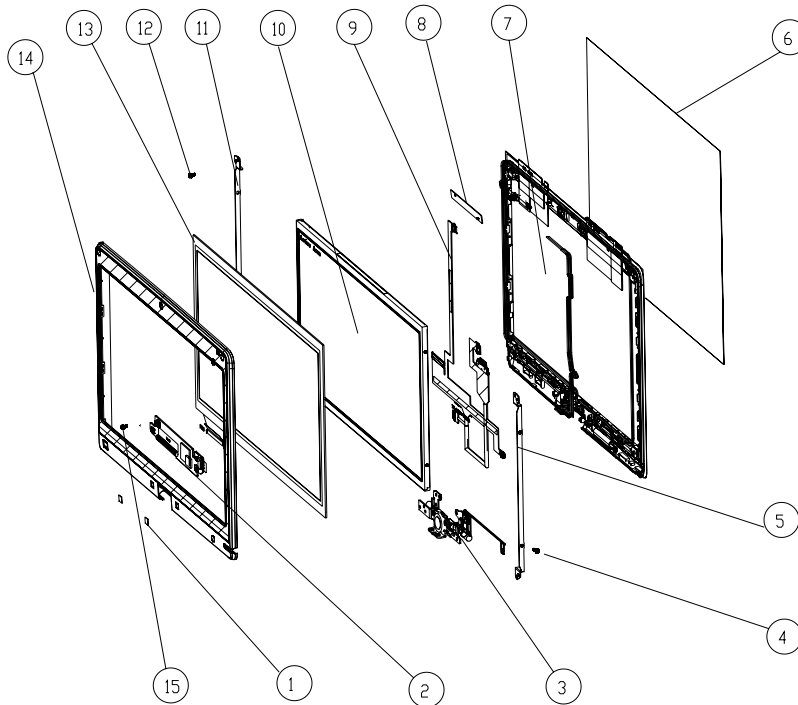

Item	Description	Acer Part No.
1	Screw cover	47.WGV07.009
2	Touchscreen board assembly	55.PND07.001
3	Center hinge	33.WGV07.001
4	LCD bracket screw	86.W0107.003
5	LCD bracket (right)	33.PND07.001
6	LCD cover protector	N/A
7	LCD cover assembly	6M.BGU07.001
8	Camera	57.PND07.001

Item	Description	Acer Part No.
9	LCD camera assembly	57.S6507.001
10	LCD panel	LK.11605.003
11	LCD bracket (left)	33.PND07.002
12	Screw	86.TPK07.001
13	Touch panel	56.PND07.004
14	Bezel	60.WGV07.004
15	Screw	86.TG607.004



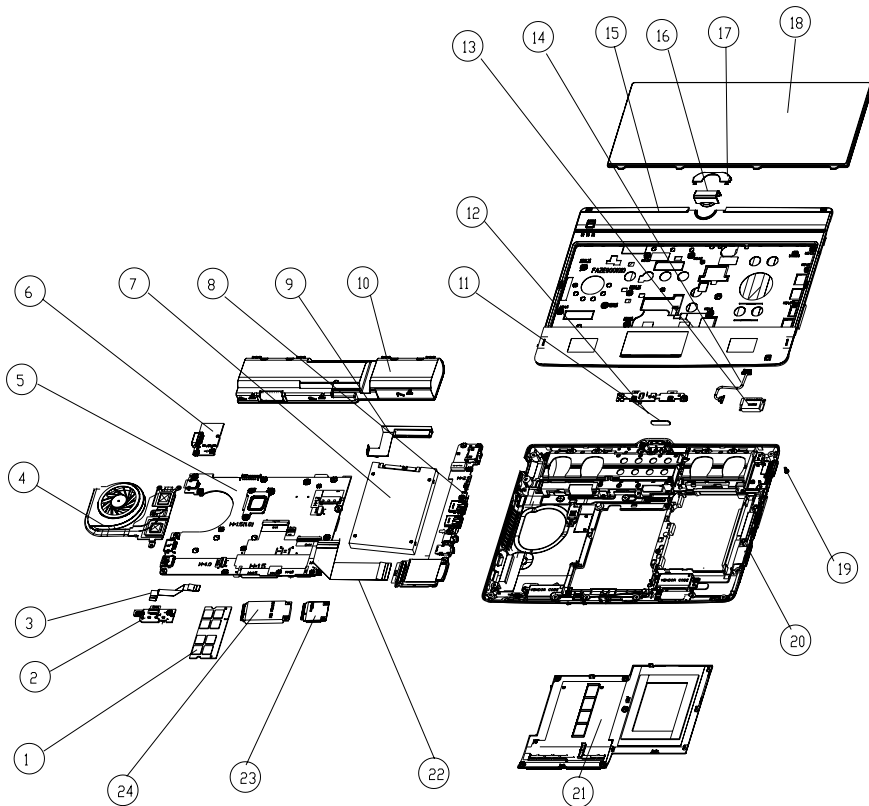





Main Chassis



Item	Description	Acer Part No.
1	DIMM module	KN.1GB03.031
2	LED assembly	55.WGV07.002
3	LED FCC cable	50.PL907.002
4	Thermal module assembly	60.PL907.004
5	CPU	N/A
6	CRT Board assembly	55.WGV07.001
7	Hard disk drive	KH.16004.006
8	I/O board	55.WGV07.003
9	HDD FPC cable	50.PL907.005
10	Battery	BT.00603.105
11	Base screw rubber	47.WGV07.003





Item	Description	Acer Part No.
12	Button board assembly	55.PL907.004
13	Bluetooth module	BT.21100.006
14	Bluetooth cable	50.PL907.001
15	Upper Cover	60.WGV07.005
16	Hinge cap	42.WGV07.002
17	Top cap	42.WGV07.004
18	Keyboard	KB.I110G.026
19	Screw	86.TG607.004
20	Lower cover	60.WGV07.002
21	HDD door	42.WGV07.001
22	I/O board FCC cable	50.PL907.004
23	WLAN Module	NI.23600.046
24	3G Module	LC.21300.011



FRU List

CATEGORY	PARTNAME	ACERPARTNO.
ADAPTER		
	ADAPTER DELTA 30W 19V 1.7X5.5X11 BLACK ADP-30JH BA LF	AP.03001.001
	ADAPTER LITE-ON 30W 1.7X5.5X11 BLACK PA-1300-04AC LF	AP.03003.001
	ADAPTER HIPRO 30W 19V 1.7X5.5X11 BLACK HP-A0301R3 B1LF LF	AP.0300A.001
BATTERY		
	Battery SANYO UM-2009F Li-Ion 3S2P SANYO 6 cell 5600mAh Main COMMON	BT.00603.105
	Battery SIMPLO UM-2009F Li-Ion 3S2P SAMSUNG 6 cell 5600mAh Main COMMON ID:UM09F70	BT.00607.114
BOARD		
	TP BOARD	55.PL907.004
	TOUCH PANEL CONTROL BOARD	55.PND07.001
	CRT BOARD	55.WGV07.001
	LED BOARB	55.WGV07.002
	CARD READER BOARD	55.WGV07.003
	Foxconn Bluetooth BRM 2046 BT2.1 (T60H928.33) f/w:861	BH.21100.004
	Lan Intel WLAN 112BN.HMWG MM#903341	KI.CPH01.001
	Lan Intel WLAN 512AN_HMWG Shirley Peak 5100 MM#895373	KI.SPH01.003
	Lan Intel WLAN 512AG_HMWG Shirley Peak 5100 MM#897072	KI.SPH01.005
	Foxconn Wireless LAN Atheros HB93 1x2 BGN (HM)	NI.23600.046
	Liteon Wireless LAN Atheris HB93 1x2 BGN (HM) WN6602AH	NI.23600.051
	Qualcomm Gobi2000	LC.21300.011
CABLE		
	POWER CORD UK 3PIN	27.A03V7.004



CATEGORY	PARTNAME	ACERPARTNO.
	POWER CORD US 3PIN ROHS	27.TAXV7.001
	BLUETOOTH CABLE	50.PL907.001
	FFC CABLE - LED/B TO MB	50.PL907.002
	CRT CABLE	50.PL907.003
	FFC CABLE - CARD READER/B TO MB	50.PL907.004
	HDD FPC CABLE	50.PL907.005
	FFC CABLE - TP TO TP/B	50.PL907.006
	FFC CABLE - MB TO TP/B	50.PL907.007
	ANTENNA - WIFI	50.PL907.008
	ANTENNA - 3G WIFI	50.PL907.009
	LCD CABLE 11.6 IN.	50.PND07.001
CASE/COVER/BRACKET ASSEMBLY		



CATEGORY	PARTNAME	ACERPARTNO.
	LCD BRACKET - R	33.PND07.001
	LCD BRACKET - L	33.PND07.002
	CENTER HINGE	33.WGV07.001
	SD DUMMY CARD BK	42.BCC07.004
	HDD COVER	42.WGV07.001
	HINGE CAP	42.WGV07.002
	TOP CAP BLACK	42.WGV07.004
	TOP CAP RED	42.WHJ07.001
	LCD COVER ASSY PB RED W/ANTENNA	60.BGU07.001
	LCD COVER ASSY PB RED W/3G ANTENNA	60.BGV07.001
	LCD BEZEL ASSY BLACK FOR PB	60.BGW07.001
	LCD COVER ASSY PB BLACK W/ANTENNA	60.BGW07.002
	LCD COVER ASSY PB BLACK W/3G ANTENNA	60.BGY07.001

CATEGORY	PARTNAME	ACERPARTNO.
	UPPER CASE ASSY BLACK W/TP , FFC*2	60.WGV07.001
	LOWER CASE ASSY W/SPEAKER FOR 3G	60.WGV07.002
	LOWER CASE ASSY W/SPEAKER FOR WIFI	60.WGV07.003
	LCD BEZEL ASSY BLACK FOR GW	60.WGV07.004
	LCD COVER ASSY GW BLACK W/ANTENNA	60.WGV07.005
	UPPER CASE ASSY RED W/TP , FFC*2	60.WHJ07.001
	LCD COVER ASSY GW RED W/ANTENNA	60.WHJ07.002
	LCD COVER ASSY GW BLACK W/3G ANTENNA	60.WHN07.001
	LCD COVER ASSY GW RED W/3G ANTENNA	60.WHP07.001
Camera		
	CAMERA MODULE	57.PND07.001

CATEGORY	PARTNAME	ACERPARTNO.
HDD/HARD DISK DRIVE		
	HDD TOSHIBA 2.5" 5400rpm 160GB MK1655GSX Libra SATA LF F/W: FG011J	KH.16004.006
	HDD HGST 2.5" 5400rpm 160GB HTS545016B9A300 Panther B SATA LF F/W:C60F Disk imbalance criteria = 0.014g-cm	KH.16007.026
	HDD WD 2.5" 5400rpm 160GB WD1600BEVT-22ZCTO ML160 SATA LF F/W:11.01A11	KH.16008.022
	HDD SEAGATE 2.5" 5400rpm 250GB ST9250315AS Wyatt SATA LF F/W:0001SDM1	KH.25001.016
	HDD TOSHIBA 2.5" 5400rpm 250GB MK2555GSX Libra SATA LF F/W:FG001J	KH.25004.003
	HDD HGST 2.5" 5400rpm 250GB HTS545025B9A300 Panther B SATA LF F/W:C60F Disk imbalance criteria = 0.014g-cm	KH.25007.016
	HDD WD 2.5" 5400rpm 250GB WD2500BEVT-22ZCT0 ML160 SATA LF F/W:11.01A11	KH.25008.021
	HDD SEAGATE 2.5" 5400rpm 320GB ST9320325AS Wyatt SATA LF F/W:0001SDM1	KH.32001.017
	HDD HGST 2.5" 5400rpm 320GB HTS545032B9A300 Panther B SATA LF F/W:C60F Disk imbalance criteria = 0.014g-cm	KH.32007.008
	HDD TOSHIBA 2.5" 5400rpm 500GB MK5055GSX Libra SATA LF F/W:FG001J	KH.50004.001
	HDD WD 2.5" 5400rpm 320GB WD3200BEVT-22ZCT0 ML160 SATA LF F/W:11.01A11	KH.32008.013
	HDD SEAGATE 2.5" 5400rpm 500GB ST9500325AS Wyatt SATA LF F/W:0001SDM1	KH.50001.011
	HDD WD 2.5" 5400rpm 500GB WD5000BEVT-22ZAT0 ML250 SATA LF F/W:01.01A01	KH.50008.013
	HDD HGST 2.5" 5400rpm 500GB HTS545050B9A300 Panther B SATA LF F/W:C60F Disk imbalance criteria = 0.014g-cm	KH.50007.010
HEATSINK		
	THERMAL MODULE	60.PL907.004

CATEGORY	PARTNAME	ACERPARTNO.
KEYBOARD		
	Keyboard GATEWAY GP1T SJM11 86KS Black Arabic Texture	KB.I110G.002
	Keyboard GATEWAY GP1T SJM11 87KS Black Belgium Texture	KB.I110G.003
	Keyboard GATEWAY GP1T SJM11 87KS Black Brazilian Portuguese Texture	KB.I110G.004
	Keyboard GATEWAY GP1T SJM11 87KS Black CZ/SK Texture	KB.I110G.005
	Keyboard GATEWAY GP1T SJM11 86KS Black Chinese Texture	KB.I110G.006
	Keyboard GATEWAY GP1T SJM11 87KS Black Danish Texture	KB.I110G.007
	Keyboard GATEWAY GP1T SJM11 87KS Black FR/Arabic Texture	KB.I110G.008
	Keyboard GATEWAY GP1T SJM11 87KS Black French Texture	KB.I110G.009
	Keyboard GATEWAY GP1T SJM11 87KS Black German Texture	KB.I110G.010
	Keyboard GATEWAY GP1T SJM11 86KS Black Greek Texture	KB.I110G.011
	Keyboard GATEWAY GP1T SJM11 87KS Black Hungarian Texture	KB.I110G.012
	Keyboard GATEWAY GP1T SJM11 87KS Black Italian Texture	KB.I110G.013
	Keyboard GATEWAY GP1T SJM11 91KS Black Japanese Texture	KB.I110G.014
	Keyboard GATEWAY GP1T SJM11 87KS Black Nordic Texture	KB.I110G.015
	Keyboard GATEWAY GP1T SJM11 87KS Black Norwegian Texture	KB.I110G.016
	Keyboard GATEWAY GP1T SJM11 87KS Black Portuguese Texture	KB.I110G.017
	Keyboard GATEWAY GP1T SJM11 86KS Black Russian Texture	KB.I110G.018
	Keyboard GATEWAY GP1T SJM11 87KS Black SLO/CRO Texture	KB.I110G.019
	Keyboard GATEWAY GP1T SJM11 87KS Black Spanish Texture	KB.I110G.020
	Keyboard GATEWAY GP1T SJM11 87KS Black Sweden Texture	KB.I110G.021
	Keyboard GATEWAY GP1T SJM11 87KS Black Swiss/G Texture	KB.I110G.022
	Keyboard GATEWAY GP1T SJM11 86KS Black Thailand Texture	KB.I110G.023
	Keyboard GATEWAY GP1T SJM11 87KS Black Turkish Texture	KB.I110G.024
	Keyboard GATEWAY GP1T SJM11 87KS Black UK Texture	KB.I110G.025
	Keyboard GATEWAY GP1T SJM11 86KS Black US International Texture	KB.I110G.026
	Keyboard GATEWAY GP1T SJM11 86KS Black US International w/ Hebrew Texture	KB.I110G.027
	Keyboard GATEWAY GP1T SJM11 87KS Black US w/ Canadian French Texture	KB.I110G.028

CATEGORY	PARTNAME	ACERPARTNO.
LCD		
	LCD MODULE ASSY NLED11.6WXGAG PB RED W/ ANTENNA	6M.BGU07.001
	LCD MODULE ASSY NLED11.6WXGAG PB RED W/3G ANTENNA	6M.BGV07.001
	LCD MODULE ASSY NLED11.6WXGAG PB BLACK W/ ANTENNA	6M.BGW07.001
	LCD MODULE ASSY NLED11.6WXGAG PB BLACK W/3G ANTENNA	6M.BGY07.001
	LCD MODULE ASSY NLED11.6WXGAG GW BLACK W/ ANTENNA	6M.WGV07.001
	LCD MODULE ASSY NLED11.6WXGAG GW RED W/ ANTENNA	6M.WHJ07.001
	LCD MODULE ASSY NLED11.6WXGAG GW BLACK W/3G ANTENNA	6M.WHN07.001
	LCD MODULE ASSY NLED11.6WXGAG GW RED W/3G ANTENNA	6M.WHP07.001
LCD PANEL W/TOUCH PANEL		
	LED LCD SAMSUNG 11.6" WXGAG LTN116AT01-A01 W/ TOUCH PANEL	56.PND07.001
	LED LCD AUO 11.6" WXGAG B116XW02 V0 1A (3G) W/ TOUCH PANEL	56.PND07.002
	LED LCD LPL 11.6" WXGAG LP116WH1-TLA1 W/TOUCH PANEL	56.PND07.003
	LED LCD CMO 11.6" WXGAG N116B6-L02 C2 W/TOUCH PANEL	56.PND07.004
MAINBOARD		
	Mainboard JM12_MS Intel G45 LF SU7300 w/o 3G	MB.PN306.001
	Mainboard JM12_MS Intel G45 LF SU7300 w/ 3G	MB.PN306.002
	Mainboard JM12_MS Intel G45 LF SU4100 w/o 3G	MB.PNA06.001
	Mainboard JM12_MS Intel G45 LF SU4100 w/ 3G	MB.PNA06.002
	Mainboard JM12_MS Intel G45 LF SU2300 WO/3G W/O RAM	MB.PND06.001
	Mainboard JM12_MS Intel G45 LF SU2300 W/3G W/O RAM	MB.PND06.002

CATEGORY	PARTNAME	ACERPARTNO.
MEMORY		
	Memory NANYA SO-DIMM DDRIII 1066 1GB NT1GC64BH8A1PS-BE LF 64*16 0.07um	KN.1GB03.031
	Memory MICRON SO-DIMM DDRIII 1066 1GB MT8JSF12864HZ-1G1F1 LF 128*8 0.065um	KN.1GB04.015
	Memory KINGSTON SO-DIMM DDRIII 1066 1GB ACR128X64D3S1066C7 LF 128*8 0.07um	KN.1GB07.001
	Memory ELPIDA SO-DIMM DDRIII 1066 1GB EBJ10UE8BDS0-AE-F LF 128*8 0.065um	KN.1GB09.012
	Memory SAMSUNG SO-DIMM DDRIII 1066 1GB M471B2874DZ1-CF8 LF	KN.1GB0B.019
	Memory SAMSUNG SO-DIMM DDRIII 1066 1GB M471B2873EH1-CF8 LF 64*16 0.055um	KN.1GB0B.028
	Memory HYNIX SO-DIMM DDRIII 1066 1GB HMT112S6BFR6C-G7 N0 LF 64*16 0.055um	KN.1GB0G.025
	Memory NANYA SO-DIMM DDRIII 1066 2GB NT2GC64B8HA1NS-BE LF 128*8 0.07um	KN.2GB03.012
	Memory MICRON SO-DIMM DDRIII 1066 2GB MT16JSF25664HZ-1G1F1 LF 128*8 0.065um	KN.2GB04.015
	Memory KINGSTON SO-DIMM DDRIII 1066 2GB ACR256X64D3S1066C7 LF 128*8 0.07um	KN.2GB07.001
	Memory ELPIDA SO-DIMM DDRIII 1066 2GB EBJ21UE8BDS0-AE-F LF 128*8 0.065um	KN.2GB09.006
	Memory SAMSUNG SO-DIMM DDRIII 1066 2GB M471B5673DZ1-CF8 LF	KN.2GB0B.005
	Memory SAMSUNG SO-DIMM DDRIII 1066 2GB M471B5673EH1-CF8 LF 128*8 0.055um	KN.2GB0B.012
	Memory A-DATA SO-DIMM DDRIII 1066 2GB HY7YG1B1674ZM LF 128*8 0.065um	KN.2GB0C.002
	Memory HYNIX SO-DIMM DDRIII 1066 2GB HMT125S6BFR8C-G7 N0 LF 128*8 0.055um	KN.2GB0G.014
	Memory SAMSUNG SO-DIMM DDRIII 1066 4GB M471B5273BH1-CF8 LF 256*8 0.055um	KN.4GB0B.007
MIC PHONE		
	MIC	23.PND07.001
MISCELLANEOUS		
	LOWER CASE RUBBER FOOT - FRONT	47.WGV07.001
	LOWER CASE RUBBER FOOT - REAR	47.WGV07.002
	LOWER CASE SCREW RUBBER	47.WGV07.003
	LCD SUPPORT RUBBER	47.WGV07.004
	FRONT LENS RUBBER	47.WGV07.005
	UPPER CASE FRONT RUBBER BLACK	47.WGV07.006
	UPPER CASE REAR RUBBER BLACK	47.WGV07.007
	TOUCHPAD RUBBER BLACK	47.WGV07.008
	LCD BEZEL SCREW MYLAR	47.WGV07.009
	FOIL IN PANEL FOR 3G	47.WGV07.010

CATEGORY	PARTNAME	ACERPARTNO.
SPEAKER		
	SPEAKER SET	23.PL907.001

Screw List

Description	Acer Part Number
SCREW M2.0*3.0-I(BKAG)(NYLOK IRON	86.ARE07.002
SCREW M2*5-I(BZN)(NYLOK)	86.TG607.004
SCREW M2.0*2.5-I(BUWZN)	86.TPK07.001
SCREW 2.0*4.0	86.W0107.003
SCREW M2.0*3.0-I(NI)(NYLOK)	86.W0907.001

Model Definition and Configuration

Model	Acer Part No	Description	CPU	LCD	HDD 1(GB)	Wireless LAN1	Blue tooth
EC14T03j	LX.WG V02.011	EC14T03j W7HP64WJP1 UMACkk 1*2G/ 250/BT/6L2.8/ 5R/ CB_bgn_0.3D_B AG_AUk_JA11	CMSU2 300B	NLED11. 6WXGAG	N250GB5 .4KS	INT1000 H	BT 2.1
EC14T05a	LX.WG V02.010	EC14T05a W7HP64WTAU1 UMACkk 1*2G/ 250/BT/6L2.8/ 5R/ CB_bgn_0.3D_A Uk_ES61	PMDSU 4100B	NLED11. 6WXGAG	N250GB5 .4KS	INT1000 H	BT 2.1
EC14T03e	LX.WG V02.009	EC14T03e EM W7HP64EMWTE A3 UMACkk 2G+1G/250/ 6L2.8/5R/ CB_bgn_0.3D_A Uk_ES31	PMDSU 4100B	NLED11. 6WXGAG	N250GB5 .4KS	INT1000 H	N
EC14T02e	LX.WG V02.008	EC14T02e EM W7HP64EMWTE A1 UMACkk 2G+1G/250/ 6L2.8/5R/ CB_bgn_0.3D_A Uk_ES31	PMDSU 4100B	NLED11. 6WXGAG	N250GB5 .4KS	INT1000 H	N
EC14T05e	LX.WG V02.007	EC14T05e EM W7HP64EMWTE A3 UMACkk 2G+1G/320/ 6L2.8/5R/ CB_bgn_0.3D_A Uk_ES31	PMDSU 4100B	NLED11. 6WXGAG	N320GB5 .4KS	INT1000 H	N
EC14T04e	LX.WG V02.006	EC14T04e EM W7HP64EMWTE A1 UMACkk 2G+1G/320/ 6L2.8/5R/ CB_bgn_0.3D_A Uk_ES31	PMDSU 4100B	NLED11. 6WXGAG	N320GB5 .4KS	INT1000 H	N
EC14T01j	LX.WG V02.001	EC14T01j W7HP64WJP1 UMACkk 1*2G/ 250/BT/6L2.8/ 5R/ CB_bgn_0.3D_A U_JA11	CMSU2 300B	NLED11. 6WXGAG	N250GB5 .4KS	INT1000 H	BT 2.1

Model	Acer Part No	Description	CPU	LCD	HDD 1(GB)	Wireless LAN1	Blue tooth
EC14T02u	LX.WG V02.003	EC14T02u W7HP64WTUS1 UMACKk 2G+1G/ 250/6L2.8/5R/ CB_bgn_0.3D_A Uk_ENP1	PMDSU 4100B	NLED11. 6WXGAG	N250GB5 .4KS	INT1000 H	N
EC14T05u	LX.WG V02.004	EC14T05u W7HP64WTUS1 UMACKk 2*2G/ 320/6L2.8/5R/ CB_bgn_0.3D_A Uk_ENP1	PMDSU 4100B	NLED11. 6WXGAG	N320GB5 .4KS	INT1000 H	N
EC14T01i	LX.WG V01.002	EC14T01i EM W7HB64EMWTP H1 UMACKk 1*2G/320/BT/ 6L2.8/5R/ CB_bgn_0.3D_B AG_AUk_ES61	PMDSU 4100B	NLED11. 6WXGAG	N320GB5 .4KS	INT1000 H	BT 2.1
EC14T02g	LX.WG V02.005	EC14T02g W7HP64WTSG1 UMACKk 1*2G/ 320/BT/6L2.8/ 5R/ CB_bgn_0.3D_A Uk_ES61	CMSU2 300B	NLED11. 6WXGAG	N320GB5 .4KS	INT1000 H	BT 2.1
EC14T01g	LX.WG V02.002	EC14T01g W7HP64WTSG1 UMACKk 1*2G/ 320/BT/6L2.8/ 5R/ CB_bgn_0.3D_A Uk_ES61	PMDSU 4100B	NLED11. 6WXGAG	N320GB5 .4KS	INT1000 H	BT 2.1
EC14T01c	LX.WG V01.001	EC14T01c W7HB64SCWTC N1 UMACKk 1*2G/250/6L2.8/ 5R/ CB_bgn_0.3D_A U_SC22	PMDSU 4100B	NLED11. 6WXGAG	N250GB5 .4KS	INT1000 H	N
EC14T04j	LX.WHJ 02.007	EC14T04j W7HP64WJP1 UMACrr 1*2G/ 250/BT/6L2.8/ 5R/ CB_bgn_0.3D_A Ur_JA11	CMSU2 300B	NLED11. 6WXGAG	N250GB5 .4KS	INT1000 H	BT 2.1
EC14T02j	LX.WHJ 02.006	EC14T02j W7HP64WJP1 UMACrr 1*2G/ 250/BT/6L2.8/ 5R/ CB_bgn_0.3D_B AG_AUr_JA11	CMSU2 300B	NLED11. 6WXGAG	N250GB5 .4KS	INT1000 H	BT 2.1

Model	Acer Part No	Description	CPU	LCD	HDD 1(GB)	Wireless LAN1	Blue tooth
EC14T01e	LX.WHJ02.005	EC14T01e EM W7HP64EMWTE A1 UMACrr 2G+1G/320/6L2.8/5R/ CB_bgn_0.3D_A Ur_ES31	PMDSU 4100B	NLED11.6WXGAG	N320GB5.4KS	INT1000H	N
EC14T04u	LX.WHJ02.002	EC14T04u W7HP64WTUS1 UMACrr 2*2G/320/6L2.8/5R/ CB_bgn_0.3D_A Ur_ENP1	PMDSU 4100B	NLED11.6WXGAG	N320GB5.4KS	INT1000H	N
EC14T03u	LX.WHJ02.001	EC14T03u W7HP64WTUS1 UMACrr 2G+1G/250/6L2.8/5R/ CB_bgn_0.3D_A Ur_ENP1	PMDSU 4100B	NLED11.6WXGAG	N250GB5.4KS	INT1000H	N
EC14T04a	LX.WHJ02.004	EC14T04a W7HP64WTAU1 UMACrr 1*2G/250/BT/6L2.8/5R/ CB_bgn_0.3D_A Ur_ES61	CMSU2 300B	NLED11.6WXGAG	N250GB5.4KS	INT1000H	BT 2.1
EC14T03a	LX.WHJ02.003	EC14T03a W7HP64WTAU1 UMACrr 1*2G/320/BT/6L2.8/5R/ CB_bgn_0.3D_A Ur_ES61	PMDSU 4100B	NLED11.6WXGAG	N320GB5.4KS	INT1000H	BT 2.1
EC14T02c	LX.WHJ01.001	EC14T02c W7HB64SCWTC N1 UMACrr 1*2G/250/6L2.8/5R/ CB_bgn_0.3D_A U_SC22	PMDSU 4100B	NLED11.6WXGAG	N250GB5.4KS	INT1000H	N
EC14T01u	LX.WG X02.001	EC14T01u W7HP64WTUS1 UMAGCkk 2G+1G/250/6L2.8/5R/ CB_bgn_0.3D_G 1KVER_AU_EN P7	PMDSU 4100B	NLED11.6WXGAG	N250GB5.4KS	INT1000H	N
EC14T02t	LX.WG X02.002	EC14T02t EM W7HP64EMWTT H1 UMAGCkk 2*2G/500_L/BT/6L2.8/5R/ CB_bgn_0.3D_G 2K_AU_TH41	PMDSU 4100B	NLED11.6WXGAG	N500GB5.4KS	INT1000H	BT 2.1

Model	Acer Part No	Description	CPU	LCD	HDD 1(GB)	Wireless LAN1	Blue tooth
EC18T01n	LX.WHL02.007	EC18T01n EM W7HP64EMWTI D1 UMACKk 2G+1G/320/BT/6L2.8/5R/ CB_n2_0.3D_BAG_AUK_ID22	C2DSU7300B	NLED11.6WXGAG	N320GB5.4KS	SP1x2H MW	BT 2.1
EC18T01c	LX.WHL01.002	EC18T01c W7HB64SCWTC N1 UMACKk 2*2G/320/6L2.8/5R/ CB_n2_0.3D_AUK_SC22	C2DSU7300B	NLED11.6WXGAG	N320GB5.4KS	SP1x2H MW	N
EC18T01g	LX.WHL02.004	EC18T01g W7HP64WTSG1 UMACKk 2*2G/500_L/BT/6L2.8/5R/ CB_n2_0.3D_BAG_AUK_ES61	C2DSU7300B	NLED11.6WXGAG	N500GB5.4KS	SP1x2H MW	BT 2.1
EC18T01u	LX.WHL02.003	EC18T01u W7HP64WTUS1 UMACKk 2*2G/500_L/6L2.8/5R/ CB_n2_0.3D_AUK_ENP1	C2DSU7300B	NLED11.6WXGAG	N500GB5.4KS	SP1x2H MW	N
EC18T04i	LX.WHL02.006	EC18T04i EM W7HP64EMWTP H1 UMACKk 1*2G/320/BT/6L2.8/5R/ CB_n2_0.3D_BAG_AUK_ES61	C2DSU7300B	NLED11.6WXGAG	N320GB5.4KS	SP1x2H MW	BT 2.1
EC18T03g	LX.WHL02.005	EC18T03g W7HP64WTSG1 UMACKk 1*2G/320/BT/6L2.8/5R/ CB_n2_0.3D_BAG_AUK_ES61	C2DSU7300B	NLED11.6WXGAG	N320GB5.4KS	SP1x2H MW	BT 2.1
EC18T01t	LX.WHL01.001	EC18T01t EM W7HB64EMWTT H1 UMACKk 2*2G/500_L/BT/6L2.8/5R/ CB_n2_0.3D_AUK_TH41	C2DSU7300B	NLED11.6WXGAG	N500GB5.4KS	SP1x2H MW	BT 2.1
EC18T02i	LX.WHL02.002	EC18T02i EM W7HP64EMWTP H1 UMACKk 1*2G/320/BT/6L2.8/5R/ CB_n2_0.3D_AUK_ES61	C2DSU7300B	NLED11.6WXGAG	N320GB5.4KS	SP1x2H MW	BT 2.1

Model	Acer Part No	Description	CPU	LCD	HDD 1(GB)	Wireless LAN1	Blue tooth
EC18T01h	LX.WHL02.001	EC18T01h W7HP64WTCA2 UMACkk 2*2G/ 320/BT/6L2.8/ 5R/ CB_n2_0.3D_AU_ENJ1	C2DSU7300B	NLED11.6WXGAG	N320GB5.4KS	SP1x2H MW	BT 2.1
EC18T02n	LX.WHM02.009	EC18T02n EM W7HP64EMWTI D1 UMACrr 2G+1G/320/BT/ 6L2.8/5R/ CB_n2_0.3D_BAG_AUr_ID22	C2DSU7300B	NLED11.6WXGAG	N320GB5.4KS	SP1x2H MW	BT 2.1
EC18T05g	LX.WHM02.008	EC18T05g W7HP64WTSG1 UMACrr 2*2G/ 500_L/BT/6L2.8/ 5R/ CB_n2_0.3D_BAG_AUr_ES61	C2DSU7300B	NLED11.6WXGAG	N500GB5.4KS	SP1x2H MW	BT 2.1
EC18T02u	LX.WHM02.003	EC18T02u W7HP64WTUS1 UMACrr 2*2G/ 500_L/6L2.8/5R/ CB_n2_0.3D_AUr_ENP1	C2DSU7300B	NLED11.6WXGAG	N500GB5.4KS	SP1x2H MW	N
EC18T03i	LX.WHM02.007	EC18T03i EM W7HP64EMWTP H1 UMACrr 1*2G/320/BT/ 6L2.8/5R/ CB_n2_0.3D_BAG_AUr_ES61	C2DSU7300B	NLED11.6WXGAG	N320GB5.4KS	SP1x2H MW	BT 2.1
EC18T04g	LX.WHM02.006	EC18T04g W7HP64WTSG1 UMACrr 1*2G/ 320/BT/6L2.8/ 5R/ CB_n2_0.3D_AUr_ES61	C2DSU7300B	NLED11.6WXGAG	N320GB5.4KS	SP1x2H MW	BT 2.1
EC18T02g	LX.WHM02.005	EC18T02g W7HP64WTSG1 UMACrr 2*2G/ 500_L/BT/6L2.8/ 5R/ CB_n2_0.3D_AUr_ES61	C2DSU7300B	NLED11.6WXGAG	N500GB5.4KS	SP1x2H MW	BT 2.1
EC18T05a	LX.WHM02.004	EC18T05a W7HP64WTAU1 UMACrr 2*2G/ 320/BT/6L2.8/ 5R/ CB_n2_0.3D_AUr_ES61	C2DSU7300B	NLED11.6WXGAG	N320GB5.4KS	SP1x2H MW	BT 2.1

Model	Acer Part No	Description	CPU	LCD	HDD 1(GB)	Wireless LAN1	Blue tooth
EC18T01i	LX.WH M02.00 2	EC18T01i EM W7HP64EMWTP H1 UMACrr 1*2G/320/BT/6L2.8/5R/ CB_n2_0.3D_AU_ES61	C2DSU 7300B	NLED11.6WXGAG	N320GB5.4KS	SP1x2H MW	BT 2.1
EC18T02t	LX.WH M01.00 1	EC18T02t EM W7HB64EMWTT H1 UMACrr 2*2G/500_L/BT/6L2.8/5R/ CB_n2_0.3D_AU_r_TH41	C2DSU 7300B	NLED11.6WXGAG	N500GB5.4KS	SP1x2H MW	BT 2.1
EC18T02h	LX.WH M02.00 1	EC18T02h W7HP64WTCA2 UMACrr 2*2G/320/BT/6L2.8/5R/ CB_n2_0.3D_AU_ENJ1	C2DSU 7300B	NLED11.6WXGAG	N320GB5.4KS	SP1x2H MW	BT 2.1

Test Compatible Components

This computer's compatibility is tested and verified by Acer's internal testing department. All of its system functions are tested under Windows®7 environment.

Refer to the following lists for components, adapter cards, and peripherals which have passed these tests. Regarding configuration, combination and test procedures, please refer to the Compatibility Test Report released by the Acer Mobile System Testing Department.

BRAND	Type	Description
3G		
	UNDP-1	3G UNDP-1
Qualcomm	Gobi1000-Verizon	Qualcomm Gobi1000-Verizon
Accessory		
	SJM12_MS GW Protection Bag	Accessory SJM12_MS +SJM13_MS GW Protection Bag
	SJM12_MS PB Protection Bag	Accessory SJM12_MS+SJM13_MS PB Protection Bag
	USB Bridge Dongle	Accessory USB Bridge dongle device - XSYNC
Adapter		
DELTA	30W	Adapter DELTA 30W 19V 1.7x5.5x11 Black ADP-30JH BA LF
HIPRO	30W	Adapter HIPRO 30W 19V 1.7x5.5x11 Black HP-A0301R3 B1LF LF
LITE-ON	30W	Adapter LITE-ON 30W 19V 1.7x5.5x11 Black PA-1300-04AC LF
Audio Codec		
Realtek	ALC269X	Realtek Audio Codec ALC269X
Battery		
SANYO	6CELL2.8	Battery SANYO UM-2009F Li-Ion 3S2P SANYO 6 cell 5600mAh Main COMMON
SIMPLO	6CELL2.8	Battery SIMPLO UM-2009F Li-Ion 3S2P SAMSUNG 6 cell 5600mAh Main COMMON ID:UM09F70
Bluetooth		
Foxconn	BT 2.1	Foxconn Bluetooth BRM 2046 BT2.1 (T60H928.33) f/w:861
Camera		
Chicony	0.3M LDV	Chicony 0.3M LDV Lilac_3GA (CNF9042-G)
Chicony	0.3M LDV	Chicony Camera Lilac_2G
Liteon	0.3M LDV	Liteon Camera Lily_2G
Suyin	0.3M LDV	Suyin Camera Rose_2G
Card Reader		
	5 in 1-Build in	5 in 1-Build in MS, MS Pro, SD, SC, XD
CPU		
INTEL	CMSU2300B	CPU Intel Celeron SU2300 BGA 1.2G 1M 800 10W R-0
INTEL	PMDSU4100B	CPU Intel Core2Dual SU4100 2M 800

BRAND	Type	Description
INTEL	C2DSU7300B	CPU Intel Core2Dual SU7300 3M 800 R-0
G sensor		
	LIS33DETR	G sensor LIS33DETR
HDD		
HGST	N160GB5.4KS	HDD HGST 2.5" 5400rpm 160GB Falcon B HTS543216L9SA00 SATA LF F/W:C40C
HGST	N160GB5.4KS	HDD HGST 2.5" 5400rpm 160GB HTS545016B9A300 Panther B SATA LF F/W:C60F Disk imbalance criteria = 0.014g-cm
HGST	N250GB5.4KS	HDD HGST 2.5" 5400rpm 250GB HTS545025B9A300 Panther B SATA LF F/W:C60F Disk imbalance criteria = 0.014g-cm
HGST	N320GB5.4KS	HDD HGST 2.5" 5400rpm 320GB HTS545032B9A300 Panther B SATA LF F/W:C60F Disk imbalance criteria = 0.014g-cm
HGST	N500GB5.4KS	HDD HGST 2.5" 5400rpm 500GB HTS545050B9A300 Panther B SATA LF F/W:C60F Disk imbalance criteria = 0.014g-cm
SEAGATE	N160GB5.4KS	HDD SEAGATE 2.5" 5400rpm 160GB ST9160314AS Wyatt SATA LF F/W:0001SDM1
SEAGATE	N250GB5.4KS	HDD SEAGATE 2.5" 5400rpm 250GB ST9250315AS Wyatt SATA LF F/W:0001SDM1
SEAGATE	N320GB5.4KS	HDD SEAGATE 2.5" 5400rpm 320GB ST9320325AS Wyatt SATA LF F/W:0001SDM1
SEAGATE	N500GB5.4KS	HDD SEAGATE 2.5" 5400rpm 500GB ST9500325AS Wyatt SATA LF F/W:0001SDM1
TOSHIBA	N160GB5.4KS	HDD TOSHIBA 2.5" 5400rpm 160GB MK1655GSX Libra SATA LF F/W: FG011J
TOSHIBA	N250GB5.4KS	HDD TOSHIBA 2.5" 5400rpm 250GB MK2555GSX Libra SATA LF F/W:FG001J
TOSHIBA	N500GB5.4KS	HDD TOSHIBA 2.5" 5400rpm 500GB MK5055GSX Libra SATA LF F/W:FG001J
WD	N160GB5.4KS	HDD WD 2.5" 5400rpm 160GB WD1600BEVT-22ZCT0 ML160 SATA LF F/W:11.01A11
WD	N250GB5.4KS	HDD WD 2.5" 5400rpm 250GB WD2500BEVT-22ZCT0 ML160 SATA LF F/W:11.01A11
WD	N320GB5.4KS	HDD WD 2.5" 5400rpm 320GB WD3200BEVT-22ZCT0 ML160 SATA LF F/W:11.01A11
WD	N500GB5.4KS	HDD WD 2.5" 5400rpm 500GB WD5000BEVT-22ZAT0 ML250 SATA LF F/W:01.01A01
Keyboard		
GATEWAY	GP-1T	Keyboard GATEWAY GP-1T SJM11 Internal 11 Standard Black NONE Texture
LAN		
Atheros	AR8131L	Atheros AR8131L
LCD		
AUO	NLED11.6WXGAG	LED LCD AUO 11.6" WXGA Glare B116XW02 V0 1A (3G) LF 200nit 8ms 500:1

BRAND	Type	Description
CMO	NLED11.6WXGAG	LED LCD CMO 11.6" WXGA Glare N116B6-L02 C2 LF 200nit 10ms 500:1
LPL	NLED11.6WXGAG	LED LCD LPL 11.6" WXGA Glare LP116WH1-TLA1 LF 200nit 8ms 500:1
SAMSUNG	NLED11.6WXGAG	LED LCD SAMSUNG 11.6" WXGA Glare LTN116AT01-A01 LF 200nit 8ms
MEM		
A-DATA	SO2GBIII10	Memory A-DATA SO-DIMM DDRIII 1066 2GB HY7YG1B1674ZM LF 128*8 0.065um
ELPIDA	SO1GBIII10	Memory ELPIDA SO-DIMM DDRIII 1066 1GB EBJ10UE8BDS0-AE-F LF 128*8 0.065um
ELPIDA	SO2GBIII10	Memory ELPIDA SO-DIMM DDRIII 1066 2GB EBJ21UE8BDS0-AE-F LF 128*8 0.065um
HYNIX	SO1GBIII10	Memory HYNIX SO-DIMM DDRIII 1066 1GB HMT112S6BFR6C-G7 N0 LF 64*16 0.055um
HYNIX	SO2GBIII10	Memory HYNIX SO-DIMM DDRIII 1066 2GB HMT125S6BFR8C-G7 N0 LF 128*8 0.055um
MICRON	SO1GBIII10	Memory MICRON SO-DIMM DDRIII 1066 1GB MT8JSF12864HZ-1G1F1 LF 128*8 0.065um
MICRON	SO2GBIII10	Memory MICRON SO-DIMM DDRIII 1066 2GB MT16JSF25664HZ-1G1F1 LF 128*8 0.065um
SAMSUNG	SO1GBIII10	Memory SAMSUNG SO-DIMM DDRIII 1066 1GB M471B2873EH1-CF8 LF 64*16 0.055um
SAMSUNG	SO2GBIII10	Memory SAMSUNG SO-DIMM DDRIII 1066 2GB M471B5673EH1-CF8 LF 128*8 0.055um
Modem		
	External USB Lite+LSI modem	External USB Lite+LSI modem
Chipset		
INTEL	GS45	NB Chipset Intel CS GS45NB
INTEL	ICH9M-SFFE	SB Chipset Intel CS AM82801IUX MM#898134
VGA Chip		
None	UMA	UMA (Intel)
WiFi Antenna		
WNC	PIFA	PIFA
Wiping Cloth		
	Wiping Cloth	Wiping Cloth Wiping Cloth BAP31-41-51 Wiping Cloth 15x15cm
Wireless LAN		
INTEL	INT1000H	Lan Intel WLAN 112BN.HMWG MM#903341
INTEL	SP1x2HMW	Lan Intel WLAN 512AN_HMWG Shirley Peak 5100 MM#895373

On-line Support Information

This section describes online technical support services available to help you repair your Acer Systems.

If you are a distributor, dealer, ASP or TPM, please refer your technical queries to your local Acer branch office. Acer Branch Offices and Regional Business Units may access our website. However some information sources will require a user i.d. and password. These can be obtained directly from Acer CSD Taiwan.

Acer's Website offers you convenient and valuable support resources whenever you need them.

In the Technical Information section you can download information on all of Acer's Notebook, Desktop and Server models including:

- Service guides for all models
- User's manuals
- Training materials
- Bios updates
- Software utilities
- Spare parts lists
- TABs (Technical Announcement Bulletin)

For these purposes, we have included an Acrobat File to facilitate the problem-free downloading of our technical material.

Also contained on this website are:

- Detailed information on Acer's International Traveler's Warranty (ITW)
- Returned material authorization procedures
- An overview of all the support services we offer, accompanied by a list of telephone, fax and email contacts for all your technical queries.

We are always looking for ways to optimize and improve our services, so if you have any suggestions or comments, please do not hesitate to communicate these to us.

A

- Antennas
 - Removing 97, 101

B

- Battery Pack
 - Removing 42
- BIOS
 - ROM type 17
 - vendor 17
 - Version 17
- BIOS Utility 23–31
 - Advanced 26
 - Boot 29
 - Exit 30
 - Navigating 23
 - Save and Exit 30
 - Security 26
 - System Security 30
- brightness
 - hotkeys 12
- Button Board
 - Removing 63

C

- Camera Board
 - Removing 87, 111
- caps lock
 - on indicator 8
- Common Problems 150
- CRT Cable
 - Removing 120

D

- DIMM Module
 - Removing 48
- Display 3
- display
 - hotkeys 12

E

- Euro Key 13
- External Module Disassembly
 - Flowchart 41

F

- Features 1
- FLASH Utility 31
- Flash Utility 31
- FRU (Field Replaceable Unit) List 175

H

- Hard Disk Drive Module
 - Removing 46
- Hibernation mode
 - hotkey 12
- Hot Keys 10

I

- Indicators 8
- Intermittent Problems 160
- Internal Microphone Failure 157
- Internal Speaker Failure 156

J

- Jumper and Connector Locations 171

K

- Keyboard
 - Removing 54
- Keyboard Failure 154

L

- LCD Bezel
 - Removing 84, 112
- LCD Brackets
 - Removing 91, 106
- LCD Cable
 - Removing 91, 106
- LCD Failure 153
- LCD Module
 - Removing 115
- LCD Module Disassembly
 - Flowchart 82
- LCD Panel
 - Removing 89, 108

M

Main Unit Disassembly
Flowchart 52

Mainboard
Removing 120

media access
on indicator 8

Memory Check 150

Microphone
Removing 89, 108

Model Definition 187

N

No Display Issue 151

num lock
on indicator 8

O

ODD Failure 159

Online Support Information 197

P

Panel 4
left 4

PC Card 8

Power On Failure 150

S

Speaker Module
Removing 78

speakers
hotkey 12

System
Block Diagram 3

T

Test Compatible Components 193

Thermal Module
Removing 77, 117

Touch Pad Failure 155

Troubleshooting
Built-in KB Failure 154
Internal Microphone 157
Internal Speakers 156

LCD Failure 153
No Display 151
ODD 159
Other Failures 159
Power On 150
Touch Pad 155
USB 159

U

Undetermined Problems 160

Upper Cover
Removing 58

USB Failure (Rightside) 159
utility
BIOS 23–31

V

volume
hotkeys 12

W

Windows 2000 Environment Test 193

WLAN Board
Removing 49

Free Manuals Download Website

<http://myh66.com>

<http://usermanuals.us>

<http://www.somanuals.com>

<http://www.4manuals.cc>

<http://www.manual-lib.com>

<http://www.404manual.com>

<http://www.luxmanual.com>

<http://aubethermostatmanual.com>

Golf course search by state

<http://golfingnear.com>

Email search by domain

<http://emailbydomain.com>

Auto manuals search

<http://auto.somanuals.com>

TV manuals search

<http://tv.somanuals.com>