

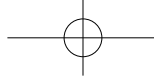

Gateway *LT21 Series* Quick Guide



Gateway *LT21 Series*

© 2009 All Rights Reserved
Gateway *LT21 Series* Quick Guide
Original Issue: 10/2009

Gateway *LT21 Series* Notebook PC

Model number: _____

Serial number: _____

Date of purchase: _____

Place of purchase: _____

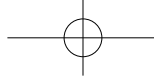

Federal Communications Commission Declaration of Conformity

This device complies with Part 15 of the FCC Rules. Operation is subject to the following two conditions: (1) this device may not cause harmful interference, and (2) this device must accept any interference received, including interference that may cause undesired operation.

The following local Manufacturer /Importer is responsible for this declaration:

Product:	Notebook PC
Brand:	Gateway
Model number:	NAV50
Machine type:	<i>LT21 series</i>
Name of Responsible Party:	Acer America Corporation
Address of Responsible Party:	333 West San Carlos St., San Jose CA 95110, U. S. A.
Contact Person:	Acer Representative
Phone No.:	1-254-298-4000
Fax No.:	1-254-298-4147
October 29, 2009	



Gateway *LT21 Series*

CE Declaration of Conformity

We,

Acer Incorporated

8F, 88, Sec. 1, Hsin Tai Wu Rd., Hsichih, Taipei Hsien 221, Taiwan

Contact Person: Mr. Easy Lai, e-mail:easy_lai@acer.com.tw

And,

Acer Europe SA

Via Cantonale, Centro Galleria 2 6928 Manno Switzerland

Hereby declare that:

Product: Notebook Computer

Trade Name: Gateway

Model Number: NAV50

Machine Type: LT21 series

Is compliant with the essential requirements and other relevant provisions of the following EC directives, and that all the necessary steps have been taken and are in force to assure that production units of the same product will continue comply with the requirements.

EMC Directive 2004/108/EC as attested by conformity with the following harmonized standards:

- EN55022, AS/NZS CISPR22, Class B
- EN55024
- EN61000-3-2 Class D
- EN61000-3-3

Low Voltage Directive 2006/95/EC as attested by conformity with the following harmonized standard:

- EN60950-1

Council Decision 98/482/EC (CTR21):

(Applicable to product with pan-European single terminal connection to the Public Switched Telephone Network (PSTN).)

RoHS Directive 2002/95/EC on the Restriction of the Use of certain Hazardous Substances in Electrical and Electronic Equipment

- The maximum concentration values of the restricted substances by weight in homogenous material are:



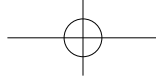

Quick Guide

Lead	0.1%	Polybrominated Biphenyls (PBB's)	0.1%
Mercury	0.1%	Polybrominated Diphenyl Ethers (PBDE's)	0.1%
Hexavalent Chromium	0.1%	Cadmium	0.01%

Directive 2005/32/EC of the European Parliament and of the Council with regard to Eco-design Requirements.

RTTE Directive 1999/5/EC as attested by conformity with the following harmonized standard:

- Article 3.1(a) Health and Safety
 - EN60950-1
 - EN62311
- Article 3.1(b) EMC
 - EN301 489-1
 - EN301 489-3 (Applicable to non-bluetooth wireless keyboard mouse set).
 - EN301 489-7
 - EN301 489-17
 - EN301 489-24
- Article 3.2 Spectrum Usages
 - EN300 440-2 (Applicable to non-bluetooth wireless keyboard mouse set).
 - EN300 328
 - EN301 511
 - EN301 893 (Applicable to 5GHz high performance RLAN).
 - EN301 908-1
 - EN301 908-2

Year to begin affixing CE marking 2009.

Easy Lai

Easy Lai /Manager
Regulation Center

Oct. 29, 2009

Date

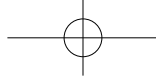

Gateway LT21 Series

Just for starters

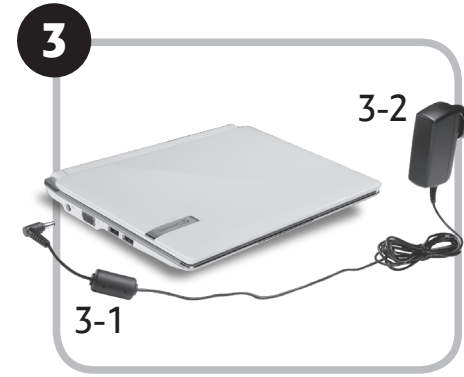
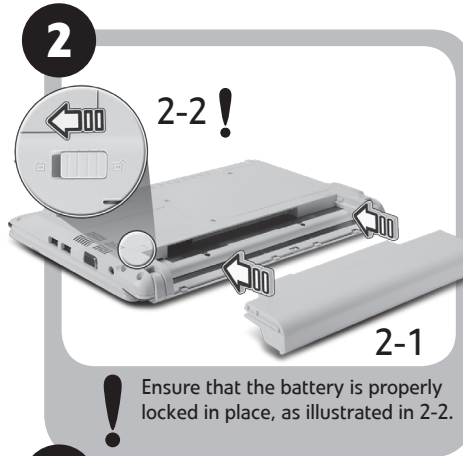
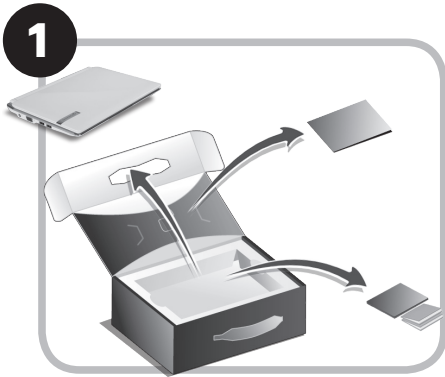

Illustrations are for reference only. Actual product specifications may vary.

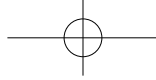

First things first

We would like to thank you for making a Gateway notebook your choice for meeting your mobile computing needs.

Your guides

To help you use your Gateway notebook, we have designed a set of guides*:

First off, the Quick Guide helps you get started with setting up your computer.

For more on how your computer can help you to be more productive, please refer to the Gateway System User Guide. This guide contains detailed information on such subjects as system utilities, data recovery, expansion options and troubleshooting. In addition it contains warranty information and the general regulations and safety notices for your notebook. It is available in Portable Document Format (PDF) and comes preloaded on your notebook.



Note: Viewing the file requires Adobe Reader. If Adobe Reader is not installed on your computer, clicking on Gateway System User Guide will run the Adobe Reader setup program first. Follow the instructions on the screen to complete the installation. For instructions on how to use Adobe Reader, access the Help and Support menu.



*** IMPORTANT NOTICE: Please note that the guides mentioned herein, whether in printed or electronic form, are for your reference only and except as provided in the specific warranty information contained in the Gateway System User Guide nothing contained in these guides shall constitute a representation or warranty by Gateway with regard to the product you purchased. Gateway expressly disclaims any liability for errors contained in the guides.**

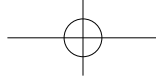

Gateway LT21 Series

Network configuration

This guide will help you configure your LAN and wireless network settings to enable you to connect to the Internet.

Setting up LAN connection

Simply plug in the LAN cable to the Ethernet (RJ-45) port. Please refer to "**Right view**" on **page 6** for the location of the Ethernet port.

Setting up a wireless connection

1. Press <Fn> + <F2> to turn the 3G/wireless LAN on/off, or to toggle between 3G and wireless functions.
2. Click the  icon on your system tray and choose the wireless access point you want to connect to.



Inserting a 3G SIM card (only for certain models)

Remove the battery and carefully insert a 3G SIM card into the 3G SIM card slot. Please refer to "**Rear & base views**" on **page 6** for the location of the 3G SIM card slot.

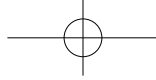

Quick Guide

Your *LT21 Series* tour

After setting up your computer as illustrated in the Just for starters section, let us show you around your new Gateway notebook.

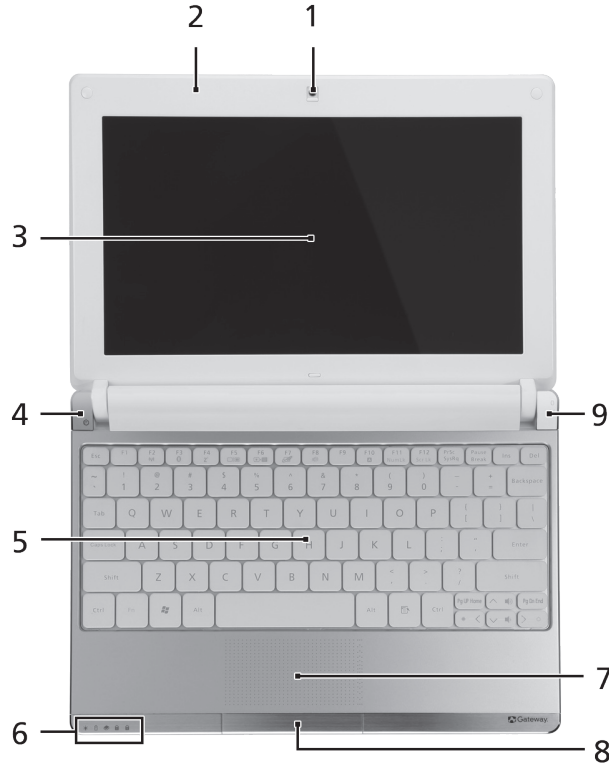

Top view

#	Icon	Item	Description
1		Webcam	Web camera for video communication
2		Microphone	Internal microphone for sound recording.
3		Display screen	Also called Liquid-Crystal Display (LCD), displays computer output.
4		Power button/indicator	Turns the computer on and off.
5		Keyboard	For entering data into your computer.
6		Power indicator	Indicates the computer's power status.
		Battery indicator	Indicates the computer's battery status.
		HDD indicator	Indicates when the hard disk drive is active.
		Num Lock indicator	Lights up when Num Lock is activated.
		Caps Lock indicator	Lights up when Caps Lock is activated.
7		Touchpad	Touch-sensitive pointing device which functions like a computer mouse.
8		Click buttons (left, and right)	The left and right buttons function like the left and right mouse buttons.
9		Bluetooth communication indicator	Indicates the status of the Bluetooth communication. (only for certain models)
		3G/Wireless LAN communication indicator	Indicates the status of 3G/Wireless LAN communication.

Blue light on	Orange light on	Not lit
3G on / WiFi on	3G off / WiFi on	3G off / WiFi off
3G on / WiFi off		

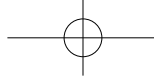



Gateway LT21 Series

Closed front view

#	Icon	Item	Description
1		Status indicators	Light-Emitting Diodes (LED) that light up to show the status of the computer's functions and components.

Left view

2		DC-in jack	Connects to an AC adapter.
3		External display (VGA) port	Connects to a display device (e.g., external monitor, LCD projector).
4		USB 2.0 port	Connects to USB 2.0 devices (e.g., USB mouse).

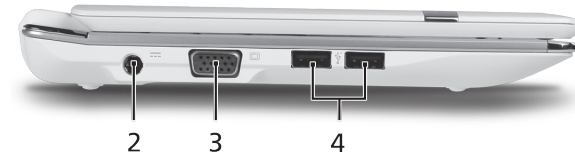

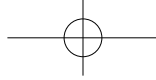

Quick Guide

Right view

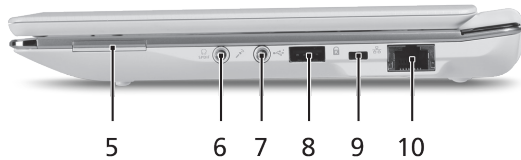

#	Icon	Item	Description
5		Multi-in-1 card reader	Accepts Secure Digital (SD), MultiMediaCard (MMC), Memory Stick (MS), Memory Stick PRO (MS PRO), xD-Picture Card (xD). Note: Push to remove/install the card. Only one card can operate at any given time.
6		Headphone/speaker/line-out jack	Connects to line-out audio devices (e.g., speakers, headphones).
7		Microphone-in jack	Accepts input from external microphones.
8		USB 2.0 port	Connects to USB 2.0 devices (e.g., USB mouse).
9		Kensington lock slot	Connects to a Kensington-compatible computer security lock.
10		Ethernet (RJ-45) port	Connects to an Ethernet 10/100-based network.

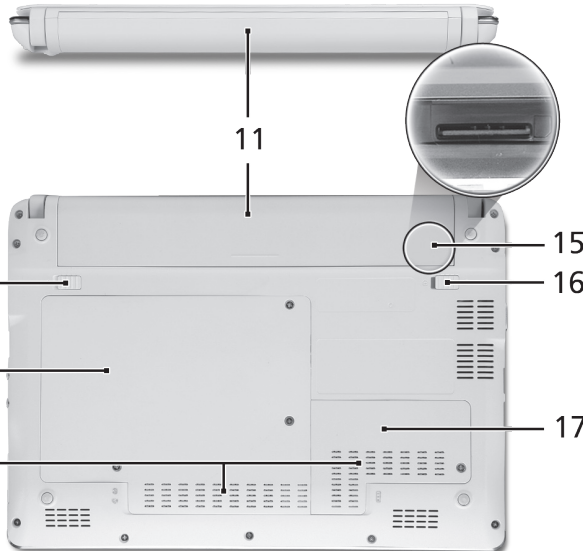

Rear & base views

11		Battery bay	Houses the computer's battery pack. Note: The battery shown is for reference only. Your PC may have a different battery, depending on the model purchased.
12		Battery release latch	Releases the battery for removal.
13		Hard disk/3G/Wireless LAN communication bay	Houses the computer's hard disk/3G/Wireless LAN communication (secured with screws).
14		Ventilation slots and/or cooling fan	Enables the computer to stay cool, even after prolonged use. Note: Do not cover or obstruct the opening of the fan.
15		3G SIM card slot	Accepts a 3G SIM card for 3G connectivity. (only for certain models)
16		Battery lock	Locks the battery in position.
17		Memory compartment	Houses the computer's main memory.

Free Manuals Download Website

<http://myh66.com>

<http://usermanuals.us>

<http://www.somanuals.com>

<http://www.4manuals.cc>

<http://www.manual-lib.com>

<http://www.404manual.com>

<http://www.luxmanual.com>

<http://aubethermostatmanual.com>

Golf course search by state

<http://golfingnear.com>

Email search by domain

<http://emailbydomain.com>

Auto manuals search

<http://auto.somanuals.com>

TV manuals search

<http://tv.somanuals.com>