



*GATEWAY 2000*  
*S O L O*™

***USER'S GUIDE***

# Your First Solo Flight

By now you've unpacked your Gateway 2000 Solo™ Multimedia Notebook, and you're just a few steps from really taking off.

1. If you haven't done so already, take the time now to connect your unit to an AC power source as shown below.

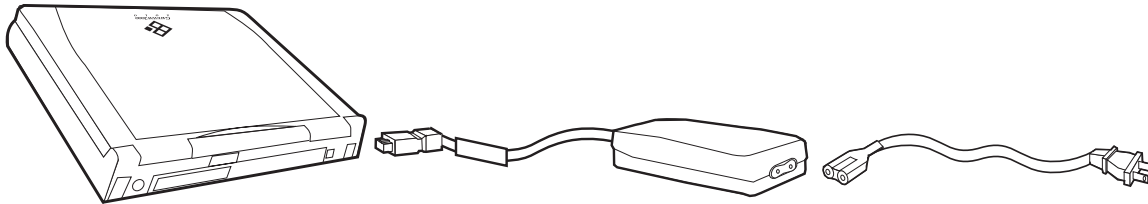

**The unit**

**The AC adapter**

**The AC power cord**

(Use AC power as the battery in your unit is probably dead. An installed battery automatically charges itself, however, as long as the unit is connected to AC power. In order to optimize the battery's life and performance, allow it to charge overnight and then completely discharge it through normal use. Do this twice for best results.)

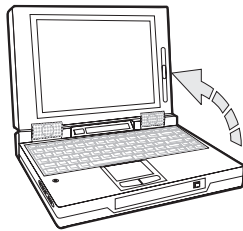

2. Slide the cover latch to the right to open the unit.

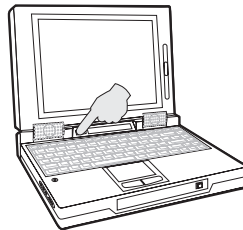

3. Press the power button to turn the unit on.

4. The Windows® 95 logo appears on the screen. (Windows® for Workgroups users must type **w i n** at the C: prompt and press Enter.)

5. Your system is now ready to fly. Continue navigating your own path, or, if the CD-ROM drive is installed, follow the steps below to take a quick ride with the *Gateway 2000 Solo System CD*.

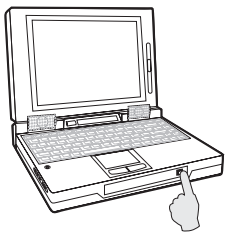

- A. Press the eject button on the CD-ROM drive.

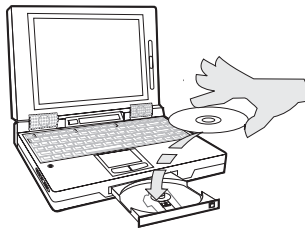

- B. Insert the *Gateway 2000 Solo System CD*.

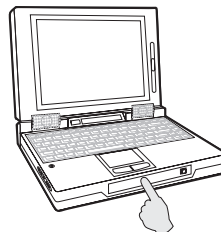

- C. Close the drive tray.

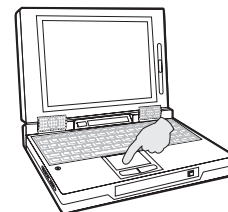

- D. Slide a finger on the pad to move the cursor onto the MEETSOLO icon in the CD's directory. Tap twice to double-click the icon.

# Contents

<b>Legal notices</b> .....	<b>2</b>
<b>Specifications</b> .....	<b>4</b>
<b>Outside the Notebook</b> .....	<b>6</b>
Front view .....	6
Back view .....	6
Bottom view .....	7
Left side view .....	7
<b>Inside the Notebook</b> .....	<b>8</b>
Status display bar .....	8
Keyboard .....	9
EZ Pad pointing device .....	11
Built-in microphone/stereo speakers .....	11
Display .....	12
<b>Power</b> .....	<b>13</b>
AC power .....	13
Battery power .....	13
Bridge battery .....	15
<b>Starting, Stopping, and Restarting</b> .....	<b>15</b>
Standby mode .....	16
Suspend mode .....	16
Rebooting .....	16
<b>Modular Option Bay</b> .....	<b>17</b>
CD-ROM Drive .....	18
Floppy Disk Drive .....	18
<b>External Floppy Drive</b> .....	<b>19</b>
<b>Hard Disk Drive</b> .....	<b>19</b>
<b>PCMCIA Cards</b> .....	<b>21</b>
<b>Memory</b> .....	<b>22</b>
<b>Connections</b> .....	<b>23</b>
IR module .....	23
Docking bar .....	23
<b>Setup Menus</b> .....	<b>25</b>
Main Setup Menu .....	25
Password Setup Menu .....	26
Port Assignment Menu .....	27
Power Management Menu .....	28
Miscellaneous Menu .....	29
Keyboard Setup Menu .....	29
<b>Troubleshooting</b> .....	<b>30</b>
<b>Index</b> .....	<b>32</b>

# The Gateway 2000

## SOLO™

### Multimedia Notebook



## User's Guide

# Legal notices

Gateway 2000 Solo™ Multimedia Notebook  
User's Guide  
Copyright © 1995

## All rights reserved

This book is protected by copyright and all rights are reserved. No part of it may be reproduced or transmitted by any means or in any form without prior written consent from Gateway 2000.

The information in this manual has been carefully checked and is believed to be accurate. However, Gateway 2000 assumes no responsibility for any inaccuracies that may be contained in this manual. In no event will Gateway 2000 be liable for direct, indirect, special, incidental, or consequential damages resulting from any defect or omission in this manual, even if advised of the possibility of such damages.

In the interest of continued product development, Gateway 2000 reserves the right to make improvements in this manual and the products it describes at any time, without notice or obligation.

## Trademark acknowledgments

Gateway 2000, The Gateway 2000 Solo logo, cow spot motif, and motto "You've got a friend in the business" are registered trademarks of Gateway 2000. EZ Pad is a trademark of Gateway 2000. IBM, PC/AT, and PS/2 are registered trademarks of International Business Machines Corporation. Intel is a registered trademark of Intel Corporation. Microsoft, MS, MS-DOS, Windows, and Windows 95 are registered trademarks of Microsoft Corporation. XJACK is a trademark of the Megahertz Corp. Novell and NetWare are trademark of Novell, Inc. PostScript is a trademark of Adobe Systems Inc. All other product names mentioned herein are used for identification purposes only, and may be the trademarks or registered trademarks of their respective companies.

## FCC statement

NOTE: This is a Class B Digital Device. This equipment has been tested and found to comply with the limits for a Class B digital device pursuant to Part 15 of the FCC Rules. These limits are designed to provide reasonable protection against harmful interference in a residential installation.

Gateway 2000®  
610 Gateway Drive  
North Sioux City, SD 57049 USA

This equipment generates, uses, and can radiate radio frequency energy and, if not installed and used in accordance with the instructions, may cause harmful interference to radio communications. However, there is no guarantee that interference will not occur in a particular installation. If this equipment does cause harmful interference to radio or television reception, which can be determined by turning the equipment off and on, the user is encouraged to try to correct the interference by one of more of the following measures:

- Reorient or relocate the receiving antenna
- Increase the separation between the equipment and receiver
- Connect the equipment into an outlet on a circuit different from that to which the receiver is connected
- Consult an experienced radio/TV technician for help.

Caution: Changes or modifications not expressly approved by the party responsible for compliance could void the user's authority to operate the equipment.

To meet FCC requirements, shielded cables and power cords are required to connect this device to a personal computer or other Class B certified device.

## Cautions and warnings

**CAUTION:** Danger of explosion if battery is incorrectly replaced. Replace only with the same or equivalent type recommended by the manufacturer. Dispose of used batteries promptly and according to the manufacturer's instructions.

**ATTENTION:** Il y a danger d'explosion s'il y a remplacement incorrect de la batterie. Remplacer uniquement avec une batteries du meme type ou d'un type recommande par le constructeur. Mettre rebut les batteries usagees conformement aux instructions du fabricant.

**VORSICHT:** Explosionsgefahr bei unsachgemäßem Batteriewechsel. Originalbatterien nur durch gleiche oder vom Hersteller empfohlene Batterien ersetzen. Gebrauchte Batterien an Gateway 2000 zurücksenden.

**ADVARSEL:** Eksplosjonsfare ved feilaktig skifte av batteri. Benytt samme batteritype eller en tilsvarende type anbefalt av apparatfabrikanten. Brukte batterier kasseres i henhold til fabrikantens instruksjoner.

**CAUTION:** This equipment uses a grounded power cable. Do not attempt to defeat the grounding prong. Do not remove the grounding prong. If you use a three-prong adapter, be sure to connect the ground wire to a good ground.

Replace the cord if it becomes damaged. U.S. and Canadian replacement cords must be UL-approved (CSA certified in Canada) type SPT-2, 18 AWG, 2-conductor cord with permanently attached NEMA type 5-15P plug at one end and a permanently attached connector body on the other. Cord length may not exceed 15 feet. Outside the U.S. and Canada the cord must be rated for at least 250VAC at 10 amps, and must indicate international safety agency approval. The plug must be a type appropriate for the country of use.

Obtain replacement cords at an authorized service center. The replacement must be of the same type and voltage rating as the original cord.

**VORSICHT:** Diese Ausrüstung verwendet ein geerdetes Netzkabel. Den Erdungskontakt unter keinen Umständen umgehen oder entfernen. Bei Verwendung eines dreipoligen Adapters den Erdungsdraht stets an geprüften Erdungskontakt anschließen.

Beschädigte Kabel ersetzen. Ersatzkabel in den USA und Kanada müssen folgende Bedingungen erfüllen: UL-anerkannter (in Kanada CSA-zertifizierter) SPT-2 Typ, 18 AWG, 2-Leiter-Kabel mit fest installiertem NEMA-Typ-5-15P-Stecker und fest installierter Anschlußdose am anderen Ende, max. 4,57 m Länge. Außerhalb der USA und Kanada gelten folgende Bedingungen: Kabel für mindestens 250 V Wechselstrom bei 10 A, anerkannt durch internationale Sicherheitsbehörde, landesspezifischer Stecker.

Ersatzkabel nur im Fachhandel erwerben. Nur Ersatzkabel des gleichen Typs und für die gleiche Spannung (Voltzahl) wie das Originalkabel verwenden.

**WARNING:** Always plug the cord into an easily accessible outlet near the equipment so that unplugging the cord is an easy way to shut off power.

**Do not attempt to disassemble the AC adapter.** The AC adapter has no user-replaceable or -serviceable parts inside. The AC adapter has dangerous voltages that can cause serious personal injury or death. Return defective AC adapters to Gateway 2000.

The AC adapter is intended for use with a computer. Both must meet EN 60950.

**ACHTUNG:** Netzkabel stets in eine gut zugängliche Steckdose nahe der Ausrüstung einstecken, um durch einfaches Ziehen des Steckers jederzeit die Stromversorgung unterbrechen zu können.

Den Adapter unter keinen Umständen auseinanderbauen. Der Adapter enthält keine vom Benutzer zu ersetzenden oder zu wartenden Bestandteile. Die Spannung im Adapter kann beim Auseinanderbau zu Verletzungen oder Tod führen. Beschädigte Adapter an Gateway 2000 zurücksenden.

Der Adapter ist für den Gebrauch mit einem Computer bestimmt. Adapter und Computer müssen die Norm EN 60950 erfüllen.

## Environmental considerations

Your Gateway 2000 Solo has been engineered to provide many years of reliable service. However, you should give it the same reasonable care and protection that you would any other electronic equipment. Damage caused by dropping the Gateway 2000 Solo, impact with another object, or immersion in liquids is not covered by the warranty. Never expose the Gateway 2000 Solo to rain, snow, or moisture. Avoid locations with high levels of dirt, dust, or smoke.

CAUTION: DO NOT OPEN. NO USER SERVICEABLE PARTS INSIDE  
ATTENTION: NE OUVRIER PAS. PARTIS RÉPARABLES UNIQUEMENT À L'USINE  
VORSICHT: NICHT ÖFFNEN. ENTHÄLT KEINE VOM BENUTZER ZU  
WARTENDEN BESTANDTEILE

## Colophon

This manual was created electronically with a Gateway 2000 P5-100 computer system, MS-DOS 6.22, Windows for Workgroups 3.11, PageMaker 5.0, CorelDraw 5.0, Adobe Type Manager 2.6, and Adobe Postscript fonts including Stone Sans, Eras Book, Times New Roman, Tektton, Myriad Headline, Insignia, Gill Sans, and Zaph Dingbats.



*This document is printed on recycled paper, using our natural resources efficiently and wisely — meeting the minimum 50% waste paper requirements established by the Federal EPA in its guidelines for recycled paper products.*

**Printed in the United States of America**

Gateway 2000  
Gateway 2000 Solo Multimedia Notebook  
User's Guide  
Part# SYSMAN017AAUS  
9/95

# Specifications

(Specifications are subject to change without notice or obligation.)

<i>Dimensions</i>	(W × D × H) 11.8" × 8.8" × 2.0" (300mm x 223.5mm x 51mm)
<i>Weight</i>	approx. 6.3 lbs with battery
<i>Keyboard</i>	86 keys, 100% scale; provides same functions as standard Windows 95 AT keyboard
<i>Screen</i>	Backlit active-matrix LCD: 10.2" diagonal (207.4mm x 155.5mm); 640 x 480 x 256 VGA resolution; supports virtual screen to 1024 x768; 0.324mm dot pitch; 70:1 contrast ratio Backlit active-matrix LCD: 10.4" diagonal (211.2mm x 158.4mm); 800 x 600 x 256 SVGA resolution; supports virtual screen to 1024 x768; 0.264mm dot pitch; 100:1 contrast ratio
<i>Video</i>	1MB video memory; C&T 65545 controller, VESA local bus with Windows acceleration; Video port supports: 640 x 480 x 16–64K colors, 800 x 600 x 16 or 256 colors, 1024 x 768 x 16 or 256 colors
<i>Mouse/Pointer</i>	EZ Pad integrated pointer; PS/2-type connector for external mouse
<i>CPU</i>	Intel P54CLM-75 or P54CLM-90 low power Pentium Processor
<i>Cache</i>	16K in CPU; 256K pipelined burst synchronous external
<i>CPU speed</i>	75 or 90MHz
<i>BIOS</i>	256K; includes configuration utility with password security and power management
<i>RAM type</i>	70ns 3.3V low power DRAM
<i>RAM capacity</i>	8MB on board, expandable to 16, 24, or 40MB by using a pair of 4, 8, or 16MB modules (subject to availability)
<i>Expansion slots</i>	Two PCMCIA Type II slots (or stacked as one Type III slot) with card ejectors; supports hot-swapping of most cards
<i>I/O ports</i>	DB25 floppy/parallel port; DB9 serial port; PS/2 external keyboard/mouse connector; docking bar connector, video connector, IR port
<i>Modular bay</i>	Internal 1.44MB 3.5 inch floppy drive or 5 inch 2x CD-ROM drive
<i>Hard disk drive</i>	340MB, 540MB, 720MB or 1.2GB IDE removeable drive, depending on system
<i>Accessories</i>	AC adapter; IR (infrared) module; Lithium battery; Docking bar, External floppy disk drive, Optional leather carrying case

<i>PCMCIA option</i>	2400/9600 data/fax modem; 14,400 data/fax modem; twisted pair or thinnet (BNC) Ethernet network; token ring network; other cards available from other sources
<i>Environment</i>	10-35° C; 10-95% noncondensing relative humidity
<i>AC adapter</i>	Requires 100-240 VAC, 0.88-0.46A nominal: adapter powers system and charges battery simultaneously
<i>Battery pack</i>	14.4DC, 2700mAh lithium battery: batteries can be "hot-swapped" without rebooting. Recharges in or out of system. Conforms to APM 1.1  Permanent internal NiMH battery maintains system memory for about one-half day with battery pack removed
<i>Battery life</i>	38.88 watt-hours; 2.5 to over 4 hours in typical usage under Windows®; fully charged battery lasts about three weeks in Suspend mode
<i>Charging cycle</i>	Varies depending on battery condition; full charge usually takes about two and one-half hours
<i>Certification</i>	FCC Class B, UL, CSA, TUV (approved to IEC950/EN60950),



# Outside the Notebook

The Gateway 2000 Solo Multimedia Notebook is designed to provide the multimedia functionality of a full-size desktop system along with the convenience of a lightweight portable. Even if you are already using the unit, we recommend you take a few moments to familiarize yourself with its many functions and features.

## Front view

**Cover latch:**  
slide to the right to release the lid and open the unit.

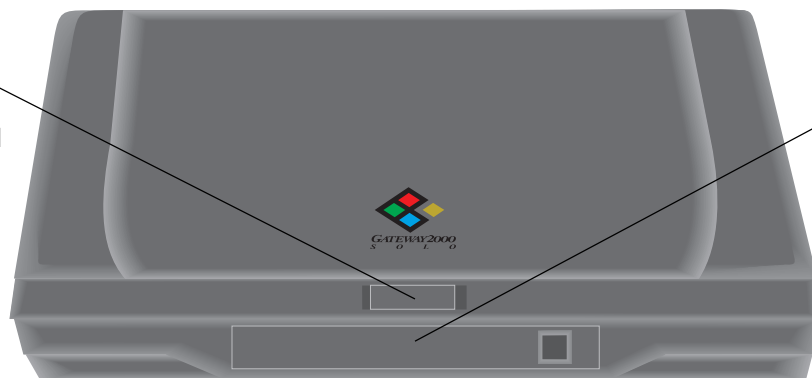

**Modular option bay:**  
houses internal floppy disk drive or CD-ROM drive. (See page 17.)

## Back view

(port cover flipped down)

**Flip down foot:**  
flip it down to tilt the unit for more comfort.

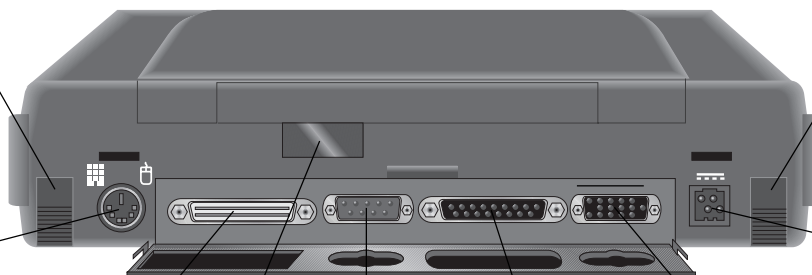

**Flip down foot:**  
flip it down to tilt the unit for more comfort.

**PS/2 port:**  
connect a mouse or keyboard here. (See pages 9 and 11.)

**Docking bar port (120-pin):**  
connect the docking bar here. (See page 23.)

**Serial port:**  
connect any serial device here.

**IR port:**  
place the IR module so that its receiver/transmitter can "see" this port. (See page 23.)

**Floppy/Parallel port:**  
connect external floppy disk drive or any parallel device here. (See page 19.)

**VGA port:**  
connect any standard monitor here. (See page 12.)

**AC connector:**  
connect AC adapter here. (See page 13.)

## Bottom view

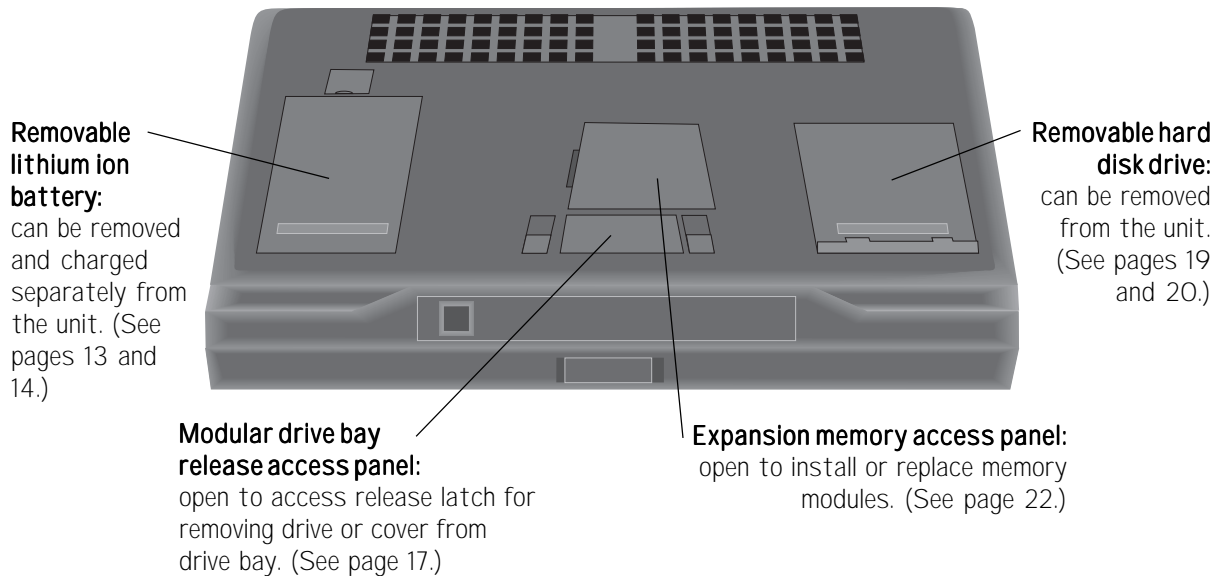

## Left side view

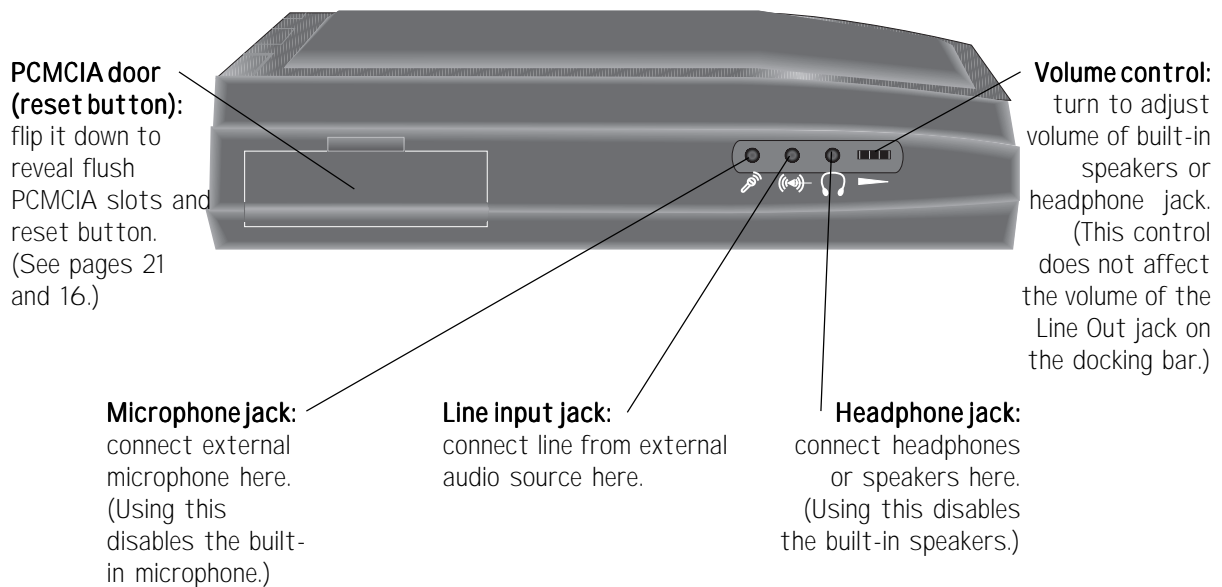

# Inside the Notebook

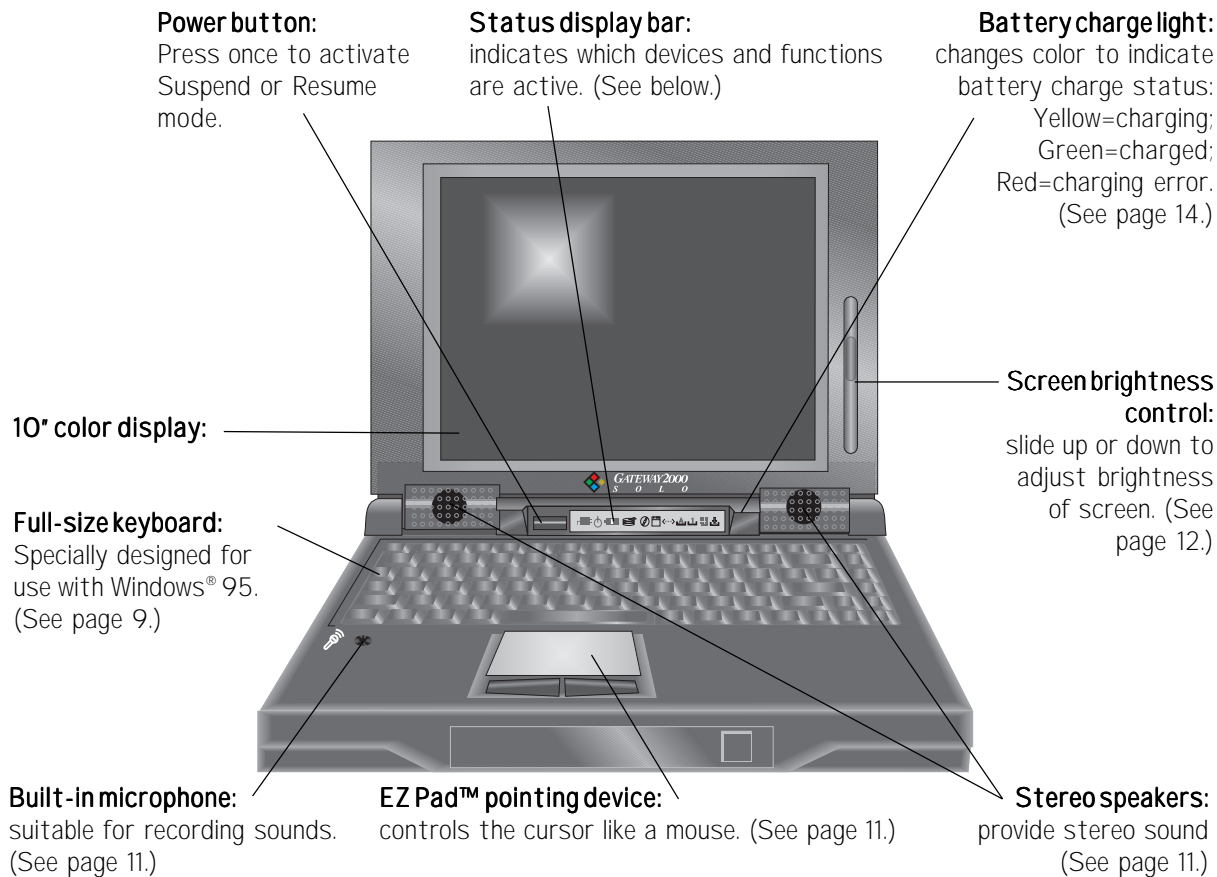

## Status display bar

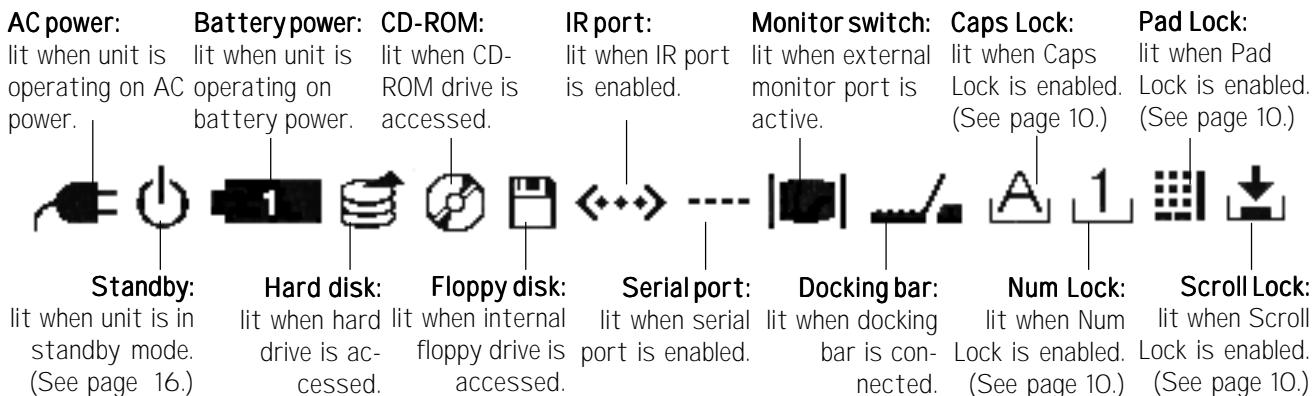

## Keyboard

The system features a specially-designed, 86-key keyboard. In order to provide the full functionality of a 101-key keyboard, many of these keys have been assigned special alternate functions, including shortcut keys for Windows® 95.

**Caps Lock key:**  
press to lock letter keys in uppercase mode. (When active, Caps Lock icon appears in status display bar icon. See page 8.)



**Windows 95 menu key:**  
press to access menus within a Windows 95 application. (See Windows 95 documentation.)

**Windows 95 start button key:**  
press to automatically click the Start button in Windows 95. (See Windows 95 documentation.)

**An external keyboard** may be attached to the unit through the PS/2 port on the back of the unit (See page 6.) or the PS/2 (keyboard) port on the docking bar. (See page 24.)

## Special function keys

The keys with blue labels perform special functions when activated. The status display bar shows individual icons for the Monitor Switch, Num Lock, Pad Lock, and Scroll Lock keys when each is activated. (See page 8.)

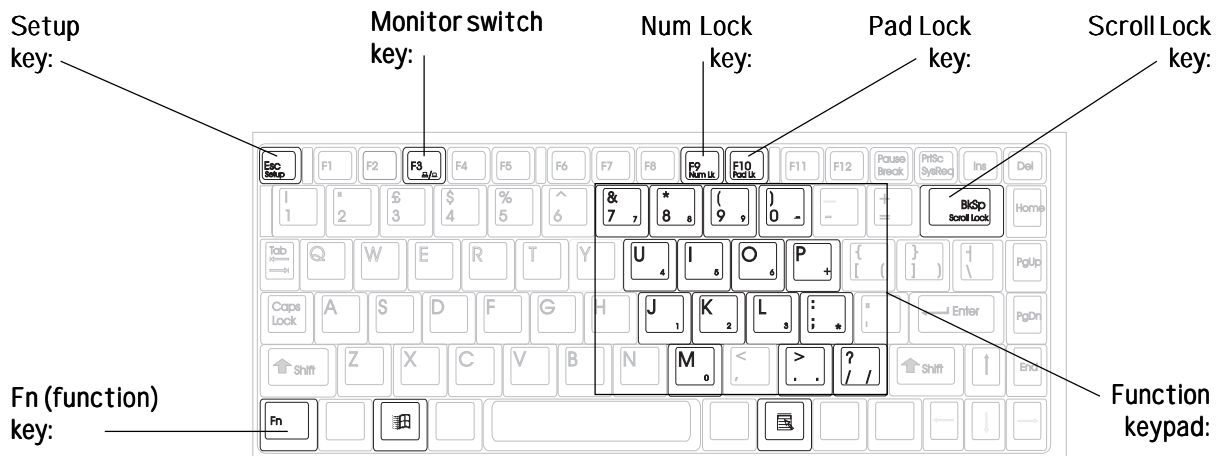

Key	To activate	Function
Fn	press with blue label key	activates alternate functions of blue label keys (See <b>Pad Lock</b> below.)
Setup	press with <b>Fn</b> key	displays Setup Menus (See page 25.)
Monitor switch	press with <b>Fn</b> key	switches between monitor options: internal, external, or both
Num Lock	press with <b>Fn</b> key	activates numeric keypad mode of function keypad
Pad Lock	press with <b>Fn</b> key	locks Fn down during use with Num Lock or Scroll Lock
Scroll Lock	press with <b>Fn</b> key	activates cursor-control mode of function keypad
Function keypad	(See below.)	functions as either numeric or cursor-control keypad

### Function keypad

The keys of the function keypad produce the following:

- standard lowercase letters, numerals, and punctuation when pressed alone
- standard uppercase letters and symbols when pressed with the **Shift** key
- numerals and symbols when pressed with the **Fn** and **Num Lock** keys
- cursor movements when pressed with **Fn** and **Scroll Lock** keys

(See the chart below for details.)

Key	Key + Shift	Key + Num Lock	Key + Scroll Lock (cursor control)
7	&	7	Home
8	*	8	Up arrow
9	(	9	Page Up
0	)	-	(no effect)
u	U	4	Left arrow
i	I	5	(no effect)
o	O	6	Right arrow
p	P	+	(no effect)
j	J	1	End
k	K	2	Down arrow
l	L	3	Page Down
;	:	*	(no effect)
m	M	0	(no effect)
.	>	.	Delete
/	?	/	(no effect)

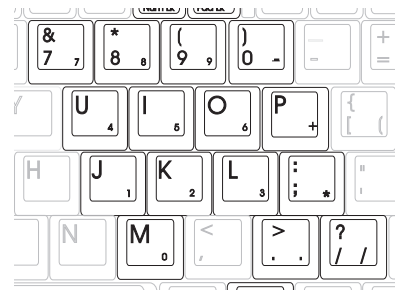

## EZ Pad pointing device

Like a mouse, the EZ Pad pointing device controls the movements of the cursor on the screen. Press a finger against the pad and move it in the direction you want the cursor to move.

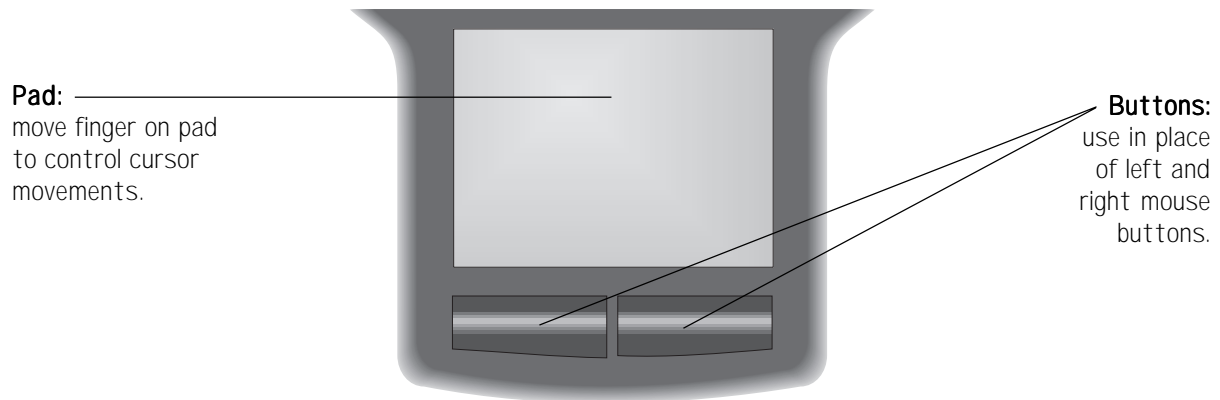

To **click** on something: position the cursor on the item and tap on the pad once.

To **double-click** on something: position the cursor on the item and tap on the pad twice.

To **drag and drop** on something: position the cursor on the item, tap on the pad twice and slide your finger (without lifting it) to reposition the cursor, and release.

An **external mouse** may be attached to the unit through the PS/2 port on the back of the unit (See page 6.) or the PS/2 (mouse) port on the docking bar. (See page 24.)

## Built-in microphone/stereo speakers

Because of their proximity to each other, the built-in microphone may cause feedback in the internal stereo speakers if both are used at the same time. (For this reason, your unit was shipped with the built-in microphone turned off. It may be turned on through your unit's audio control panel.) If you encounter this feedback problem, it may be remedied by turning the volume down or by using an external microphone or external speakers. (See the audio connections on page 7.)

## Display

The system features a built-in, backlit, active-matrix, color display. This display is either a 10.2 inch VGA display or a 10.4 inch SVGA display. Each of these displays provides sharp, clear color and resolution.

**Backlit display:**  
tilt the unit's cover  
forward or backward to  
adjust viewing angle.

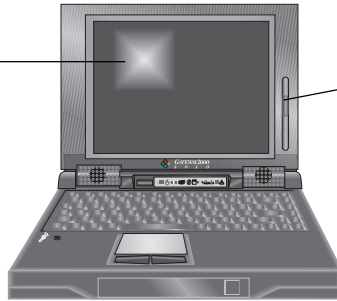

**Brightness control:**  
slide up or down  
to adjust screen  
brightness.

Tilt the unit's entire cover forward or backward to adjust the viewing angle. A sliding control on the right of the screen controls brightness. (VGA displays also have a contrast control located directly below the brightness control.)

Because the display is an active-matrix display, small dots of color may occasionally appear on the screen. Do not worry: this is normal for active-matrix screens and does not affect the overall screen image.

**NOTE:** If your unit displays an unchanging image for an extended period of time, that image may remain on the screen for a while as a slight shadow. Although this shadow is temporary and will disappear eventually, a screen saver program should be used to maintain optimum image quality.

**An external monitor** may be attached to the unit through the VGA port located on the back of the unit (See page 6.) or on the docking bar. (See page 24.) If you attach an additional monitor, use the Monitor Switch key to specify which display is active (See page 10.) and check the Boot Display function on the Main Setup Menu. (See pages 25 and 26.) When an external monitor is active, the monitor switch icon lights in the status display bar. (See page 8.)

# Power

The unit draws power from either a direct AC connection or its own rechargeable battery. To optimize the system's use of power, enter the Power Management Menu in the Setup Menus. (See page 25.)

## AC power

We recommend you use the AC adapter whenever possible to provide the unit with a constant supply of power and simultaneously keep the battery charged. (See "Charging/discharging the battery" below for details.) The proper method for connecting the AC power to the unit is shown below:

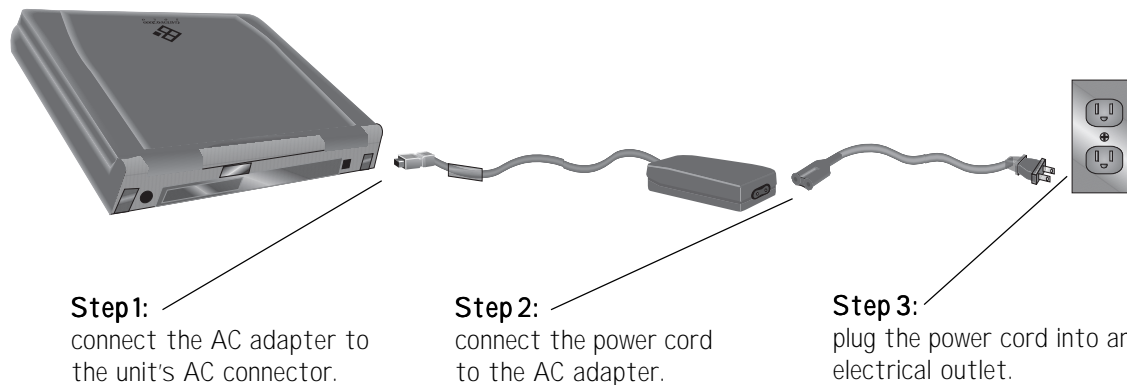

## Battery power

When you first receive the battery, it is installed in the system but not charged. We recommend that you completely charge and discharge the battery twice as soon as possible, as this improves the accuracy of the unit's battery power gauge and optimizes the battery's life and performance.

## Charging/discharging the battery

The battery must be connected to an AC power source for about 2 and one-half hours to charge completely. The unit can run on a fully charged battery for about 3-5 hours of normal use before the battery needs recharging. When the battery level gets low, the battery icon in the status display bar blinks. (See page 8.)



If the battery is installed in the unit and the unit is connected to AC power (See “AC power” on the previous page.), it automatically charges, even if the unit is in use. While the battery charges, the battery charger light (See page 8.) glows yellow, and when it is fully charged, the light glows green. (If the battery charger light glows red, a charging failure has occurred. Check connections and try again.)

## Removing the battery

The battery may also be charged independently of the unit. Simply remove the battery from the unit’s case as shown below and connect it directly to the AC adapter.

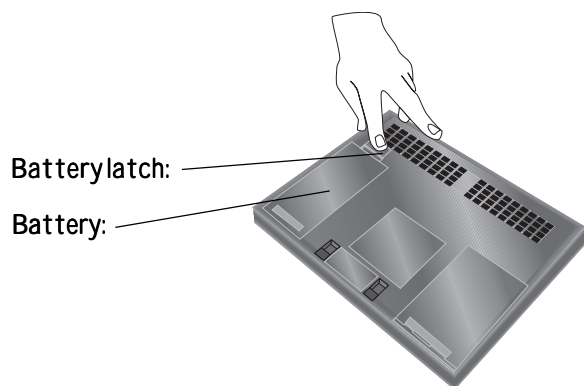

**Step 1:**  
Disconnect the AC adapter, turn the unit over, and slide the battery latch away from the battery.



**Step 2:**  
While holding the latch, place a fingertip in the indentation and lift the edge of the battery up.

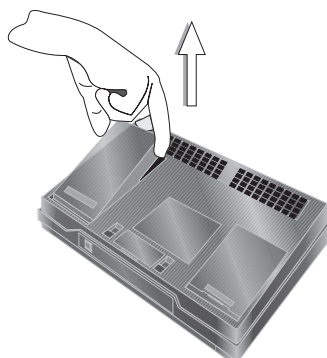

**Step 3:**  
Lift the battery up and away from the unit.

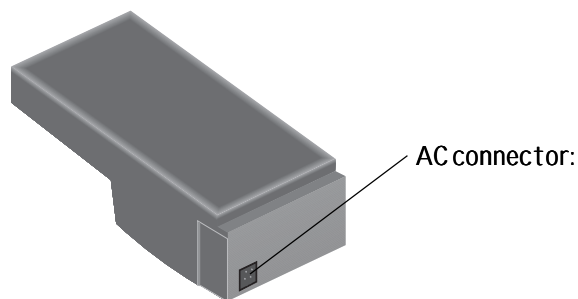

**Step 4:**  
Connect the AC adapter to the battery's AC connector.

## Bridge battery

Beneath the unit's hard disk drive bay lies the bridge battery. This rechargeable 3.6V battery provides power for certain functions when the unit is not connected to a power source (AC or battery). It automatically charges while the unit uses either power source and is designed to last for the life of the unit. However, the instructions below detail the procedure for removal and replacement if necessary:

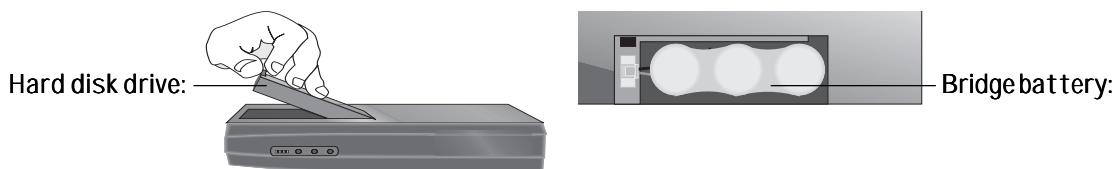

### Step 1:

Remove the hard disk drive as shown on page 20.

### Step 2:

Locate the bridge battery under the HDD bay.



### Step 3:

Carefully lift the battery out of its compartment and slide its connector out from the unit's connector.

### Step 4:

Slide the replacement battery's connector into the unit's connector and place battery back into compartment. Replace hard disk drive.

## Starting, Stopping, and Restarting

After the system is connected to a power source, it can be started by opening the cover and pressing the power button.

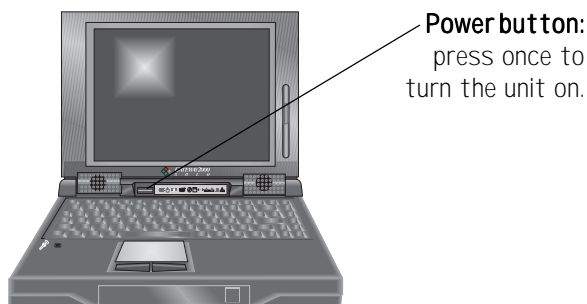

The unit may likewise be shut down by pressing the power button. This method of turning off the system is recommended, especially when the unit will not be used for some time. When using this method to shut down the system, be sure to save all work before pressing the power button.

## Standby mode

To conserve the system's power and resources while it is on, enter the Power Management Menu (See page 28.) and switch the Standby Timer setting in the User Settings Menu: Battery to the desired time amount. The unit then goes into Standby mode if you don't use the keyboard or EZ Pad for a while: The hard disk drive spins down, the screen goes blank, and the Standby icon on the status display bar lights. (See page 8.) After about 10 minutes of Standby mode, the unit automatically shifts to Suspend mode. Using the keyboard or EZ Pad sends the unit from Standby mode back to its active mode .

## Suspend mode

The system goes into Suspend mode after 10 minutes or so of Standby mode. It also enters Suspend mode from the active mode if the battery is removed, the cover is closed, or the power button is pressed. When the unit is in Suspend mode, it appears to be shut off, but it is actually using a very small amount of power to save your work for up to three weeks. Of course, work should still be saved to the hard drive as often as possible, because the Suspend save only lasts as long as the unit is in Suspend mode. To exit Suspend mode, open the cover and press the power button.

## Rebooting

If the system stops responding to the EZ Pad or the keyboard, it has experienced a "hang." Generally, a hang can be fixed by one of the following procedures:

- ❑ **Ctrl+Alt+Del:** Press the Ctrl, Alt, and Del keys simultaneously. Try this procedure (also called a "warm boot") before attempting the others below.
- ❑ **Fn+Alt+Del:** Press the Fn, Alt, and Del keys simultaneously. This procedure (also called a "cold boot") is similar to pressing the reset button on a desktop computer.
- ❑ **Hardware Reset button:** If the keystrokes above don't have any effect, press this button (located inside the PCMCIA slot on the left side of the unit) to restart the unit.

### Left side view of the system

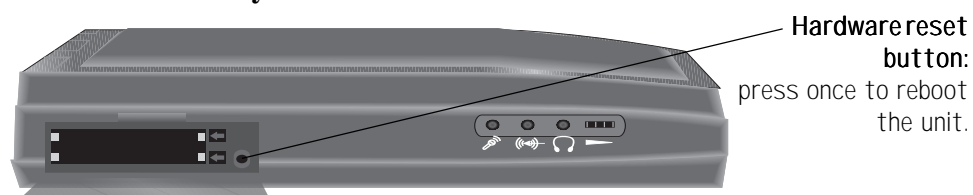

# Modular Option Bay

The Gateway 2000 Solo PC features a modular option bay located directly beneath the cover latch. This bay accepts the modular CD-ROM drive, the modular internal floppy disk drive, or the modular bay cover when neither drive is installed. The unit houses either drive, but only one at a time. (The bay cover is recommended for use when neither drive is installed and total carrying weight of the unit is an issue.)



To switch between drives, remove the installed drive (or bay cover) from the unit's modular bay as shown below and replace it with a different drive.

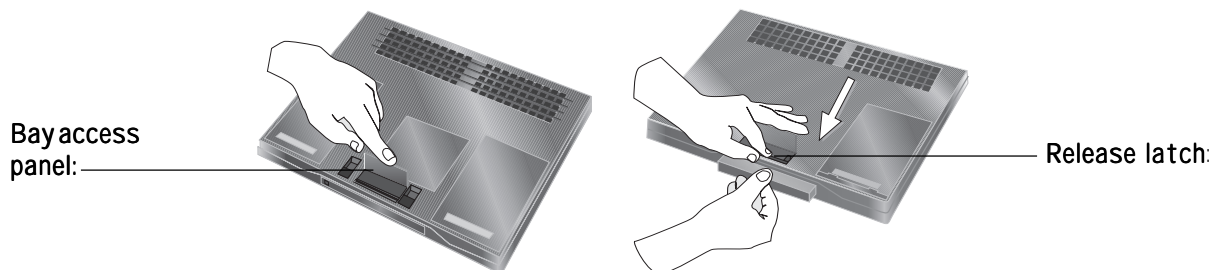

### Step 1:

Turn the unit off and flip it over. Locate the modular bay release access panel and flip the panel open.

### Step 2:

Slide the release latch forward until the drive (or cover) ejects from the unit. Remove the drive (or cover).

### Step 3:

Turn the new drive (or cover) upside down\*, align the grooves on its sides with the rails in the bay, and push the drive into the bay until the latch locks into place and the access panel can be closed. Restart the unit.

\*The system is upside down at this point, so the drive being installed must be turned upside down as well.

To use CD-ROM and floppy disk drive functions simultaneously, install the modular CD-ROM drive and connect an external floppy drive to the floppy/parallel port on the unit or the docking bar. (See “External Floppy Drive” on page 19.)

## CD-ROM Drive

To ensure that the system can recognize and read it, **the CD-ROM drive must be already installed when the system is booted up.** If the system is on when the drive is installed, it must be rebooted.

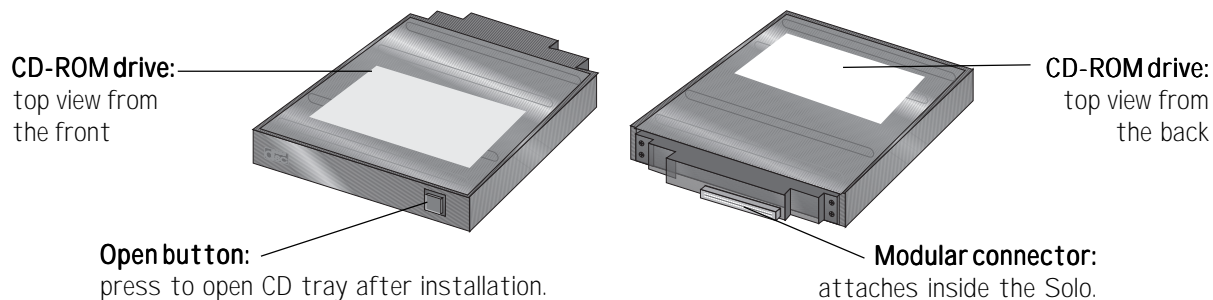

When the CD-ROM drive is installed and active, the CD-ROM drive icon lights in the status display bar. (See page 8.)

## Floppy Disk Drive

To ensure that the system can recognize and read it, **the floppy disk drive must be already installed when the system is booted up.** If the system is on when the drive is installed, it must be rebooted.

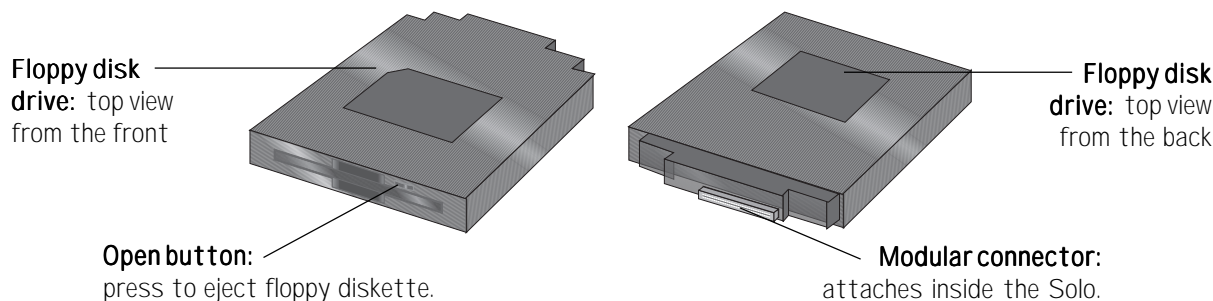

When the floppy disk drive is installed and active, the floppy disk drive icon lights in the status display bar. (See page 8.)

# External Floppy Drive

The system accepts an optional external floppy disk drive. This drive connects to the floppy/parallel port on the back of the unit as shown below. (It also connects to the floppy/parallel port on the docking bar. See page 24.) This connection requires a floppy drive cable:



**Step 1:**  
connect the cable's parallel connector to the unit's (or the docking bar's) floppy/parallel port.

**Step 2:**  
connect the cable's other connector to the floppy drive's connector (not shown).

When the floppy disk drive is installed and active, the floppy disk drive LED lights on the external floppy disk drive. (External drives do not affect status display bar icons.)

# Hard Disk Drive

The system's hard disk drive (HDD) may be removed from the unit for replacement or for switching between different hard drives.

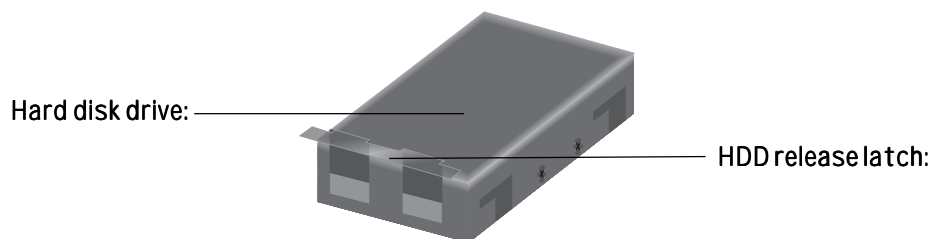

The instructions on the following page detail the procedure for removing and replacing the hard disk drive:

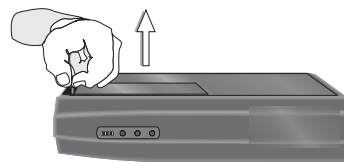
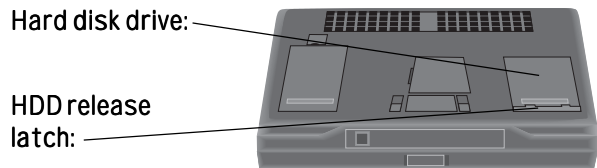

**Step 1:**  
Turn the unit over and locate the hard disk drive (HDD) and its release latch.

**Step 2:**  
Slide a fingernail between the hard drive and the release latch. Grasp the latch and pull it straight up.

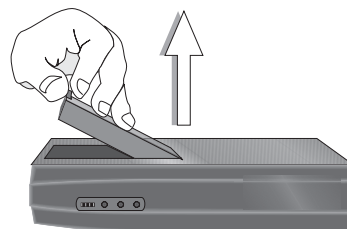
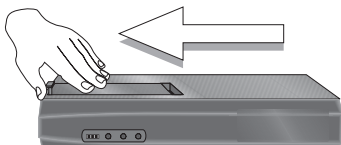

**Step 3:**  
With the release latch up, slide the hard drive toward the front of the unit.

**Step 4:**  
Grasp the latch and lift the hard drive up and out of the HDD bay. (The HDD may need to be slid backwards to free it from the unit.)

When the hard disk drive is installed and active, the hard disk icon lights in the status display bar. (See page 8.) The instructions below detail the procedure for installing or replacing the hard drive:

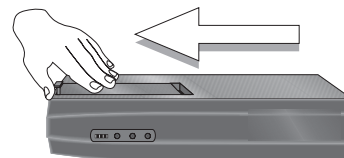
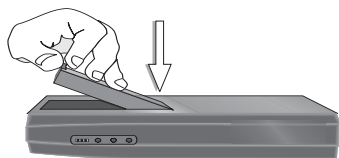

**Step 1:**  
Gently lower the drive into the unit's HDD bay.

**Step 2:**  
Slide the drive toward the front of the HDD bay to assure proper placement.

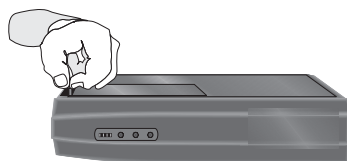
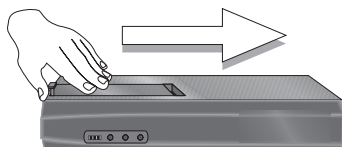

**Step 3:**  
Slide the drive all the way to the back of the HDD bay.

**Step 4:**  
Press the release latch into place. (If the latch does not easily snap into place, adjust the position of the drive.)

# PCMCIA Cards

The system's PCMCIA slots are located behind the PCMCIA door on the left side of the unit. These slots may be used as two Type II slots or as one Type III slot. Since these are flush slots, the door can be shut even when a PCMCIA card is installed. The system is preconfigured to accept most PCMCIA cards automatically: simply plug a card into the PCMCIA slot as shown below:

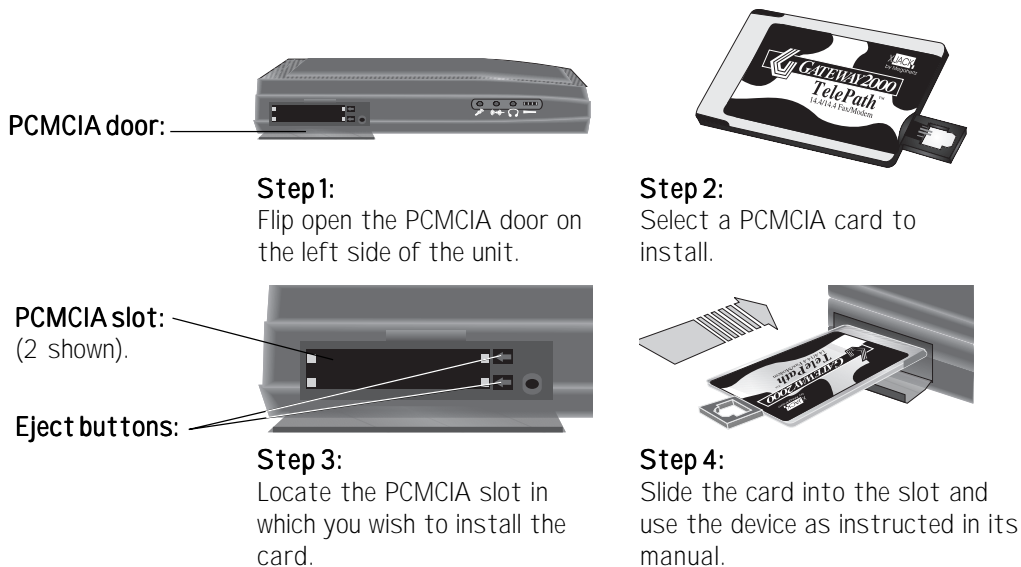

To remove a PCMCIA card, simply press the appropriate eject button located to the right of the PCMCIA slot. Because the system supports "hot-swapping," one card can usually be exchanged for another by simple removal and replacement.



# Memory

The system already has a minimum of 8MB of RAM on board. This memory capacity can be upgraded by installing memory modules in the unit's expandable memory sockets, located on the underside of the unit. These sockets will accept 4, 8, or 16MB modules, but remember: **If you upgrade the memory, the same type and size module must be used in EACH socket!** For instance, if you wish to install a 4MB module in one of the sockets, you **MUST** install an identical module in the other socket. Memory modules are installed in the memory sockets as shown below:

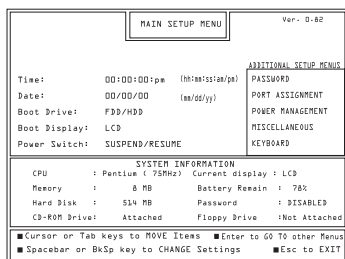

## Step 1:

Enter the Main Setup Menu , set the power switch to ON/ OFF, and exit saving changes. (See page 25 and 26.)

## Step 2:

Press the Power button to turn the unit off, close the lid, disconnect the AC power, and remove the battery.

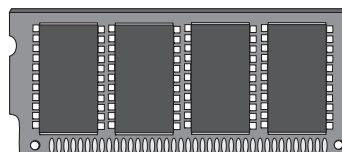
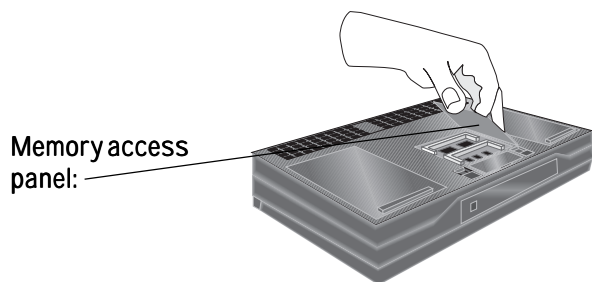

## Step 3:

Turn the unit over and lift away the expansion memory access panel.

## Step 4:

Insert two memory modules, one into each socket. They must be identical. Close the unit. (Feel free to re-enter the Main Setup Menu and change the power switch back.)

# Connections

The unit uses a variety of hardware to connect to peripheral devices or to other computer systems. When the unit connects to another system, that system is called the “remote system.”

## IR module

The IR module uses infrared technology to send signals between the unit and the remote system. The odd-shaped end of the module (the receiver/transmitter) must be placed within nine inches of the IR port located on the back of the unit. The flat side of this end must directly face the IR port. The other end connects to the remote system's serial port as shown below:

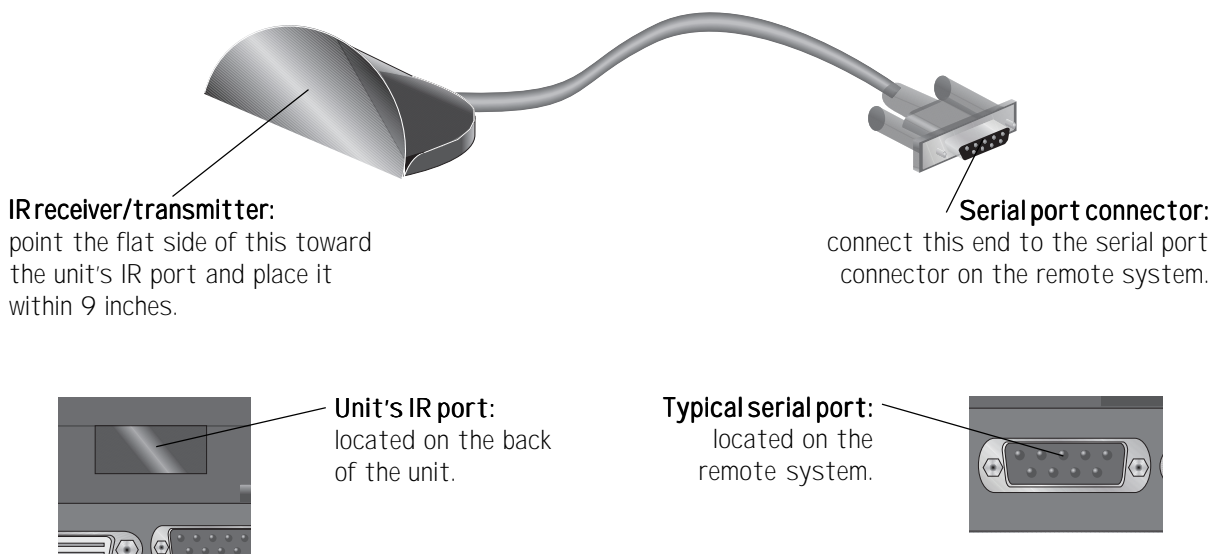

When the IR module is active, the IR module icon lights in the status display bar. (See page 8.)

## Docking bar

The docking bar, or port replicator, duplicates many of the connectors and ports found on the back of the unit as well as a line out jack for audio, a game port, and an extra PS/2 port. Peripheral devices—such as an external keyboard, mouse, or joystick—connect to the bar, which then connects to the system.

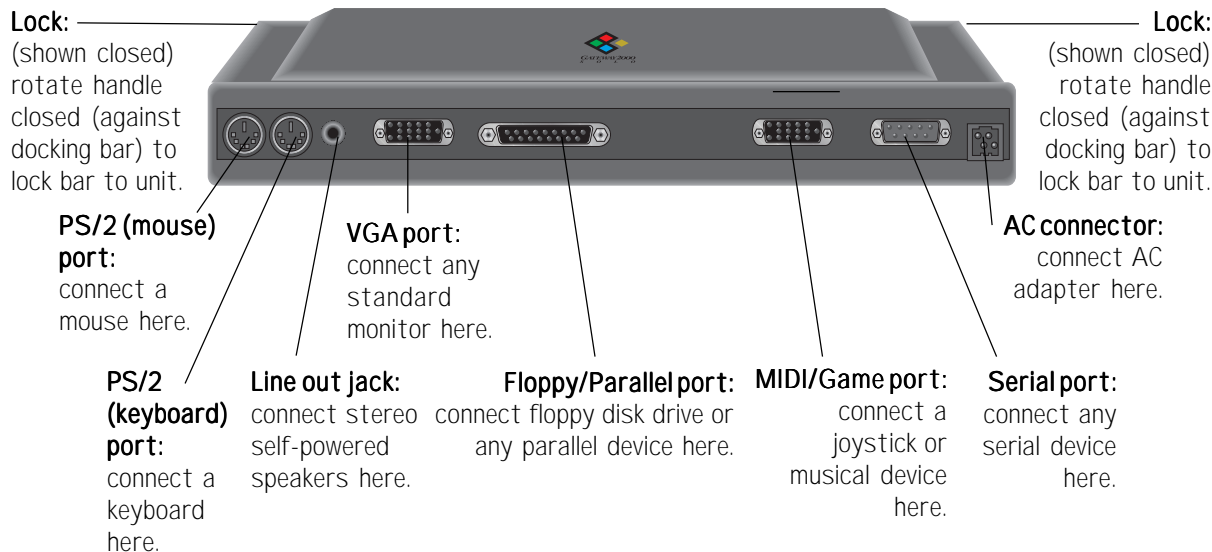

Because the peripherals connect to the unit through the docking bar, the unit connects to (or disconnects from) them in one step and at only one place: its 120-pin docking bar port. The docking bar attaches directly to the unit as shown below:

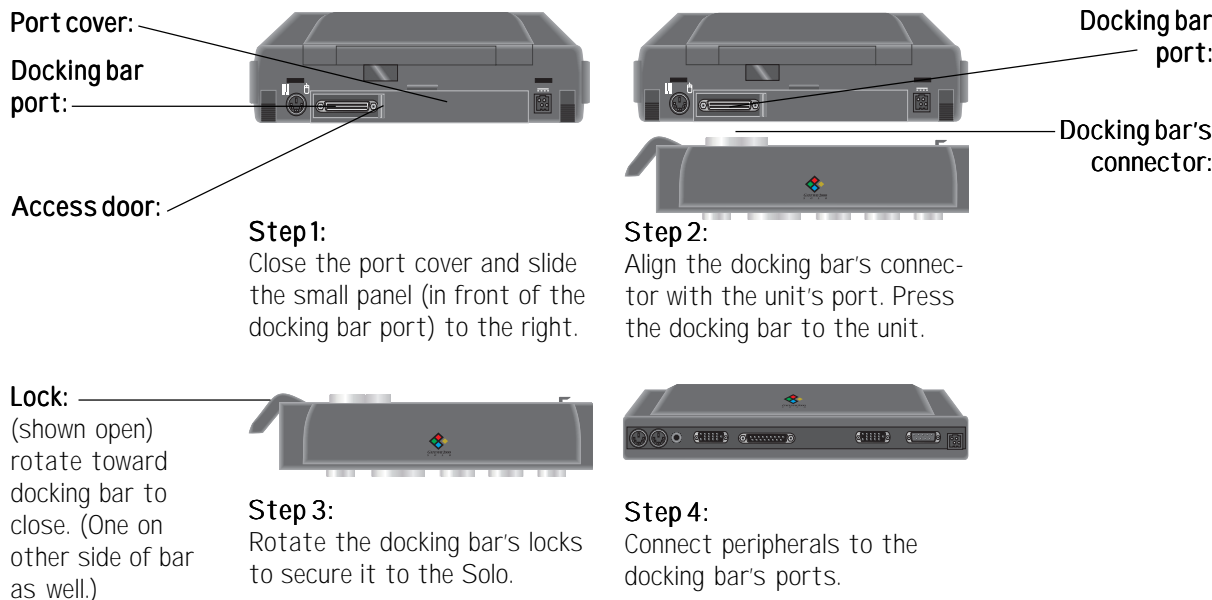

When the docking bar is installed, the docking bar icon lights in the status display bar. (See page 8.)

# Setup Menus

The system contains a series of Setup Menus, or screens, which control its security, efficiency, and functionality. The features these screens control may be modified to suit your needs. **To access these menus, press the Fn and Esc(Setup) keys simultaneously.**

## Main Setup Menu

The first screen to appear after pressing the **Fn** and **Esc(Setup)** keys is the Main Setup Menu. This menu allows you to:

- ❑ Change options such as the unit's time, date, boot drive, display option, or power switch function (See chart on page 26.)
- ❑ Access the Additional Setup Menus, which control the unit's password, port assignments, power management, keyboard setup, and other functions (See pages 26-29.)
- ❑ Exit the Setup Menus by pressing the **Esc** key.

The highlighted box on any of the Setup Menus indicates which option is selected. The arrow keys control the position of this box.

**Main menu options:**  
use arrow keys to select (highlight) desired option.

MAIN SETUP MENU		Ver.: 0.62	
Time:	00:00:00:pm (hh:mm:ss:am/pm)	ADDITIONAL SETUP MENUS	
Date:	00/00/00 (mm/dd/yy)	PASSWORD	
Boot Drive:	FDD/HDD	PORT ASSIGNMENT	
Boot Display:	LCD	POWER MANAGEMENT	
Power Switch:	SUSPEND/RESUME	MISCELLANEOUS	
		KEYBOARD	
SYSTEM INFORMATION			
CPU	: Pentium ( 75MHz)	Current display	: LCD
Memory	: 8 MB	Battery Remain	: 78%
Hard Disk	: 514 MB	Password	: DISABLED
CD-ROM Drive:	Attached	Floppy Drive	:Not Attached
■ Cursor or Tab keys to MOVE Items    ■ Enter to GO TO other Menus ■ Spacebar or BKSp key to CHANGE Settings    ■ Esc to EXIT			

**Additional Setup menus:**  
use arrow keys to select (highlight) desired menu and press Enter to open.

**To select an option from the left side of the Main Setup Menu:** press the appropriate arrow key(s) to move the highlighted box onto the desired option. The following chart indicates how to change the options:

Option	Controls	To Change
Time	unit's clock/time	select; press Enter; type correct time; press Enter.
Date	unit's calendar/date	select; press Enter; type correct date; press Enter.
Boot Drive	which drive unit boots from	select; press Spacebar to toggle between: <b>HDD</b> -unit boots from hard drive <b>FDD/HDD</b> -unit tries to boot first from floppy drive; if unsuccessful, boots from hard drive.
Boot Display	which display(s) the unit uses	select; press Spacebar to toggle between: <b>LCD</b> -only uses unit's screen;disables VGA port <b>CRT</b> -only uses external monitor <b>LCD&amp;CRT</b> -can use both types of screen at once.
Power Switch	function of power switch	select; press Spacebar to toggle between: <b>ON/OFF</b> -system reboots (or shuts off completely) when switch is pressed. <b>SUSPEND/RESUME</b> -system enters suspend mode (or resumes from suspend mode) when switch is pressed.

After changing an option, feel free to change another option, select another menu, or exit the Setup Menus.

**To select one of the Additional Setup Menus from the right side of the Main Setup Menu:** press the appropriate arrow key(s) to move the highlighted box onto the desired menu. When the desired menu is selected, press Enter.

## Password Setup Menu

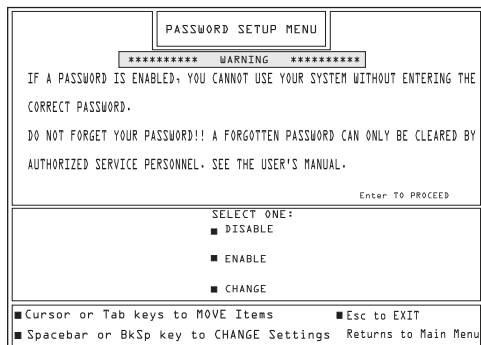

This menu allows you to enable or disable password protection for the system as well as set or change the password. Access this menu from the Main Setup Menu (See page 25.)

The following chart details the process for setting the Password Setup Menu options. (After setting an option, the screen automatically returns to the Main Setup Menu.):

Option	Function	To Change
Disable	shuts off password protection	select (can only be selected if password is currently enabled); press Enter; type old password; press Enter.
Enables	turns on password protection	select (can only be selected if password is currently disabled); press Enter; type new password, press Enter; type new password again; press Enter.
Change	changes password	select (can only be selected if password is currently enabled); press Enter; type old password, press Enter; type new password, press Enter; type new password again; press Enter.

## Port Assignment Menu

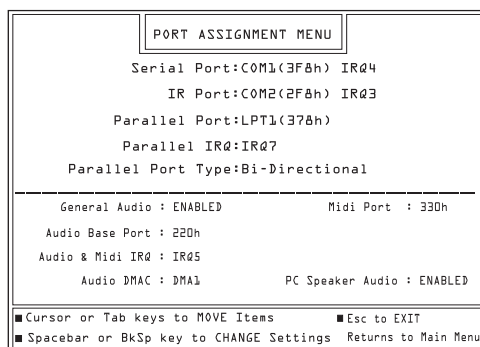

This menu allows you to designate port assignments for the system. Access this menu from the Main Setup Menu (See page 25.)

The following chart details the process for setting the Port Assignment Menu options. (After setting options, the screen automatically returns to the Main Setup Menu.):

Option	To Change
Serial Port	select; press Spacebar to toggle between: <b>COM1; COM2; COM3; COM4; or DISABLED.</b>
IR Port	select; press Spacebar to toggle between: <b>COM1; COM2; COM3; COM4; or DISABLED.</b>
Parallel Port	select; press Spacebar to toggle between: <b>LPT1; LPT2; LPT3; or DISABLED.</b>
Parallel IRQ	select; press Spacebar to toggle between: <b>IRQ5 or IRQ7.</b>
Parallel Port	select; press Spacebar to toggle between: <b>AT or BI-DIRECTIONAL.</b>
General Audio	select; press Spacebar to toggle between: <b>ENABLED or DISABLED.</b>
Audio Base Port	select; press Spacebar to toggle between: <b>220h; 230h; or 240h.</b>
Audio and MIDI IRQ	select; press Spacebar to toggle between: <b>IRQ5; IRQ2; IRQ10; IRQ5 &amp; IRQ2; IRQ5 &amp; IRQ11; IRQ10 &amp; IRQ2; or IRQ10 &amp; IRQ 11.</b>
PC Speaker Audio	select; press Spacebar to toggle between: <b>ENABLED or DISABLED.</b>
Audio DMAC	select; press Spacebar to toggle between: <b>DMA0 or DMA1.</b>
MPU-401 Base Port	select; press Spacebar to toggle between: <b>300h; 320h; 330h; or DISABLED.</b>

# Power Management Menu

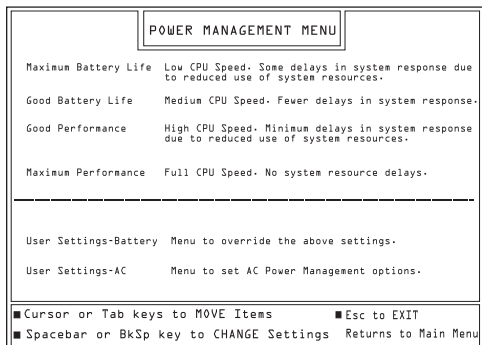

This menu allows you to control the unit’s efficiency in managing resources. Access this menu from the Main Setup Menu (See page 25.)

The following chart details the process for setting the Power Management Menu options. (After setting options, the screen automatically returns to the Main Setup Menu.):

Option	Function	To Change
Maximum Battery Life	see screen	select; press Enter.
Good Battery Life	see screen	select; press Enter.
Good Performance	see screen	select; press Enter.
Maximum Performance	see screen	select; press Enter.
User Settings-Battery	sets Battery options	select; press Enter; new menu screen appears (see screen below); select and set options individually with arrow keys; press Enter; press Esc.
User Settings-AC	sets AC options	select; press Enter; new menu screen appears (see screen below); select and set options individually with arrow keys; press Esc.

## User Settings Menu: Battery

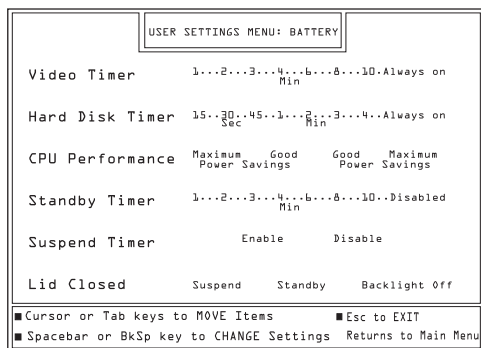

## User Settings Menu: AC

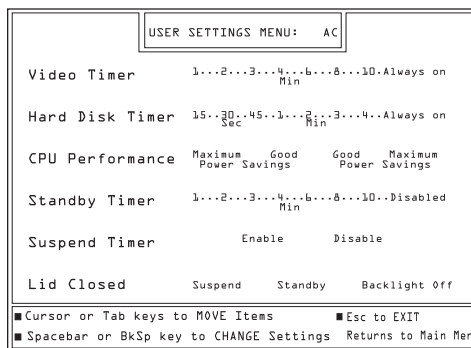

## Miscellaneous Menu

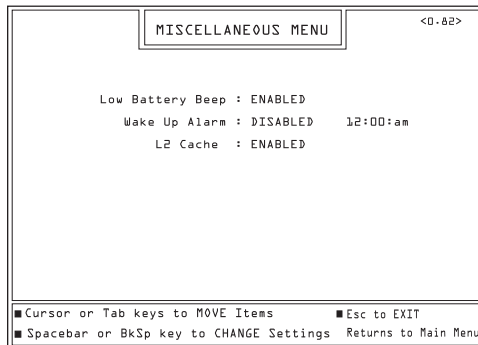

This menu allows you to set various options on the unit. Access this menu from the Main Setup Menu (See page 25.)

The following chart details the process for setting the Miscellaneous options. (After setting options, press Enter to return to the Main Setup Menu.):

Option	To Change
Low Battery Beep	select; press Spacebar to toggle between: <b>ENABLED</b> or <b>DISABLED</b> .
Wake Up Alarm	select; press Spacebar to toggle between: <b>ONE TIME; EVERY DAY;</b> or <b>DISABLED</b> . (If selecting One Time or Every Day, be sure to select the box to the right and type in the alarm time.)
L2 Cache	select; press Spacebar to toggle between: <b>ENABLED</b> or <b>DISABLED</b> .

## Keyboard Setup Menu

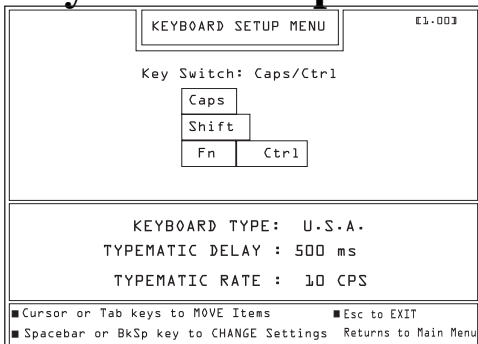

This menu allows you to control the unit's keyboard. Access this menu from the Main Setup Menu (See page 25.)

The following chart details the process for setting the Keyboard Setup options. (After setting option, press Enter to return to the Main Setup Menu.):

Option	Function	To Change
Key Switch	switches Ctrl and Caps keys	select (Caps and Ctrl keys highlighted); press Spacebar to toggle between normal key positions and reversed positions.
Keyboard Type	assigns keyboard nationality	select; press Spacebar to toggle between: <b>U.S.A., U.K., FRENCH, GERMANY;</b> or <b>JAPANESE</b> .
Typematic Delay	assigns delay for key repeat	select; press Spacebar to toggle between: <b>250ms, 500ms, 750ms, or 1000ms;</b> Press Enter
Typematic Rate	assigns speed of key repeat	select; press Spacebar to toggle between: <b>2cps, 6cps, 10cps, 15cps, 20cps, or 30cps.</b>



# Troubleshooting

Although the Gateway 2000 Solo Multimedia Notebook is designed for trouble-free performance, you may occasionally encounter minor problems. Most of these can be fixed by thoroughly double-checking connections and settings or by performing the procedures described below.

If the Solo does not respond to these solutions, feel free to contact Gateway 2000 for assistance. The warranty shipped with the unit describes several ways to request help, including traditional Portables Technical Support and our FaxBack Service.

## Start Up

When the system is turned on, the hard disk makes a whirring noise, the screen shows an image, and the status display bar shows an icon for either AC power or battery power. **If any of these do not occur, check the following parts and their connectors:**

**Hard disk:** Is it installed properly? (See page 19.) Has it recently been subjected to an excessive amount of static electricity or physical shock? (Reinstall system files from the *Gateway 2000 Solo System CD*.) Is the unit attempting to boot from the floppy drive first? (See page 26.)

**Battery (if using battery power):** Is it installed? (See page 13.) Is the battery icon on the status display bar lit or blinking? (See pages 8 and 14.) Is it charged? (See page 13.)

**AC (if using AC power):** Are all connections secure? (See page 13.) Is the AC icon on the status display bar lit? (See pages 8 and 13.) Is the light on the adapter on? (If so, power is running at least that far.) Is the outlet the power cord plugs into live? (Check it by plugging something you know works into it.) Are the cables free of cuts or damage? (If they are damaged, they may need replacing.)

**Display:** Is an image on the screen? (Windows® 95 users should see the Windows 95 desktop, Windows® for Workgroups users should see a C: prompt (C:\>) or the Windows Program Manager screen.) Is the brightness turned up? (Perhaps the screen is simply too dark to see: see page 12.)

## General

Even after the system is on and running, you may encounter one or more of the following problems. **If any of these happen, check the appropriate parts and their connectors, and try the solutions suggested:**

**The system date says January 1, 1980:** The internal battery that keeps the clock/calendar going ran completely down. This can happen if you leave the battery pack out of the unit for a day or more. To correct the problem, reset the date in the Setup Screens (page 25). Then plug the AC adapter into the unit and leave it attached for an hour or so.

**The screen says “General Failure reading drive C:”:** Try rebooting a couple times. Be sure the unit isn't too cold. If nothing works, call Gateway 2000 Customer Support.

**The screen says “Non-system disk or disk error reading drive A:”:** You have a non-bootable disk in drive A: (the floppy disk drive). Remove it and press any key.

**The screen says “Bad command or file name”:** You may have mistyped a command. Retype the command or check your operating systems manual.

**(For information on other error messages, refer to the manuals that document your operating system.)**

**The unit won't accept your password:** Check the indicators for Caps Lock, Num Lock, and Pad Lock. If any of them are on, turn them off. (You can do this before entering the password.) Then try retyping the password.

**You forgot your password:** Try to prevent this! We made the password feature very secure and there is **no** easy way to erase a forgotten password. You have to return your system to Gateway 2000 for a time-consuming repair. Call Gateway 2000 Customer Support.

**The screen looks a little dark:** Check the brightness control.

# Index

## A

AC adapter 3, 4, 5, 6, 13, 14, 24, 31  
 AC power 8, 13, 14, 22, 30  
 Audio 7, 11, 23, 27

## B

Battery 2, 4, 5, 7, 8, 13, 14, 15, 16, 22, 28, 29, 30, 31  
 Brightness 8, 12, 30, 31

## C

Caps Lock 8, 9, 31  
 Caution 2, 3  
 CD-ROM 4, 6, 8, 17, 18. *See also* Modular option bay  
 Connect 2, 3, 4, 6, 7, 8, 13, 14, 15, 18, 19, 22, 23, 24, 30, 31  
 Cover 3, 6, 7, 12, 15, 16, 17, 24  
 Cursor 8, 10, 11

## D

Docking bar 6, 7, 8, 9, 11, 12, 18, 19, 23, 24  
 Drive 2, 4, 6, 7, 8, 15, 16, 17, 18, 19, 20, 24, 25, 26, 30, 31. *See also* CD-ROM; Floppy disk; Hard disk

## E

External floppy drive 18, 19  
 EZ Pad 2, 8, 11, 16. *See also* Mouse

## F

FCC 2, 5  
 Floppy disk 6, 8, 17, 18, 19, 24, 31. *See also* Modular option bay  
 Function keypad 9, 10

## G

Game port 23, 24

## H

Hard disk 4, 7, 8, 15, 16, 19, 20, 30  
 Headphone 7, 24

## I

Icon 9, 12, 13, 16, 18, 19, 20, 23, 24, 30  
 IR module 6, 8, 23

## K

Keyboard 4, 6, 8, 9, 16, 23, 24, 25, 29  
 Keyboard Setup Menu 29

## L

Line input 7  
 Line out 7, 23, 24

## M

Main Setup Menu 12, 22, 25, 26, 27, 28, 29  
 Memory 4, 7, 22  
 Menu 9, 10, 12, 13, 22, 25, 26, 27, 28, 29  
 Microphone 7, 8, 11  
 Miscellaneous Menu 29  
 Modular option bay 6, 17  
 Mouse 4, 6, 8, 11, 23, 24. *See also* EZ Pad

## N

Num Lock 8, 9, 10, 31

## P

Pad Lock 8, 9, 10, 31  
 Password 4, 25, 26, 27, 31  
 Password Setup Menu 26  
 PCMCIA 4, 5, 7, 16, 21  
 Pointer 4  
 Port 4, 6, 8, 9, 11, 12, 18, 19, 21, 23, 24, 25, 26, 27, 30, 31  
 Port Assignment Menu 27  
 Power 2, 3, 4, 5, 8, 13, 14, 15, 16, 22, 25, 26, 28, 30  
 Power Management Menu 28  
 PS/2 2, 4, 6, 9, 11, 23, 24

## R

Reboot 5, 16, 18, 26, 31  
 Reset button 7, 16, 31

## S

Screen 4, 8, 11, 12, 16, 25, 26, 27, 28, 30, 31  
 Scroll Lock 8, 9, 10  
 Serial 4, 6, 8, 23, 24, 27  
 Setup 9, 10, 12, 13, 22, 25, 26, 27, 28, 29, 31  
 Speaker 7, 8, 11, 24, 27  
 Specifications 4  
 Standby 8, 16  
 Start 9, 15, 16, 17, 30  
 Status display bar 8, 9, 12, 13, 16, 18, 19, 20, 23, 24, 30  
 Suspend 5, 8, 16, 26  
 SVGA 4, 12

## T

Troubleshooting 30

## V

VGA 4, 6, 12, 24, 26  
 Video 4  
 Volume 7, 11

## W

Windows 2, 3, 4, 5, 8, 9, 30

# “Calling Gateway 2000 . . .”

If you encounter any “turbulence” while using your Gateway 2000 Solo™ Multimedia Notebook, feel free to contact Gateway 2000. Please take a moment before calling to determine which service listed below is most appropriate for your particular needs. In most cases, we will need your Customer ID number and order number, so please have these available when you call.

**Customer Service:** 800/846-2000

**Fax:** 605/232-2445

**Technical Support:** 800/846-2302 (U.S.)

800/846-3609 (Canada/Puerto Rico)

**Fax:** 605/232-2445

**Add-on Components:** 800/846-2080

**Fax:** 605/357-1023

**International Callers:** 605/232-2191

**FaxBack Service:** 800/846-4526

**Gateway 2000 BBS:** 605/232-2224

**Download Service:** 800/846-7562

**SYSMAN017AAUS**  
**8/95**

## Free Manuals Download Website

<http://myh66.com>

<http://usermanuals.us>

<http://www.somanuals.com>

<http://www.4manuals.cc>

<http://www.manual-lib.com>

<http://www.404manual.com>

<http://www.luxmanual.com>

<http://aubethermostatmanual.com>

Golf course search by state

<http://golfingnear.com>

Email search by domain

<http://emailbydomain.com>

Auto manuals search

<http://auto.somanuals.com>

TV manuals search

<http://tv.somanuals.com>