

GBC TITAN 1264WF/1244WF

INSTALLATION & OPERATING MANUAL

Part Number: 930-144 Rev A.



Part Number:
 1264 WF 3600242
 1244 WF 3600238

GB	Operating Instructions
I	Istruzioni per l'Uso
D	Bedienungsanleitungen
NL	Gebruiksaanwijzing
F	Mode d'Emploi
E	Instrucciones de Operación

GB

The information in this publication is provided for reference and is believed to be accurate and complete. General Binding Corporation (GBC) is not liable for errors in this publication or for incidental or consequential damage in connection with the furnishing or use of the information in this publication, including, but not limited to, any implied warranty of fitness or merchantability for any particular use.

GBC reserves the right to make changes to this publication and to the products described in it without notice. All specifications and information concerning products are subject to change without notice. Reference in this publication to information or products protected by copyright or patent does not convey any license under the rights of GBC or others. GBC assumes no liability arising from infringements of patents or any other rights of third parties.

This publication is copyrighted © 2006 by GBC. All rights reserved. The information contained in this publication is proprietary and may not be reproduced, stored, transmitted, or transferred, in whole or in part, in any form without the prior and express written permission of GBC.

I

Le informazioni contenute in questo documento sono fornite a titolo di referenza e sono considerate corrette e complete. General Binding Corporation (GBC) non si responsabilizza di eventuali errori contenuti in questo documento, né di danni incidentali o conseguenti relazionati con la fornitura e l'uso delle informazioni in questo documento, includendo senza limitazioni qualsiasi garanzia d'idoneità o commerciabilità per qualsiasi uso particolare.

GBC si riserva il diritto di effettuare cambi a questo documento e ai prodotti in esso descritti senza preavviso. Tutte le specifiche e le informazioni sui prodotti sono soggette a cambio senza preavviso.

In questo documento le referenze a informazioni e prodotti protetti da diritti di proprietà intellettuale o brevetti non trasferiscono nessuna licenza alla quale abbiano diritto GBC o altri. GBC non assume nessuna responsabilità derivante dalla violazione di brevetti o di qualsiasi altro diritto di terzi.

Copyright © 2006 Questo documento è soggetto ai diritti di proprietà intellettuale di GBC. Riservati tutti i diritti. Le informazioni contenute in questo documento sono di proprietà esclusiva e non possono essere riprodotte, conservate, trasferite, in tutto o in parte ed in modo alcuno, senza la previa autorizzazione espressa e per iscritto di GBC.

D

Die Informationen in dieser Druckschrift werden als Richtlinien zur Verfügung gestellt und sind unseres Wissens richtig und vollständig. General Binding Corporation (GBC) lehnt jede Haftung für Fehler in dieser Druckschrift sowie für Schadenersatz oder Folgeschäden im Zusammenhang mit der Bereitstellung oder Verwendung der hierin enthaltenden Informationen ab, ein- aber nicht ausschließlich die Gewährleistung für Eignung und handelsübliche Qualität für einen bestimmten Zweck.

GBS behält sich das Recht vor, diese Druckschrift und die darin beschriebenen Produkte ohne Vorankündigung zu ändern. Alle die Produkte betreffenden Leistungsbeschreibungen und Informationen können jederzeit ohne Vorankündigung geändert werden.

Durch die Bezugnahmen in dieser Druckschrift auf urheberrechtlich oder durch ein Patent geschützte Informationen oder Produkte werden keine Rechte von GBC oder Dritten übertragen. GBC lehnt jede Haftung für Patentverletzungen sowie für die Verletzung anderer Rechte von Dritten ab.

Diese Druckschrift ist durch GBC urheberrechtlich geschützt (© 2006). Alle Rechte vorbehalten. Die Informationen in dieser Druckschrift sind gesetzlich geschützt und dürfen ohne vorherige und ausdrückliche schriftliche Genehmigung von GBC in keiner Weise weder ganz noch teilweise vervielfältigt, aufbewahrt, weiter verbreitet oder übertragen werden.

NL

De informatie in deze publicatie geldt slechts ter verwijzing en wordt nauwkeurig en volledig geacht. General Binding Corporation (GBC) is niet aansprakelijk voor fouten in deze publicatie of voor incidentele of voortvloeiende schade in verband met het verschaffen of gebruik van de informatie in deze publicatie, inclusief, maar niet beperkt tot stilzwijgende garanties van geschiktheid voor een bepaald doel of verkoopbaarheid.

GBC behoudt zich het recht voor om zonder voorafgaande kennisgeving wijzigingen te maken in de producten die hierin worden beschreven. Alle specificaties en informatie m.b.t. producten kunnen zonder voorafgaande kennisgeving gewijzigd worden.

Verwijzingen in deze publicatie naar informatie of producten beschermd door copyrights of patenten houdt geen licenties onder de rechten van GBC of anderen in. GBC is niet aansprakelijk voor schendingen van patenten of andere rechten van derden.

De publicatie is auteursrechtelijk beschermd, copyright © 2006 door GBC. Alle rechten voorbehouden. De informatie in deze publicatie is eigendom van GBC en mag niet verveelvuldigd, opgeslagen, overgebracht of overgedragen worden, geheel of gedeeltelijk, in welke vorm dan ook zonder voorafgaande en uitdrukkelijke schriftelijke toestemming van GBC.

F

L'information contenue dans cette publication est fournie à titre de référence et elle est considérée exacte et complète. General Binding Corporation (GBC) n'est pas responsable des erreurs contenues dans cette publication ni des dommages indirects ou consécutifs portant sur l'utilisation ou la présentation de l'information de ce document, y compris, mais sans s'y limiter, toute garantie implicite de commercialité ou d'adaptation à un usage particulier.

GBC se réserve le droit d'apporter des modifications à cette publication et aux produits qui y sont décrits sans préavis. Toutes les spécifications et l'information au sujet des produits sont sujettes à changements sans préavis.

Toute référence à l'information ou aux produits protégés par un droit d'auteur ou un brevet présentée dans ce document ne porte aucune licence sous les droits de GBC ou d'autres parties. GBC n'assume aucune responsabilité découlant de contraventions aux brevets ou à tout autre droit de tierces parties.

Cette publication est protégée par un droit d'auteur © 2006 de GBC. Tous droits réservés L'information contenue dans cette publication est privative et ne peut pas être reproduite, mise en mémoire, transmise ou transférée, en partie ou en entier, sous quelque forme que ce soit sans la permission écrite préalable et expresse de GBC.

E

La información contenida en esta publicación es proporcionada a título de referencia y se considera que es precisa y completa. General Binding Corporation (GBC) no es responsable por errores contenidos en esta publicación o por daños consecuentes o incidentales relacionados con la disponibilidad o el uso de la información en esta publicación, incluyendo y sin limitarse a, cualquier garantía de aptitud y comerciabilidad para cualquier uso específico.

GBC se reserva el derecho de hacer cambios en esta publicación y a los productos descritos en la misma sin aviso previo. Todas las características y la información referente a los productos, están sujetas a cambios sin aviso previo.

Las referencias en esta publicación a información o productos protegidos por derechos de propiedad intelectual o por patentes no otorga ninguna licencia amparada por los derechos de GBC u otros. GBC no asume ninguna responsabilidad que se derive de la violación de patentes u otros derechos de terceras partes.

Copyright © 2006 Esta publicación está amparada por derechos de propiedad intelectual de GBC. Todos los derechos reservados. La información contenida en este documento es de propiedad exclusiva y no puede reproducirse, almacenarse, transmitirse o transferirse, en su totalidad o en partes, y de ninguna manera, sin la autorización previa y por escrito de GBC.

GB

TABLE OF CONTENTS

Description	Page No.
Cover	1
Legal Disclaimer	2
Table of Contents	3
Important Safety Instructions	4
Important Safeguards	4
General ,Electric & Service	
Warranty	5
Specifications	5
Pre- Installation	6
Installation	6
Section 1-Detailed Specifications:	
Description	7
Features	7
Applications	7
Section 2-Consumables:	
Film Types	8
Film Dimensions	8
Core Size	8
Film Widths	8
Paper Widths	8
Section 3-Function:	
Speed	9
Motor	9
Heating Capabilities	9
Controls	9
Roll Design	9
Section 4-Electrical:	
Requirements	9
BTU Output	9
Heater Wattage	10
Amperage Draw	10
D/C Voltage Used	10
A/C Voltage Used	10
Plug Configuration and Type	11
Section 5-Dimensions:	
Weight	12
Dimensions	12
Nip Height	12
Section 6-know your Laminator:	
Parts reference Guide	13
Front View	14
Rear View	14
Left Side View	15
Right Side View	15
Definition of Parts	16
Section 7-Display Control Panel:	
Stand-By Mode	17
Jobs	17
Measure	17
Cooling	17
Run	17

Description	Page No.
Top/Bottom Temperature Control	18
Stop	18
Reverse	18
Auto-Off	19
Ready	19
Wait	19
Section 8-Safety:	
Emergency Stops	20
Safety Shield	20
Feed Table	21
Section 9-How To Guide:	
Loading Film	22
Select and Change Nip Settings	24
In-Line Slitters	25
Rear Cut-Off Blade	25
Section 10-Applications:	
Film Loading and Threading	26
Load a Roll of Film	
Webbing Thermal Film using	27
Threading Card	
Webbing PSA Film / Mount Adhesive	28
Using Threading Card	
Start Laminating	29
Method for Tacking new Film to	30
Existing Film	
To Unweb The Laminator	31
Clearing a Film Jam (Wrap- Up)	31
Applications	
Tips for Pre-Coating Boards	32
Tips for Mounting Pre-Coated Boards	32
Tips for Single Sided Lamination	32
Tips for Creating a Decal	33
Tips for Mounting a Decal	33
Thermal Encapsulation	33
AccuShield™	34
Speed/Temperature Control	33
The Art of Lamination	
Basic Rules	35
Film Tension	35
Heat	35
Output	36
Maintenance	37
Trouble Shooting Guide	38
Service Agreement	38

IMPORTANT SAFETY INSTRUCTIONS

YOUR SAFETY AS WELL AS THE SAFETY OF OTHERS IS IMPORTANT TO GBC. IN THIS INSTRUCTION MANUAL AND ON THE PRODUCT, YOU WILL FIND IMPORTANT SAFETY MESSAGES REGARDING THE PRODUCT. READ THESE MESSAGES CAREFULLY. READ ALL OF THE INSTRUCTIONS AND SAVE THESE INSTRUCTIONS FOR LATER USE.

⚠ THE SAFETY ALERT SYMBOL PRECEDES EACH SAFETY MESSAGE IN THIS INSTRUCTION MANUAL. THE SYMBOL INDICATES A POTENTIAL PERSONAL SAFETY HAZARD TO YOU OR OTHERS. THE FOLLOWING WARNINGS ARE FOUND UPON THIS PRODUCT.

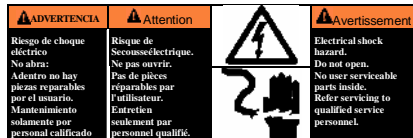

THIS SAFETY MESSAGE MEANS THAT YOU COULD BE SERIOUSLY HURT OR KILLED IF YOU OPEN THE PRODUCT AND EXPOSE YOURSELF TO HAZARDOUS VOLTAGE.



THIS SAFETY MESSAGE MEANS THAT YOU COULD BE BURNED AND YOUR FINGERS COULD BE TRAPPED AND CRUSHED IN THE HOT ROLLERS. CLOTHING, JEWELRY AND LONG HAIR COULD BE CAUGHT IN THE ROLLERS AND PULL YOU INTO THEM.



THIS SAFETY MESSAGE MEANS THAT YOU COULD CUT YOURSELF IF YOU ARE NOT CAREFUL.

⚠ WARNING: THIS SAFETY ALERT SYMBOL PRECEDES EACH SAFETY MESSAGE IN THIS INSTRUCTION MANUAL. THE SYMBOL INDICATES A POTENTIAL PERSONAL SAFETY HAZARD TO YOU OR OTHERS.

⚠ WARNING: DO NOT ATTEMPT TO SERVICE OR REPAIR THE 1264/1244 WF LAMINATOR.

⚠ WARNING: DO NOT CONNECT THE LAMINATOR TO AN ELECTRICAL SUPPLY OR ATTEMPT TO OPERATE THE LAMINATOR UNTIL YOU HAVE COMPLETELY READ THESE INSTRUCTIONS. MAINTAIN THESE INSTRUCTIONS IN A CONVENIENT LOCATION FOR FUTURE REFERENCE.

IMPORTANT SAFEGUARDS

⚠ WARNING: TO GUARD AGAINST INJURY THE FOLLOWING SAFETY PRECAUTIONS MUST BE OBSERVED IN INSTALLATION AND USE OF THE LAMINATOR.

General:

Keep hands, long hair, loose clothing, and articles such as necklaces or ties away from the front of the heat and pull rollers to avoid entanglement and entrapment.

The heat rollers can reach temperatures over 300°F (150°C). Avoid contact with the heat rollers during operation or shortly after power has been removed from the laminator.

Keep hands and fingers away from the path of the sharp film cutter blades.

Do not use the laminator for other than its intended purpose.

Avoid moving the Laminator on uneven floor surfaces. Never tilt the laminator.

Do not defeat or remove electrical and mechanical safety equipment such as interlocks, shields and guards.

Do not insert objects unsuitable for laminating or expose the equipment to liquids.

Electrical:

The Laminator should be connected only to a source of power as indicated in these instructions and on the serial plate located on the rear of the laminator. Contact an electrician should the attachment plug provided with the Laminator not match the receptacles at your location.

⚠ WARNING: THE RECEPTACLE MUST BE LOCATED NEAR THE EQUIPMENT AND EASILY ACCESSIBLE.

Do not operate the Laminator with a damaged power supply cord or attachment plug, upon occurrence of a malfunction, or after the laminator has been damaged. Contact GBC's Technical Service Department or your dealer/distributor for assistance.

Service:

Perform only the routine maintenance procedures referred to in these instructions

⚠ WARNING: DO NOT ATTEMPT TO SERVICE OR REPAIR THE LAMINATOR

Disconnect the plug from the receptacle and contact GBC's Technical Department or your dealer/distributor when one or more of the following has occurred.

- The power supply cord or attachment plug is damaged.
- Liquid has been spilled into the laminator.
- The laminator is malfunctioning after being mishandled.
- The laminator does not operate as described in these instructions.

WARRANTY

Limited 90- Day Warranty

GBC warrants to the original purchaser for a period of ninety days on labor and one year on parts after installation that this laminator is free from defects in workmanship and material under normal use and service. GBC's obligation under this limited warranty is limited to replacement or repair, at GBC's option, of any part found defective by GBC without charge for material or labor.

THIS LIMITED WARRANTY IS IN LIEU OF ALL OTHER WARRANTIES EXPRESSED OR IMPLIED. WARRANTIES OF MERCHANTABILITY OR FITNESS FOR A PARTICULAR PURPOSE ARE EXPRESSLY EXCLUDED. ANY REPRESENTATIONS OR PROMISES INCONSISTENT WITH, OR IN ADDITION TO, THIS LIMITED WARRANTY ARE UNAUTHORIZED AND SHALL NOT BE BINDING UPON GBC. IN NO EVENT SHALL GBC BE LIABLE FOR ANY SPECIAL, INCIDENTAL, OR CONSEQUENTIAL DAMAGES, WHETHER OR NOT FORESEEABLE.

This limited warranty shall be void if the laminator has been misused; mishandled; damaged by negligence, by accident, during shipment, or due to exposure to extreme conditions; repaired, altered, moved, or installed by anyone other than GBC or its authorized agents; or if incompatible film was used. GBC's obligation under this limited warranty does not include routine maintenance, cleaning, adjustment, normal cosmetic or mechanical wear, or freight charges.

Without limiting the generality of the previous paragraph, GBC's obligation under this limited warranty does not include:

1. Damage caused to the rollers by knives, razors, or other sharp tools: by any foreign objects falling into the working area of the laminator; or by cleaning the laminator with solutions or materials that harm its surfaces;
2. Damage caused by adhesives; nor
3. Damage caused by lifting, tilting or attempting to position the laminator other than rolling it on its castors across even surfaces.

FOR EUROPEAN UNION RESIDENTS ONLY: This guarantee does not affect the legal rights which consumers have under applicable national legislation governing the sale of consumer goods.

SPECIFICATIONS	
Operating Speed	0 to 10 fpm (3.0m/min) MAX
Maximum Temperature	320°F (160°C)
Maximum Mounting Thickness	Main Roller-5/8 th in. (15 mm) Max. Pull Roller-5/8 th in. (15mm)
Maximum Film Width 1264WF 1244WF	61 in. (155. cm.), 62 in. Pressure Sensitive Films 42 in. Max paper width. (107 cm.), 42 In. Pressure Sensitive Films.
Dimensions (W x D x H) 1246WF 1244WF	Unit alone: (Uncrated) 80 in. x 28in. x 51in. (203 cm. x71 cm x 129 cm.) 60 in. x 28in. x 51in. (152 cm. x71 cm x 129 cm.)
Weight 1244 WF 1264 WF	Unit alone: 275 lbs (125 kg) 600 lbs (272 kg)
Electrical Requirements US Models- CE Models-	Refer to the serial plate located on the rear of the laminator for the specific electrical rating applicable to the unit. Unit is rated for 220VAC-240AC. Do not exceed 240VAC. For best results it is recommended that 230VAC be used. 230V, 30Amps, 60 HZ. Single Phase. 7000Watts 80.in x 28in. x 51in. (203 cm. x71 cm x 129 cm.) 230V, 15Amps, 50 HZ .Single Phase, 7000 Watts 80.in x 28in. x 51in. (203 cm. x71 cm x 129 cm.)
FCC NOTE	FCC Class A Notice - Notification pour les Etats-Unis Note: This equipment has been tested and found to comply with the limits for a Class A digital device, pursuant to part 15 of the FCC rules. These limits are designed to provide reasonable protection against harmful interference when the equipment is operated in a commercial environment. This equipment generates, uses, and can radiated radio frequency energy and, if not installed and used in accordance with the instruction manual, may cause harmful interference to radio communications. Operation of this equipment in a residential area is likely to cause harmful interference in which case the user will be required to correct the interference at their own expense. Canada Class A Notice - Avis Canada, Class A This Class A digital apparatus complies with Canadian ICES-003. Cet appareil numérique de la classe A est conforme à la norme NMB-003 du Canada. Modifications Any modifications made to this device that are not approved by General Binding Corporation may void the authority granted to the user by the FCC and/or by Industry Canada to operate this equipment. Toutes modifications apportées à ce dispositif et non approuvées par General Binding Corporation annuleront le droit accordé à l'utilisateur par le FCC et/ou par Industrie Canada de faire fonctionner cet équipement.

PRE-INSTALLATION

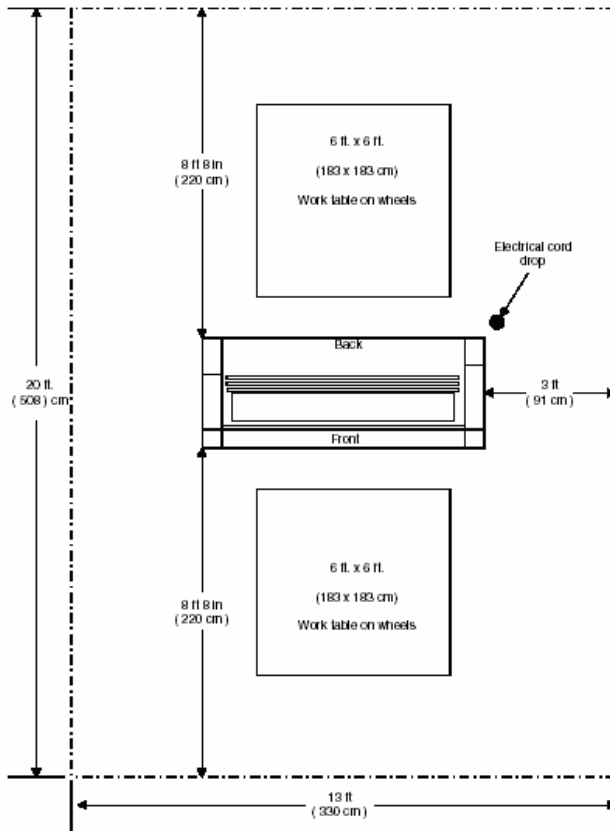

Before a 1264WF/1244WF Laminator can be installed, ensure the following requirements are met:

1. Are doorways and hallways wide enough for the laminator to be moved to the installation site?
2. Is there ample room for the laminator?
 - A work area must be established that allows for operation in both the front and rear of the laminator and provides space for efficient material flow.
3. Is the environment appropriate for the laminator?
 - The laminator requires a clean, dust and vapor free environment to operate properly.
 - Avoid locating the laminator near sources of heat or cold. Avoid locating the laminator in the direct path of forced, heated or cooled air.

CAUTION: Air flow can cause uneven heating / cooling of the rollers and result in poor output quality.

4. Have you contacted a certified electrician to wire the receptacle and ensure that adequate power is being supplied, having the appropriate capacity, over current protection and safety lockouts available?

GBC 1264 WF/1244 WF Requires:

- 230V at 60Hz with 30 amps single phase.
 - 1264WF: Nema 6-30P 30A 230V Receptacle.
 - 1244WF: Nema 6-20P 20A 230V Receptacle.
- The machines are supplied with Male Plugs.

INSTALLATION

1. Shipping damage should be brought to the immediate attention of the delivering carrier.
2. With assistance, carefully roll the laminator into position over flat and even surfaces.
3. The laminator should be positioned to allow exiting film to flow freely to the floor or a work table. Accumulation of laminate immediately behind the laminator as it exits the equipment may cause the film to wrap around the pull rollers, resulting in a "jammed" condition.
4. Avoid locating the laminator near sources of heat or cold. Avoid locating the laminator in the direct path of forced, heated or cooled air.
5. Once the laminator has been properly positioned, lock the castors in place. Locking the castors prevent the machine from rolling during set up, operation or servicing.
6. Connect the attachment plug provided with the laminator to a suitably grounded outlet. Avoid connecting other equipment to the same branch circuit to which the laminator is connected, as this may result in nuisance tripping of circuit breakers or blowing fuses.

Note: Machine must be leveled to ensure best performance. Level the machine by lowering both the main and pull rolls. Lay a level on top of the main and pull rolls. Then, check level from main roll to pull roll on right and left side of the roll. Finally, check by placing the level diagonally across lower main to lower pull rolls.

Section 1: Detailed Specifications

Specifications provide all of the technical data for the Titan 1244WF & 1264WF

Description:

- A high speed laminator for the graphic arts professional as well as for the manufacturer who produces promotional pieces in-house. A new elegant design, low power consumption and first class safety and quality assurances.

Features:

- Roller heating technology
- Independent control of each heater
- Thermal and cold lamination capabilities
- Unique vented cooling system
- Mounting capabilities to 5/8th in.-15mm.
- Easy to use control panel
- 9 Programmable job settings
- LCD temperature displays for each heat roller
- Rear out put slitter.
- Swing out shafts for ease of loading film.
- In-Line slitters.
- Accushield capable.

Applications:

- Encapsulation-Promotional-materials, posters, counter cards, POP displays, calendars, instructional displays, phone & debit cards, blueprints, menus, maps, flipcharts, etc.

Section 2: Consumables

Film Types:

- Poly-in films, thermal and PSA films
- Poly-out films, thermal and PSA
- Accushield

Film Diameters:

- Up to a 7 in. outside roll diameter. (18 cm.)

Core Size:

- 3 in. core standard. (76 cm.)

Film widths:**1264WF**

- 61 in. Thermal films (155 cm.)
- 62 in. PSA (157 cm.)

12444WF

- 42 in. maximum paper width (107 cm.)
- 42 in. PSA films (107 cm.)

Paper widths:**1264WF**

- 62 in. Maximum paper width (157 cm.)

12444WF

- 42 in. maximum paper width (107 cm.)

Section 3: Function

- Speed:**
- 0-10 fpm (0-6.1mpm)
- Motor:**
- DC Geared Motor
- Heating Capabilities:**
- Up to 320* F. (160*C)
- Controls:**
- Operations control panel
- Roll Design:**
- High release silicone main rollers
 - High release pull roll

Section 4: Electrical

Requirements:

- 1264 WF:
- 1264WF CE:
- 1244 WF:
- 1244WF CE:
- 230 VAC, 60Hz, Single phase, 30Amps.
- 230 VAC, 50Hz. Single phase, 20Amps.
- 230 VAC, 60Hz. Single phase, 20 Amps.
- 230 VAC, 50Hz. Single phase, 20 Amps.

B.T.U output:

- 1264 WF:
- 1264WF CE:
- 1244 WF:
- 1244WF CE:
- 30708 B.T.U./hour
- 22519 B.T.U./hour
- 20472 B.T.U./hour

Heater Wattage:

- 1264 WF:
- 1264WF CE:
- 1244 WF:
- 1244WF CE:
- 4500W / Heater
- 3300W / Heater
- 3000 W / Heater

Amperage draw:

- 1264 WF:
- 1264WF CE:
- 1244 WF:
- 1244WF CE:
- Drive Motor=3.3 Amps.
- Fan Motor=0.5 Amps.
- Motors and Heater=25 Amps.
- Drive Motor=3.3 Amps.
- Fan Motor=0.5 Amps.
- Motors and Heater=13 Amps.
- Drive Motor=3.3 Amps
- Fan Motor=0.5 Amps
- Motors and Heater=12Amps

D/C Voltage used:

- 36 VDC Motor Voltage
- 24 VDC Fan Motor

A/C Voltage Used:

- 230 VAC Recommended...(Not to exceed 240VAC)

Connectors for 1264 WF

Connectors for 1244 WF

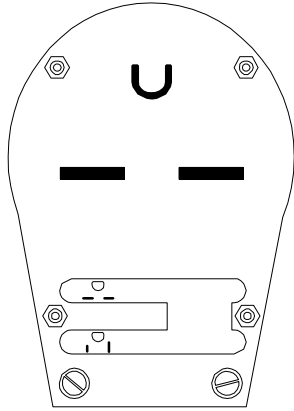

NEMA 6-30 P

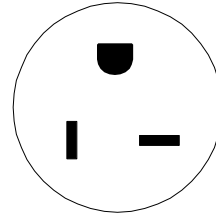

NEMA 6-20 P

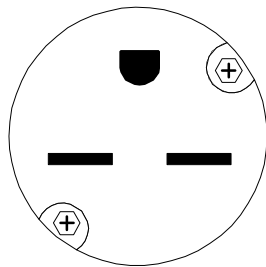

NEMA 6-30 R

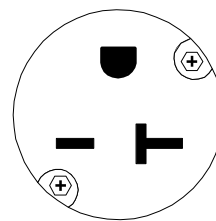

NEMA 6-20 R

Section 5: Dimensions

Weight:

- 1264 WF:
 - 1264WF CE:
 - 1244 WF:
 - 1244WF CE:
- Crated: 750 lbs. (340 kg.)
 - Uncrated: 600 lbs. (272 kg.)
 - Crated: 350 lbs (159 kg.)
 - Uncrated: 275 lbs (125 kg.)

Dimensions:

- 1264 WF:
 - 1264WF CE:
 - 1244 WF:
 - 1244WF CE:
- Crated: 58 in.(H) x 87 in. (W) x 40 in. (D)
147 cm. (H) x 221 cm. (W) x 102 cm. (D)
 - Uncrated: 49in(H) x 77.25 in.(W) x 25.5 in. (D)
124 cm. (H) x196 cm. (W) x65cm. (D)
 - Crated: 57 in.(H) x 68 in. (W) x 38 in. (D)
145 cm. (H) x 173 cm. (W) x 97 cm. (D)
 - Uncrated: 49in(H) x 77.25 in.(W) x 25.5 in. (D)
124 cm. (H) x145 cm. (W) x65cm. (D)

Nip Height:

- 35.63 in (91cm.)

Section 6: Know your Laminator

This section is intended to aide the user in becoming more familiar with the 1244 WF & 1264 WF laminators. Refer back to this section if you have questions regarding references to certain parts of the laminator in this laminator.

1.) Safety Shield

9.) Rewind Clutch Adjustment Knob

2.) Control Panel

10.) Rewind Shaft & Rewind Tube

3.) Feed Table

11.) Rear Slitter

4.) Lower Film Shaft/Unwind Shaft

12.) Power Switch

5.) Upper Film Shaft/Unwind Shaft

13.) Foot Pedal

6.) Unwind Brake

14.) Power Cord

7.) Pressure Plate

15.) Web Clutch

8.) Emergency Stop/E-Stop

16.) Roller Lift Handle/Gap Adjustment Handle

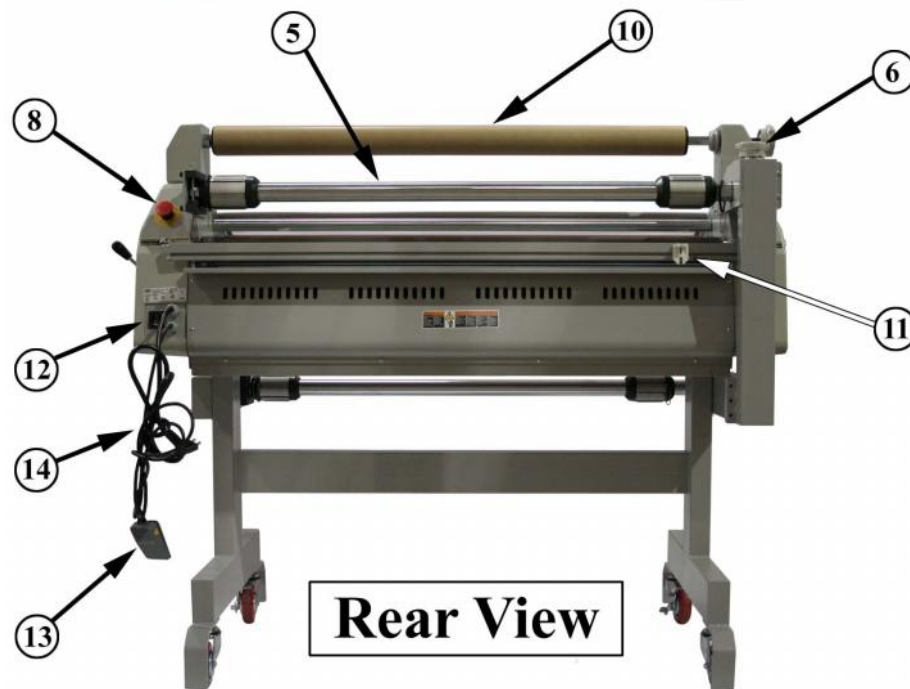
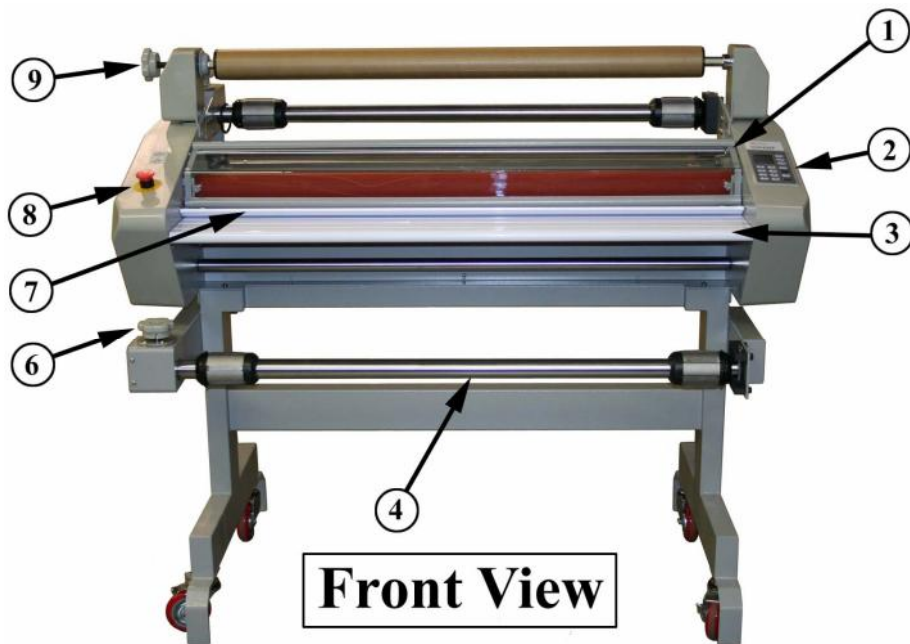

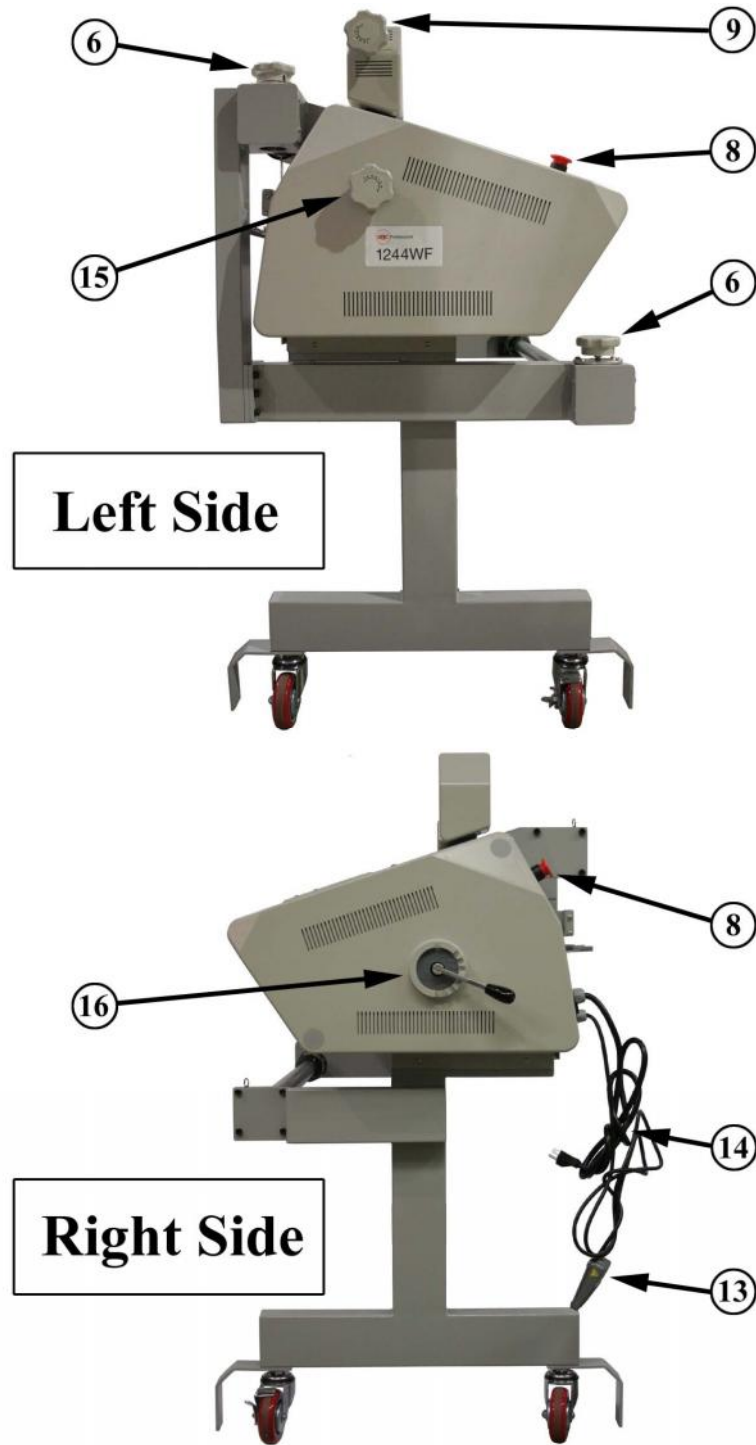

Know your Laminator Continued-

1.) Safety Shield:

- The Safety Shield aids in preventing the operators fingers from becoming pinched or burned in the heat rollers of the laminator. With the Safety Shield raised or removed, the machine goes into the safety mode that prevents the run button on the control panel from starting the rollers to turn. The foot pedal must be used when the Safety Shield is raised or removed.

2.) Control Panel:

- The Control Panel enables the operator to control motor run/stop, motor direction, motor speed, cooling fans, top temperature, bottom temperature, job number selection, job programming and temperature reading.

3.) Feed Table:

- The Feed Table supports the product that is to be laminated. It also prevents full access to the roller nip (where the upper and lower roller meet) of the laminator. Because of this, the laminator has been designed not to operate when the Feed Table is removed. Re-install the Feed Table before attempting to operate the laminator.

4.) Lower Film Shaft/Unwind Shaft:

- The Lower Film Shaft/Unwind Shaft holds the lower film and allows the end user to apply tension to the web.

5.) Upper Film Shaft/Unwind Shaft:

- The Upper Film Shaft/Unwind Shaft holds the Upper film and allows the end user to apply tension to the web.

6.) Unwind Brake:

- The Unwind Brakes are used to apply tension to the web.

7.) Pressure Plate:

- The Pressure Plate assists in keeping the leading edge and the trailing edge of the print flat when fed into the laminator.

8.) Emergency Stop/E-Stop:

- The Emergency/E-Stops are a safety feature that allows the operator to stop the rollers from rotating by depressing them as needed.

9.) Rewind Clutch Knob:

- The rewinder is clutch driven. As you increase the tension on the Rewind Clutch Knob, the amount of force is increased and increases the rate/strength of the rewinder.

10.) Rewind Shaft:

- The Rewind Shaft is driven by a clutch system. The greater you increase the clutch; the amount of force is increased and increases the rate/strength of the rewinder.

11.) Rear Slitter:

- The Rear slitter is intended to cut the web output from the laminator and should not be used for any other purpose.

12.) Power Switch:

- The Main Power Switch turns the laminator on and off. It supplies power to the laminator.

13.) Foot Pedal:

- The Foot Pedal allows the operator to start and stop the machine without using the Main Control Panel.

14.) Power Cord:

- The Power cord comes with the machine and requires certain plug configurations. Please see the Specs to determine correct outlet configuration.

15.) Web Clutch:

- Use the Web clutch to control tension between the main rolls and the pull rollers. This will assist the end user in ensuring good output.

16.) Roll Lift Handle/Gap Adjust. Handle:

- Use this Handle to select the proper settings depending on what application is to be used.

Section 7: Display Control Panel

Stand-by

Pressing **STAND-BY** will cause the laminator to go into the AUTO-OFF mode. The laminator will automatically go into this mode after sitting idle for an extended amount of time. When in AUTO-OFF mode the laminator will no longer continue to heat the main rollers to save power.

Stand-by

Pressing **MEMORY** will cause the current speed and heat settings to be recorded in the JOB memory location shown on the display.

Jobs

Pressing the up or down arrows will cause the unit to cycle through stored jobs. Up to 9 separate jobs can be stored. To save a job, select one of the nine jobs to overwrite. Then change the heat and speed settings as required for your application. Once selected, press the memory button once.

Measure

Press and hold the **MEASURE** key to display the current roller temperature.

Cooling

When the **COOLING** button is pressed the cooling fans will turn on or off. The **COOLING** button will illuminate green when the fans are on. The fans blow fresh air on the film web in between the heat and pull rollers.

Run

When the **RUN** is pressed the rollers will begin turning. However, pressing run will not cause the rollers to turn when any of the following are true: the Emergency Stop is engaged, Safety Shield is raised or removed and/or the feed table is removed.



Display Control Panel-Continued

Top and Bottom Temperature

Use the up or down arrow keys to increase or decrease the set temperature of the heat rollers. The temperature shown on the display is the temperature at which the unit is attempting to attain. For example if the unit is set to 200°F even though the actual roller temperature may be higher or lower. To view the actual temperature press **MEASURE**.

Stop

The **STOP** button ceases the forward rotation of the rollers.

Reverse

Pressing the **REVERSE** button causes the rollers to turn in the reverse direction. The rollers will only turn in reverse as long as the **REVERSE** button is depressed.



Display Control Panel-Continued

The Temperature displayed in the area referred to as **TOP TEMPERATURE** and **BOTTOM TEMPERATURE** is the value that the laminator is attempting to attain. Pressing the **MEASURE** button will momentarily display the actual roller temperature.

The current speed and job settings are given on the right side of the display.

The current state of the heat rollers is given on the lower portion of the display. The unit will always be in one of three states: **AUTO-OFF**, **READY**, or **WAIT**.

Auto-Off

In the **AUTO-OFF** state (also referred to as Standby) the unit will no longer continue to heat the main rollers. The unit will go into this state after a period of inactivity or by pressing the **STAND-BY** key. Press the **STAND-BY** key to bring the unit out of **AUTO-OFF** mode. See Fig. A

Ready

The **READY** icon will flash when the actual roller temperature is nearing but not quite met the target temperature.

The **READY** icon will be displayed continually when the actual roller temperature is within +/- 15* F of the target temperature entered by the operator. See Fig. B

Wait

The **WAIT** icon is displayed when the actual roller temperature is much higher or lower than the target temperature entered by the user. See Fig. C

Fig. A

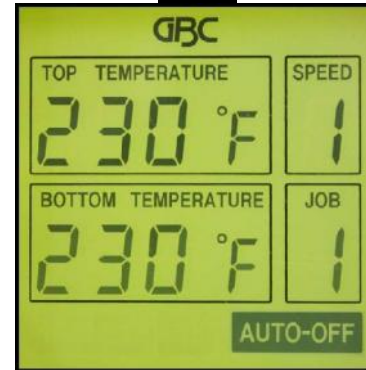

Fig. B



Fig. C



Section 8: Safety

The 1244Wf & 1264 WF have numerous safety features that will help keep the operator safe from harm. But for these features to work correctly, the user must become familiar with each of the safety mechanisms as well as never override a safety feature.

Emergency Stop/E-Stop

Two **Emergency Stops** (Sometimes referred to as E-Stops) are located on the 1244 WF & 1264 WF laminators. See the “*Know your Laminator*” section for the locations.

Pressing any one of the two **Emergency Stops** will immediately stop all roller motion.

To reset the **Emergency Stop**, simply rotate the red top clockwise; this will cause the red top to pop upward and allow the rollers to turn again.



Safety Shield

The **Safety Shield** aids in preventing the operators fingers from becoming pinched or burned in the heat rollers of the laminator. With the **Safety Shield** raised or removed, the machine goes into the safety mode that prevents the **RUN** button on the control panel from starting the rollers to turn. The foot pedal must be used when the **Safety Shield** is raised or removed. Use caution when operating the unit with the shield removed.

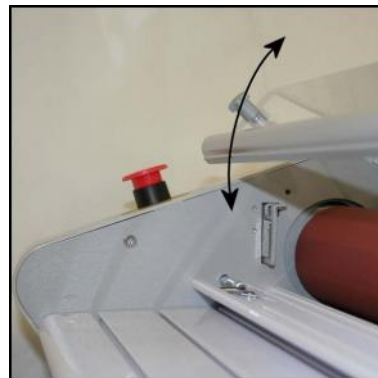

Safety Shield-Continued

To remove the **Safety Shield**, first raise the shield and locate the spring hinge pin on the right side of the shield. Pull the pin to release the shield from the laminator as illustrated in the photo.

**Feed Table**

The **Feed Table** supports the product to be laminated. It also prevents full access to the roller nip (where the upper and lower roller meet) of the laminator. Because of this the laminator has been designed not to operate when the **Feed Table** is removed. Re-install the **Feed Table** before attempting to operate the laminator.

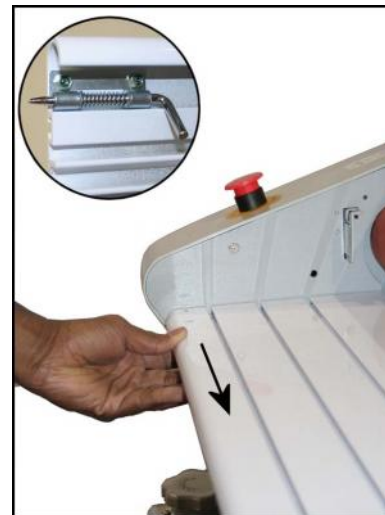

Section 9: How to Guide

This section discusses how to load film on the unwinds, how to center film, how to select and change the nip, how to center film, how to select and change the nip, how to use the inline slitters and rear slit.

Loading Film

Begin by removing the hinge pin that prevents the film shaft from swinging outward.

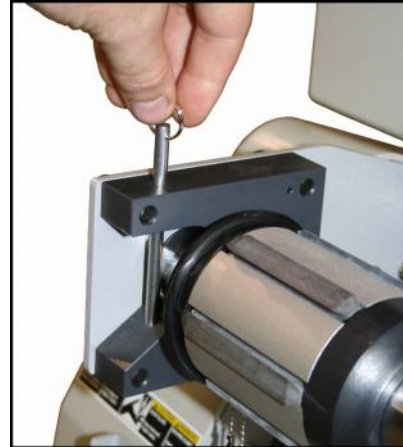

Swing the film shaft outward as is illustrated in the photo.



Loading Film Continued

The core chucks need to be adjusted to match the width of the film that is going to be loaded on the laminator. To do this, begin by removing the rubber o-rings.



Then use the included hex tool to loosen the setscrews in the core chucks. **Note: Do not remove the setscrews; they only need to be loosened.**

Make the necessary adjustments to the upper roll of laminate to center it to the Main Rollers.

Slide the Core Chucks into place and gently tighten the setscrews to secure the Core Chuck. The rubber O-Rings can be replaced to keep the film from moving off center.

Make the necessary adjustments to the lower roll of laminate to match up with the upper. Lock the Core Chucks into position and replace the O-Rings.



Select and Change the Nip

The Roller Handle raises and lowers the Main Rollers and Pull Rollers simultaneously. The Roller Handle Guide is notched with preset nip heights. The Roller Handle is located on the right side of the laminator.

Keep hands and fingers clear of the laminator roller nip when changing the gap. You can be crushed or burned.

Never leave the rollers in the down position without rotating. Prolonged contact in one area can form flat spots on the rollers.

To change the nip opening, pull the handle away from the notch and move to the desired setting and secure the handle in the appropriate notch.

Lift the handle to the top position to open the rollers.



In-Line Slitters

The **In-Line Slitters** allows the operator to slit the images as they pass through the Main Rollers and into the Pull Rollers. The trimmed waste can then be attached to the Rewinder Tubes and disposed of later.

To engage the **In-Line Slitters**, simply press the lever down to expose the blade. Keep hands and fingers away from the path of the **In-Line Slitters**. The blade is extremely sharp and can cut you.

To disengage the **In-Line Slitter** blade, simply push the blade lever up to return the blade to its original state.

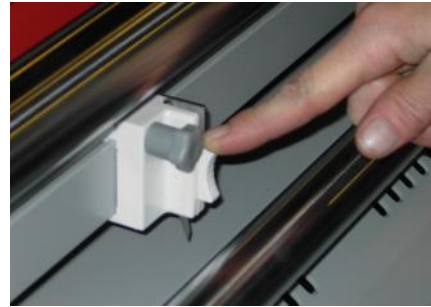

Rear Cut-Off Blade

The **Rear Cut-Off Blade** is intended to cut the web output from the laminator and should not be used for any other purposes.

Stop the laminator before using the **Rear Cut-Off Blade**. Moving material can damage the **Rear Cut-Off Blade**.

Keep hands and fingers away from the path of the **Rear Cut-Off Blade**. The blade is very sharp and can cut you.

Slide the rear Cut-Off Blade about six inches into the web. Press and hold down the blade engage lever. Slide the Rear Cut-Off Blade from one side to the opposite side then release.



Section 10: Applications

The 1244 WF & 1264 WF can accommodate Poly-in or Poly-out films. Poly-out means the adhesive is on the outside of the roll. Each film requires a slightly different loading procedure. Refer to the Webbing diagrams at the end of this section.

The shiny side of clear film must contact the heating components with the dull sides (adhesive side) facing out. Use caution when loading Matte or Delustered film since both sides appear dull.

The top and bottom rolls of laminating film must be of the same width and be present simultaneously.

Fig. 1A & B

Film Loading & Threading

The top and bottom rolls of laminating film must be of the same width and be present simultaneously. A Small amount of adhesive will “squeeze out” during Lamination. Hardened adhesive deposits can damage the heat rollers.

CAUTION:

Adhesive will deposit on the rollers if:

- Only one roll is used.
- Different widths of rolls are loaded together.
- Either roll is loaded adhesive side against a heat roller.
- One or both rolls of film are allowed to run completely off its core.

The adhesive side of the film is on the inner side of the web (Fig. 1A & B). The shiny side of clear film must contact the heat rollers. The dull side of the film contains the adhesive. Use extreme caution when loading delustered (matte) film as both sides appear dull.

Always change the top and bottom supply rolls at the same time. Near the end of each roll of GBC laminating film is a label stating “Warning-End of Roll”. The appearance of this label on either the top or bottom roll requires that new rolls of film be installed as soon as the item presently being laminated completely exits the rear of the laminator.

Do not introduce any additional items into the laminator when the warning label is visible.

To load a roll of film: (Fig.2)

1. Pull the swing out shaft clevis pin up.
2. Swing shaft outward.
3. Slide the roll of film onto the film shaft ensuring Adhesive side is out.
4. Push the film shaft back into the film shaft Support saddle.
5. Push the clevis pin down.
6. Center the roll of film.

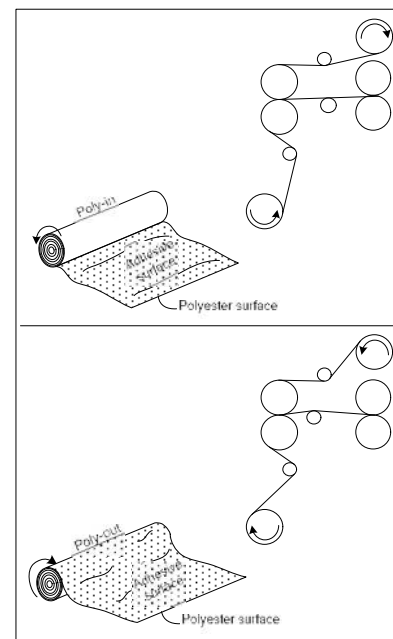
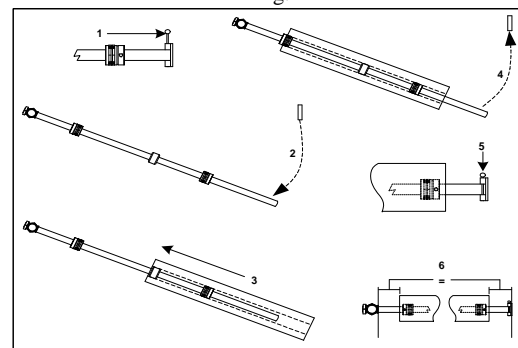

Fig. 2



Webbing Thermal Film Using Threading Card

CAUTION: The laminator rollers will be hot and can burn you. For pressure sensitive film (PSA), refer to the section titled

WEBBING: USING FILM THREADING CARD FOR PSA FILM.

1. Turn the Main Power ON /OFF to On.
2. Set top and bottom temperature with regards to the film type used.
3. Ensure no brake tension is applied to the film shafts.
4. Pull the top roll film down under the upper idler bar and allow to drape over the top heat roller (Fig. 3)
5. Pull the lower film behind the lower idler bar, Lower the table Pull Film up towards the film draped over the top heat roller and adhere the Lower Film to the upper Film (Fig. 4).
6. Pivot the table back to its feeding position while ensuring the threading card is on top of the feed table (Fig. 5).
7. Use a threading card to push the two materials into the heat roller nip.
8. Lower the main roller to initial contact with the threading card.
9. Ensure forward is selected for Motor direction and Press the Foot Switch
10. From the rear of the machine, guide the web over the chill idler, if installed, and through the pull rollers.
11. Once the web has entered the pull roller nip, lower the pull roller nip. Adjust unwind film tension; use as little tension as possible to get smooth output.
12. Once the threading card has completely exited the pull rollers, press the stop button.
13. Now refer to the section entitled START LAMINATING.

Fig.3

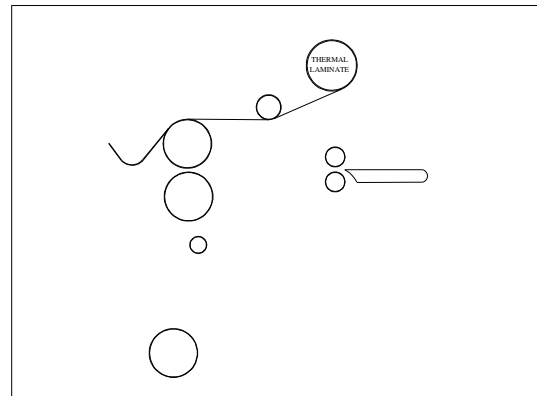

Fig. 4

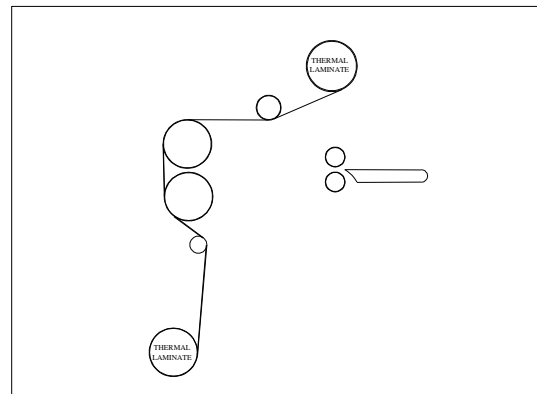
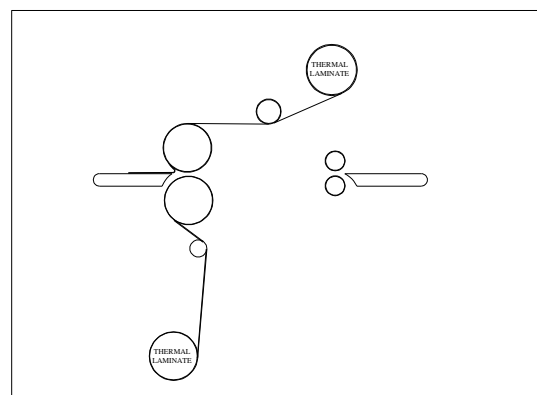

Fig. 5



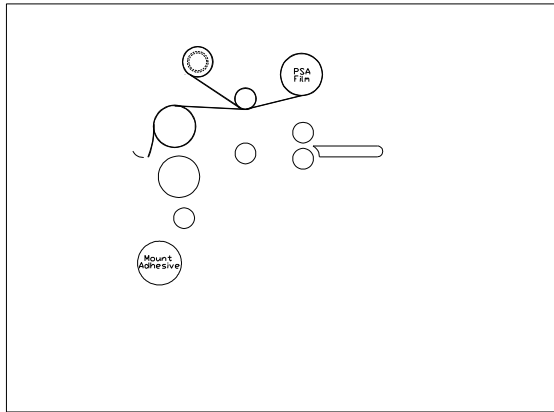

Fig. 6

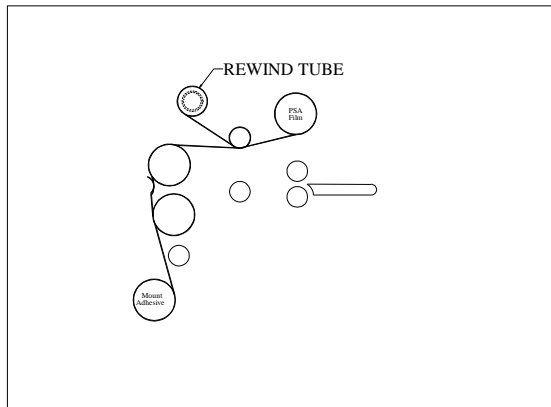

Fig. 7

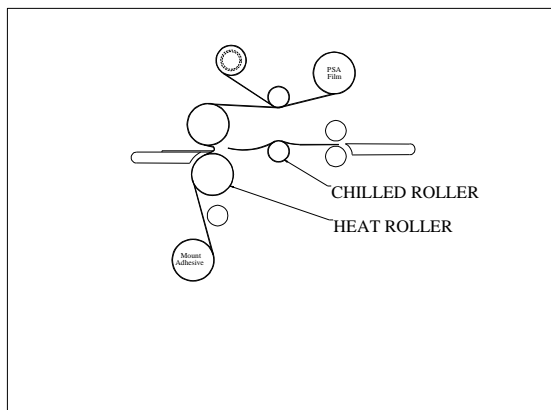

Fig.8

Webbing PSA Film/Mount Adhesive Using Threading Card

The laminator should be cool to the touch before Proceeding.

1. Turn the Power ON /OFF to On
2. Load the rolls of film as illustrated in (Fig. 6). Ensure no brake tension is applied to the film shafts.
3. Pull the top roll of film down under the idler bar and up to the upper front rewind tube.
4. Place one piece of masking tape in the center of the film and secure to the rewind tube.
5. Make two full wraps around the rewind tube, and then score the laminate without cutting the release liner. Pull the laminate down allowing it to drape over the upper roller (Fig. 6).
6. Pull the mount adhesive up towards the film draped over the upper heat roller (Fig.7).
7. Stick the mount adhesive to the exposed adhesive of the upper role.
8. Insert the table back to its feeding position while ensuring the threading card is on top of the feed table (Fig. 8).
9. Use a threading card to push the two materials through the heat roller nip
10. Lower the main heated roller to bring the main roller into initial contact with the threading card. Ensure front is selected and press the foot switch.
11. From the rear of the machine, guide the web over the chill idler, if installed, and through the pull rollers. Once the web has entered the pull roller nip, close the pull roller nip –
12. Press the stop button when the threading card has completely exited the pull rollers and adjusts the film web tension using as little tension as possible.
13. Now refer to the section titled START LAMINATING.

Start Laminating

1. At this point you should have your laminator Webbed with the appropriate material for your application.
2. The feed table should be in the normal operating position.
3. Close the main and Pull roll nips. Rollers should be closed.
4. Speed is set to 3 or less and front motor direction is selected.
5. Press the start button.
6. Set main roller pressure at desired setting for laminating by turning the roll lift handle.

CAUTION: If using PSA film, an air pocket may result between the main rollers and pull rollers. Raise the pull rollers to allow the air Pocket to pass.

7. Make any necessary film brake tension adjustments, pull/main roller pressure, and clutch and/ or rewind brake tension adjustments.
8. Position the item to be laminated on the feed table.
9. Align the leading edge of the item parallel to the heat roller nip (Fig. 9).
10. With both hands and an outward force push the image slower than the speed of the rollers into the nip of the heat rollers (Fig. 10).

CAUTION: Avoid forcing the image into the main roller nip as this action will cause the corners of the leading edge to buckle and create a wave.

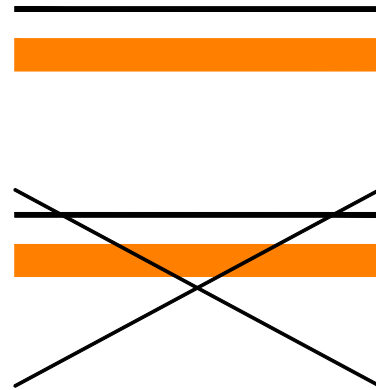

Fig. 9

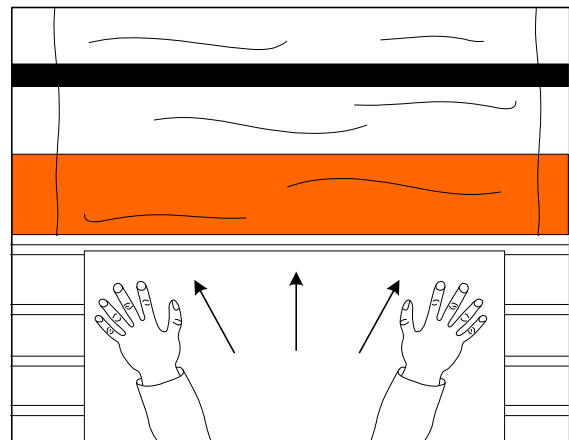

Fig. 10

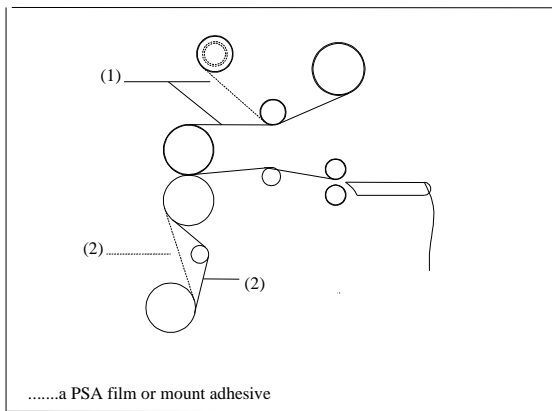

Fig. 11

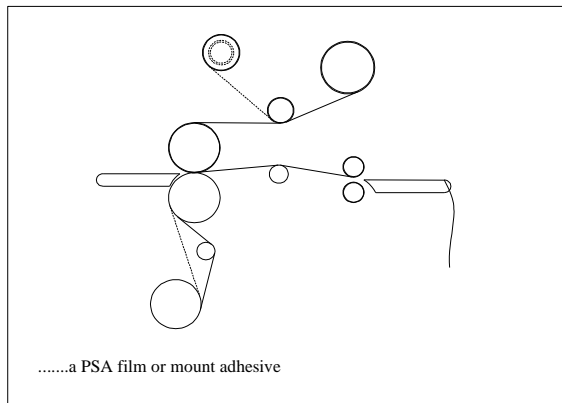

Fig.12

Method for Tacking New Film to Existing Film

The following describes a method for loading film whereby the existing film present on the heat rollers may be used in place of the threading card to draw the new film through the laminator. The adhesive of the existing film must be tacky or liquefied. Leading edges of the new film will be overlapped onto the tacky adhesive of the old film. The existing film and the new film will be pulled through the laminator together.

CAUTION: Do not cut yourself

CAUTION: Be careful not to cut any of the rollers!

1. Cut (1) remaining top film web between the idler bar and heat roller. Cut (2) the film web between the lower film supply and the idler bar (Figure 11).

CAUTION: Be careful not to cut any of the rollers!

2. Remove the feed table down.
3. Do not allow the adhesive side of the film to contact the heat or pull rollers. Liquefied or tacky adhesive deposited on heat rollers will require the rollers to be cleaned per the section tilted.
4. Replace both the top and bottom rolls of film with new rolls. Ensure the adhesive side is facing out.
5. Pull the film around the idler bars, with the exception of PSA mounting adhesives without a release liner.
6. Tack the new film to the existing film on the heat rollers. For PSA film, attach the release liner to the rewind tube
7. Use the footswitch to advance the film into the heat roller nip.
8. Observe the film being pulled through the laminator to assure that the remaining existing film and the new films are advancing concurrently. Any separation between the films will require stopping the motor immediately and the situation corrected.
9. Press STOP once the newly threaded film has completely exited the pull rollers.

To Unweb the laminator

Unweb the laminator if you are changing film widths, cleaning the rollers or have finished using the machine for the day.

CAUTION: Do not cut yourself

1. Using a slitter, cut (1) the output from the web (Fig. 13).
2. Cut (2) remaining top film web between the idler bar and heat roller. PSA film cut the release liner too.
3. Cut (3) the film web between the lower film supply and the idler bar (Fig. 13).

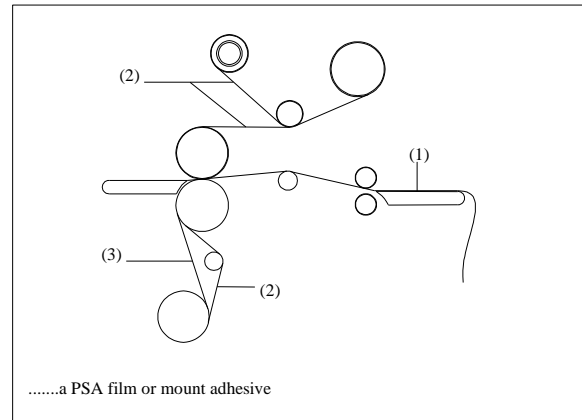

Fig. 13

CAUTION: Be careful not to cut any of the rollers!

4. Remove the feed table.
5. Gap the main rollers and pull rollers.
6. Carefully grab hold of the web (top and bottom film), from the back operating position and pull towards you (Fig. 14).
7. Do not allow the adhesive side of the film to contact the heat or pull rollers.

Clearing a Film Jam (Wrap-up)

Film jams (wrap-ups) may occur if the film is loaded backwards or if the area at which film exits the equipment is blocked. The film, when jammed, wraps around the heat rollers or pulls rollers during webbing if webbing, if a Thread Card is not used.

To clear a jam:

1. Immediately stop the laminator by pressing STOP.
2. Set motor direction to rear.
3. Use the footswitch to reverse the web until the wrap up is clear.
4. Raise the main roller and pull rollers.
5. Manually guide the web from the main rollers and pull rollers.
6. Once the film jam has been cleared, lower the main roller and pull rollers.
7. Refer to the section titled START LAMINATING.

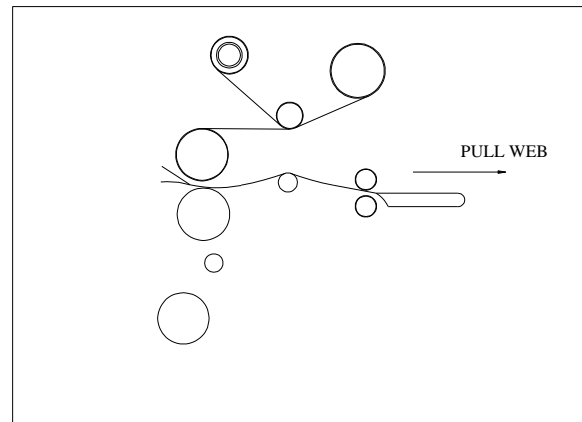

Fig.14

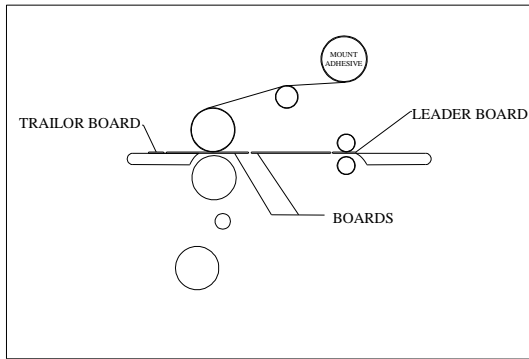

Fig. 15

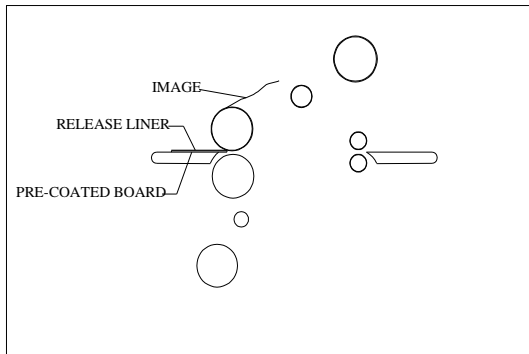

Fig. 16

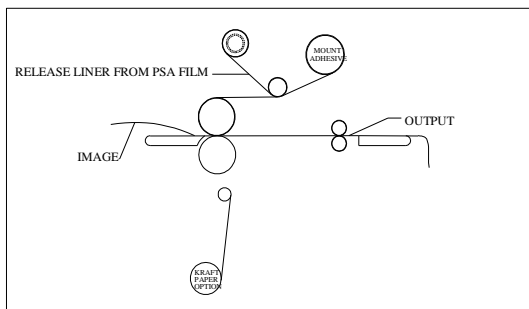

Fig. 17

Tips for Pre Coating Boards

1. Load the laminator as illustrated in (Fig. 15). Remove chill idler.
2. The width of the roll should not exceed the width of the board by more than 1/2 in. (1.3 cm).
3. Use a leader board to set the main roller and pull roller pressure prior to webbing.
4. Use a leader board to start the run and a trailer board to finish the run.
5. Using the pull rollers will allow you to leave gaps between boards.
6. If not using the pull rollers, have the boards nearby to butt end to end during feeding.

Tips for Mounting Pre Coated Boards

1. Use a leader board to set the main roller pressure prior to mounting the image.
2. Ensure the chill idler is removed and the rear slitter is to one side.
3. Do not stop once you have started the mounting process through the machine. (Fig. 16)

Note: This application can also be performed from the rear operating position.

Tips for Single Sided lamination

1. Load the laminator as illustrated in Fig. 17.
2. Use Kraft paper for one-sided lamination. When ever the items to be laminated are narrower than the film you are using.
3. If not using Kraft paper, use a scrap piece to finish the run or you will have adhesive on your rollers.
4. For high volume runs, use Kraft paper and the lower rear rewind for roll to roll operation.
5. Running the web over the chill idler may improve the Flatness of the output.
6. A little heat, 125 degree F (52 degree C), may help eliminate silvering effects associated with PSA films.

Tips for Creating a Decal

1. Load the laminator as illustrated in Fig. 18.
2. The over laminate may be PSA or thermal type.
3. If using thermal type, pay attention to the Poly-in/Poly-out rule.
4. Run a test material prior to running the actual image to ensure flat output.
5. Use minimal brake tension to achieve quality output.
6. Do not web the PSA mount adhesive around the lower web idler.

Tips for mounting a Decal

1. Use a leader board to set the pull roller pressure prior to mounting the image.
2. The image should not exceed the width of the board by more than 1 in. (2.54 cm) per side.
3. Tack about 1 in. (2.54 cm) of the leading edge of the decal to the leading edge of the board.
4. When tacking the leading edge, start in the center and work to the sides.
5. Use a board that exceeds the size of the decal if inexperienced in the mounting application.

Note: This application can also be performed from the front operating position.

Tips for Thermal Encapsulation

1. Load the laminator as illustrated in Fig. 20 Poly-in film is used for illustration purpose.
2. Refer to section entitled FILM LOADING & THREADING for Poly-out film.
3. Always use two rolls of film the same width.
4. Use minimal brake tension to achieve flat output.
5. Increase speed gradually to maintain the activating temperature required for the laminate you are using.
6. Length and width of image, ink coverage and paper type may affect the temperature and speed recommended in the SPEED/ TEMPERATURE GUIDE.

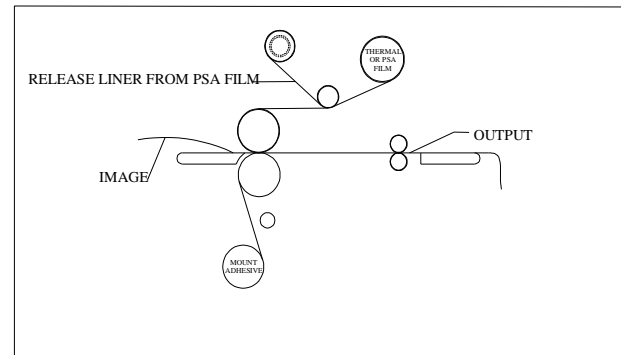

Fig. 18

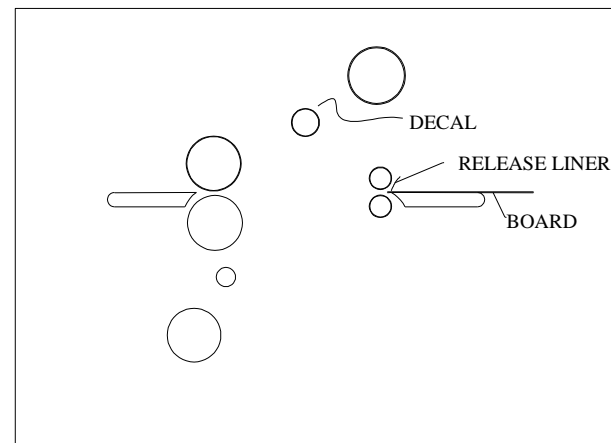

Fig. 19

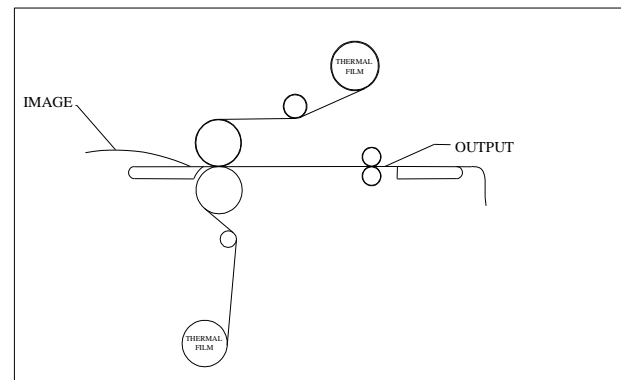

Fig. 20

SPEED / TEMPERATURE CONTROL

This is only a general reference guide. Different settings may be suitable as the warm up time, lamination time and materials change.

Factors that may affect the speed and temperature parameters;

1. Image length
2. Image width and ink coverage.
3. Ink coverage
4. Paper type
5. Laminate thickness
6. Operating environment
7. Condition of the rollers
8. Line voltage (effects heaters)
9. Using cooling features.

You may have to adjust temperature or speed depending on stock finish, thickness *Turn heat off when not in use.

THE ART OF LAMINATION**BASIC RULES**

- Do not attempt to laminate abrasive or metal Objects such as staples, paper clips and glitter, as they may damage the heat or pull rollers.
- Do not force items into the nip area of the heat rollers. An item that is not easily drawn into the laminator by the heat rollers is probably too thick to laminate.
- Wrinkles may result if an attempt is made to reposition an item once it has been grasped by the heat rollers.
- Do not stop the laminator before an item has completely exited the pull rollers. Even a momentary stop will cause a mark (heat line) on the laminated item.

Good, consistent lamination is a result of combining proper heat, tension and dwell time. Dwell time is controlled by the speed of the motor and is defined as the amount of time the material to be laminated is compressed between the heat rollers.

As a general rule, thicker items and film need to run at slower speeds because they extract more heat from the rollers at a quicker rate. Setting the speed control at slower settings gives the laminator longer dwell time thus allowing proper lamination of thick items. Thinner items, such as standard copier paper (20 lb. bond) and tissue paper, extract less heat from the rollers and can be run at faster speeds.

FILM TENSION

Proper film tension, known as brake tension, is the minimum amount required to eliminate wrinkles in the finished item. The film should be taut. A properly adjusted roll of film should not require excessive force to turn by hand.

Film tension should be enough to introduce a minor amount of drag as the film unrolls. Insufficient tension causes wrinkles, while too much tension causes stretching (necking). Uneven tensions between the top and bottom rolls create curl. Too much upper tension creates upward curl while too much bottom tension causes downward curl.

Adjustment of the pull roller clutch may be necessary if after adjusting unwind and rewind brake tensions do not improve your output quality.

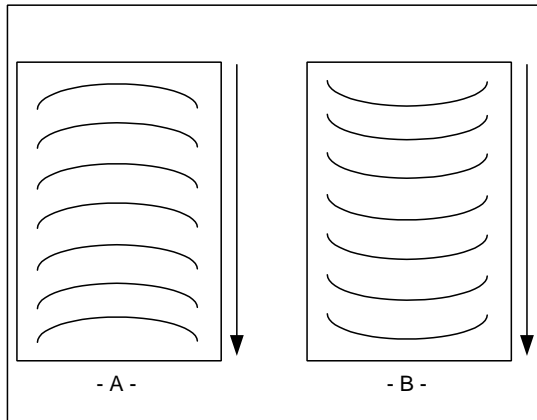

Fig. 24

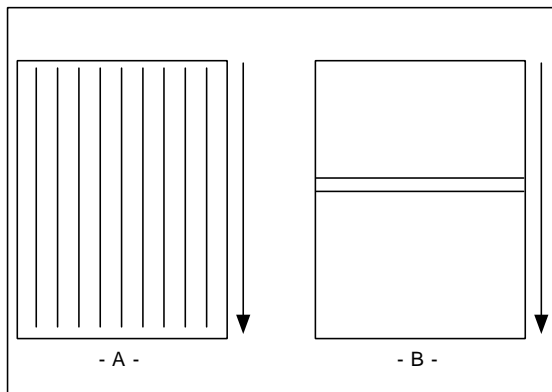

Fig. 25

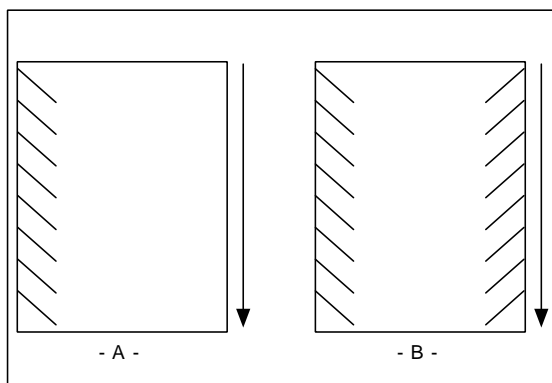

Fig. 26

Heat

The "READY" indicator may extinguish if the speed is set too fast for the material being laminated. Either lower the speed setting or press STOP and wait until the "READY" indicator illuminates. Operation of the laminator for more than thirty minutes at a time may necessitate a lower speed setting. It is recommended that, during periods of long runs, the items being laminated are alternated between thick and thin. Do not combine thick and thin items at the same time, as this will result in a poor edge seal around the thinner material. If you are unsure that the laminator is set at the proper speed for the item to be laminated, run a test piece (scrap) of the same or similar material through the Laminator. This procedure is recommended because rotating the heat roller prior to lamination will more evenly distribute the heat.

Make speed adjustments if necessary.

Output

1. "D" waves in the image (Fig. 24 A&B).
 - Check paper tension.
 - Paper may be damp or not dry.
2. "D" waves in the laminate (Fig. 24 A&B).
 - Check main roller pressure.
 - Check pull roller pressure.
3. Straight waves in output (Fig. 25 A).
 - Check operational settings for materials being used.
 - Check clutch tension.
4. Indent waves in output after pull rollers. (Fig. 25 B)
 - Insufficient cooling time.
 - Output was handled prior to cooling.
 - Use cooling feature if not on.
 - Machine was stopped on print.
5. Angled waves in the output. (Fig. 26 A&B)
 - Main air Supply setting
 - Check main Roller Pressure.
 - Check main roller pressure.
 - Check pull roller pressure.
 - Check for Paper Tension.

MAINTENANCE

Caring For the GBC 2064WF Laminator

GBC offers Cleaning kits as well as Extended Maintenance Agreements.

Contact your local GBC Service Representative or your dealer/distributor for additional information. The only maintenance required by the operator is to periodically clean the heat rollers and schedule semi annual maintenance checks. The following procedure will help keep the heat rollers free of adhesive that has been deposited along the edge of the laminating film. Proper alignment of the rolls of film reduces the amount of "squeeze out".



WARNING: Do not attempt to laminate adhesives marked "Flammable".
Do not laminate glitter and/ or metallic items. Damage to the rollers may result.



WARNING: Do not apply any cleaning fluids or solvents to the rollers. Some solvents and fluids could ignite on heated rollers.
Never clean rollers with sharp or pointed objects.
Hardened adhesive deposits on the rollers can cause damage to the rollers. Rotate the rollers at the lowest speed setting on the control panel.



CAUTION: THE FOLLOWING PROCEDURE IS PERFORMED WHILE THE LAMINATOR IS HOT. USE EXTREME CAUTION.

1. Remove the film from the laminator following the Procedure outlined in steps 1 through 6 of the section entitled TO UNWEB THE LAMINATOR.
2. Preheat the laminator until the "READY" indicator illuminates.
3. Tilt the feed table.
4. Rub the top and bottom heat rollers with a 3M™ Scotch-Brite™ pad. DO NOT USE METAL SCOURING PADS!
5. Use the footswitch to rotate the lower heat/ pull roller to an unclean portion. The upper heat/ pull rollers are free spinning. Continue this process until the complete surfaces of both rollers are clean.
6. Refer to the beginning of the section entitled OPERATING INSTRUCTIONS to web your laminator.

NOTE: Do not use metal scouring pads to clean the rollers.

TROUBLE SHOOTING GUIDE

SYMPTOM	POSSIBLE CAUSE	CORRECTIVE ACTION
The control panel display does not illuminate when POWER ON/OFF is in the ON, marked "I", position	Laminator not connected to electrical supply	Insert attachment plug into receptacle
	Blown out fuse.	Check fuses.
Heat rollers do not turn when I	Feed table not properly installed.	Tilt feed table and properly replace it.
Press the RUN button.	Pull E-Stop button	Pull out on the E-STOP push button.
Heat rollers only turn if I use the "Footswitch".	Photo eye is blocked.	Disengage the footswitch mode. Clear nip area.
Laminated items exhibit curling.	Tension between the top and bottom film. Roll is unequal.	Adjust tension per section FILM TENSION.
	Tension on top or bottom roll of film is too film is too loose.	Adjust tension per section FILM TENSION.
	Bottom film roll may be improperly loaded.	Make sure bottom roll of film is around idler bar and that is the normal operation position.
Adhesive deposited on heat rollers.	Top and bottom film webs not aligned	Release heat and pull roller pressure, align the rolls of film.
	Laminate improperly loaded.	Adhesive (matte) side of laminate film may be against the heat rollers. Unweb and reload the film properly.
Unsatisfactory adhesion of laminate.	Speed setting too fast for type of material being laminated	Lower speed setting.
	Insufficient heat	Wait for "READY" indicator to appear in the control panel display.
	Laminate improperly loaded	Adhesive side of film must be facing away from the heat rollers.
	Heat rollers require cleaning.	Bottom roll of film not threaded behind the idle bar.
	Laminated item unsuitable for adhesion.	Clean heat rollers per procedure in section CARING FOR THE GBC 3064 WF LAMINATOR. Item may be dirty or may have non porous surface that is extremely difficult to laminate.

SERVICE AGREEMENT

GBC's Equipment Maintenance Agreement will insure the quality performance and long life built into your laminator.

A service charge for travel time, labor and parts may be incurred for each out of warranty service call. GBC's Equipment Maintenance Agreement Decreases these expenses and protects your valuable investment. GBC offers several types of agreements to suit your needs and budget. To contact

GBC write to:

GBC NATIONAL SERVICE
ONE GBC PLAZA
NORTHBROOK, IL 60062 U.S.A.

IN CANADA: GBC NATIONAL SERVICE
49 RAILSIDE ROAD
DON MILLS, ONTARIO
M3A 1B3

General Binding Corporation
One GBC Plaza
Northbrook, IL 60062-4195
®

Free Manuals Download Website

<http://myh66.com>

<http://usermanuals.us>

<http://www.somanuals.com>

<http://www.4manuals.cc>

<http://www.manual-lib.com>

<http://www.404manual.com>

<http://www.luxmanual.com>

<http://aubethermostatmanual.com>

Golf course search by state

<http://golfingnear.com>

Email search by domain

<http://emailbydomain.com>

Auto manuals search

<http://auto.somanuals.com>

TV manuals search

<http://tv.somanuals.com>