

ORCA-IV Image Transfer Laminator Operation Manual

© 1998 GBC Pro-Tech
Do not duplicate without written permission

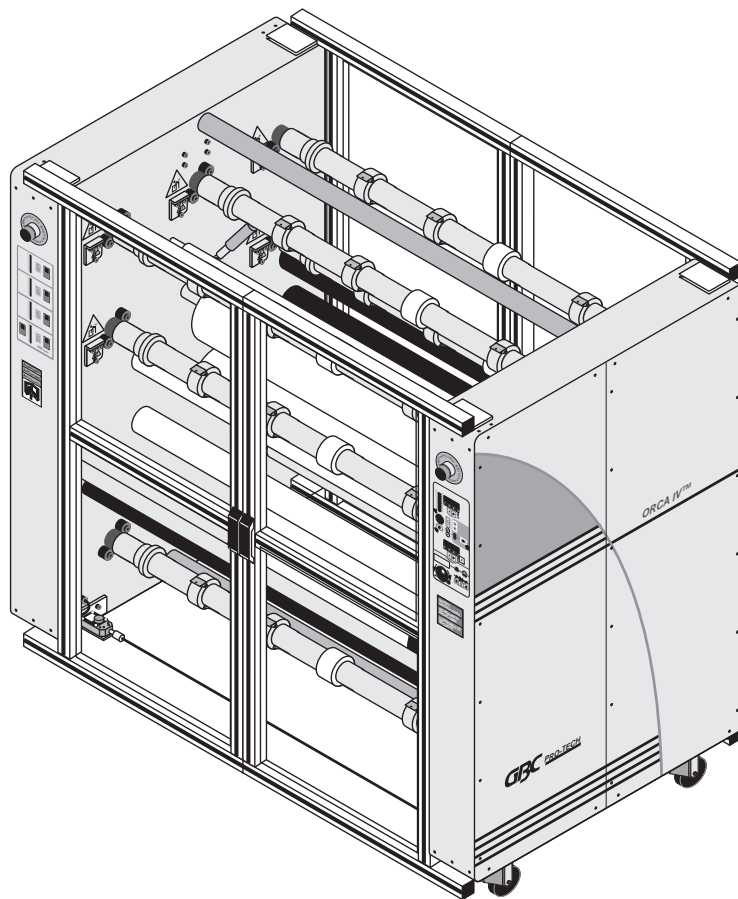

Part Number 930-009 Rev. A

GBC Pro-Tech
4151 Anderson Road
De Forest, Wisconsin 53532
Tel: 608-246-8844
Fax: 608-246-8645

The information in this publication is provided for reference and is believed to be accurate and complete. GBC Pro-Tech is not liable for errors in this publication or for incidental or consequential damage in connection with the furnishing or use of the information in this publication, including, but not limited to, any implied warranty of fitness or merchantability for any particular use.

GBC Pro-Tech reserves the right to make changes to this publication and to the products described in it without notice. All specifications and information concerning products are subject to change without notice.

Reference in this publication to information or products protected by copyright or patent does not convey any license under the rights of GBC Pro-Tech or others. GBC Pro-Tech assumes no liability arising from infringements of patents or any other rights of third parties.

This manual is copyrighted ©1998 by GBC Pro-Tech. All rights reserved. The information contained in this manual is proprietary and may not be reproduced, stored, transmitted, or transferred, in whole or in part, in any form without the prior and express written permission of GBC Pro-Tech.

Table of Contents

Section 1 : Safety	1-1
Caution/Warning Label Locations	1-5
Section 2 : Installation	2-1
Preinstallation Checklist.....	2-1
Unpacking.....	2-4
Setup	2-5
Leveling	2-5
Startup	2-6
Section 3 : Operation.....	3-1
Safety.....	3-1
Audible Signals	3-3
Operator Controls	3-4
Front Control Panel.....	3-4
Front Clutch/Brake Panel.....	3-6
Rear Control Panel	3-8
Rear Clutch/Brake Panel	3-10
Setup	3-11
Loading the Film	3-11
Heating	3-11
Recommended Materials.....	3-12
Films (Excluding Vinyl Transfer and Overlamination)	3-12
Vinyl Transfer and Overlamination Materials	3-12
Setting the Slitter	3-12
Paper Tips.....	3-12
Positioning the Film and Centering the Web	3-13
Film Spacing	3-14
Operational Tips and Tricks	3-14
Changing Film and Paper	3-14
Process Control Charts.....	3-15
Vinyl Transfer	3-15
Setup.....	3-15
Procedure	3-16
Machine Shutdown	3-16
Procedure	3-16

Section 4 : Maintenance and Troubleshooting4-1

- Cleaning 4-1
- Lubrication 4-3
- Adjusting the Kick Cable..... 4-3
- Contacting Technical Support..... 4-4
- Output Troubleshooting Guide..... 4-6

Section 5 : Warranty5-1

- Limited Warranty..... 5-1
- Exclusions to the Warranty 5-1

Section 6 : Specifications6-1

Section 7: Index..... 7-1

Section 1 : Safety

DO NOT ATTEMPT TO OPERATE YOUR ORCA-IV IMAGE TRANSFER LAMINATOR UNTIL YOU HAVE READ THIS SECTION CAREFULLY!

Your safety, as well as the safety of others, is important to GBC Pro-Tech. This section contains important safety information.

The following symbols are used throughout this manual to indicate warnings and cautions.



DANGER

Indicates an imminently hazardous situation which, if not avoided, will result in death or serious injury.



WARNING

Indicates a potentially hazardous situation which, if not avoided, could result in death or serious injury.



CAUTION

Indicates a potentially hazardous situation which, if not avoided, could result in minor or moderate injury, or alerts against unsafe practices, or alerts against actions which could damage the product.



IMPORTANT

Indicates important additional information.

The ORCA-IV Image Transfer Laminator has been designed with safety as a primary consideration. However, you must become thoroughly familiar with the controls, proper operation, proper service procedures, and safety features of the image transfer laminator before using or servicing the unit.

The GBC Pro-Tech ORCA-IV is a powerful machine that is designed for vinyl transfer and over-lamination. The forces required to accomplish these tasks are very large.

The air-cylinder system used to provide downward pressure on the top roll is capable of producing forces greater than 1000 pounds (454kg). This force is applied to any object presented in the opening (called the nip) between the two rolls.

Use care in lowering the top main roll and know how to react quickly in an emergency. The laminator roll **UP-DOWN** switch is located on the instrument panels. This switch controls the up and down motion of the top laminator roll. Before pressing this switch to the **DOWN** position, ensure that nothing is in the nip area. If any problem or danger should occur, depressing any of the emergency buttons stops the rolls from closing and raises them completely.

 **Note**

To quickly stop the machine in the event of an emergency, press any of the emergency stop buttons or apply force to either kick cable. This action stops the machine completely and raises the rolls.

In addition, the rolls of the ORCA-IV can reach temperatures of over 290 °F (143 °C). At these temperatures you can be burned if the rolls are touched during set-up, operation or servicing.

Opening any door of the image transfer laminator causes the rolls to slow to 3.0 ft/min (1 m/min).



WARNING

Do not ever attempt to override the safety system on the doors of the machine or the kick cables. You could get your fingers or arms between the rolls when they are turning or in the closed position and you could be crushed or severely burned.

The machine has a steel cabinet that is bolted closed to isolate the electrical and drive system components for the safety of the operator. Only a qualified service technician should open these cabinets.

The machine is equipped with four emergency stop buttons located on either side of the front and back of the image transfer laminator. Any of these, if engaged, stops the machine. To continue operation, all emergency stop buttons must be in the out position and you must perform the Machine Reset Procedure. See “Machine Reset Procedure” on page 1-3.

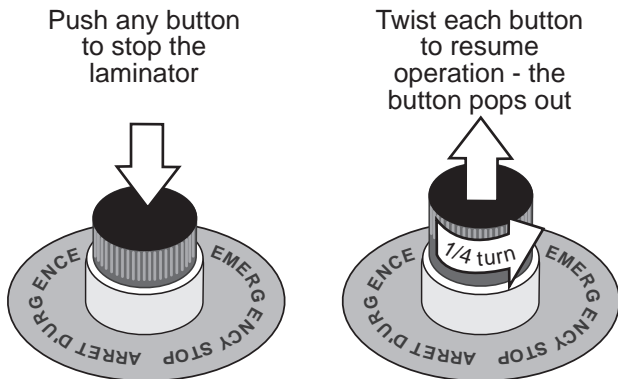

Figure 1-1: Using the Emergency Stop Buttons

In addition, the ORCA-IV is equipped with two emergency stop kick cables located at the lower front and back of the image transfer laminator.

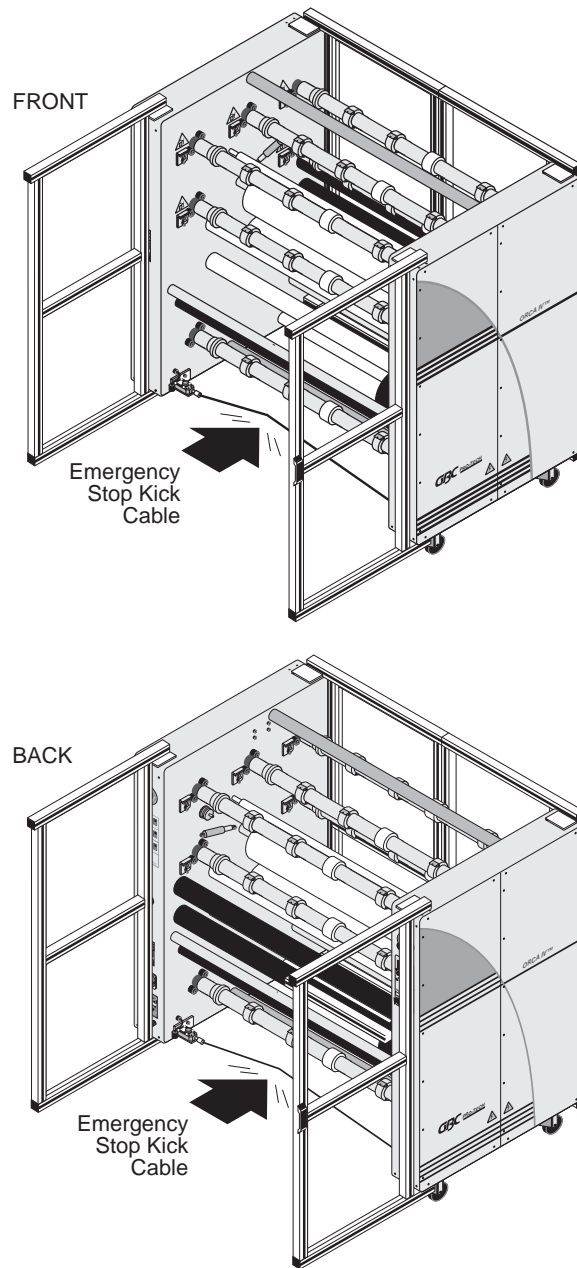

Figure 1-2: Using the Emergency Stop Kick Cables

Either of these, if stepped on or kicked, stops the laminator and raises the rolls. To continue operation, press the kick cable reset button. Then complete the Machine Reset Procedure. See “Machine Reset Procedure” on page 1-3.

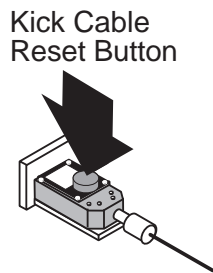

Figure 1-3: Kick Cable Reset Button

Machine Reset Procedure

Perform this procedure whenever an emergency stop button or kick cable is activated or when the power to the machine is turned on.

1. Make sure all emergency stop buttons and kick cables are reset.
2. Press the main machine reset button above the power switch on the back of the machine. See Figure 1-4: Machine Reset Button.
3. Check the web force settings to make sure they are what you require.
4. Turn the heater back on. It is necessary to restart the heater as all power is turned off when an emergency stop button or kick cable is activated.
5. Lock the shafts by closing the doors of the machine and pressing either the shaft locking switch or the FWD or REV arrow.
6. Start the motor and increase the speed.

Note

If the display does not have a decimal point in it, the machine needs to be reset.

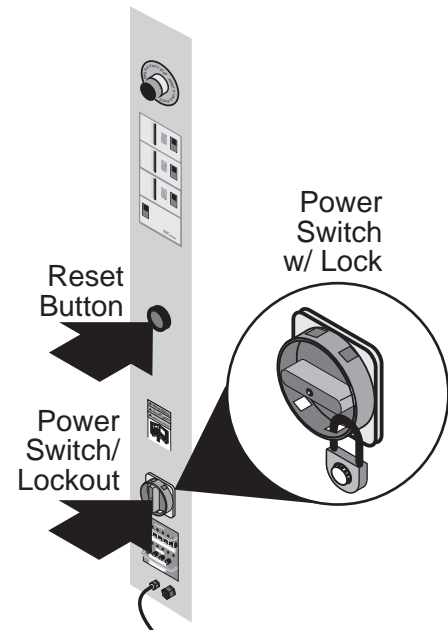

Figure 1-4: Machine Reset Button

Despite the safety features built into the ORCA-IV, extreme caution must be used when operating or servicing the unit. **READ THE FOLLOWING WARNINGS AND CAUTIONS BEFORE ATTEMPTING TO OPERATE OR SERVICE THE ORCA-IV IMAGE TRANSFER LAMINATOR.**



WARNING

Secure long hair so that it cannot get caught in the machinery. Do not wear ties, loose fitting clothing or dangling jewelry while cleaning or servicing the image transfer laminator. These items can get caught in the nip and choke you or you can be crushed or burned.



IMPORTANT

Use a lift to load and unload rolls larger than 50 yards. They can weigh up to 500 lbs and can crush you.

**IMPORTANT**

Do not operate the image transfer laminator near water. You can be severely shocked, electrocuted or cause a fire.

**IMPORTANT**

Raise the upper main roll when the image transfer laminator is not in operation. Prolonged contact can damage the rolls.

**DANGER**

Remove and lockout power from the image transfer laminator before servicing. You can be severely shocked, electrocuted or cause a fire.

**IMPORTANT**

Do not leave the top roll heater on with the roll raised. Heat builds up in a stationary roll and can damage it.

**IMPORTANT**

Do not use liquid or aerosol cleaners on the image transfer laminator. Do not spill liquid of any kind on the image transfer laminator. You can be severely shocked, electrocuted or cause a fire. Use only a damp cloth for cleaning.

**IMPORTANT**

Excess pressure can damage the rolls. Always select the minimum roll pressure necessary to complete the task.

**IMPORTANT**

Use only 80% (or stronger) isopropyl alcohol or a rubber cement eraser to clean the rolls. Harsh chemicals like toluene, acetone or MEK destroy the silicone covering of the rolls.

**IMPORTANT**

If silicone adhesive contacts the upper or lower roll, remove it **IMMEDIATELY** using 80 % isopropyl alcohol. It can harden within an hour and ruin the roll.

**IMPORTANT**

Exercise care when cleaning the rolls with 80% (or stronger) isopropyl alcohol:

- Use only in a well ventilated area.
 - Wear rubber gloves.
 - Use only on cool rolls.

Cleaning heated rolls can ignite the fumes.

**IMPORTANT**

The operating environment must be free of dust, flammable liquids and vapors. You can be injured by inhaling chemical vapors. Vapor build up or stored flammable liquids can cause a fire. Excessive dust can damage the image transfer laminator.

**IMPORTANT**

Do not use a knife or other sharp instrument during installation or while servicing the image transfer laminator. You can cause irreparable damage to the rolls.

**IMPORTANT**

Do not attempt to move the image transfer laminator across anything other than a flat, level surface without trained and qualified riggers. You can be crushed or seriously injured.

The ORCA-IV Image Transfer Laminator is a large and heavy piece of equipment. It is necessary to employ **LICENSED RIGGERS ONLY** to move the machine. The image transfer laminator is not designed to be tipped up or sideways in any way. Such action disturbs the exact alignment of the rolling parts of the machine and requires extensive realignment.

GBC Pro-Tech's warranty does not cover malfunction of the equipment due to mishandling and/or tipping.

GBC Pro-Tech bears no responsibility for personal injury or damage due to moving the image transfer laminator improperly.

**IMPORTANT**

Do not open the side covers of the machine. Only a qualified service technician should remove the covers. You can be severely shocked, electrocuted, or crushed.

**IMPORTANT**

Never operate the machine with side covers open. You can be severely shocked, electrocuted, or crushed.

ALWAYS USE GOOD SAFETY PRACTICES WHEN OPERATING OR SERVICING THE IMAGE TRANSFER LAMINATOR AND KNOW HOW TO REACT QUICKLY IN AN EMERGENCY.

Caution/Warning Label Locations

On your ORCA-IV Image Transfer Laminator are important safety labels. See *Figure 1-5: Locations of Safety Labels* for the location of these labels.

**WARNING**

Only a qualified electrician should connect power to the image transfer laminator. You can be severely shocked, electrocuted or cause a fire if power is improperly applied.

**IMPORTANT**

Do not operate the image transfer laminator if the power cord is damaged or frayed. You can be severely shocked, electrocuted or cause a fire. Contact a qualified electrician to replace the cord.

**IMPORTANT**

Do not allow anything to rest on the power cord. Do not locate the cord where people can walk on it. You or others can be severely shocked, electrocuted or cause a fire.

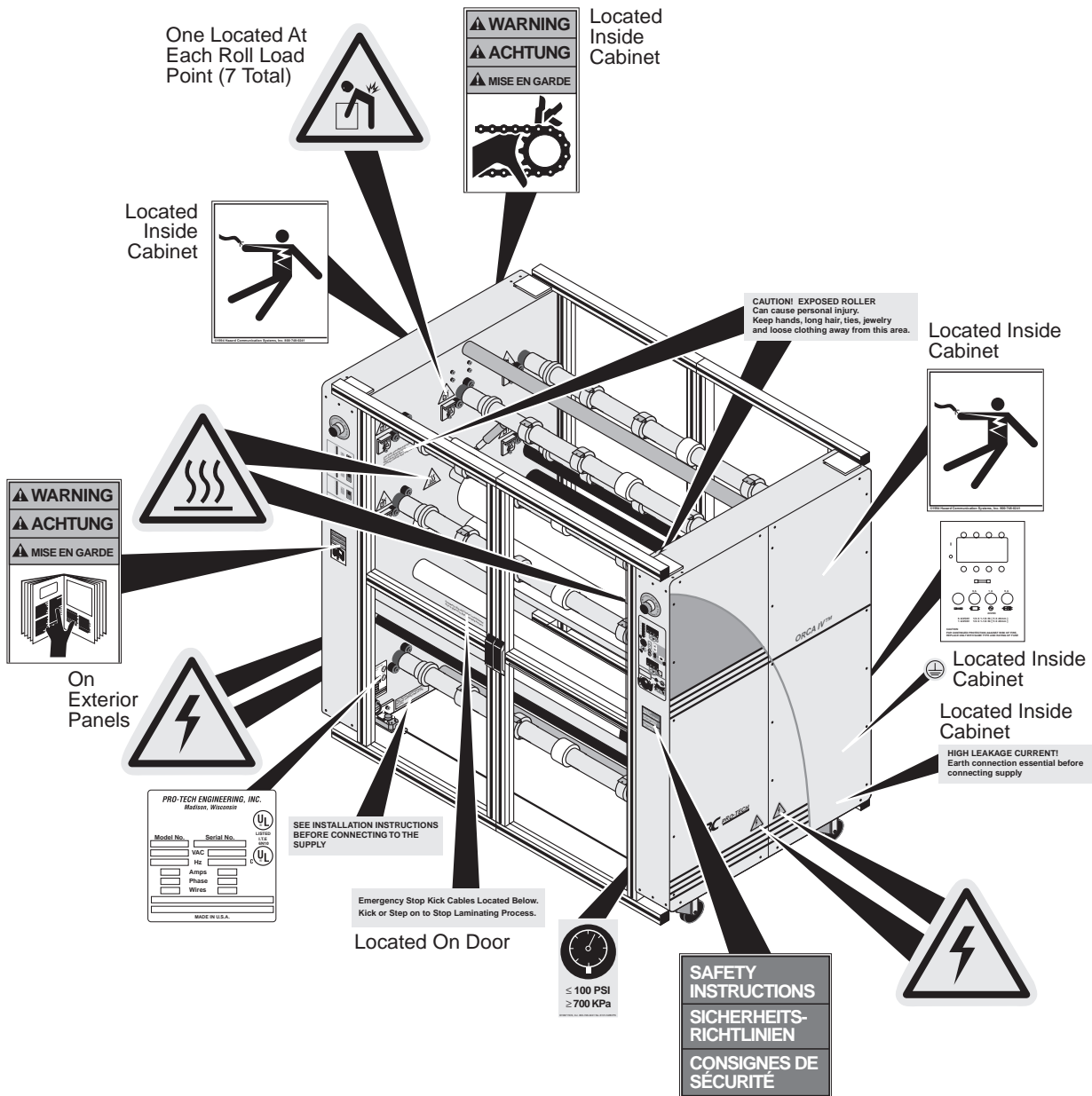

Figure 1-5: Locations of Safety Labels

The following are typical safety hazard decals used on GBC Pro-Tech machines, with a brief description (“Meaning” column) of each decal.

Decal	Meaning
	<p>WARNING!</p> <p>Moving parts can crush and cut.</p> <p>Do not operate with guard or door open.</p>
	<p>WARNING!</p> <p>Crush and burn hazard. Stay clear of moving rollers. Stop machine and raise roll before cleaning.</p>
	<p>WARNING!</p> <p>Carefully read Operator's Manual before handling this machine. Observe instructions and safety rules when operating.</p>
	<p>WARNING!</p> <p>HAZARDOUS VOLTAGE.</p> <p>To be serviced only by trained and authorized personnel.</p> <p>Lockout power before servicing.</p>
	<p>CAUTION!</p> <p>Surface is hot.</p> <p>A burn hazard exists.</p>
	<p>CAUTION!</p> <p>Rolls are heavy. Use proper lifting techniques to prevent injury.</p>
	<p>CAUTION!</p> <p>For continued protection against risk of fire, replace only with same type and rating of fuse.</p>
	<p>Machine identification label.</p>

Decal	Meaning
	<p>WARNING!</p> <ol style="list-style-type: none"> 1. Read and understand the Operation Manual and all safety labels before operating this machine. 2. Only a trained person is to be permitted to operate this machine. Training should include instruction in operation under normal conditions and emergency situations. 3. This machine is to be serviced only by trained and authorized personnel. Follow lockout procedures before servicing. 4. Never reach into the machine for any reason unless the machine is at a COMPLETE STOP. 5. Never leave the machine stopped in such a manner that another worker can start the machine while you are working on or within the machine. 6. Never change or defeat the function of electrical interlocks or other machine "shutdown" switches. 7. Before starting this machine, check that: <ul style="list-style-type: none"> - All persons are clear of the machine. - No maintenance work is being performed on the machine. - All guards are in place. - All parent rolls are well chucked in the unwind stands. - The machine is free of paper scraps, wraps and jams. 8. There is a potential hazard of entanglement in this machine caused by items such as long hair, loose clothing, and jewelry. Make sure your clothing and hair fit closely to your body and that all jewelry, rings and watches are removed.
	<p>CAUTION!</p> <p>Air pressure must be less than 100 PSI (700 kPa) to avoid damaging the machine.</p>
	<p>Reset.</p>
	<p>WARNING!</p> <p>EMERGENCY STOP BUTTON</p> <p>Press this button to stop the machine cycle, remove electric power, and separate (open) rolls to eliminate a pinch point (on some machines).</p>
	<p>Electric power disconnect and lock out location.</p>
	<p>CAUTION!</p> <p>EXPOSED ROLLER</p> <p>Can cause personal injury. Keep hands, long hair, ties, jewelry and loose clothing away from this area.</p>
	<p>Emergency Stop Kick Cables Located Below. Kick or Step on to Stop Laminating Process.</p>
	<p>SEE INSTALLATION INSTRUCTIONS BEFORE CONNECTING TO THE SUPPLY.</p>
	<p>HIGH LEAKAGE CURRENT!</p> <p>Earth connection essential before connecting supply.</p>
	<p>Earth ground.</p>

Blank page.

Section 2 : Installation

GBC Pro-Tech is committed to a program of ongoing product improvement. As a result, we are providing these instructions so that you can ensure that your new ORCA-IV Laminator is properly and securely unpacked, moved and installed.

Before an ORCA-IV Image Transfer Laminator can be installed there are a few requirements that must be met. Make certain that each of the requirements listed in the following preinstallation checklist are met before beginning installation.



IMPORTANT

Failure to follow the preinstallation checklist can result in damage to the image transfer laminator.

Preinstallation Checklist

- ❑ Are doorways and hallways wide enough for the image transfer laminator to be moved to the installation site?
- ❑ Is there ample room for the image transfer laminator?
A work area must be established that allows for operation in both the front and the rear of the machine and provides space for efficient material flow. See *Figure 2-6: Machine Space Requirements* for a typical machine area layout.
- ❑ Is the environment appropriate for the image transfer laminator?
The image transfer laminator requires a clean, dust and vapor free environment to operate properly, such as an air conditioned office area with forced 10% make up air. However, the image transfer laminator must not be located where there is air blowing directly on it. Major fluctuation in temperature and humidity are to be avoided.



IMPORTANT

The operating environment must be free of dust, flammable liquids and vapors. You can be injured by inhaling chemical vapors. Vapor build up or stored flammable liquids can cause a fire. Excessive dust can damage the image transfer laminator.



IMPORTANT

Do not locate the image transfer laminator where air is blowing directly on the machine. The air flow can cool the rolls unevenly and result in poor quality output.

- ❑ Have you contacted a certified electrician to both hard wire the laminator and ensure that an adequate power supply, having the appropriate capacity, overcurrent protection, and safety lockouts is available?
The laminator requires 4 wire North American Delta 230 VAC, 50/60 Hz, three phase, 45A per phase with the preheater option and 35A per phase without the preheater option.

Note

If you require setup for European power input (three phase wye), please contact GBC Technical Support.



CAUTION

Do not ever attempt to change the internal jumper configurations. Only a qualified GBC Service Technician can change these configurations. You can severely damage the machine.

- ❑ Is there an appropriate filtered dry air supply available?

The machine requires filtered dry air at 1.5 cubic feet per minute (cfm), 50 liters/minute at a pressure of 100 pounds per square inch (psi) (700 kPa). The air supply must be clean (free of dirt) and *dry*. Moisture causes corrosion and particles block pneumatic controls. Either problem can cause the laminator to malfunction.

It is the customer's responsibility to provide appropriate filters and water traps for the air hose before the air is routed to the laminator. Pro-Tech suggests that the best approach to the air requirement is to provide a dedicated small compressor for the laminator. A standard light-duty $\frac{1}{2}$ to $\frac{3}{4}$ horse power (1 kW) electric air compressor with 1.5 to 2.5 cfm output with a 5 gallon (20 liter) storage tank is appropriate.

**IMPORTANT**

The air supply to the laminator must be clean and dry or the machine will be damaged.

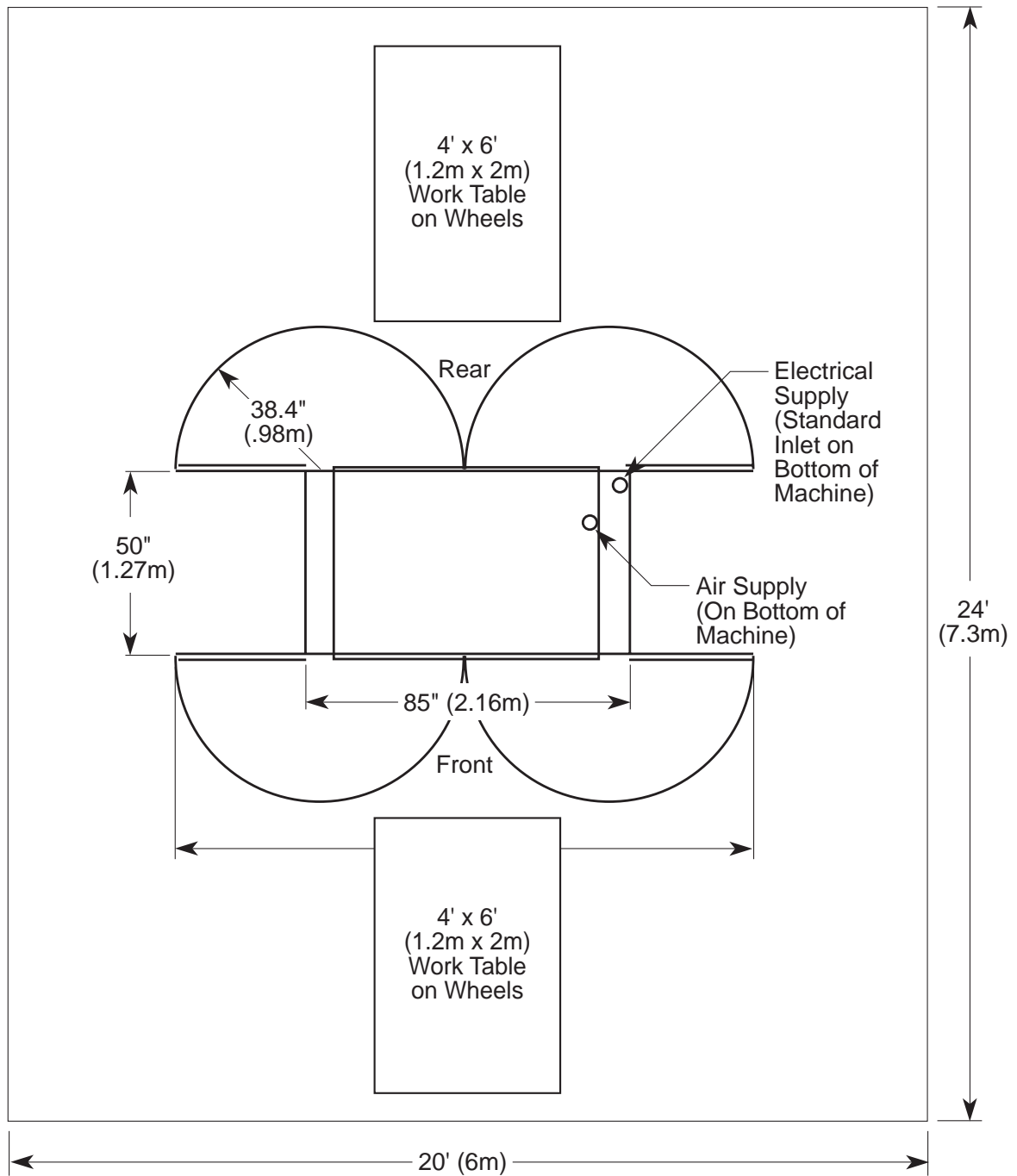

Figure 2-6: Machine Space Requirements

Unpacking

NOTE

ALL SHIPMENTS ARE EX- WORKS. At our dock title passes to the buyer Please review your insurance coverage prior to shipment, as you are responsible for all subsequent freight charges and risks. Before signing the Bill of Lading you should be sure to inspect the machine for signs of damage or missing items; if applicable, you should make a note of this on the Bill of Lading.

The ORCA-IV Image Transfer Laminator is shipped encased in shrink wrap via Air Ride Van.

To unpack the machine:

7. Have the image transfer laminator rolled off the Air Ride Van and placed on the floor by licensed riggers.



IMPORTANT

Do not attempt to move the image transfer laminator across anything other than a flat, level surface without trained and qualified riggers. You can be crushed or seriously injured.

The ORCA-IV Image Transfer Laminator is a large and heavy piece of equipment. It is necessary to employ LICENSED RIGGERS ONLY to move the machine. The image transfer laminator is not designed to be tipped up or sideways in any way. Such action disturbs the exact alignment of the rolling parts of the machine and requires extensive realignment.

GBC Pro-Tech's warranty does not cover malfunction of the equipment due to mishandling and/or tipping.

GBC Pro-Tech bears no responsibility for personal injury or damage due to moving the image transfer laminator improperly.

8. Gently unwrap the shrink wrap from around the image transfer laminator and remove the foam protecting the corners of the machine.



IMPORTANT

Do not use a knife or other sharp instrument during installation or while servicing the image transfer laminator. You can cause irreparable damage to the rolls.

9. Carefully remove any accessories packed with the machine. The accessory pack should contain:

- 1 Towel, white
- 1 Slitting knife
- 1 Set, hex wrenches
- 4 Leveling pads
- 3 Fuses (6A, 250V)
- 1 Tape measure
- 1 Rubber cement pick-up
- 1 Strain relief
- 1 Manual
- 4 Slitter Assemblies
- 2 T-handle wrenches ($\frac{1}{4}$ "
- 2 Web unwind spacers

10. Remove any plastic strapping and packing paper taped to the rolls.



IMPORTANT

Do not use a knife or other sharp instrument during installation or while servicing the image transfer laminator. You can cause irreparable damage to the rolls.

11. Remove all packing materials to a safe distance from the image transfer laminator.
12. Level the machine using the procedure included in this section.

NOTE

A word about international shipments: As these are heavy pieces of equipment, GBC Pro-Tech takes every precaution to ensure that our image transfer laminators are properly crated to the highest standards.

Before machines leave our loading dock, they are pre-treated with a VCI protective film to provide total corrosion protection. This protective film is wrapped around the machine and completely sealed. In addition, moisture absorbing silicone desiccant packs are packed inside the crate and machine cabinets.

Prior to start up of the machine, you must remove the desiccant packs from each cabinet and discard. DO NOT operate the machine with the desiccant packs inside the cabinets.

Setup

Once the ORCA-IV Image Transfer Laminator has been unpacked and moved into final position perform the following setup procedure.

Tools required:

- 1/8" hex wrench
- Adjustable wrench

Setup Procedure

1. Inspect the machine for any obvious shipping damage.
2. Remove the drive and control side cabinet covers with the 1/8" hex wrench by removing the screws securing the covers to the machine. Lift the covers off.
3. Inspect all the bolts and tighten any that were loosened during shipping.
4. Have a certified electrician wire the machine directly to a power source.
5. Connect the machine to the air supply.
6. Replace all cabinet covers.

Leveling**Tools required:**

- Adjustable wrench
- Carpenter's level (or equivalent)

To level the laminator:

1. Install the four level pads (included in the accessory pack) on the ends of the foot bolts.
2. Remove the rear idler so that you can place a carpenter's level across the pull roll to the bottom main roll.



Figure 2-7: Leveling Front to Rear

3. Level this side of the machine front to rear, raising or lowering the leveling pads by adjusting the nuts on the foot bolts.
4. Move the level to the other side of the machine and level front to rear.
5. Place the level directly on the chrome tie bar below the pull rolls and level the back of the machine side to side.



Figure 2-8: Leveling Side to Side

6. Place the level directly on the chrome tie bar in the front of the machine and level the front of the machine side to side.
7. Recheck the front to rear level condition to ensure that it has not changed. If it has, repeat the leveling procedure.
8. Remove the four metal casters after the machine is leveled (casters provided for transportation only).

Startup

The first time the image transfer laminator is started and every time it is serviced you should use the following checklist to confirm that the unit is operating properly and that all safety mechanisms are functioning.

Startup Checklist

Start the image transfer laminator and go through the following checklist.

- Are the emergency stop buttons working?
Push down on one of the emergency stop buttons. The image transfer laminator should stop immediately. Reset the button by turning it clockwise until it pops up. Press the reset button. See *Figure 1-4: Machine Reset Button* to locate the main machine reset button. Start the laminator. The machine should resume operation. Always check all four buttons.



IMPORTANT

Never operate the image transfer laminator unless all of the emergency stop buttons are functioning properly. You can be crushed or burned.

- Are the emergency stop kick cables working?
With the laminator running, step on or kick the front emergency stop kick cable. The rolls should stop turning and rise, if they are lowered. Reset the kick cable button. See *Figure 1-3: Kick Cable Reset Button* to locate the kick cable reset button. Then reset the main machine reset. See *Figure 1-4: Machine Reset Button* to locate the main machine reset button.



IMPORTANT

Never operate the image transfer laminator unless both of the emergency stop kick cables are functioning properly. You can be crushed or burned.

- Is the safety system on the doors functioning.
Open any door of the image transfer laminator. The rolls should slow to 3.0 ft/min (1 m/min) with the doors open. You should not be able to increase the speed of the machine above 3.0 ft/min (1 m/min).

 **Note**

The speed control works best with a slow, gradual increase or decrease of the speed control knob.



IMPORTANT

Never operate the image transfer laminator unless safety system on the doors is functioning properly. You can be crushed or burned.

- Is the motor functioning?
Test the motor at various speeds ranging from 0-19 ft/min (0-5.8 m/min). At 0 the rolls should stop turning.
Run the motor in both forward and reverse. In reverse you should hear a beep once a second to alert you that you are operating the machine in reverse.
- Are the heaters working?
Verify that the heater controller heats the top roll. (The bottom roll cannot be heated.)
- Is the temperature set correctly?
Check that the temperature is set to 290°F (143.3 °C) for most transfer processes.



IMPORTANT

Never allow any film, packing material, object, etc. to block the infrared temperature sensor. The sensor has a cone-shaped view of the roll that should never be obstructed. Severe roll damage can occur.



CAUTION

Never allow loose objects (pens, knife blades, jewelry, etc.) close to the machine or web paths. These objects can fall onto the web and can be carried through to the roll. Severe roll damage can occur.

Once you have completed the startup checklist you can safely run a test sample.

Blank page.

Section 3 : Operation

Safety

The ORCA-IV Image Transfer Laminator has been designed with safety as a primary consideration. However, you must become thoroughly familiar with the controls, proper operation, proper service procedures, and safety features of the image transfer laminator before using or servicing the unit.

The GBC Pro-Tech ORCA-IV is a powerful machine that is designed for vinyl transfer and over-lamination. The forces required to accomplish these tasks are very large.

The air-cylinder system used to provide downward pressure on the top roll is capable of producing forces greater than 1000 pounds (454kg). This force is applied to any object presented in the opening (called the nip) between the two rolls.

Use care in lowering the top main roll and know how to react quickly in an emergency. The laminator roll **UP-DOWN** switch is located on the instrument panels.

This switch controls the up and down motion of the top laminator roll. Before pressing this switch to the **DOWN** position, ensure that nothing is in the nip area. If any problem or danger should occur, depressing any of the emergency buttons stops the rolls from closing and raises them completely.

Note

To quickly stop the machine in the event of an emergency, press any of the emergency stop buttons or apply force to either kick cable. This action stops the machine completely and raises the rolls.

In addition, the rolls of the ORCA-IV can reach temperatures of over 290 °F (143 °C). At these temperatures there is a danger of a severe burn if the rolls are touched during set-up, operation or servicing.

Opening any door of the image transfer laminator causes the rolls to slow to 3.0 ft/min (1 m/min).



WARNING

Do not ever attempt to override the safety system on the doors of the machine or the kick cables. You could get your fingers or arms between the rolls when they are turning or in the closed position and you could be crushed or severely burned.

The machine has a steel cabinet that is bolted closed to isolate the electrical and drive system components for the safety of the operator. Only a qualified service technician should open these cabinets.

The machine is equipped with four emergency stop buttons located on either side of the front and back of the image transfer laminator. Any of these, if engaged, stops the machine. To continue operation, all emergency stop buttons must be in the up position and you must perform the Machine Reset Procedure. See “Machine Reset Procedure” on page 3-3.

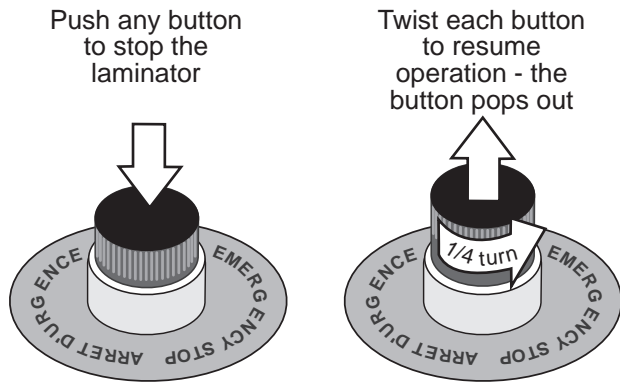

Figure 3-1: Using the Emergency Stop Buttons

In addition, the ORCA-IV is equipped with two emergency stop kick cables located at the lower front and back of the image transfer laminator.

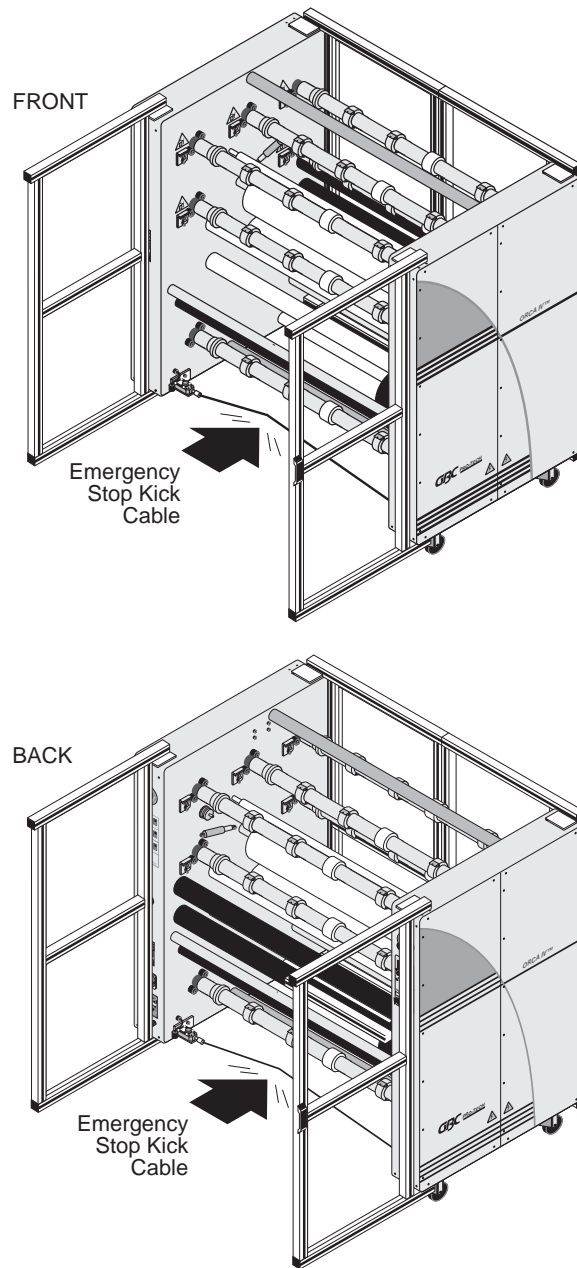

Figure 3-2: Using the Emergency Stop Kick Cables

Either of these, if stepped on or kicked, stops the laminator and raises the rolls. To continue operation, press the kick cable reset button. Then complete the Machine Reset Procedure. See “Machine Reset Procedure” on page 3-3.

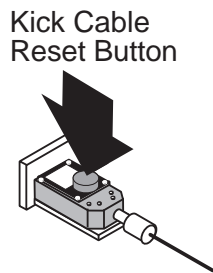

Figure 3-3: Kick Cable Reset Button

Machine Reset Procedure

Perform this procedure whenever an emergency stop button or kick cable is activated or when the power to the machine is turned on.

1. Make sure all emergency stop buttons and kick cables are reset.
2. Press the main machine reset button above the power switch on the back of the machine. See *Figure 3-4: Machine Reset Button*.
3. Check the web force settings to make sure they are what you require.
4. Restart the heater if it is being used.
5. Lock the shafts by closing the doors of the machine and pressing the shaft lock button or starting the motor.

6. Start the motor and increase the speed.

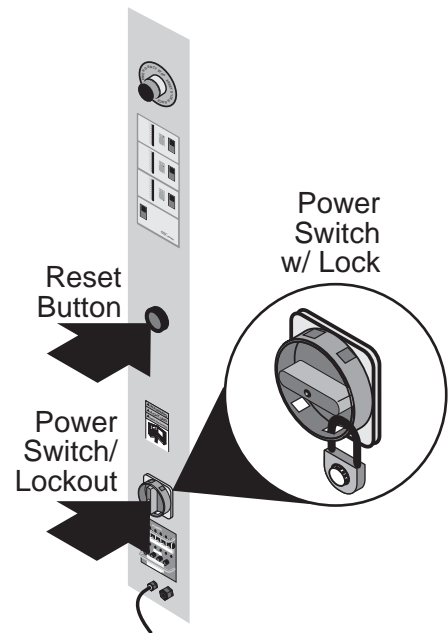

Figure 3-4: Machine Reset Button

Audible Signals

For your safety, the machine has several audible signals that are used to alert you to the status of the machine. The following table lists the alert signals.

Table 3-1: Audible Signals

Audible Signal	Meaning
Continuous rapid beep	If the roll is down but not turning, the machine will begin beeping continuously after 10 seconds.
Four beeps every 30 seconds after 55 minutes of inactivity	If the roll is up and the heater is on, the machine will begin beeping four times every 30 seconds after the machine has been inactive for 55 minutes.
One beep per second	The machine is in reverse.

Operator Controls

The operator controls for the ORCA-IV Image Transfer Laminator are located on the front and rear of the machine, to the right of the operator positions. The names and functions of these controls are as follows:

Front Control Panel

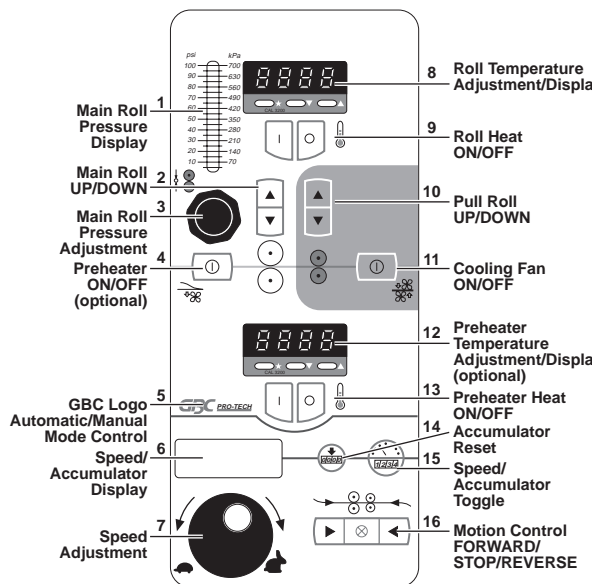

Figure 3-5: Front Control Panel

1. **MAIN ROLL PRESSURE DISPLAY** - Displays the air pressure pushing the upper main roll down.
2. **MAIN ROLL UP/DOWN** - Sets the upper main roll to the up (load) or down (operate) position.
3. **MAIN ROLL PRESSURE CONTROL** - Varies the air pressure fed to the cylinders that drive the upper main roll down.
4. **PREHEATER ON/OFF (optional)** - Turns on or off the preheater. The preheater mode is indicated by a **P** in the accumulator display.
5. **GBC LOGO AUTOMATIC/MANUAL MODE CONTROL** - Toggles between Automatic Tension and Manual Tension mode. In Automatic Tension mode, the system automatically adjusts the brake/clutch pressure. In Manual Tension mode the system doesn't automatically adjust these pressures (indicated by an **H** or **L** in the accumulator display). In the Automatic Tension mode with the motor stopped, setting a web force (tension) for

either a clutch or brake loads that force into the internal computer, which then automatically adjusts the air pressure sent to the clutch/brake to obtain the required web tension based on the roll size. When you enter the setting and then turn the motor on, the indicator changes from reading the web force to the actual pressure sent to the brake to attain the required web force calculated for that roll size. In Manual Tension mode the display reads actual pressure sent to the clutch/brake. This pressure stays set until you change it. The computer will not override your setting or change the display.

6. **SPEED/ACCUMULATOR DISPLAY** - Displays either the accumulator or speed, depending on which you have selected with the **SPEED/ACCUMULATOR TOGGLE**. A letter in the display before the speed readout indicates the mode of operation:

H - Manual mode with the preheater off.

P - Automatic mode with the preheater on.

L - Manual mode with the preheater on.

No letter - Automatic mode with the preheater off.

The following codes alert you to machine status:

.0 - The machine is reset and ready to be started.

8888 - Main power has just been turned on and the main reset has not yet been pressed.

*In addition to these codes, if an emergency stop button or kick cable is activated, the decimal point will no longer be displayed (for example, 3.0 would change to 3 0). Simply resetting the emergency stop button or kick cable does not change the display. You must also press the main machine reset button for display to read .0 indicating the machine is ready to be started. Note that you must reset the emergency stop button or kick cable **before** pressing the main machine reset or the machine will not be reset.*

7. **SPEED ADJUSTMENT** - Adjusts the speed of the machine from zero to maximum as the control is turned clockwise. Adjust the speed control slowly for best results.

8. **ROLL TEMPERATURE** - Provides a readout of the temperature of the upper main roll and the set-point for the desired temperature adjustment. Press the star button on the temperature controller to see or change the set point.
9. **ROLL HEAT ON/OFF** - Turns the heater controller for the top roll on or off.
10. **PULL ROLL UP/DOWN** - Sets the pull roll to the up (load) or down (operate) position.
11. **COOLING FAN ON/OFF** - Turns the cooling fan on or off. Push once to turn only the cooling idlers on, push again to turn only the cooling tubes on, push a third time to turn both cooling idlers and cooling tubes on, and push a fourth time for all cooling off.
12. **PREHEATER AIR TEMPERATURE (optional)** - Provides a readout of the temperature of the air inside the preheater and the set-point for the desired temperature.
13. **PREHEATER HEAT ON/OFF** - Turns the heater controller in the preheater roll on or off.
14. **ACCUMULATOR RESET** - Resets the accumulator.
15. **SPEED/ACCUMULATOR TOGGLE** - Toggles control between the speed and the accumulator.
16. **MOTION CONTROL FORWARD/STOP/REVERSE** - Controls the direction of the drive system, forward, reverse, or stop.

Front Clutch/Brake Panel

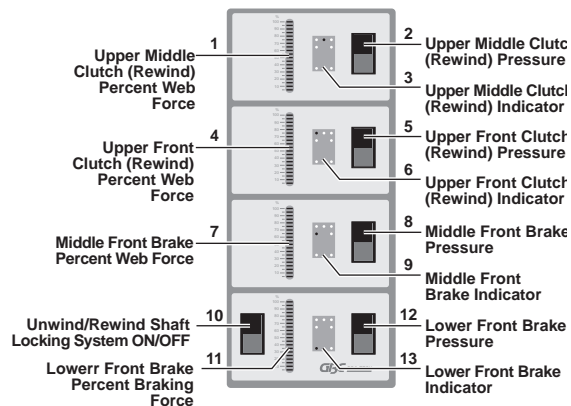

Figure 3-6: Front Brake Panel

1. **UPPER MIDDLE CLUTCH (REWIND) PERCENT WEB FORCE** - Indicates the web force (tension) for this clutch as a percentage of the total possible tension the clutch can exert. What the pressure indicator displays will change depending upon whether the motor is on or off and what mode you are operating the machine under. With the motor direction arrows off and the machine in Automatic Tension mode, the indicator displays the material web tension you set. Once the motor arrow is pressed and the machine starts, the computer calculates the appropriate pressure to attain the required web force based on the roll size. The indicator then changes to read the actual air pressure (in psi) sent to the clutch/brake. If the machine is in Manual Tension mode, the indicator reads the actual air pressure (in psi) sent to the clutch/brake.
2. **UPPER MIDDLE CLUTCH (REWIND) PRESSURE** - Adjusts the clutch pressure up or down.
3. **UPPER MIDDLE CLUTCH (REWIND) INDICATOR** - Indicates that this set of controls is for the upper middle clutch.
4. **UPPER FRONT CLUTCH (REWIND) PERCENT WEB FORCE** - Indicates the web force (tension) for this clutch as a percentage of the total possible tension the clutch can exert. What the pressure indicator displays changes depending upon whether the motor is on or off and what mode you are operating the machine under. With the motor direction arrows off and the machine in Automatic Tension mode, the indicator displays the material web tension you set. Once the motor arrow is pressed and the machine starts, the computer calculates the appropriate pressure to attain the required web force based on the roll size. The indicator then changes to read the actual air pressure (in psi) sent to the clutch/brake. If the machine is in Manual Tension mode, the indicator reads the actual air pressure (in psi) sent to the clutch/brake.
5. **UPPER FRONT CLUTCH (REWIND) PRESSURE** - Adjusts the clutch pressure up or down.
6. **UPPER FRONT CLUTCH (REWIND) INDICATOR** - Indicates that this set of controls is for the upper front clutch.
7. **MIDDLE FRONT BRAKE PERCENT WEB FORCE** - Indicates the web force (tension) for this brake as a percentage of the total possible tension the brake can exert. What the pressure indicator displays changes depending upon whether the motor is on or off and what mode you are operating the machine under. With the motor direction arrows off and the machine in Automatic Tension mode, the indicator displays the material web tension you set. Once the motor arrow is pressed and the machine starts, the computer calculates the appropriate pressure to attain the required web force based on the roll size. The indicator then changes to read the actual air pressure (in psi) sent to the clutch/brake. If the machine is in Manual Tension mode, the indicator reads the actual air pressure (in psi) sent to the clutch/brake.
8. **MIDDLE FRONT BRAKE PRESSURE** - Adjusts the brake pressure up or down.
9. **MIDDLE FRONT BRAKE INDICATOR** - Indicates that this set of controls is for the middle front brake.
10. **UNWIND/REWIND SHAFT LOCKING SYSTEM ON/OFF** - Engages/disengages the unwind/rewind shaft locking system. The switch disengages the locking system with the door either open or closed with the motor off. The doors must be shut to engage the system. If the doors are shut and the unwind/rewind shafts are disengaged, pushing the motion control engages them automatically. Note the color coding on each shaft and the shaft loading tray. Unwinds are marked with blue and rewinds are marked with red. Always use the correct shaft in each loading position.

11. **LOWER FRONT BRAKE PERCENT BRAKING FORCE** - Indicates the web force (tension) for this brake as a percentage of the total possible tension the brake can exert. What the pressure indicator displays changes depending upon whether the motor is on or off and what mode you are operating the machine under. With the motor direction arrows off and the machine in Automatic Tension mode, the indicator displays the material web tension you set. Once the motor arrow is pressed and the machine starts, the computer calculates the appropriate pressure to attain the required web force based on the roll size. The indicator then changes to read the actual air pressure (in psi) sent to the clutch/brake. If the machine is in Manual Tension mode, the indicator reads the actual air pressure (in psi) sent to the clutch/brake.
12. **LOWER FRONT BRAKE PRESSURE** - Adjusts the brake pressure up or down.
13. **LOWER FRONT BRAKE INDICATOR** - Indicates that this set of controls is for the lower front brake.

Rear Control Panel

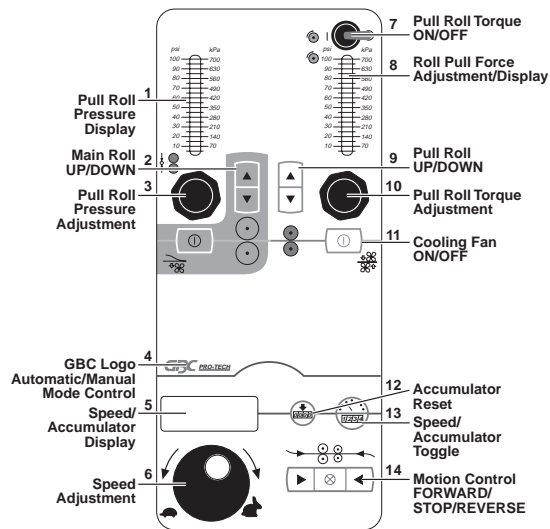

Figure 3-7: Rear Control Panel

1. **PULL ROLL PRESSURE DISPLAY** - Displays the air pressure pushing the upper pull roll down.
2. **MAIN ROLL UP/DOWN** - Sets the upper main roll to the up (load) or down (operate) position.
3. **PULL ROLL PRESSURE CONTROL** - Varies the air pressure fed to the cylinders that drive the upper pull roll down.
4. **GBC LOGO AUTOMATIC/MANUAL MODE CONTROL** -Toggles between Automatic Tension and Manual Tension mode. In Automatic Tension mode, the system automatically adjusts the brake/clutch pressure. In Manual Tension mode the system doesn't automatically adjust these pressures (indicated by an **H** or **L** in the accumulator display). In the Automatic Tension mode with the motor stopped, setting a web force (tension) for either a clutch or brake loads that force into the internal computer, which then automatically adjusts the air pressure sent to the clutch/brake to obtain the required web tension based on the roll size. When you enter the setting and then turn the motor on, the indicator changes from reading the web force to the actual pressure sent to the brake to attain the required web force calculated for that roll size. In Manual Tension mode the display reads actual pressure sent to the clutch/brake. This pressure stays set until you change it. The computer will not override your setting or change the display.
5. **SPEED/ACCUMULATOR DISPLAY** - Displays either the accumulator or speed, depending on which you have selected with the **SPEED/ACCUMULATOR TOGGLE**. A letter in the display before the speed readout indicates the mode of operation:
H - Manual mode with the preheater off.
P - Automatic mode with the preheater on.
L - Manual mode with the preheater on.
No letter - Automatic mode with the preheater off.
The following codes alert you to machine status:
.0 - The machine is reset and ready to be started.
8888 - Main power has just been turned on and the main reset has not yet been pressed.
*In addition to these codes, if an emergency stop button or kick cable is activated, the decimal point will no longer be displayed (for example, 3.0 would change to 3 0). Simply resetting the emergency stop button or kick cable does not change the display. You must also press the main machine reset button for display to read .0 indicating the machine is ready to be started. Note that you must reset the emergency stop button or kick cable **before** pressing the main machine reset or the machine will not be reset.*
6. **SPEED ADJUSTMENT** - Adjusts the speed of the machine from zero to maximum as the control is turned clockwise. Turn control knob slowly for best results.
7. **PULL ROLL TORQUE ON/OFF** - Allows you to turn the pull roll clutch (torque) pressure on or off without changing the pressure settings.
8. **PULL ROLL PULL FORCE DISPLAY** - Displays the air pressure of the clutch (torque or pull force).
9. **PULL ROLL UP/DOWN** - Sets the pull roll to the up (load) or down (operate) position.
10. **PULL ROLL TORQUE CONTROL** - Varies the air pressure fed to the clutch that drives the lower pull roll.
11. **COOLING FAN ON/OFF** - Turns the cooling fan on or off. Push once to turn only the cooling idlers on, push again to turn only the cooling tubes on, push a third time to turn both cooling idlers and cooling tubes on, and push a fourth time for all cooling off.

12. **ACCUMULATOR RESET** - Resets the accumulator.
13. **SPEED/ACCUMULATOR TOGGLE** - Toggles control between the speed and the accumulator.
14. **MOTION CONTROL FORWARD/STOP/REVERSE** - Controls the direction of the drive system, forward, reverse, or stop.

Rear Clutch/Brake Panel

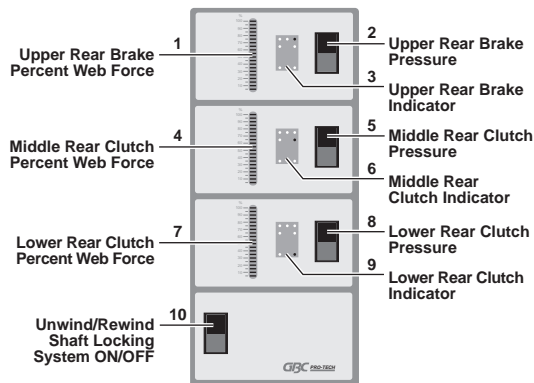

Figure 3-8: Rear Brake Panel

1. **UPPER REAR BRAKE PERCENT WEB FORCE** - Indicates the web force (tension) for this brake as a percentage of the total possible tension the brake can exert. What the pressure indicator displays changes depending upon whether the motor is on or off and what mode you are operating the machine under. With the motor direction arrows off and the machine in Automatic Tension mode, the indicator displays the material web tension you set. Once the motor arrow is pressed and the machine starts, the computer calculates the appropriate pressure to attain the required web force based on the roll size. The indicator then changes to read the actual air pressure (in psi) sent to the clutch/brake. If the machine is in Manual Tension mode, the indicator reads the actual air pressure (in psi) sent to the clutch/brake.
2. **UPPER REAR BRAKE PRESSURE** - Adjusts the brake pressure up or down.
3. **UPPER REAR BRAKE INDICATOR** - Indicates that this set of controls is for the upper rear brake.
4. **MIDDLE REAR CLUTCH PERCENT WEB FORCE** - Indicates the web force (tension) for this clutch as a percentage of the total possible tension the clutch can exert. What the pressure indicator displays changes depending upon whether the motor is on or off and what mode you are operating the machine under. With the motor direction arrows off and the machine in Automatic Tension mode, the indicator displays the material web tension you set. Once the motor arrow is pressed and the machine starts, the computer calculates the
5. **MIDDLE REAR CLUTCH PRESSURE** - Adjusts the clutch pressure up or down.
6. **MIDDLE REAR CLUTCH INDICATOR** - Indicates that this set of controls is for the middle rear clutch.
7. **LOWER REAR CLUTCH PERCENT WEB FORCE** - Indicates the web force (tension) for this clutch as a percentage of the total possible tension the clutch can exert. What the pressure indicator displays changes depending upon whether the motor is on or off and what mode you are operating the machine under. With the motor direction arrows off and the machine in Automatic Tension mode, the indicator displays the material web tension you set. Once the motor arrow is pressed and the machine starts, the computer calculates the appropriate pressure to attain the required web force based on the roll size. The indicator then changes to read the actual air pressure (in psi) sent to the clutch/brake. If the machine is in Manual Tension mode, the indicator reads the actual air pressure (in psi) sent to the clutch/brake.
8. **LOWER REAR CLUTCH PRESSURE** - Adjusts the clutch pressure up or down.
9. **LOWER REAR CLUTCH INDICATOR** - Indicates that this set of controls is for the lower rear clutch.
10. **UNWIND/REWIND SHAFT LOCKING SYSTEM ON/OFF** - Engages/disengages the unwind/rewind shaft locking system. The switch disengages the locking system with the door either open or closed with one motor off. The doors must be shut to engage the system. If the doors are shut and the unwind/rewind shafts are disengaged, pushing the motion control engages them automatically. Note the color coding on each shaft and the shaft loading tray. Unwinds are marked with blue and rewinds are marked with red. Always use the correct shaft in each loading position.

Setup

Setup of the ORCA-IV Image Transfer Laminator is quick and straightforward when instructions are followed exactly.

Loading the Film



IMPORTANT

Use a lift to load and unload rolls larger than 50 yards. They can weigh up to 500 lbs and can crush you.

Film is loaded on the appropriate unwinds indicated by color coding. Blue shafts and loading trays indicate unwinds, red shafts and loading trays indicate rewinds. The process of loading and aligning film is the same for both the top and the bottom unwinds/rewinds.

1. Be sure that rewind (clutch) shafts are in rewind positions (loading trays) and unwind (brake) shafts are in unwind positions so that the core gripping mechanism engages properly.
2. Slide the shaft over until the drive tang fits in the slot before engaging the unwind/rewind shaft locking system.
3. Loosen the lock collar with a 1/4" hex wrench and center the material before webbing the machine.

The film must be centered on the unwind for best performance. This is vital when two films are fed together. If the two films are not aligned, feed problems, wrinkles and other assorted troubles will occur. See Table 3-2 for centering and alignment information.



IMPORTANT

Carefully align the two films being fed into the nip. If not, you will obtain poor results.

Heating

Use the following instructions when heating the upper main roll.

1. Set the heater switch to **ON**.
2. Adjust the temperature controller for the desired operating temperature using the temperature controller set point adjustment. To adjust the set point, hold the star button down and press the up or down arrow on the temperature controller.
3. Allow the roll to come to temperature. After the roll has come up to set temperature, let the rolls run together for 5 minutes to produce even heat or you can also simply start the process a little slower and bring it up to speed as the roll reaches prime operating temperature.
4. The temperature controller has an LED (light emitting diode) readouts to indicate the status of the heating system.
5. It will take approximately 45 minutes for the upper main roll to reach operating temperature. When the preset operating temperature has been reached, the machine is ready to use.

Recommended Materials

Films (Excluding Vinyl Transfer and Overlamination)

The ORCA IV image transfer laminator is capable of processing a wide range of pressure sensitive and thermal laminates onto an equally wide range of image materials. The primary considerations are:

- Laminate adhesives are compatible with image materials.
- The materials properly activate below the maximum roll temperature and within the speed and roll nip pressure ranges available on the laminator.

It is the operator's responsibility to ensure the compatibility and operational settings for any laminates/image material combination. GBC Pro-Tech Technical Support is available at the number provided in the Maintenance chapter for advice on some material combinations.

Vinyl Transfer and Overlamination Materials

This machine is designed to do transfer using complete systems provided by companies such as GBC Pro-Tech, 3M, or Rexam. This system includes the paper, inks, vinyl and overlamine films specifically matched to offer excellent performance. Some vinyl materials offered by other companies will emit chemicals that will cause permanent damage to the rolls.



IMPORTANT

Substituting materials can cause severe damage to your machine and is not recommended or covered under our warranty.

It is the operator's responsibility to ensure compatibility and operational settings for the transfer process. Consult your transfer system supplier to ensure the correct combinations of materials are being used.

Setting the Slitter

1. Turn the thumbscrew on the slitter counterclockwise until it stops.



Figure 3-9: Slitter

2. Turn the thumbscrew one turn clockwise.
3. Set the slitter blade against the plastic covered black roll.
4. Engage the slitter against the tube by allowing the slitter to just touch the tube and then pressing it 1/16" further.

Note:

Setting the slitter to tight shortens the life of the blade and the plastic tube.

5. Pull the material through the machine to test the slitter. Adjust the thumbscrew to obtain the required results.

Paper Tips

- Always cut the leading edge of a print straight so it can be fed perpendicular to the rolls.
- The paper must be trimmed to match the width of the vinyl.
- The paper will wrinkle if it extends more than 1/2" beyond the vinyl edge.
- The trim can be neatly collected by threading it behind the imaged transfer media roll and taping it to the used transfer media core just to the outside of the trimmed transfer media. The diameter of the collected trim must be kept the same as the diameter of the winding transfer media to obtain a good quality windup.
- When trimming the final product, the trim can be wound on the same core just outside of the edge of the roll.

Positioning the Film and Centering the Web

Tools required:

- 1/4" T-handle wrench
- Tape measure

To load film:

1. Retract the shaft locking plungers and remove the shafts.
2. Slide the shaft into the new roll of material until the end plate is tight to the end of the material. Always leave the end plate on the drive side locked down. This insures that the material alignment will be the same from roll to roll. See the material size chart to determine what end plate setting to use for different width materials.
3. Make sure the end plates are tight to the edge of the material. If the core protrudes out more than 1/8", it will be necessary to use a plastic spacer to fill the gap. (Provided in the accessory pack.)
4. Place the roll of material on the machine. Be sure to line up with the drive tang and slide the shaft over to engage it into the drive tang. Make sure the shafts are slid over and engaged. This is critical to prevent the material from shifting after the machine is webbed.
5. Repeat steps 1 through 4 for the unwinds and rewinds.
6. When all the material is loaded on the unwinds and all the empty cores are loaded on the rewinds, close the doors and lock in the shafts.
7. Open the doors and verify that the paper edge matches the edge of the vinyl by measuring from the side plate to the edge of the rolls. If the paper or vinyl do not match up, loosen the end plates and adjust the material so they are exactly in line.
8. Web the vinyl as shown in the diagram and secure it to the finished product rewind. For best results, align one edge of the rewind core to match the material edge measurement on the unwind.
9. Web the transfer paper and tape it to the front rewind as shown in the diagram. If the paper is wider than the vinyl, it will be necessary to use the slitters to cut the paper down to match the width of the vinyl. See "Setting the Slitter" on page 3-12.

10. Load and web the overlaminates as indicated in the drawing. The operator has the option of lowering the pull roll now or waiting for the image to come through.
11. Check the web force for all the unwinds and rewinds and adjust as necessary.
12. Lower the main roll and start the motor. Start out at a low speed (2-3 ft/min (.6-.9 m/min)) and then increase the speed as needed after confirming that everything is working well.
13. Check for looseness at either edge of the paper just before it enters the nip. If a loose edge is detected, increase the brake 2-5 psi and, if the image is not yet into the nip, "pop" the roll up and back down quickly to help pull the web straight.

Note:

Initial looseness on the edge is common, It is caused by one of several things:

- *No tension on the initial web before the roll comes down.*
 - *Not webbed through perfectly straight.*
 - *Web expansion from the heat as that stays in the nip area as the machine is webbed.*
 - *The roll does not come down evenly.*
14. Close the doors and increase the speed as required.
 15. Observe the machine as it runs the material. Pay close attention to the web. Look for loose webs or spliced rolls and check the image quality.



IMPORTANT

When the process is complete, stop the machine and raise the roll. Do not let either paper or vinyl run through the nip alone. The vinyl could stick to the roll and the transfer paper would transfer to the bottom roll resulting in a large clean up job.

Film Spacing

Table 3-2: Film Spacing

Film Size	Distance From End of Shaft to Material Side Plate	Distance From Machine Side to Material Side Plate
54" (137.16 cm)	7-15/16" (20.16 cm)	7-1/2" (19.05 cm)
49" (124.46 cm)	10-7/16" (26.51 cm)	10" (25.40 cm)
48" (121.92 cm)	10-15/16" (27.78 cm)	10-1/2" (26.67 cm)

Note

Always set the drive side and keep it set as the base. When changing film, remove the end plate on the control side of the shaft. The new roll should then be pushed tight up to the plate on the drive side and the shaft should be slid over and engaged in the drive.

Operational Tips and Tricks

Suggested leaders:

- For vinyl: 65" (165.1 cm)
- For paper: 75" (190.5 cm)

To advance the paper without the vinyl:

You may want to advance the paper without the vinyl for several reasons:

- At the beginning of a new roll to clear the splice and reduce leader waste.
- To get past a large white spot, a known extra, or a bad image on a roll of images.

The key to advancing the paper without the vinyl is to raise the main roll but let the material continue to run through until the paper that is not stuck to the vinyl clears the paper peel idler. Then, put the machine in reverse briefly to release tension on the paper peel idler, or release the pull roll clutch and turn it back by hand. Lower the paper unwind and rewind tension and hand turn the paper roll so that the paper is advanced without the vinyl advancing.

To advance the vinyl without the paper:

Release all the tension on the transfer media web. Start the vinyl web. If the paper is not stuck to the vinyl, only the vinyl web will advance.

Changing Film and Paper

The recommended way to change over to new material is to splice the new material to the old and let the old material web pull the new material through the machine.

To splice vinyl:

When splicing the vinyl, stop the machine before the roll is totally used up.

1. Load a new roll of vinyl on the unwind shaft and place it on the machine. Engage the shaft into the drive tang.
2. The old material should be left long enough to lay over the new roll. This provides a straight, firm surface to splice onto.
3. Tape the new material to the old with a high quality 1-1/2" to 2" masking or vinyl tape. Make sure the materials are straight before applying the tape so that one side is not looser than the other.
4. Start the tape in the center and work outward.
5. Lower the brake tension until the splice has cleared the main roll.

Note

On machines without the preheater option it is possible to splice the two materials together using the bottom main roll as the firm, straight taping surface.

To splice paper:

Splicing paper is also the recommended way to change over to new material. The key to a successful splice is to leave enough of the old paper to be able to wrap it on the new roll and tape it on a square, firm surface.

1. Load the new roll of transfer paper on the machine.
2. Pull the old paper around the roll of images and tension and smooth out evenly.
3. Overlap the old paper with the new paper and tape securely. It is very important to have the new material over the old so that, when the paper is peeled off later, the new paper is lifted along with it and does not pull the tape off.

4. Tape starting in the center and move to the sides.
The tighter and smoother the tape job, the less web looseness that will have to be tensioned out later.
5. Decrease the brake tension until the splice passes through the nip. If slitters are being used, be sure that they have cut through the two layers of paper and the tape at the splice. It is best to run slow as the splice passes through the slitters and finish the cut, if necessary.

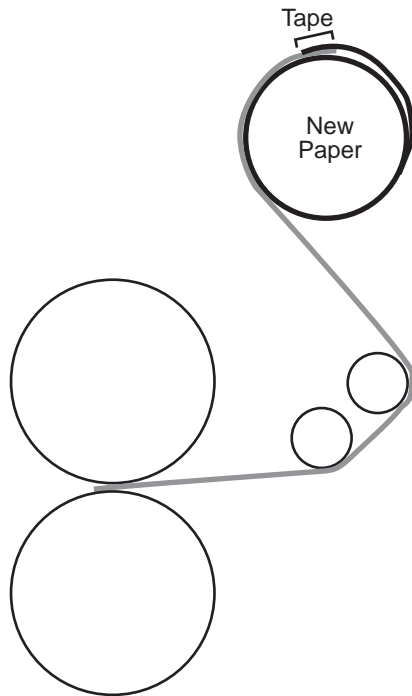

Figure 3-10: Splicing Paper

Process Control Charts

Process control charts allow you to record the way you thread film through the machine's rolls and idlers (called webbing) and the control settings for each product and process. Process control charts are an excellent tool for training new operators. They provide a "road map" for correct machine setup and operation.

This section contains a completed chart for the basic operation of the image transfer laminator.

GBC Pro-Tech image transfer laminators respond in a very accurate and repeatable manner. The chart provides a way to set up each time, every time for repeatable performance by assuring that all controls are set to optimum.

The process control chart should be kept in this manual or in a book close to the image transfer laminator.

NOTE

When trying new products and processes, remember that GBC Pro-Tech's customer service representatives are only a phone call away. In North America, call 1-608-246-8844 or fax 1-608-246-8645.

Vinyl Transfer

Setup

1. See process chart 3-1 and diagram 3-1a on page 3-17.
2. Set the controls as follows:
 - Main Roll Air Pressure: 100 psi (689 kPa).
 - Pull Roll Clutch Air Pressure: 35 psi (241 kPa).
 - Pull Roll Up/Down: Down
 - Pull Roll Air Pressure: 80 psi (552 kPa).
 - Speed Adjust: 1-10 fpm (.3-3.0 m/min).
 - Upper Heater Controller: 290 °F (143 °C).
 - Cooling: Idlers on, cooling tubes as needed

Procedure

1. See process chart 3-1 and diagram 3-1a for material mounting instructions and machine adjustments.
2. Web the vinyl up around the bottom main roll and over to the pull roll. Make sure the material is webbed straight and lower the pull roll to hold the vinyl.
3. Web the paper through as shown in diagram 3-1a.

Often, when paper is not on a core, hand tension must be applied to the paper in order to maintain transfer quality until the end of the transferred image.

Machine Shutdown

It is very important that the ORCA-IV Image Transfer Laminator is shut down in proper manner. If not, the rolls can be damaged or destroyed.

**IMPORTANT**

Failure to follow this procedure can result in damage to the rolls.

Procedure

1. Raise the upper main roll and upper pull roll so that the rolls do not make contact with the bottom rolls.
2. Turn off the main power to the machine.
3. Disconnect the air supply to the machine if the machine is not to be used for the next several days.

**IMPORTANT**

The main and pull rolls must always be in the up position when the machine is not in use.

PROCESS CONTROL CHART 3-1

WEB FORCE SUGGESTED VALUES			
Main Product Rewind (Finished Graphic)	20 WF	Transfer Media, 3M 8601i	15 WF
Marking Film (Vinyl) Like 3M (8620, 8640, etc.)	20 WF	Overlamine Unwind	50 WF
Used Transfer Media (Rewind)	20WF	Strip Release Liner (Laminate)	30 WF

IMAGE TRANSFER LAMINATOR SETTINGS			
Top Heater Status	290 °F (143 °C)	Pull Roll Position	Up or Down (optional unless applying laminate)
Speed	1-10 fpm (.3-3.0 m/min) max	Main Roll Setting	100 psi (689 kPa)
Drive Direction	Forward	Output Cooling	Idlers On, Cooling Tubes Optional
Drive Mode	Automatic or Manual		

PROCESS CONTROL DIAGRAM 3-1A

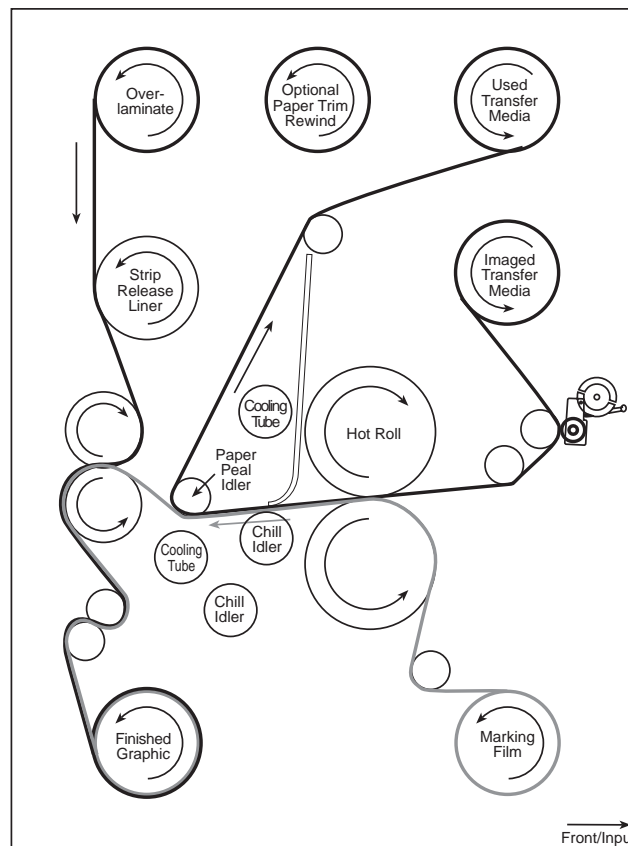

Notes

Blank page.

Section 4 : Maintenance and Troubleshooting

Performing regular maintenance on the ORCA-IV Image Transfer Laminator is critical to the proper operation of the machine. A maintenance schedule and a section of procedures for disassembling and reassembling the serviceable areas of the image transfer laminator are included in this section.

Table 4-3: Maintenance Schedule

Daily	<ul style="list-style-type: none"> • Clean the rolls and machine
Monthly	<ul style="list-style-type: none"> • Inspect the area around the image transfer laminator for possible hazards (dust buildup, combustible items stored too close, etc.) • Lubricate core end plate bolts • Inspect the roll lift mechanism
Every Six Months	<ul style="list-style-type: none"> • Check the chain tension and lubricate with heavy motor or gear oil. • Lubricate the grease fittings and chain • Lubricate slitter collar bolts • Lubricate the roll lift mechanism • Check wire termination tightness
Yearly	<ul style="list-style-type: none"> • Disassemble the roll lift mechanism and lubricate with lithium grease

Cleaning

Tools required:

- 80% isopropyl alcohol (or dishwashing detergent)
- Rubber cement eraser
- Several lint free paper or 100% cotton terry cloths
- Protective cotton gloves

To clean the image transfer laminator rolls:

1. Open the machine doors and gain access to the rolls.



IMPORTANT

Exercise extreme caution while cleaning the image transfer laminator. You can be caught in the turning rolls and crushed or burned.

2. While the image transfer laminator is at normal operating temperature, put on cotton gloves and, using a rubber cement eraser, remove any heat activated adhesive from the rolls.



IMPORTANT

If silicone adhesive contacts the upper or lower roll, remove it IMMEDIATELY using a rubber cement eraser. It can harden within an hour and ruin the roll.



IMPORTANT

Do NOT pick or pull heat activated adhesive off the rolls when they are cold. You can cause irreparable damage to the laminating rolls.



IMPORTANT

Do not use compressed air to clean the machine. Blowing debris can be forced into places where it will later ignite or short electric circuits.

To clean beads of adhesive, dust and dirt from the rolls:

1. Allow the image transfer laminator to cool slightly to no higher than 110°F (43°C).
2. Set the FWD/REV switch to the REV position and let the rolls move slowly as you clean them. Set the Speed Control to 1.5 ft/min.
3. Clean the rolls using a moderate amount of 80% isopropyl alcohol on a cotton terry cloth.

**IMPORTANT**

Use the minimum amount of pressure necessary to clean the rolls. You can destroy the silicone layer on the rolls by pressing too hard or scrubbing too long in one spot.

**IMPORTANT**

Exercise care when cleaning the rolls with 80% isopropyl alcohol:

- Use only in a well ventilated area.
 - Wear rubber gloves.
 - Use only on cool rolls.

Cleaning heated rolls can ignite the fumes.

**IMPORTANT**

Use only 80% isopropyl alcohol or a rubber cement eraser to clean the laminating rolls. Harsh chemicals like toluene, acetone or MEK destroy the silicone covering of the rolls.

To clean the cabinet and covers:

1. Using a damp cotton terry cloth (water only), clean the exterior of the image transfer laminator.

**WARNING**

Do not use liquid or aerosol cleaners on the image transfer laminator. Do not spill liquid of any kind on the image transfer laminator. You can be severely shocked, electrocuted or cause a fire. Use only a damp cloth for cleaning.

To clean the doors:

1. Using a cotton terry cloth, wash the doors using a mild soap or detergent and lukewarm water.

**IMPORTANT**

Do not scrub or use brushes or squeegees to clean the doors. You can scratch the surface.

2. Rinse thoroughly to prevent water spotting.
3. To remove grease, rub lightly with isopropyl alcohol, then wash and rinse.

Compatible Cleaning Agents:

- Fantastik¹
- Formula 409¹
- Hexcel, F.O. 554
- Joy²
- Lysol³
- Mr. Clean²
- Neleco-Placer
- PineSol⁴
- Top Job²
- Windex⁵

¹ Registered Trademark of the Clorox Company.

² Registered Trademarks of Procter & Gamble.

³ Registered Trademark of Sterling Drugs.

⁴ Registered Trademark of American Cyanamid.

⁵ Registered Trademark of the Drackett Products Company.

Lubrication

Tools required:

- 1/8" hex wrench
- High temperature grease or lithium grease
- Grease gun
- Heavy weight gear oil
- Soft cloth

To lubricate the image transfer laminator:



IMPORTANT

Do not lubricate the image transfer laminator when it is hot. You can be burned.



IMPORTANT

Unplug the image transfer laminator and lockout power while you are performing this procedure. You could be severely shocked, electrocuted, or get your fingers caught in the drive mechanisms.

1. Remove the drive side cabinet cover using the 1/8" hex wrench by removing the screws holding the cover in place.
2. Using the grease gun, lubricate each grease fitting (shown in Figure 4-1) with one squirt of high temperature grease.
3. Grease the main roll lift pins with high temperature grease (also shown in Figure 4-1).
4. Using heavy weight gear oil, lubricate the lift mechanism. On a yearly basis, disassemble and grease all the levers and pins on the lift mechanism.
5. Lubricate the chain using a soft cloth and gear oil.
6. Replace the cabinet covers and reconnect power to the image transfer laminator.

Note

Disassembly of the laminator should be performed by a qualified service technician.

Adjusting the Kick Cable

Occasionally, the kick cable needs adjustment to properly reset after use.

Tools required:

- Phillips head screwdriver

To adjust the kick cable:

1. Remove the kick cable cover by unscrewing the four screws and lifting the cover off.
2. Check the alignment of the internal mechanism. It should seat squarely against the metal pin.

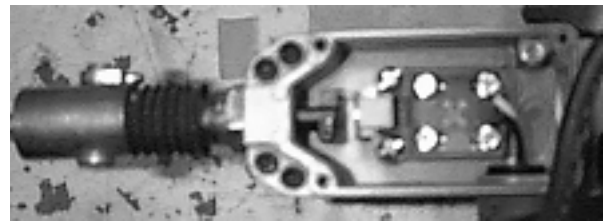

Figure 4-11: Kick Cable Incorrectly Set - Mechanism Is Not Square

Mechanism correctly seated against metal pin.

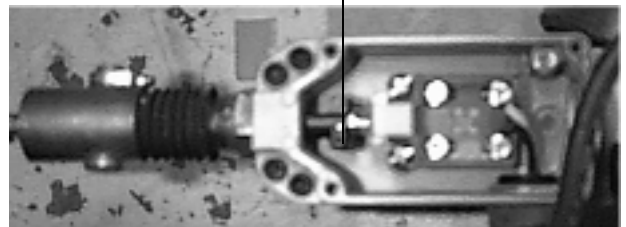

Figure 4-12: Kick Cable Tripped - Mechanism Correctly Seated

3. The bolts that hold the switch to the bracket are slotted and can be used to fine tune the switch adjustment. Loosen the bolts, tighten them until snug, make the necessary adjustments, then lock them down securely.

Contacting Technical Support

For machine parts and technical service in North America, please call: 1-608-246-8844 or fax 1-608-246-8645. **Please provide serial number when calling for service.** In Europe, please call: +44 (0) 1844 202 440 or fax: +44 (0) 1844 202 441.

For film and application questions in North America, please call 1-608-246-8844 or fax 1-608-246-8645. In Europe, please call: +44 (0) 1844 202 440 or fax: +44 (0) 1844 202 441.

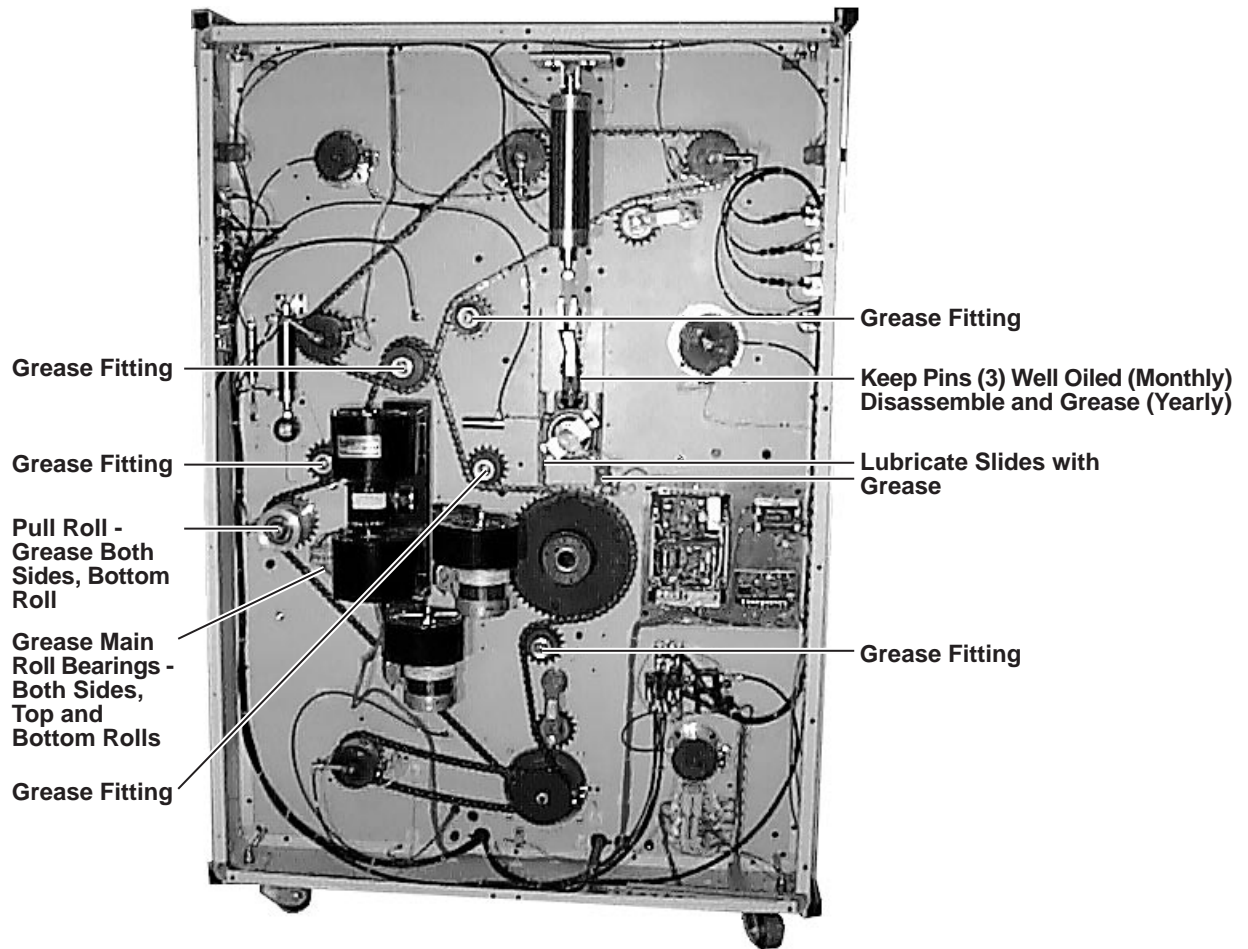
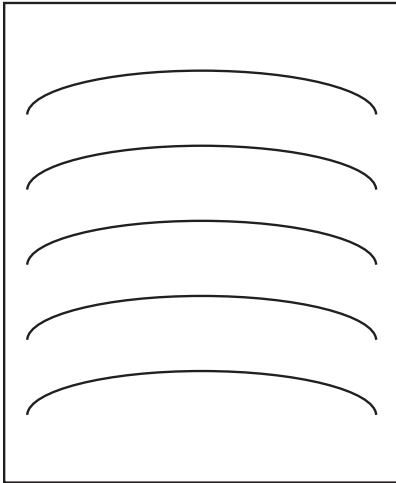

Figure 4-1: Grease Fittings

Output Troubleshooting Guide



Problem:
D waves in the image, not in the laminate.

- Hints:**
- Check paper tension.
 - Check relative moisture content of the paper.

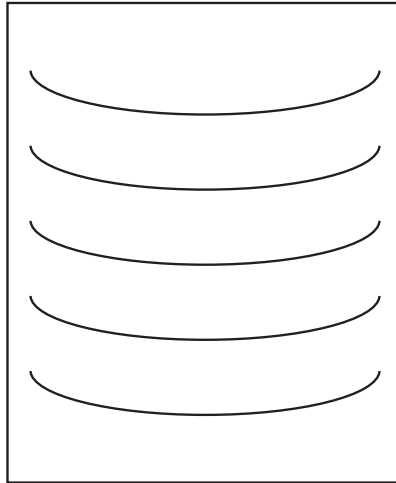

Problem:
D waves in the laminate.

- Hints:**
- Increase brake tension on laminate.
 - Check roll pressures.
 - Check nip settings.

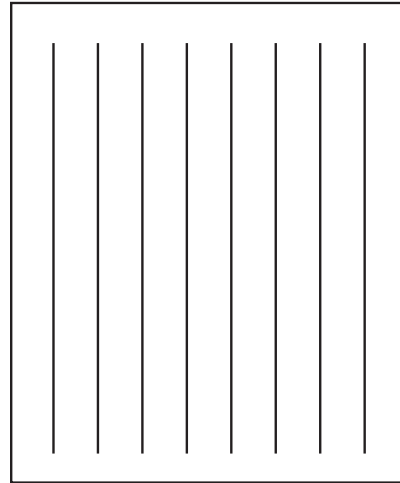

Problem:
Straight waves in the output.

- Hints:**
- Decrease clutch tension.
 - Check operational settings for materials being used.

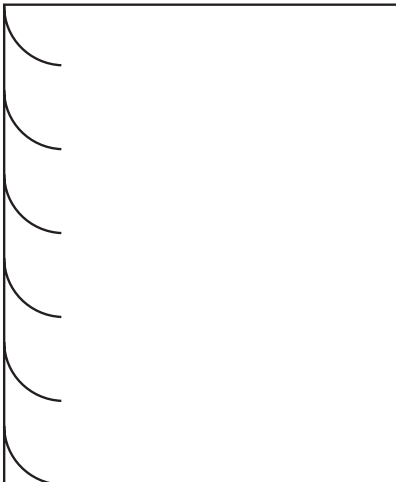

Problem:
Waves on only one side of the output.

- Hints:**
- Check nip settings.
 - Check for even paper tension.
 - Check for proper alignment on initial setup.

Feed Direction



Other Common Problems:

Problem:
Blistering in the image.

- Hints:**
- Increase speed or lower the operating temperature.

Problem:
Coiling of encapsulated images.

- Hints:**
- Balance the upper and lower unwind brake tension. Adjust cooling fans.

Problem:
Longitudinal waves or stuttering, jerking, or excessive noise from the drive side of the laminator.

- Hints:**
- Increase chain tension, decrease unwind brake tension.

Table 4-4: Machine Troubleshooting Guide

Problem Number	Problem	Possible Cause	Corrective Action
1	No display.	a. Is there power to the unit?	a. Check for power to the machine (building circuit breaker is on, main switch is on (I), and the machine circuit breaker is on (up)).
2	Display reads 8888.	a. Is the machine reset?	a. Make sure all safety buttons are released (out). Be sure all kick cables are reset and adjusted properly. Press the machine reset (above main switch). See "Machine Reset Procedure" on page 3-3.
3	Display reads .0 and the machine does not run.	a. Is the direction indicator (FWD/REV) pressed? b. Is the speed not turned up?	a. Press FWD or REV. b. Turn up the speed control.
4	Display missing the decimal point (e.g. -reads 30 instead of 3.0)	a. Is there a kick cable or safety button that has not been reset?	a. Make sure all safety buttons are released (out). Be sure all kick cables are reset and adjusted properly. Press the machine reset (above main switch). See "Machine Reset Procedure" on page 3-3.
5	Display missing the decimal point (e.g. -reads 30 instead of 3.0) but the kick cables and safety buttons have been checked and the reset button has been pushed.	a. Is the kick cable stretched out of adjustment?	a. Verify that the kick cable is truly resetting (listen, look). Adjust the kick cable. See "Adjusting the Kick Cable" on page 4-3.
6	Waiver on one side of paper/vinyl.	a. Is the tension too low? b. Does the roll lower unevenly? c. Was there a misalignment on set up? d. Is there a bad roll of material? e. Is the web loose only when first starting or splicing? f. Is there uneven nip pressure?	a. Increase appropriate brake tension. b. Adjust cylinder flow controls. c. Measure from the side frame to the edge of material in front and back to verify that the material is webbed through straight. d. Try a different roll. e. Raise and lower the roll (pop up and down) to pull the initial loose web straight and tight. f. Call Technical Support to disassemble and lubricate the cylinder lift linkage (qualified service technician required).

Problem Number	Problem	Possible Cause	Corrective Action
7	Rewound material not even on edge.	<ul style="list-style-type: none"> a. Was the initial material webbing straight? b. Is the roll telescoped? c. Is there excessive tension? d. Is it a poor roll of film (soft end)? 	<ul style="list-style-type: none"> a. Measure carefully from sideframe and straighten webbing. b. Use end plates on all unwinds. c. Lower the tension. d. Try a new roll.
8	Plastic slitter tube has developed a larger diameter where the round knives cut causing paper stress lines and paper tearing at peel idler.	<ul style="list-style-type: none"> a. Has the slitter idler increased in diameter at the point of contact with the blades? 	<ul style="list-style-type: none"> a. Sand and/or file down the higher spots in the plastic tube. b. Replace the slitter tube (note: use as little pressure on the slitter as possible to increase the life of the slitter tube).
9	Rewind is not turning	<ul style="list-style-type: none"> a. Is the rewind engaged in the drive? b. Is there air pressure? 	<ul style="list-style-type: none"> a. Line up the drive tang and side shafts over to the drive side to engage them. b. Check for appropriate main air supply or increase the air pressure to the rewind.
10	Laminate paper rewind will not turn and/or you cannot set the pressure.	<ul style="list-style-type: none"> a. Is the pull roll up? 	<ul style="list-style-type: none"> a. Lower the pull roll. The laminate paper rewind will not turn and the pressure will not increase until the pull roll is down. b. Stop the motor to allow the web force to be set.
11	Roll is overheating.	<ul style="list-style-type: none"> a. Is the IR sensor blocked? b. Is the IR sensor misaligned? c. Is there cool air blowing on the roll? d. Is there an electrical problem? 	<ul style="list-style-type: none"> a. Be sure nothing ever blocks the path of the IR sensor. b. Align the sensor. c. Direct the cool air away from the roll surface. d. Call Technical Support.

Problem Number	Problem	Possible Cause	Corrective Action
12	I pressed the motor forward button, but the rolls would not turn!	<ul style="list-style-type: none"> a. Has a speed setting been set? b. Are the doors closed and shafts locked in? c. Are the e-stop buttons pressed? Are the kick cables reset? d. Is there decimal on display? e. Check motor fuses on the back of machine. 	<ul style="list-style-type: none"> a. Press the FWD or REV arrow and turn the speed control up. b. Close the doors and lock in the unwind/rewind shafts. c. Make sure all safety buttons are released (out). Be sure all kick cables are reset and adjusted properly. Press the machine reset (above main switch). See "Machine Reset Procedure" on page 3-3. Verify that the kick cable is truly resetting (listen, look). Adjust the kick cable. See "Adjusting the Kick Cable" on page 3-3. d. Press the machine reset (above main switch). See "Machine Reset Procedure" on page 3-3. e. Remove fuses and replace, if necessary. Be sure to replace with the correct size fuses: two 6A fuses for the motor and one 1A fuse for the power supply.
13	I pressed the motor reverse button, but the rolls would not turn!	<ul style="list-style-type: none"> a. see problem 12 	<ul style="list-style-type: none"> a. See problem 12.
14	I pressed the main roll down push button, but the roll did not go down!	<ul style="list-style-type: none"> a. Is there air pressure to the machine? b. Is there at least 20 psi on the gauge? c. Are the e-stop push buttons pressed and the kick cables reset? d. Is the machine reset? 	<ul style="list-style-type: none"> a. Verify that the air supply is sufficient (≤ 100 psi). b. Turn up regulator for main roll pressure. c. See problem 12. d. See problem 12. e. Reset the machine. See "Machine Reset Procedure" on page 3-3.
15	I pressed the main roll up push button, but the rolls did not go up!	<ul style="list-style-type: none"> a. Is there air pressure to the machine? b. Is the machine reset? 	<ul style="list-style-type: none"> a. Verify that the air supply is sufficient (≤ 100 psi). b. Reset the machine. See "Machine Reset Procedure" on page 3-3.
16	I pressed the pull roll down push button, but the rolls did not go down!	<ul style="list-style-type: none"> a. Is there air pressure to the machine? b. Is there at least 20 psi on the gauge? c. Is the roll hook retracted? d. Are the e-stop push buttons pressed and the kick cables reset? e. Is the machine reset? 	<ul style="list-style-type: none"> a. Verify that the air supply is sufficient (≤ 100 psi). b. Increase the pull roll air pressure. c. Disconnect and reconnect air pressure to the machine and observe pull roll locking mechanism. d. See problem 12. e. Reset the machine. See "Machine Reset Procedure" on page 3-3.

Problem Number	Problem	Possible Cause	Corrective Action
17	I pressed the pull roll up push button, but the rolls did not go up!	a. Is there air pressure to the machine? b. Is the machine reset?	a. Verify that the air supply is sufficient (≤ 100 psi). b. Reset the machine. See "Machine Reset Procedure" on page 3-3.
18	I pressed the top roll temperature control "ON" push button and nothing happens.	a. Are the e-stop push buttons pressed and the kick cables reset? b. Is the machine reset? c. Is there a decimal point in the display?	a. See problem 12. b. Reset the machine. See "Machine Reset Procedure" on page 3-3. c. Reset the machine. See "Machine Reset Procedure" on page 3-3.
19	The display shows unusual numbers or characters.	a. Is the machine reset?	a. Reset the machine. See "Machine Reset Procedure" on page 3-3.
20	I press the preheater push button and a "P" is displayed on the control panel.	a. This is normal. This shows that you are in PREHEAT AUTO mode.	a. If you press the preheat button again, it will go off.
21	I pressed the cooling fan push button and the fan did not turn off.	a. Is the cooling fan toggle switch set correctly?	a. The cooling fan push button is a 4-way toggle switch, keep pushing the button until the fan goes off. From the off position, press once to turn only the cooling idler on, press twice to turn the cooling tubes only on, press a third time to turn on both the cooling idler and the cooling tubes, and press a fourth time to turn the cooling systems off.
22	I pressed the cooling fan push button and the fan did not turn ON.	a. Are the e-stop push buttons pressed and the kick cables reset? b. Is the machine reset?	a. See problem 12. b. Reset the machine. See "Machine Reset Procedure" on page 3-3.
23	I pushed the totalizer push button, the display changed to read 4 characters, but the value does not increase.	a. Is the proximity switch that reads the motor sensor teeth adjusted properly? b. Does the input light "X1" come on when the proximity switch comes on?	a. Make adjustment and try again. b. If the input light comes on, go to problem 48.
24	I pressed the totalizer-reset push button while in totalizer mode, and it did not reset and other buttons on the panel do not work either.	a. Is the machine reset?	a. Reset the machine. See "Machine Reset Procedure" on page 3-3.

Problem Number	Problem	Possible Cause	Corrective Action
25	I pressed the totalizer-reset push button while in totalizer mode, and it did not reset and other buttons on the panel do not work either, but the controls on the other panel work.	<ul style="list-style-type: none"> a. Is the machine reset? b. Is there a problem with the keypad? c. Is there a software problem? 	<ul style="list-style-type: none"> a. Reset the machine. See "Machine Reset Procedure" on page 3-3. b. Check/tighten the connector to the keypad. c. Call Technical Support.
26	My air supply is 100 psi, but my control panel reads less than 100 psi.	<ul style="list-style-type: none"> a. Has the display panel been calibrated? b. Is the pressure transducer faulty? 	<ul style="list-style-type: none"> a. Call Technical Support. b. Call Technical Support.
27	When I operate the machine in reverse, an alarm goes off.	<ul style="list-style-type: none"> a. This is a normal safety function. 	<ul style="list-style-type: none"> a. No corrective action necessary.
28	An alarm sounds rapidly after a 10 second delay.	<ul style="list-style-type: none"> a. Main rolls are down, and the rolls are not turning. 	<ul style="list-style-type: none"> a. Raise the rolls or run the machine at a slow speed to increase the life of the rolls.
29	After 55 minutes of no activity, a 4 beep alarm sounds, followed by a 30 second delay	<ul style="list-style-type: none"> a. The main roll is in the up position and the temperature controller is on. 	<ul style="list-style-type: none"> a. If you're not using the machine, turn the temperature controller off, or lower the roll and run the machine at a slow speed. Failure to do this will reduce the life of your rolls and may cause permanent damage.
30	The alarm does not come on for the conditions outlined above.	<ul style="list-style-type: none"> a. Is there a technical problem with the alarm? 	<ul style="list-style-type: none"> a. Contact Technical Support.
31	When the rolls are stopped, I pressed the switch to adjust the pressure to the brakes or clutches, and nothing happened.	<ul style="list-style-type: none"> a. Are the e-stop push buttons pressed and the kick cables reset? b. Is the machine reset? 	<ul style="list-style-type: none"> a. See problem 12. b. Reset the machine. See "Machine Reset Procedure" on page 3-3.
32	When the rolls are moving, I pressed the switches to adjust the pressure to the brakes and clutches, and nothing happens.	<ul style="list-style-type: none"> a. This may be normal. When the machine is running the computer takes over the settings and adjusts the pressure to the brakes and clutches. The change that you attempted to make may have been too small to see on the gauge as a percent allowable pressure for that size roll. 	<ul style="list-style-type: none"> a. Push and release button (do not hold). Try manual mode. In automatic mode with the motor off, set the web force. When it starts to run, see calculated pressure sent to brake for that required web force. Even though you do not see a large increase in the pressure on the display, feel the web tension manually to see if the brake tension has changed.
33	I pressed the motor forward push button and the arrow light did not come on.	<ul style="list-style-type: none"> a. Are the shafts locked in? 	<ul style="list-style-type: none"> a. Close the doors and lock in the shafts, then try the motor.

Problem Number	Problem	Possible Cause	Corrective Action
34	I pressed the shaft engage push button and the shaft did not engage.	<ul style="list-style-type: none"> a. Are the guard doors closed? b. Is the machine reset? c. Are the e-stop buttons pressed and the kick cables reset? 	<ul style="list-style-type: none"> a. Close the doors. b. Reset the machine. See "Machine Reset Procedure" on page 3-3. c. See problem 12.
35	The machine was running, but stopped abruptly.	<ul style="list-style-type: none"> a. Has the machine blown a fuse? b. Did you activate the kick cable? 	<ul style="list-style-type: none"> a. Check fuses on the back of the machine. b. Reset the kick cable.
36	The machine was running, but then the rolls went up and the machine stopped	<ul style="list-style-type: none"> a. Was the e-stop pressed? b. Did you activate the kick cable? 	<ul style="list-style-type: none"> a. Reset the e-stop and reset the machine. See "Machine Reset Procedure" on page 3-3. b. Reset the kick cable and reset the machine. See "Machine Reset Procedure" on page 3-3.
37	Nothing seems to work.	<ul style="list-style-type: none"> a. Is the machine reset? 	<ul style="list-style-type: none"> a. Reset the machine. See "Machine Reset Procedure" on page 3-3.
38	Slitter is not cutting.	<ul style="list-style-type: none"> a. Is the blade adjusted properly? b. Is the blade dull or damaged? c. Is the bushing that mounts the blade worn out? 	<ul style="list-style-type: none"> a. Check blade adjustment. "Setting the Slitter" on page 3-12 b. Replace blade. c. Replace the bushing.
39	Paper rips easily at the point it is pulled off.	<ul style="list-style-type: none"> a. Is the slitter tube enlarged? 	<ul style="list-style-type: none"> a. The plastic slitter tube can become enlarged from many cuts in a close area. This causes the edge of the paper to go around a larger diameter at the slitter station and causes small tears in the paper's edges which can lead to the paper starting to tear all the way across at the rear idler. The solution is to sand/file down the frequently used raised areas on the slitter's plastic tube.

Section 5 : Warranty

Limited Warranty

GBC Pro-Tech Engineering Company, Inc. warrants the equipment sold is free from defects in material and workmanship for a period of one year **from the date of delivery** to the customer for parts and ninety days (90) **from the date of delivery** to the customer for labor. This warranty is the only warranty made by GBC Pro-Tech and cannot be modified or amended.

GBC Pro-Tech's sole and exclusive liability and the customer's sole and exclusive remedy under this warranty shall be, at GBC Pro-Tech's option, to repair or replace any such defective part or product. These remedies are only available if GBC Pro-Tech's examination of the product discloses to GBC Pro-Tech's satisfaction that such defects actually exist and were not caused by misuse, neglect, attempt to repair, unauthorized alteration or modification, incorrect line voltage, contaminated air supply, or by fire, accident, flood, or other hazard.

This warranty specifically does not cover damage to the laminating rollers caused by knives, razor blades, other sharp objects, failure caused by adhesives or improper use of the machine. Warranty repair or replacement does not extend the warranty beyond the initial period from the date of delivery.



IMPORTANT

Unauthorized customer alterations will void this warranty.

THE WARRANTY MADE HEREIN IS IN LIEU OF ALL OTHER WARRANTIES, EXPRESS OR IMPLIED, INCLUDING ANY WARRANTY OR MERCHANTABILITY OR FITNESS FOR A PARTICULAR PURPOSE. GBC PRO-TECH WILL NOT BE LIABLE FOR PROPERTY DAMAGE OR PERSONAL INJURY (UNLESS PRIMARILY CAUSED BY ITS NEGLIGENCE), LOSS OF PROFIT OR OTHER INCIDENTAL OR CONSEQUENTIAL DAMAGES ARISING OUT OF THE USE OR INABILITY TO USE THE EQUIPMENT.

Exclusions to the Warranty

This warranty specifically does not cover:

1. Damage to the laminating rolls caused by knives, razor blades, other sharp objects, or failure caused by adhesives.
2. Damage to the machine caused by lifting, tilting, and/or any attempt to position the machine other than rolling on the installed casters on even surfaces.
3. Improper use of the machine.

Blank page.

Section 6 : Specifications

Table 6-1: ORCA-IV Image Transfer Laminator
Specifications

Characteristic	Specifications
Dimensions (L x D x H)	86" x 48" x 73" (2.2 x 1.2 x 1.7 m)
Weight	Uncrated: 3060 lbs (1814 kg)
Main Rolls	62" (157 cm) roll face with high release silicon rubber coating for 54" wide materials
Main Roll Opening	1.25" (3.2 cm) maximum opening
Material	Uses transfer materials 0 - 54" (0 - 137.2 cm) wide. Handles materials on 3" (7.6 cm) ID cores with material diameters up to 15" (38.1 cm).
Speeds	0 to 10 fpm (0 to 3.1 mpm) for transfer process with variable speed and 19 fpm (5.8 mpm), reversible action, start and stop controlled by the instrument panel.
Safety Features	<ul style="list-style-type: none"> All electrical and moving mechanical parts are located in bolted cabinets Emergency stop buttons with a reset button circuit Fully guarded with interlocks Emergency stop kick cables
Options	<ul style="list-style-type: none"> Preheater module
Installation Requirement	<p>230VAC 50 or 60 Hz, three phase, 45A per phase with preheater (35A per phase without preheater) for 4 wire delta hookup. 40A service without the preheater and 50A service with the preheater is required.</p> <p>Filtered air at 1.5 cubic feet per minute (cfm), 50 liters/minute at a pressure of 100 pounds per square inch (psi) (700 kPa)</p>

Blank page.

Index

Numerics

3M 3-12

A

Accessory pack 2-4

Air supply 2-2

Audible signals 3-3

C

Centering the web 3-13

Chain

 Lubrication 4-3

Changing film and paper 3-14

Cleaning 4-1

 Cabinet and covers 4-2

 Doors 4-2

 Rolls 4-1

Controls

 Front brake panel 3-6

 Front control panel 3-4

 Rear brake panel 3-10

 Rear control panel 3-8

E

Emergency stop buttons 1-2, 2-6, 3-2

Environment 2-1

F

Film 3-12

 Loading 3-11

Film spacing 3-14

Front clutch/brake panel 3-6

Front control panel 3-4

FWD/REV switch 4-2

G

Grease fittings 4-3

H

Heater 2-7

 Controller 2-7

Heating 3-11

I

Installation requirements 2-1, 6-1

International shipments 2-5

Isopropyl alcohol 4-1

J

Jumper configurations 2-1

K

Kick cable 1-2, 2-6

 Adjusting 4-3

L

Laminate adhesives 3-12

Leveling 2-5

Lubrication 4-3

M

Main roll opening 6-1

Main rolls 6-1

Maintenance schedule 4-1

Material 6-1

Motor 2-7

N

Nip 1-1, 1-3, 3-1

O

Options 6-1

P

Paper 3-12

Positioning the film 3-13

Preinstallation checklist 2-1

Process control charts 3-15

R

Rear clutch/brake panel 3-10

Rear control panel 3-8

Recommended materials 3-12

Reset button 1-3

Reset procedure, machine 1-3

Reset, machine 3-3

Rexam 3-12

Riggers 1-5, 2-4

Roll to roll transfer 3-15

Rubber cement eraser 4-1

S

- Safety 1-1
- Safety features 6-1
- Safety hazard decals 1-7
- Safety information 1-1, 3-1
- Safety labels 1-5
- Setup 3-11
- Setup procedure 2-5
- Shutdown 3-16
- Shutdown, machine 3-16
- Slitter 3-12
- Specifications
 - Dimensions 6-1
 - Installation requirements 6-1
 - Main roll opening 6-1
 - Main rolls 6-1
 - Material 6-1
 - Options 6-1
 - Speeds 6-1
 - Weight 6-1
- Speeds 6-1
- Splicing
 - Paper 3-14
 - Vinyl 3-14

T

- Technical support
 - Call 1-608-246-8844 or fax 1-608-246-8645 4-4

U

- Unpacking 2-4
 - Crate 2-4
- Upper main roll 1-4

V

- Vinyl transfer 3-15
- Vinyl transfer and overlamination materials 3-12

W

- Warnings and cautions 1-1
- Warranty 5-1
 - Exclusions 5-1

Free Manuals Download Website

<http://myh66.com>

<http://usermanuals.us>

<http://www.somanuals.com>

<http://www.4manuals.cc>

<http://www.manual-lib.com>

<http://www.404manual.com>

<http://www.luxmanual.com>

<http://aubethermostatmanual.com>

Golf course search by state

<http://golfingnear.com>

Email search by domain

<http://emailbydomain.com>

Auto manuals search

<http://auto.somanuals.com>

TV manuals search

<http://tv.somanuals.com>