



Radiant Self-Cleaning Convection Ranges

Safety Instructions2-7

Operating Instructions

Convection Oven21-24
 Roasting Guide24
 Timed Convection Baking25
 Griddle8-9
 Restaurant Quality Steak9
 Lower Oven Drawer30
 Range Lockout27
 Surface Units10-13
 Thermostat29, 30
 Upper Oven15-32
 Aluminum Foil16
 Baking or Roasting16
 Broiling Guide17
 Clock and Timer18
 Oven Controls14
 Preheating16
 Probe20
 Sabbath Feature28
 Self-Cleaning31, 32
 Special Features26, 27
 Timed Baking and
 Roasting Features19

Care and Cleaning

Control Panel and Knobs36
 Glass Cooktop Surface38, 39
 Griddle33
 Lift-Off Oven Door34
 Lower Oven Drawer35
 Oven Air Vents36
 Oven Heating Elements34
 Oven Light Replacement37
 Oven Racks37
 Self-Cleaning31, 32
 Stainless Steel Surfaces33

Installation

Instructions40-42
 Anti-Tip Device40
 Level the Range42
 Safety Instructions40

Accessories48

Troubleshooting

Tips44-47

Consumer Support

Consumer
 SupportBack Cover
 Product Registration49, 50
 Warranty51

Owner's Manual & Installation Instructions

CBC980

Write the model and serial numbers here:

Model # _____

Serial # _____

You can find them on a label on the front of the range behind the lower oven drawer.

IMPORTANT SAFETY INFORMATION. READ ALL INSTRUCTIONS BEFORE USING.

⚠ WARNING!

For your safety, the information in this manual must be followed to minimize the risk of fire or explosion, electric shock, or to prevent property damage, personal injury, or loss of life.



ANTI-TIP DEVICE



⚠ WARNING

- All ranges can tip.
- BURNS or other SERIOUS INJURIES can result.
- INSTALL and CHECK the ANTI-TIP bracket following the instructions supplied with the bracket.

To reduce the risk of tipping the range, the range must be secured by a properly installed anti-tip bracket. See installation instructions shipped with the bracket for complete details before attempting to install.

To check if the bracket is installed and engaged properly, carefully tip the range forward. The bracket should stop the range within 4 inches. If it does not, the bracket must be reinstalled. If the range is pulled from the wall for any reason, always repeat this procedure to verify the range is properly secured by the anti-tip bracket.

For free-standing or slide-in ranges, never completely remove the leveling legs or the range will not be secured to the anti-tip device properly.

If you did not receive an anti-tip bracket with your purchase, call 1.800.626.8774 to receive one at no cost (in Canada, call 1.800.561.3344). For installation instructions of the bracket, visit GEAppliances.com (in Canada, GEAppliances.ca).

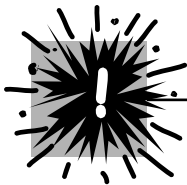

SAFETY PRECAUTIONS

When using electrical appliances, basic safety precautions should be followed, including the following:

- n Use this appliance only for its intended purpose as described in this Owner's Manual.
- n Be sure your appliance is properly installed and grounded by a qualified technician in accordance with the provided installation instructions.
- n Do not attempt to repair or replace any part of your range unless it is specifically recommended in this manual. All other servicing should be referred to a qualified technician.
- n Before performing any service, disconnect the range power supply at the household distribution panel by removing the fuse or switching off the circuit breaker.
- n Do not leave children alone—children should not be left alone or unattended in an area where an appliance is in use. They should never be allowed to sit or stand on any part of the appliance.
- n Do not allow anyone to climb, stand or hang on the oven door, drawer or cooktop. They could damage the range and even tip it over, causing severe personal injury.
- n Do not store flammable materials in an oven or near the cooktop.
- n **CAUTION:** Items of interest to children should not be stored in cabinets above a range or on the backsplash of a range—children climbing on the range to reach items could be seriously injured.



COOK MEAT AND POULTRY THOROUGHLY...

Cook meat and poultry thoroughly—meat to at least an INTERNAL temperature of 160°F and poultry to at least an INTERNAL temperature of 180°F. Cooking to these temperatures usually protects against foodborne illness.



⚠️ WARNING! SAFETY PRECAUTIONS

- n Never wear loose-fitting or hanging garments while using the appliance. Be careful when reaching for items stored over the range. Flammable material could be ignited if brought in contact with hot surface units or heating elements and may cause severe burns.
- n Use only dry pot holders—moist or damp pot holders on hot surfaces may result in burns from steam. Do not let pot holders touch hot surface units or heating elements. Do not use a towel or other bulky cloth.
- n For your safety, never use your appliance for warming or heating the room.
- n Do not let cooking grease or other flammable materials accumulate in or near the range.
- n Do not use water on grease fires. Never pick up a flaming pan. Turn the controls off. Smother a flaming pan on a surface unit by covering the pan completely with a well-fitting lid, cookie sheet or flat tray. Use a multi-purpose dry chemical or foam-type fire extinguisher.
Flaming grease outside a pan can be put out by covering it with baking soda or, if available, by using a multi-purpose dry chemical or foam-type fire extinguisher.
Flame in the upper oven or lower oven drawer can be smothered completely by closing the oven door or drawer and turning the oven off, or by using a multi-purpose dry chemical or foam-type fire extinguisher.
- n Be sure all packaging materials are removed from the range before operating it to prevent fire or smoke damage should the packaging material ignite.
- n After prolonged use of a range, high floor temperatures may result and many floor coverings will not withstand this kind of use. Never install the range over vinyl tile or linoleum that cannot withstand such type of use. Never install it directly over interior kitchen carpeting.
- n Do not touch the surface units, the heating elements or the interior surface of the oven. These surfaces may be hot enough to burn even though they are dark in color. During and after use, do not touch, or let clothing or other flammable materials contact, the surface units, areas nearby the surface units or any interior area of the oven; allow sufficient time for cooling first.
Potentially hot surfaces include the cooktop, areas facing the cooktop, oven vent opening, surfaces near the opening, crevices around the oven door and metal trim parts above the door.
REMEMBER: The inside surface of the oven may be hot when the door is opened.
- n Do not store or use combustible materials, gasoline or other flammable vapors and liquids in the vicinity of this or any other appliance.
- n Keep the hood and grease filters clean to maintain good venting and to avoid grease fires.
- n Never block the vents (air openings) of the range. They provide the air inlet and outlet that are necessary for the range to operate properly. Air openings are located at the rear of the cooktop, at the top and bottom of the oven door, and at the bottom of the range under the lower oven drawer.
- n Teach children not to play with the controls or any other part of the range.
- n Always keep dish towels, dish cloths, pot holders and other linens a safe distance from your range.
- n Always keep wooden and plastic utensils and canned food a safe distance from your range.
- n Always keep combustible wall coverings, curtains or drapes a safe distance from your range.

IMPORTANT SAFETY INFORMATION. READ ALL INSTRUCTIONS BEFORE USING.

⚠️ WARNING!



RADIANT SURFACE UNITS

Use proper pan size—select cookware having flat bottoms large enough to cover the surface unit heating element. The use of undersized cookware will expose a portion of the surface unit to direct contact and may result in ignition of clothing. Proper relationship of cookware to surface unit will also improve efficiency.

- n Never leave the surface units unattended at high heat settings. Boilovers cause smoking and greasy spillovers that may catch on fire.
- n Only certain types of glass, glass/ceramic, earthenware or other glazed containers are suitable for cooktop service; others may break because of the sudden change in temperature.
- n To minimize the possibility of burns, ignition of flammable materials and spillage, the handle of a container should be turned toward the center of the range without extending over nearby surface units.
- n Always turn the surface units off before removing cookware.
- n Do not flame foods on the cooktop. If you do flame foods under the hood, turn the fan on.
- n Keep an eye on foods being fried at high or medium high heat settings.
- n Foods for frying should be as dry as possible. Frost on frozen foods or moisture on fresh foods can cause hot fat to bubble up and over the sides of the pan.
- n Use little fat for effective shallow or deep fat frying. Filling the pan too full of fat can cause spillovers when food is added.
- n If a combination of oils or fats will be used in frying, stir together before heating, or as fats melt slowly.
- n Always heat fat slowly, and watch as it heats.
- n Use a deep fat thermometer whenever possible to prevent overheating fat beyond the smoking point.
- n Do not leave plastic items on the cooktop—they may melt if left too close to the vent.
- n Do not leave any items on the cooktop. The hot air from the vent may ignite flammable items and will increase pressure in closed containers, which may cause them to burst.



RADIANT SURFACE UNITS

- n Use care when touching the cooktop. The glass surface of the cooktop will retain heat after the controls have been turned off.
- n Avoid scratching the glass cooktop. The cooktop can be scratched with items such as sharp instruments, rings or other jewelry and rivets on clothing.
- n Large scratches or impacts to glass doors or cooktops can lead to broken or shattered glass.
- n Do not operate the radiant surface units if the glass is broken. Spillovers or cleaning solution may penetrate a broken cooktop and create a risk of electrical shock. Contact a qualified technician immediately should your glass cooktop become broken.
- n Never use the glass cooktop surface as a cutting board.
- n Do not place or store items that can melt or catch fire on the glass cooktop, even when it is not being used.
- n Be careful when placing spoons or other stirring utensils on the glass cooktop surface when it is in use. They may become hot and could cause burns.
- n Clean the cooktop with caution. If a wet sponge or cloth is used to wipe spills on a hot surface unit, be careful to avoid steam burns. Some cleaners can produce noxious fumes if applied to a hot surface.

NOTE: We recommend that you avoid wiping any surface unit areas until they have cooled and the indicator light has gone off. Sugar spills are the exception to this. Please see *Cleaning the glass cooktop* section.
- n When the cooktop is cool, use only the recommended cleaning cream to clean the cooktop.
- n To avoid possible damage to the cooking surface, do not apply cleaning cream to the glass surface when it is hot.
- n After cleaning, use a dry cloth or paper towel to remove all cleaning cream residue.
- n Read and follow all instructions and warnings on the cleaning cream labels.
- n Do not lift the cooktop. Lifting the cooktop can lead to damage and improper operation of the range.

IMPORTANT SAFETY INFORMATION. READ ALL INSTRUCTIONS BEFORE USING.



⚠️ WARNING! LOWER OVEN DRAWER

- n The purpose of the warm setting of the lower oven drawer is to hold hot cooked foods at serving temperature. Always start with hot food; cold food cannot be heated or cooked using the warm setting of the lower oven drawer.
- n Do not use the lower oven drawer to dry newspapers. If overheated, they can catch on fire.
- n Do not leave paper products, plastics, canned food or combustible materials in the drawer.
- n Never leave jars or cans of fat drippings in or near your lower oven drawer.
- n Do not warm food in the lower oven drawer for more than two hours.
- n **Do not touch the heating element or the interior surface of the lower oven drawer.** These surfaces may be hot enough to burn.
REMEMBER: The inside surface of the lower oven drawer may be hot when the drawer is opened.
- n Use care when opening the lower oven drawer. Open the drawer a crack and let hot air or steam escape before removing or replacing food. Hot air or steam which escapes can cause burns to hands, face and/or eyes.
- n Do not use aluminum foil to line the lower oven drawer. Foil is an excellent heat insulator and will trap heat beneath it. This will upset the performance of the drawer and it could damage the interior finish.
- n Never place, use or self-clean the lower oven drawer pan in the upper oven.



UPPER OVEN

Stand away from the range when opening the door of a hot oven. The hot air and steam that escape can cause burns to hands, face and eyes.

- n Do not use the oven for a storage area. Items stored in the oven can ignite.
- n Keep the oven free from grease buildup.
- n Place the oven racks in the desired position while the oven is cool. If racks must be handled when hot, do not let pot holder contact the heating elements.
- n Pulling out the rack to the stop-lock is a convenience in lifting heavy foods. It is also a precaution against burns from touching hot surfaces of the door or oven walls. The lowest position "R" is not designed to slide.
- n Do not heat unopened food containers. Pressure could build up and the container could burst, causing an injury.
- n When using cooking or roasting bags in the oven, follow the manufacturer's directions.
- n Do not use your oven to dry newspapers. If overheated, they can catch fire.
- n Do not leave paper products, cooking utensils or food in the oven when not in use.
- n Keep the oven vent unobstructed.
- n Make sure any broiler pan is in place correctly to reduce the possibility of grease fires.
- n If you should have a grease fire in a broiler pan, press the **CLEAR/OFF** pad and keep the oven door closed to contain fire until it burns out.
- n Never place, use or self-clean the lower oven drawer pan in the upper oven.



SELF-CLEANING UPPER OVEN

- n Be sure to wipe up excess spillage before self-cleaning operation.
- n Grey porcelain-coated racks may be cleaned in the oven during the self-clean cycle.
- n Before self-cleaning the oven, remove any broiler pan, grid and other cookware.
- n Never place, use or self-clean the lower oven drawer pan in the upper oven.
- n Do not clean the door gasket. The door gasket is essential for a good seal. Care should be taken not to rub, damage or move the gasket.
- n Clean only parts listed in this Owner's Manual.
- n If the self-cleaning mode malfunctions, turn the oven off and disconnect the power supply. Have it serviced by a qualified technician.
- n Do not use oven cleaners. No commercial oven cleaner or oven liner of any kind should be used in or around any part of the oven. Residue from oven cleaners will damage the inside of the oven when the self-clean cycle is used.



**READ AND FOLLOW THIS SAFETY INFORMATION CAREFULLY.
SAVE THESE INSTRUCTIONS**

Using the griddle.

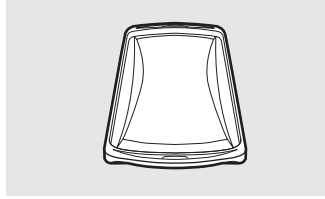

Your non-stick coated griddle provides an extra-large cooking surface for meats, pancakes or other food usually prepared in a frying pan or skillet.

NOTE: Your griddle will discolor over time as it becomes seasoned with use.

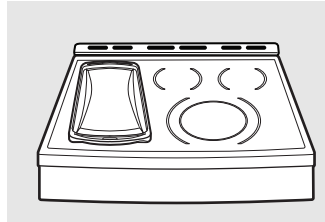

How to Place the Griddle

▲ CAUTION: Place and remove the griddle only when the griddle is cool and all surface units are turned OFF.

IMPORTANT: Always place and use your griddle on the left surface units only.

NOTE: Do not clean the griddle in the self-cleaning oven.

Using the Griddle

Most griddled foods require cooking on a preheated surface. Preheat griddle according to the guide below, then switch to the desired cook setting.

To turn on the surface units for the entire griddle, turn the knob clockwise.

To turn on the surface unit for the back half of the griddle, turn the knob counterclockwise.

▲ CAUTION: The entire griddle will still become hot.

IMPORTANT NOTES:

- Avoid cooking extremely greasy foods and be careful of grease spillover while cooking.
- Never place or store any items on the griddle, even when it is not in use. The griddle can become heated when using the surrounding surface units.

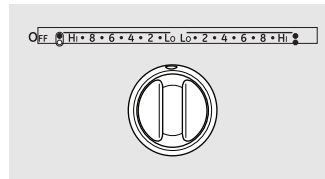

| Type of Food | Preheat Setting and Time | Cook Setting |
|---|--------------------------|--------------|
| Warming Tortillas | 5 5 min. | 5 |
| Pancakes | 8 5 min. | 3 |
| Hamburgers | 5 5 min. | 3 |
| Fried Eggs | 5 4 min. | 2 |
| Bacon | None | 6 |
| Breakfast Sausage Links | 8 5 min. | 4 |
| Hot Sandwiches (such as Grilled Cheese) | 8 3 min. | 3 |

NOTE: Griddle settings may need to be adjusted if griddle is used for an extended time.

Restaurant Quality Steak

Many fine restaurants will prepare steak by first searing it using cast iron, and then continue to finish the steak in the oven. Using the Lodge® cast iron griddle that came with your range, you can do the very same thing in the comfort of your own home! The chart and instructions below will guide you through this process.

| Meat Thickness | Desired Doneness | Griddle Control Setting | Griddle Preheat Time | Sear Each Side (Hi Setting) | Oven Temp (Bake) | Probe Internal Temp | Rest Time |
|------------------|------------------|-------------------------|----------------------|-----------------------------|------------------|---------------------|--------------|
| 3/4" to 1¼"† | Medium Well | Hi | 5 min. | 3 min. | 425° | 165° | 5 min. |
| | Well Done | Hi | 5 min. | 3 min. | 425° | 170° | 5 min. |
| 1½" to 2" | Medium Rare | Hi | 5 min. | 3 min. | 425° | 145° | 5 to 10 min. |
| | Medium | Hi | 5 min. | 3 min. | 425° | 160° | 5 to 10 min. |
| | Medium Well | Hi | 5 min. | 3 min. | 425° | 165° | 5 to 10 min. |
| | Well Done | Hi | 5 min. | 3 min. | 425° | 170° | 5 to 10 min. |
| Thicker than 2"‡ | Rare | Hi | 5 min. | 3 min. | 425° | 140° | 8 to 10 min. |
| | Medium Rare | Hi | 5 min. | 3 min. | 425° | 145° | 8 to 10 min. |
| | Medium | Hi | 5 min. | 3 min. | 425° | 160° | 8 to 10 min. |
| | Medium Well | Hi | 5 min. | 3 min. | 425° | 165° | 8 to 10 min. |

† Most thinner steaks will not cook to any less than Medium Well.

‡ May be difficult to cook thicker steaks to Well Done.

Restaurant Quality Steak, Easy as 1, 2, 3:

1.

Prep

- Bring steak to room temperature. **NOTE:** Always use safe food practices when handling meat.
- Season both sides to taste and coat with olive oil or similar.
- Preheat the oven to BAKE at 425°, with the oven rack in center position "C".
- Place your Lodge® cast iron griddle on the designated area of the cooktop and then preheat the griddle on the Hi setting for 5 minutes.
- Sear steak on each side for 3 minutes. **NOTE:** There will be "smoke"; ensure there is proper ventilation.
- Remove your Lodge® cast iron griddle from the cooktop and place directly in the oven with the steak still on the griddle.

2.

Cook

⚠ CAUTION: The griddle will be VERY HOT!

- Insert the meat probe that came with your range into the center of the steak, making sure that the tip of the probe is in the center of the steak.
- Plug the probe into the outlet (located on the upper front side of the oven), slide the rack back into the oven and close the door.
- Press **PROBE** on your control, enter the desired internal temp shown above, and press **START**.
- Allow steak to finish cooking in the oven. The range control will beep and turn off when the steak reaches the desired internal temperature.

3.

Enjoy

NOTES:

- After searing, your steak could possibly already be at the desired temperature, depending on size, cut and desired doneness.
 - For thinner steaks it may not be possible to achieve a Rare or Medium Rare doneness.
- Remove the steak from the oven, and let it rest on a baker's rack (or equivalent) for the specified time.

By first searing your meat with a very high heat, you are creating a browning reaction known as the Maillard Reaction. This Reaction unlocks the fuller, more intense flavor from the meat, which occurs when cooking meat at a high heat.

Using the surface units.

Throughout this manual, features and appearance may vary from your model.

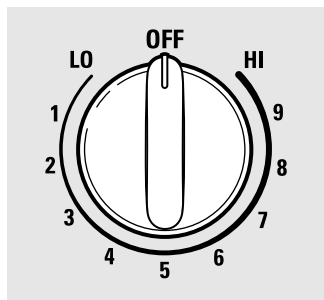

Be sure you turn the control knob to OFF when you finish cooking.

How to Set

Push the knob in and turn in either direction to the setting you want.

At both **OFF** and **HI** the control **clicks** into position. You may hear slight **clicking** sounds during cooking, indicating the control is keeping the power level you set.

A **HOT COOKTOP** indicator light will glow when any radiant element is turned on, and will remain on until the surface is cooled to approximately 150°F.

Indicator light will:

- n come on when the unit is turned on or hot to the touch.
- n stay on even after the unit is turned off.
- n glow until the unit is cooled to approximately 150°F.

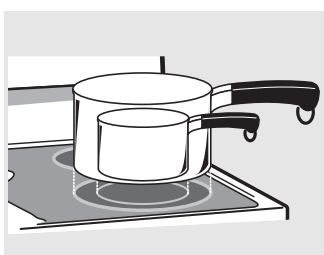

Dual Surface Unit Control Knob

The dual surface unit has 2 cooking sizes to select from so you can match the size of the unit to the size of the cookware you are using.

To use the small surface unit, turn the control knob counterclockwise to the small surface unit settings.

To use the large surface unit, turn the control knob clockwise to the large surface unit settings.

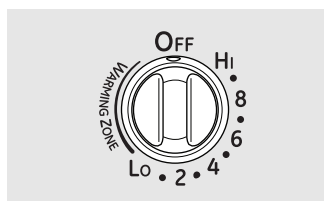
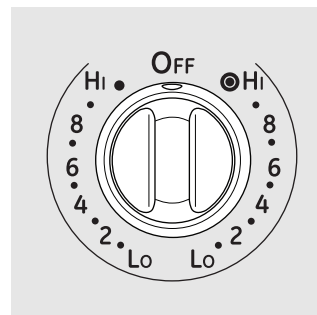

Using the COOK-WARM Zone

The **COOK-WARM ZONE**, located in the back center of the glass surface, will keep hot, cooked food at serving temperature. Always start with hot food. Do not use to heat cold food. Placing uncooked or cold food on the **COOK-WARM ZONE** could result in food-borne illness.

Push and turn the control knob to any desired setting.

For best results, all foods on the **COOK-WARM ZONE** should be covered with a lid or aluminum foil. When warming pastries or breads, the cover should be vented to allow moisture to escape.

Always use potholders or oven mitts when removing food from the **COOK-WARM ZONE**, as cookware and plates will be hot.

CAUTION: Do not warm food on the **COOK-WARM ZONE** for more than two hours.

NOTE: The surface cook-warm zone will not glow red like the cooking elements.

A **HOT** surface indicator light will glow when the glass surface is hot and will remain on until the surface is cool enough to touch. Lower settings may not heat the glass surface enough to cause the **HOT** surface indicator light to come on.

A **COOK-WARM ZONE** indicator light will glow when the unit is on.

- n Do not use plastic wrap to cover food. Plastic may melt onto the surface and be very difficult to clean.
- n Use only cookware recommended for top-of-range cooking.

GUIDE

SETTING FOOD

| | |
|----------|----------------------------|
| (Low) | Bread/Pastries |
| (Medium) | Chocolate/Butter |
| (Medium) | Sauces, Stews, Cream Soups |
| (Medium) | Vegetables |
| (High) | Soups (liquid) |
| (High) | Tea or Coffee |

The Guide is for reference only and the SETTING that you need will depend on the amount and type of food, the starting temperature of the food and the length of the holding time.

Throughout this manual, features and appearance may vary from your model.

Temperature Limiter

Every radiant surface unit has a temperature limiter.

The temperature limiter protects the glass cooktop from getting too hot.

The temperature limiter may cycle the units off for a time if:

- n *The pan boils dry.*
- n *The pan bottom is not flat.*
- n *The pan is off center.*
- n *There is no pan on the unit.*

Home Canning Tips

Be sure the canner is centered over the surface unit.

Make sure the canner is flat on the bottom.

To prevent burns from steam or heat, use caution when canning.

Use recipes and procedures from reputable sources. These are available from manufacturers such as Ball® and Kerr® and the Department of Agriculture Extension Service.

Flat-bottomed canners are recommended. Use of water bath canners with rippled bottoms may extend the time required to bring the water to a boil.

Wok Cooking

We recommend that you use only a flat-bottomed wok. They are available at your local retail store.

Do not use woks that have support rings.

Do not use round bottom woks. You could be seriously burned if the wok tipped over.

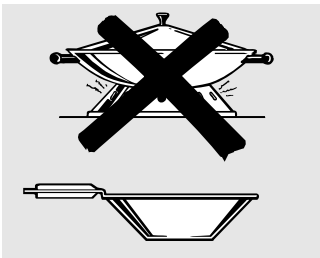

Use only flat-bottomed woks.

Using the surface units.

The following information will help you choose cookware which will give good performance on glass cooktops.



Never cook directly on the glass.
Always use cookware.



Always place the pan in the center
of the surface unit you are cooking on.

About the radiant surface units...

The radiant cooktop features heating units beneath a smooth glass surface.

NOTE: A slight odor is normal when a new cooktop is used for the first time. It is caused by the heating of new parts and insulating materials and will disappear in a short time.

NOTE: On models with light colored glass cooktops, it is normal for the cooking zones to change color when hot or cooling down. This is temporary and will disappear as the glass cools to room temperature.

The surface unit will cycle on and off to maintain your selected control setting.

It is safe to place hot cookware on the glass surface even when the cooktop is cool.

Even after the surface units are turned off, the glass cooktop retains enough heat to continue cooking. To avoid overcooking, remove pans from the surface units when the food is cooked. Avoid placing anything on the surface unit until it has cooled completely.

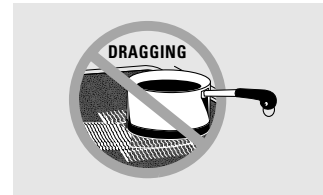

Do not slide cookware across the cooktop because it can scratch the glass—the glass is scratch resistant, not scratch proof.

- n Water stains (mineral deposits) are removable using the cleaning cream or full strength white vinegar.
- n Use of window cleaner may leave an iridescent film on the cooktop. The cleaning cream will remove this discoloration.
- n Don't store heavy items above the cooktop. If they drop onto the cooktop, they can cause damage.
- n Do not use the surface as a cutting board.

Selecting types of cookware.

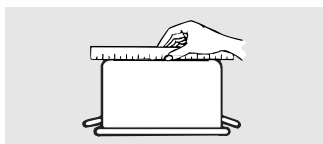

Check pans for flat bottoms by using a straight edge.

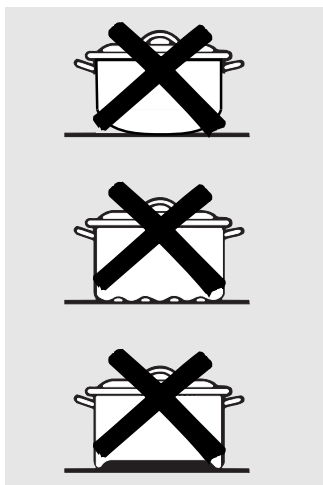

Pans with rounded, curved, ridged or warped bottoms are not recommended.

Stainless Steel:
recommended

Aluminum:
heavy weight recommended

Good conductivity. Aluminum residues sometimes appear as scratches on the cooktop, but can be removed if cleaned immediately. Because of its low melting point, thin weight aluminum should not be used.

Copper Bottom:
recommended

Copper may leave residues which can appear as scratches. The residues can be removed, as long as the cooktop is cleaned immediately. However, do not let these pots boil dry. Overheated metal can bond to glass cooktops. An overheated copper bottom pot will leave a residue that will permanently stain the cooktop if not removed immediately.

Porcelain Enamel Covered Cast Iron:
recommended

As long as the cookware is covered completely with porcelain enamel, this cookware is recommended. Caution is recommended for cast iron cookware that is not completely covered with smooth porcelain enamel, as it may scratch the glass ceramic cooktop.

NOTE: The Lodge® cast iron griddle provided with the range is specifically designed for use with the radiant cooktop. Do not use any other griddles on the radiant cooktop.

Glass-ceramic:

usable, but not recommended
Poor performance. May scratch the surface.

Stoneware:

usable, but not recommended
Poor performance. May scratch the surface.

Using the upper oven controls.

(Throughout this manual, features and appearance may vary from your model.)

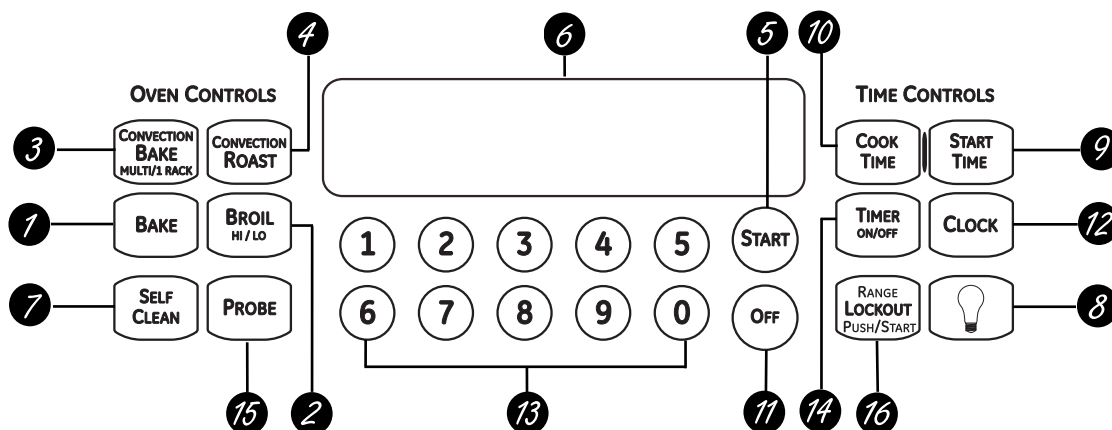

Features and appearance may vary.



Oven Control, Clock, Timer and Features

- 1** **BAKE Pad**
Touch to select the bake function.
 - 2** **BROIL HI/LO Pad**
Touch to select the broil function.
 - 3** **CONVECTION BAKE MULTI/1 RACK Pad**
Touch to select baking with the convection function.
 - 4** **CONVECTION ROAST Pad**
Touch to select roasting with the convection function.
 - 5** **START Pad**
Must be touched to start any cooking or cleaning function.
 - 6** **Display**
Shows the time of day, oven temperature, whether the oven is in the bake, broil or self-cleaning mode, the times set for the timer or automatic oven operations, and if the range is locked.
 - 7** **SELF-CLEAN Pad**
Touch to select self-cleaning function.
See the *Using the self-cleaning oven* section.
- If "F- and a number or letter" flash in the display and the oven control signals, this indicates a function error code.** Touch the **CLEAR/OFF** pad. Allow the oven to cool for one hour. Put the oven back into operation. If the function error code repeats, disconnect the power to the oven and call for service.
- If your oven was set for a timed oven operation and a power outage occurred, the clock and all programmed functions must be reset.**
- The time of day will flash in the display when there has been a power outage.**
- 8** **OVEN LIGHT Pad**
Touch to turn the oven light on or off.
 - 9** **START TIME pad**
Use along with **COOKING TIME** or **SELF CLEAN** pads to set the oven to start and stop automatically at a time you set.
 - 10** **COOK TIME Pad**
Touch and then touch the number pads to set the amount of time you want your food to cook. The oven will shut off when the cooking time has run out.
 - 11** **OFF Pad**
Touch to cancel **ALL** upper oven operations except the clock, timer and Range Lockout.
 - 12** **CLOCK Pad**
Touch before setting the clock.
 - 13** **Number Pads**
Use to set any function requiring numbers such as the time of day on the clock, the timer, the oven temperature, the internal food temperature, the start time and length of operation for timed baking and self-cleaning.
 - 14** **TIMER ON/OFF Pad**
Touch to select the timer feature.
 - 15** **PROBE Pad**
Touch when using the probe to cook food.
 - 16** **RANGE LOCKOUT Pad**
Touch the **RANGE LOCKOUT** pad and then touch the **START** pad to lock/unlock the surface units, oven burners and control panel so they cannot be activated.

Using the upper oven.

To avoid possible burns, place the racks in the desired position before you turn the oven on.

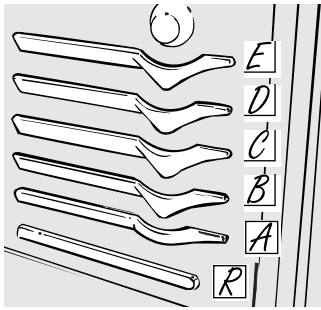

The oven has 5 rack positions.

It also has a special low rack position (R) for extra large items, such as a large turkey.

Before you begin...

The racks have stop-locks, so that when placed correctly on the supports, they will stop before coming completely out and will not tilt.

When placing and removing cookware, pull the rack out to the bump on the rack support.

To remove a rack, pull it toward you, tilt the front end up and pull it out.

To replace, place the end of the rack (stop-locks) on the support, tilt up the front and push the rack in.

NOTE: The rack is not designed to slide out at the special low rack (R) position.

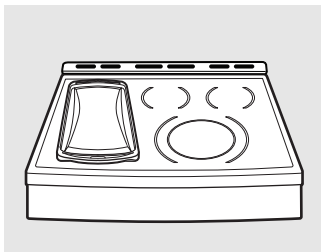

Plastic items on the cooktop may melt if left too close to the vent.

Vent appearance and location vary.

Upper Oven Vent

Your oven is vented through ducts at the rear of the range. Do not block these ducts when cooking in the oven—it is important that the flow of hot air from the oven and fresh air to the oven burner be uninterrupted. Avoid touching the vent openings or nearby surfaces during oven or broiler operation—they may become hot.

- ⓘ Handles of pots and pans on the cooktop may become hot if left too close to the vent.
- ⓘ Do not leave plastic items on the cooktop—they may melt if left too close to the vent.
- ⓘ Do not leave any items on the cooktop. The hot air from the vent may ignite flammable items and will increase pressure in closed containers, which may cause them to burst.
- ⓘ Metal items will become very hot if they are left on the cooktop, and could cause burns.

Upper Oven Light

Touch the **OVEN LIGHT**  pad to turn the light on or off.

Using the upper oven.

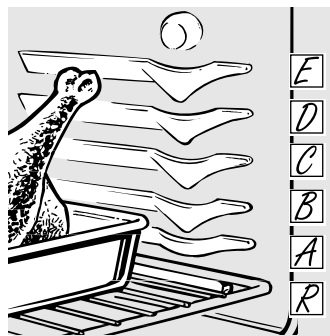

The oven has a special low rack (R) position just above the oven bottom. Use it when extra cooking space is needed, for example, when cooking a large turkey. The rack is not designed to slide out at this position.

How to Set the Upper Oven for Baking or Roasting

- 1 Touch the **BAKE** pad.
- 2 Touch the number pads to set the desired temperature.
- 3 Touch the **START** pad.

The word **ON** and **100°** will be displayed. As the oven heats up, the display will show the changing temperature. When the oven reaches the temperature you set, a tone will sound.

To change the oven temperature during BAKE cycle, press the BAKE pad and then the number pads to get the new temperature.

- 4 Check food for doneness at minimum time on recipe. Cook longer if necessary.
- 5 Touch the **OFF** pad when cooking is complete.

| Type of Food | Rack Position |
|---|---------------|
| Frozen pies (on cookie sheet) | C |
| Angel food cake | A |
| Bundt or pound cakes | C |
| Biscuits, muffins, brownies, cookies, cupcakes, layer cakes, pies | B or C |
| Casseroles | B or C |
| Turkey | R or A |
| Roasting | A or B |

Preheating and Pan Placement

Preheat the oven if the recipe calls for it. To preheat, set the oven at the correct temperature. Preheating is necessary when baking cakes, cookies, pastry and breads.

For ovens without a preheat indicator light or tone, preheat 10 minutes.

Baking results will be better if baking pans are centered in the oven as much as possible. Pans should not touch each other or the walls of the oven. If you need to use two racks, stagger the pans so one is not directly above the other, and leave approximately 1½" between pans, from the front, back and sides of the wall.

Aluminum Foil

Do not use aluminum foil on the bottom of the oven.

Do not use aluminum foil to catch spillovers when using the CircuWave fan. The foil will be sucked toward the convection fan.

Never entirely cover a rack with aluminum foil. This will disturb the heat circulation and result in poor baking.

A smaller sheet of foil may be used to catch a spillover by placing it on a lower rack several inches below the food.

Oven Moisture

As your oven heats up, the temperature change of the air in the oven may cause water droplets to form on the door glass. These droplets are harmless and will evaporate as the oven continues to heat up.

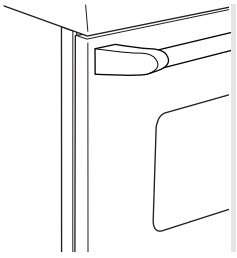

Close the door. **Always broil with the door closed.**

NOTE: Broil will not work if the temperature probe is plugged in.

How to Set the Upper Oven for Broiling—Close the oven door

- 1 Place the meat or fish on a broiler grid in a broiler pan.
- 2 Follow suggested rack positions in the *Broiling Guide*.
- 3 The oven door **must** be closed during broiling.
- 4 Touch the **BROIL HI/LO** pad once for **HI Broil**.
To change to **LO Broil**, touch the **BROIL HI/LO** pad again.
- 5 Touch the **START** pad.
NOTE: The display will always automatically remind you to close the door.
- 6 When broiling is finished, touch the **OFF** pad.
Serve the food immediately, and leave the pan outside the oven to cool during the meal for easiest cleaning.
Use **LO Broil** to cook foods such as poultry or thick cuts of meat thoroughly without over-browning them.

Broiling Guide

| Food | Quantity and/or Thickness | Rack Position | First Side Time (min.) | Second Side Time (min.) | Comments |
|------------------------|---|-------------------|------------------------|-------------------------|---|
| Ground Beef | 1 lb. (4 patties) ½ to ¾" thick | C | 13 | 8 | Space evenly. |
| | 4 lbs. (16 patties) | C | 15 | 11 | |
| Beef Steaks | Rare† | ¾ to 1" thick | E | 6 | Steaks less than ¾" thick are difficult to cook rare. Slash fat. |
| | Medium | 1 to 1½ lbs. | D | 8 | |
| | Well Done | | D | 10 | |
| | Rare† | 1½" thick | C | 10 | |
| Chicken | 1 whole cut up 2 to 2½ lbs., split lengthwise | Well Done | C | 15 | Brush each side with melted butter. Broil skin-side-down first. |
| | | Well Done | D | 20 | |
| | Breast | B | 25 | 15 | |
| Bakery Product | Bread (toast) | D | 3 | 1 | Space evenly. Place English muffins cut-side-up and brush with butter if desired. |
| | English Muffin | E | 3-4 | | |
| Lox Tails | 2-4 | B | 18-20 | Do not turn over. | Cut through back of shell. Spread open. Brush with melted butter before broiling and after half of broiling time. |
| Fish Fillets | 1 lb. (¼ to ½" thick) | D | 5 | 5 | Handle and turn very carefully. Brush with lemon butter before and during cooking, if desired. |
| Salmon | Steaks | 2 (1" thick) | D | 10 | Turn carefully. Do not turn skin side down. |
| | Fillet | 2 (½ to ¾" thick) | D | 10 | |
| Ham Slices (precooked) | ½" thick | C | 6 | 6 | Slash fat. |
| | 1" thick | C | 8 | 8 | |
| Pork Chops | 2 (½" thick) | C | 10 | 10 | Slash fat. |
| | 2 (1" thick) about 1 lb. | C | 15 | 15 | |
| Lamb Chops | 2 (1" thick) about 10 to 12 oz. | Medium | D | 7 | Slash fat. |
| | | Well Done | D | 10 | |
| | 2 (1½" thick) about 1 lb. | Medium | D | 9 | |
| | | Well Done | D | 14 | |

The size, weight, thickness, starting temperature and your preference of doneness will affect broiling times. This guide is based on meats at refrigerator temperature.

†The U.S. Department of Agriculture says "Rare beef is popular, but you should know that cooking it to only 140°F means some food poisoning organisms may survive." (Source: *Safe Food Book, Your Kitchen Guide*, USDA Rev. June 1985.)

Using the clock and timer.

Not all features are on all models.



Make sure the clock is set to the correct time of day.

To Set the Clock

The clock must be set to the correct time of day for the automatic oven timing functions to work properly. The time of day cannot be changed during a timed baking or self-cleaning cycle.

- 1 Touch the **CLOCK** pad.
- 2 Touch the number pads.

Touch the number pads the same way you read them. For example, to set 12:34, touch the number pads **1, 2, 3** and **4** in that order.

If number pads are not touched within one minute after you touch the **CLOCK** pad, the display reverts to the original setting. If this happens, touch the **CLOCK** pad and reenter the time of day.

- 3 Touch the **START** pad until the time of day shows in the display. This enters the time and starts the clock.

*To check the time of day when the display is showing other information, simply touch the **CLOCK** pad. The time of day shows until another pad is touched.*

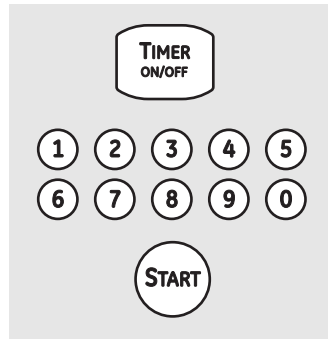

The timer is a minute timer only.
The CLEAR/OFF pad does not affect the timer.

To Set the Timer

The timer does not control oven operations. The maximum setting on the timer is 9 hours and 59 minutes.

- 1 Touch the **TIMER ON/OFF** pad.
- 2 Touch the number pads until the amount of time you want shows in the display. The maximum number of minutes that can be entered is 60. To set additional time, you will need to set it by hours and minutes. For example, to enter 1 hour and 30 minutes, touch **1, 3** and **0** in that order.

*If you make a mistake, press the **KITCHEN TIMER ON/OFF** pad and begin again.*

- 3 Touch the **START** pad. After pressing the **START** pad, **SET** disappears; this tells you the time is counting down, although the display does not change until one minute has passed.
- 4 When the timer reaches **:00**, the control will beep 3 times followed by one beep every 6 seconds until the **TIMER ON/OFF** pad is touched.

The 6 second tone can be canceled by following the steps in the Special features of your oven control section under Tones at the End of a Timed Cycle.

To Reset the Timer

If the display is still showing the time remaining, you may change it by touching the **TIMER ON/OFF** pad; then touch the number pads until the time you want appears in the display.

If the remaining time is not in the display (clock, delay start or cooking time are in the display), recall the remaining time by touching the **TIMER ON/OFF** pad and then touching the number pads to enter the new time you want.

To Cancel the Timer

Touch the **TIMER ON/OFF** pad twice.

Power Outage

If a flashing time is in the display, you have experienced a power failure. Reset the clock.

To reset the clock, touch the **CLOCK** pad. Enter the correct time of day by touching the appropriate number pads. Touch the **START** pad.

Using the timed baking and roasting features (upper oven only).

NOTE: Foods that spoil easily—such as milk, eggs, fish, stuffings, poultry and pork—should not be allowed to sit for more than 1 hour before or after cooking. Room temperature promotes the growth of harmful bacteria. Be sure that the oven light is off because heat from the bulb will speed harmful bacteria growth.

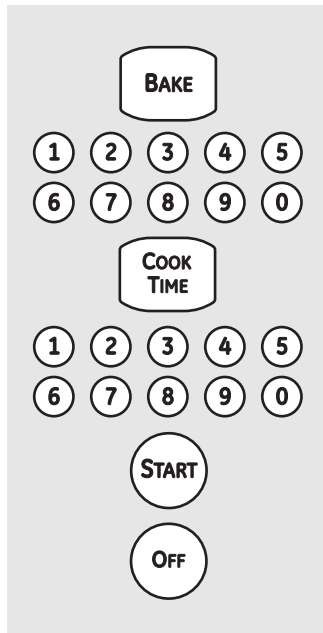

How to Set an Immediate Start and Automatic Stop

The upper oven will turn on immediately and cook for a selected length of time. At the end of the cooking time, the oven will turn off automatically.

- 1 Touch the **BAKE** pad.
- 2 Using the number pads, enter the desired temperature.
- 3 Touch the **COOK TIME** pad.

NOTE: If your recipe requires preheating, you may need to add additional time to the length of the cooking time.

- 4 Using the number pads, enter the desired baking time. The oven temperature and the cooking time that you entered will be displayed.
- 5 Touch the **START** pad.

The word **ON** and **100°** will be displayed. The cook time will begin to count down. As the oven heats up, the display will show the changing temperature. When the oven reaches the temperature you set, 3 beeps will sound.

At the end of timed baking, the oven will turn off. The end of cycle tone will sound.

Touch the **OFF** pad to clear the display.

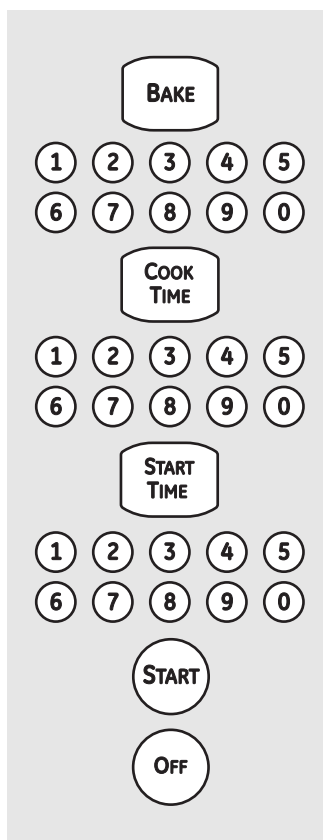

How to Set a Delayed Start and Automatic Stop

You can set the upper oven control to delay-start the oven, cook for a specific length of time and then turn off automatically.

Make sure the clock shows the correct time of day.

- 1 Touch the **BAKE** pad.
- 2 Using the number pads, enter the desired temperature.
- 3 Touch the **COOK TIME** pad.

NOTE: If your recipe requires preheating, you may need to add additional time to the length of the cooking time.

- 4 Using the number pads, enter the desired baking time.
- 5 Touch the **START TIME** pad.
- 6 Using the number pads, enter the time of day you want the oven to turn on and start cooking.
- 7 Touch the **START** pad.

NOTE: An attention tone will sound if you are using timed baking and do not touch the **START** pad after entering the baking temperature.

If you would like to check the times you have set, touch the **START TIME** pad to check the start time you have set or touch the **COOK TIME** pad to check the length of cooking time you have set.

The oven will turn on automatically. The word **ON** and **100°** will be displayed. The cook time will begin to count down.

As the oven heats up, the display will show the changing temperature. The oven will cook for the programmed cooking time and shut off automatically.

At the end of timed baking, the oven will turn off. The end of cycle tone will sound.

Touch the **OFF** pad to clear the display.

Using the probe.

For many foods, especially roasts and poultry, internal food temperature is the best test for doneness. The temperature probe takes the guesswork out of roasting by cooking foods to the exact doneness you want.

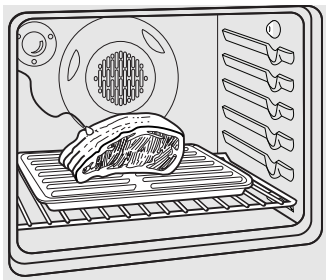

The temperature probe has a skewer-like probe at one end and a plug at the other end that goes into the outlet in the oven.

Use of probes other than the one provided with this product may result in damage to the probe.

Use the handles of the probe and plug when inserting and removing them from the food and outlet.

- n To avoid damaging your probe, do not use tongs to pull on the cable when removing it.
- n To avoid breaking the probe, make sure food is completely defrosted before inserting.
- n To prevent possible burns, do not unplug the probe from the outlet until the oven has cooled.

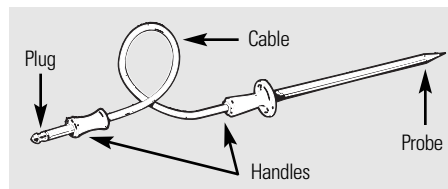

- n Never leave your probe inside the oven during a self-cleaning cycle.
- n Do not store the probe in the oven.

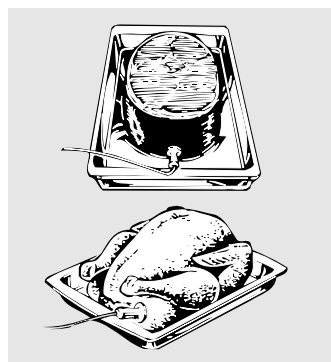

After preparing the meat and placing it on a trivet or on a broiler pan grid, follow these directions for proper probe placement.

Insert the probe completely into the meat. It should not touch the bone, fat or gristle.

For roasts with no bone, insert the probe into the meatiest part of the roast. For bone-in ham or lamb, insert the probe into the center of the lowest large muscle.

Insert the probe into the center of dishes such as meat loaf or casseroles.

Insert the probe into the meatiest part of the inner thigh from below and parallel to the leg of a whole turkey.

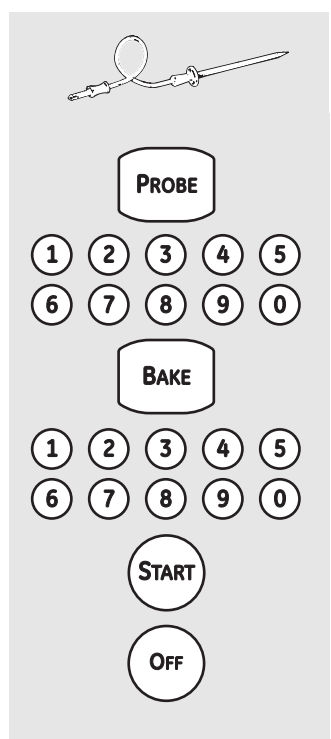

How to Set the Upper Oven For Roasting When Using the Probe

- 1 Insert the probe into the food.
- 2 Plug the probe into the outlet in the oven. Make sure it's pushed all the way in. Close the oven door.
- 3 Touch the **PROBE** pad.
- 4 Touch the number pads to set the desired internal food or meat temperature.
- 5 Touch the **BAKE** pad.
- 6 Touch the number pads to set the desired oven temperature.
- 7 Touch the **START** pad.
- 8 When the internal temperature of the food reaches the number you have set, the probe and the oven turn off and the oven control signals. To stop the signal, touch the **OFF** pad. Use hot pads to remove the probe from the food. Do not use tongs to pull on it—they might damage it.

The display will flash if the probe is inserted into the outlet and you have not set a probe temperature and touched the **START** pad.

After the internal temperature of the food reaches 100°F, the changing internal temperature will be shown in the display.

To change the oven temperature during the Roast cycle, touch the **BAKE** pad and then the number pads to set the new temperature.

- n If the probe is removed from the food before the final temperature is reached, a tone will sound and the display will flash until the probe is removed from the oven.
- n You can use the timer even though you cannot use timed oven operations while using the probe.

Using the convection oven.

The convection oven fan shuts off when the oven door is opened. DO NOT leave the door open for long periods of time while using convection cooking.

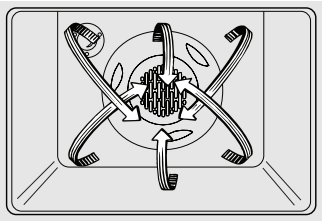

In a convection oven, a fan circulates hot air over, under and around the food. This circulating hot air is evenly distributed throughout the oven cavity. As a result, foods are evenly cooked and browned—often in less time than with regular heat.

NOTE: To maximize cooking evenness, the fan is designed to rotate in both directions with a pause in between. This is normal.

To help you understand the difference between convection bake and roast and traditional bake and roast, here are some general guidelines.

Convection Bake

- n Preheat the oven. See the Using the Oven— Preheating and Pan Placement section.
- n Ideal for foods cooked on multiple racks.
- n Good for large quantities of baked foods.
- n Good results with cookies, biscuits, brownies, cupcakes, cream puffs, sweet rolls, angel food cake and bread.

The convection fan circulates the heated air evenly over and around the food.

Convection Roast

- n Good for large tender cuts of meat, uncovered.

The convection fan circulates the heated air evenly over and around the food. Meat and poultry are browned on all sides as if they were cooked on a rotisserie. Heated air will be circulated over, under and around the food being roasted. The heated air seals in juices quickly for a moist and tender product while, at the same time, creating a rich golden brown exterior.

Roasts or poultry should be cooked on rack position (A).

When you are convection roasting, it is important that you use a broiler pan and grid for best convection roasting results. The pan is used to catch grease spills and the grid is used to prevent grease splatters.

- n Place the rack in rack position (A).

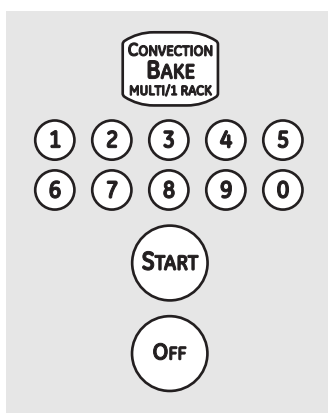
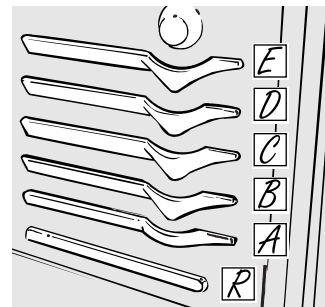

Auto Recipe™ Conversion

You can use your favorite recipes in the convection oven.

When using CONVECTION BAKE, the oven will automatically convert the oven temperature from regular baking to Convection Bake temperatures.

- 1 Using the number pads, enter the temperature recommended in the recipe.
- 2 Touch the **START** pad.

The display will show the temperature you entered from your recipe. The oven will automatically convert it to the convection cooking temperature.

- 3 Touch the **OFF** pad when baking is finished.

- n Use pan size recommended in the recipe.
- n Some package instructions for frozen casseroles, main dishes or baked goods have been developed using commercial convection ovens. For best results in this oven, preheat the oven and use the temperature, for regular baking, on the package.

Using the convection oven.

Cookware for Convection Cooking

Before using your convection oven, check to see if your cookware leaves room for air circulation in the oven. If you are baking with several pans, leave space between them. Also, be sure the pans do not touch each other or the walls of the oven.

Paper and Plastic

Heat-resistant paper and plastic containers that are recommended for use in regular ovens can be used in convection ovens. Plastic cookware that is heat-resistant to temperatures of 400°F can also be used, when oven is below 400°F.

Metal and Glass

Any type of cookware will work in your convection oven. However, metal pans heat the fastest and are recommended for convection baking.

n Darkened or matte-finished pans will bake faster than shiny pans.

n Glass or ceramic pans cook more slowly.

When baking cookies, you will get the best results if you use a flat cookie sheet instead of a pan with low sides.

For recipes like oven-baked chicken, use a pan with low sides. Hot air cannot circulate well around food in a pan with high sides.

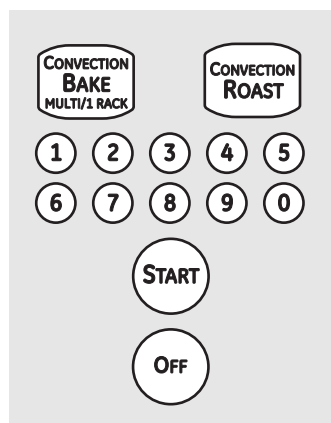

How to Set the Upper Oven for Convection Baking or Roasting

1 Touch the **CONVECTION BAKE MULTI/1 RACK** pad once for multi-rack convection baking. This mode is used for cooking food items on more than one rack (i.e., 2, 3 or more racks) at the same time in convection bake. See the *Multi-Rack Baking* section for more information. Touch the **CONVECTION BAKE MULTI/1 RACK** pad twice for one rack convection baking. This mode is used for cooking food items on only one rack in convection bake.

Touch the **CONVECTION ROAST** pad for convection roasting.

2 Touch the number pads to set the desired oven temperature. Remember to adjust baking temperature accordingly. See the *Adapting Recipes* section.

3 Touch the **START** pad.

To change the oven temperature, touch the **CONVECTION BAKE** or **CONVECTION ROAST** pad and then the number pads to set the new temperature.

When the oven starts to heat the changing temperature, starting at 100°F, will be displayed. When the oven reaches the temperature you set, 3 beeps will sound.

4 Touch the **OFF** pad when finished.

NOTE: You will hear a fan while cooking with convection. The fan will stop when the door is opened but the heat will not turn off.

The fan will not start until the preheat temperature is reached.

In convection bake modes, for maximum cooking evenness, the fan is designed to rotate in both directions, with a pause in between. This is normal.

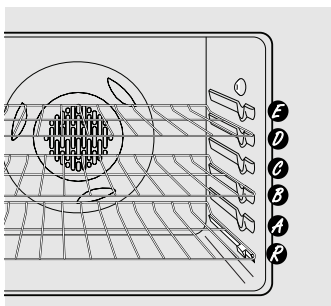

Multi-Rack Baking

Because heated air is circulated evenly throughout the oven, foods can be baked with excellent results using multiple racks.

Multi-rack baking may increase cook times slightly for some foods but the overall result is time saved. Cookies, muffins, biscuits, and other quick breads give very good results with multi-rack baking.

To cook food on more than one rack in convection bake, use **CONVECTION BAKE MULTI**.

When baking larger foods on 3 racks, place one rack in the 2nd (A) position, one on the 4th (C) position and the third rack in the 6th (E) position.

When baking cookies, place the racks in the 3rd (B), 4th (C) and 5th (D) positions.

When convection baking with only 1 rack, follow the rack positions recommended in the Using the Oven section.



For best results when roasting large turkeys and roasts, we recommend using the probe included in the convection oven.

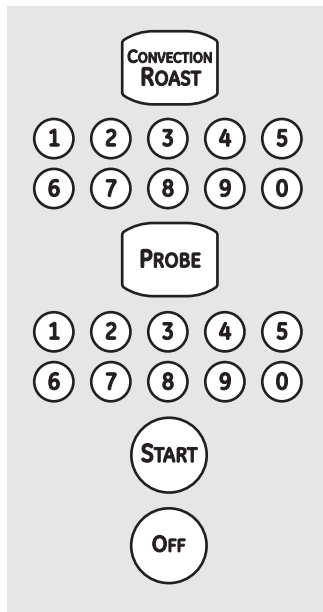

How to Set the Upper Oven for Convection Roasting when Using the Probe

The display will flash **PROBE** and the oven control will signal if the probe is inserted into the outlet, and you have not set a probe temperature and touched the **START** pad.

- 1 Place the rack in the rack position (A). Insert the probe completely into the food.
- 2 Plug the probe into the outlet in the oven. Make sure it is pushed all the way in. Close the oven door.
- 3 Touch the **CONVECTION ROAST** pad.
- 4 Touch the number pads to set the desired oven temperature.
- 5 Touch the **PROBE** pad.
- 6 Touch the number pads to set the desired internal food temperature.

To change the oven temperature during the Convection Roast cycle, touch the **CONVECTION ROAST** pad and then touch the number pads to set the new desired temperature.

- 7 Touch the **START** pad.

When the oven starts to heat, the word **LO** will be in the display.

After the internal temperature of the food reaches 100°F, the changing internal temperature will be shown in the display.

- 8 When the internal temperature of the food reaches the number you have set, the probe and the oven turn off and the oven control signals. To stop the signal, touch the **OFF** pad. Use hot pads to remove the probe from the food. Do not use tongs to pull on it—they might damage it.

CAUTION: To prevent possible burns, do not unplug the probe from the oven outlet until the oven has cooled. Do not store the probe in the oven.

NOTE:

- n If the probe is removed from the food before the final temperature is reached, a tone will sound and the display will flash until the probe is removed from the oven.
- n You will hear a fan while cooking with this feature. The fan will stop when the door is opened but the heat will not turn off.
- n You can use the timer even though you cannot use timed oven operations while using the probe.

Using the convection oven.

Convection Roasting Guide

| Meats | | Minutes/Lb. | Oven Temp. | Internal Temp. | | |
|----------------|---------------------------------------|---------------------------|-------------|----------------|------------|------------|
| Beef | Rib (3 to 5 lbs.) | Rare† | 20–24 | 325°F | 140°F | |
| | | Medium | 24–28 | 325°F | 160°F | |
| | | Well | 28–32 | 325°F | 170°F | |
| | Boneless Rib, Top Sirloin | Rare† | 20–24 | 325°F | 140°F | |
| Medium | | 24–28 | 325°F | 160°F | | |
| | Well | 28–32 | 325°F | 170°F | | |
| | Beef Tenderloin | Rare† | 10–14 | 325°F | 140°F | |
| | | Medium | 14–18 | 325°F | 160°F | |
| | Pot Roast (2½ to 3 lbs.) chuck, rump | | 35–45 | 300°F | 170°F | |
| Pork | Bone-in (3 to 5 lbs.) | | 23–27 | 325°F | 170°F | |
| | Boneless (3 to 5 lbs.) | | 23–27 | 325°F | 170°F | |
| | Pork Chops (½ to 1" thick) | 2 chops | 30–35 total | 325°F | 170°F | |
| | | 4 chops | 35–40 total | 325°F | 170°F | |
| 6 chops | | 40–45 total | 325°F | 170°F | | |
| Ham | Canned (3 lbs. fully cooked) | | 14–18 | 325°F | 140°F | |
| | Butt (5 lbs. fully cooked) | | 14–18 | 325°F | 140°F | |
| | Shank (5 lbs. fully cooked) | | 14–18 | 325°F | 140°F | |
| Lamb | Bone-in (3 to 5 lbs.) | Medium | 17–20 | 325°F | 160°F | |
| | | Well | 20–24 | 325°F | 170°F | |
| | Boneless (3 to 5 lbs.) | Medium | 17–20 | 325°F | 160°F | |
| | | Well | 20–24 | 325°F | 170°F | |
| Seafood | Fish, whole (3 to 5 lbs.) | | 30–40 total | 400°F | | |
| | Lobster Tails (6 to 8 oz. each) | | 20–25 total | 350°F | | |
| Poultry | Whole Chicken (2½ to 3½ lbs.) | | 24–26 | 350°F | 180°–185°F | |
| | Cornish Hens Unstuffed (1 to 1½ lbs.) | | 50–55 total | 350°F | 180°–185°F | |
| | | | 55–60 total | 350°F | 180°–185°F | |
| | Duckling (4 to 5 lbs.) | | 24–26 | 325°F | 180°–185°F | |
| | Turkey, whole* | Unstuffed (10 to 16 lbs.) | | 8–11 | 325°F | 180°–185°F |
| | | Unstuffed (18 to 24 lbs.) | | 7–10 | 325°F | 180°–185°F |
| | Turkey Breast (4 to 6 lbs.) | | 16–19 | 325°F | 170°F | |

* Stuffed birds generally require 30–45 minutes additional roasting time. Shield legs and breast with foil to prevent overbrowning and drying of skin.

† The U.S. Department of Agriculture says "Rare beef is popular, but you should know that cooking it to only 140°F means some food poisoning organisms may survive." (Source: *Safe Food Book. Your Kitchen Guide.* USDA Rev. June 1985.)

Using the timed convection baking features (upper oven only).

You will hear a fan while cooking with this feature. The fan will stop when the door is opened but the heat will not turn off.

NOTE: Foods that spoil easily—such as milk, eggs, fish, stuffings, poultry and pork—should not be allowed to sit for more than 1 hour before or after cooking. Room temperature promotes the growth of harmful bacteria. Be sure that the oven light is off because heat from the bulb will speed harmful bacteria growth.

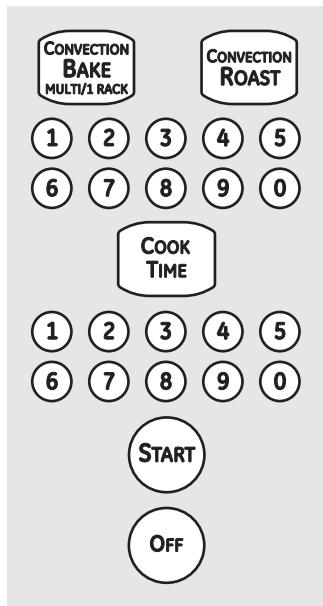

How to Set an Immediate Start and Automatic Stop

The upper oven will turn on immediately and cook for a selected length of time. At the end of the cooking time, the oven will turn off automatically.

- 1 Touch the **CONVECTION BAKE MULTI/1 RACK** pad once for multi-rack convection baking. This mode is used for cooking food items on more than one rack (i.e., 2, 3 or more racks) at the same time in convection bake. See the *Multi-Rack Baking* section for more information. Touch the **CONVECTION BAKE MULTI/1 RACK** pad twice for one rack convection baking. This mode is used for cooking food items on only one rack in convection bake. Touch the **CONVECTION ROAST** pad for convection roasting.

- 2 Touch the number pads to set the desired oven temperature.
- 3 Touch the **COOK TIME** pad.

NOTE: If your recipe requires preheating, you may need to add additional time to the length of the cooking time.

- 4 Touch the number pads to set the desired length of cooking time. The minimum cooking time you can set is 1 minute.

The oven temperature that you set and the cooking time that you entered will be in the display.

- 5 Touch the **START** pad.

The display shows the oven temperature that you set and the cooking time countdown. The display starts changing once the temperature reaches 100°F.

- 6 At the end of timed convection bake the oven will turn off. The end of cycle tone will sound. Touch the **OFF** pad to clear the display if necessary.
- 7 Remove the food from the oven. Remember, foods that are left in the oven continue cooking after the controls are off.

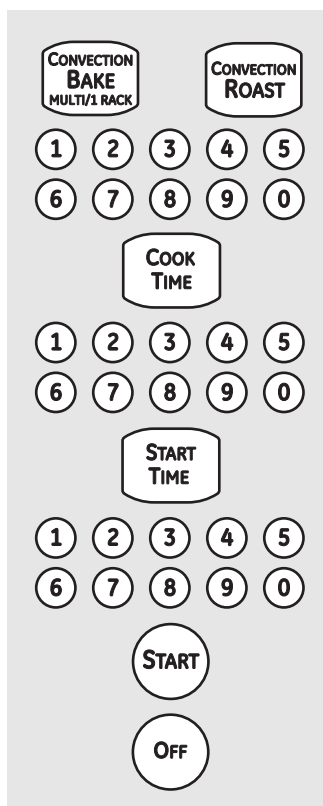

How to Set a Delayed Start and Automatic Stop

You can set the upper oven control to delay-start the oven, cook for a specific length of time and then turn off automatically.

Make sure the clock shows the correct time of day.

- 1 Touch the **CONVECTION BAKE MULTI/1 RACK** pad once for multi-rack convection baking. This mode is used for cooking food items on more than one rack (i.e., 2, 3 or more racks) at the same time in convection bake. See the *Multi-Rack Baking* section for more information. Touch the **CONVECTION BAKE MULTI/1 RACK** pad twice for one rack convection baking. This mode is used for cooking food items on only one rack in convection bake.

Touch the **CONVECTION ROAST** pad for convection roasting.

- 2 Touch the number pads to set the desired oven temperature.
- 3 Touch the **COOK TIME** pad.

NOTE: If your recipe requires preheating, you may need to add additional time to the length of the cooking time.

- 4 Touch the number pads to set the desired cooking time.

- 5 Touch the **START TIME** pad.

- 6 Touch the number pads to set the time of day you want the oven to turn on and start cooking.

If you would like to check the times you have set, touch the **START TIME** pad to check the start time you have set or touch the **COOK TIME** pad to check the length of cooking time you have set.

- 7 Touch the **START** pad.

NOTE: An attention tone will sound if you are using timed baking and do not touch the **START** pad after entering the baking temperature.

When the oven turns on at the time of day you have set, the display will show the changing temperature (starting at 100°F) and the cooking time countdown.

At the end of timed convection bake the oven will turn off. The end of cycle tone will sound.

- 8 Touch the **OFF** pad to clear the display if necessary. When baking is finished, remove the food from the oven. Remember, even though the oven shuts off automatically, foods continue cooking after the controls are off.

Special features of your upper oven control.

Your new touch pad control has additional features that you may choose to use. The following are the features and how you may activate them.

The special feature modes can only be activated while the display is showing the time of day. They remain in the control's memory until the steps are repeated.

When the display shows your choice, touch the **START** pad. The special features will remain in memory after a power failure.

12 Hour Shut-Off

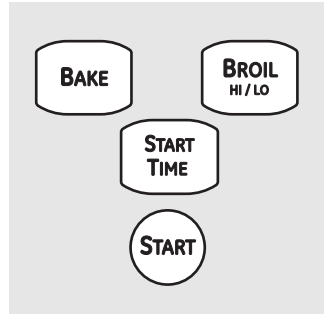

With this feature, should you forget and leave the oven on, the control will automatically turn off the oven after 12 hours during baking functions or after 3 hours during a broil function.

If you wish to turn **OFF** this feature, follow the steps below.

- 1 Touch the **BAKE** and **BROIL HI/LO** pads at the same time for 3 seconds until the display shows **SF**.

- 2 Touch the **START TIME** pad. The display will show **12 shdn** (12 hour shut-off). Touch the **START TIME** pad again and the display will show **no shdn** (no shut-off).
- 3 Touch the **START** pad to activate the no shut-off and leave the control set in this special features mode.

Fahrenheit or Celsius Temperature Selection

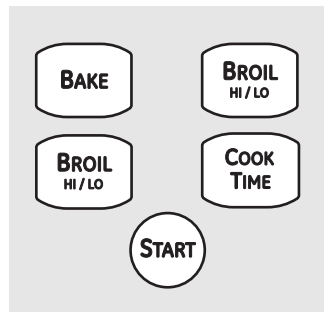

Your oven control is set to use the Fahrenheit temperature selections but you may change this to use the Celsius selections.

- 1 Touch the **BAKE** and **BROIL HI/LO** pads at the same time for 3 seconds until the display shows **SF**.

- 2 Touch the **BROIL HI/LO** pad. The display will show **F** (Fahrenheit).
- 3 Touch the **BROIL HI/LO** pad again. The display will show **C** (Celsius).
- 4 Touch the **START** pad.

Tones at the End of a Timed Cycle

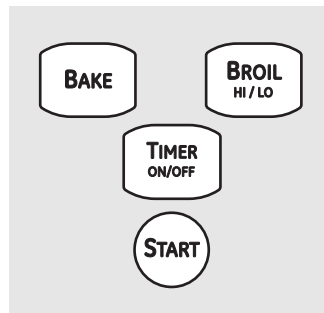

At the end of a timed cycle, 3 short beeps will sound followed by one beep every 6 seconds until the **CLEAR/OFF** pad is touched. This continual 6 second beep may be canceled.

To cancel the 6 second beep:

- 1 Touch the **BAKE** and **BROIL HI/LO** pads at the same time for 3 seconds until the display shows **SF**.

- 2 Touch the **TIMER ON/OFF** pad. The display shows **CON BEEP** (continual beep). Touch the **TIMER ON/OFF** pad again. The display shows **BEEP**. (This cancels the one beep every 6 seconds.)
- 3 Touch the **START** pad.



Range Lockout

Your control will allow you to lock out the surface units, oven burners and control panel so they cannot be activated.

To lock/unlock the controls:

- 1 Turn all surface units and the oven off.
- 2 Touch the **RANGE LOCKOUT** pad and then the **START** pad.
- 3 To unlock the control, touch the **RANGE LOCKOUT** pad and then the **START** pad.

When this feature is on and the touch pads are touched, the control will beep and the display will show **LOC**.

- n The control lock-out mode affects all controls. No controls will work when this feature is activated.
- n The adjustment will be retained in memory after a power failure.

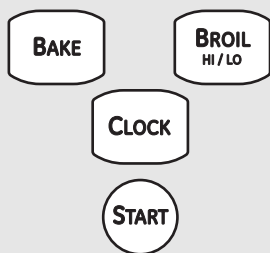

12 Hour, 24 Hour or Clock Black-Out

Your control is set to use a 12 hour clock.

If you would prefer to have a 24 hour military time clock or black-out the clock display, follow the steps below.

- 1 Touch the **BAKE** and **BROIL HI/LO** pads at the same time for 3 seconds until the display shows **SF**.
- 2 Touch the **CLOCK** pad once. The display will show **12 hr**. If this is the choice you want, touch the **START** pad.

Touch the **CLOCK** pad again to change to the 24 hour military time clock. The display will show **24 hr**. If this is the choice you want, touch the **START** pad.

Touch the **CLOCK** pad again to black-out the clock display. The display will show **OFF**. If this is the choice you want, touch the **START** pad.

NOTE: If the clock is in the black-out mode you will not be able to use the Delay Start function.

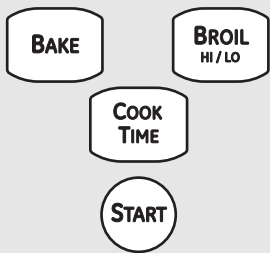

Cook and Hold

Your new control has a cook and hold feature that keeps cooked foods warm for up to 3 hours after the cooking function is finished.

This feature can only be used when timed cooking.

To activate this feature, follow the steps below.

- 1 Touch the **BAKE** and **BROIL HI/LO** pads at the same time for 3 seconds until the display shows **SF**.

- 2 Touch the **COOK TIME** pad. The display will show **Hld OFF**.

Touch the **COOK TIME** pad again to activate the feature. The display will show **Hld ON**.

- 3 Touch the **START** pad to activate the cook and hold feature and leave the control set in this special features mode.

Using the Sabbath Feature. (on some models)

(Designed for use on the Jewish Sabbath and Holidays)

The Sabbath feature can be used for baking/roasting in the upper oven only. It cannot be used for convection, broiling, self-cleaning, or Delay Start cooking.

NOTE: The oven light comes on automatically when the door is opened and goes off when the door is closed. The bulb may be removed. See the Oven Light Replacement section.

How to Set for Regular Baking/Roasting

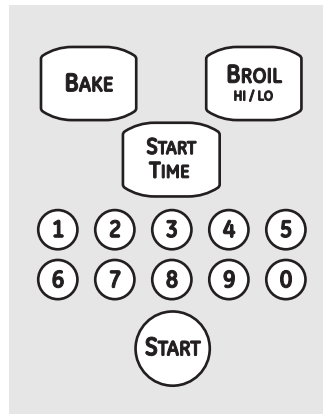

Make sure the clock shows the correct time of day and the oven is off.

- 1 Press and hold **both** the **BAKE** and **BROIL HI/LO** pads, **at the same time**, until the display shows **SF**.
- 2 Tap the **START TIME** pad until **Sab bAtH** appears in the display.
- 3 Touch the **START** pad and \supset will appear in the display.
- 4 Touch the **BAKE** pad. No signal will be given.
- 5 Using the number pads, enter the desired temperature between 170° and 550°. No signal or temperature will be given.

- 6 Touch the **START** pad.
- 7 After a random delay period of approximately 30 seconds to 1 minute, \supset \subset will appear in the display indicating that the oven is baking/roasting. If \supset \subset doesn't appear in the display, start again at Step 4.

To adjust the oven temperature, touch the **BAKE** pad, enter the new temperature using the number pads, and touch the **START** pad.

NOTE: The **OFF** and **COOK TIME** pads are active during the Sabbath feature.

When the display shows \supset the oven is set in Sabbath. When the display show \supset \subset the oven is baking/roasting.

How to Set for Timed Baking/Roasting—Immediate Start and Automatic Stop

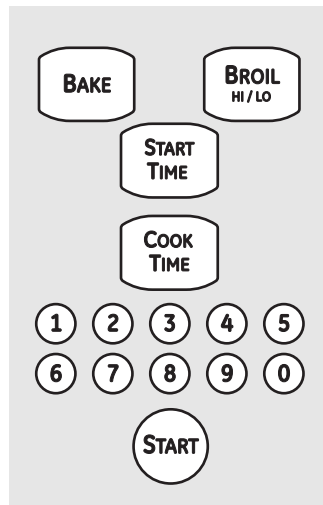

Make sure the clock shows the correct time of day and the oven is off.

- 1 Press and hold **both** the **BAKE** and **BROIL HI/LO** pads, **at the same time**, until the display shows **SF**.
- 2 Tap the **START TIME** pad until **Sab bAtH** appears in the display.
- 3 Touch the **START** pad and \supset will appear in the display.
- 4 Touch the **COOK TIME** pad.
- 5 Touch the number pads to set the desired length of cooking time between 1 minute and 9 hours and 99 minutes. The cooking time that you entered will be displayed.
- 6 Touch the **START** pad.
- 7 Touch the **BAKE** pad. No signal will be given.

- 8 Using the number pads, enter the desired temperature. No signal or temperature will be given.

- 9 Touch the **START** pad.
- 10 After a random delay period of approximately 30 seconds to 1 minute, \supset \subset will appear in the display indicating that the oven is baking/roasting. If \supset \subset doesn't appear in the display, start again at Step 7.

To adjust the oven temperature, touch the **BAKE** pad, enter the new temperature using the number pads, and touch the **START** pad.

When cooking is finished, the display will change from \supset \subset to \supset and **0:00** will appear, indicating that the oven has turned **OFF** but is still set in Sabbath. Remove the cooked food.

When the display shows \supset the oven is set in Sabbath. When the display shows \supset \subset the oven is baking/roasting.

How to Exit the Sabbath Feature

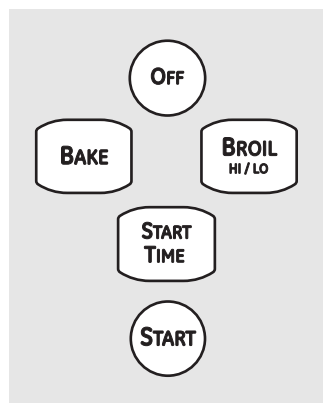

- 1 Touch the **OFF** pad.
- 2 If the oven is cooking, wait for a random delay period of approximately 30 seconds to 1 minute, until only \supset is in the display.
- 3 Press and hold **both** the **BAKE** and **BROIL HI/LO** pads, **at the same time**, until the display shows **SF**.
- 4 Tap the **START TIME** pad until **12 shdn** or **no shdn** appears in the display.

12 shdn indicates that the oven will automatically turn off after 12 hours.
no shdn indicates that the oven will not automatically turn off.

- 5 Touch the **START** pad.

NOTE: If a power outage occurred while the oven was in Sabbath, the oven will automatically turn off and stay off even when the power returns. The oven control must be reset.

Adjust the upper oven thermostat—Do it yourself!

geappliances.ca

You may find that your new oven cooks differently than the one it replaced. Use your new oven for a few weeks to become more familiar with it. If you still think your new oven is too hot or too cold, you can adjust the thermostat yourself.

Do not use thermometers, such as those found in grocery stores, to check the temperature setting of your oven. These thermometers may vary 20–40 degrees.

NOTE: This adjustment will not affect the broiling or the self-cleaning temperatures. The adjustment will be retained in memory after a power failure.

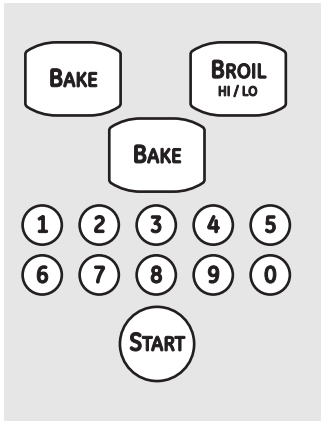

To Adjust the Thermostat

- 1 Touch the **BAKE** and **BROIL HI/LO** pads at the same time for 3 seconds until the display shows **SF**.
- 2 Touch the **BAKE** pad. A two digit number shows in the display.
Touch **BAKE** once to decrease (-) the oven temperature, or twice to increase (+).
- 3 The oven temperature can be adjusted up as much as 35°F or down as much as 35°F. Touch the number pads the same way you read them. For example, to change the oven temperature 15°F, touch **1** and **5**.
- 4 When you have made the adjustment, touch the **START** pad to go back to the time of day display. Use your oven as you would normally.

NOTE: The thermostat adjustment for Baking will also affect Convection Baking or Convection Roasting.

The type of margarine will affect baking performance!

Most recipes for baking have been developed using high fat products such as butter or margarine (80% fat). If you decrease the fat, the recipe may not give the same results as with a higher fat product.

Recipe failure can result if cakes, pies, pastries, cookies or candies are made with low-fat spreads. The lower the fat content of a spread product, the more noticeable these differences become.

Federal standards require products labeled "margarine" to contain at least 80% fat by weight. Low-fat spreads, on the other hand, contain less fat and more water. The high moisture content of these spreads affects the texture and flavor of baked goods. For best results with your old favorite recipes, use margarine, butter or stick spreads containing at least 70% vegetable oil.

Safety Instructions

Operating Instructions

Care and Cleaning

Installation Instructions

Troubleshooting Tips

Consumer Support

Using the lower oven drawer.

The lower oven drawer may be used to bake foods using the same times and temperatures as a standard oven. Foods ideal for baking in the lower oven drawer include pizza, frozen foods, casseroles, biscuits, rolls and many desserts.

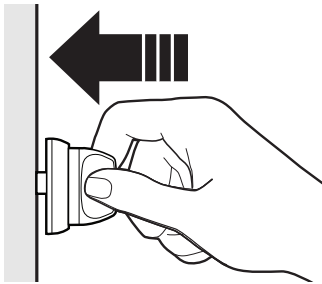
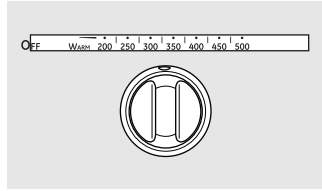

Push in and turn the lower oven drawer knob to any desired setting.

To Use the Lower Oven Drawer

- 1 Push in and turn the lower oven drawer knob to any desired setting.
- 2 Allow the lower oven drawer to preheat.
 - n The ON signal light is located on the upper right side of the knob and glows when the knob is in the ON position. It remains ON until the knob is moved to the OFF position.
 - n The "Heating" signal light is located below the ON signal light and glows when the heating elements are active. Preheat is complete after the "Heating" signal has turned off for the first time with each use.

NOTES:

- n Always use the included drawer rack when using the Lower Oven Drawer.
- n The lower oven drawer cannot be used during a self-clean cycle of the upper oven.
- n Do not put food, foil or cookware directly on the bottom of the lower oven drawer. Always use the included drawer rack.
- n If foods require a cover, use only foil or lids able to withstand baking temperatures. Do not use plastic.
- n Maximum height of foods that can be placed in the lower oven drawer is 4".
- n Do not put liquid or water in the lower oven drawer.
- n Never place plastics, paper, canned foods or combustible material in the lower oven drawer.

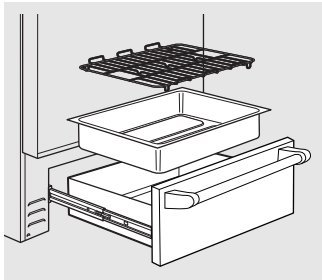

The lower oven drawer uses less energy than the upper oven. Allow the following approximate times for preheating:

| Desired Lower Oven Temperature | Preheat Time |
|--------------------------------|--------------|
| WARM | 10 minutes |
| 350°F | 20 minutes |
| 425°F | 30 minutes |

Adjust the lower oven drawer thermostat—Do it yourself!

You may find that your new oven cooks differently than the one it replaced. Use your new oven for a few weeks to become more familiar with it. If you still think your new oven is too hot or too cold, you can adjust the thermostat yourself.

Do not use thermometers, such as those found in grocery stores, to check the temperature setting of your oven. These thermometers may vary 20–40 degrees.

NOTE: This adjustment will not affect the broiling temperatures.

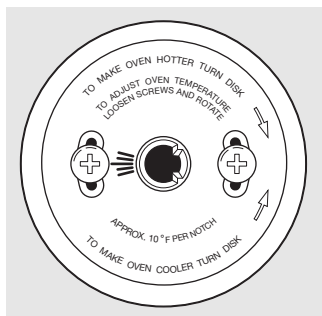

Back of Lower Oven Knob
(Appearance may vary.)

- 1 Pull the **OVEN CONTROL** knob off the range and look at the back side. To make an adjustment, loosen (approximately one turn), but do not completely remove, the two screws on the back of the knob.
- 2 With the back of the knob facing you, hold the outer edge of the knob with one hand and turn the front of the knob with the other hand.
 - To raise the oven temperature, move the top screw toward the right. You'll hear a click for each notch you move the knob.
 - To lower the temperature, move the top screw toward the left.

Each click will change the oven temperature approximately 10°F. (Range is ± 60°F. from the arrow.) We suggest that you make the adjustment one click from the original setting and check oven performance before making any additional adjustments.

- 3 After the adjustment is made, retighten screws so they are snug, but be careful not to overtighten.
- 4 Re-install knob on range and check performance.

Using the self-cleaning upper oven.

The oven door must be closed and all controls set correctly for the cycle to work properly.

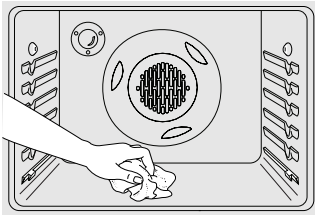

Wipe up heavy soil on the oven bottom.

Before a Clean Cycle

For the first self-clean cycle, we recommend venting your kitchen with an open window or using a ventilation fan or hood.

Remove broiler pan, broiler grid, probe, all cookware and any aluminum foil from the oven.

NOTE: Your oven is equipped with grey porcelain-coated oven racks, they may be left in the oven during the self-clean cycle.

The oven racks can be self-cleaned, but they will darken, lose their luster and become hard to slide.

Soil on the front frame of the range and outside the gasket on the door will need to be cleaned by hand. Clean these areas with hot water, soap-filled scouring pads or cleansers such as Soft Scrub®. Rinse well with clean water and dry.

Do not clean the gasket. The fiberglass material of the oven door gasket cannot withstand abrasion. It is essential for the gasket to remain intact. If you notice it becoming worn or frayed, replace it.

Wipe up any heavy spillovers on the oven bottom.

Make sure the oven light bulb cover is in place and the oven light is off.

IMPORTANT: The health of some birds is extremely sensitive to the fumes given off during the self-cleaning cycle of any range. Move birds to another well-ventilated room.

NOTE: Use caution when opening the upper oven after the self-clean cycle has ended. The oven may still be hot.

How to Set the Upper Oven for Cleaning

For the self-clean cycle to operate, the **RANGE LOCKOUT** must be off. See the *Range Lockout* section.

- 1 Touch the **SELF CLEAN** pad.
- 2 Using the number pads, enter the desired clean time, if a time other than 4 hours is needed.

Clean cycle time is normally 4 hours. You can change the clean time to any time between 3 hours and 5 hours, depending on how dirty your oven is.

- 3 Touch the **START** pad.

NOTE: The surface units should be turned off during the self-clean cycle.

The door locks automatically. The display will show the clean time remaining. It will not be possible to open the oven door until the temperature drops below the lock temperature and the **LOCKED DOOR** light goes off.

The oven shuts off automatically when the clean cycle is complete.

- 4 When the **LOCKED DOOR** light is off, the door will unlock automatically.

n The words **LOCK DOOR** will flash and the oven control will signal if you set the clean cycle and forget to close the oven door.

n To stop a clean cycle, touch the **CLEAR/OFF** pad. When the **LOCKED DOOR** light goes off indicating the oven has cooled below the locking temperature, you may open the door.

n Do not use the lower oven drawer during a self-clean cycle.

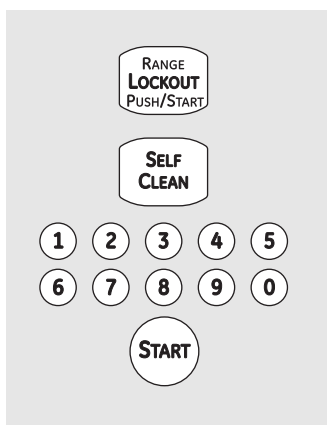

Using the self-cleaning upper oven.

The oven door must be closed and all controls set correctly for the cycle to work properly.

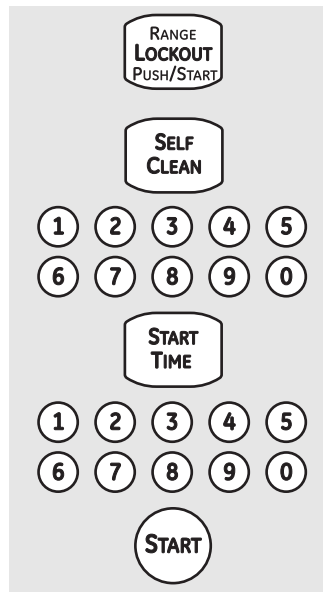

How to Delay the Start of Cleaning

Make sure the clock shows the correct time of day.

- 1 Touch the **RANGE LOCKOUT** pad and then the **START** pad to turn it off. See the *Range Lockout* section.
- NOTE:** The surface units must be turned off prior to the self-clean start time.
- 2 Touch the **SELF CLEAN** pad.
- 3 Using the number pads, enter the desired clean time.
- 4 Touch the **START TIME** pad. The earliest start time you can set will appear in the display.
- 5 Using the number pads, enter the time of day you want the clean cycle to start.
- 6 Touch the **START** pad.

The door locks automatically. The display will show the start time. It will not be possible to open the oven door until the temperature drops below the lock temperature and the **LOCKED DOOR** light goes off.

The oven shuts off automatically when the clean cycle is complete.

- 7 When the **LOCKED DOOR** light is off, the door will unlock automatically.
- n The words **LOCK DOOR** will flash and the oven control will signal if you set the clean cycle and forget to close the oven door.
- n To stop a clean cycle, touch the **OFF** pad. When the **LOCKED DOOR** light goes off indicating the oven has cooled below the locking temperature, you may open the door.

After a Clean Cycle

You may notice some white ash in the oven. Wipe it up with a damp cloth after the oven cools.

If white spots remain, remove them with a soap-filled scouring pad and rinse thoroughly with a vinegar and water mixture.

These deposits are usually a salt residue that cannot be removed by the clean cycle.

If the oven is not clean after one clean cycle, repeat the cycle.

- n You cannot set the oven for cooking until the oven is cool enough for the door to unlock.
- n While the oven is self-cleaning, you can touch the **CLOCK** pad to display the time of day. To return to the clean countdown, touch the **COOK TIME** pad.
- n If the racks become hard to slide, apply a small amount of vegetable oil or cooking oil to a paper towel and wipe the edges of the oven racks with the paper towel.

Be sure electrical power is off and all surfaces are cool before cleaning any part of the range.

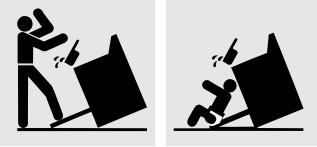

If your range is removed for cleaning, servicing or any reason, be sure the anti-tip device is re-engaged properly when the range is replaced. Failure to take this precaution could result in tipping of the range and cause injury.

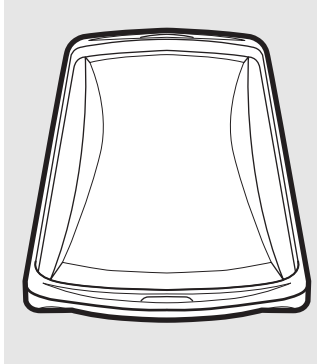

Lodge® Cast Iron Griddle

- 1 Rinse with hot water (do not use soap), and dry thoroughly.
- 2 Before cooking, prepare the surface with cooking spray or vegetable oil.
- 3 After cooking, clean the griddle with a stiff brush and hot water. Using soap is not recommended, and harsh detergents should never be used.
- 4 Towel dry immediately and apply a light coat of cooking spray or vegetable oil while the griddle is still warm.
- 5 Store in a cool, dry place.
- 6 Do not wash in a dishwasher.

Griddle Precautions:

- n If something has spilled under the griddle, it should be cleaned up as soon as possible to prevent "baked on" food soil. See the *Cleaning the glass cooktop* section.
- n Do not allow grease to accumulate under the griddle as it can be a fire hazard. Clean under the griddle as soon as it is cool. See the *Cleaning the glass cooktop* section.
- n Do not place your griddle in the microwave.
- n Always turn off all surface units before removing the griddle. Use caution when handling a hot griddle.

Stainless Steel Surfaces

Protecting

STAINLESS STEEL has a reputation for withstanding tough abuse for years. This is a key reason why it is so popular with the food service industry.

However, stainless steel appliances can have surface imperfections, discolorations or blemishes that consumers with a critical eye notice and find unattractive in the home. These discolorations or blemishes can be caused by something as simple as leaving fingerprint smudges on the stainless steel surface overnight.

For stainless steel appliances where blemishes are prone to show on the surface, we recommend APPLYING A COAT OF CERAMA BRYTE® Stainless Steel Cleaning Polish & Conditioner (purchased separately—follow instructions).

This will help you to maintain the brightness and appearance of your stainless steel appliance.

Cleaning

Do not use a steel wool pad; it will scratch the surface.

- n In order to avoid any discolorations and/or grease stains, we recommend cleaning and removing any spills, spots and grease from the range after use.
- n It is important to use a soft cloth or paper towel every time the range is cleaned to avoid any scratches.

Read carefully the instructions on the back of the Brightener (included with your range) for better results.

Cleaning Instructions:

- 1 Wash using warm, soapy water: Wet soft cloth or paper towel (avoid using excessive water). Wipe the surface in the direction of the grain (following the steel lines). Rinse and wring out a soft cloth or paper towel and dry the range.
- 2 Apply a degreaser that does not contain sodium hydroxide or Stainless Steel Cleaner (follow instructions).
- 3 Apply Cerama Bryte® Stainless Steel Brightener (follow instructions).
- 4 Repeat steps 2–4 as many times as needed.

Follow these instructions for any Stainless Steel surface on your range.

DO NOT USE the following products for cleaning the Cooktop or Stainless Steel parts:

- Caustic Lye (Sodium Hydroxide) or cleaners containing this chemical
- Hard or Steel Wool Pads
- Abrasive Materials or Chemicals

To inquire about purchasing stainless steel appliance cleaner or polish, or to find the location of a dealer nearest you, please call our toll-free number:

National Parts Center
1.800.661.1616 (Canada)
www.GEAppliances.ca

Care and cleaning of the range.

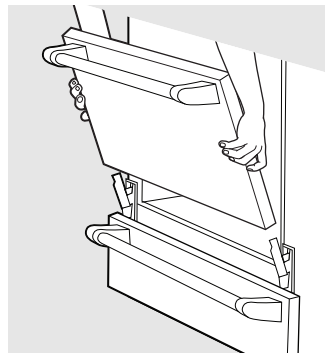

Lift the door straight up and off the hinges.

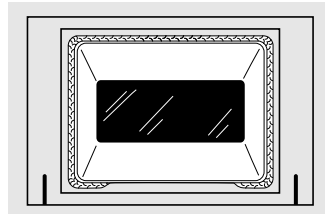

The gasket is designed with a gap at the bottom to allow for proper air circulation.

Do not rub or clean the door gasket—it has an extremely low resistance to abrasion.

If you notice the gasket becoming worn, frayed or damaged in any way or if it has become displaced on the door, you should have it replaced.

Lift-Off Oven Door

The oven door is removable, but it is heavy. You may need help removing and replacing the door.

Do not lift the door by the handle. Make sure the oven is completely cool.

To remove the door, open it a few inches to the special stop position that will hold the door open. Grasp firmly on each side and lift the door straight up and off the hinges.

NOTE: Be careful not to place hands between the hinge and the oven door frame as the hinge could snap back and pinch fingers.

To replace the door, make sure the hinges are in the special stop position. Position the slots in the bottom of the door squarely over the hinges. Then lower the door slowly and evenly over both hinges at the same time. If the hinges snap back against the oven frame, pull them back out.

To clean the inside of the door:

- n Do not allow excess water to run into any holes or slots in the door.
- n Because the area inside the gasket is cleaned during the self-clean cycle, you do not need to clean this by hand. Any soap left on the liner causes additional stains when the oven is heated.

- n The area outside the gasket can be cleaned with a soap-filled plastic scouring pad.

Do not allow food spills with a high sugar or acid content (such as milk, tomatoes, sauerkraut, fruit juices or pie filling) to remain on the surface. They may cause a dull spot even after cleaning.

To clean the outside of the door:

- n Use soap and water to thoroughly clean the top, sides and front of the oven door. Rinse well. You may also use a glass cleaner to clean the glass on the outside of the door.
- n Spillage of marinades, fruit juices, tomato sauces and basting materials containing acids may cause discoloration and should be wiped up immediately. When the surface is cool, clean and rinse.
- n Do not use oven cleaners, cleansing powders or harsh abrasives on the outside of the door.

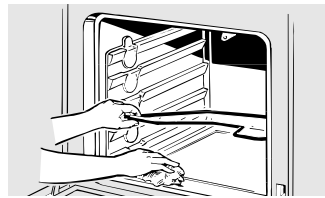

Oven Heating Elements

Do not clean the bake element or the broil element. Any soil will burn off when the elements are heated.

To clean the oven floor, gently lift the bake element. Clean with warm soapy water.

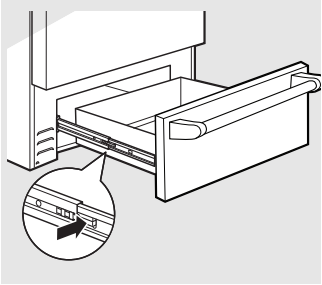

Removable Lower Oven Drawer

NOTE: Before performing any adjustments, cleaning or service, disconnect the range electrical power supply at the household distribution panel by removing the fuse or switching off the circuit breaker. Make sure the drawer heating element is cool.

Most cleaning can be done with the drawer in place. However, the drawer may be removed if further cleaning is needed. Use soap and warm water to thoroughly clean.

To remove the drawer:

- 1 Pull the drawer straight out until it stops.
- 2 Press the tabs on both sides in, while pulling the drawer forward and free.

To replace the drawer:

- 1 Place the left drawer rail around the inner left rail guide and slide it in slightly to hook it.
- 2 Place the right drawer rail around the inner right rail guide and slide it in slightly to hook it.
- 3 Slide the drawer all the way in.

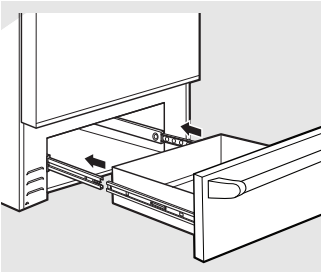

Removable Lower Oven Drawer Pan

NOTE: Before performing any adjustments, cleaning or service, disconnect the range electrical power supply at the household distribution panel by removing the fuse or switching off the circuit breaker. Make sure the drawer heating element is cool.

NOTE: Allow lower oven drawer to cool before removing pan.

NOTE: Wipe spills promptly after each use.

- n Never place, use or self-clean the lower oven drawer pan in the upper oven.
- n Lower oven drawer has a removable pan for easy cleaning. Clean with hot, soapy water and a sponge or dish towel. Dry with a clean cloth. An oven cleaner, such as Easy-Off®, may also be used. Be sure to follow the directions on the oven cleaner. Replace the pan in the lower oven drawer.

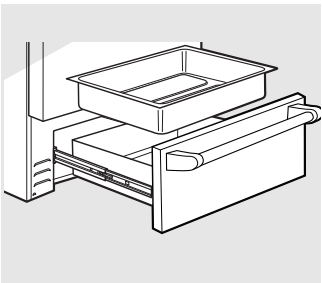

Glass Window

To clean the outside glass finish, use a glass cleaner. Rinse and polish with a dry cloth.

Care and cleaning of the range.

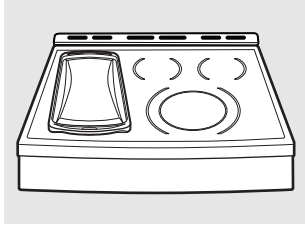

Vent appearance and location vary.

Oven Air Vents

Never block the vents (air openings) of the range. They provide the air inlet and outlet that are necessary for the range to operate properly.

Air openings are located at the rear of the cooktop, at the top and bottom of the oven door, and at the bottom of the range, under the lower oven drawer.

Oven Control Panel

Lock out the touch pads before cleaning.

See the *Range Lockout* information in the *Special features of your oven control* section in this manual.

Clean up splatters with a damp cloth.

You may also use a glass cleaner.

Remove heavier soil with warm soapy water. Do not use abrasives of any kind.

Unlock the touch pads after cleaning.

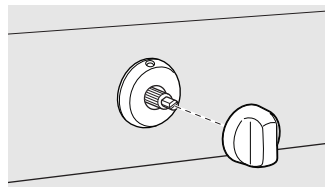

Surface unit knob

Control Panel and Knobs

It's a good idea to wipe the control panel after each use of the oven. Clean with mild soap and water or vinegar and water, rinse with clean water and polish dry with a soft cloth.

Do not use abrasive cleansers, strong liquid cleaners, plastic scouring pads or oven cleaners on the control panel—they will damage the finish. A 50/50 solution of vinegar and hot water works well.

The control knobs may be removed for easier cleaning.

Make sure the knobs are in the **OFF** positions and pull them straight off the stems for cleaning.

The knobs can be washed with soap and water. Make sure the insides of the knobs are dry before replacing.

NOTES:

- n Do not wash the knobs in an automatic dishwasher.
- n Do not use any chemical or abrasive substances to clean the knobs—they could be permanently damaged.

Replace the knobs in the **OFF** position to ensure proper placement.

Metal parts can be cleaned with soap and water. Do not use steel wool, abrasives, ammonia, acids or commercial oven cleaners. Dry with a soft cloth.

NOTE: The lower oven drawer control knob is not interchangeable with the surface unit knobs. Be sure to reinstall the lower oven drawer knob to the original location. The lower oven drawer knob may be identified by the increasing numbers from "WM" to "450."

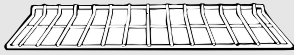

Oven Racks and Drawer Racks

Clean the racks with an abrasive cleanser.

The oven racks may be cleaned in the self-cleaning oven. However, the racks will darken in color, lose their luster and become hard to slide if cleaned during the self-cleaning cycle.

To make the racks slide more easily, apply a small amount of vegetable oil or cooking oil to a paper towel and wipe the edges of the oven racks with the paper towel.

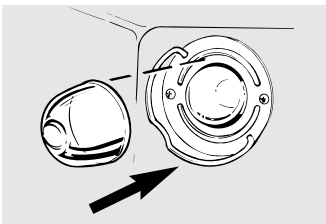

Wire cover holder.

Oven Light Replacement

CAUTION: Before replacing your oven light bulb, disconnect the electrical power to the range at the main fuse or circuit breaker panel. Be sure to let the light cover and bulb cool completely.

The oven light bulb is covered with a removable glass cover that is held in place with a bail-shaped wire. Remove the oven door, if desired, to reach cover easily.

To remove:

- 1 Hold a hand under the cover so it doesn't fall when released. With fingers of the same hand, firmly push back the wire cover holder. Lift off the cover.

Do not remove any screws to remove the cover.

- 2 Do not touch hot bulb with a wet cloth. Replace bulb with a 40-watt household appliance bulb.

To replace cover:

- 1 Place it into the groove of the light receptacle. Pull the wire forward to the center of the cover until it snaps into place. When in place, the wire holds the cover firmly. Be certain the wire is in the depression in the center of the cover.
- 2 Connect electrical power to the range.

Cleaning the glass cooktop.



Clean your cooktop after each spill. Use CERAMA BRYTE® Ceramic Cooktop Cleaner.

Normal Daily Use Cleaning

ONLY use CERAMA BRYTE® Ceramic Cooktop Cleaner on the glass cooktop. Other creams may not be as effective.

To maintain and protect the surface of your glass cooktop, follow these steps:

- 1 Before using the cooktop for the first time, clean it with CERAMA BRYTE® Ceramic Cooktop Cleaner. This helps protect the top and makes cleanup easier.
- 2 Daily use of CERAMA BRYTE® Ceramic Cooktop Cleaner will help keep the cooktop looking new.

- 3 Shake the cleaning cream well. Apply a few drops of CERAMA BRYTE® Ceramic Cooktop Cleaner directly to the cooktop.
- 4 Use a paper towel or CERAMA BRYTE® Cleaning Pad for Ceramic Cooktops to clean the entire cooktop surface.
- 5 Use a dry cloth or paper towel to remove all cleaning residue. No need to rinse.

NOTE: It is very important that you **DO NOT** heat the cooktop until it has been cleaned thoroughly.

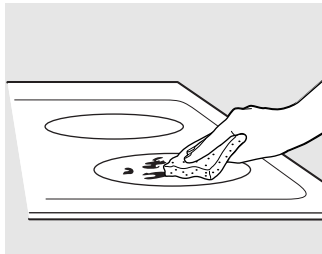

Use a CERAMA BRYTE® Cleaning Pad for Ceramic Cooktops.

Burned-On Residue

WARNING: DAMAGE to your glass surface may occur if you use scrub pads other than those recommended.

- 1 Allow the cooktop to cool.
- 2 Spread a few drops of CERAMA BRYTE® Ceramic Cooktop Cleaner on the entire burned residue area.
- 3 Using the included CERAMA BRYTE® Cleaning Pad for Ceramic Cooktops, rub the residue area, applying pressure as needed.

- 4 If any residue remains, repeat the steps listed above as needed.
- 5 For additional protection, after all residue has been removed, polish the entire surface with CERAMA BRYTE® Ceramic Cooktop Cleaner and a paper towel.

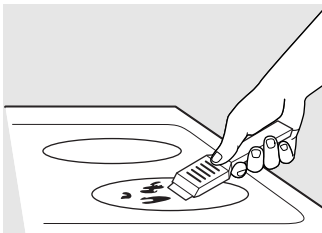

The CERAMA BRYTE® Ceramic Cooktop Scraper and all recommended supplies are available through our Parts Center. See instructions under "To Order Parts" section on next page.

NOTE: Do not use a dull or nicked blade.

Heavy, Burned-On Residue

- 1 Allow the cooktop to cool.
- 2 Use a single-edge razor blade scraper at approximately a 45° angle against the glass surface and scrape the soil. It will be necessary to apply pressure to the razor scraper in order to remove the residue.
- 3 After scraping with the razor scraper, spread a few drops of CERAMA BRYTE® Ceramic Cooktop Cleaner on the entire burned residue area. Use the CERAMA BRYTE® Cleaning Pad to remove any remaining residue.

- 4 For additional protection, after all residue has been removed, polish the entire surface with CERAMA BRYTE® Ceramic Cooktop Cleaner and a paper towel.

Metal Marks and Scratches

- 1 Be careful not to slide pots and pans across your cooktop. It will leave metal markings on the cooktop surface.
These marks are removable using the CERAMA BRYTE® Ceramic Cooktop Cleaner with the CERAMA BRYTE® Cleaning Pad for Ceramic Cooktops.

- 2 If pots with a thin overlay of aluminum or copper are allowed to boil dry, the overlay may leave black discoloration on the cooktop. This should be removed immediately before heating again or the discoloration may be permanent.

WARNING: Carefully check the bottom of pans for roughness that would scratch the cooktop.

Cooktop Seal

To clean the cooktop seal around the edges of the glass, lay a wet cloth on it

for a few minutes, then wipe clean with nonabrasive cleaners.

Glass surface—potential for permanent damage.

Our testing shows that if you are cooking high sugar mixtures such as jelly or fudge and have a spillover, it can cause permanent damage to the glass surface unless the spillover is immediately removed.

Damage from Sugary Spills and Melted Plastic

- 1 Turn off all surface units. Remove hot pans.
- 2 Wearing an oven mitt:
 - a. Use a single-edge razor blade scraper (CERAMA BRYTE® Ceramic Cooktop Scraper) to move the spill to a cool area on the cooktop.
 - b. Remove the spill with paper towels.

- 3 Any remaining spillover should be left until the surface of the cooktop has cooled.
- 4 Don't use the surface units again until all of the residue has been completely removed.

NOTE: If pitting or indentation in the glass surface has already occurred, the cooktop glass will have to be replaced. In this case, service will be necessary.



To Order Parts

To order CERAMA BRYTE® Ceramic Cooktop Cleaner and the cooktop scraper, please call our toll-free number:

- National Parts Center 800.661.1616**
- CERAMA BRYTE® Ceramic Cooktop Cleaner # WX10X300**
- CERAMA BRYTE® Ceramic Cooktop Scraper # WX10X0302**
- Kit # WB64X5027**
(Kit includes cream and cooktop scraper)
- CERAMA BRYTE® Cleaning Pads for Ceramic Cooktops # WX10X350**

Installation Instructions

Free-Standing Electric Ranges

? Questions? Call 1.800.561.3344 or Visit our Website at: www.GEAppliances.ca

BEFORE YOU BEGIN

Read these instructions completely and carefully.

- **IMPORTANT** – Save these instructions for local inspector's use.
- **IMPORTANT** – Observe all governing codes and ordinances.
- **Note to Installer** – Be sure to leave these instructions with the Consumer.
- **Note to Consumer** – Keep these instructions for future reference.
- **Skill level** – Installation of this appliance requires basic mechanical skills.
- **Completion time** – 1 to 3 hours
- Proper installation is the responsibility of the installer.
- Product failure due to improper installation is not covered under the Warranty.

⚠ WARNING – This appliance must be properly grounded.

FOR YOUR SAFETY:

⚠ WARNING – Before beginning the installation, switch power off at service panel and lock the service disconnecting means to prevent power from being switched on accidentally. When the service disconnecting means cannot be locked, securely fasten a prominent warning device, such as a tag, to the service panel.

FOR YOUR SAFETY:

All rough-in and spacing dimensions must be met for safe use of your range. Electricity to the range can be disconnected at the outlet without moving the range if the outlet is in the preferred location (remove lower drawer).

To reduce the risk of burns or fire when reaching over hot surface elements, cabinet storage space above the cooktop should be avoided. If cabinet storage space is to be provided above the cooktop, the risk can be reduced by installing a range hood that sticks out at least 5" beyond the front of the cabinets. Cabinets installed above a cooktop must be no deeper than 13".

Be sure your appliance is properly installed and grounded by a qualified technician.

Make sure the cabinets and wall coverings around the range can withstand the temperatures (up to 200°F) generated by the range.

ANTI-TIP DEVICE

⚠ WARNING – To reduce the risk of tipping, the appliance must be secured by properly installed Anti-Tip bracket packed with this appliance.

If the Anti-Tip device supplied with the range does not fit this application, use the universal Anti-Tip device WB2X7909.



⚠ WARNING –

- All ranges can tip
- Injury to persons could result
- Install Anti-Tip bracket packed with range
- See Installation Instructions



If you pull the range out and away from the wall for any reason, make sure the Anti-Tip bracket is engaged when the range is pushed back against the wall.

Installation Instructions

PREPARE TO INSTALL THE RANGE

MATERIALS YOU MAY NEED

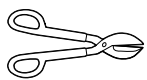

Tin Snips



Lag Bolts

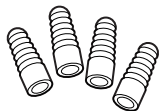

Anchor Sleeves

(For Anti-Tip Bracket Mounted on Concrete Floors Only)



(UL Approved 40 AMP)

4-Wire Cord **OR** 3-Wire Cord
4' Long 4' Long

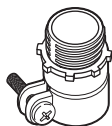

Squeeze Connector
(For Conduit Installations Only)

TOOLS YOU WILL NEED



Phillips Screwdriver



Flat-blade Screwdriver



Adjustable Wrench

PARTS INCLUDED

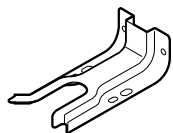

Anti-Tip Bracket Kit

1 REMOVE SHIPPING MATERIALS

Remove packaging materials. Failure to remove packaging materials could result in damage to the appliance.

2 PREPARE THE OPENING

Allow 1½" spacing from the range to adjacent vertical walls above the cooktop surface.

Allow 30" minimum clearance between the surface units and the bottom of unprotected wood or metal top cabinet, and 15" minimum between the countertop and adjacent cabinet bottom.

EXCEPTION: Installation of a listed microwave oven or cooking appliance over the cooktop shall conform to the installation instructions packed with that appliance.

If cabinet storage is installed, reduce the risk by installing a range hood that projects horizontally a min. of 5" beyond the bottom of the cabinets. Make sure the wall covering, countertops and cabinets around the range can withstand heat generated by the range, oven or cooktop up to 200°F.

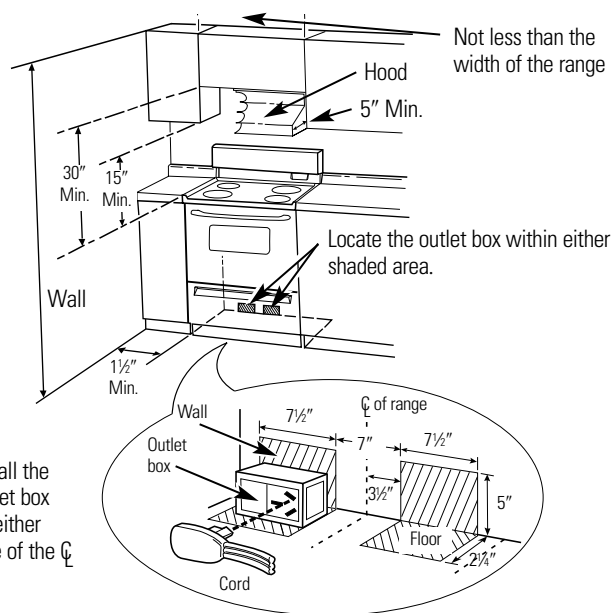

Flooring under the range

Your range, like many other household items, is heavy and can settle into soft floor coverings such as cushioned vinyl or carpeting.

When moving the range on this type of flooring, it should be installed on a ¼" thick sheet of plywood (or similar material) as follows:

When the floor covering ends at the front of the range, the area that the range will rest on should be built up with plywood to the same level or higher than the floor covering. This will allow the range to be moved for cleaning or servicing.

Installation Instructions

3 LEVEL THE RANGE

A Install the oven racks in the oven and position the range where it will be installed.

B Check for levelness by placing a spirit level or a cup, partially filled with water, on one of the oven racks. If using a spirit level, take two readings—with the level placed diagonally first in one direction and then the other.

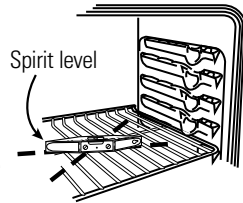

C The rear leveling legs must be adjusted prior to moving the range into position. They can be adjusted from the bottom at the back of the range.

Adjust from the bottom back of range (warming drawer models)

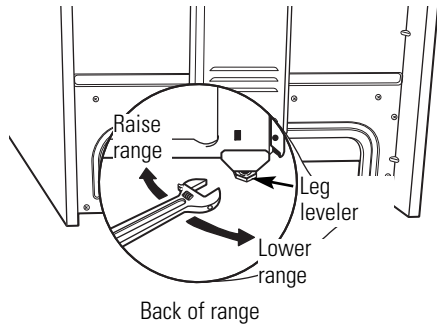

D Use an open-end or adjustable wrench to adjust the leveling legs until the range is level.

E Replace the drawer or panel.

4 FINAL INSTALLATION CHECKLIST

- Check to make sure the circuit breaker is closed (RESET) or the circuit fuses are replaced.
- Be sure power is in service to the building.
- **Note (on some models):** If the clock flashes "bAd" and then "LinE" with a loud tone, the neutral connection to the range is not wired correctly. Check the terminal block connections and/or house wiring to correct.
- Check to be sure that all packing materials and tape have been removed. This will include tape on metal panel under control knobs (if applicable), adhesive tape, wire ties, cardboard and protective plastic. Failure to remove these materials could result in damage to the appliance once the appliance has been turned on and surfaces have heated.
- Check to make sure that the rear leveling leg is fully inserted into the Anti-Tip bracket and that the bracket is securely installed.

5 OPERATION CHECKLIST

- Turn on one of the surface units to observe that the element glows within 60 seconds. Turn the unit off when glow is detected. If the glow is not detected within the time limit, recheck the range wiring connections. If change is required, retest again. If no change is required, have building wiring checked for proper connections and voltage.
- Check to make sure the Clock (on models so equipped) display is energized. If a series of horizontal red lines appear in the display, disconnect power immediately. Recheck the range wiring connections. If change is made to connections, retest again. If no change is required, have building wiring checked for proper connections and voltage. It is recommended that the clock be changed if the red lines appear.
- Be sure all range controls are in the OFF position before leaving the range.

Safety Instructions

Operating Instructions

Care and Cleaning

Installation Instructions

Troubleshooting Tips

Consumer Support

Before you call for service...



Troubleshooting Tips

Save time and money! Review the charts on the following pages first and you may not need to call for service.

| Problem | Possible Causes | What To Do |
|--|---|---|
| Surface units will not maintain a rolling boil or cooking is not fast enough | Improper cookware being used. | <ul style="list-style-type: none"> Use pans which are flat and match the diameter of the surface unit selected. |
| | Surface units do not work properly | <ul style="list-style-type: none"> Check to see the correct control is set for the surface unit you are using. Replace the fuse or reset the circuit breaker. |
| Scratches (may appear as cracks) on cooktop glass surface | Incorrect cleaning methods being used. | <ul style="list-style-type: none"> Scratches are not removable. Tiny scratches will become less visible in time as a result of cleaning. To avoid scratches, use the recommended cleaning procedures. Make sure bottoms of cookware are clean before use, and use cookware with smooth bottoms. |
| | Cookware with rough bottoms being used or coarse particles (salt or sand) were between the cookware and the surface of the cooktop. Cookware has been slid across the cooktop surface. | |
| Areas of discoloration on the cooktop | Food spillovers not cleaned before next use. | <ul style="list-style-type: none"> See the <i>Cleaning the glass cooktop</i> section. |
| | Hot surface on a model with a light colored glass cooktop. | <ul style="list-style-type: none"> This is normal. The surface may appear discolored when it is hot. This is temporary and will disappear as the glass cools. |
| Plastic melted to the surface | Hot cooktop came into contact with plastic placed on the hot cooktop. | <ul style="list-style-type: none"> See the <i>Glass surface—potential for permanent damage</i> section in the <i>Cleaning the glass cooktop</i> section. |
| Pitting (or indentation) of the cooktop | Hot sugar mixture spilled on the cooktop. | <ul style="list-style-type: none"> Call a qualified technician for replacement. |
| Frequent cycling off and on of surface units | Improper cookware being used. | <ul style="list-style-type: none"> Use only flat cookware to minimize cycling. |
| Control signals after entering cooking time or delay start | You forgot to enter a bake temperature or cleaning time. | <ul style="list-style-type: none"> Press the BAKE pad and desired temperature or the SELF CLEAN pad and desired clean time. |
| Food does not bake or roast properly | Oven controls improperly set. | <ul style="list-style-type: none"> See the <i>Using the oven</i> section. |
| | Rack position is incorrect or the rack is not level. | <ul style="list-style-type: none"> See the <i>Using the oven</i> section. |
| | Incorrect cookware or cookware of improper size being used. | <ul style="list-style-type: none"> See the <i>Using the oven</i> section. |
| | Oven thermostat needs adjustment. | <ul style="list-style-type: none"> See the <i>Adjust the oven thermostat—Do it yourself!</i> section. |

| Problem | Possible Causes | What To Do |
|---|--|---|
| "Close Door" scrolls in the display when BROIL is set | The display will always automatically remind you to close the door. | <ul style="list-style-type: none"> This is a normal reminder to close the door when broiling. |
| Food does not broil properly in the upper oven | Oven controls improperly set. | <ul style="list-style-type: none"> Make sure you touch the BROIL HI/LO pad. |
| | Oven door not closed. | <ul style="list-style-type: none"> See the <i>Using the upper oven</i> section. |
| | Improper rack position being used. | <ul style="list-style-type: none"> See the <i>Broiling Guide</i>. |
| | Food being cooked in a hot pan. | <ul style="list-style-type: none"> For best results, use a pan designed for broiling. Make sure it is cool. |
| | Cookware not suited for broiling. | <ul style="list-style-type: none"> For best results, use a pan designed for broiling. |
| | Oven bottom not securely seated in position. | <ul style="list-style-type: none"> See the <i>Installation of the range</i> section. |
| Upper oven temperature too hot or too cold | Oven thermostat needs adjustment. | <ul style="list-style-type: none"> See the <i>Adjust the oven thermostat—Do it yourself!</i> section. |
| Clock and timer do not work | Plug on range is not completely inserted in the electrical outlet. | <ul style="list-style-type: none"> Make sure electrical plug is plugged into a live, properly grounded outlet. |
| | A fuse in your home may be blown or the circuit breaker tripped. | <ul style="list-style-type: none"> Replace the fuse or reset the circuit breaker. |
| | Oven controls improperly set. | <ul style="list-style-type: none"> See the <i>Using the clock and timer</i> section. |
| Upper oven light does not work | Light bulb is loose or defective. | <ul style="list-style-type: none"> Tighten or replace the bulb. |
| | Plug on range is not completely inserted in the electrical outlet. | <ul style="list-style-type: none"> Make sure electrical plug is plugged into a live, properly grounded outlet. |
| Upper oven will not self-clean | The oven temperature is too high to set a self-clean operation. | <ul style="list-style-type: none"> Allow the range to cool to room temperature and reset the controls. |
| | Oven controls improperly set. | <ul style="list-style-type: none"> See the <i>Using the self-cleaning upper oven</i> section. |
| "Crackling" or "popping" sound | This is the sound of the metal heating and cooling during both the cooking and cleaning functions. | <ul style="list-style-type: none"> This is normal. |
| Excessive smoking | Excessive soil. | <ul style="list-style-type: none"> Touch the CLEAR/OFF pad. Open the windows to rid the room of smoke. Wait until the LOCKED DOOR light goes off. Wipe up the excess soil and reset the clean cycle. |
| Oven door will not open after a clean cycle | Oven too hot. | <ul style="list-style-type: none"> Allow the oven to cool below locking temperature. |

Before you call for service...



Troubleshooting Tips

| | Problem | Possible Causes | What To Do |
|---------------------------|---|--|---|
| Safety Instructions | | | |
| | | | |
| Operating Instructions | Oven not clean after a clean cycle | Oven controls not properly set. Oven was heavily soiled. | <ul style="list-style-type: none"> See the <i>Using the self-cleaning oven</i> section. Clean up heavy spillovers before starting the clean cycle. Heavily soiled ovens may need to self-clean again or for a longer period of time. |
| | "LOCK DOOR" flashes in the display | The self-clean cycle has been selected but the door is not closed. | <ul style="list-style-type: none"> Close the oven door. |
| Care and Cleaning | LOCKED DOOR light is on when you want to cook | The oven door is locked because the temperature inside the oven has not dropped below the locking temperature. | <ul style="list-style-type: none"> Touch the CLEAR/OFF pad. Allow the oven to cool. |
| | "F—and a number or letter" flash in the display | You have a function error code. If the function code repeats. | <ul style="list-style-type: none"> Touch the CLEAR/OFF pad. Allow the oven to cool for one hour. Put the oven back into operation. Disconnect all power to the range for 5 minutes and then reconnect power. If the function error code repeats, call for service. |
| Installation Instructions | "Probe" appears in the display | This is reminding you to enter a probe temperature after plugging in the probe. | <ul style="list-style-type: none"> Enter a probe temperature. |
| | Display goes blank | A fuse in your home may be blown or the circuit breaker tripped. The clock is in the black-out mode. | <ul style="list-style-type: none"> Replace the fuse or reset the circuit breaker. See the <i>Special features of your oven control</i> section. |
| Troubleshooting Tips | Display flashes | Power failure. | <ul style="list-style-type: none"> Reset the clock. |
| | Unable to get the display to show "SF" | Oven control pads were not pressed properly. | <ul style="list-style-type: none"> The BAKE and BROIL HI/LO pads must be touched at the same time and held for 3 seconds. |
| Consumer Support | Power outage, clock flashes | Power outage or surge. | <ul style="list-style-type: none"> Reset the clock. If the oven was in use, you must reset it by touching the CLEAR/OFF pad, setting the clock and resetting any cooking function. |
| | "Burning" or "oily" odor emitting from the vent | This is normal in a new oven and will disappear in time. | <ul style="list-style-type: none"> To speed the process, set a self-clean cycle for a minimum of 3 hours. See the <i>Using the self-cleaning oven</i> section. |
| Consumer Support | Strong odor | An odor from the insulation around the inside of the oven is normal for the first few times the oven is used. | <ul style="list-style-type: none"> This is temporary. |
| | LOC appears in the display | The Range Lockout feature is activated. | <ul style="list-style-type: none"> Be sure the surface unit controls are turned OFF. Turn this feature off to use the range. See the <i>Range Lockout</i> section. |

| Problem | Possible Causes | What To Do |
|--|---|--|
| Fan noise | The convection fan may turn on and off automatically. | <ul style="list-style-type: none"> This is normal. To maximize cooking evenness, the fan is designed to operate in both directions with a pause in between. |
| Convection fan not working | Preheat temperature not reached. | <ul style="list-style-type: none"> Fan will start automatically once the preheat temperature is reached. |
| Drawer does not slide smoothly or drags | The drawer is out of alignment. | <ul style="list-style-type: none"> Fully extend the drawer and push it all the way in. See the <i>Care and cleaning of the range</i> section. |
| | Drawer is overloaded or load is unbalanced. | <ul style="list-style-type: none"> Reduce weight. Redistribute drawer contents. |
| Lower oven drawer will not work | A fuse in your home may be blown or the circuit breaker tripped. | <ul style="list-style-type: none"> Replace the fuse or reset the circuit breaker. |
| | The upper oven is self-cleaning. | <ul style="list-style-type: none"> Wait for the self-clean cycle to finish and the oven to cool. |
| | Controls improperly set. | <ul style="list-style-type: none"> See the <i>Lower oven drawer</i> section. |
| Excessive condensation in the drawer | Liquid in drawer. | <ul style="list-style-type: none"> Remove liquid. |
| | Uncovered foods. | <ul style="list-style-type: none"> Cover food with lid or aluminum foil. |
| | Temperature setting too high. | <ul style="list-style-type: none"> Reduce temperature setting. |
| Food dries out in the lower oven drawer | Moisture escaping. | <ul style="list-style-type: none"> Cover food with lid or aluminum foil. |
| | Oven drawer not fully closed. | <ul style="list-style-type: none"> Push drawer in until latch engages. |

Accessories.

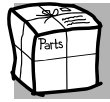

Looking For Something More?

You can find these accessories and many more at geappliances.ca, or call **800.661.1616** (during normal business hours). Have your model number ready.

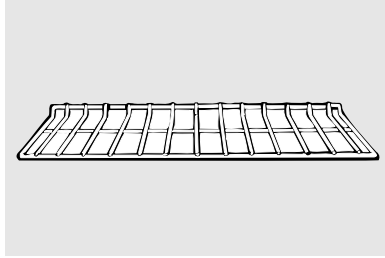

Oven Racks

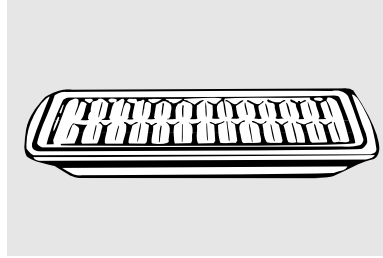

Broiler Pan

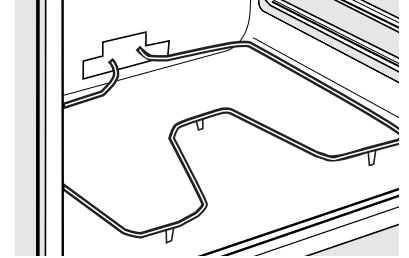

Oven Elements



Light Bulbs

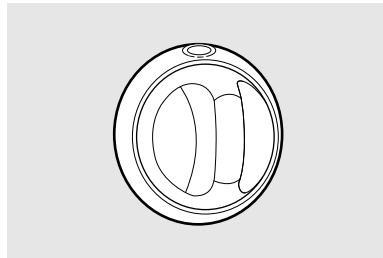

Knobs



Cleaner

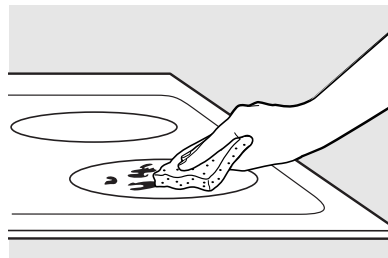

Cleaning Pads

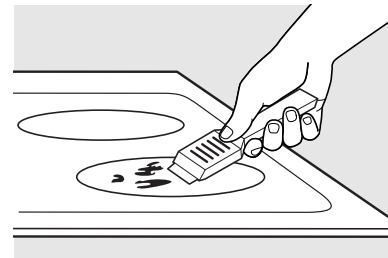

Scraper

Tired of discolored racks? Wishing you had extra-heavy-duty oven racks?

NOW AVAILABLE for your range:

GE's innovative, self-cleanable porcelain-coated oven racks!

- Heavy Duty
- Durable
- Able to be cleaned in a self-cleaning oven

Visit geappliances.ca for more information.

Please place in envelope and mail to:
Veuillez mettre dans une enveloppe et envoyez à :

**OWNERSHIP REGISTRATION
P.O. BOX 1780
MISSISSAUGA, ONTARIO
L4Y 4G1**

(FOR CANADIAN CONSUMERS ONLY)



For Canadian
Customers



Pour les
Consommateurs
Canadiens

CUT ALONG THIS LINE AND RETURN CARD—THANKS

OWNERSHIP REGISTRATION CERTIFICATE – FICHE D'INSCRIPTION DU PROPRIÉTAIRE

Please register your product to enable us to contact you in the remote event a safety notice is issued for this product and to allow for efficient communication under the terms of your warranty, should the need arise.

Veuillez enregistrer votre produit afin de nous permettre de communiquer avec vous si jamais un avis de sécurité concernant ce produit était émis et de communiquer facilement avec vous en vertu de votre garantie, si le besoin s'en fait sentir.

| | | | | | | |
|--|------------------------------------|---------------------------------|--------|------------------------------------|-----------------------------------|----------------------|
| REGISTER ON-LINE: | | www.geappliances.ca | | MAIL TO: | P.O. BOX 1780, MISSISSAUGA | |
| ENREGISTREMENT SUR INTERNET À: | | www.electromenagersqe.ca | | POSTER À: | ONTARIO, L4Y 4G1 | |
| <input type="checkbox"/> MR./M | <input type="checkbox"/> MRS./MME. | FIRST NAME / PRÉNOM | | LAST NAME / NOM | | |
| <input type="checkbox"/> MISS/MLE. | <input type="checkbox"/> MS. | | | | | |
| STREET NO / N° RUE | | STREET NAME / RUE | | | | APT. NO / APP. / RR# |
| CITY / VILLE | | | | PROVINCE | POSTAL CODE / POSTAL | |
| AREA CODE / IND. RÉG. | | TELEPHONE | E-MAIL | | | |
| DID YOU PURCHASE A SERVICE CONTRACT FOR THIS APPLIANCE? AVEZ-VOUS ACHETÉ UN CONTRAT DE SERVICE POUR CET APPAREIL ? | | | | YES / OUI <input type="checkbox"/> | IF YES / SI OUI: EXPIRATION | |
| | | | | NO / NON <input type="checkbox"/> | Y/A | M D/J |
| NAME OF SELLING DEALER / NOM DU MARCHAND | | | | MODEL / MODÈLE | | |
| INSTALLATION DATE / DATE D'INSTALLATION | | CORRESPONDENCE | | <input type="checkbox"/> ENGLISH | | |
| Y/A | M D/J | CORRESPONDANCE | | <input type="checkbox"/> FRANÇAIS | | |
| | | | | SERIAL / SÉRIE | | |
| <input type="checkbox"/> I do not wish to receive any promotional offers regarding this product. <input type="checkbox"/> Je ne désire pas recevoir d'offres promotionnelles concernant ce produit. | | | | | | |

GE Electric Range Warranty.



All warranty service provided by our Factory Service Centers or an authorized Customer Care® technician. For service, call 1.800.561.3344. Please have serial number and model number available when calling for service.

Staple your receipt here.
Proof of the original purchase date is needed to obtain service under the warranty.

For The Period Of: Mabe Will Replace:

One Year
From the date of the original purchase

Any part of the range which fails due to a defect in materials or workmanship. During this **limited one-year warranty**, Mabe will also provide, **free of charge**, all labor and in-home service to replace the defective part.

Five Years
From the date of the original purchase

A replacement glass cooktop if it should: crack due to thermal shock; discolor; crack at the rubber seal between the glass cooktop and the porcelain edge, or if the pattern wears off.
A replacement radiant surface unit if it should burn out.

During this **limited additional four-year warranty**, you will be responsible for any labor or in-home service.

What Mabe Will Not Cover:

- n Service trips to your home to teach you how to use the product.
- n Improper installation, delivery or maintenance.
- n Failure of the product if it is abused, misused, or used for other than the intended purpose or used commercially.
- n Damage to the glass cooktop caused by hardened spills of sugary materials or melted plastic that are not cleaned according to the directions in the Owner's Manual.
- n Damage to the glass cooktop caused by use of cleaners other than the recommended cleaning creams.
- n Replacement of house fuses or resetting of circuit breakers.
- n Damage to the product caused by accident, fire, floods or acts of God.
- n Incidental or consequential damage caused by possible defects with this appliance.
- n Damage caused after delivery.
- n Product not accessible to provide required service.

EXCLUSION OF IMPLIED WARRANTIES—Your sole and exclusive remedy is product repair as provided in this Limited Warranty. Any implied warranties, including the implied warranties of merchantability or fitness for a particular purpose, are limited to one year or the shortest period allowed by law.

WARRANTOR IS NOT RESPONSIBLE FOR CONSEQUENTIAL DAMAGES.

Warrantor: MABE CANADA INC.

Safety Instructions

Operating Instructions

Care and Cleaning

Installation Instructions

Troubleshooting Tips

Consumer Support

Consumer Support.



GE Appliances Website

www.GEAppliances.ca

Have a question or need assistance with your appliance? Try the GE Appliances Website 24 hours a day, any day of the year! For greater convenience and faster service, you can now download Owner's Manuals on-line.

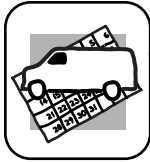

Schedule Service

www.GEAppliances.ca

Expert GE repair service is only one step away from your door. Call 1.800.561.3344, 7 days a week.

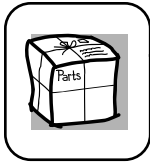

Parts and Accessories

www.GEAppliances.ca

To inquire about purchasing a part or an accessory for your appliance, call our National Parts Centre at 1.800.661.1616.

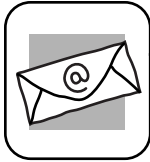

Contact Us

www.GEAppliances.ca

If you are not satisfied with the service you receive from GE, contact us on our Website with all the details including your phone number, or write to:

Mabe Canada Inc.
1 Factory Lane
Moncton, New Brunswick
E1C 9M3



Register Your Appliance

www.GEAppliances.ca

Register your new appliance on-line—at your convenience! Timely product registration will allow for enhanced communication and prompt service under the terms of your warranty, should the need arise. You may also mail in the preprinted registration card included in the packing material.

Free Manuals Download Website

<http://myh66.com>

<http://usermanuals.us>

<http://www.somanuals.com>

<http://www.4manuals.cc>

<http://www.manual-lib.com>

<http://www.404manual.com>

<http://www.luxmanual.com>

<http://aubethermostatmanual.com>

Golf course search by state

<http://golfingnear.com>

Email search by domain

<http://emailbydomain.com>

Auto manuals search

<http://auto.somanuals.com>

TV manuals search

<http://tv.somanuals.com>