



Use and Care Guide

Built-in Oven

Contents

Aluminum Foil	4,15	Roasting, Roasting Guide	12-14
Appliance Registration	2	Safety Instructions	2-4
Baking, Baking Guide	9,10,11	Self-Cleaning Instructions	18-20
Broiling, Broiling Guide	15,16	Shelves	8,21
Care and Cleaning	17-21	Thermostat Adjustment	20
Clock/Timer	7	Warranty	Back Cover
Consumer Services	23		
Energy-Saving Tips	4		
Features	5,6		
Light; Bulb Replacement	17,22		
Model and Serial Numbers	2		
Oven Control	6,7		
Probe	13,14,21	GE Answer Center®	
Problem Solver	22	800.626.2000	

**Models JKP44GP
JKP45WP**

GE Appliances

Help us help you...

Before using your oven, read this book carefully.

It is intended to help you operate and maintain your new oven properly.

Keep it handy for answers to your questions.

If you don't understand something or need more help, write (include your phone number):

Consumer Affairs
GE Appliances
Appliance Park
Louisville, KY 40225

Write down the model and serial numbers.

You'll find them on a label on the front of the oven behind the oven door.

These numbers are also on the Consumer Product Ownership Registration Card that came with your oven. Before sending in this card, please write these numbers here:

Model Number

Serial Number

Use these numbers in any correspondence or service calls concerning your oven.

Save time and money. Before you request service...

Check the Problem Solver in the back of this book. It lists causes of minor operating problems that you can correct yourself.

If you need service...

To obtain service, see the Consumer Services page in the back of this book.

We're proud of our service and want you to be pleased. If for some reason you are not happy with the service you receive, here are three steps to follow for further help.

FIRST, contact the people who serviced your appliance. Explain why you are not pleased. In most cases, this will solve the problem.

NEXT, if you are still not pleased, write all the details—including your phone number—to:

Manager, Consumer Relations
GE Appliances
Appliance Park
Louisville, KY 40225

FINALLY, if your problem is still not resolved, write:

Major Appliance Consumer
Action Panel
20 North Wacker Drive
Chicago, IL 60606

IMPORTANT SAFETY INSTRUCTIONS

Read all instructions before using this appliance.

IMPORTANT SAFETY NOTICE

The California Safe Drinking Water and Toxic Enforcement Act requires the Governor of California to publish a list of substances known to the state to cause birth defects or other reproductive harm, and requires businesses to warn customers of potential exposure to such substances.

The fiberglass insulation in self-cleaning ovens gives off a very small amount of carbon monoxide during the cleaning cycle. Exposure can be minimized by venting with an open window or using a ventilation fan or hood.

When You Get Your Oven

• **Have the installer show you the location of the circuit breaker or fuse.** Mark it for easy reference.

• **Be sure your appliance is properly installed and grounded** by a qualified technician in accordance with the provided Installation Instructions.

• **Don't attempt to repair or replace any part of your oven unless it is specifically recommended in this book.** All other servicing should be referred to a qualified technician.

• **Before performing any service, DISCONNECT THE OVEN POWER SUPPLY AT THE HOUSEHOLD DISTRIBUTION PANEL BY REMOVING THE FUSE OR SWITCHING OFF THE CIRCUIT BREAKER.**

● **Do not leave children alone—** Children should not be left alone or unattended in an area where appliance is in use. They should never be allowed to sit or stand on any part of the appliance.

• **Don't allow anyone to climb, stand or hang on the door.** They could damage the oven.

• **CAUTION: ITEMS OF INTEREST TO CHILDREN SHOULD NOT BE STORED IN CABINETS ABOVE AN OVEN. CHILDREN CLIMBING ON THE OVEN TO REACH ITEMS COULD BE SERIOUSLY INJURED.**

• **Never wear loose-fitting or hanging garments while using the appliance.** Be careful when reaching for items stored in cabinets over the oven. Flammable material could be ignited if brought in contact with hot heating elements and may cause severe burns.

• **DO NOT STORE OR USE COMBUSTIBLE MATERIALS, GASOLINE OR OTHER FLAMMABLE VAPORS AND LIQUIDS IN THE VICINITY OF THIS OR ANY OTHER APPLIANCE.**

• **Use only dry pot holders—** Moist or damp pot holders on hot surfaces may result in burns

from steam. Do not let potholders touch hot heating elements. Do not use a towel or other bulky cloth.

• **For your safety, never use your appliance for warming or heating the room.**

• **Storage in or on appliance—** Do not store flammable materials in the oven.

• **Keep hood and grease filters clean** to maintain good venting and to avoid grease fires.

• **Do not let cooking grease or other flammable materials accumulate in or near the oven.**

• **Do not use water on grease fires. Flame in oven can be smothered by completely closing door and touching the CLEAR/OFF pad or use dry chemical or foam type extinguisher.**

• **Do not touch heating elements or interior surface of oven.** These surfaces may be hot enough to burn even though they are dark in color. During and after use, do not touch, or let clothing or other flammable materials contact any interior area of the oven; allow sufficient time for cooling, first.

Potentially hot surfaces include the oven vent openings and surfaces near the openings, crevices around the oven door, the edges of the door window and the metal trim above door.

Remember: The inside surface of the oven may be hot when the door is opened.

• **When cooking pork,** follow the directions exactly and always cook the meat to an internal temperature of at least 170°F. This assures that, in the remote possibility that trichina may be present in the meat, it will be killed and the meat will be safe to eat.

Oven

• **Stand away from oven when opening oven door.** The hot air or steam which escapes can burn hands, face and/or eyes.

• **Don't heat unopened food containers in the oven.** Pressure could build up and the container could burst, causing an injury.

• **Keep oven vent ducts unobstructed.**

• **Keep oven free from grease buildup.**

• **Place oven shelf in desired position while oven is cool.** If shelves must be handled when hot, do not let pot holder contact heating units in the oven.

• **Pulling out shelf to shelf stop is a convenience in lifting heavy foods. It is also a precaution against burns from touching hot surfaces of door or oven walls.**

• **When using cooking or roasting bags in oven,** follow the manufacturer's directions.

• **Do not use your oven to dry newspapers.** If overheated, they can catch fire.

(continued next page)

IMPORTANT SAFETY INSTRUCTIONS (continued)

Self-Cleaning Oven

- **Do not clean door gasket before reading special cleaning instructions in the Self-Clean section of this book.** The door gasket is essential for a good seal. Care should be taken not to rub, damage or move the gasket.
- **Do not use oven cleaners.** No commercial oven cleaner or oven liner protective coating of any kind should be used in or around any part of the oven.
- **Clean only parts listed in this Use and Care Book.**
- **Before self-cleaning the oven, remove broiler pan and other cookware.**
- **Do not use aluminum foil** to line oven bottoms, except as suggested in manual. Improper installation of these liners may result in a risk of electric shock or fire.
- **Be sure to wipe up excess spillage** before starting the self-cleaning operation.
- **If the self-cleaning mode malfunctions, turn off and disconnect the power supply.** Have serviced by a qualified technician.

If You Need Service

- **Read the Problem Solver in the back of this book.**
- **Don't attempt to repair or replace any part of your oven unless it is specifically recommended in this book.** All other servicing should be referred to a qualified technician.

SAVE THESE INSTRUCTIONS

Energy-Saving Tips

- Preheat oven only when necessary. Most foods will cook satisfactorily without preheating. If you find preheating is necessary, listen for the beep, and put food in oven promptly after the oven is preheated.
- Always turn oven off before removing food.
- During baking, avoid frequent door openings. Keep door open as short a time as possible if it is opened.
- Cook complete oven meals instead of just one food item. Potatoes, other vegetables and some desserts will cook together with a main-dish casserole, meat loaf, chicken or roast. Choose foods that cook at the same temperature and in approximately the same time.
- Use residual heat in the oven whenever possible to finish cooking casseroles, oven meals, etc. Also add rolls or precooked desserts to warm oven, using residual heat to warm them.

Features of Your Oven

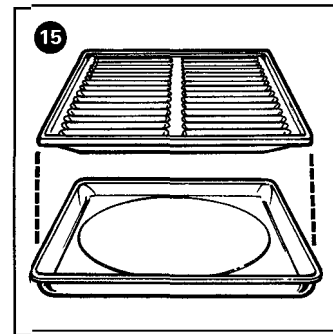
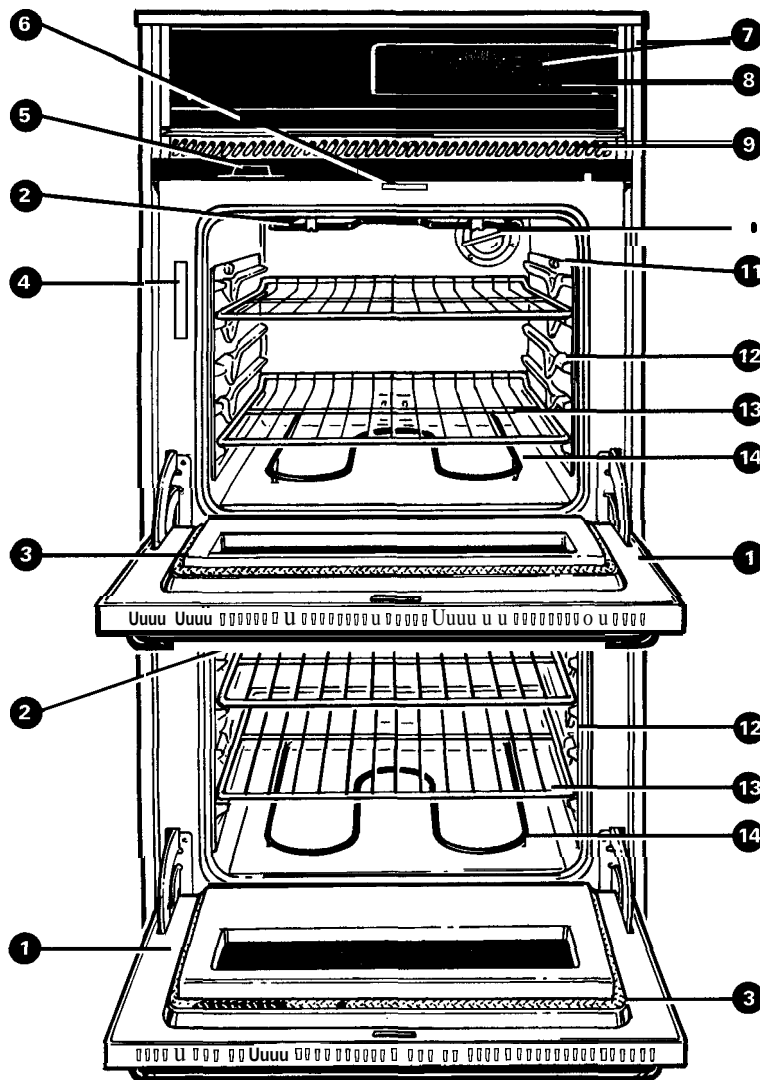

**JKP44GP
JKP45WP**

Feature Index	Explained on page
1 Removable Oven Doors with Window	17,21
2 Oven Broil Unit	15,21
3 Oven Door Gasket	18,20
4 Model and Serial Number Location	2
5 Oven Vent	—
6 Automatic Oven Door Latch	18,19
7 Oven Control, Clock and Minute Timer	6,7

Feature Index	Explained on page
8 Oven Light Switch (Lets you control interior oven lights.)	6
9 Grille	—
10 Oven Interior Light	17,22
11 Probe Receptacle	13, 14,21
12 Oven Shelf Supports	8
13 Oven Shelves	8,21
14 Bake Unit	21
15 Broiler Pan and Rack (Do not clean in self-clean oven.)	15, 17,21

Features of Your Oven Control

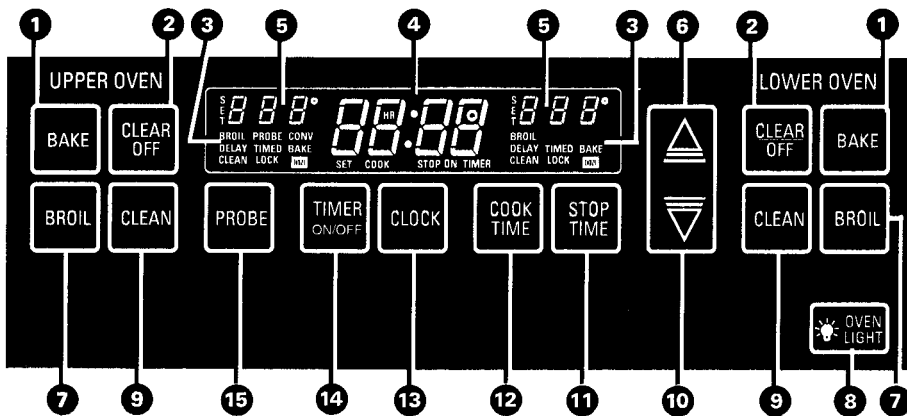

NOTE: Oven has controls for upper oven and lower oven. Be sure to set the correct control. Pads on the left side of panel are for the upper oven. Pads on the right side of panel are for the lower oven. The TIMER ON/OFF, COOK TIME, and STOP TIME pads can be used for either oven.

1. BAKE. Touch this pad to select bake function. Then tap or press INCREASE or DECREASE pad to display desired temperature.

2. CLEAR/OFF. Touch this pad to cancel all oven operations except clock and timer.

3. FUNCTION INDICATORS. Lights up to show whether bake, timed bake, broil, self-clean or probe is selected. Also lights up to show oven door lock and oven on status. Programmed information can be displayed at any time by touching the pad of the operation you want to see. For example, you can display the current time of day while the timer is counting down by touching the CLOCK pad. Selected function is displayed on the left side of panel for upper oven and right side of panel for lower oven.

4. TIME DISPLAY. Shows the time of day, the times set for the timer or automatic oven operation.

5. OVEN OR PROBE TEMPERATURE AND BROIL DISPLAY. Shows oven temperature, probe temperature or broil setting.

Temperature is displayed on left side of panel for upper oven and right side of panel for lower oven.

6. INCREASE. Short taps to this pad increase time or temperature by small amounts. Press and hold pad to increase time or temperature by larger amounts.

7. BROIL. Touch this pad to select broil function. Then tap INCREASE pad to broil at HI (525°F.) Tap DECREASE pad to broil at LO (450°F.).

8. OVEN LIGHT. Touch to turn oven light on or off.

9. CLEAN. Touch this pad to select self-cleaning function. See Self-Cleaning Instructions in this book.

10. DECREASE. Short taps to this pad decrease time or temperature by small amounts. Press and hold pad to decrease time or temperature by larger amounts.

11. STOP TIME. Use this pad along with COOK TIME or CLEAN and INCREASE or DECREASE pad to set the oven to start automatically and stop automatically at a time you select.

12. COOK TIME. Touch this pad and then touch the INCREASE or DECREASE pad to set the amount of time you want your food to cook. Touch BAKE and the INCREASE or DECREASE pad to set the oven temperature.

13. CLOCK. To set clock, first touch CLOCK pad. "SET TIME" will appear in the display. Tap INCREASE or DECREASE pad to change the time of day by small amounts. Press and hold INCREASE or DECREASE pad to change the time of day by larger amounts.

14. TIMER ON/OFF. This pad does not control oven operations. The timer can time up to 9 hours and 55 minutes.

To set timer, first touch TIMER ON/OFF pad. "O :00," "HR" and "SET TIMER" will appear in the display. Tap INCREASE or DECREASE pad to change the time by small amounts. Press and hold INCREASE or DECREASE pad to change the time by larger amounts. Hours and minutes are entered and displayed on the timer. Timer signals when last minute is reached. The timer will display hours and minutes until the last minute is displayed, then it will display seconds. Timer signals when it has counted down to 0. Then it will signal every six seconds until you touch TIMER ON/OFF pad.

15. PROBE. (upper oven) Insert the probe in your food and receptacle, then roast to your choice of internal food temperatures.

If "F-" and a number flash on display and the control beeps, this indicates function error code. Press CLEAR/OFF pad. Allow oven to cool for one hour. Put oven back into operation. If function error code repeats, disconnect power to the oven and call for service.

Oven Control, Clock and Timer

Child Lockout Feature

Your built-in oven has a provision for locking the control panel to prevent the oven from being turned on accidentally.

To lock the control panel press & hold the INCREASE and DECREASE pad and the STOP TIME pad at the same time for 2 seconds. The word "OFF" will appear and then disappear in the display and the control panel will be locked. During lockout, the word "OFF" will appear momentarily each time a cooking function pad is touched.

To unlock the control panel, repeat the above procedure. The word "OFF" will appear in the display then disappear after two seconds.

Clock

The clock must be set for the automatic oven timing functions to work properly. The time of day cannot be changed during a TIME BAKE or CLEAN cycle.

To Set the Clock

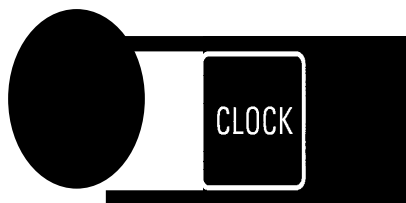

Step 1. Touch the CLOCK pad.

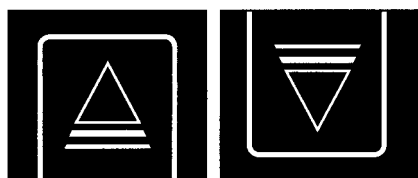

Step 2. Press the INCREASE or DECREASE pad to set the time of day.

Example: Try setting the time for three o'clock. Use a combination of presses and taps to get familiar with the control. Since this is a 12-hour clock, there is no need to worry about AM or PM.



If you accidentally go past three o'clock, simply press the DECREASE pad until the time shows in the display.

Power Outage?

After a power outage, when power is restored the display will flash and time shown will no longer be correct—for example, after a 5-minute power interruption the clock will be 5 minutes slow.

All other functions that were in operation when the power went out will have to be programmed again.

Timer

The timer does not control oven operations. The maximum setting on the timer is 9 hours and 55 minutes.

To Set the Timer



Step 1. Touch the TIMER ON/OFF pad.

Step 2. Press the INCREASE or DECREASE pad to set the amount of time on timer.

The clock starts immediately; the words SET TIME go off after about one minute.

The timer will display hours and minutes as it counts down until the last minute is displayed, then it displays seconds.

To Reset Timer

If "TIMER" is showing, hold or tap INCREASE or DECREASE pad until desired time is reached. If "TIMER" is not showing, touch TIMER ON/OFF pad first.

To Cancel Timer

Touch TIMER ON/OFF pad twice to cancel if "TIMER" is not showing or if "SET TIMER" shows on display. Touch TIMER ON/OFF pad once to cancel if timer has started counting down.

Timer Tones

The timer tone is a series of three beeps followed by one beep every six seconds. If you would like to remove the signal that beeps every six seconds, press & hold CLEAR/OFF pad for 10 seconds.

To return the signal that beeps every six seconds, press & hold CLEAR/OFF pad for 10 seconds.

Display Messages

If "door" appears on the display, LOCK flashes and oven signals, you set the self-clean cycle and did not shut the oven door.

Using Your Oven

INCREASE & DECREASE Pad Speed

You can change the speed of these pads in 5 increments. While the oven is off and the time of day shows in the display, press & hold the INCREASE and DECREASE pads and the TIMER pad for 2 or 3 seconds. A number from 1 to 5 will replace "0:00" in the display. 1 is slowest and 5 is fastest. Use INCREASE or DECREASE pad to change, then press CLEAR/OFF to return to time-of-day display.

Before Using Your Oven

1. Look at the controls. Be sure you understand how to set them properly. Read over the directions for the Oven Controls so you understand how to use them.
2. Check oven interior. Look at the shelves. Take a practice run at removing and replacing them properly, to give sure, sturdy support.
3. Read over information and tips that follow.
4. Keep this book handy so you can refer to it, especially during the first weeks of using your new oven.

Oven Shelves

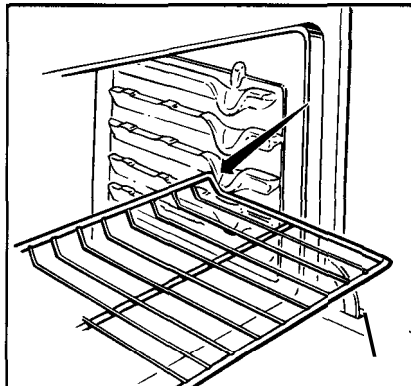

The shelves are designed with stop-locks so that when placed correctly on the shelf supports, they will stop before coming completely from the oven, and will not tilt when you are removing food from them or placing food on them.

When placing cookware on a shelf, pull the shelf out to the "stop" position. Place the cookware on the shelf, then slide the shelf back into the oven. This will eliminate reaching into the hot oven.

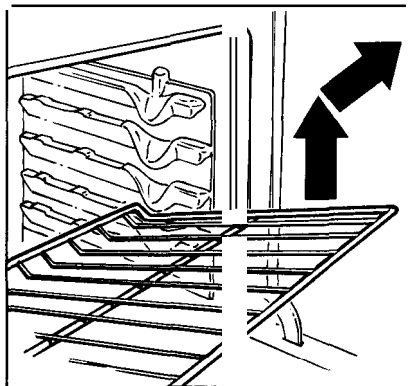

To remove the shelves from the oven, pull them toward you, tilt front end upward and pull shelf out.

To replace, place shelf on shelf support with stop-locks (curved extension of shelf) facing up and toward rear of oven. Tilt up front and push shelf toward back of oven until it goes past "stop" on oven wall. Then lower front of shelf and push it all the way back.

Shelf Positions

The oven has four shelf supports—A (bottom), B, C and D (top). Shelf positions for cooking are suggested on Baking and Roasting pages.

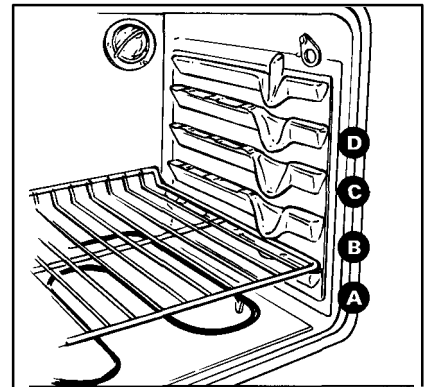

Oven Light

The light comes on automatically when the oven door is opened. Use the pad on the oven control panel — to turn the light on and off when the door is closed.

*Back light
comes on
when oven
door is open*

Baking

See Baking Guide.

NOTE: Oven has controls for upper oven and lower oven. Be sure to set the correct control. Pads on the left side of panel are for the upper oven. Pads on the right side of panel are for the lower oven. The TIMER ON/OFF, COOK TIME, and STOP TIME pads can be used for either oven.

Your oven temperature is controlled very accurately using an oven control system. It is recommended that you operate the oven for a number of weeks using the time given on recipes as a guide to become familiar with your new oven's performance. If you think an adjustment is necessary, see Adjusting Oven Temperature section in this book.

How to Set Your Range for Baking

Step 1: Position the shelf or shelves in the oven. If cooking on two shelves at the same time, place shelves on alternate shelf supports and stagger food on them.

Step 2: Close the oven door.



Step 3: Touch the BAKE pad.

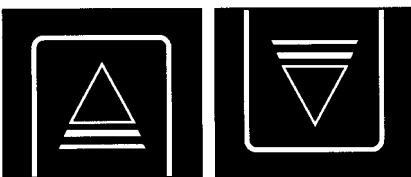

Step 4: Press the INCREASE or DECREASE pad. The display will show the last bake temperature that was used. (Tap to change temperature 5 degrees a tap. Press and hold to change temperature 25 degrees at a time.)

The word "ON" and the changing temperature will be displayed as the oven heats up. When the oven reaches the set temperature a tone will sound.

To change oven temperature during BAKE cycle, touch BAKE pad and then INCREASE or DECREASE pad to get new temperature.



Step 5: Touch the CLEAR/OFF pad when baking is finished and then remove food from oven.

How to Time Bake

The oven control allows you to turn the oven on automatically at specific times that you set. Foods that are highly perishable such as milk, eggs, fish, stuffings, poultry and pork should not be allowed to sit out for more than one hour before or after cooking. Room temperature promotes the growth of harmful bacteria. Be sure that oven light is off because heat from the bulb will speed harmful bacteria growth.

NOTE: Before beginning make sure the oven clock shows the correct time of day. To set the clock, first touch the CLOCK pad. "SET TIME" will show in the display. Press INCREASE or DECREASE pad until correct time of day is displayed.

How to Set Immediate Start and Automatic Stop

Oven turns on right away, and cooks for preset length of time.

Step 1: Position the shelf or shelves in the oven. If cooking on two shelves at the same time, place shelves on alternate shelf supports and stagger food on them.

Step 2: Close the oven door.



Step 3: Touch the BAKE pad



Step 4: Press the INCREASE or DECREASE pad until desired temperature is displayed.



Step 5: Touch the COOK TIME pad.



Step 6: Press the INCREASE or DECREASE pad until the desired length of baking time appears in the display.

The words "TIMED BAKE ON" and "COOK TIME" will be displayed along with the oven temperature that you set and the cook time that you entered.

NOTE: Remember, foods that are left in the oven continue cooking after controls are off.

(continued next page)

Baking (continued)

How to Set Delay Start and Stop

Quick Reminder:

1. Touch BAKE pad.
2. Touch INCREASE/DECREASE pad to select oven temperature.
3. Touch COOK TIME pad.
4. Touch INCREASE/DECREASE pad to set cooking time.
5. Touch STOP TIME pad.
6. Touch INCREASE/DECREASE pad until desired Stop Time appears in display.
7. Touch START pad. *There is no start pad*

Delay Start and Stop is setting the oven control to turn the oven on and bake until specific time.

For example: Let's say it's 2:00 and dinner time is shortly after 7:00. The recipe suggests 3 hours baking time at 325°F. Here's how:

Step 1: Position the shelf or shelves in the oven. If cooking on two shelves at the same time, stagger the pans for best heat circulation.

Step 2: Close the oven door.



Step 3: Touch the BAKE pad.

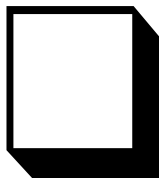

Step 4: Press the INCREASE or DECREASE pad until "325°" is displayed



Step 5: Touch the COOK TIME pad



Step 6: Press the INCREASE pad until "3:00" appears in the display. Cook Time of 3 hours now appears in display.



Step 7: Touch the STOP TIME pad. "SET STOP TIME" and the earliest stop time you can set appear on display. In this example, "5:00" and "COOK STOP TIME" appear on display. The control automatically sets Stop Time by adding the Cook Time to the time of day. In this example, the time of day is 2:00 and the Cook Time is 3 hours. Adding 3 hours to the time of day equals 5:00.

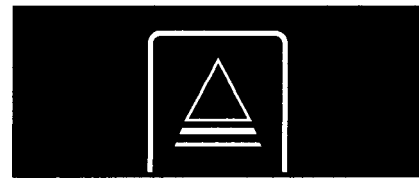

Step 8: Change Stop Time from 5:00 to 7:00 by pressing the INCREASE pad until "7:00" appears in the display. The words "DELAY TIMED BAKE" appear on display.

At 4:00, the oven will turn on automatically. Oven will continue to cook for the programmed 3 hours and shut off automatically at 7:00.

NOTE: Foods that are highly perishable such as milk, eggs, fish, stuffings, poultry and pork should not be allowed to sit out for more than one hour before or after cooking. Room temperature promotes the growth of harmful bacteria.

NOTE: Be sure that oven light is off because heat from the bulb will speed harmful bacteria growth.

Baking Guide

1. Aluminum pans conduct heat quickly. For most conventional baking, light, shiny finishes generally give best results because they help prevent overbrowning. For best results, we recommend dull bottom surfaces for cake pans and pie plates.

2. Dark or non-shiny finishes and glass cookware generally absorb

heat, which may result in dry, crisp crusts, Reduce oven heat 25°F. if lighter crusts are desired. Rapid browning of some foods can be achieved-by preheating cast-iron cookware.

3. Preheating the oven is not always necessary, especially for foods that cook longer than 30" to 40 minutes. For foods with short cooking times,

preheating gives best appearance and crispness. Although preheating is not necessary with meats, it is preferred for baked goods.

4. Open the oven door to check food as little as possible to prevent uneven heating and to save energy.

Food	Cookware	Shelf Position	Oven Temperature	Time, Minutes	Comments
Bread					
Biscuits (1/2 in. thick)	Shiny Cookie Sheet	B, C	400°-4750	15-20	Canned, refrigerated biscuits take 2 to 4 minutes less time.
Coffee cake	Shiny Metal Pan with satin-finish bottom	B	350°-4000	20-30	
Corn bread or muffins	Cast-iron or Glass Pan	B	400°-4500	20-40	Preheat cast-iron pan for crisp crust.
Gingerbread	Shiny Metal Pan with satin-finish bottom	B	350°	45-55	
Muffins	Shiny Metal Muffin Pans	B	400°-4250	20-30	Decrease about 5 minutes for muffin mix, or bake at 450°F. for 25 minutes, then at 350°F. for 10 to 15 minutes.
Popovers	Deep Glass or Cast-iron Cups	B	375°	45-60	
Quick loaf bread	Metal or Glass Loaf Pans	B	350°-3750	45-60	
Yeast bread (2 loaves)	Metal or Glass Loaf Pans	B	375°-4250	45-60	Dark metal or glass give deepest browning.
Plain rolls	Shiny Oblong or Muffin Pans	B	375°-4250	10-25	
Sweet rolls	Shiny Oblong or Muffin Pans	B	350°-3750	20-30	
Cakes (without shortening)					
Angel food	Aluminum Tube Pan	A	325°-3750	30-55	Two-piece pan is convenient.
Jelly roll	Metal Jelly Roll Pan	B	375°-4000	10-15	Line pan with waxed paper.
Sponge	Metal or Ceramic Pan	B	325°-3500	45-60	
Cakes					
Bundt cakes	Metal or Ceramic Pan	A, B	325°-3500	45-65	
Cupcakes	Shiny Metal Muffin Pans	B	350°-3750	20-25	Paper liners produce moister crusts.
Fruitcakes	Metal or Glass Loaf or Tube Pan	A, B	275°-3000	2-4 hrs.	Use 300°F. and Shelf B for small or individual cakes.
Layer	Shiny Metal Pan with satin-finish bottom	B	350°-3750	20-35	If baking four layers, use Shelves B and D.
Loaf	Metal or Glass Loaf Pans	B	350°	40-60	
Cookies	Metal or Glass Pans	B, C	325°-3500	25-35	Bar cookies from mix use same time.
Brownies	Cookie Sheet	B, C	350°-4000	10-20	Use Shelf C and increase temperature 25°F. to 50°F. for more browning.
Drop					
Refrigerator	Cookie Sheet	B, C	400°-4250	6-12	
Rolled or sliced	Cookie Sheet	B, C	375°-4000	7-12	
Fruits, Other Desserts					
Baked apples	Glass or Metal Pans	B, C	350°-400°	30-60	
Custard	Glass Custard Cups or Casserole (set in pan of hot water)	B	300°-3500	30-60	Reduce temperature to 300°F. for large custard.
Puddings, rice and custard	Glass Custard Cups or Casserole	B	325°	50-90	Cook bread or rice pudding with custard base 80 to 90 minutes.
Pies					
Frozen	Foil Pan on Cookie Sheet	A	400°-4250	45-70	For large pies use 400°F. and more time.
Meringue	Spread to crust edges	B, C	325°-3500	15-25	To quickly brown meringue, use 400°F. for 8 to 10 minutes.
One crust	Glass or Satin-finish Metal Pan	B	400°-4250	40-60	Custard fillings require lower temperature, longer time.
Two crust	Glass or Satin-finish Metal Pan	B	400°-4250	40-60	
Pastry shell	Glass or Satin-finish Metal Pan	B	450°	12-15	
Miscellaneous					
Baked potatoes	Set on Oven shelf	B, C	325°-4000	60-90	Increase time for larger amount or size.
Scalloped dishes	Glass or Metal Pan	B, C	325°-3750	30-60	
Souffles	Glass Pan	B	300°-3500	30-75	

Roasting

NOTE: Oven has controls for upper oven and lower oven. Be sure to set the correct control. Pads on the left side of panel are for the upper oven. Pads on the right side of panel are for the lower oven. The TIMER ON/OFF, COOK TIME, and STOP TIME pads can be used for either oven.

Roasting is cooking by dry heat. Tender meat or poultry can be roasted uncovered in your oven. Roasting temperatures, which should be low and steady, keep spattering to a minimum. When roasting, it is not necessary to sear, baste, cover or add water to your meat.

Roasting is really a baking procedure used for meats. Therefore, oven controls are set for BAKE. (You may hear a slight clicking sound, indicating the oven is working properly.) Roasting is easy; just follow these steps:

Step 1: Check weight of meat, and place, fat-side-up, on roasting rack in a shallow pan. (Broiler pan with rack is a good pan for this.) Line broiler pan with aluminum foil when using pan for marinating, cooking with fruits, cooking heavily cured meats, or basting food during cooking. Avoid spilling these materials on oven liner or door.

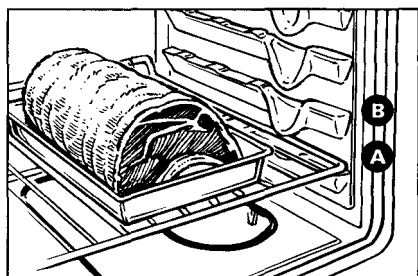

Step 2: Place in oven shelf in A or B position. No preheating is necessary.



Step 3: Touch the BAKE pad



Step 4: Press the INCREASE or DECREASE pad until desired temperature is displayed.

The word "ON" will be displayed as the oven heats up. When the oven reaches the set temperature a tone will sound.

To change oven temperature during BAKE cycle, touch BAKE pad and then INCREASE or DECREASE pad to set new temperature.



Step 5: Touch the CLEAR/OFF pad when roasting is finished and then remove food from oven.

Step 6: Most meats continue to cook slightly while standing, after being removed from the oven. Standing time recommended for roasts is 10 to 20 minutes. This allows roasts to firm up and makes them easier to carve. Internal temperature will rise about 5° to 10°F.; to compensate for temperature increase, if desired, remove the roast from oven sooner (at 5° to 10°F. less than temperature in the Roasting Guide.)

NOTE: You may wish to TIME BAKE, as described in the Baking section, to turn oven on and off automatically.

Remember that food will continue to cook in the hot oven and therefore should be removed when the desired internal temperature has been reached.

For Frozen Roasts

- Frozen roasts of beef, pork, lamb, etc., can be started without thawing, but allow 10 to 25 minutes per pound additional time (10 minutes per pound for roasts under 5 pounds, more time for larger roasts).
- Thaw most frozen poultry before roasting to ensure even doneness. Some commercial frozen poultry can be cooked successfully without thawing. Follow directions given on package label.

Questions and Answers

Q. Why is my roast crumbling when I try to carve it?

A. Roasts are easier to slice if allowed to cool 10 to 20 minutes after removing from oven. Be sure to cut across the grain of the meat.

Q. Do I need to preheat my oven each time I cook a roast or poultry?

A. It is unnecessary to preheat your oven.

Q. When buying a roast, are there any special tips that would help me cook it more evenly?

A. Yes. Buy a roast as even in thickness as possible, or buy rolled roasts.

Q. Can I seal the sides of my foil "tent" when roasting a turkey?

A. Sealing the foil will steam the meat. Leaving it unsealed allows the air to circulate and brown the meat.

Roasting with the Probe See Roasting Guide.

Correct Placement of the Temperature Probe

Oven has a probe in the upper oven only.

For many foods, especially roasts and poultry, internal food temperature is the best test for doneness. The temperature probe takes the guesswork out of roasting by cooking foods to the exact doneness you want. When the internal temperature of the food reaches the temperature you set, the oven automatically shuts off.

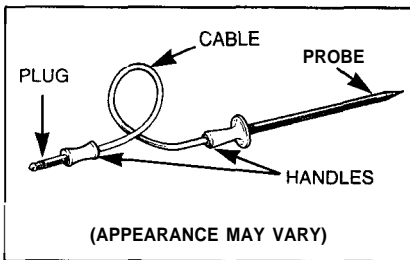

The temperature probe has a skewer-like probe at one end and a plug at the other end that goes into a receptacle on the oven wall. Use handles of the probe and plug when inserting and removing from meat and wall receptacle. Do not use tongs to pull on the cable when removing the probe—they might damage it. **TO AVOID BREAKING THE PROBE, MAKE SURE FOOD IS COMPLETELY DEFROSTED BEFORE INSERTING.**

After preparing meat and placing it on roasting pan rack, follow these steps for proper probe placement.

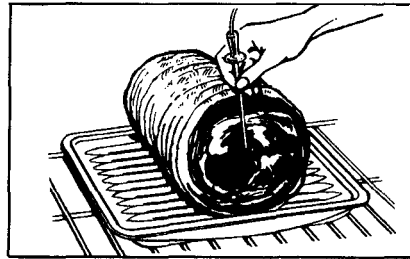

Step 1: Lay the probe on the outside of the meat along the top or side and mark with your finger where the edge of the meat comes to on the probe. Point should rest in the center of the thickest meaty part of the roast.

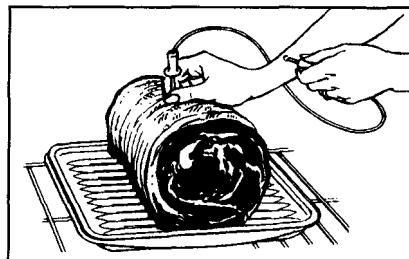

Step 2: Insert the probe into the meat up to the point marked off with your finger. It should not touch bone, fat or gristle.

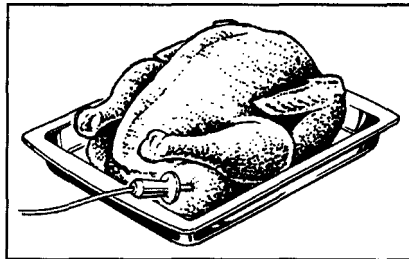

No more than two inches of the probe, not counting the handle, should be left exposed outside the meat.

Poultry

Insert probe into meatiest part of inner thigh from below and parallel to the leg of a whole turkey.

Casseroles or Fish

Insert probe into center of dishes such as meat loaf or casseroles. When cooking fish, insert probe from just above gill into meatiest area, parallel to backbone.

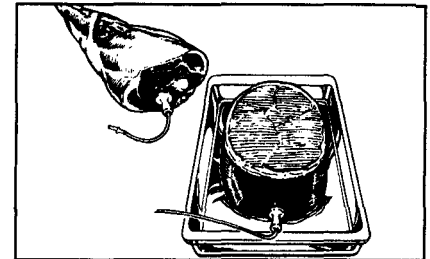

Ham or Lamb

Insert probe into cut end, meatiest part of ham or lamb without a bone. For bone-in ham or lamb, insert probe into center of lowest large muscle or joint.

(continued next page)

Roasting with the Probe (continued)

How to Set the Oven When Using the Temperature Probe

Oven has a probe in the upper oven only.

Step 1: Insert probe into meat.

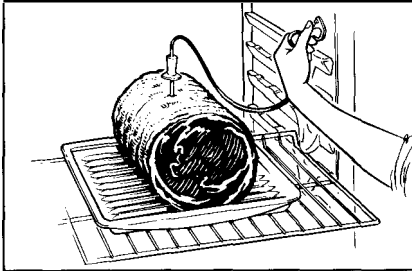

Step 2: Plug probe into receptacle on the oven wall. Make sure it's pushed all the way in. Close the oven door.

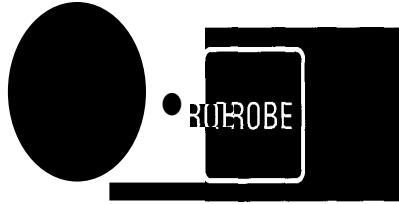

Step 3: Touch PROBE pad.

Step 4: Press INCREASE or DECREASE pad to set probe temperature.

Step 5: Touch BAKE pad.

Step 6: Press INCREASE or DECREASE pad to set oven temperature.

Step 7: When internal temperature of roast reaches number you have set, probe and oven turn off and oven signals. To stop signal, press timer CLEAR/OFF pad. Use hotpads to remove the probe from the food. Do not use tongs to pull on it, they might damage it.

Caution: To prevent possible burns, do not unplug the probe from the oven receptacle until the oven has cooled. Do not store probe in the oven.

NOTE: You will not be able to use the probe in the upper oven during timed oven operations.

Roasting Guide

Type	Oven temperature	Doneness	Approximate Roasting Time in Minutes per Pound		Internal Temperature °F.
Meat Tender cuts; rib, high quality sirloin tip, rump or top round* Lamb leg or bone-in shoulder* Veal shoulder, leg or loin* Pork loin, rib or shoulder* Ham, precooked Ham, raw *For boneless rolled roasts over 6 inches thick, add 5 to 10 minutes per pound to times given above.	325°	Rare: Medium: Well Done:	3 to 5 lbs. 24-33 35-39 40-45	6 to 8 lbs. 18-22 22-29 30-35	140°-1500 150°-1600 170°- 185°
	325°	Rare: Medium: Well Done:	21-25 25-30 30-35	20-23 24-28 28-33	130°-1400 150°-1600 170°- 185°
	325°	Well Done:	35-45	30-40	170°-180°
	325°	Well Done:	35-45	30-40	170°-1800
	325°	To Warm:	17-20 minutes per pound (any weight)		115°- 125°
	325°	Well Done:	Under 10 lbs. 20-30	10 to 15 lbs. 17-20	170°
Poultry Chicken or Duck Chicken pieces Turkey	325°	Well Done:	3 to 5 lbs. 35-40	Over 5 lbs. 30-35	185°-1900
	350°	Well Done:	35-40		185°-1900
	325°	Well Done:	10 to 15 lbs. 18-25	Over 15 lbs. 15-20	In thigh: 185°-1900

Broiling

NOTE: Oven has controls for upper oven and lower oven. Be sure to set the correct control. Pads on the left side of panel are for the upper oven. Pads on the right side of panel are for the lower oven. The TIMER ON/OFF, COOK TIME, and STOP TIME pads can be used for either oven.

Broiling is cooking food by intense radiant heat from the upper broil unit in the oven. You can broil in upper or lower oven. Most fish and tender cuts of meat can be broiled. Follow these steps to keep spattering and smoking to a minimum.

Step 1: If meat has fat or gristle near edge, cut vertical slashes through both about 2" apart. If desired, fat may be trimmed, leaving layer about 1/8" thick.

Step 2: Place meat on broiler rack in broiler pan. Always use rack so fat drips into broiler pan; otherwise juices may become hot enough to catch fire.

Step 3: Position shelf on recommended shelf position as suggested in Broiling Guide.

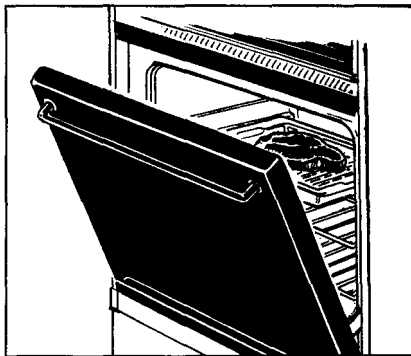

Step 4: Leave door open to broil stop position. The door stays open by itself, yet the proper temperature is maintained in the oven.

Step 5: Touch the BROIL pad.

NOTE: If BROIL pad does not work, probe might be connected. Remove probe.

Step 6: Touch INCREASE pad for HI broil or touch DECREASE pad for LO broil.

NOTE: Chicken and ham are broiled at LO broil in order to cook food without overbrowning it.

Step 7: Turn food only once during broiling. Time foods for first side per Broiling Guide.

Turn food, then use times given for second side as a guide to preferred doneness. (Where two thicknesses and times are given together, use first times given for thinnest food.)

Step 8: When finished broiling, touch the CLEAR/OFF pad. Serve food immediately, and leave pan outside oven to cool during meal for easiest cleaning.

Use of Aluminum Foil

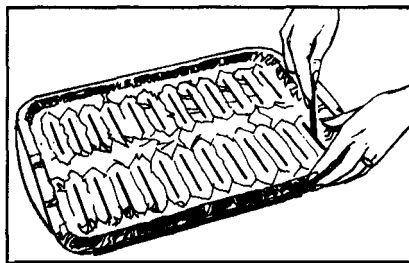

You can use aluminum foil to line your broiler pan and broiler rack. However, you must mold the foil tightly to the rack and cut slits in it just like the rack.

Without the slits, the foil will prevent fat and meat juices from draining to the broiler pan. The juices could become hot enough to catch on fire. If you do not cut the slits, you are frying, not broiling.

Questions & Answers

Q. When broiling, is it necessary to always use a rack in the pan?

A. Yes. Using the rack suspends the meat over the pan. As the meat cooks, the juices fall into the pan, thus keeping meat drier. Juices are protected by the rack and stay cooler, thus preventing excessive spatter and smoking.

Q. Should I salt the meat before broiling?

A. No. Salt draws out the juices and allows them to evaporate. Always salt after cooking. Turn meat with tongs; piercing meat with a fork also allows juices to escape. When broiling poultry or fish, brush each side often with butter.

Q. Why are my meats not turning out as brown as they should?

A. In some areas, the power (voltage) to the oven maybe low. In these cases, preheat the broil unit for 10 minutes before placing broiler pan with food in oven. Check to see if you are using the recommended shelf position. Broil for longest period of time indicated in the Broiling Guide. Turn food only once during broiling.

Q. Do I need to grease my broiler rack to prevent meat from sticking?

A. No. The broiler rack is designed to reflect broiler heat, thus keeping the surface cool enough to prevent meat from sticking to the surface. However, spraying the broiler rack lightly with a vegetable cooking spray before cooking will make cleanup easier.

Broiling Guide

1. Always use broiler pan and rack that comes with your oven. It is designed to minimize smoking and spattering by trapping juices in the shielded lower part of the pan.
2. Oven door should be open to the broil stop position for all foods.
3. For steaks and chops, slash fat evenly around outside edges of meat. To slash, cut crosswise through outer fat surface just to the edge of

- the meat. Use tongs to turn meat over to prevent piercing meat and losing juices.
4. If desired, marinate meats or chicken before broiling. Or brush with barbecue sauce last 5 to 10 minutes only.
5. When arranging food on pan, do not let fatty edges hang over sides, which could soil oven with fat dripping.

6. Broiler does not need to be preheated. However, for very thin foods, or to increase browning, preheat if desired.
7. Frozen steaks can be conventionally broiled by positioning the oven shelf at next lowest shelf position and increasing cooking time given in this guide 1 1/2 times per side.

Food	Quantity and/or Thickness	Shelf Position	HI or O Broil	First Side Time, Minutes	Second Side Time, Minute	Comments
Bacon	1/2 lb. (about 8 thin slices)	C	HI	4 1/2	4 1/2	Arrange in single layer.
Ground Beef Well Done	1 lb. (4 patties) 1/2 to 3/4 in. thick	C	HI	10	7	Space evenly. Up to 8 patties take about same time.
Beef Steaks						
Rare	1 in. thick (1 to 1X lbs.)	C	HI	6	5	Steaks less than 1 in. thick cook through before browning. Pan frying is recommended. Slash fat.
Medium Well Done		C		8	6	
Rare	1 1/2 in. thick	C		12	11	
Medium Well Done		C		10	7-8	
	(2 to 2 1/2 lbs.)	C		15	14-16	
		C		25	20-25	
Chicken	1 whole (2 to 2 1/2 lbs.), split lengthwise	A	LO	35	10-15	Reduce time about 5 to 10 min. per side for cut-up chicken. Brush each side with melted butter. Broil with skin-side-down first.
Bakery Products						
Bread (Toast) or Toaster Pastries	2 to 4 slices	C	HI	1 1/2-2	1/2	Space evenly. Place English muffins cut-side-up and brush with butter, if desired.
English Muffins	1 pkg. (2) 2 (split)	C		3-4		
Lobster tails	2-4 (6 to 8 oz. each)	B	HI	13-16	Do not turn over,	Cut through back of shell, spread open. Brush with melted butter before broiling and after half of broiling time.
Fish	1-lb. fillets 1/4 to 1/2 in. thick	C	HI	5	5	Handle and turn very carefully. Brush with lemon butter before and during cooking if desired. Preheat broiler to increase browning.
Ham slices (precooked)	1 in. thick	B	LO	8	8	Increase time 5 to 10 min. per side for 1 1/2 in. thick or home-cured ham.
Pork chops Well Done	2 (1/2 in.) 2 (1 in. thick), about 1 lb.	C B	HI	10 13	10 13	Slash fat.
Lamb chops						
Medium Well Done	2(1 in. thick) about 10 to 12 oz.	C	HI	10	9	Slash fat.
Medium Well Done		C		12	10	
	2(1 1/2 in. thick), about 1 lb.	C B		14 17	12 12-14	
Wieners and similar precooked sausages, bratwurst	1-lb. pkg. (10)	C	HI	6	1-2	If desired, split sausages in half lengthwise; cut into 5- to 6-in. pieces.

Care and Cleaning

Proper care and cleaning are important so your oven will give you efficient and satisfactory service. Follow these directions carefully in caring for your oven to assure safe and proper maintenance.

Oven Shelves

Oven shelves may be cleaned with a mild abrasive cleanser following manufacturer's directions. After cleaning, rinse the shelves with clean water and dry with a clean cloth.

To remove heavy, burned-on soil, soapy metal pads may be used following manufacturer's directions. After scrubbing, wash with soapy water, rinse and dry.

Oven shelves may be cleaned in the self-cleaning oven. Note: Shelves will discolor during the self-cleaning cycle.

Broiler Pan & Rack

After broiling, remove the broiler pan from the oven. Remove the rack from the pan. Carefully pour out the grease in the pan into a proper container. Wash and rinse the pan and rack in hot, soapy water.

If food has burned on, sprinkle the rack while hot with detergent and cover with wet paper towels or a dish cloth. That way, burned-on foods will soak loose while the meal is being served.

Do not store a soiled broiler pan and rack in the oven. Do not clean in self-cleaning oven.

Oven Light Bulb

The light bulb is located on the back wall of the oven. Before replacing the bulb, disconnect electric power to the oven at the main fuse or circuit breaker panel. Let the bulb cool completely before removing it. Do not touch a hot bulb with a damp cloth. If you do, the bulb will break.

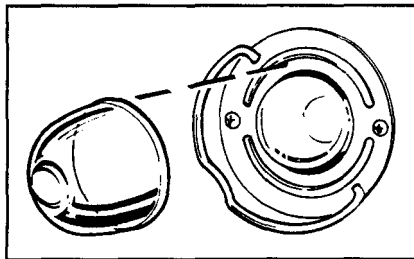

The oven lamp (bulb) is covered with a removable glass cover which is held in place with a bail-shaped wire. Remove oven door, if desired, to reach cover easily.

To remove:

- Hold hand under cover so it doesn't fall when released. With fingers of same hand, firmly push back wire bail until it clears cover. Lift off cover. **DO NOT REMOVE ANY SCREWS TO REMOVE COVER.**
- Replace bulb with 40-watt home appliance bulb.

To replace cover:

- Place it into groove of lamp receptacle. Pull wire bail forward to center of cover until it snaps into place. When in place, wire holds cover firmly. Be certain wire bail is in depression in center of cover.
- Connect electric power to oven.

Lift-Off Oven Door

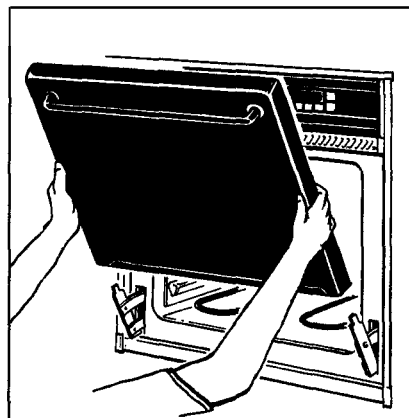

The oven door is removable to make the interior more accessible.

To remove the door, open it a few inches to the special stop position that will hold the door open. Grasp firmly on each side and lift the door straight up and off the hinges.

Note: Be careful not to place hands between the hinge and the oven door frame as the hinge could snap back and pinch fingers.

To replace the door, make sure the hinges are in the special stop position. Position the slots in the bottom of the door squarely over the hinges. Then lower the door slowly and evenly over both hinges at the same time. If hinges snap back against the oven frame, pull them back out.

Operating the Self-Cleaning Oven

NOTE: Oven has controls for upper oven and lower oven. Be sure to set the correct control. Pads on the left side of panel are for the upper oven. Pads on the right side of panel are for the lower oven. The TIMER ON/OFF, COOK TIME, and STOP TIME pads can be used for either oven.

**Programmed Cleaning Time:
3 hours**

Prepare the Oven Before Setting the Controls

Step 1:

Remove the broiler pan, broiler rack, all cookware and any aluminum foil from the oven. (Oven shelves may be left in the oven. NOTE: Shelves will discolor during the self-cleaning cycle.)

Step 2:

Wipe up heavy soil on oven bottom. If you use soap, rinse thoroughly before self-cleaning to prevent staining.

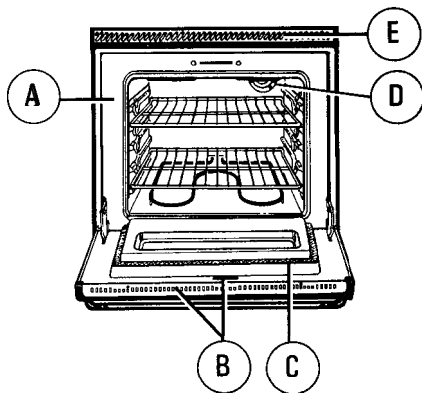

- A. Oven Front Frame
- B. Openings in the Door
- C. Oven Door Gasket
- D. Oven Light
- E. Oven Vent Grille

Step 3:

- Clean spatters or soil on the oven front frame (A), under the front edge of the oven vent, the door liner outside the door gasket and the front edge of the oven cavity (about 1" into the oven). Use detergent and hot water with a soap-filled steel wool pad, then rinse well with a vinegar and water mixture. This will help prevent a brown residue from forming when the oven is heated. Buff these areas with a dry cloth.

- Clean top, sides and outside front of oven door with soap and water. Do not use abrasives or oven cleaners.

Do not let water run down through openings in the top of the door (B). To help prevent water from getting in these slots when cleaning, open the door as far as it will go.

Clean the door gasket (C) using a clean sponge to soak the soiled area with hydrogen peroxide. Repeated soaking may be needed depending on the amount of soil. Frequent cleaning will prevent excessive soil buildup. Do not rub the door gasket—the fiberglass material of the gasket has an extremely low resistance to abrasion. An intact and well-fitting oven door gasket is essential for energy-efficient oven operation and good baking results. If you notice the gasket becoming worn, frayed or damaged in any way or if it has become displaced on the door, you should replace it.

Make sure the oven light bulb cover (D) is in place.

Step 4:

Close the oven door and make sure the oven light is off.

Oven shelves may be cleaned in the self-cleaning oven. However, they will darken, lose their luster and become hard to slide. Wipe the shelf supports with cooking oil after self-cleaning to make shelves slide more easily.

Do not use commercial oven cleaners or oven protectors in or near the self-cleaning oven.

A combination of any of these products plus the high clean-cycle temperature may damage the porcelain finish of the oven.

Important

The oven door must be closed and all controls must be set correctly for the clean cycle to work properly. To help you understand how the clean cycle works, the stages of the cycle are noted below.

1. Close the oven door completely.
2. Set the controls.
3. The words "SET TIME CLEAN" and the selected clean time from 2-4 hours is displayed. The door locks automatically, the oven begins to heat.

Operating the Self-Cleaning Oven



Set the Oven for Cleaning

If range is too hot and you start to set a clean cycle, the word "OFF" will appear in the display. Allow additional time for cooling before you try to set the cycle.

NOTE: Only one oven at a time can be self-cleaned. "OFF" will appear in the display if you try to clean both ovens at the same time.

1. Close the oven door completely.
2. Touch the CLEAN pad.
3. Touch INCREASE or DECREASE pad. "3:00," "HR" and "TIME CLEAN" will appear on display. Three hours is the programmed clean time, but any time between two and four hours can be set.

The door latches automatically. If the oven door is not closed, the word "DOOR" is displayed, the word "LOCK" will flash and the oven will signal. Close the door. The signal will stop and the clean cycle will start when the door can lock.

When a clean cycle is finished, the word "CLEAN" will be off in the display.

You will not be able to open the door unless the oven temperature is at a safe level, when "LOCK" goes out on display. Wait until the oven has cooled. below locking temperature (about 20-30 minutes).

NOTE: You can find out when the clean cycle will be finished by pushing the STOP TIME pad.

To Set a Delayed Start

1. Close the oven door completely.
2. Touch the CLEAN pad.
3. Touch INCREASE or DECREASE pad to enter Clean Time.
4. Touch STOP TIME pad. "SET STOP TIME" and the earliest stop time you can set will appear on display.

The earliest stop time will be the clean time selected, plus the time of day. For example: if the clean time is three hours and the time of day is 6:00, the stop time that appears on display will be 9:00.

5. Touch INCREASE pad, to change the stop time to a later time of day if desired. For example: if you set stop time at 11:00, oven will start clean cycle at 8:00 and end at 11:00.

NOTE: During a delayed self-clean operation you can find out when the oven is set to turn on by pushing and holding the CLEAN pad for 3 seconds.

To Stop a Clean Cycle

1. Press the CLEAR/OFF pad.

After Self-Cleaning

You may notice some white ash in the oven. Just wipe it up with a damp cloth after the oven cools.

If white spots remain, remove them with a soap-filled steel wool pad. Be sure to rinse thoroughly with a vinegar and water mixture. These deposits are usually a salt residue that cannot be removed by the clean cycle.

If the oven is not clean after one clean cycle, repeat the cycle.

NOTE: A Bake or Broil function cannot be programmed before the door automatically unlocks.

If "F-" and a number flash on display and the control beeps, this indicates function error code. Press CLEAR/OFF pad. Allow oven to cool for one hour. Put oven back into operation. If function error code repeats, disconnect power to the oven and call for service.

(continued next page)

Operating the Self-Cleaning Oven (continued)

Questions and Answers

Q. If my oven clock is not correct, can I still self-clean my oven?

A. If the clock is not set to the correct time of day you will not be able to set a delay clean to end at a specific time.

Q. Can I use commercial oven cleaners on any part of my self-cleaning oven?

A. No cleaners or coatings should be used around any part of this oven. If you do use them and do not wipe the oven absolutely clean, the residue can scar the oven surface and damage metal parts the next time the oven is automatically cleaned.

Q. Can I clean the Woven Gasket around the oven door?

A. Yes, but carefully, and only with a clean sponge to soak the soiled area with hydrogen peroxide. See section on Preparing the Oven for Self-Clean.

Q. What should I do if excessive smoking occurs during cleaning?

A. This is caused by excessive soil. Press the CLEAR/OFF pad. Open windows to rid room of smoke. Wait until the oven has cooled (about 20-30 minutes). Wipe up the excess soil and reset the clean cycle. Don't wait too long between cleanings.

Q. Can I clean both ovens at the same time?

A. No. The control only allows one oven to clean at a time.

Q. Is the "crackling" sound I hear during cleaning normal?

A. Yes. This is the sound of the metal heating and cooling during both the cooking and cleaning functions.

Q. Should there be any odor during the cleaning?

A. Yes, there maybe a slight odor during the first few cleanings. Failure to wipe out excessive soil might also cause a strong odor when cleaning.

Q. What causes the hair-like lines on the enameled surface of my oven?

A. This is a normal condition, resulting from heating and cooling during cleaning. These lines do not affect how your oven performs.

Q. Why do I have ash left in my oven after cleaning?

A. Some types of soil will leave a deposit which is ash. It can be removed with a damp sponge or cloth.

Q. My oven shelves do not slide easily. What is the matter?

A. After many cleanings, oven shelves may become so clean they do not slide easily. If you wish shelves to slide more easily, dampen fingers with a small amount of cooking oil and rub lightly over sides of shelf where they contact shelf supports.

Q. My oven shelves have become gray after the self-clean cycle. Is this normal?

A. Yes. After the self-clean cycle, the shelves may lose some luster and discolor to a deep gray color.

Adjusting Oven Thermostat

When cooking a food for the first time in your oven, use time given on recipes as a guide. Oven thermostats, over a period of years, may "drift" from the factory setting and differences in timing between an old and a new oven of 5 to 10 minutes are not unusual. You may be inclined to think that the new oven is not performing correctly. However, your new oven has been set correctly at the factory and is more apt to be accurate than the oven it replaced.

If you think the oven should be hotter or cooler, you can adjust it yourself. To decide how much to change the temperature, set the oven temperature 25°F. higher or lower than the temperature in your recipe, then bake. The results of this "test" should give you an idea of how much the temperature should be changed.

To adjust the temperature, follow the steps below. Note: The thermostats in the upper and lower ovens need to be adjusted separately.

1. Touch BAKE pad.
2. Select an oven temperature between 500°F. and 550°F.
3. Immediately, before "ON" appears, press and hold the BAKE pad for about 4 seconds. The time display will change to the oven adjustment display.
4. The oven temperature can be adjusted up to (+) 35°F. hotter or (-) 35°F. cooler. Use the INCREASE or DECREASE pads to select the desired change in the red display.
5. When you have made the adjustment, press the CLEAR/OFF pad to go back to the time of day display. Use your oven as you would normally.

NOTE: This adjustment will not affect Broil or Clean temperatures. It will be retained in memory after a power failure.

Cleaning Guide

NOTE: Let oven parts cool before touching or handling.

PART	MATERIALS TO USE	GENERAL DIRECTIONS	
Broiler Pan and Rack	<ul style="list-style-type: none"> • Soap and Water • Soap-Filled Scouring Pad • Plastic Scouring Pad • Dishwasher-Safe 	Drain fat and COOI pan and rack slightly. (Do not let soiled pan and rack stand in oven to cool.) Sprinkle on detergent. Fill the pan with warm water and spread a damp cloth or paper towel over the rack. Let pan and rack stand for a few minutes. Wash; scour if necessary. Rinse and dry. OPTION: The broiler pan and rack may also be cleaned in a dishwasher.	
Control Panel	<ul style="list-style-type: none"> • Damp Cloth • Paper Towel • Soap and Water 	DO NOT USE abrasives, cleaning powders, steel wool or plastic scouring pads. They will mar the surface.	Wash control panel with soap and water, using a soft cloth. Rinse and dry with a soft cloth.
Outside Glass Finish	<ul style="list-style-type: none"> • Soap and Water 	Clean outside of cooled glass door with a glass cleaner that does not contain ammonia. Do not allow water to run down inside opening in the door while cleaning.	
Metal Trim	<ul style="list-style-type: none"> • Soap and Water 	DO NOT USE steel wool, abrasives, ammonia, acids or commercial oven cleaners.	To safely clean surfaces: wash, rinse, and then dry with a soft cloth. Do not allow water to run down inside the surface of the glass door while cleaning.
Porcelain Enamel and Painted Surfaces*	<ul style="list-style-type: none"> • Paper Towel • Dry Cloth • Soap and Water 	DO NOT USE oven cleaners, cleansing powders or harsh abrasives. These might scratch the surface.	If acids should spill on the oven while it is hot, use a dry paper towel or cloth to wipe them up right away. When the surface has cooled, wash and rinse. For other spills, such as fat smatterings, etc., wash with soap and water when cooled and then rinse. Polish with dry cloth.
Oven Door*	<ul style="list-style-type: none"> • Soap and Water 	DO NOT USE oven cleaners, cleansing powders or harsh abrasives.	INSIDE OF DOOR: Clean ONLY the door liner outside the gasket. The door is automatically cleaned if the oven is in the self-cleaning cycle. DO NOT allow water to run down inside the surface of the glass door while cleaning. DO NOT rub or damage the gasket. Avoid getting soap and water on the gasket or in any openings on the door. Rinse well. NOTE: Soap left on liner causes additional stains when oven is reheated. OUTSIDE OF DOOR: Use soap and water to thoroughly clean the top, sides and front of the oven door.
Oven Liner	<ul style="list-style-type: none"> • Soap and Water 	Allow to cool before cleaning. Frequent wiping with mild soap and water will prolong the time between self-cleaning cycles. Be sure to rinse thoroughly to avoid additional stains.	
Oven Gasket	<ul style="list-style-type: none"> • Hydrogen Peroxide 	See Self-Clean section for more information.	
Shelves (See Self-Cleaning Oven Directions)	<ul style="list-style-type: none"> • Soap and Water • Dishwasher-Safe 	Shelves can be cleaned with the self-cleaning function in the oven. For heavy soil, clean by hand and rinse thoroughly.	
Bake Unit and Broil Unit		Do not clean the bake unit or broil unit. Any soil will burn off when the unit is heated. NOTE: The bake unit can be lifted gently to clean the oven floor. If spillover, -esidue, or ash accumulates around the bake unit, gently wipe around the unit with warm water.	
Probe	<ul style="list-style-type: none"> • Soap and Water • Soap-Filled Scouring Pad 	Cool before cleaning. DO NOT IMMERSE IN WATER. Scour stubborn spots with soap-filled scouring pad, rinse and dry. DO NOT STORE IN OVEN.	

*Spillage of marinades, fruit juices, tomato sauces and basting materials containing acids may cause discoloration and should be wiped up immediately. Take care not to touch hot portion of oven. When surface is cool, clean and rinse,



Questions? Use This Problem Solver

PROBLEM	POSSIBLE CAUSE AND REMEDY
OVEN WILL NOT WORK	<ul style="list-style-type: none">•The circuit breaker in your house has been tripped, or a fuse has been blown.•Oven controls not properly set.
OVEN LIGHT DOES NOT WORK	<ul style="list-style-type: none">•Light bulb is loose or defective. Tighten or replace.•Control panel is broken. Call for service.
OVEN DOES NOT COOK PROPERLY	<ul style="list-style-type: none">•Aluminum foil being used improperly in oven.•Oven vent blocked,•Oven shelf not level.•Incorrect cookware being used. Check the Baking Guide for cookware tips.•Clock set incorrectly.•Controls set incorrectly. Review each cooking section.•Shelf position is incorrect. Check Baking, Roasting and Broiling Guides.
OVEN WILL NOT SELF-CLEAN	<ul style="list-style-type: none">•Oven temperature is too high to set self-clean operation. Allow the oven to cool to room temperature and reset the controls.•Probe is in oven.
OVEN DOOR WILL NOT OPEN	<ul style="list-style-type: none">•Oven must cool below locking temperature (approximately 30 minutes after the clean cycle is complete).
OVEN NOT CLEAN AFTER CLEAN CYCLE	<ul style="list-style-type: none">•Oven controls not set properly.•Heavily soiled ovens require 3½ - to 4-hour Clean Time.•Heavy spillovers should be cleaned up before starting clean cycle.
“door” APPEARS ON DISPLAY	<ul style="list-style-type: none">•Oven door not closed after self-clean cycle selected.
“F-” AND A NUMBER FLASH ON DISPLAY	<ul style="list-style-type: none">•If “F-” and a number flash on display and the control beeps, this indicates a function error code, Press the CLEAR/OFF pad. Allow oven to cool for one hour. Put oven back into operation. If function error code repeats, disconnect power to the oven. Call for service.
“OFF” APPEARS ON DISPLAY	<ul style="list-style-type: none">•Oven is too hot for Self-Clean.•Bake or Broil attempted too soon after Self-Clean.•Other oven is in Self-Clean.•Child Lockout feature turned on.

If you need more help...call, toll free:
GE Answer Center®
800.626.2000
consumer information service

We'll Be There

With the purchase of your new GE appliance, receive the assurance that if you ever need information or assistance from GE, we'll be there. All you have to do is call-toll-free!

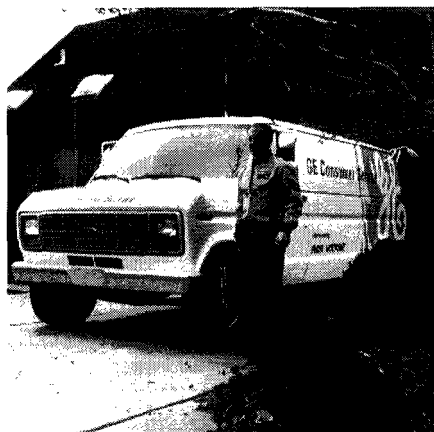

In-Home Repair Service

800-GE-CARES

(800432-2737)

AGE consumer service professional will provide expert repair service, scheduled at a time that's convenient for you. Many GE Consumer Service company-operated locations offer you service today or tomorrow, or at your convenience (7:00 a.m. to 7:00 p.m. weekdays, 9:00 a.m. to 2:00 p.m. Saturdays). Our factory-trained technicians know your appliance inside and out—so most repairs can be handled in just one visit.



Service Contracts

800-626-2224

You can have the secure feeling that GE Consumer Service will still be there after your warranty expires. Purchase a GE contract, while your warranty is still in effect and you'll receive a substantial discount. With a multiple-year contract, you're assured of future service at today's prices.

Parts and Accessories

800-626-2002

Individuals qualified to service their own appliances can have needed parts or accessories sent directly to their home. The GE parts system provides access to over 47,000 parts... and all GE Genuine Renewal Parts are fully warranted. VISA, MasterCard and Discover cards are accepted.

User maintenance instructions contained in this booklet cover procedures intended to be performed by any user. Other servicing generally should be referred to qualified service personnel. Caution must be exercised, since improper servicing may cause unsafe operation.



GE Answer Center[®]

800.626.2000

Whatever your question about any GE major appliance, GE Answer Center[®] information service is available to help. Your call—and your question—will be answered promptly and courteously. And you can call any time. GE Answer Center[®] service is open 24 hours a day, 7 days a week.

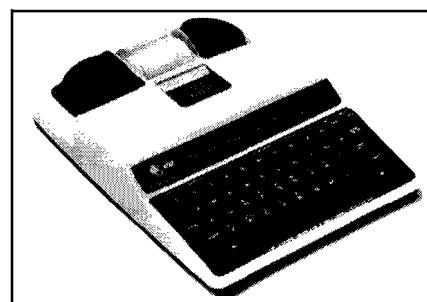

Telecommunication Device for the Deaf

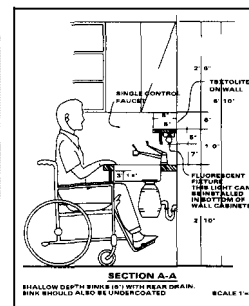
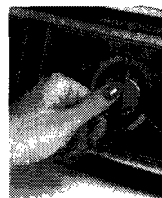

& Customers With Special Needs...

800.626.2000

Upon request, GE will provide Braille controls for a variety of GE appliances, and a brochure to assist in planning a barrier-free kitchen for persons with limited mobility. To obtain these items, free of charge, call 800.626.2000.

Consumers with impaired hearing or speech who have access to a TDD or a conventional teletypewriter may call 800-TDD-GEAC (800-833-4322) to request information or service.

YOUR GE ELECTRIC OVEN WARRANTY

Save proof of original purchase date such as your sales slip or cancelled check to establish warranty period.

WHAT IS COVERED

FULL ONE-YEAR WARRANTY

For one year from date of original purchase, we will provide, free of charge, parts and service labor in your home to repair or replace **any part of the oven** that fails because of a manufacturing defect.

This warranty is extended to the original purchaser and any succeeding owner for products purchased for ordinary home use in the 48 mainland states, Hawaii and Washington, D.C. In Alaska the warranty is the same except that it is LIMITED because you must pay to ship the product to the service shop or for the service technician's travel costs to your home.

All warranty service will be provided by our Factory Service Centers or by our authorized Customer Care® servicers during normal working hours.

Look in the White or Yellow Pages of your telephone directory for GENERAL ELECTRIC COMPANY, GENERAL ELECTRIC FACTORY SERVICE, GENERAL ELECTRIC-HOTPOINT FACTORY SERVICE or GENERAL ELECTRIC CUSTOMER CARE™ SERVICE.

WHAT IS NOT COVERED

• Service trips to your home to teach you how to use the product.

Read your Use and Care material.

If you then have any questions about operating the product, please contact your dealer or our Consumer Affairs office at the address below, or call, toll free:

GE Answer Center®
800.626.2000
consumer information service

• Improper installation.

If you have an installation problem, contact your dealer or installer. You are responsible for providing

adequate electrical, gas, exhausting and other connecting facilities as described in the Installation Instructions provided with the product.

• Replacement of house fuses or resetting of circuit breakers.

• Failure of the product if it is used for other than its intended purpose or used commercially.

• Damage to product caused by accident, fire, floods or acts of God.

WARRANTOR IS NOT RESPONSIBLE FOR CONSEQUENTIAL DAMAGES.

Some states do not allow the exclusion or limitation of incidental or consequential damages, so the above limitation or exclusion may not apply to you. This warranty gives you specific legal rights, and you may also have other rights which vary from state to state. To know what your legal rights are in your state, consult your local or state consumer affairs office or your state's Attorney General.

Warrantor: General Electric Company

**If further help is needed concerning this warranty, write:
Manager-Consumer Affairs, GE Appliances, Louisville, KY 40225**

Part No. 164D2588P079

Pub. No. 49-8275

MNU052 (Rev. 3)

JKP44G
JKP45W

Free Manuals Download Website

<http://myh66.com>

<http://usermanuals.us>

<http://www.somanuals.com>

<http://www.4manuals.cc>

<http://www.manual-lib.com>

<http://www.404manual.com>

<http://www.luxmanual.com>

<http://aubethermostatmanual.com>

Golf course search by state

<http://golfingnear.com>

Email search by domain

<http://emailbydomain.com>

Auto manuals search

<http://auto.somanuals.com>

TV manuals search

<http://tv.somanuals.com>