

# Model 28320 InfoLink Phone User's Guide



*for use as a telephone  
and to receive information from internet*

## Equipment Approval Information

Your telephone equipment is approved for connection to the Public Switched Telephone Network and is in compliance with parts 15 and 68, FCC Rules and Regulations and the Technical Requirements for Telephone Terminal Equipment published by ACTA.

### 1 Notification to the Local Telephone Company

On the bottom of this equipment is a label indicating, among other information, the US number and Ringer Equivalence Number (REN) for the equipment. You must, upon request, provide this information to your telephone company.

The REN is useful in determining the number of devices you may connect to your telephone line and still have all of these devices ring when your telephone number is called. In most (but not all) areas, the sum of the RENs of all devices connected to one line should not exceed 5. To be certain of the number of devices you may connect to your line as determined by the REN, you should contact your local telephone company.

A plug and jack used to connect this equipment to the premises wiring and telephone network must comply with the applicable FCC Part 68 rules and requirements adopted by the ACTA. A compliant telephone cord and modular plug is provided with this product. It is designed to be connected to a compatible modular jack that is also compliant. See installation instructions for details.

**US Number is located on the base bottom.**

**REN Number is located on the base bottom.**

#### Notes

- This equipment may not be used on coin service provided by the telephone company.
- Party lines are subject to state tariffs, and therefore, you may not be able to use your own telephone equipment if you are on a party line. Check with your local telephone company.
- Notice must be given to the telephone company upon permanent disconnection of your telephone from your line.
- If your home has specially wired alarm equipment connected to the telephone line, ensure the installation of this product does not disable your alarm equipment. If you have questions about what will disable alarm equipment, consult your telephone company or a qualified installer.

### 2 Rights of the Telephone Company

Should your equipment cause trouble on your line which may harm the telephone network, the telephone company shall, where practicable, notify you that temporary discontinuance of service may be required. Where prior notice is not practicable and the circumstances warrant such action, the telephone company may temporarily discontinue service immediately. In case of such temporary discontinuance, the telephone company must: (1) promptly notify you of such temporary discontinuance; (2) afford you the opportunity to correct the situation; and (3) inform you of your right to bring a complaint to the Commission pursuant to procedures set forth in Subpart E of Part 68, FCC Rules and Regulations.

The telephone company may make changes in its communications facilities, equipment, operations or procedures where such action is required in the operation of its business and not inconsistent with FCC Rules and Regulations. If these changes are expected to affect the use or performance of your telephone equipment, the telephone company must give you adequate notice, in writing, to allow you to maintain uninterrupted service.

## Interference Information

This device complies with Part 15 of the FCC Rules. Operation is subject to the following two conditions: (1) This device may not cause harmful interference; and (2) This device must accept any interference received, including interference that may cause undesired operation.

This equipment has been tested and found to comply with the limits for a Class B digital device, pursuant to Part 15 of the FCC Rules. These limits are designed to provide reasonable protection against harmful interference in a residential installation.

This equipment generates, uses, and can radiate radio frequency energy and, if not installed and used in accordance with the instructions, may cause harmful interference to radio communications. However, there is no guarantee that interference will not occur in a particular installation.

Privacy of Communications may not be ensured when using this product.

If this equipment does cause harmful interference to radio or television reception, which can be determined by turning the equipment off and on, the user is encouraged to try to correct the interference by one or more of the following measures:

- Reorient or relocate the receiving antenna (that is, the antenna for radio or television that is "receiving" the interference).
- Reorient or relocate and increase the separation between the telecommunications equipment and receiving antenna.
- Connect the telecommunications equipment into an outlet on a circuit different from that to which the receiving antenna is connected.

If these measures do not eliminate the interference, please consult your dealer or an experienced radio/television technician for additional suggestions. Also, the Federal Communications Commission has prepared a helpful booklet, "How To Identify and Resolve Radio/TV Interference Problems." This booklet is available from the U.S. Government Printing Office, Washington, D.C. 20402. Please specify stock number 004-000-00345-4 when ordering copies.

Notice: The changes or modifications not expressly approved by the party responsible for compliance could void the user's authority to operate the equipment.

## Hearing Aid Compatibility (HAC)

This telephone system meets FCC standards for Hearing Aid Compatibility.

## Licensing

Licensed under US Patent 6,427,009.

## FCC RF Radiation Exposure Statement

This equipment complies with FCC RF radiation exposure limits set forth for an uncontrolled environment. This equipment should be installed and operated with a minimum distance of 20 centimeters between the radiator and your body. This transmitter must not be co-located or operated in conjunction with any other antenna or transmitter."

For body worn operation, this phone has been tested and meets the FCC RF exposure guidelines when used with the belt clip supplied with this product. Use of other accessories may not ensure compliance with FCC RF exposure guidelines.

## Information for DECT Product





This telephone is compliant with the DECT 6.0 standard which operates in the 1.92GHz to 1.93GHz frequency range.

<b>IMPORTANT INSTRUCTIONS &amp; INFORMATION</b> .....2	<b>IDLE MODE DISPLAY</b> ..... 14
<b>EQUIPMENT APPROVAL INFORMATION</b> .....2	<b>PROGRAMMING YOUR PHONE</b> ..... 15
<b>INTERFERENCE INFORMATION</b> .....3	<b>NAVIGATING THE MENU</b> ..... 15
<b>HEARING AID COMPATIBILITY (HAC)</b> .....3	<b>HANDSET SETTINGS</b> ..... 16
<b>LICENSING</b> .....3	HANDSET NAME .....16
<b>FCC RF RADIATION EXPOSURE</b>	LANGUAGE .....16
<b>STATEMENT</b> .....3	MENU COLOR.....17
<b>INFORMATION FOR DECT PRODUCT</b> .....3	BACKGROUND PICTURE.....17
<b>INTRODUCTION</b> .....6	DISPLAY CONTRAST .....17
<b>PARTS CHECKLIST</b> ..... 6	AUTO TALK.....18
<b>INSTALLATION</b> .....7	AREA CODES .....18
<b>IMPORTANT INSTALLATION GUIDELINES</b> .....7	DEFAULT SETTINGS .....19
<b>DIGITAL SECURITY SYSTEM</b> .....7	LIST OF DEFAULT SETTINGS.....19
<b>TELEPHONE JACK REQUIREMENTS</b> .....7	<b>CONTACTS</b> ..... 20
<b>LOCATION</b> .....7	FIND ENTRY .....20
<b>INSTALLING THE HANDSET BATTERY</b> .....8	ADD ENTRY.....20
BATTERY PERFORMANCE .....8	COPY ALL NAMES .....20
BATTERY LOW WARNING .....8	PHONEBOOK STATUS.....21
BATTERY CHARGING LIGHT.....8	<b>SOUNDS</b> .....21
<b>BASE SET-UP</b> .....9	EARPIECE VOLUME.....21
ETHERNET CONNECTION .....9	RINGTONE .....21
TELEPHONE CABLE CONNECTION .....9	RINGTONE INFORMATION .....21
POWER SUPPLY CONNECTION .....10	RING VOLUME .....22
<b>HANDSET SYNCHRONIZATION*</b> ..... 10	RING VOLUME INFORMATION.....22
<b>GETTING TO KNOW YOUR PHONE</b> ..... 11	KEY BEEP .....22
<b>BASE LAYOUT</b> ..... 11	<b>BASE SETTINGS</b> ..... 22
ETHERNET INDICATOR (BLUE)..... 11	BASE IP ADDRESS .....22
DECT INDICATOR (BLUE)..... 11	<b>TIME SETTINGS</b> ..... 23
POWER INDICATOR (GREEN) ..... 11	SET DATE & TIME .....23
PAGE BUTTON ..... 11	TIME FORMAT.....23
<b>HANDSET LAYOUT</b> ..... 12	ALARM .....24
LEFT SOFT BUTTON.....13	<b>RSS SETTINGS</b> ..... 24
RIGHT SOFT BUTTON .....13	VIEW CHANNELS .....24
NAVIGATIONAL/VOLUME BUTTON.....13	CHANNEL SET UP .....25
ALERT INDICATOR.....13	RESET RSS TO DEFAULT .....25
CALL/SPEAKER BUTTON.....13	<b>OPERATING YOUR PHONE</b> ..... 26
END BUTTON.....13	<b>HELP</b> ..... 26
FLASH BUTTON .....13	FEED SET UP .....26
CALLER ID BUTTON .....13	BUTTON NAVIGATION .....26
INTERCOM/LOWER/UPPER CASE	<b>CALL LISTS</b> ..... 27
BUTTON .....13	RECEIVED CALLS LIST OR DIALED CALLS
* BUTTON.....13	LIST .....27
PAUSE/#/LOCK BUTTON .....13	DELETE CALLS LIST.....27

CALL TIMER.....	28	RSS CUSTOMIZATION .....	34
MAKING A CALL .....	28	CUSTOMIZING YOUR ON SCREEN RSS	
TO SWITCH TO SPEAKERPHONE.....	28	INFOLINK SERVICES.....	34
ANSWERING CALLS .....	28	ACCESSING THE CONFIGURATION	
ADJUSTING HANDSET/SPEAKERPHONE		PAGE.....	34
VOLUME.....	28	HANDSET MANAGEMENT .....	35
END CALL .....	28	EDIT RSS FEED.....	36
SPEAKERPHONE .....	29	PERSONALIZING YOUR CONTENT	
MAKING A CALL WITH THE		INFORMATION SERVICE.....	37
SPEAKERPHONE.....	29	INFORMATION CATEGORIES.....	38
ANSWERING A CALL WITH THE		HANDBET REGISTRATION .....	39
SPEAKERPHONE.....	29	ACCESSORY HANDBET.....	39
MUTE .....	29	FIRMWARE UPDATE .....	40
PAGING.....	30	FIRMWARE UPDATES.....	40
KEYPAD LOCK .....	30	OTHER INFORMATION.....	41
INTERCOM OPERATION.....	30	CHANGING THE BATTERY .....	41
MAKING AN INTERCOM CALL.....	30	BATTERY SAFETY PRECAUTIONS .....	41
RECEIVING AN INTERCOM CALL .....	30	TROUBLESHOOTING GUIDE .....	42
ADVANCED INTERCOM FEATURES .....	31	TELEPHONE SOLUTIONS.....	42
USING INTERCOM WITH EXTERNAL PHONE		CALLER ID SOLUTIONS.....	43
CALLS .....	31	BATTERY SOLUTIONS.....	44
TWO-WAY CALLING.....	31	GENERAL PRODUCT CARE .....	44
CONFERENCE TWO HANDSETS.....	31	CAUSES OF POOR RECEPTION .....	44
TRANSFERING A CALL .....	32	WARRANTY INFORMATION .....	45
TELEPHONE COMPANY CALLING FEATURES	32	WARRANTY ASSISTANCE.....	45
CALLER ID (CID).....	32	LIMITED WARRANTY.....	46
CALL WAITING CID.....	33	ACCESSORY INFORMATION .....	47
RECEIVING CALL WAITING CALLS ..	33	INDEX .....	48
CALLER INFORMATION DISPLAY.....	33		
IF A CALLER HANGS UP.....	33		
IF YOU FORGET A WAITING CALL..	33		

**WARNING: TO PREVENT FIRE OR ELECTRICAL SHOCK HAZARD, DO NOT EXPOSE THIS PRODUCT TO RAIN OR MOISTURE.**

 <p>THE LIGHTNING FLASH AND ARROW HEAD WITHIN THE TRIANGLE IS A WARNING SIGN ALERTING YOU OF "DANGEROUS VOLTAGE" INSIDE THE PRODUCT.</p>	<p><b>CAUTION:</b> RISK OF ELECTRIC SHOCK DO NOT OPEN</p> <p>CAUTION: TO REDUCE THE RISK OF ELECTRIC SHOCK, DO NOT REMOVE COVER (OR BACK). NO USER SERVICEABLE PARTS INSIDE. REFER SERVICING TO QUALIFIED SERVICE PERSONNEL.</p>	 <p>THE EXCLAMATION POINT WITHIN THE TRIANGLE IS A WARNING SIGN ALERTING YOU OF IMPORTANT INSTRUCTIONS ACCOMPANYING THE PRODUCT.</p>
SEE MARKING ON BOTTOM / BACK OF PRODUCT		

This User Guide provides you with all the information you need to get the most from your phone.

You must first set up your phone before you can use it. This doesn't take long and is easy to do. Just follow the simple instructions on the next few pages.

### Need help?

If trouble is experienced with this equipment, for repair or warranty information, please contact customer service at 1-800-448-0329.

Alternatively, you may find the answer in Troubleshooting Tips section at the back of this guide.

## Parts Checklist (for model 28320xx2)

Make sure your package includes the items shown here.



Base



2 Handset charge cradles



2 Handsets

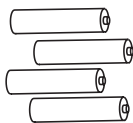

4 AAA  
Nickel-metal  
Hydride  
batteries



2 Battery  
compartment  
covers

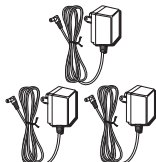

3 AC power  
adaptors

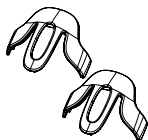

2 Belt clips



Ethernet  
cable



Telephone line  
cord



**CAUTION:** When using telephone equipment, there are basic safety instructions that should always be followed. Refer to the **IMPORTANT SAFETY INSTRUCTIONS** provided with this product and save them for future reference.

**IMPORTANT:** Because cordless phones operate on electricity, you should have at least one phone in your home that isn't cordless, in case the power in your home goes out.

**INSTALLATION NOTE:**

This product operates at a frequency of 1.9GHz. to provide communication with minimal interference from other electronic devices. To further minimize the possibility of interference, the base of the cordless telephone should not be placed near or on top of a TV, microwave oven, or VCR. If interference continues, move the cordless telephone further away from these appliances.



**WARNING: Do not place your phone in the bathroom or other humid areas.**

**Handset Range**

The range between the base and handset will vary greatly depending on the location of the base. When there is no clear line of sight between the base and handset the range will be reduced.

**Range Indicator**

The ¶ symbol on your handset screen indicates when you are in range. When you are out of range, it flashes.

**Important Installation Guidelines**

- Avoid sources of noise and heat, such as motors, fluorescent lighting, microwave ovens, heating appliances and direct sunlight.
- Avoid areas of excessive dust, moisture and low temperature.
- Avoid other cordless telephones.
- Never install telephone wiring during a lightning storm.

**Digital Security System**

Your cordless phone uses a digital security system to protect against false ringing, unauthorized access, and charges to your phone line.

**Telephone Jack Requirements**

To use this phone, you need an RJ11C type modular telephone jack, which might look like the one pictured here, installed in your home. If you don't have a modular jack, call your local phone company to find out how to get one installed.

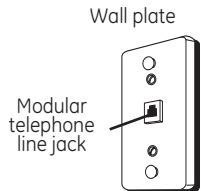
**Location**

You need to place the base within 6 feet of the AC power outlet, telephone jack, and ethernet port. Make sure it is at least 3 feet away from other electrical and metal appliances to avoid interference issues.

Your phone works by sending radio signals between the handset and base. The strength of the signal depends on where you locate the base. Putting it as high as possible and separated as much as possible from other radio devices and metal objects ensures the best signal.

Your unit is provided with three power adaptors; 2 for handset charger cradles and 1 base power. The connectors are different sizes, only the larger power adaptor is for the base unit.

## Installing the Handset Battery

1. Locate batteries and battery door which are packaged together inside a plastic bag and are separate from the handsets.
2. Locate the battery compartment on the back of the handsets.

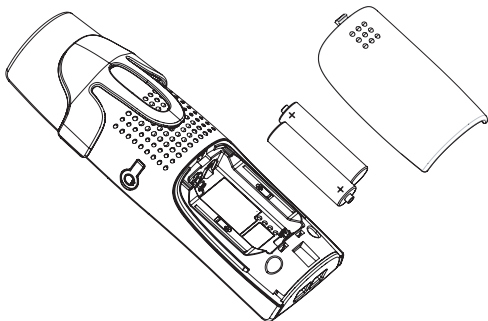

3. Insert the batteries.
4. Close the battery compartment by pushing the door up until it snaps into place.
5. Plug the AC power adaptor of the charge cradle into an electrical outlet.
6. Place the handsets in the charge cradles. The blue CHARGE indicator turns on, verifying the batteries are charging.

**Allow handset to charge for 16 hours prior to first use. If you do not properly charge the handset, battery performance is compromised.**



**CAUTION: To reduce the risk of fire or personal injury, use only the Thomson Inc. approved model GP 75AAAHC 1.2V 750mAh, rechargeable Nickel-metal Hydride AAA batteries, which are compatible with this unit.**

### Battery Performance

When batteries are fully charged the handset displays an icon of a full battery. To keep your batteries in the best condition, leave the handset off the charge cradle for a few hours at a time (after the initial 16 hour charge).

### Battery Low Warning

The handset displays a flashing icon of an "empty" battery and sounds a warning beep. Recharge your handset right away.

When charging the battery, level bars are animated.

### Battery Charging Light

The blue charging light on the handset charge cradle stays on while the handset is on the cradle, even when the batteries are fully charged.





**CAUTION:** To reduce risk of personal injury, fire, or damage use only the 5-2792 power adaptor listed in the user's guide. This power adaptor is intended to be correctly orientated in a vertical or floor mount position.

**IMPORTANT:** Do not connect the telephone line until the handset is fully charged. The base must be plugged into the AC power at all times.

**INSTALLATION NOTE:** Your InfoLink is designed for home use and will work with most any standard Internet system (non-commercial, non-corporate environments/applications). This includes wired and/or wireless routers which provide additional "hard" Firewall security functionality (HTTP Internet traffic transmits inbound and outbound via Port 80, which is typically open on most firewall set ups). However, this unit may not function properly behind a firewall that does not allow http traffic inbound and outbound on Port 80.

**The unit will not work with a dial-up internet connection.**

## Base Set-Up

The base needs a direct access connection to the internet, and the IP address of the base must be provided by a DHCP server.

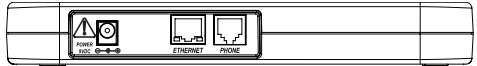

### ETHERNET Connection

1. Using the ETHERNET cable (RJ45 ) provided with your phone, connect the cable to your broadband modem or router with cable access.
2. Connect the other end of the cable to the base ETHERNET port.

### Telephone Cable Connection

To use the phone as standard telephone:

1. Plug one end of the telephone line cord into the PHONE jack on the back of the base and the other end into a modular jack.

## Power Supply Connection

1. Connect the power adaptor provided with your unit to the base.
2. Connect the adaptor to an electrical wall outlet.
3. When power is applied to the base, the unit goes through a one minute initialization process in the following sequence:
  - a) the blue DECT indicator is on (solid);
  - b) the green POWER indicator flashes;
  - c) both the blue DECT and green POWER indicators flash; and
  - d) the green POWER and blue ETHERNET indicators are on (solid).

The unit has now completed the process. The phone will not function until this process is complete.

## Handset Synchronization\*

1. After base is powered up, wait 5-7 seconds until



RSS synchronization icon briefly appears on the handset display. This indicates that the handset and base are synchronized to each other.

2. Next you will see the **RSS Service Wizard** which will guide you step by step through setup of Weather and Weather Alerts. There are some useful channels pre-configured to help get you started.

-OR-

you can bypass the Wizard at this time and return later.

3. Programmed content windows will start auto scrolling and handset is ready for use.

For more information on the RSS setup refer to: Programming Your Phone > RSS Settings

**NOTE:** Your handset will automatically display the **RSS synchronization icon** for a few seconds when the feeds are updated at approximately 15 minute intervals. During this automatic process you will not be able to search or view your RSS feeds.

\*Thomson Inc. does not warrant that the content of any website or RSS feed transmitting content to this product (InfoLink Phone) will be uninterrupted or error free. Access to streaming content through this device is subject to provider availability. Thomson Inc. does not endorse any Internet-based content or RSS feeds maintained by a third party that may be accessed using this device.

## Base Layout

---

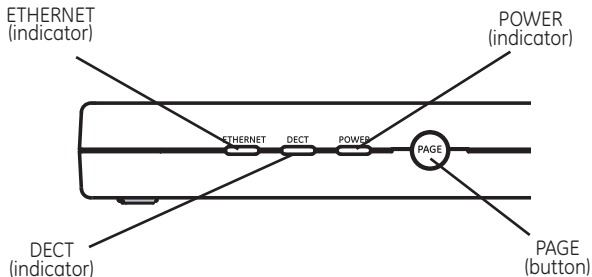

### **ETHERNET Indicator (blue)**

When flashing, indicates network error with last RSS update.

When solid, indicates properly working ethernet connection.

When off, indicates no ethernet connection.

### **DECT Indicator (blue)**

When flashing, indicates base is in handset registration mode.

When solid, indicates an active call.

When off, indicates no activity.

### **POWER Indicator (green)**

When solid, indicates base is powered.

When flashing, indicates base is in start up mode.

### **PAGE button**

Press to locate misplaced handset(s).

For more information on the Page feature refer to: Programming Your Phone > Page.

## Handset Layout

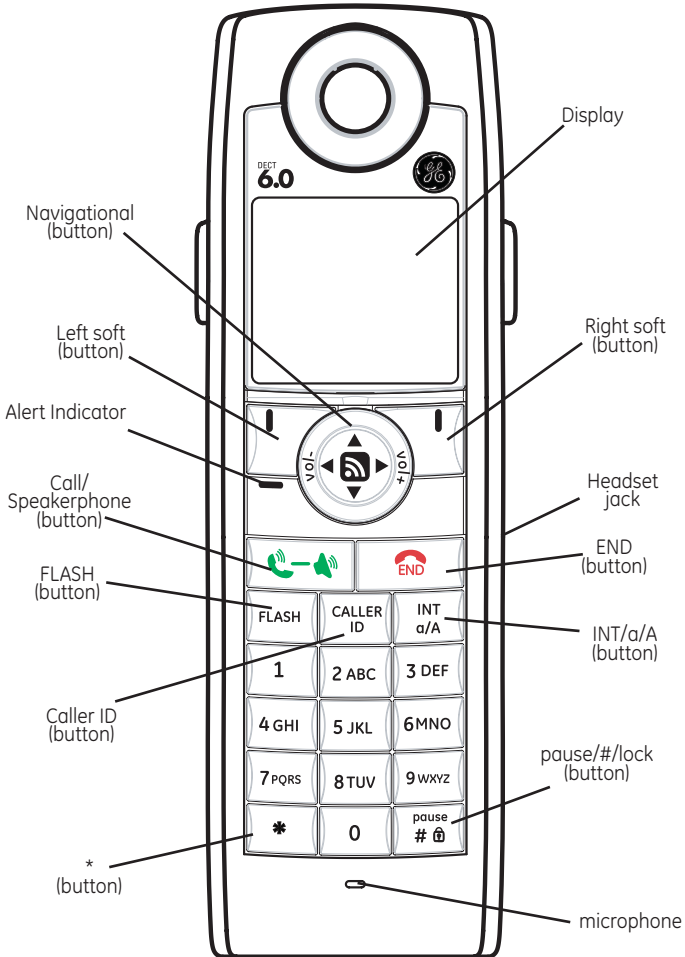

**Left soft button**

Selects the current menu item or confirms a setting, depending on the current screen.

**Right soft button**

"Back" button returns to the previous screen.

**Navigational/Volume button**

Press the outer ring to navigate up, down, left, or right while in a menu or content screen. During a call, press vol-/+ to increase or decrease the volume.

**Alert Indicator**

If flashing, indicates you have voice mail waiting or a weather warning if an RSS Weather Alert has been selected.

**Call/Speaker button**

Initiates or answers a call. During a call, activates speaker.

**End button**

Ends a call. Also returns any RSS or menu function to idle mode.

FLASH

**FLASH button**

Call Waiting acceptance; during a call, push to accept new incoming call.

CALLER  
ID**Caller ID button**

Short press to view list of received calls. Press and hold to view list of dialed calls.

INT  
a/A**Intercom/Lower/Upper case button**

Allows you to make High Definition (HD) calls between the handsets registered to the base. When in text editor, switches from lower-case to upper-case letters.

\*

**\* button**

When in text editor, provides a symbol table.









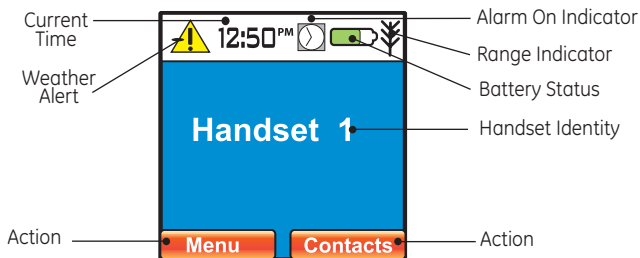



pause  
# **Pause/#/Lock button**

Allows you to input a pause while dialing or lock the keypad.

## Idle Mode Display

The idle mode display of your phone provides various status indicators and access to the menu-based interface. The illustration below shows the screen and its elements.





<b>Weather Alert</b>	<ul style="list-style-type: none"> <li>• When there is a Weather Warning issued, the warning symbol in the display flashes (as well as the red Alert Indicator). After the warning is viewed the indicator shuts off.</li> <li>• When there is a Weather Advisory or Watch only the alert symbol is displayed flashing.</li> <li>• The warning symbols in the display remain flashing until the condition for the alert has ended.</li> </ul>				
<b>Range Indicator</b>	Flashes when handset is out of range of the base.				
<b>Battery Status</b>	Indicates the status of the battery. <table style="width: 100%; border: none;"> <tbody> <tr> <td style="width: 50%; border: none;">  Low level.             </td> <td style="width: 50%; border: none;">  Fully charged.             </td> </tr> <tr> <td style="border: none;">  Partially charged.             </td> <td style="border: none;">  Charging.             </td> </tr> </tbody> </table>	 Low level.	 Fully charged.	 Partially charged.	 Charging.
 Low level.	 Fully charged.				
 Partially charged.	 Charging.				

## Navigating The Menu

Your phone has an easy to use menu system. Each menu leads to a list of options. When the handset is in idle mode, press  to open the main menu.

Press  to navigate to the menu options you want.

Press  to select further options or confirm the setting displayed, or if a new call was received it takes you to the Caller ID records. Press  to return to previous menu.

If no button is pressed within 60 seconds, the handset will return to idle mode automatically. To cancel and return to idle mode at any time press .



**The following table outlines the main menu items:**

<b>Calls Lists</b>	Access to received calls, dialed calls, and delete calls list.
<b>Handset</b>	Set preferences for handset name, language, menu color, wallpaper picture, contrast, auto talk, regional and local area codes, and default settings.
<b>Contacts</b>	Add, edit or delete entries to phonebook listings.
<b>Sounds</b>	Set preferences for volume, ringtones, ringer volume, and keypad.
<b>Base Settings</b>	Displays IP address.
<b>Time Settings</b>	Set date and time, select time format, set alarm clock feature.
<b>Registration</b>	Register and de-register handsets to base.
<b>RSS Setting</b>	View and set up RSS channels, reset RSS to default channels.
<b>Help</b>	Detailed info for use of Feed set up and navigation button.

## Handset Settings

There are eight programmable menus available: Handset Name, Language, Menu Color, Wallpaper, Contrast, Auto Talk, Area Codes (Regional & Local), and Default Settings.





### To Access Handset Settings via the Menu;

1. Make sure your phone is **OFF** (not in talk mode).
2. Press , navigate to the **Handset** menu, press  to enter.

## Handset Name

Change the name displayed on the handset's screen.







### From the **Handset** menu;

1. Use  or  to scroll to **Handset Name**.
2. Press  to enter.
3. Enter name using number pad, press  to confirm.  
The default is *InfoLink*.

## Language

Choose the display language.

### From the **Handset** menu;

1. Use  or  to scroll to **Language**.
2. Press  to enter the menu.
3. Use  or  to scroll to the desired language. The default is *ENGLISH*.
4. Press  to save your selection.

**NOTE:** If you cannot read the display language, refer to: Handset Settings> Language.

**Entering Handset Name:** It may be necessary to press  repeatedly to clear any pre-existing handset name.







There is an 8-character limit to handset name

Press the 0 button to enter a space or \* button to access symbols table.









## Menu Color

From the *Handset* menu;

1. Use  or  to scroll to **Menu Color**.
2. Press  to enter the menu.
3. Use  or  to scroll to the desired color. The default is *Blue*.
4. Press  to save your selection.







## Background Picture

From the *Handset* menu;

1. Use  or  to scroll to **Picture**.
2. Press  to enter the menu.
3. Use  or  to scroll through the selection, press  to view. The default is *Picture 4*.
4. Press  to save your selection.







## Display Contrast

From the *Handset* menu;

1. Use  or  to scroll to **Contrast**.
2. Press  to enter the menu.
3. Use  to lighten or  to darken.
4. Press  to save your selection.

## Auto Talk







From the *Handset* menu;

1. Use  or  to scroll to **Auto Talk**.
2. Press  to enter the menu.
3. Use  or  to select **Off** or **On**. The default is *Off*.
4. Press  to save your selection.

## Area Codes

Preset local and regional area codes.

From the *Handset* menu;

1. Use  or  to scroll to **Area Codes**.
2. Press  to enter the menu.
3. Use  or  to select **Local Area Code** or **Regional Area Code**.
4. Enter the three digit code. The default is - - -.
5. Press  to save your selection.

## Auto Talk

If Auto Talk is set to **On** the handset automatically answers the incoming call when the handset is ringing and lifted from the charger. (Same as pressing .

If Auto Talk is set to **Off**, you **must** press  to answer the call after the handset is lifted from the charger.

## Area Codes

The telephone uses the pre-programmed area code to determine the number format to display when a valid Caller ID record is received. The pre-programmed area code is also used for the Dialback feature.

## Regional Area Codes





Depending on your area, you may need to set regional area codes. These are needed in order for the phone to determine the number format to display when a valid Caller ID signal is received. Calls received that match any of the regional area codes display as 10 digits. If the number is not displayed correctly, the phone may not be able to dial back the number. You can store up to 5 regional area codes.

You may need to use this feature if you have:

- Multiple area codes
- Overlapping area codes
- Areas that require 10-digit dialing.

## Default Settings

From the *Handset* menu;



1. Use  or  to scroll to **Default Settings**.
2. Press  to enter the menu.
3. Press  to confirm.

## List of Default Settings:

Handset Name	Handset #	Earpiece Volume	6 Bars
Language	English	Internal Ringtone	Melody 1
Menu Color	Blue	External Ringtone	Melody 5
Background Picture	Picture 4	Ringer Volume	6 Bars
Contrast	Mid-level	Key Beep	On
Auto Talk	Off	Time Format	12 Hour
Area Codes	- - -	Alarm Tone	Off







## Contacts

### To Access Contacts via the Menu;

1. Make sure your phone is **OFF** (not in talk mode).
2. Press , navigate to the **Contacts** menu, press  to enter.







### Find Entry

#### From the **Contacts** menu;

1. Use  or  to scroll to **Find Entry**.
2. Press  to enter the menu.
3. The current list of contacts is displayed. Use  to increase or  to scroll through the contacts.
4. Press  to select contact to view details, delete entry, edit entry, copy entry to other handsets and view phonebook status.







### Add Entry

#### From the **Contacts** menu;

1. Use  or  to scroll to **Add Entry**.
2. Press  to enter the menu.
3. **Name, Home, Work, Cell** is displayed. Use  or  to scroll the list. Press  to edit entry.



### Copy All Names (to another Handset)

#### From the **Contacts** menu;

1. Use  or  to scroll to **Copy All Names**.
2. Press  to enter the menu.
3. **Handset Number** is displayed. Use  or  to scroll the list. Press  to copy entry.

## Phonebook Status



From the **Contacts** menu;

1. Use  or  to scroll to **Phonebook Status**.
2. Press  to enter the menu.
3. **Total entries** and **Free entries** is displayed.

## Sounds







Set your preferences for each handset.

**To Access Sounds via the Menu;**

1. Make sure your phone is **OFF** (not in talk mode).
2. Press , navigate to the **Sounds** menu, press  to enter.











## Earpiece Volume

From the **Sounds** menu;

1. Use  or  to scroll to **Ear Volume**.
2. Press  to enter the menu.
3. The current setting is displayed. Use  to increase or  to decrease the volume. The default is 6 bars.
4. Press  to save your selection.

## Ringtone

From the **Sounds** menu;







1. Use  or  to scroll to **Ringtone**.
2. Press  to enter the menu. Use  or  to switch between **Internal** (intercom/page) and **External** (incoming calls) and press .
3. Scroll  or . A sample is played. Press  to confirm. The default for Internal is *Melody 1*, the default for External is *Melody 5*.
4. Press  to save your selection.

### Ringtone Information

You can choose from 12 different melodies for external (regular) or internal (intercom) calls.







## Ring Volume

From the **Sounds** menu;

1. Use  or  to scroll to **Ring Volume**.
2. Press  to enter the menu.
3. The current setting is displayed. Use  to increase or  to decrease the volume. Press  to confirm. The default is 6 bars.
4. Press  to save your selection. **Ring Volume Saved** is displayed.

## Key Beep



From the **Sounds** menu;

1. Use  or  to scroll to **Key Beep**.
2. Press  to enter the menu.
3. Use  or  to switch between **Off** and **On**, press  to confirm. The default is **On**.
4. Press  to save your selection. **Key Beep On** is displayed.

## Base Settings



---

To Access Base Settings via the Menu;

1. Make sure your phone is **OFF** (not in talk mode).
2. Press , navigate to the **Base Settings** menu, press  to enter.

## Base IP Address

From the **Base Settings** menu;

1. Use  or  to scroll to **Base IP Address**.
2. Press  to enter the menu.
3. Your IP address is displayed.

## Ring Volume Information



There are six handset ringer volume levels including 'off'.

If you select ringer off, an icon is shown in the upper left side of the display. Calls will still ring at the base and your handset screen will indicate incoming calls.

**NOTE:** If you subscribe to Caller ID, the handset time is automatically updated with the first incoming call.





## Time Settings

### To Access Time Settings via the Menu;

1. Make sure your phone is **OFF** (not in talk mode).
2. Press , navigate to the **Time Settings** menu, press  to enter.







## Set Date & Time

### From the **Time Settings** menu;

1. Use  or  to scroll to **Set Date & Time**.
2. Press  to enter the menu.
3. Enter date in mm/dd format.
4. Press number keys to enter time in hh:mm format; press # for **AM** or **PM**.
5. Press  to save your selection. **Time and Date Saved** is displayed.











## Time Format

### From the **Time Settings** menu;

1. Use  or  to scroll to **Time Format**.
2. Press  to enter the menu.
3. Use  or  to switch between **12 Hour** or **24 Hour**. The default is **12 Hour**.
4. Press  to save your selection. **Time Format Saved** is displayed.



## Alarm

From the *Time Settings* menu;

1. Use  or  to scroll to **Alarm**.
2. Press  to enter the menu.
3. Press  to activate alarm.
  - On Once** - Set preferred time for single alarm.
  - On Daily** - Set preferred time for daily alarm.
  - Off** - Turn the alarm off.
4. Press  to save your selection. **Done** is displayed.
5. Use  or  to scroll to **Set Alarm Tone**:
6. Press  to hear a sample played. Scroll  or  to make another selection. The default is **OFF**.
7. Press  to save your selection. **Alarm Tone Saved** is displayed.



## RSS Settings

To Access RSS Settings via the Menu;

1. Make sure your phone is **OFF** (not in talk mode).
2. Press , navigate to the **RSS** menu, press  to enter.

## View Channels

From the **RSS** menu;

1. Use  or  to scroll to **View channels**.
2. Press  to enter.
3. The pre-configured RSS Channels are displayed.

When the alarm is activated, an icon is displayed on the main screen.

When the alarm sounds, press any button on the handset(s) to turn off the alarm.











**NOTE:** Only one handset can add new RSS feeds at a time. If more than one handset attempts to enter new RSS content you may receive - **Service Unavailable Please try later** notification.

## Channel Set Up

Selecting your preferred channels.

### From the RSS menu;

1. Use  or  to scroll to **Channel set up**.
2. Press  to enter the menu.
3. Use  or  to select a channel. (Identified by ) Press  to enter **Channel Set Up**.
4. Use  or  to scroll to the desired option;

**Pre-Configured Feeds** - Listing of all the Categories available for your selection.





**Personal RSS Feeds** - Listing of all your personal RSS Feeds. These must first be configured in the InfoLink Customization web page. Refer to section: **Personalizing your Content Information Service**

**Deactivate** - Removes the channel from your scrolling menu, (Identified by an X'd out channel number).

5. Press  to save your selection.

## Reset RSS to Default

### From the RSS menu;



1. Use  or  to scroll to **Reset RSS to Default**.
2. Press  to confirm return to default settings. You will now be prompted to customize your Weather and Weather Alert feeds for your preferred area.
3. Press  to begin customization.

## Help

---







Assistance with your feed set up and navigation buttons.

### To Access Help via the Menu;

1. Make sure your phone is **OFF** (not in talk mode).
2. Press , navigate to the **Help** menu, press  to enter.







## Feed Set Up

### From the **Help** menu;

1. Use  or  to scroll to **Feed Set Up**.
2. Press  to enter the menu.
3. Use  or  to scroll through text.
4. Press  to return to previous screen.

## Button Navigation

### From the **Help** menu;

1. Use  or  to scroll to **Button Navigation**.
2. Press  to enter the menu.
3. Use  or  to scroll through text.
4. Press  to return to previous screen.

### Received Calls

Shows details for calls which were answered or missed. A missed call is identified with an asterisk on the right side of each entry.

### Missed Calls

If you have missed calls, the main display will notify you of the presence and count of the missed calls. Press  to see the missed call.

### Dialed Calls

List shows details of the last 20 outgoing calls made from that handset.

*A combined total of 50 calls can be stored in the **Received** and **Missed calls** lists per handset.*



You can display, scroll through, and dial numbers in the Calls Lists or copy them into the phonebook.

If a call is received when the Calls List is full, the oldest entry will be replaced with details of the new call.















## Call Lists

This menu allows you to view and manage the Call Lists. You may select a caller from one of the lists to either call back, delete the number, or add to your phone book. You may also select an entire call list to delete.







### To Access Call Lists via the Menu;

1. Make sure your phone is **OFF** (not in talk mode).
2. Press , the **Call Lists** menu is displayed, press  to enter.

### Received Calls List or Dialed Calls List

1. Press  or  to scroll to **Received Calls** or **Dialed Calls** call list. Press  to enter.
2. Use  or  to scroll to desired number.
3. Press  to select.
4. Use  or  to scroll to the desired category:
  - Call** - Press  to call selected number.
  - Delete** - Press  to delete selected number. Press  to confirm.
  - Save Number** - Press  to store in phonebook. Enter name using number pad, press . Confirm (or edit) number and press .

### Delete Calls List

1. Use  or  to scroll to **Delete Calls List**. Press  to enter.
2. Use  or  to scroll to desired listing.
3. Press  to select.
4. Press  to confirm selection.

## Call Timer

The display shows the duration of the current call. After you hang up, the total duration displays briefly.

## Making a Call

1. Press , then dial the number you want.





- OR -

Dial the number first, then press .

- OR -

Press  to enter your phonebook, scroll to desired name, then press .

- OR -

Press and release  to access **Received Calls** list or press and hold  to access **Dialed Calls** list, use  or  to scroll to desired number, then press .

## Answering Calls

If Auto-Talk is set to **On** and the Handset is in the charge cradle, simply pick up the handset (when ringing) and the phone will answer the call automatically.

If the handset is in the charge cradle or Auto-talk is turned **Off**, press  to answer the call.



Providing you have subscribed to your network's Caller-ID service, the caller's number and name is displayed after the first ring.

## End Call



Press  or simply place the handset back on the charge cradle.

**NOTE:** If you make a mistake, while entering the number, press  to delete the last digit entered or multiple times to clear all digits.

### To switch to speakerphone:

At any time during a call, just press  to switch back to handset mode, press  again. While in speakerphone mode, the display will show a speakerphone icon.

### Adjusting Handset / Speakerphone Volume:





During a call, Use  to increase or  to decrease the volume level. The display will show the current level : 2 bars are the minimum and 10 bars are the maximum.

## Speakerphone

---



Speakerphone lets you talk to your caller without holding the handset to your ear. It also enables other people in the room to listen to both sides of your conversation.

### Making a Call with the Speakerphone

1. Press  for dial tone, then press  again for speakerphone mode. Dial the number. Your call will be on the handset's loudspeaker.
2. To switch back to the handset at any time, press  again, (i.e.,  toggles between the handset and the speakerphone mode).
3. Press  to end the call.

### Answering a Call with the Speakerphone



When the phone rings:

1. Press  to answer the call, then press  again for speakerphone mode. Your call will be on the handset's loudspeaker.
2. Press  to end the call.

## Mute

---

To have a private, off-line conversation with someone nearby, use the MUTE feature. The party on the telephone line cannot hear you, but you can hear them.

1. During the call, press  (**Mute**). The display shows **Mute On**. When Mute On is active, your caller cannot hear you.
2. Press  (**Off**) to return to your caller.



## Paging

You can use the button on the base to page all registered handsets to locate a missing handset.

1. Press the PAGE button on the base. All registered handsets will ring. The display shows **Paging**.
2. Press PAGE again, or press any button on a handset, to cancel the page.

## Keypad Lock



You can lock the keypad to prevent accidental dialling while carrying the handset around.

1. Press and hold  until the screen shows **Keypad Locked** and the padlock symbol appears.
2. Press  to unlock then  again to confirm.

## Intercom Operation

If you have two or more handsets registered to your base, the intercom feature allows you to have a conversation with another registered handset without tying up the telephone line, allowing you to still receive incoming calls.

### Making an Intercom Call

1. Press  then the handset number you want (1-5).
2. Press  to end the intercom call.

### Receiving an Intercom Call

When you receive an intercom call, your handset will ring (using selected Internal Ringtone). To answer the call press .

**NOTE:** You can make 911 emergency calls, while the keypad is locked.

Answer incoming calls by pressing the keypad as normal.

**NOTE:** Intercom allows the users to have a conversation in HD sound.



If you receive a telephone call during an intercom call, the intercom call is immediately terminated and both handsets ring. Either handset user may press  to answer the call.

## Advanced Intercom Features



### Using Intercom with External Phone Calls

During a telephone call, you may use the intercom function to; place the call on hold and page another handset to have an off line private (two-way) intercom conversation, have a three-way conversation between the external caller and the handsets, or transfer the external telephone call to another handset.

### Two-Way Calling

1. During a regular telephone call, press  and your call is put on hold. Enter the handset number you want (1-5).
2. When the receiving handset answers, both intercom users may speak privately. The external caller will not hear the intercom conversation.
3. When finished, press  to end the intercom call and resume the call.
4. Press  to end the call.



### Conference Two Handsets

1. During a regular telephone call, press  on the second handset to join the call.
2. Press  to end the call.

### Transferring a Call

You can transfer a call to another handset.

1. During a regular telephone call, press  and your call is put on hold. Enter the handset number you want to join on the call (1-5).

- When the other handset answers inform them they have a call, then press . The call is then transferred. If the other handset does not answer or you decide not to transfer the call, press  to cancel and resume the call.
- Press  to end the call.

## Caller ID (CID)

This unit receives and displays information transmitted by your local phone company. This information can include the phone number, date, and time; or the name, phone number, date, and time.

When you receive a call, the Caller ID information is transmitted between the first and second ring. The Caller ID information appears on the display while the phone rings, giving you a chance to monitor the information and decide whether or not to answer the call.

## Call Waiting CID

Provided you subscribe to Call Waiting CID service from your phone company; if you receive an incoming call and you are using a GE multi handset system, a beep indicates the presence of a Call Waiting call on

**IMPORTANT:** In order to use this phone's Caller ID features, you must subscribe to either the standard Name/Number Caller ID Service or Call Waiting Caller ID Service. To know who is calling while you are on the phone, you must subscribe to Call Waiting Caller ID Service.



the line. The Call Waiting Caller ID information will be displayed and stored in the history of all handsets in the system.

## Receiving Call Waiting Calls

If you receive a second incoming call while on an active call, you will hear a beep in the earpiece. The screen will identify caller and display **Answer Call?** with **Call Waiting** in the top banner.

1. Press the FLASH button to answer. The original call will be put on hold and you will be connected to the new call.
2. Press the FLASH button to go back to the original caller and put the second call on hold.
3. Press the FLASH button to toggle between callers.

## Customizing your On Screen RSS InfoLink Services

The following configuration pages provide a portal that enables you to personalize your InfoLink product.

### Accessing the Configuration Page

You will need to type in your base IP address on your computer.

1. Open your favorite internet web browser (for example, Internet Explorer or Firefox). Be sure to use direct connection setting (no proxy).
2. Using one of your registered handsets, press menu, navigate to Base Settings, press OK.
3. Screen displays **Base IP address**, press OK. IP address is displayed.
4. Enter the IP address displayed in your handset into your PC web browser.
5. Press "Go" on your PC web browser.

The following InfoLink webpage will be displayed:

InfoLink

Home Product Information Help Contact Us

InfoLink

The most advanced home phone technology can provide you the information you need for your daily life!

- Handset Alerts
  - One-Button
  - Weather Alerts
  - News
  - Sports
  - Health
  - Entertainment
  - Security
  - Tech & Science

Expandable up to 5 Handsets Only one phone jack required!

Copyright 2007 Thomson All Rights Reserved [Contact Us](#) | [GE Phones](#) | [Service Policy](#) | [InfoLink](#)

**NOTICE:** Thomson Inc. does not warrant that the content of any website or RSS feed transmitting content to this product (InfoLink Phone) will be uninterrupted or error free. Access to streaming content through this device is subject to provider availability. Thomson Inc. does not endorse any Internet-based content or RSS feeds maintained by a third party that may be accessed using this device.

## Handset Management

1. This screen provides you the option to configure each individual handset with six channels.

**InfoLink**

Home Product Information Help Contact Us

**Handset Management** [View InfoLink User page!](#)

The maximum number of feeds you can have active at one time on each phone is 6.

Customize Your Handsets

- Handset Management
- My Personal RSS Feeds
- Configuration
  - Language Settings
  - Network Parameters

Handset: 1 [Show All Handsets](#)

Ch.	Active	RSS Feeds	Copy to Handset	Select
1	<input checked="" type="radio"/>	International-News	<input type="checkbox"/>	<input type="checkbox"/>
2	<input checked="" type="radio"/>	Weather-Asia-Andam	<input type="checkbox"/>	<input type="checkbox"/>
3	<input checked="" type="radio"/>	HBBC/News	<input type="checkbox"/>	<input type="checkbox"/>
4	<input checked="" type="radio"/>	HBBC/Sports	<input type="checkbox"/>	<input type="checkbox"/>
5	<input checked="" type="radio"/>	HBBC/Health	<input type="checkbox"/>	<input type="checkbox"/>
6	<input checked="" type="radio"/>	HBBC/Entertainment	<input type="checkbox"/>	<input type="checkbox"/>

To update handsets now, click [Update Handset](#). Otherwise, changes will be taken into account in about 15 minutes.

Copyright 2017 Thomson. All Rights Reserved. [Contact Us](#) | [GE Photos](#) | [Privacy Policy](#) | [Trademarks](#)

2. You can view one handset at a time or multiple handsets (show All Handsets).
3. Channels available to view are made active by clicking On. Clicking Off will deactivate channel in handset.
4. Each handset's content channels can be configured differently or copied to another handset.
5. Clicking edit opens the Edit RSS Feed list. Each channel can be configured from a large list of feeds.
6. When finished configuring handset, click the **Update Handset** to activate changes.

## Edit RSS Feed

1. Click edit to open. Select RSS Feeds From a List.

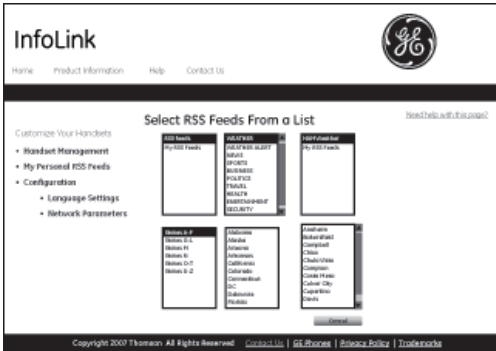

2. Step through each of the drop down lists as it is displayed to configure your personal feeds.
3. Once you have made all of your changes, simply click on the **Update Handset** button at the bottom of the page to update your preferences.
4. The phone will automatically acknowledge any changes made to the configuration file within a few minutes by showing the **RSS Synchronization** icon.
5. You can repeat this process for each of the available six channels.

**TIP:** You can find new RSS feeds by visiting web sites like [www.feedburner.com](http://www.feedburner.com) or any RSS logo on your favorite web pages.

**NOTE:** An "Invalid URL" message is displayed if the selected feed includes only graphics, audio, videos, or does not adhere to RSS standards.

**NOTE:** Also visit [www.infolinkforum.com](http://www.infolinkforum.com) to view additional RSS feeds, read frequently asked questions and provide user feedback.

## Personalizing your Content Information Service

The InfoLink GE web page enables you to personalize your RSS Feed InfoLink Services.

To personalize your handset simply:

1. Click My Personal RSS Feeds. The following screen will be displayed.



2. Enter your RSS feed in the Feed Address and press OK.
3. Your personal RSS feed will be added to My Personal RSS Feeds as shown below.

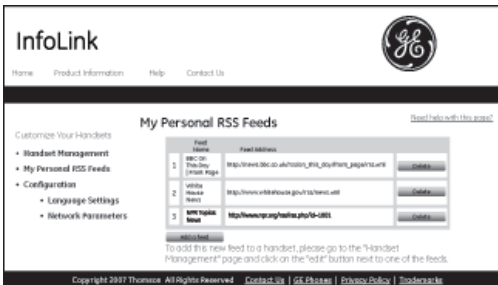

4. Return to the Handset Management screen to enter your personal feeds in the channels for each handset.

## Information Categories

Your base is preconfigured with the RSS Feed categories listed below. Each handset can be configured with any combination of feeds by entering the RSS Menu and stepping through the Channel SetUp section.

- HAMweather
- Government NOAA Weather
- Government Weather Alerts
- Government Homeland Security
- MSNBC.com News (Top, World, and US)
- MSNBC.com Entertainment
- MSNBC.com Health
- MSNBC.com Sports
- MSNBC.com Tech & Science
- MSNBC.com Business
- MSNBC.com Politics
- MSNBC.com Travel

**Auto-registration;**

Handsets packed with the base unit are pre-registered and ready to use right out-of-the-box.

**NOTE:** When a handset is associated with a base, a number is given to the handset by the base. This number is displayed on the handset after the name and must be used for internal calls.

**NOTE:** A handset can be registered to only one base.

## Accessory Handset (Purchased Separately)





---

For accessory handsets (without Base unit), an auto-registration mechanism is available so the unregistered accessory handset can be automatically registered without the need of entering a PIN code.

**On the base:**

1. Put the base into subscription mode, by pressing and holding the PAGE button for at least 8 seconds.
2. The DECT indicator light starts flashing. It is now ready to be associated with a new handset. This registration mode lasts 90 seconds after pressing the button. Once the subscription is done, the base LED flashing is switched off.

**On the handset:**

1. Make sure your phone is **OFF** (not in talk mode).
2. Press , navigate to the **Registration** menu, press  to enter.
3. Use  or  to scroll to **Register Handset**.
4. Press  to enter the menu and start the handset registration. **Wait Base searching 1"** is displayed. If the handset has located the base, it may display (depending on EEPROM settings), the base identification number (RFPI).
5. **Handset Registered** is displayed and the handset goes back to idle.
6. The DECT indicator light on the Base stops flashing when a handset has successfully been registered.

If the handset does not locate the base, it goes back to idle mode. Try again.

If the handset emits a double beep, it means that the base has reached the maximum number of 5 subscribed handsets.

## Firmware Updates

Your phone has the capability to receive Handset and Base firmware upgrades.

1. When new firmware is available, the handsets will display a New Firmware Available screen, which will ask the user if they want to perform an update.
2. You will have the option to download firmware immediately or wait until later.
3. To download the new firmware simply follow the prompts in the handset screen.
4. During the software update the base LED's will flash alternately with Power & Ethernet. The handset will display firmware update in process in the screen.
5. A firmware update notification is also displayed on the handset with specific screen and message when process is complete.

**NOTE:** It will take several minutes install new software. During this time you will not be able to use your phone.

**NOTE:** The software upgrade from the network is split into two sequences. At the end of the second sequence, the base will reboot and finish software update. The Power and Ethernet LED will be steady on.



## Changing the Battery

---



**CAUTION:** To reduce the risk of fire or personal injury, use only the Thomson Inc. approved model GP 75AAAHC 1.2V 750mAh, rechargeable Nickel-metal Hydride AAA batteries, which are compatible with this unit.

1. Make sure handset is **OFF** (not in TALK mode) before you replace battery.
2. Remove the battery compartment door.
3. Remove the batteries from the handset.
4. Insert the new batteries.
5. Put the battery compartment door back on.
6. Place handset in the base or handset charge cradle to charge. **Allow the handset batteries to properly charge (for 16 hours) prior to first use or when you install new batteries. If you do not properly charge the phone, battery performance will be compromised.**

## Battery Safety Precautions

---

- Do not burn, disassemble, mutilate, or puncture. Batteries of this type could release toxic materials which can cause injury.
- To reduce the risk of fire or personal injury, use only the **Nickel-metal Hydride** battery listed in the User's Guide.
- Keep batteries out of the reach of children.
- Remove batteries if storing over 30 days.

**NOTE:** The RBRC seal on the battery used in your Thomson Inc. product indicates that we are participating in a program to collect and recycle the rechargeable battery (or batteries).

For more information go to the RBRC web site at [www.rbrc.org](http://www.rbrc.org) or call 1-800-8-BATTERY or contact a local recycling center.

## Troubleshooting Guide

---

### Telephone Solutions

No dial tone

- Check and repeat installation steps:
    - Ensure the base power cord is connected to a working electrical outlet .
    - Ensure the telephone line cord is connected to the base and the wall jack.
  - Connect another phone to the same jack; if there is still no dial tone, the problem might be your wiring or local service.
  - The handset may be out of range of the base. Move closer to the base.
  - Ensure the batteries are installed correctly.
- 

Cannot dial

- Keypad may be locked. If the Padlock icon is on, press unlock in order to deactivate and enable the keypad.
- 

No signal icon

- The handset may be out of range of the base. Move closer to the base.
  - Register handset.
- 

Handset does not ring

- Make sure the handset ringer switch is turned ON, this can be done through the handset setup menu - Sounds - Ring Volume.
  - The handset may be out of range. Move closer to the base.
  - You may have too many extension phones on your line. Try unplugging some phones.
  - Check for dial tone.
- 

No sound from handset

- Adjust handset volume.
  - Check and adjust sound settings.
- 

You experience static, noise, or fading in and out

- The handset may be out of range of the base. Move closer to the base.
  - Make sure base is not plugged into an outlet with another household appliance. If necessary, relocate the base.
-

### Unit beeps

- Clean charging contacts on cordless handset.
  - See solutions for "No dial tone".
  - Replace the battery.
- 

### Memory Dialing doesn't work

- Did you program correctly?
  - Did you follow proper dialing sequence?
- 

Handset displays "**SEARCHING**" or "**NOT REGISTERED**" and cannot link up with the base when the TALK/CALL BACK button is pressed.

- Handset may be out of range of the base. Move closer to the base.
  - Make sure the power adaptor is properly installed.
  - Disconnect the handset battery and plug it in again. Place the handset on the cradle for at least 2 to 3 minutes.
  - Disconnect the power adaptor and plug it in again. Then place the handset on the cradle for at least 2 to 3 minutes.
- 

### Handset displays "**NOT REGISTERED**"

- Follow the programming in the telephone procedures to re-register the handset to the base.
  - Press the SELECT button to begin handset registration. Follow instructions on Handset screen.
- 

### Registration did not work

- Charge the batteries for 16 hours.
  - Unplug and then plug in the power adaptor.
- 

## Caller ID Solutions

### No Display

- Charge or replace the batteries.
  - Make sure that the unit is connected to a non-switched electrical outlet. Disconnect the AC power adaptor from the base and reconnect it.
-

### Caller ID Error Message

- The unit displays this message if it detects anything other than valid Caller ID information during the silent period after the first ring.
- 

### No Caller ID

- In order to receive Caller ID information, you must subscribe to the standard name/number Caller ID service from your local telephone company.
- 

## Battery Solutions

If you experience any of the following problems, even after fully recharging the battery, you may need to replace the battery pack:

- Short talk time
- Poor sound quality
- CHARGE/IN USE indicator on the base fails to illuminate.
- Limited range

## General Product Care

---

To keep your unit working and looking good, follow these guidelines:

- Avoid dropping the handset, as well as other rough treatment to the phone.
- Wipe the base station with a damp cloth or an antistatic wipe. Never use a dry cloth as this can cause static discharge.
- Retain the original packaging in case you need to ship the phone at a later date.
- Periodically clean the charge contacts on the handset and remote charger with a clean pencil eraser.

## Causes of Poor Reception

---

- Aluminum siding.
- Foil backing on insulation.
- Heating ducts and other metal construction that can shield radio signals.
- You're too close to appliances such as microwaves, stoves, televisions, entertainment centers, etc.
- Atmospheric conditions, such as strong storms.
- Base is installed in the basement or lower floor of the house.
- Base is plugged into AC outlet with other electronic devices.
- Handset battery is low.

## Warranty Assistance

---

If trouble is experienced with this equipment, for warranty information, please contact customer service at **1-800-448-0329**. If the equipment is causing harm to the telephone network, the telephone company may require that you disconnect the equipment until the problem is resolved.

Any unauthorized repairs, changes or modifications not expressly approved by Thomson Inc. could void the user's authority to operate this product. For instructions on how to obtain a replacement unit, refer to the warranty included in this guide or call customer service at **1-800-448-0329**.

Or refer inquiries to:

**Thomson Inc.**  
**Manager, Consumer Relations**  
**P O Box 1976**  
**Indianapolis, IN 46206**

Attach your sales receipt to this booklet for future reference or jot down the date this product was purchased or received as a gift. This information will be valuable if service should be required during the warranty period.

Purchase Date \_\_\_\_\_

Name of Store \_\_\_\_\_

## Limited Warranty

---

### What your warranty covers:

- Defects in materials or workmanship.

### For how long after your purchase:

- One year, from date of purchase.  
(The warranty period for rental units begins with the first rental or 45 days from date of shipment to the rental firm, whichever comes first.)

### What we will do:

- Provide you with a new or, at our option, a refurbished unit. The exchange unit is under warranty for the remainder of the original product's warranty period.

### How you get service:

- Properly pack your unit. Include any cables, etc., which were originally provided with the product. We recommend using the original carton and packing materials.
- "Proof of purchase in the form of a bill of sale or receipted invoice which is evidence that the product is within the warranty period, must be presented to obtain warranty service." For rental firms, proof of first rental is also required. Also print your name and address and a description of the defect. Send via standard UPS or its equivalent to:

**Thomson Inc.  
11721 B Alameda Ave.  
Socorro, Texas 79927**

- Insure your shipment for loss or damage. Thomson Inc. accepts no liability in case of damage or loss.
- A new or refurbished unit will be shipped to you freight prepaid.

### What your warranty *does not* cover:

- Customer instruction. (Your Owner's Manual provides information regarding operating instructions and user controls. Any additional information, should be obtained from your dealer.)
- Installation and setup service adjustments.
- Batteries.
- Damage from misuse or neglect.
- Products which have been modified or incorporated into other products.
- Products purchased or serviced outside the USA.
- Acts of nature, such as but not limited to lightning damage.

**Product Registration:**

- Please complete and mail the Product Registration Card packed with your unit. It will make it easier to contact you should it ever be necessary. The return of the card is not required for warranty coverage.

**Limitation of Warranty:**

- **THE WARRANTY STATED ABOVE IS THE ONLY WARRANTY APPLICABLE TO THIS PRODUCT. ALL OTHER WARRANTIES, EXPRESS OR IMPLIED (INCLUDING ALL IMPLIED WARRANTIES OF MERCHANTABILITY OR FITNESS FOR A PARTICULAR PURPOSE) ARE HEREBY DISCLAIMED. NO VERBAL OR WRITTEN INFORMATION GIVEN BY THOMSON INC., ITS AGENTS, OR EMPLOYEES SHALL CREATE A WARRANTY OR IN ANY WAY INCREASE THE SCOPE OF THIS WARRANTY.**
- **REPAIR OR REPLACEMENT AS PROVIDED UNDER THIS WARRANTY IS THE EXCLUSIVE REMEDY OF THE CONSUMER. THOMSON INC. SHALL NOT BE LIABLE FOR INCIDENTAL OR CONSEQUENTIAL DAMAGES RESULTING FROM THE USE OF THIS PRODUCT OR ARISING OUT OF ANY BREACH OF ANY EXPRESS OR IMPLIED WARRANTY ON THIS PRODUCT. THIS DISCLAIMER OF WARRANTIES AND LIMITED WARRANTY ARE GOVERNED BY THE LAWS OF THE STATE OF INDIANA. EXCEPT TO THE EXTENT PROHIBITED BY APPLICABLE LAW, ANY IMPLIED WARRANTY OF MERCHANTABILITY OR FITNESS FOR A PARTICULAR PURPOSE ON THIS PRODUCT IS LIMITED TO THE APPLICABLE WARRANTY PERIOD SET FORTH ABOVE.**

**How state law relates to this warranty:**

- Some states do not allow the exclusion nor limitation of incidental or consequential damages, or limitations on how long an implied warranty lasts so the above limitations or exclusions may not apply to you.
- This warranty gives you specific legal rights, and you also may have other rights that vary from state to state.

**If you purchased your product outside the USA:**

- This warranty does not apply. Contact your dealer for warranty information.

**Accessory Information**

DESCRIPTION	MODEL NO.
DC Power Adaptor (Main Base Unit)	5-2792
DC Power Adaptor (Handset Charge Cradle)	5-2791
Belt Clip	5-2793
Charge Cradle only	5-2794
Wired Headset	5-2713

To place order, have your Visa, MasterCard, or Discover Card ready and call toll-free 1-800-338-0376.

A shipping and handling fee will be charged upon ordering. We are required by law to collect appropriate sales tax for each individual state, country, and locality to which the merchandise is being sent. Items are subject to availability.

<b>A</b>	
Accessing the Configuration Page	34
Accessory Handset	39
Accessory Information	47
Add Entry	20
Advanced Intercom Features	31
Alarm	24
Answering a Call with the Speakerphone	29
Answering Calls	28
Area Codes	18
Auto Talk	18
<b>B</b>	
Background Picture	17
Base IP Address	22
Base Layout	11
Base Settings	22
Base Set-Up	9
Battery Safety Precautions	41
Button Navigation	26
<b>C</b>	
Call Lists	27
Call Timer	28
Call Waiting CID	33
Caller ID (CID)	32
Causes of Poor Reception	44
Changing the Battery	41
Channel Set Up	25
Conference Two Handsets	31
Contacts	20
Copy All Names	20
Customizing your On Screen RSS	
InfoLink Services	34
<b>D</b>	
Default Settings	19
Digital Security System	7
Display Contrast	17
<b>E</b>	
Earpiece Volume	21
Edit RSS Feed	36
End Call	28
Equipment Approval Information	2
ETHERNET Connection	9
<b>F</b>	
FCC RF Radiation Exposure Statement	3
Feed Set Up	26
Find Entry	20
Firmware Update	40
Firmware Updates	40
<b>G</b>	
General Product Care	44
Getting to Know Your Phone	11
<b>H</b>	
Handset Layout	12
Handset Management	35
Handset Name	16
Handset Registration	39
Handset Settings	16
Handset Synchronization*	10
Hearing Aid Compatibility (HAC)	3
Help	26
<b>I</b>	
Idle Mode Display	14
Important Installation Guidelines	7
Important Instructions & Information	2
Information Categories	38
Information for DECT Product	3
Installation	7
Installing the Handset Battery	8
Intercom Operation	30
Interference Information	3
Introduction	6
<b>K</b>	
Key Beep	22
Keypad Lock	30



<b>L</b>		<b>S</b>	
Language	16	Set Date & Time	23
Licensing	3	Sounds	21
Limited Warranty	46	Speakerphone	29
List of Default Settings.	19	<b>T</b>	
Location	7	Telephone Cable Connection	9
<b>M</b>		Telephone Company Calling Features	32
Making a Call	28	Telephone Jack Requirements	7
Making a Call with the Speakerphone	29	Time Format	23
Making an Intercom Call	30	Time Settings	23
Menu Color	17	Transferring a Call	32
Mute	29	Troubleshooting Guide	42
<b>N</b>		Two-Way Calling	31
Navigating The Menu	15	<b>U</b>	
<b>O</b>		Using Intercom with External Phone Calls	31
Operating Your Phone	26	<b>V</b>	
Other Information	41	View Channels	24
<b>P</b>		<b>W</b>	
Page Button	11	Warranty Assistance	45
Paging	30	Warranty Information	45
Parts Checklist	6		
Personalizing your Content Information Service	37		
Phonebook Status	21		
Power Supply Connection	10		
Programming Your Phone	15		
<b>R</b>			
Receiving an Intercom Call	30		
Receiving Call Waiting Calls	33		
Reset RSS to Default	25		
Ring Volume	22		
Ringtone	21		
RSS Customization	34		
RSS Settings	24		

Visit the GE website at: [www.GE.com/phones](http://www.GE.com/phones)

---



Model 28320  
00018937 (Rev. 1 Dom E/S)  
07-42 (unreleased)  
Printed in China

**Thomson Inc.**  
101 West 103rd Street  
Indianapolis, IN 46290-1102  
© 2007 Thomson Inc.  
Trademark(s) ® Registered  
Marca(s) Registrada(s)

## Free Manuals Download Website

<http://myh66.com>

<http://usermanuals.us>

<http://www.somanuals.com>

<http://www.4manuals.cc>

<http://www.manual-lib.com>

<http://www.404manual.com>

<http://www.luxmanual.com>

<http://aubethermostatmanual.com>

Golf course search by state

<http://golfingnear.com>

Email search by domain

<http://emailbydomain.com>

Auto manuals search

<http://auto.somanuals.com>

TV manuals search

<http://tv.somanuals.com>