

User
Manual

DVMRe Triplex



GE Security

All Rights Reserved.

Any GE Security software supplied with GE Security products is proprietary and furnished under license and can be used or copied only in accordance with the terms of such license.

This document contains proprietary information that is protected by copyright. No part of this document may be reproduced or transmitted in any form or by any means without the prior written permission of GE Security.

The information contained in this document is subject to change without notice. GE Security in keeping pace with technological advances is a company of product innovation. Therefore, it is difficult to ensure that all information provided is entirely accurate and up-to-date. GE Security accepts no responsibility for inaccuracies or omissions and specifically disclaims any liabilities, losses, or risks, personal or otherwise, incurred as a consequence, directly or indirectly, of the use or application of any of the contents of this document.

For the latest product specifications, visit GE Security online at www.GE-Security.com or contact your GE Security sales representative.

For technical support before and after installation, call 800-469-1676.

Technical support is available 24 hours a day, 7 days a week.

Call: **Tech Support** 800-469-1676 (6 A.M. – 5 P.M. PST Monday through Friday)

Tech Support 541-740-3589 (all other times)

Main 800-343-3358 or 541-754-9133

Fax: **Tech Support** 541-752-9096 (available 24 hours a day)

Main 541-754-7162

Web: www.ge-security.com

0150-0193G / April 2004



This equipment has been tested and found to comply with the limits for a Class A digital device, pursuant to part 15 of the FCC Rules. These limits are designed to provide reasonable protection against harmful interference when the equipment is operated in a commercial environment. This equipment generates, uses, and can radiate radio frequency energy and, if not installed and used in accordance with the instruction manual, may cause harmful interference to radio communications.

You are cautioned that any changes or modifications not expressly approved by the party responsible for compliance could void the user's authority to operate the equipment.

Contents

1	DVMRe Triplex Overview	6
1.1	Products Featured In This Manual	6
1.2	Product Description.....	6
1.3	Passwords.....	7
1.4	Unpacking	8
1.5	Installation Environment	8
1.6	Associated Equipment.....	9
1.7	The Back Panel	9
1.8	Power-Up.....	15
1.9	Minimum Recommended Menu Setup	16
2	DMVRe Triplex Basic Operations	17
2.1	Principal Operating Modes	17
2.2	The Front Panel.....	17
2.3	Live Viewing	18
2.4	Playback	19
2.5	Recording.....	21
2.6	Display Options.....	22
2.7	Active Cameos	22
2.8	Sequencing	23
2.9	On-screen Indicators	24
2.10	Triplex Mode	25
2.11	The Print Image Feature	27
3	Menu System Overview.....	29
3.1	Menu Notation In This Manual.....	29
3.2	Accessing The Menu System	29
3.3	Available Menus.....	29
3.4	Menus In This Manual.....	30
3.5	Navigating The Menu System.....	30
3.6	Menu Shortcuts.....	30
3.7	The Main Menu.....	31
3.8	Time/Date	31
3.9	Sequencing	34
3.10	Record	34
3.11	Alarms	41
3.12	Macro.....	47
3.13	Motion Detection.....	49
3.14	Camera Setup.....	52
3.15	Archive Setup.....	56
3.16	Audio Setup.....	56

3.17	Communications.....	57
3.18	Front Panel Lock.....	60
3.19	Factory Settings.....	60
3.20	Passwords.....	60
3.21	The QuickInstall Menu	62
3.22	The Operator Menu	62
3.23	The SystemView Menu.....	63
4	Alarms	67
4.1	Alarm Input.....	67
4.2	Alarm Output.....	67
4.3	Alarm Acknowledge.....	67
4.4	On-screen Displays During Alarms.....	67
4.5	Alarm Operations During Playback.....	68
4.6	Alarm History Box.....	69
4.7	Searching For Recorded Alarms	69
5	Searching	70
5.1	Disk Analysis Screen.....	71
5.2	Quick Archive to CD	71
5.3	Motion Search.....	72
5.4	Search Filters	73
5.5	Retail Search.....	74
5.6	Search Results.....	76
6	WebBrowser.....	78
6.1	WaveBrowser Overview and Controls	79
6.2	DVMRe Triplex WaveLink	81
7	Technical Specifications.....	83
8	RS232 Alarm/Event Generation/Text Insertion Protocol.....	85
8.1	Message Structure.....	85
8.2	Message Type	85
8.3	Alarm/Event Fields.....	86
8.4	Alarm Actions	86
8.5	Event Actions.....	87
9	RS232 Remote Control Protocol	88
9.1	Front Panel Button Emulation.....	88
9.2	Configuration and Status	89

10 Macro Tables..... **90**
 10.1 Macro Functions Table **90**
 10.2 Scheduled Macro Table **91**

11 Warranty and Service **92**
 11.1 Factory Service **92**
 11.2 Warranty and Return Information..... **93**

1 DVMRe Triplex Overview

1.1 Products Featured In This Manual

DVMRe -4CT: Digital Video Multiplexer Recorder, Four-Channel, Color, Triplex.

DVMRe -10CT: Digital Video Multiplexer Recorder, Ten-Channel, Color, Triplex.

DVMRe -16CT: Digital Video Multiplexer Recorder, Sixteen-Channel, Color, Triplex.

Key To Model Numbers

1. **DVMRe:** Digital Video Multiplexer Recorder, Ethernet capable.
2. **4, 10, or 16:** Maximum number of camera inputs.
3. **C:** Color.
4. **T:** Triplex.

DVMRe	16	C	T
1	2	3	4

1.2 Product Description

The DVMRe Triplex is a video multiplexer capable of recording from multiple cameras to one or more internal hard drives while simultaneously providing playback. Unlike outdated time-lapse VCRs, the DVMRe Triplex records high-resolution pictures. Digital recording improves playback quality over VCRs, and eliminates the hassle of cleaning heads, changing tapes or servicing motors. The unit can also be programmed to record continuously by overwriting the oldest recorded data. Depending on the setup, the DVMRe Triplex can store from a few hours to more than 3 years of color images.

Programmable search features eliminate time consuming Fast Forwarding or Rewinding of tapes, searching for critical data. Search for recorded images or events by alarm, time, date, motion, video loss, camera number and ASCII cash register or ATM text.



Caution! This products primary purpose is to furnish video multiplexing and recording. Although the unit has alarm handling and motion detection functions, they are considered secondary features. **This unit should not be the only alarm device on site.**

Features

- Multiplexer functionality with built-in digital recording.
- Triplex simultaneous recording, playback, and live multiscreen viewing.
- Remote programming and control through the RS232, RS485 and Ethernet ports.
- View live or recorded images remotely using WaveReader software.
- Dual multiscreen monitor displays.
- Auto-detect video mode on startup (NTSC or PAL).
- Video motion detection (intrusion and activity).
- Retail and Motion search.
- Preview search results with thumbnail images.
- Record speed selectable per camera.
- Displays include full screen, sequenced, picture-in-picture, and multiscreens.
- Alarm Handling with History Log. Pre- and post alarm recording, selectable per camera.
- Archive onto GE Security DVSe Disk Array, or RAID, DAT, AIT, or CD-Rs.
- IEEE 1394 Firewire interface for GE Security DVSe Disk Array or Firewire Disk Drives.
- Continuous Recording with simultaneous Archiving.
- PTZ control via ethernet or POTS, using CBR-KB3/J or KTD-405 keypad.
- Covert camera recording (recording without display).

- Auto-Daylight savings time change function.
- Clock synchronization with Network Server.
- Alarm Notification via email and/or TCP/IP.
- Integrated WaveBrowser Software.
- Dynamic IP addressing (DHCP).
- Support for Dynamic Domain Name Server (DDNS).
- One-touch image printing directly from the DVMRe.
- Support for over a dozen languages.
- Hard Disk monitoring and testing features.
- Playback and live audio via WaveReader on audio supported models.

1.3 Passwords

Passwords are provided to limit access to menus and certain functions. Two levels of password security are provided:

- **Operator:** Limited menu access, only Operator and System View menus are available.
- **Installer:** Complete menu access.

As a security measure, it is recommended that the Operator and Installer passwords be changed after installation is complete (see section 3.20). Store the passwords in the administrator's secure files.

Default Passwords

Four-Channel Units

Password Type	Access Level	Function	Changeable by user?	Default Password
Operator	Operator	Provides access to the Operator and SystemView menus.	Yes	Press 'ENTER' 4 Times
Installer	Installer	Provides access to all on-screen menus.	Yes	3 4 4 4
Factory Defaults	Installer	Resets the multiplexer to the factory defaults (except the time, date, email addresses, and email IP address).	No	4 1 1 1
Language	Installer	Provides access to the On-screen Language menu.	No	1 4 1 4
Ethernet Access Reset	Installer	Deactivates the ethernet password, so that the unit may be accessed by any PC equipped with WaveReader.	No	1 1 1 1

Ten and Sixteen-Channel Units

Password Type	Access Level	Function	Changeable by user?	Default Password
Operator	Operator	Provides access to the Operator and SystemView menus.	Yes	Press 'ENTER' 4 Times
Installer	Installer	Provides access to all on-screen menus.	Yes	3 4 7 7
Factory Defaults	Installer	Resets the multiplexer to the factory defaults (except the time, date, email addresses, and email IP address).	No	8 1 1 1
Language	Installer	Provides access to the On-screen Language menu.	No	5 4 1 5
Ethernet Access Reset	Installer	Deactivates the ethernet password, so that the unit may be accessed by any PC equipped with WaveReader.	No	1 1 1 1

1.4 Unpacking

Check the package and contents for visible damage. If any components are damaged or missing, do not attempt to use the unit, contact the supplier immediately. If the unit must be returned, it must be shipped in the original packing box.

Package Contents

- The DVMRe Triplex unit.
- The Alarm Interface Circuit Board (P/N 0090-0077).
- Accessory PCB (P/N 0900-0127). Audio equipped models only.
- The User Manual (P/N 0150-0193).
- A WaveReader Software CD (P/N 0151-0005-25W11).
- The WaveReader Software Manual (P/N 0150-0143).
- The Archiving Addendum (P/N 0150-0194).
- WaveWatch User Manual (P/N 0150-0189).
- Power Supply (P/N 4310-0020).
- Power Cords (**120 VAC** P/N 4310-0002) and (**220 VAC** P/N 4310-0001).

1.5 Installation Environment

Power: Ensure that the installation site's AC power is stable and within the rated voltage of the 12 Volt DC power supply. If the site's AC power is likely to have spikes or power dips, use power line conditioning or an Uninterruptable Power Supply (UPS).

Ventilation: Ensure that the location planned for the installation of the unit is well ventilated. Take note of the locations of the cooling vents in the unit's enclosure, and ensure that they are not obstructed.

Temperature: Consider the unit's operating temperature (0 to 40 °C) and non-condensing humidity specifications (10% to 80%) before choosing an installation location. Extremes of heat or cold beyond

the specified operating temperature limits may cause the unit to fail. Do not install the unit on top of other hot equipment. Leave space between rack mounted units.

Moisture: Do not expose the unit to rain or moisture. Moisture can damage the internal components. Do not install the unit near sources of water.

Chassis: Other equipment may be placed on top of the unit if it weighs less than 35 pounds (16 kilograms).

1.6 Associated Equipment

Associated equipment in a typical security system could contain the following items:

- Two monitors
- A Keyboard (KB3 or KTD405).
- Video cameras: Composite video, 1 volt peak-to-peak.
- Alarm input devices: Pressure sensors, motion detectors, etc.
- Alarm output devices: Buzzers, Sirens, Flashing Lights, etc.
- A PC connected via ethernet cable.
- An external archive device, such as a DVSe, RAID, CD-R, DAT, or AIT drive.
- Printer with Printer Server connected via ethernet cable.

For instructions regarding the connection of the associated security equipment in your system, please consult the instruction manual of the associated equipment.

1.7 The Back Panel

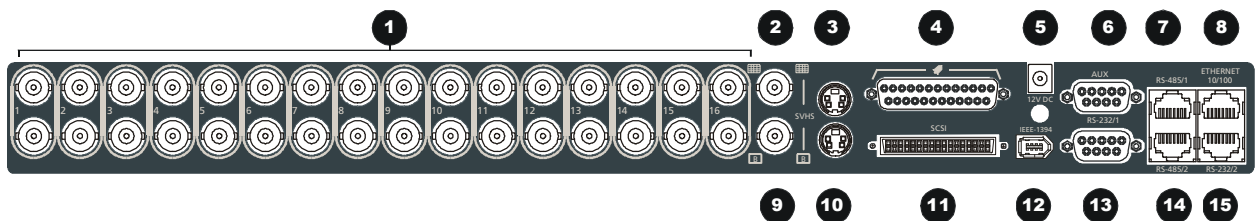

1. **Camera Inputs:** BNC connector, looping. Auto Terminating.
2. **Composite Monitor-A Output:** Composite video output with BNC style connector.
3. **Y/C Monitor-A Output:** Y/C video output with 4-pin mini-DIN style connector.
4. **Alarm I/O:** For connecting alarm inputs, and alarm output relays.
5. **Power Input:** For connecting the power supply.
6. **Aux Port:** For connecting the Accessory PCB for Audio inputs and outputs.
7. **RS485 Port 1 Connector:** For connecting to keyboard and other RS485 devices.
8. **10/100 Ethernet Port:** For connecting to remote PC via ethernet network.
9. **Composite Monitor-B Output:** Composite video output with BNC style connector.
10. **Y/C Monitor-B Output:** Y/C video output with 4-pin mini-DIN style connector.
11. **SCSI Port:** For connecting SCSI compatible archive devices.
12. **IEEE 1394 Firewire Port:** For connecting Firewire compatible archive devices.
13. **RS232 Port 1:** For modem connection and external control of the unit.

14. RS485 Port 2 Connector: For connecting to keyboard and other RS485 devices.

15. RS232 Port 2: For Event Generation and ASCII Text insertion.

Camera Inputs

There are two BNC jacks for each camera. Either jack can receive a camera signal. The signal is looped (directly connected to the other jack), making the camera signal available to other equipment.

The camera input connectors are Auto Terminating.

Cable: 75-Ohm Coaxial

Connectors: BNC

Auto Terminating: Yes

Passive Looping: Yes

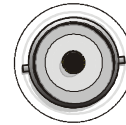

This means that the input signal will automatically be terminated with 75-Ohms unless a 2nd cable is connected to the 2nd BNC connector of the same camera input. Make sure there is 75-Ohm termination at the end of the video line if the signal is looped through the DVMRe Triplex.

Time base correction is performed during digital capture. As a result, cameras do not require synchronization.

See section 3.14 for information about disabling unused camera jacks in the menu system.

Composite Monitor Output

When connecting directly from the DVMRe Triplex to the monitor, select the 75-Ohm impedance setting on the monitor.

Cable: 75-Ohm Coaxial

Connectors: BNC

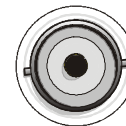

If an additional device is connected to the monitor's looping output, set the termination of the additional device as 75-Ohm, and set the termination of the monitor as Hi-Z (High Impedance).

Y/C Monitor Output

Y/C video output has a 4-pin mini-DIN style connector. This style of connection is also referred to as SVHS and S-Video.

Cable: 75-Ohm Coaxial

Connectors: BNC



Alarm I/O Port

The back panel of the unit is equipped with an Alarm Port (DB-25 style connector).

Do not attempt to wire directly to the DB-25 connector on the back panel.

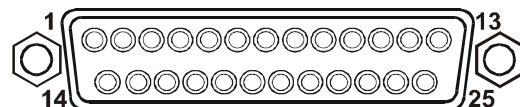

DB-25 Connector on Back Panel

Connect the Alarm PCB (supplied with the unit) to the Alarm Port. Wire all alarm inputs to the Alarm PCB per the pin out specifications shown below.

- Pin 1:** Alarm Input 1.
- Pin 2:** Alarm Input 2.
- Pin 3:** Alarm Input 3.
- Pin 4:** Alarm Input 4.
- Pin 5:** Alarm Input 5.
- Pin 6:** Alarm Input 6.
- Pin 7:** Alarm Input 7.
- Pin 8:** Alarm Input 8.
- Pin 9:** Alarm Input 9.
- Pin 10:** Alarm Input 10.
- Pin 11:** Alarm Input 11.
- Pin 12:** Alarm Input 12.
- Pin 13:** Alarm Input 13.
- Pin 14:** Alarm Input 14.
- Pin 15:** Alarm Input 15.
- Pin 16:** Alarm Input 16.
- Pin 17:** Alarm Output Relay #1.
- Pin 18:** Ground.
- Pin 19:** Ground.
- Pin 20:** Ground.
- Pin 21:** Alarm Output Relay #1 Common.
- Pin 22:** Alarm Output Relay #2.
- Pin 23:** External Alarm Silence and Acknowledge Input.
- Pin 25:** Alarm Output Relay #2 Common.

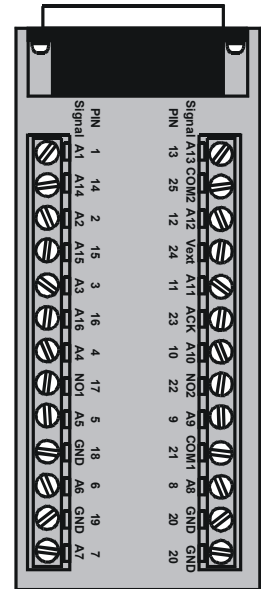

Alarm PCB

Active alarm inputs vary by DVMRe model. 4 channel units (4CT) have 4 active alarm inputs. 10 channel units (10CT) have 10 active alarm inputs.

Alarm Input

An alarm condition can be activated by devices such as pressure pads, passive infrared detectors, door switches, or other similar devices.

See section 3.11 for information about configuring the contacts as Normally Open or Normally Closed in the menu system.

Normally Open, Zero Potential Relay Contact: Configure in menu as Normally Open.

Normally Closed, Zero Potential Relay Contact: Configure in menu as Normally Closed

TTL Active High: Configure in menu as Normally Closed.

TTL Active Low: Configure in menu as Normally Open.

Open Collector Active On: Configure in menu as Normally Open.

Open Collector Active Off: Configure in menu as Normally Closed.

High: 5V (12V Tolerant)
Low: Ground
Inputs: 1 per channel.

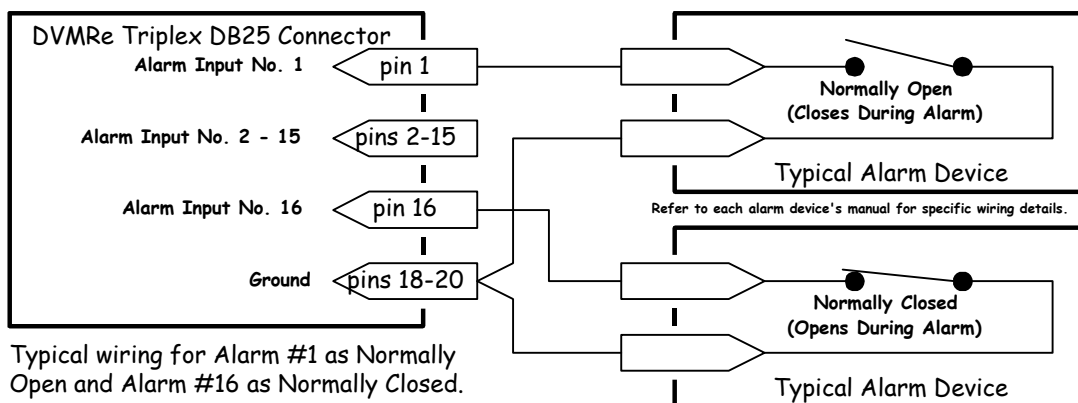

Normally Open and Normally Closed Connections

Alarm Relay Output

The alarm relay output is activated when an alarm condition exists. The alarm output is only active for the duration of the alarm.

Alarm relays can be programmed in the menu system to respond to macros, and video loss. See section 3.11 for information about configuring the alarms in the menu system.

Output: Zero potential relay contacts, programmable in menu system as Normally Open or Normally Closed.

Voltage: 30V (Max)

Current: 500mA (Max)

Typical wiring for Alarm Relays. Relays may be programmed Normally Open or Normally Closed.

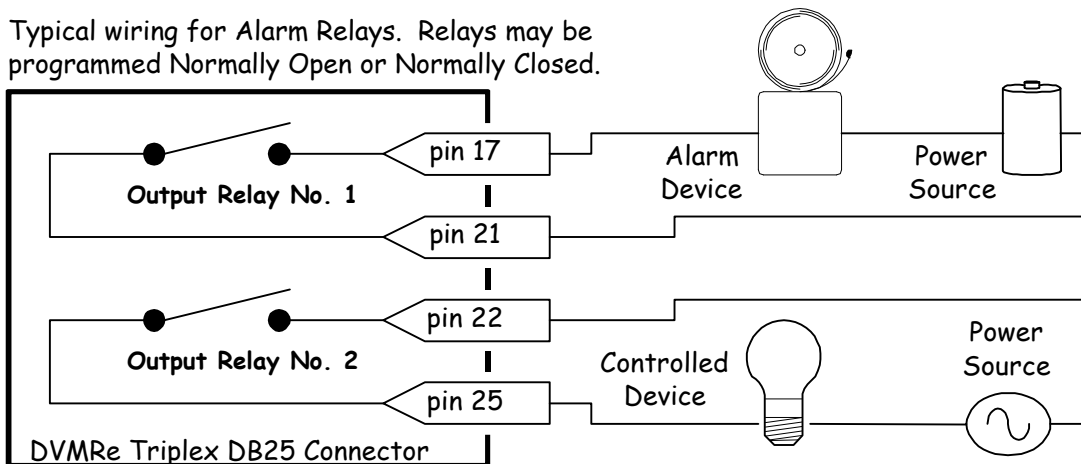

External Alarm Acknowledge Input

Connect a switch or similar device to ground this pin in order to acknowledge an alarm condition, and silence associated buzzers and relays. Connect from pin 23 to either pin 18, 19, or 20 (ground pins).

External Device: Normally Open Zero potential relay contact.



All specifications subject to change without notice. GE Security believes all specifications to be correct at time of printing, but no liability is assumed for omissions or errors.

AUX Port

The back panel of the unit is equipped with an Aux Port (DB-9 style connector).

Do not attempt to wire directly to the DB-9 connector on the back panel.

Connect the Accessory PCB (supplied with the audio equipped models) to the AUX port to access the Audio features. Wire the audio input and output to the Accessory PCB per the pin out specifications shown below.

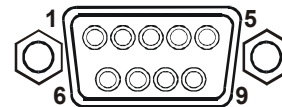

DB-9 Connector on Back Panel



Warning! The use of clandestine listening and recording devices is forbidden by Federal Law as well as other State and Municipal Jurisdictions. Please review local and Federal Law prior to the installation or operation of this equipment to ensure that you are in legal compliance with the Authorities having Jurisdiction.

- Pin 1:** Not Used.
- Pin 2:** Audio Out.
- Pin 3:** Ground.
- Pin 4:** Audio In.
- Pin 5:** Ground.
- Pin 6:** Not Used.
- Pin 7:** Ground.
- Pin 8:** Not Used.
- Pin 9:** Ground.
- GND:** Ground.

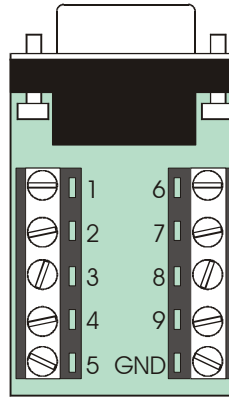

Accessory PCB

RS485 Connector

Shields are grounded at one end, preferably at the DVMRe Triplex.

See section 3.17 for information about configuring the RS485 network address settings in the menu system.

Wire Type: #24 AWG, twisted pair with shield (2-wire)

Connector Type: RJ-45

Max. Cable Length: 3200 feet / 1000 meters

RJ-45 Pin Configuration For RS485 Port

Pin	Use
1	Ground (Shield)
2	Not Connected
3	Network +VE
4	Not Connected

Pin	Use
5	Not Connected
6	Network -VE
7	Ground (Shield)
8	Not Connected

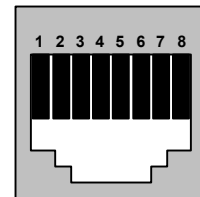

RJ-45 socket on back panel.

Ethernet Port

The cable connection configuration depends on your network configuration:

- For a DVMRe Triplex that connects directly to a Hub or Switch, use a straight through connection.
- For a DVMRe Triplex that connects directly to a PC, use a cross over connection.

Consult with your MIS personnel for the specific type of configuration. See section 3.17 for information about configuring the ethernet settings in the menu system.

Wire Type: Cat 5

Connector Type: RJ-45

Max. Cable Length: 100 meters / 328 ft.

Min. Cable Length: 6 feet / 1.8 meters

Hub Wiring Configuration: Straight Through

PC Wiring Configuration: Cross Over

RJ-45 Pin Configuration For Ethernet Port

Pin	Use
1	TX+
2	TX-
3	RX+
4	Not Connected

Pin	Use
5	Not Connected
6	RX-
7	Not Connected
8	Not Connected

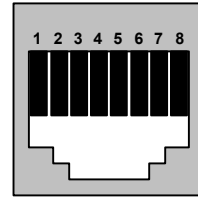

RJ-45 socket on back panel.



SCSI and IEEE 1394 archiving devices should not be connected to the DVMRe Triplex simultaneously. Archiving support is only available for one or the other type of interface at a time.

SCSI Port

The unit is equipped with a SCSI port for connecting external archive devices. The unit only supports a single SCSI device. The SCSI ID of the archive device must be set to 0.

The SCSI bus must be terminated, otherwise the system will not operate properly.

Additional menu setup may be necessary to configure archive device. See section 3.15.

Connector: 50 Pin, High Density SCSI-2.

Gender (on unit) : Female

Compatible devices : DVSe, RAID, DAT, AIT, CD-R, CD-RW

SCSI ID : 0

IEEE 1394 Firewire Port

The unit is equipped with an IEEE 1394 Firewire port for connecting Firewire compatible external archive devices. For information on the approved devices, please refer to the Archiving Addendum manual that is supplied with this unit.

Cable: 6 position Firewire

Connectors: 6 position DIP

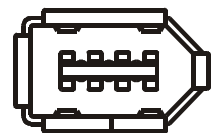

Caution! Ensure the power to DVMRe Triplex is OFF BEFORE connecting any SCSI or 1394 devices. Do not attempt to use the SCSI and 1394 ports simultaneously.

RS232 Port 1

For a Modem connection or remote control of unit. See section 3.17 for information about configuring the modem settings in the menu system. See section 9 for RS232 Remote Control Protocols.

DB-9 Pin Configuration For Port 1

Pin	Use
1	DCD
2	RX
3	TX

Pin	Use
4	DTR
5	Ground
6	Not Connected

Pin	Use
7	RTS
8	CTS
9	Not Connected

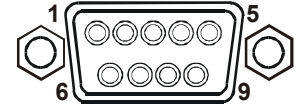

DB-9 on back panel.

RS232 Port 2

For Event Generation and ASCII Text Insertion.

RJ-45 Pin Configuration For RS232 Port 2

Pin	Use
1	Ground
2	Reserved
3	Not Connected
4	RXD

Pin	Use
5	TXD
6	Not Connected
7	Ground
8	Reserved

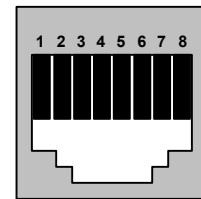

RJ-45 socket on back panel.

1.8 Power-Up

Use the diagram below to secure the power cord to the back panel.

- 1 Slide approximately 6 inches of the power cord through the pre-installed cable tie (approximately 1 inch after the ferrite core).

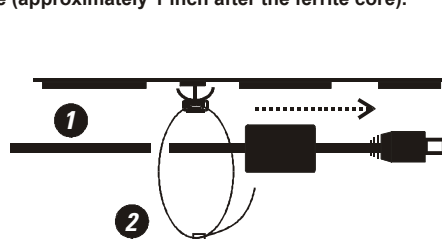

- 2 Tighten the cable tie until the cord is secure. Do not over tighten.

- 3 Loop the power cord end around and insert into the power receptacle on the back panel.

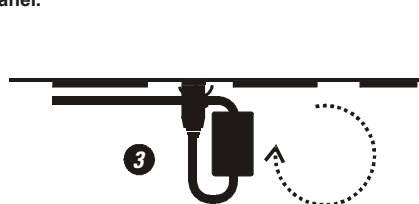

It is important that the power-up procedures be followed carefully. The unit uses its auto-detect feature to detect camera signals during power-up, and configure itself automatically.

Power-up procedure

Once the system installation is complete, apply power in the following order:

1. Energize the monitors and all of the cameras.
2. Energize the DVMRe Triplex.

Power Supply Input
Voltage: 12 Volt DC
Power: 60 Watt (5 Amp)
Connector: 2.1mm barrel, center positive

Once power is applied to the unit, it will begin its power-up procedure. The unit will begin by displaying the software version on Monitor-A, then the unit will begin recording automatically.

Check Video Input Quality

Check the picture quality by selecting each camera for full screen display. If the picture quality is poor, check the following items:

- The BNC connections.
- The loop-through terminations.
- The video levels of incoming signals.
- The possibility of ground loops.
- Consult the camera's installation instructions for additional information about proper camera setup.

Check Record And Playback Quality

Record for at least three minutes at the default record rate. Then play back the recording, selecting each camera for full screen display. Check the playback picture quality.

1.9 Minimum Recommended Menu Setup

After installation is complete, it is strongly recommended that, as a minimum, the items in the QuickInstall menu be configured before the unit is used. All the features located in the QuickInstall menu are also found in the Main menu. These items are provided in the separate QuickInstall menu as a convenience for the installer.

For information about accessing and configuring the menu system, see Section 3.

To find detailed information in this manual about configuring each item in the QuickInstall menu, use the following table to locate the main menu location of each item in the QuickInstall menu.

QuickInstall Menu Item	Main Menu Location	Section in Manual
Change the time	Main Menu → Time/Date → Set Time	3.8
Change the date	Main Menu → Time/Date → Set Date	3.8
Edit Camera Titles	Main Menu → Camera Setup → Camera Titles → Edit Titles	3.14
Camera Disable	Main Menu → Camera Setup → Camera Disable	3.14
Record Quality	Main Menu → Record → Record Quality	3.10
Installer Password	Main Menu → Passwords → Installer Password	3.20
Auto Disable Now	Main Menu → Camera Setup → Camera Disable → Auto Disable Now	3.14

2 DMVRe Triplex Basic Operations

2.1 Principal Operating Modes

The DMVRe Triplex has three principal modes of operation:

- Live Viewing.
- Playback.
- Recording.

All three of these modes can operate simultaneously. Each mode is discussed in detail later in this section.

2.2 The Front Panel

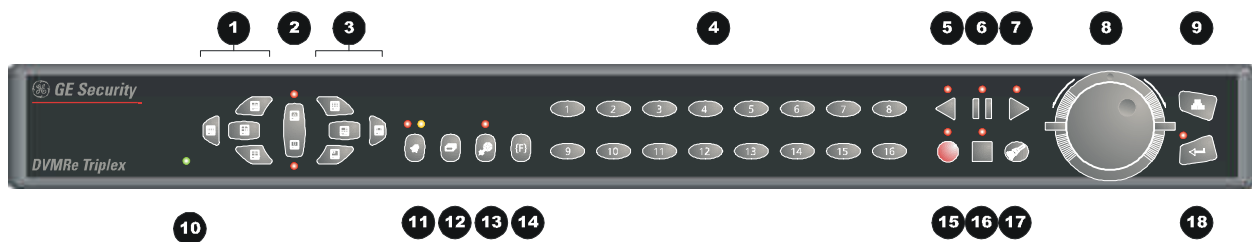

1. **Multiscreen Selection Buttons:** 16, 10, 7, and 4 way.
2. **Monitor Selection Button:** Monitor A or Monitor B.
3. **Multiscreen Selection Buttons:** 13, 9, 6 way, and Picture-in-Picture.
4. **Camera Selection Number buttons:** Camera numbers 1 through 16.
5. **Reverse Play Button:** Playback in Reverse.
6. **Freeze Button:** Freezes camera images on-screen in Live mode. Pauses Playback.
7. **Play Forward Button:** Begins Playback.
8. **Jog/Shuttle:** Controls Playback speed and Menu selections.
9. **Menu Button:** Provides access to on-screen menus.
10. **Power Indicator:** Indicates power on/off condition.
11. **Alarm button:** Allows user to acknowledge and silence alarms.
12. **Sequence Button:** Sequences camera views.
13. **Zoom Button:** Provides a 2X digital zoom.
14. **Function Button:** Used in conjunction with Camera Buttons to run Macros.
15. **Record Button:** Used to Start and Stop Recording.
16. **Stop Button:** To stop Playback and return to Live mode.
17. **Search Button:** Access to stored video data.
18. **Enter Button:** Confirms selection in menus.

2.3 Live Viewing

Multiscreen Display

In Live Multiscreen mode, press one of the **Multiscreen** buttons to activate the multiscreen display on Monitor-A or Monitor-B. Live Multiscreens are displayed with gray borders. For detailed information about Multiscreen displays, see section 2.6.

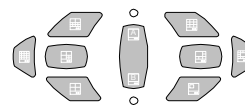

Multiscreen Buttons

Multiscreen Display With Sequencing

If a multiscreen display does not include all of the cameras, the remaining cameras can be sequenced in the bottom right cameo. While in a multiscreen display, press the **Sequence** button to begin sequencing. For detailed information about sequencing, see section 2.8.



Sequence Button

Full Screen Display

Select any camera for Full Screen display by pressing the **Number** button of the desired camera. Pressing the Camera number button again displays the Status Display Box. Pressing the same button a third time displays any associated ATM or cash register ASCII text, see section 2.9.



Number Button

Sequenced Full Screen Display

While in a Full Screen display, press the **Sequence** button to begin full screen sequencing. The sequence list and dwell times are programmable. For detailed information about programming the sequence list see section 2.8. For detailed information about configuring the dwell times in the menu system, see section 0.



Sequence Button

Zooming

To activate the 2x digital zoom, select the full screen display of the camera you wish to zoom, then press the **Zoom** button. Zooming will be indicated by the LED located directly above the **Zoom** button. Zooming is also indicated as **ZOOM** on the primary monitor. Zooming works with frozen and non-frozen images. Zoomed images can also be frozen.



**Zoom Button
with LED**

While Zoomed, rotate the **Jog/Shuttle** to Pan and Tilt across the image. Please note, the camera does not move during digital Pan/Tilt.

Press the **Zoom** button again to cancel the Zoom operations.



If the **Zoom** button is pressed while in a multiscreen display, the camera from the last active cameo is selected for full screen display. Press the **Zoom** button again to activate the Zoom operation.

Freezing

Pressing the **Freeze** button freezes all camera images on-screen. Full Screen freezing is indicated as **FRZ** on-screen. Multiscreen freezing is indicated as * (a flashing asterisk) in each frozen cameo.

Individual cameos can be frozen in Active Cameo mode (see section 2.7).

Press the **Freeze** button again or any camera button to cancel Freeze operations.



Freeze Button

Selecting Monitor-B

To control Monitor-B, press the lower part of the **Monitor** button. The Monitor-B LED will light to indicate that the number keypad now controls Monitor-B. Press the upper part of the **Monitor** button again to return the keypad control to Monitor-A.



Monitor Button

2.4 Playback

Playback always displays on Monitor A. Playback multiscreen borders are black, as opposed to the gray borders of the live multiscreens. Monitor B continues to display full or multiscreen live images in playback mode. To begin playback, press the **Play Forward** or **Reverse Play** button.

Play Forward

When the Play Forward button is pressed, the unit will play forward at the rate the data was recorded. While in Playback mode, the user may change the playback direction, playback speed, etc. To return to Play Forward operations, press the **Play Forward** button.

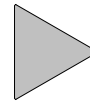

Play Forward Button

Reverse Play

To begin reverse playback, press the **Reverse Play** button.

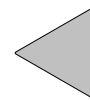

Reverse Play Button

Fast Forward

During playback, rotate the **Shuttle** (the outer dial) clockwise to view data at a higher than normal rate. Increasing the amount of rotation increases the rate of playback.

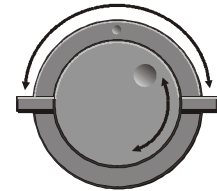

Jog / Shuttle

AutoPause

During playback, moving the **Jog** (the inner dial) in any direction will freeze playback. Depress the **Freeze** or any Play button to continue playback.

Rewind

During playback, rotate the **Shuttle** counter-clockwise to view data (in reverse) at a higher than normal rate. Increasing the amount of rotation increases the rate of playback.

Freeze

During playback, press the **Freeze** button. This feature pauses all full screen and multiscreen images



Freeze Button

Single Frame Advance & Single Frame Rewind

During Freeze or Pause mode, rotate the **Jog** (the inner dial) to view the frame directly before or after the frame displayed on-screen.

Stop Playback

To stop playback and return to Live Multiscreen mode on Monitor A, press the **Stop** button.

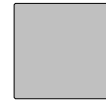

Stop Button

Multiscreen Display

During Playback, press one of the **Multiscreen** buttons to activate a multiscreen display. The 6-way and PIP multiscreen displays are not available in Playback mode. For detailed information about Multiscreen displays, see section 2.6.

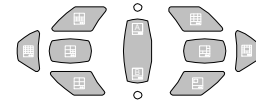

Multiscreen Buttons

Multiscreen Display With Sequencing

If a multiscreen display does not include all of the cameras, the remaining cameras can be sequenced in the bottom right cameo. While in a multiscreen display, press the **Sequence** button to begin sequencing. For detailed information about sequencing, see section 2.8.



Sequence Button

Full Screen Display

Select any camera for Full Screen display by pressing the **Number** button of the desired camera. Pressing the Camera number button again displays the Status Display Box. Pressing the same button a third time displays any associated ATM or cash register ASCII text.



Number Button

Sequenced Full Screen Display

While in a Full Screen display, press the **Sequence** button to begin full screen sequencing. The sequence list and dwell times are programmable. For detailed information about programming the sequence list see section 2.8. For detailed information about configuring the dwell times in the menu system, see section 0.



Sequence Button

Zooming

To activate the 2x digital zoom, select the full screen display of the camera you wish to zoom, then press the **Zoom** button. Zooming will be indicated by the LED located directly above the **Zoom** button. Zooming is also indicated as **ZOOM** on the monitor. Zooming works with frozen and non-frozen images. Zoomed images can also be frozen.

While Zoomed, use the **Jog/Shuttle** to Pan and Tilt across the image. Please note, the camera does not move during digital Pan/Tilt.

Press the **Zoom** button again, or another camera button to cancel the Zoom operations.



Zoom Button with LED



If the **Zoom** button is pressed while in a multiscreen display, the camera from the last active cameo is selected for full screen display. Press the **Zoom** button again to activate the Zoom operation.

Searching Recorded Data

The DVMRe Triplex has a powerful search interface feature that allows the user to search for data on the internal hard disk or an external archive device. The user may search the data for previous recording sessions, retail data, text insertion, alarm conditions, or for motion in a selectable area of the

scene. Because the search interface is so dynamic, the search interface is covered in detail in a separate section of this manual. See section 5.

2.5 Recording

To begin recording, press the **Record** button. Recording will be indicated by the LED located directly above the **Record** button. The unit always starts recording at the end of previously recorded data.

The unit will continue recording until the record button is pressed again.

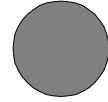

Record Button

Monitor Displays During Recording

Multiscreen Live and Playback displays on Monitor A and Monitor B are not affected by recording operations.

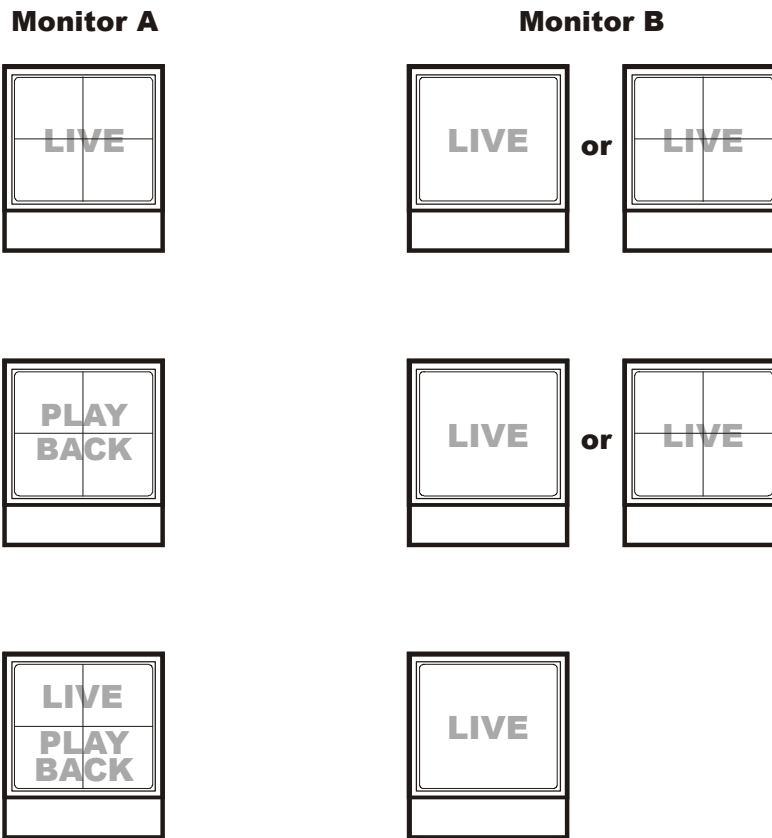

2.6 Display Options

Available Multiscreen Displays

Press the **Multiscreen** buttons to activate the multiscreen display. Pressing the individual multiscreen button will display the corresponding multiscreen.

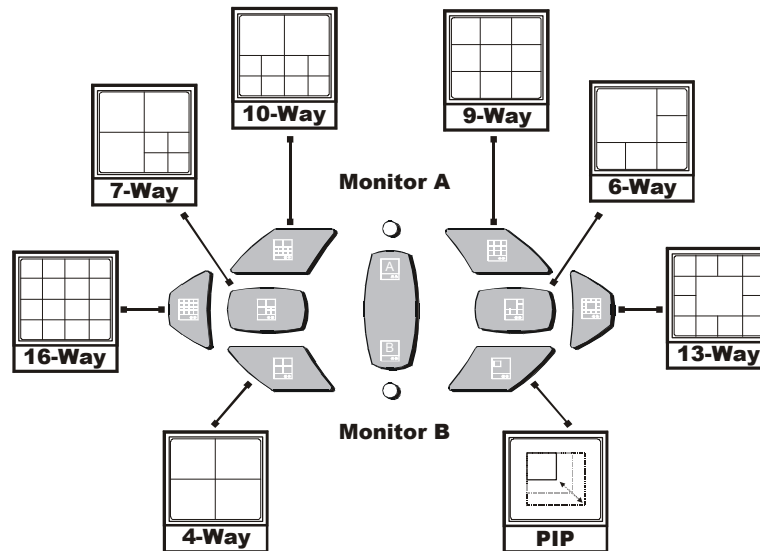

The multiscreen display is limited to the number of camera inputs on the unit.

Sixteen-Channel unit: Capable of displaying all multiscreens.

Ten-Channel unit: Only capable of displaying 10-way through 4-way multiscreen and PIP.

Four-Channel unit: Only capable of displaying 4-way multiscreen and PIP.

The camera assignments for each multiscreen is retained (in non-volatile memory) for both Live and Playback multiscreen mode on Monitor A, as well as Live multiscreen mode on Monitor B.

PIP: Use the Jog/Shuttle to adjust the location and size of the PIP display. Please note that the PIP display is only available on Monitor A in Live mode, when Monitor B is in fullscreen display mode.

2.7 Active Cameos

A cameo is defined as any cell within a multiscreen display. Active Cameo mode allows the user to access and edit each cameo individually.

Entering Active Cameo Mode

While viewing a multiscreen, enter Active Cameo mode by pressing the **Enter** button. Active Cameo mode is indicated on-screen by flashing the number and titles of the active cameo and the LED above the Enter button is lit. By default, the top left cameo is activated.

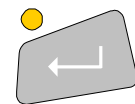

Enter Button

Selecting Cameos

Select a cameo using the **Jog/Shuttle** to navigate the multiscreen. Rotating the Jog selects the next screen up or down a row. Rotating the shuttle selects the next screen in numerical order. The active cameo will always be indicated by the flashing camera number and titles.

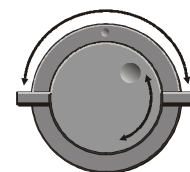

Jog/Shuttle

Selecting Cameras

Display any camera in the active cameo by pressing the **Number** button of the desired camera. Once a camera has been selected, the active cameo advances to the next cameo on the right.



Number Button

The camera selection only changes the multiscreen currently being displayed. Each multiscreen must be configured separately. Changes to the multiscreen display are saved in non-volatile memory, and will be retained even if power is removed from the unit.

Freezing

Press the **Freeze** button to freeze the image in the selected cameo. Each frozen cameo is indicated as * (a flashing asterisk) on-screen.

Press the **Freeze** button again to cancel Freeze operations.



Freeze Button

2.8 Sequencing

The sequencing feature allows a camera to be displayed briefly on-screen, before advancing to the next camera in the sequence list. The default sequence list displays each camera in numerical order.



Sequence Button

Dwell Time

The dwell time is the amount of time each camera is displayed on-screen before advancing to the next camera. The Full Screen and Multiscreen Dwell Times are separately programmable in the menu system. For detailed information about configuring the dwell times in the menu system, see section 0.

Autolist™ Custom Sequence List

The Autolist™ feature allows the user to create a custom sequence list, controlling the order the cameras are displayed and the dwell time. Separate Autolists may be created for Monitor A (Live and Playback mode) and Monitor B (Live mode). Using the **Monitor** button, select the monitor to be programmed. Then, using a **Number** button, select any camera for full screen display.



The unit must be in Full Screen Display mode before starting to create the sequence list. This initial camera is not part the sequence list.

To begin recording the Autolist™ sequence: Press the **Alarm** button and **Sequence** button simultaneously. Autolist Program mode is indicated as **PGM** on-screen.

Recording starts when the first camera number is pressed. Press the camera numbers in the order you wish them to appear on-screen. The amount of time between button presses determines the Dwell Time. During sequence list programming, pressing any button other than a **Number** button or the **Sequence** button voids the sequence list.

To end the recording: Press the **Sequence** button. The amount of time between pressing the last **Number** button and the **Sequence** button determines the dwell time for the final camera in the sequence list.



Alarm Button and Sequence Button

Returning To The Default Sequence List

The default sequence list is all cameras in numeric order with a three second dwell time.

To return the unit to the default sequence list, go to the **Main Menu** ® **Sequencing** ® **Full Screen Dwell** menu. Select 03 seconds by rotating the **Jog**, then press the **Enter** button.

Note: Any alteration of the dwell time from this menu will cancel the sequence list and return to the default (numeric) order.

Sequencing In Cameos

While viewing a multiscreen display, additional cameras (cameras not shown in the multiscreen display) can be sequenced in the lower right hand cameo by pressing the **Sequence** button. The sequence list is not programmable, but the dwell time can be adjusted in the menu system. Press the **Sequence** button again to cancel sequencing.

2.9 On-screen Indicators

There are five types of on-screen indicators.

Camera Titles: Displays the camera number and the camera title.

Status Indicators: Displays Time, Date, and Hard Disk record time left.

Conditional Indicators: Displays indicators for Freeze, Zoom, Alarm, Motion Detection, Videoloss, Autolist™ Program mode, Macro Record and Macro Playback mode.

Status Display Box: Displays Archive Device, Network status and Image Quality Setting (Playback mode only).

Text Display Box: Displays ATM/POS Text data.

Camera Titles

Camera Titles are displayed on either the upper or lower corner of the left hand side of the screen. The camera title can be changed in the menu system (see section 3.14). The user can change display position and color. See below.

Changing Position And Color Of Title And Status Indicators

Camera Titles: To change the color and position of the camera titles, select a camera for full screen display, then press the **Enter** button to advance to the next display setting. Repeatedly pressing the **Enter** button advances the display settings through the sequence show in the table on the right.

Example: Select **Camera 1** for full screen display. Using the **Enter** button, cycle through the sequence shown on the right. Each time the position cycle is completed, the unit advances the Status Indicator color. Choose Black, White or Gray.

Position	Color
Top Left	Black
Top Left	White
Top Left	Gray
Bottom Left	Black
Bottom Left	White
Bottom Left	Gray
Title not displayed	

Status Indicators

Status indicators are displayed on the upper right hand corner of the screen.

Status indicators include:

- Time and Date (these can be turned off in the menu system, see section 3.8). The Time and Date format can also be changed in the menu system.
- Time remaining on Hard Disk(s).

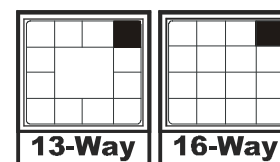

Small Cameo

Conditional Indicators

Condition	Full Screen Indicator	Multiscreen Indicator
Alarm	ALM	A in cameo of camera in alarm
Autolist™ Program mode	PGM	PGM
Freeze	FRZ	* (Asterisk) in frozen cameo
Macro Record mode	F followed by macro number	F followed by macro number
Motion Detection	M	M in cameo w/ motion detection
Videoloss	VDL	V in cameo with videoloss
Zoom	ZOOM	ZOOM

Status Display Box

A Status Display Box can be viewed by pressing the Camera Number button twice. Status Indicators include:

On Live Fullscreen:

- Archive Status: **Not Connected, Not Ready, Ready, Ejecting, Play**, and *timeleft*. *Timeleft* indicates the amount of time before the archive medium is full (Only available if the unit has Background Archiving turned On).
- Network: Displays all current Network connections. Normal connection is displayed as **ip.ip** or --- if there is no connection. Live connections are displayed as **E1: ip.ip, E2: ip.ip, etc.** (where ip.ip represents the last 2 bytes of the IP Address). POTS connection is displayed as **IP 1.1**.

On Playback Fullscreen:

- All the above, including Image Quality Setting: **High, Medium, Standard**.

ATM/POS Text Display

Pressing the Camera Number a third time displays an ATM/POS text display. This feature can be used during live viewing mode to verify that the DVMRe Triplex is receiving ATM/POS text, or in Playback mode to review recorded text and video.

2.10 Triplex Mode

Triplex mode allows the display of both live and playback images to appear on Monitor A simultaneously. Live images have gray borders, while playback images have black borders.

To enter Triplex mode, press the Play Forward button while in Play Forward mode. Alternatively, press the Play Reverse button while in Play Reverse mode. Both the Play Forward LED and the Stop LED turn on to indicate that the unit is in Triplex mode.

Monitor B always switches to a fullscreen live display whenever Triplex mode is entered.

Play Forward

When in Play Forward mode and the Play Forward button is pressed, the unit will enter the Triplex mode of operation. When Play Forward is pressed again, the unit will revert back into the normal Playback mode. While in the Triplex mode, if reverse play is in progress, the Play Forward button will change the playback direction.

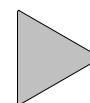

**Play Forward
Button**

Reverse Play

When in Reverse Play mode and the Reverse Play button is pressed, the unit will enter the Triplex mode of operation. When Reverse Play is pressed again, the unit will revert back into the normal Playback mode. While in the Triplex mode, if forward play is in progress, the Reverse Play button will change the playback direction.

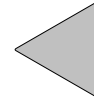

Reverse Play Button

Fast Forward

During Triplex mode, rotate the **Shuttle** (the outer dial) clockwise to view playback images at a higher than normal rate. Increasing the amount of rotation increases the rate of playback. Live images are not affected.

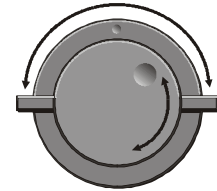

Jog / Shuttle

Rewind

During Triplex mode, rotate the **Shuttle** counter-clockwise to view playback images (in reverse) at a higher than normal rate. Increasing the amount of rotation increases the rate of playback. Live images are not affected.

Freeze

During Triplex mode, pressing the **Freeze** button pauses all multiscreen images, both Live and Playback.



Freeze Button

Single Frame Advance & Single Frame Rewind

During Freeze or Pause mode, rotate the **Jog** (the inner dial) to view the frame directly before or after the frame displayed on-screen. Only the playback images are affected.

Stop

To stop Triplex mode and return to Live mode on Monitor A, press the **Stop** button.



Stop Button

Multiscreen Display

During Triplex mode, press one of the **Multiscreen** buttons to activate a multiscreen display. The 6-way and PIP multiscreen displays are not available in Triplex mode. For detailed information about Multiscreen displays, see section 2.6. The Live and Playback images in a multiscreen display may be transposed by pressing the multiscreen button that corresponds with the current multiscreen display.

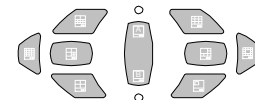

Multiscreen Buttons

E.g. If the current display is a 13-way multiscreen with the center cameo being a playback image and the rest of the cameos being live images, pressing the 13-way multiscreen button will result in the center cameo being live and the rest of the cameos being playback images.

Multiscreen Display With Sequencing

The bottom right cameo of any multiscreen will start sequencing when the Sequence button is pressed. If this camera is a playback image, the sequencing will include all the non-displayed playback cameras, and vice versa for a live image.



Sequence Button

Full Screen Display

Select any camera for Full Screen display by pressing the **Number** button of the desired camera. Pressing the Camera number button again displays the Status Display Box. Pressing the same button a third time displays any associated ATM or cash register ASCII text.



Number Button

Sequenced Full Screen Display

While in a Full Screen display, press the **Sequence** button to begin full screen sequencing. The sequence list and dwell times are programmable. For detailed information about programming the sequence list see section 2.8. For detailed information about configuring the dwell times in the menu system, see section 0.



Sequence Button

Zooming

To activate the 2x digital zoom, select the full screen display of the camera you wish to zoom, then press the **Zoom** button. Zooming will be indicated by the LED located directly above the **Zoom** button. Zooming is also indicated as **ZOOM** on the monitor. Zooming works with frozen and non-frozen images. Zoomed images can also be frozen.

While Zoomed, use the **Jog/Shuttle** to Pan and Tilt across the image. Please note, the camera does not move during digital Pan/Tilt.

Press the **Zoom** button again, or another camera button to cancel the Zoom operations.



**Zoom Button
with LED**



If the **Zoom** button is pressed while in a multiscreen display, the camera from the last active cameo is selected for full screen display. Press the **Zoom** button again to activate the Zoom operation.

2.11 The Print Image Feature

Pressing the **Function and Zoom** button will print the currently displayed image. If any multiscreen is the display mode, the Triplex will switch to a single image display of the last selected fullscreen camera, freeze the image, and send to the default printer.

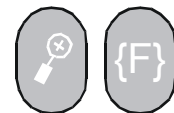

**Zoom and Function
Button**

Printer Setup

The following equipment and conditions are required for the operation of the Print Image feature.

Equipment

HP DeskJet 3820

Hawking Print Server PN7127P

Conditions

The Printer and Print Server must be connected to the same local network as the Triplex.

The Triplex must be aware of the Print Server's IP address. The IP address can be input under **Main Menu – Communications – Ethernet – Ethernet Settings** (See Section 3.15).

The Printer and Print Server must be On-line and Operational.

3 Menu System Overview

3.1 Menu Notation In This Manual

In the following sections, there are headings like this:

☐ **Main Menu → Time/Date → Set Time**

Meaning: From the Main Menu, select Time/Date, then press the **Enter** button. The Time/Date menu will appear. From the Time/Date menu, select Set Time, then press the **Enter** button. A pop-up or pull-down menu will appear.

Selected Items

Items selected in the menu system are represented in the manual as follows:



3.2 Accessing The Menu System

Enter the menu system by pressing the **Menu** button. A Password Box will appear on the primary monitor. Enter either the:

- **Operator Password:** Providing limited access to the menu system. Only the Operator and System View menus are available.
- **Installer Password:** Providing complete menu access.

Use the **Number** buttons to enter the appropriate password.

Default passwords are provided in the beginning of this manual, in section 1.

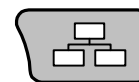

Menu Button

3.3 Available Menus

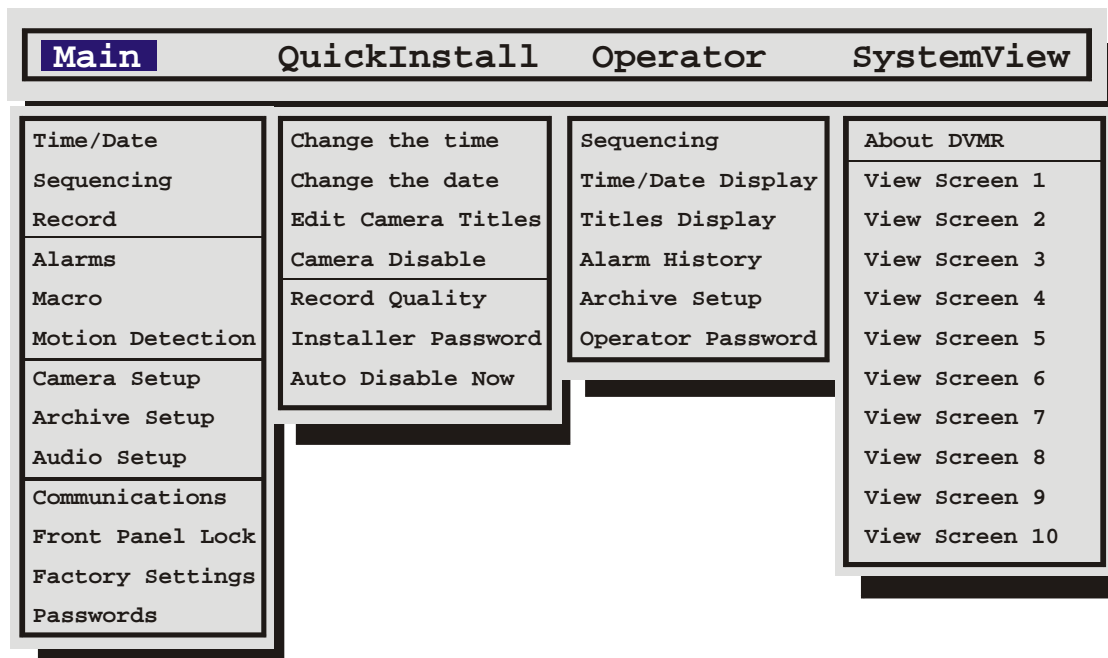

3.4 Menus In This Manual

Each menu is covered in detail in this chapter of this manual. Menus and Menu Items appear in the manual in the same order they appear on-screen.

- **Main Menu**
- **QuickInstall Menu**
- **Operator menu**
- **SystemView Menus**

3.5 Navigating The Menu System

Selecting a Menu from the Menu Bar: When the menu system is first accessed, only the menu bar is displayed. Use the **Shuttle** to select the desired menu.

Opening the Drop Down Menus: Rotate the **Jog**.

Navigating in Menus: Rotate the **Jog** to highlight items in the drop-down menus.

Selecting Menu Items: Hit the **ENTER** button to select the highlighted menu item.

Exiting Menus: Press the **Menu** button to exit a menu. From the menu bar, press the **Menu** button to exit the menu system completely.

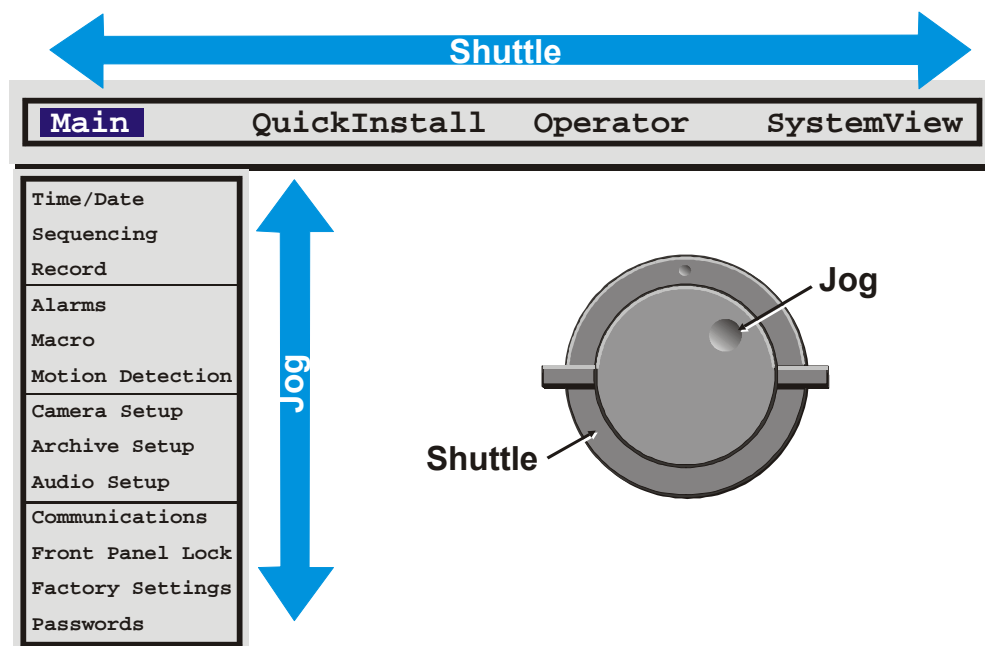

3.6 Menu Shortcuts

Zoom Button: In menu lists that have 2 settings per camera, the Zoom button will toggle all selections. This provides a quick and easy way to enable or disable all cameras for a particular feature.

Camera Button: In menu lists that provide settings per camera, a particular camera may be accessed directly by pressing on the associated camera button. Rotate the Shuttle to modify the setting.

3.7 The Main Menu

Main Menu Overview

The Main menu contains the majority of programmable options for the DVMRe Triplex. Each item in the Main menu is described in detail in this section of the manual.

Main menu items appear in this section in the same order they appear in the menu.

3.8 Time/Date

Use this menu to specify:

- Which monitors will display the time and date.
- The time format: 12 or 24 hours.
- The date format: MM/DD/YY, YY/MM/DD, or DD/MM/YY.
- The time and date.
- Whether the unit's clock is a master or slave.
- Set Regional Daylight Savings Time.
- Setup clock synchronization between Triplex and Network Server.

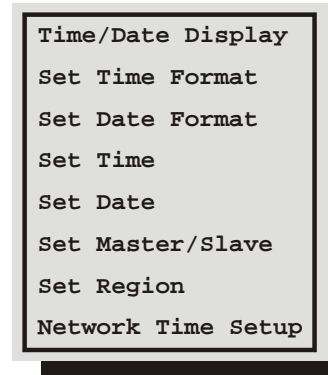

☐ Main Menu → Time/Date → Time / Date Display

Use this menu to specify if the time and date will be displayed on:

- Monitor-A.
- Monitor-B.
- Both Monitors.
- Not Displayed

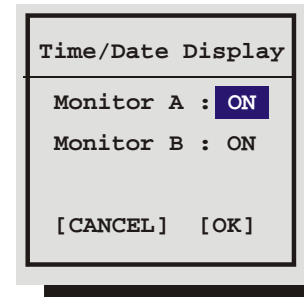

Rotate the **Jog** to navigate, then rotate the **Shuttle** to change the values.

Save changes and exit the menu: Select **[OK]**, then press the **Enter** button.

Exit the menu without making changes: Press the **Menu** button, or select **[CANCEL]**, then press the **Enter** button.

☐ Main Menu ® Time/Date ® Set Time Format

Rotate the **Jog** to set the desired time format. Select from either:

- 12 Hour
- 24 Hour

Press the **Enter** button to confirm the selection and exit the menu.

Press the **Menu** button to exit the menu without making changes.

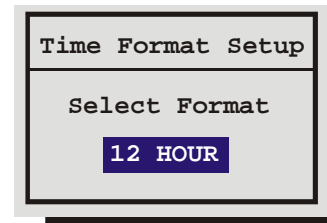

❑ Main Menu ® Time/Date ® Set Date Format

Rotate the **Jog** to set the desired date format. Select from either:

- MM/DD/YY
- DD/MM/YY
- YY/MM/DD

Press the **Enter** button to confirm the selection and exit the menu.

Press the **Menu** button to exit the menu without making changes.

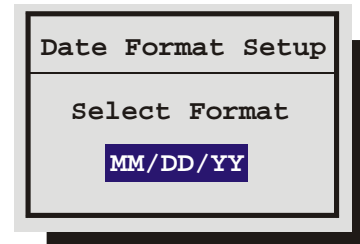

❑ Main Menu ® Time/Date ® Set Time

1. Rotate the **Shuttle** to navigate, highlight **HH MM SS**.
2. Press the **Enter** button, the highlighting will move to the row of numbers.
3. Enter the time in Hours, Minutes, and Seconds. Rotate the **Jog** to change the values and the **Shuttle** to navigate.
4. Press the **Enter** button to confirm the selection and exit the edit mode.
5. **To save the changes and exit the menu:** Rotate the **Jog** to select **[OK]**, then press the **Enter** button.
6. **To exit the menu without making changes:** Rotate the **Jog** to select **[CANCEL]**, then press the **Enter** button.

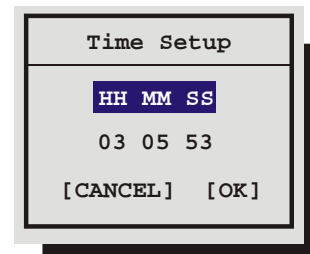

❑ Main Menu ® Time/Date ® Set Date

1. Press the **Enter** button, the highlighting will move to the row of numbers.
2. Enter the date in Months, Days, Years. The day of the week is calculated automatically. Rotate the **Jog** to change the values and the **Shuttle** to navigate.
3. Press the **Enter** button to confirm the selection and exit the edit mode.
4. **To save the changes and exit the menu:** Rotate the **Jog** to select **[OK]**, then press the **Enter** button.
5. **To exit the menu without making changes:** Rotate the **Jog** to select **[CANCEL]**, then press the **Enter** button.

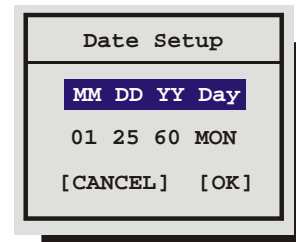

❑ Main Menu ® Time/Date ® Set Master / Slave

If several multiplexers are installed and connected via RS485 network, one of the multiplexers may be set as the master clock. This unit will control the date and time (including daylight savings time) for all of the other units.

Select **One** unit from the RS485 network as the master clock by selecting **YES** in this menu. **All other units must be set as NO (Default).**

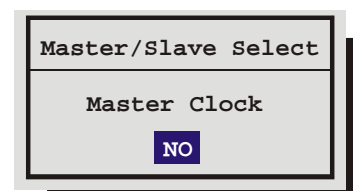

☐ Main Menu ® Time/Date ® Set Region

Use this menu to set the region for the Auto Daylight Savings Time feature. Choices are:

- **OFF:** Clock will not be changed automatically, but can still be adjusted by one hour using the daylight saving macros.
- **USA:** DST starts at 02:00 on the first Sunday in April. DST ends at 02:00 on the last Sunday in October. Includes: United States (except Hawaii, American Samoa, Guam, Puerto Rico, Virgin Islands, parts of Indiana and Arizona) and Canada (except Saskatchewan).
- **EUR:** DST starts at 01:00 GMT on the last Sunday in March. DST ends at 01:00 GMT on the last Sunday in October. Includes: European Union Countries.
- **AUS:** DST starts at 02:00 on the last Sunday in October. DST ends at 03:00 on the last Sunday in March. Includes: South Australia, Victoria, ACT, NSW. Excludes: Tasmania.

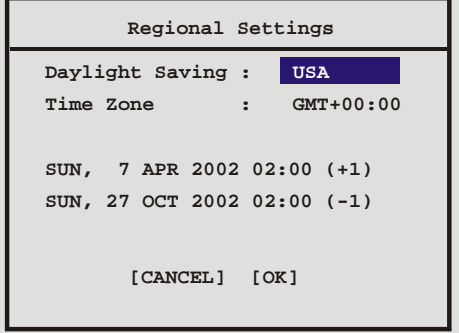

```
Regional Settings
-----
Daylight Saving : USA
Time Zone      : GMT+00:00

SUN,  7 APR 2002 02:00 (+1)
SUN, 27 OCT 2002 02:00 (-1)

[CANCEL] [OK]
```

The Time Zone must be set correctly to ensure that the DST adjustments are made at the right time. It is also required for accurate email time stamping.



The clock will only be automatically adjusted once on a given time and date. If you manually set the clock back before the last DST change, the time will not get automatically adjusted again for that same time change.

☐ Main Menu → Time/Date → Network Time Setup

Use this menu to enable/disable and specify how often time synchronization should occur between the Triplex and the Network Server. The Region /Time Zone must be setup prior to enabling the option.

Update Interval, Select from: Enable, Disable, Once per Day, Twice per Day, and Once per Hour

NTP Primary Server: Enter IP Address of Primary Server.

NTP Backup Server: Enter IP Address of Backup Server.

1. To save changes and exit the menu: Select **[OK]**, then press the **Enter** button.
2. To exit the menu without making changes: Press the **Menu** button, or select **[CANCEL]**, and then press the **Enter** button.

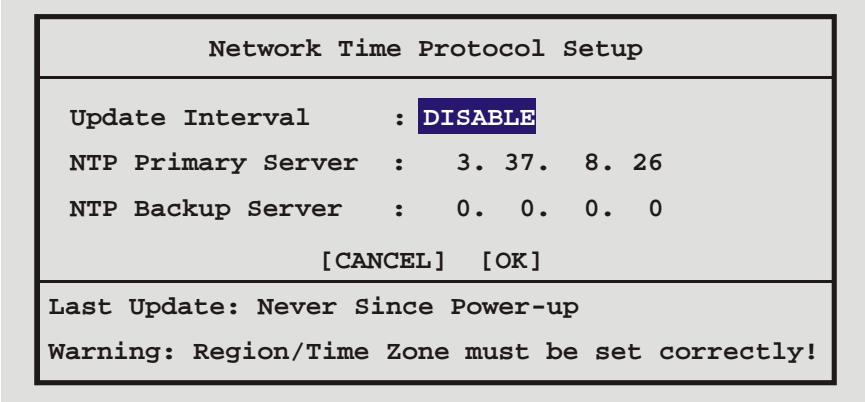

```
Network Time Protocol Setup
-----
Update Interval      : DISABLE
NTP Primary Server   : 3. 37. 8. 26
NTP Backup Server    : 0. 0. 0. 0

[CANCEL] [OK]

Last Update: Never Since Power-up
Warning: Region/Time Zone must be set correctly!
```

3.9 Sequencing

Use this menu to specify:

- The multiscreen dwell time.
- The full screen dwell time.

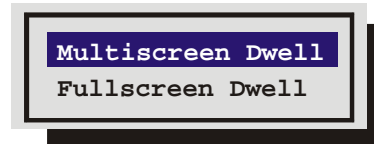

The dwell time is the amount of time each camera is displayed on-screen (while sequencing) before advancing to the next camera.

□ Main Menu ® Sequencing ® Multiscreen Dwell

Rotate the **Jog** to change the desired dwell time (from 1 to 30 seconds).
The default is 3 seconds.

1. Press the **Enter** button to confirm the selection and exit the menu.
2. Press the **Menu** button to exit the menu without making changes.

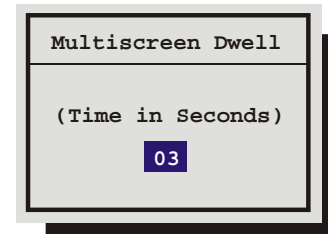

□ Main Menu ® Sequencing ® Fullscreen Dwell

Rotate the **Jog** to change the desired dwell time (from 1 to 30 seconds).
The default is 3 seconds.

1. Press the **Enter** button to confirm the selection and exit the menu.
2. Press the **Menu** button to exit the menu without making changes.



3.10 Record

Use this menu to:

- Specify the record quality: High, Medium, or Standard.
- Specify if a camera is to be used for event recording, time-lapse recording, or both.
- Specify the time-lapse record rate per camera.
- Specify the event record rate per camera.
- Specify the activity record rate per camera.
- Specify the alarm record rate.
- Set the Record Lock feature.
- Perform disk maintenance by Deleting, Un-deleting, or Destroying previously recorded video.
- Specify how the unit will handle data overwrite issues once the hard disk becomes full.

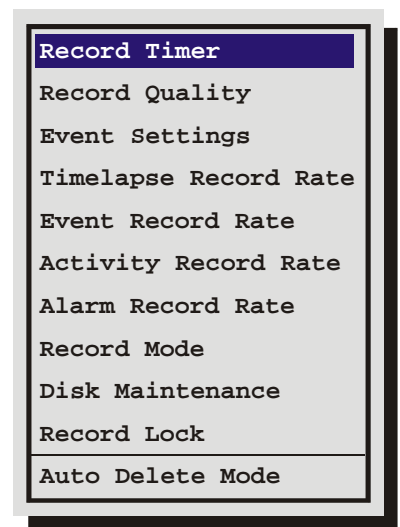

❑ Main Menu ® Record ® Record Timer

Use this menu to setup Preset Record Timer Events.

1. Rotate the **Shuttle** to select a timed event from the list.
2. Press the **ENTER** button to enter the **Edit** mode.
3. Rotate the **Shuttle** to navigate to the desired field.
4. Rotate the **Jog** to change the values of the selected field.
5. Press the **Enter** button to exit the **Edit** mode.
6. Rotate the **Jog** to highlight the **[OK]** field and press the **ENTER** button to save the changes.

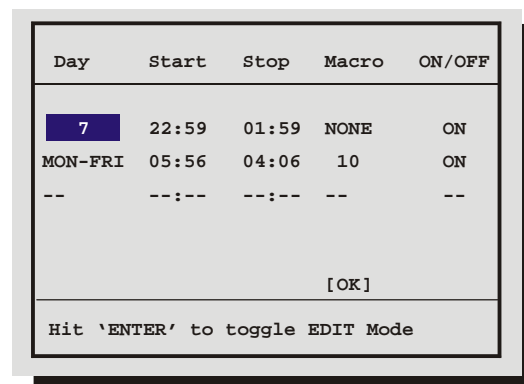

❑ Main Menu ® Record ® Record Quality

Use this menu to specify the record quality for each camera. Decreasing the record quality decreases the amount of disk space required to store the images, due to a higher compression scheme.

Record Quality	Picture Quality	Disk Space Needed
High	Excellent	Most
Medium	Good	Medium
Standard	Fair	Least

3. Rotate the **Jog** to navigate, and the **Shuttle** to change the values.
4. To save changes and exit the menu: Select **[OK]**, then press the **Enter** button.
5. Exit the menu without making changes: Press the **Menu** button, or select **[CANCEL]**, and then press the **Enter** button.

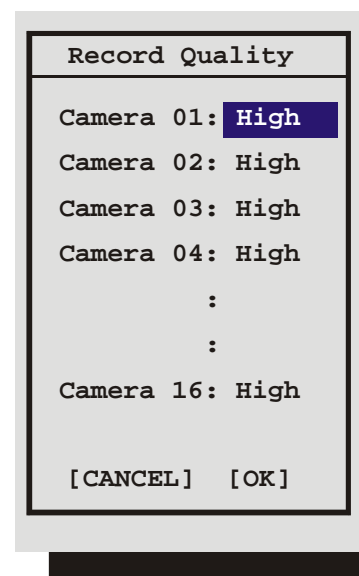

❑ Main Menu ® Record ® Event Settings

Use this menu to specify how each camera will record during normal and event conditions.

TL: Records at the Time-lapse Record Rate under normal conditions. Does not change record rate during an event.

Event: Records during events at the Event Record Rate. Camera does not record under normal conditions.

Event + TL: Records at the Time-lapse Record Rate under normal conditions. Records at the Event Record Rate during events.

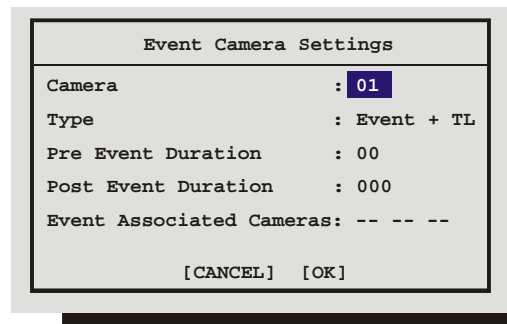



About Events: An Event is an action that the unit acknowledges by recording at the Event Record Rate, yet it is not cause for an Alarm. Events may be created two ways, via RS232 text insertion and Activity detection.

Example of an Event: A camera is pointed at the front door inside the lobby during business hours. With the Event Camera Settings Type set to Event, the unit does not record while the doorway is empty. When activity motion detection senses that someone is entering or leaving the doorway, the unit begins recording at the Event Record Rate and stops recording when the motion ceases.

RS232 Event: See section 9 for information about generating an Event via RS232, and optionally inserting ASCII text to mark the Event.

Activity Detection Event: See Setup Parameters in section 3.13 for detailed information about configuring activity detection as an event in the menu system.

Pre Event Duration: The unit will record up to 5 seconds of data ahead of the event trigger, at the Event Record Rate. Select from 0 to 5 seconds.

Post Event Duration: The unit will record up to 250 seconds after the completion of the Event, at the Event Record Rate. Select from 0 to 250 seconds.

Event Associated Cameras: Enter up to three camera numbers to be associated with this event.

☐ Main Menu ® Record ® Timelapse Record Rate

The unit records at the Timelapse Record Rate under normal conditions, when there are no alarms, events, or activity present. Record rates are measured in both Pictures Per Second (pps) and Seconds Per Picture (spp).

The maximum record rate per camera is inversely proportional to the number of cameras connected to the unit. The fewer cameras connected, the higher the maximum record rate for each camera, and vice versa. The maximum record rate for multiple cameras is 48pps (NTSC)(40pps PAL). The maximum record rate for a single camera is 30pps (NTSC)(25pps PAL).

The bottom right corner of the menu contains a record duration calculator. The top line indicates the estimated recording time for the unit in Time-lapse record mode only. The bottom line indicates the estimated recording time, taking into consideration the amount of time the unit will spend in Activity, Event, and/or Alarm record mode.

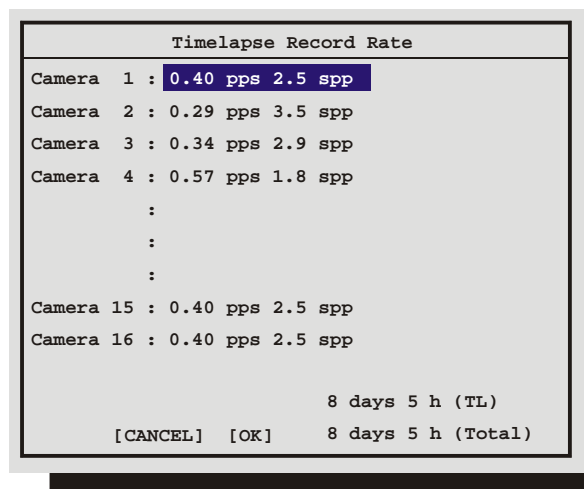

1. Rotate the **Jog** to navigate, and the **Shuttle** to change the values.
2. To save changes and exit the menu: Select **[OK]**, and then press the **Enter** button.
3. To exit the menu without making changes: Press the **Menu** button, or select **[CANCEL]**, then press the **Enter** button.

❑ Main Menu ® Record ® Event Record Rate

The unit will record at the Event Record Rate when an Event is activated. Events can be activated by RS232 event generation or activity detection. See **Event Settings** on page 35.

Record rates are measured in both Pictures Per Second (pps) and Seconds Per Picture (spp).

The maximum record rate per camera is inversely proportional to the number of cameras connected to the unit. The fewer cameras connected, the higher the maximum record rate for each camera, and vice versa. The maximum record rate for multiple cameras is 48pps (NTSC)(40pps PAL). The maximum record rate for a single camera is 30pps (NTSC)(25pps PAL).

The bottom right corner of the menu contains a record duration calculator. The top line indicates the estimated recording time of the cameras in Event record mode only. The bottom line indicates the estimated recording time, taking into consideration the amount of time the unit will spend in Time-lapse, Activity, Event, and/or Alarm record mode.

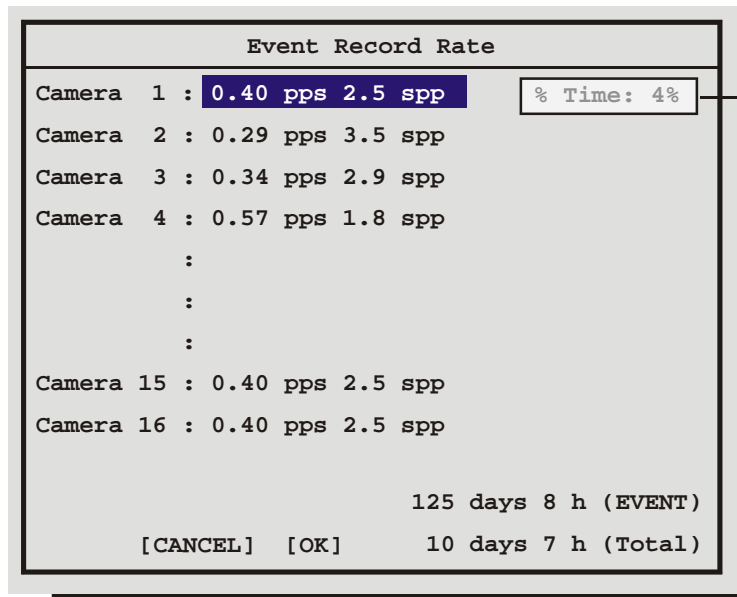

Estimate of the % of time each camera will typically spend in Event mode. For example if you expect to have about 20 total events each day, each lasting 3 minutes on average, then the % of the time will be 4%. (1 hour/24 hours)

1. Rotate the **Jog** to navigate, and the **Shuttle** to change the values.
2. To save changes and exit the menu: Select **[OK]**, and then press the **Enter** button.
3. To exit the menu without making changes: Press the **Menu** button, or select **[CANCEL]**, then press the **Enter** button.

❑ Main Menu ® Record ® Activity Record Rate

The unit will record at the Activity Record Rate when the camera is in normal Timelapse Record Mode and activity is detected in the camera scene. Activity should not be linked to Event, in which case the Event Record Rate will be used.

Record rates are measured in both Pictures Per Second (pps) and Seconds Per Picture (spp).

The maximum record rate per camera is inversely proportional to the number of cameras connected to the unit. The fewer cameras connected, the higher the maximum record rate for each camera, and vice versa.

versa. The maximum record rate for multiple cameras is 48pps (NTSC)(40pps PAL). The maximum record rate for a single camera is 30pps (NTSC)(25pps PAL).

The bottom right corner of the menu contains a record duration calculator. The top line indicates the estimated recording time of the cameras in Activity record mode only. The bottom line indicates the estimated recording time, taking into consideration the amount of time the unit will spend in Time-lapse, Activity, Event, and/or Alarm record mode.

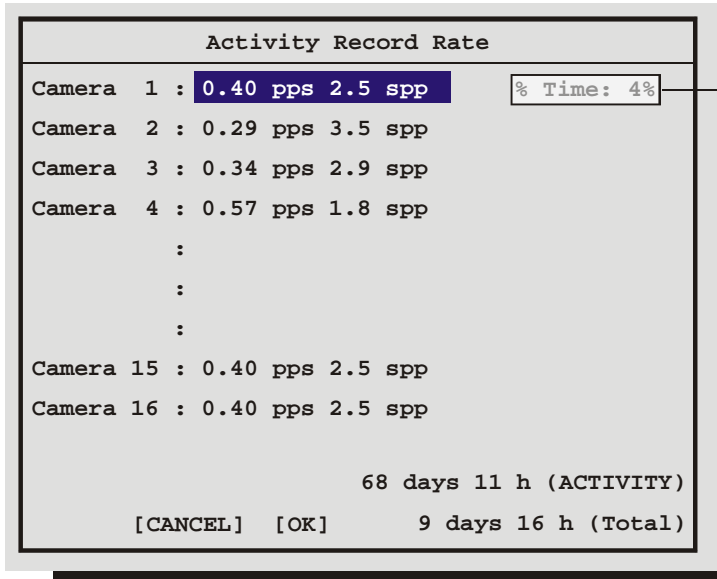

Estimate of the % of time each camera will typically spend in periods of activity. For example if you expect to have about 20 total periods of activity each day, each lasting 3 minutes on average, then the % of the time will be 4%. (1 hour/24 hours)

1. Rotate the **Jog** to navigate, and the **Shuttle** to change the values.
2. To save changes and exit the menu: Select **[OK]**, and then press the **Enter** button.
3. To exit the menu without making changes: Press the **Menu** button, or select **[CANCEL]**, then press the Enter button.

□ Main Menu ® Record ® Alarm Record Rate

During an alarm, the unit records at the alarm record rate. The bottom of the menu contains a record duration calculator. The top line indicates the estimated recording time of the cameras in Alarm record mode only. The bottom line indicates the estimated recording time, taking into consideration the amount of time the unit will spend in Time-lapse, Activity, Event, and/or Alarm record mode.

The configuration of the Alarm Record Rate is closely associated with the Alarm Record Mode. For detailed information about configuring the Alarm Record Mode, see Alarm Record mode in section 3.11.

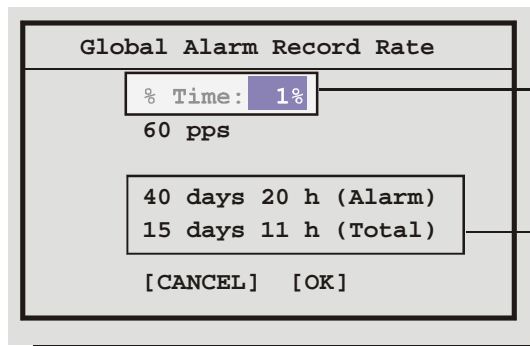

Estimate of the % of time the unit will typically spend in alarm mode. For example if you expect to have about 5 total periods of alarms each day, each lasting 3 minutes on average, then the % of the time will be 1%. (15 min/24 hours)

Record Duration Calculator

1. Rotate the **Jog** to navigate, and the **Shuttle** to change the values.
2. To save changes and exit the menu: Select **[OK]**, and then press the Enter button.
3. To exit the menu without making changes: Press the Menu button, or select **[CANCEL]**, then press the Enter button.

❑ Main Menu ® Record ® Record Mode

Use this menu to specify how the unit will handle data overwrite issues once the hard disk becomes full.

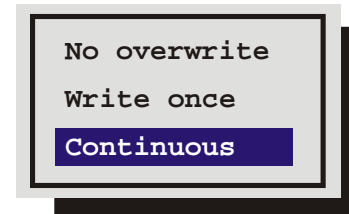

No Overwrite:

- Recording starts at the end of the last recording.
- Recording stops when disk becomes full.
- When the hard disk becomes full, the unit displays an on-screen message indicating that the device is full and that the archive device has stopped recording. The user must acknowledge the message by pressing the **Enter** button.

Write Once:

- Recording starts at the end of the last recording.
- Recording stops when disk becomes full.
- The user is prompted to authorize overwriting old data.

Continuous:

- Recording starts at the end of the last recording.
- Unit overwrites all previously recorded data, overwriting the oldest data first.
- The unit does not stop recording when disk becomes full.

❑ Main Menu ® Record ® Disk Maintenance

Use the Jog to select from the following options, then press the **Enter** button to begin.

Delete: Delete all data from the hard disk (with the possibility of restoring it).

Undelete: Restore data that has been deleted, but not yet overwritten.

Destroy: Erase all data from the hard disk permanently, **without the possibility of restoring it**. Selecting this option brings up a confirmation dialog box.

Test: Provides access to the **Disk Test Setup** menu which features disk test and monitoring options.



Disk Test Setup Menu

The Disk Test Setup menu provides several testing options including the test time, frequency, and duration.

Disk Test: Options include **Disable**, **Test Now**, **Test Periodically**. The **Test Periodically** option runs the Disk Test at the specified frequency. The Disk Tests run in the background and will not interfere with normal operations.

Test Frequency in hours: From 0 to 1000 hours between tests.

Test Duration: This option is for the type of test to run; **Fast** or **Thorough**. The **Thorough** test will test significantly more sectors than the **Fast** test. GE recommends using the **Thorough** test. The **Fast** test can miss some disk failures

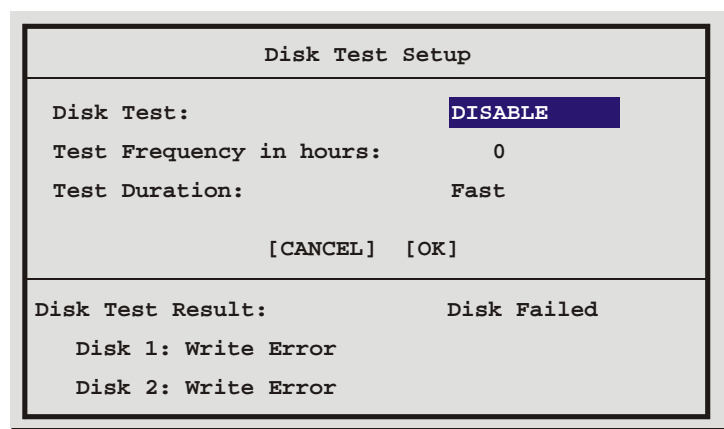

Use the **Jog** to move between the menu fields and the **Shuttle** for the selections within the fields. When satisfied with the selections select **OK** and press the **Enter** button to execute.

The Disk Test will run in the background and will not interfere with normal operations. Once the disk test is done, a message will appear on the screen indicating the test result.

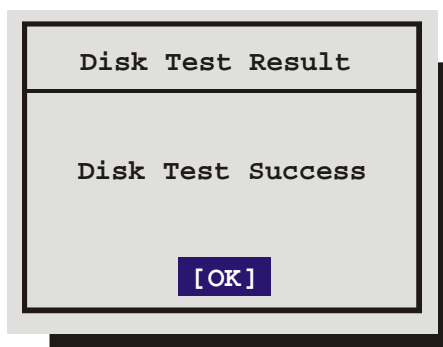

PASSED

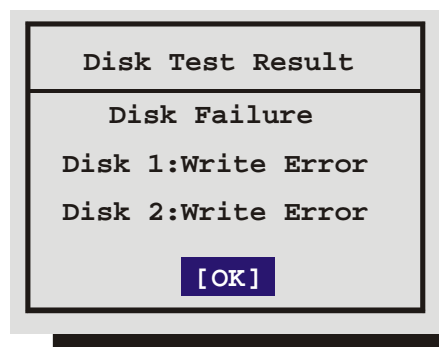

FAILED

Press the Enter button to clear from the display.

Should a disk test fail, several actions will be performed:

- An icon will be displayed indicating disk failure.  It is displayed on Monitor A on the bottom of the screen in the middle. This icon will only disappear when the disk is replaced.
- If the alarm or record email option is enabled in the **Email Notification Setup** Screen, an email will be sent indicating that a disk failure occurred.

Main Menu ® Record ® Record Lock

Use this menu to set the Record Lock feature. This feature disables the front panel record button. Setting Record Lock to ON will start the unit recording if it is not currently in the Record mode.

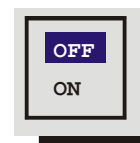

❑ Main Menu ® Record ® Auto Delete Mode

The ADM feature prevents the unit from displaying or archiving any search results that are more than thirty days old. This feature may be required by law in some jurisdictions. Choose from **1** to **99** days or **Off**. The default setting is **Off**.

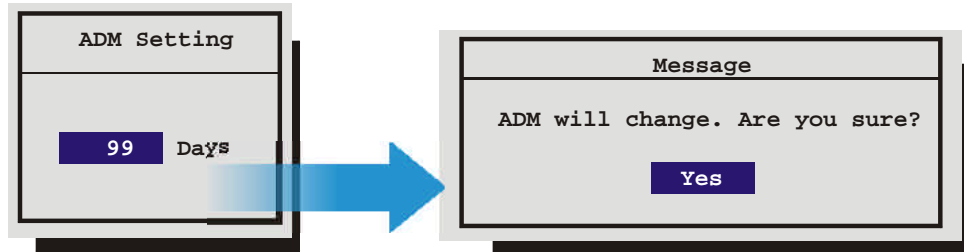

3.11 Alarms

Use this menu to configure the alarm handling features of the unit.



Caution! The DVMRe Triplex's primary function is to furnish video multiplexing and recording with a multiscreen display. Although the unit has alarm handling and motion detection functions, these are considered secondary features. **This unit should not be the only alarm device on site.**

Input Configuration

- Alarm Latch
- Alarm Action
- Alarm Record Mode
- Enable / Disable
- Alarm History
- Link to a Macro
- Fullscreen Alarm
- Relay Configuration
- Buzzer Setup
- Videoloss Action
- Pre Alarm Duration
- Notification
- Archive Alarms

❑ Main Menu ® Alarms ® Input Configuration

Configure the alarm inputs as either Normally Open or Normally Closed.

Configure inputs as follows.

Normally Open Zero Potential Relay Contact: Configure in menu as Normally Open.

Normally Closed Zero Potential Relay Contact: Configure in menu as Normally Closed

TTL Active High: Configure in menu as Normally Closed.

TTL Active Low: Configure in menu as Normally Open.

Open Collector Active On: Configure in menu as Normally Open.

Open Collector Active Off: Configure in menu as Normally Closed.

Alarm Input

- Alarm 01: **N/OPEN**
- Alarm 01: N/CLOSED
- Alarm 03: N/OPEN
- Alarm 04: N/CLOSED
- :
- :
- Alarm 15: N/OPEN
- Alarm 16: N/CLOSED

[CANCEL] [OK]

❑ Main Menu ® Alarms ® Alarm Latch

This feature determines how the unit latches alarm conditions.

Select from the following options:

Latched: The alarm is activated until it is silenced and acknowledged by the user.

Transparent: The alarm is active only while receiving alarm input. The alarm condition is canceled when the alarm input ceases.

Timed Out: The alarm condition is latched for the amount of time selected in this menu, then it is automatically silenced and acknowledged. If the alarm input exceeds the duration specified in this menu, the unit silences and acknowledges the alarm when the alarm input ceases. Select the timeout duration, the range is from 1 to 250 seconds.

Transparent alarms cannot be silenced and acknowledged. If transparent mode is preferred, but the ability to silence and acknowledge alarms is desired, select Timed Out and set the Alarm Timeout to two seconds.

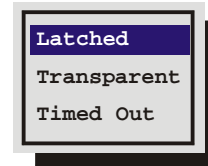

❑ Main Menu ® Alarms ® Alarm Action

This menu is not available on 4-channel units. Only the full screen alarm display is available on the 4-channel unit. Therefore, a 4 channel unit will always be limited to the default values in this menu, i.e. no presets linked to alarms and alarm relay is always Relay 1.

Input: Select the input you wish to configure.

Freeze: Selecting **Yes** will freeze the alarm camera display (quadrant 1) at the time the alarm is activated.

Cameras: This setting determines the four cameras displayed on-screen when an alarm is received. The camera group contains the camera in alarm and three associated cameras.

Default Settings: The first camera in the list is the camera in alarm. The second camera in the list is the camera that precedes the alarm camera numerically. The third and fourth cameras in the list are the two cameras following the alarm camera numerically.

Preset: Use this feature to send a camera to a preset when an alarm is activated. The preset number corresponds directly with the camera number located directly above it in this menu. Select from 1 through 16. If this field is left blank, the camera will not respond. In the example above, Camera 1 will go to Preset 1, while Camera 2 will go to Preset 9.

Relay: Configure which relay will be triggered when an alarm is activated per camera. Select from:

- 1
- 2
- 1 + 2
- None

Intrusion AND/OR: Use this feature to activate alarms by hardwired alarm inputs AND/OR Intrusion detection. Select from AND or OR. Motion Detection must be set to Intrusion and linked to the Alarm number.

Rotate the **Jog** to navigate and the **Shuttle** to change the values.

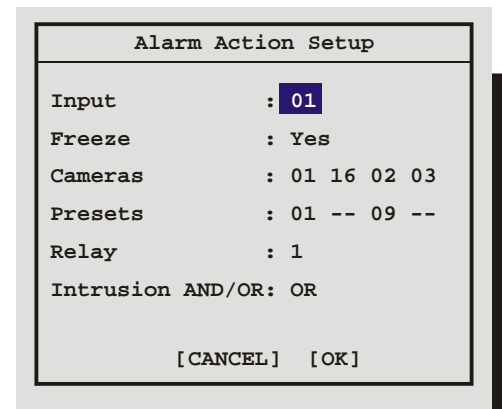

❑ **Main Menu ® Alarms ® Alarm Record Mode**

Use this menu to determine how the unit will record cameras in alarm.

No Change: Unit changes to the Alarm Record Rate, but it does not give priority to the camera in alarm.

Exclusive: The unit records only the camera (or cameras) in alarm.

Interleaved: Alarmed cameras are recorded at a higher rate than non-alarm cameras. The unit accomplishes this by interleaving images of alarmed cameras between images from non-alarmed cameras in the record list. **Interleaved is the recommended mode of operation.**

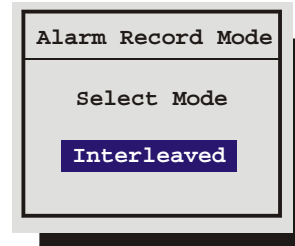

Example of Record Lists:

No Change record list for 8 cameras, Camera-4 in alarm.	1 2 3 4 5 6 7 8 1 2 3 4 5 6 7 8
Exclusive record list for 8 cameras, Camera-4 in alarm.	4 4 4 4 4 4 4 4 4 4 4 4 4 4 4 4
Interleaved record list for 8 cameras, Camera-4 in alarm.	1 4 2 4 3 4 5 4 6 4 7 4 8 4 1 4

❑ **Main Menu ® Alarms ® Enable / Disable**

Use this menu to Enable or Disable the alarm inputs.

Select from the following:

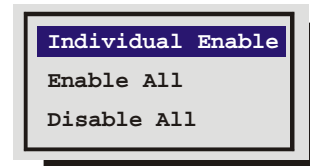

- **Individual Enable:** Allow the user to access the Alarm Enable submenu, and enable or disable alarm inputs on a per camera basis.
- **Enable All**
- **Disable All**

Rotate the **Jog** to navigate, and the **Shuttle** to change the values.

Save changes and exit the menu: Select **[OK]**, then press the **Enter** button.

Exit the menu without making changes: Press the **Menu** button, or select **[CANCEL]**, then press the **Enter** button.

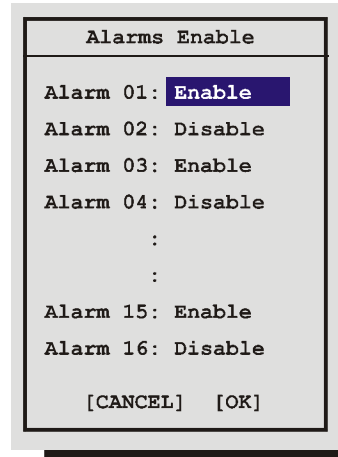

❑ **Main Menu ® Alarms ® Alarm History**

Use this window to view a list of the 100 most recent alarms. Alarms are displayed 10 at a time. Rotate the **Jog** to scroll through the alarms.

Information displayed in this window is:

- The alarms number in the list.
- The date of the alarm (month and day).
- The time of the alarm (hours, minutes, and seconds).
- The number of the camera input in alarm.

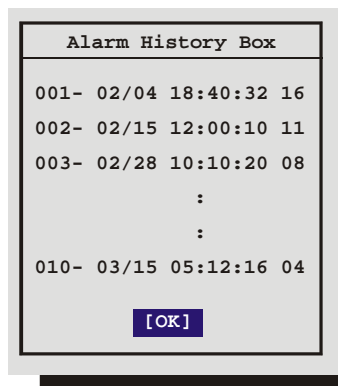

❑ Main Menu ® Alarms ® Link To A Macro

Use this menu to link an alarm input to a macro. If a link is created, a macro will run each time that alarm is activated.

Alarm: Select the alarm input you would like to link.

Macro: Select the macro number you wish to link to. Leave this setting blank if you do not wish to link to a macro.

Rotate the **Jog** to navigate, and the **Shuttle** to change the values.

Save changes and exit the menu: Select **[OK]**, then press the **Enter** button.

Exit the menu without making changes: Press the **Menu** button, or select **[CANCEL]**, then press the **Enter** button.

Alarm	Macro
01	01
02	
03	
15	
16	

[CANCEL] [OK]

❑ Main Menu ® Alarms ® Fullscreen Alarm

Selecting **Yes** from this menu will cause the unit to always display the alarm camera fullscreen.

Selecting **No** from this menu will cause the unit to display the 4-way display configured in the **Main Menu ® Alarms ® Alarm Action Setup** menu.

This menu selection is not available on 4-channel DVMRe Triplex units, since Fullscreen Alarm Mode is the only alarm mode available.

Fullscreen Alarm

Fullscreen

NO

❑ Main Menu ® Alarms ® Relay Configuration

Use this menu to configure each relay output as either:

- Normally Open
- Normally Closed

Relay Configuration

Relay 01: N/OPEN

Relay 02: N/CLOSED

[CANCEL] [OK]

❑ Main Menu ® Alarms ® Buzzer Setup

Use this menu to configure the internal buzzer.

Global Buzzer: The Global Buzzer setting acts as a master On/Off switch. Setting the Global Buzzer to **OFF** deactivates all buzzer activity.

Live Alarm Buzzer: Activates while receiving alarm input.

Videoloss Buzzer: Activates when video loss is detected.

Disabling the Videoloss buzzer disables all videoloss buzzer activity. Videoloss buzzers may be disabled on a per camera basis in the **Alarms ® Videoloss Action** menu.

Playback Buzzer: Activates during playback of recorded alarms.

Buzzer Setup

Global Buzzer : ON

Live Alarm Buzzer: ON

Videoloss Buzzer : ON

Playback Buzzer : ON

[CANCEL] [OK]

❑ Main Menu ® Alarms ® Videoloss Action

Use this menu to configure how the unit responds to videoloss.

Camera: Select the camera you wish to configure.

Relay 1: If enabled, the unit will activate Relay 1 when videoloss is detected.

Relay 2: If enabled, the unit will activate Relay 2 when videoloss is detected.

Buzzer: Use this setting to disable the videoloss buzzer activation on a per camera basis. To disable videoloss buzzer activation on all cameras go to the **Main Menu ® Alarms ® Buzzer Setup** menu, described in the previous section.

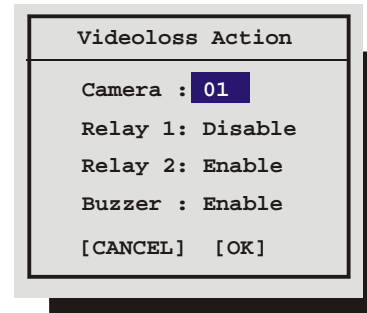

❑ Main Menu ® Alarms ® Pre Alarm Duration

During recording, the unit stores up to 5 seconds of recorded information in a buffer. This data can be automatically retrieved when an alarm is activated. Select the amount of time just previous to the activation of an alarm you wish to retrieve.

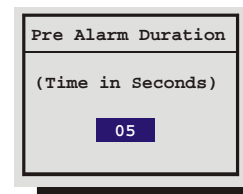

❑ Main Menu ® Alarms ® Notification

Use this menu to select:

- Email Alarm Notification.
- TCP/IP Notification.



Email Notification Setup

This screen allows the user to setup the types of events to be notified of, and the email addresses (up to two) to be notified. Follow the context sensitive on-screen instructions to setup the individual fields. Also, please note that the Region/Time Zone setting must be set correctly for Email notification to time stamp messages accurately.

One or more of these fields must be set to **ENABLE** to receive an email notification of the selected event.

Obtain the parameters for these two fields from your IT Department.

Email Notification Setup	
Notify Vidloss:	ENABLE
Notify Alarm:	DISABLE
Notify Record:	DISABLE
Notify Archive:	DISABLE
Notify Menu Access:	DISABLE
Notify Power Up:	DISABLE
Notify Connection:	DISABLE
Email User 1:	john.doe
Email Domain 1:	somecompany.com
Email User 2:	jane.doe
Email Domain 2:	somecompany.com
SMTP Server:	0. 0. 0. 0
SMTP Port:	25
[CANCEL] [OK]	

Format of email address: user@domain
Warning: Region/Time Zone must be set correctly!



Only if **Notify Alarm** is set to **enable** will the email include a link to the video on the disk. The link pertains only to the alarm start. For more information see section 6.2.

Email Address Format

The format of the email addresses should be entered as follows. If the email address to be notified is john.doe@somecompany.com, then john.doe should be entered in one of the **Email User** fields and somecompany.com should be entered in the subsequent **Email Domain** field.

TCP/IP Notification Setup

This screen allows the user to setup the types of events to be notified of, and the IP addresses (up to two) of the PC(s) where the WaveReader software resides.

WaveReader must be running on the receiving PC(s) and Alarm Monitoring must be setup. See Alarm Monitoring in the WaveReader Manual for details.

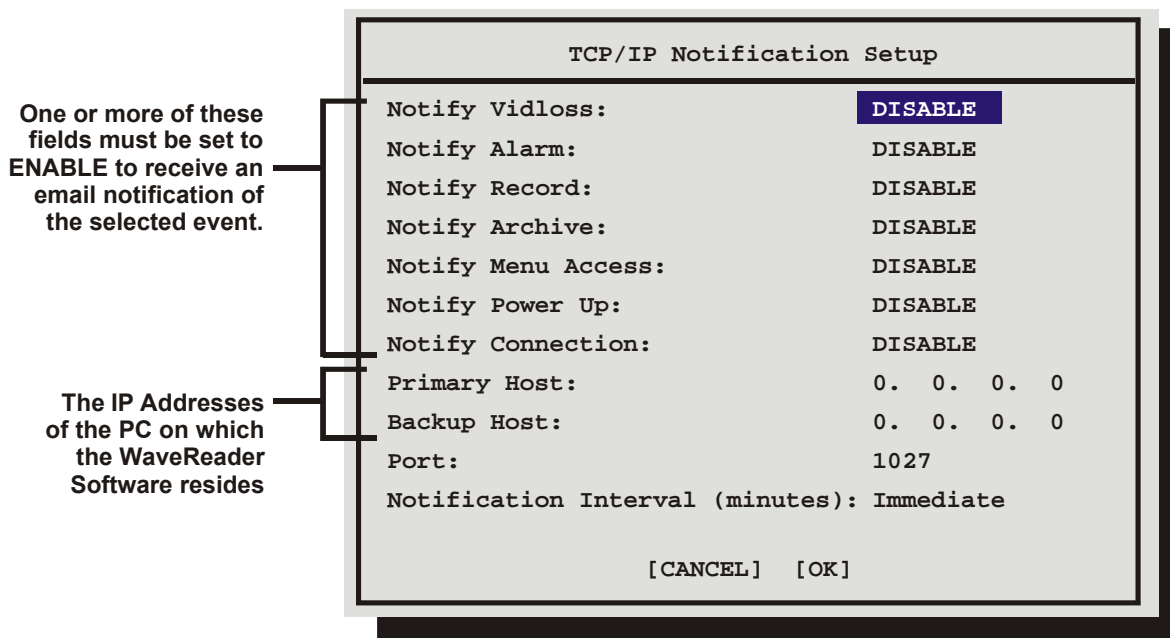

The **Notification Interval** can be set from 1 minute to 60 minutes, or immediately upon the event.

☐ Main Menu ® Alarms ® Archive Alarms

Selecting **Enable** from this menu will cause the unit to activate Relay 2 if a malfunction occurs while archiving.



3.12 Macro

A macro is a recorded sequence of keystrokes. The number of macros depends on the number of camera inputs (4, 10 or 16). Each macro can have up to 32 keystrokes.

Use this menu to:

- Enter Macro Record mode.
- Program a scheduled start time for a macro.
- Edit the RS232 command string for each submacro.

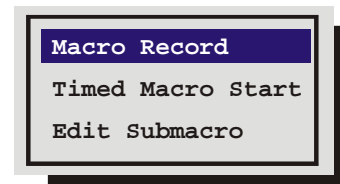

☐ Main Menu ® Macro ® Macro Record

Note: Do not attempt macro programming while the front panel is locked.

To begin recording a macro:

1. Select the macro number you wish to record, then press the **Enter** button. The unit will automatically exit the menu system and go to a starting point. Macro Record mode is indicated as **F** and the **Macro Number** on-screen.
2. From this point, begin recording the desired keystroke sequence. Record up to 32 keystrokes. If 32 keystrokes are exceeded, the unit will end the macro recording automatically.
3. When finished programming, press the **Function** button then the **Enter** button to end the macro recording. A form is provided in section 10 to keep track of recorded macro functions.

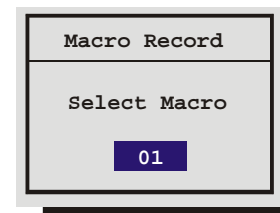



Keystroke count while in the menu system: While recording a macro, entering the menu system, changing multiple menu items, and exiting the menu system are only counted as one keystroke. Using the **Jog** to navigate the menu system does not count as keystrokes. Once the menu system has been exited, re-entering the menu system will count as a second keystroke.

Not all menu items can be programmed using macros. For a complete list of macro programmable menu items, see the table below.

During macro recording, the following button combinations perform special functions.

Button Sequence	Resulting Action
Function then 1.	Activate Relay 1 output.
Function then 2.	Reset Relay 1 output.
Function then 3.	Pause macro for 1 second.
Function then 4.	Pause macro for 5 seconds.
Function then 5.	Activate Relay 2 output.
Function then 6.	Reset Relay 2 output.
Function, Function, then Submacro number.	Program a specific submacro to activate when the macro is run.
Function then Enter.	End macro recording

Macro Excluded Features

The following core features or settings cannot be programmed by Macro.

- Disk Maintenance.
- Erase Archive Medium.
- POTS Setting.
- Ethernet Setting.
- RS485 Network Address.
- Front Panel Lock/Unlock.
- Record Timer.

☐ Main Menu ® Macro ® Timed Macro Start

Use this menu to program scheduled start times for macros. Up to 20-scheduled start times can be programmed in this menu.

Event: Select the scheduled start event you wish to edit.

Day: Select the start day (**Monday – Sunday**) of the macro. Select ** (double asterisks) to run the macro every day.

Select **None** to cancel the scheduled start time.

Time: Select the start time for the macro.

Macro: Select the desired macro number.

A form is provided in section 10 to keep track of scheduled macros.

Timed Macro Setup

Event : 01

Day : Monday

Time : 00:00

Macro : 01

[CANCEL] [OK]

❑ Main Menu ® Macro ® Edit Submacro

A submacro is an RS232 command string that is used to control a peripheral device. Submacros are activated during macros. See the table above for information about programming a macro to activate a submacro.

Select the submacro you wish to edit from the menu system. This menu will appear.

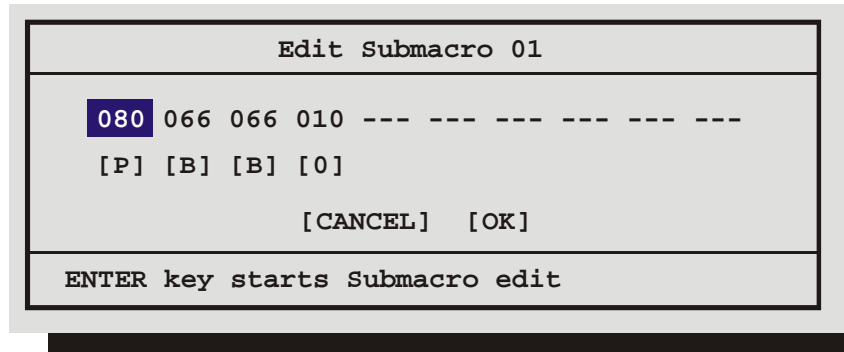

Use this menu to create the RS232 command string. Press the **Enter** button to Enter and Exit the submacro edit mode. Rotate the **Jog/Shuttle** to navigate among the fields and change the values. Each byte value can be set from 0 to 255.

Running A Macro

A macro is a recorded sequence of up to 32 keystrokes. To activate a macro, press the **Function** button followed by the **Number** button of the desired macro. While running, the macro is indicated on-screen as the letter **F** and the macro number.

The user can cancel the macro at any time by pressing the **Function** button.

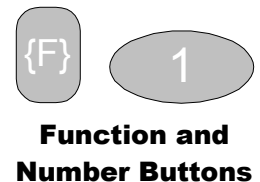

Function and Number Buttons

Daylight Savings Time (Alternate Method)

To adjust the time one hour for daylight savings time, press the **Function** button, then the **Sequence** button. If this function is activated during April, one hour is added to the time. If this function is activated in October, one hour is subtracted from the time. This function will only operate once per time period.

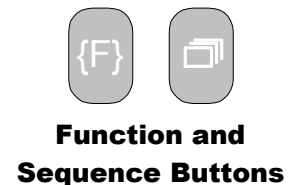

Function and Sequence Buttons

3.13 Motion Detection

Use this menu to:

- Enable motion detection on a per camera basis.
- Activate individual zones in a scene to respond to motion detection.
- Activate the on-screen motion detection indicator.
- Set motion detection as Activity detection or Intrusion Detection.
- Configure the motion detection parameters on a per camera basis.

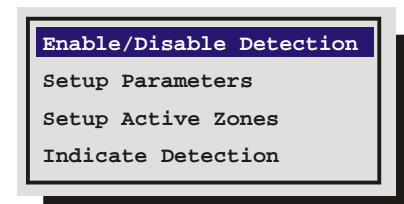

❑ Main Menu ® Motion Detection ® Enable/Disable Detection

Selecting **Enable All** or **Disable All** from this menu will activate or deactivate motion detection on all cameras.

Selecting **Individual Enable** from this menu will bring up the following menu.

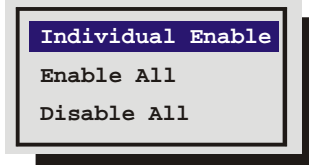

Individual Enable Menu

Use this menu to enable or disable motion detection on a per camera basis. Rotate the **Jog** to navigate, and the **Shuttle** to change the values.

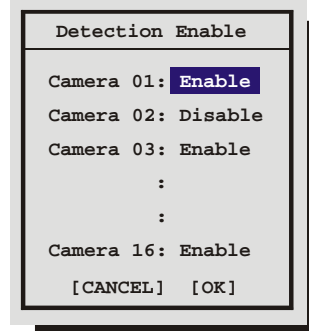

❑ Main Menu ® Motion Detection ® Setup Parameters

Use this menu to select the **Camera**, **Motion Detection Type**, and **Sensitivity** of the Motion Detection you wish to configure.

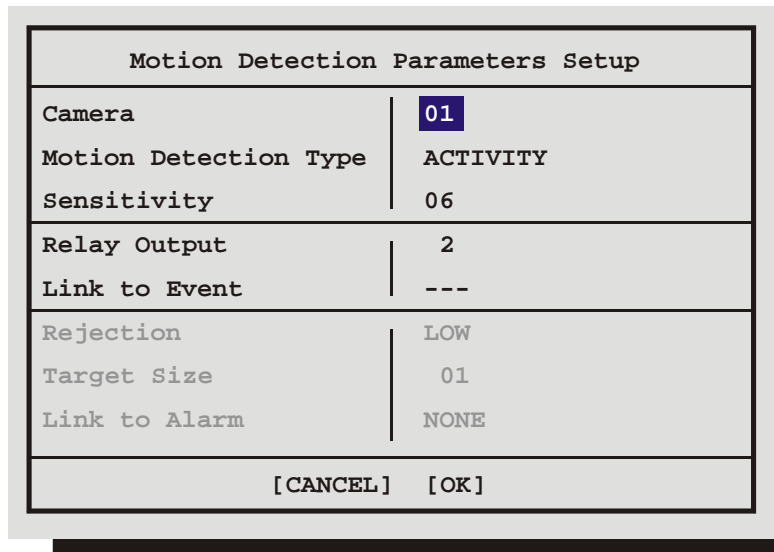

Navigate in this menu using the **Jog** to select the field and the **Shuttle** to change the parameters.

Activity Vs. Intrusion

Activity Detection is a simple type of motion detection having only a sensitivity setting and a relay output. Intrusion Detection is a more sophisticated type of motion detection, with additional features such as false alarm rejection levels, minimum target size, and an alarm output.

Activity Detection Setup

If Activity is selected in Motion Detection Type field, the following parameters are enabled:

Relay Output: The unit may be configured to activate a relay output when motion detection is present. Select either **1**, **2**, **1+2** (both relays), or **None**.

Link to Event: Selecting **Yes** in this menu will activate the event record speed when activity detection is present.

Intrusion Detection Setup

If Intrusion is selected in Motion Detection Type field, the following parameters are enabled:

Sensitivity: Rotate the **Shuttle** to change the motion detection sensitivity, 10 being the most sensitive.

Rejection: Configure the unit's false alarm rejection feature by selecting **Low**, **Medium**, or **High**. These settings are based on the number of simultaneously triggered zones and the persistence of motion in a scene. The Low setting is the most sensitive to motion. The Medium setting will filter out most false alarm situations due to sudden luminance changes over the whole scene (clouds passing over). The High setting will filter out sudden luminance changes as well as spurious motion events that do not persist for a number of frames (a bird flying past the lens).

Target Size: This setting is the minimum number of zones (from the 16 x 16 grid) that must be activated simultaneously before it is considered to be valid motion.

Link To Alarm: Select the alarm number that you wish to activate when motion detection is activated.

❑ Main Menu ® Motion Detection ® Setup Active Zones

Use this menu to setup the Active Zones for motion detection. The screen shown below will overlay the current video image allowing for precise activity zone setup. The disabled zones will be tinted. The enabled zones will be clear.

Activity Grid Setup Screen

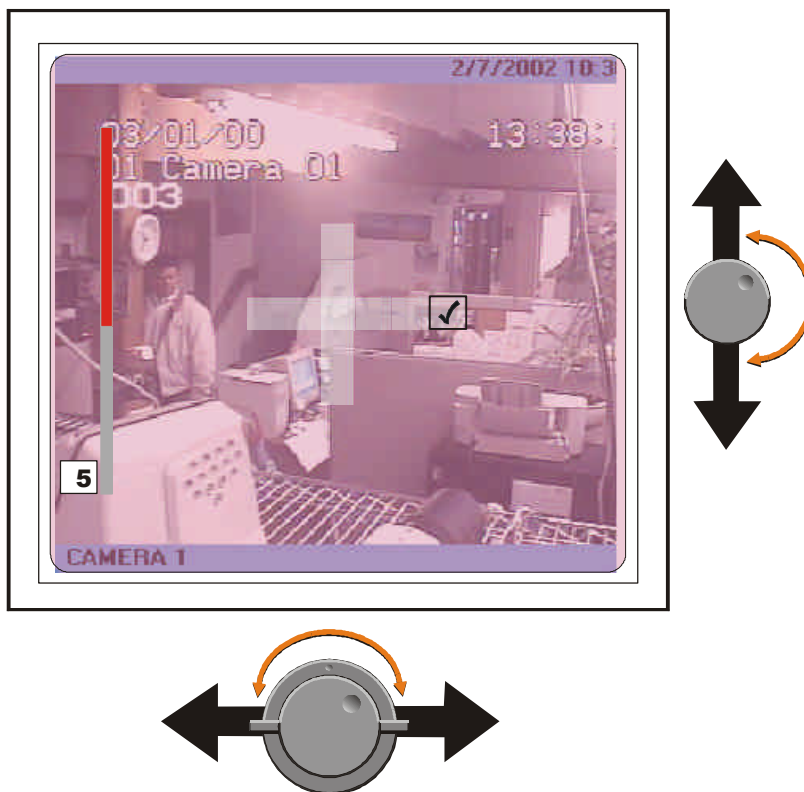

Pressing the Function button will bring up the Help screen shown on the next page. This screen will overlay the current video image.

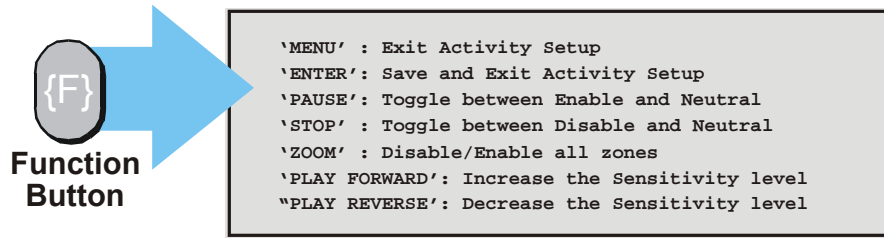

Sensitivity Scope

Use the sensitivity scope to adjust the motion detection sensitivity for the scene. The sensitivity scope is the bar located near the left-hand corner of the screen.

The black bar raises and lowers to indicate the degree of motion detected. When the black bar reaches the red bar, a motion detection alarm is activated.

Adjusting Motion Detection Sensitivity: Raise and lower the red bar to change the motion detection sensitivity. Use the Play Forward button to increase the sensitivity level and the Play Reverse button to decrease the sensitivity level. The sensitivity level is also displayed as a numeric value.

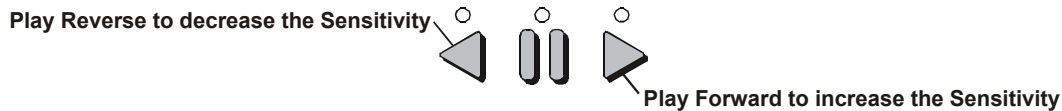

❑ Main Menu ® Motion Detection → Indicate Detection

Motion Detection may be indicated on-screen by displaying the letter **M**. Use this menu to turn this feature On or Off.

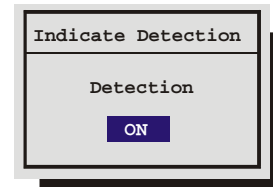

3.14 Camera Setup

Use this menu to:

- Edit the title for each camera.
- Adjust the Automatic Gain Control.
- Disable or Enable camera inputs.
- Specify cameras as covert (recorded but not displayed).
- View the Camera Scope (Histogram)
- Enable or Disable SVHS output on Monitor B.

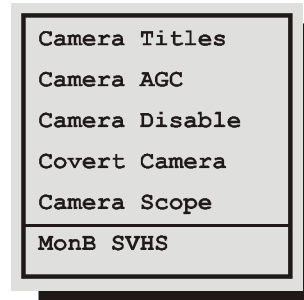

❑ Main Menu ® Camera Setup ® Camera Titles

Use this menu to:

- Specify if the camera titles will be displayed on the monitors.
Edit the title for each camera.



Titles Display

Camera titles may be displayed on either monitor. Use this menu to turn this feature On or Off.

Rotate the **Jog** buttons to navigate and the **Shuttle** to change the values.

Edit Titles

Rotate the **Shuttle** to select the camera whose title you wish to configure, and then press the **Enter** button. The Camera Title Edit menu will appear.

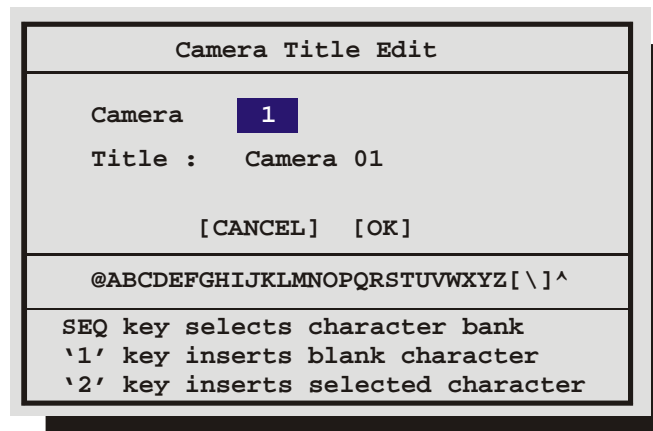
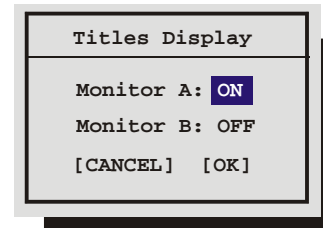

Camera Title Edit Menu

1. With the camera title selected, press the **Enter** button. The menu will enter the Edit mode and the character bank will appear in the center of the menu.
2. Press the **Sequence** button to select the desired character set.
3. Rotate the **Shuttle** to navigate the cursor in the camera title.
4. Rotate the **Jog** to navigate the cursor in the character bank.
5. Press the **Number 1** button to insert a blank character or press the **Number 2** button to insert the selected character.
6. When finished editing the title, press the **Enter** button to exit the edit mode.
7. **Save changes and exit the menu:** Select **[OK]**, then press the **Enter** button.
8. **Exit the menu without making changes:** Press the **Menu** button, or select **[CANCEL]**, then press the **Enter** button.

❑ Main Menu ® Camera Setup ® AGC

Use the Automatic Gain Control (AGC) to adjust the video input signal level for cameras whose level is outside the normal range. The default gain setting is 100%.

Rotate the **Jog** to navigate and the **Shuttle** to change the values.

Save changes and exit the menu: Select **[OK]**, then press the **Enter** button.

Exit the menu without making changes: Press the **Menu** button, or select **[CANCEL]**, then press the **Enter** button.

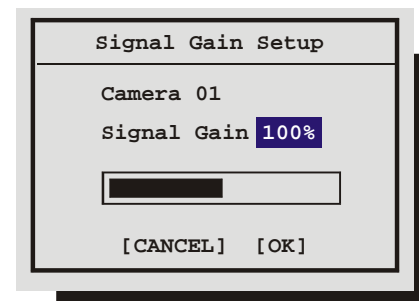

Main Menu ® Camera Setup ® Camera Disable

Use this menu to:

- Enable or Disable cameras individually
- Configure the unit to disable cameras automatically at power-up if video loss is detected.
- Automatically disable all inputs detecting videoloss.

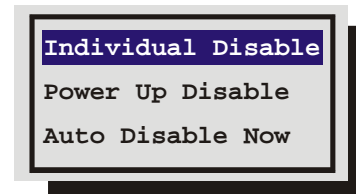

Individual Disable

Use this menu to Disable or Enable each camera input individually.

Use the **Jog** to navigate and the **Shuttle** to change the values.

Save changes and exit the menu: Select **[OK]**, then press the **Enter** button.

Exit the menu without making changes: Press the **Menu** button, or select **[CANCEL]**, then press the **Enter** button.

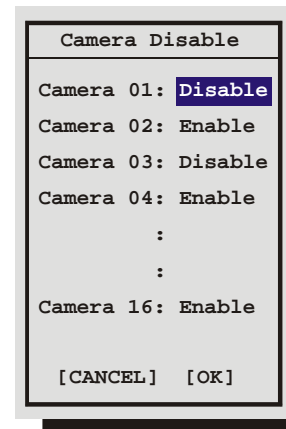

Power Up Disable

With this feature turned On (Enabled), the unit will automatically detect which inputs are experiencing videoloss at power-up, and disable them.

Rotate the **Jog** to navigate and the **Shuttle** to change the values.

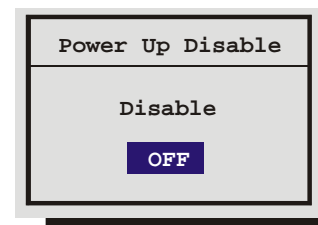

Auto Disable Now

This feature detects which inputs have video signals and which are experiencing videoloss. When this feature is activated, the unit will automatically disable the inputs experiencing videoloss. The DVMRe Triplex will also re-enable video inputs that were previously disabled if a video input signal is detected.

☐ Main Menu ® Camera Setup ® Covert Camera

This feature removes cameras from all live displays while continuing to record them, so that the users and the public are unaware that the camera is being recorded. Covert cameras are not viewable during playback.

Select **Yes** in this menu to configure a camera as covert.

Rotate the **Jog** to navigate and **Shuttle** to change the values.

To disable the covert camera (make display visible) return to this menu and change the selection to **NO**. The camera's display will become visible upon exiting the Main Menu.

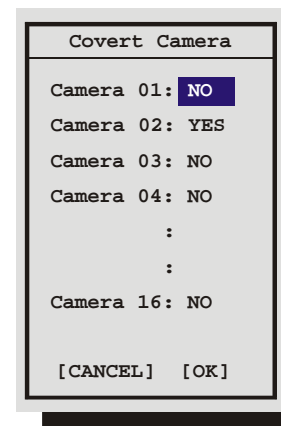

❑ Main Menu ® Camera Setup ® Camera Scope

Use this menu to view a live luminance histogram of the currently displayed camera.

Luminance Histogram

A Luminance Histogram is a graphical representation of how many times each gray-level value occurs in an image.

Use this feature to analyze and optimize the video input signal.

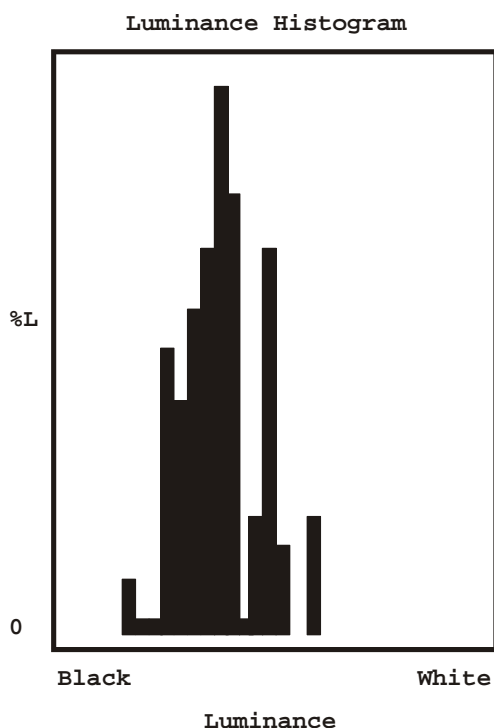

❑ Main Menu ® Camera Setup ® MonB SVHS

Use this menu to enable or disable SVHS output on Monitor B. Select **Enable** or **Disable** from the menu and press **Enter**. A confirmation screen will appear. Select from **Yes** or **No** and press **Enter**. The output of monitor B will change immediately.

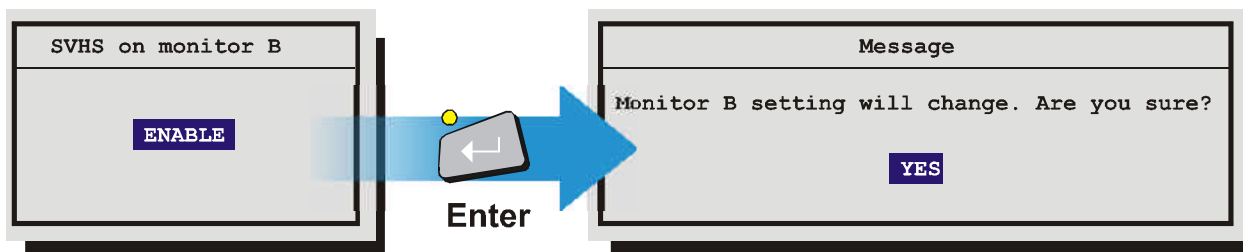

3.15 Archive Setup

Data recorded by the unit can be archived to an external archive device.

Use this menu to:

- Select the Port where the archive device will be connected.
- Turn Background Archiving mode **Off** and **On**.
- Erase the recorded data on a compatible archive device.
- Enable or Disable QuickWave Setup.

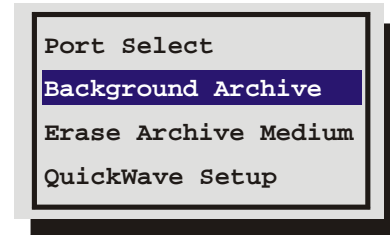

□ Main Menu ® Archive Setup ® Port Select

Select the Port or interface to which the archive device will be connected.

Select from the following items.

SCSI: SCSI archive devices.

1394: 1394 Firewire archive devices.

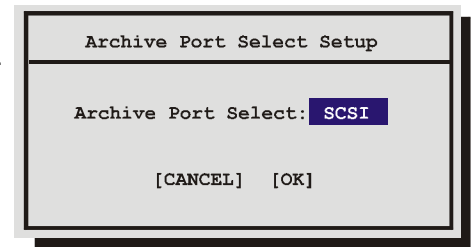

□ Main Menu ® Archive Setup ® Background Archive

Background Archive: Commands the unit to record data to both the hard disk and the archive device simultaneously.

Select from the following items.

OFF: Turns background archiving Off.

ON: Turns background archiving On.



□ Main Menu ® Archive Setup ® Erase Archive Medium

Use this feature to erase all of the recorded data on an archive device.

With **Erase Archive Medium** highlighted, press the **Enter** button. If a compatible archive device is connected, a confirmation box will appear, otherwise no action will occur.



□ Main Menu ® Archive Setup ® QuickWave Setup

This feature provides the option of having the QuickWave software written to any CDs that are created. This allows the CD to be read on any PC without installing software. Select **ON** to enable, **OFF** to disable.

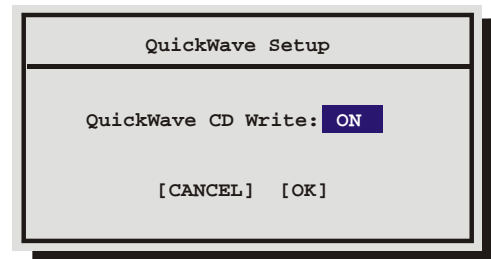

3.16 Audio Setup

Use this menu to enable or disable the audio feature of the Triplex. Select from:

- OFF
- G.711



Audio Limitations:

1. To record audio at least one the unit's video inputs must be set to record video at a rate of 1pps or faster.
2. If all the cameras are set to EVENT mode and no events are occurring, no audio will be recorded regardless of the event recording speed.

3.17 Communications

Use this menu to:

- Configure the baud rates and settings for the RS232 ports.
- Configure the network address for the RS485 network.
- Configure the Ethernet address and networks settings.

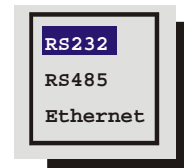

□ Main Menu ® Communications ® RS232

Select the Port you wish to configure and press the ENTER button.



Port 1

Use this menu to:

- Enable/Disable POTS and configure the Modem initialization string (POTS Setup).
- Adjust the Baud rate.

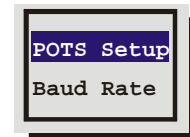

POTS Setup

The default modem string (shown below) is for use with Hayes Accura 56k, Diamond Supra Express 56k, and 5686 US Robotics modems in their default conditions. Consult with the modem manual before attempting to make any changes. It is strongly recommended that the modem initialization string only be modified by a qualified technician.

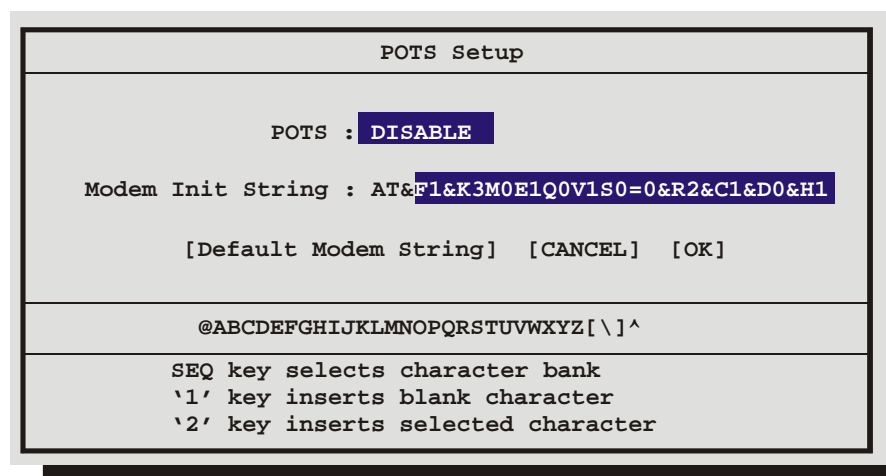

1. With the Modem Init String highlighted, press the **Enter** button to enter the Edit mode. The character bank will appear in the center of the menu.
2. Press the **Sequence** button to select the desired character bank.
3. Rotate the **Shuttle** to navigate the Modem Init String.
4. Rotate the **Jog** to select a character from the character bank.
5. Use the **Number 2** button or rotate the **Shuttle** to insert the desired character from the character bank into the Modem Init String and advance to the next character.
6. Use the **Number 1** button to insert a blank character.
7. When finished, press the **Enter** button.
8. To save the changes and reboot, select **OK**, then press the **Enter** button. The unit will only reboot if changes were made to the Modem Init String.
9. To exit the menu without making changes, select **Cancel**, then press the **Enter** button. Pressing the **Menu** button also exits the menu without making changes.

Baud Rate

Use this menu to configure the baud rate for Port 1. Rotate the Jog to select a baud rate from the menu.

Save changes and exit the menu: Press the **Enter** button.

Exit the menu without making changes: Press the **Menu** button.

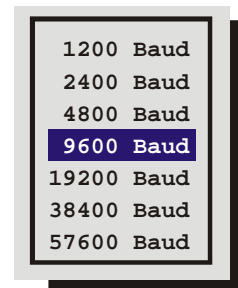

Port 2

Use this menu to configure the baud rate for Port 2. Rotate the Jog to select a baud rate from the menu.

Save changes and exit the menu: Press the **Enter** button.

Exit the menu without making changes: Press the **Menu** button.

The RS232 port 2 is used for Event Generation and ASCII Text Insertion. See Section 7 for the RS232 Protocol required to perform these functions.

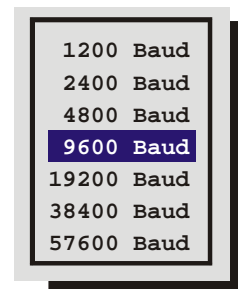

☐ Main Menu ® Communications ® RS485

Connect several units to a single keyboard, or vice-versa. Up to 32 units (any combination of multiplexers and keyboards) can be networked together. Use this menu to specify the units unique network address.

Save changes and exit the menu: Press the **Enter** button.

Exit the menu without making changes: Press the **Menu** button.

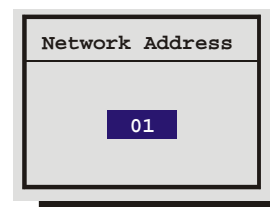

□ Main Menu ® Communications ® Ethernet Settings

An ethernet connection can be used to connect to the unit from a PC for the viewing of live or recorded images. Use this menu to configure the Ethernet communications settings. Select from the following:

Ethernet: Select Enable or Disable.

Hostname: The default Hostname is the unit's serial number without the dashes. The user should modify only when GnuDIP is selected in the Name Service field.

DHCP: Select Enable or Disable. Enables dynamic IP addressing. When DHCP is enabled, the IP address, Subnet Mask, Gateway, and Server fields are dynamically addressed.

Name Service: Select from Disable, WINS or GnuDIP. Enabling WINS registers the hostname and IP address within the current Network. This ensures that you can connect to the Triplex by hostname within the network. See the Note below for information on configuring Dynamic DDS with GnuDIP.

DDNS Update Interval: Select the Dynamic Domain Name Server interval. Select from Disable or from 1 to 1440 minutes.

IP Address / Subnet Mask / Gateway: Consult with a qualified Network Administrator or an MIS professional to configure these settings if DHCP is not enabled.

Primary Name Server / Backup Name Server: The IP addresses of the Primary and Backup Name Servers. Not required if DHCP is enabled.

Print Server: Enter the Print Servers IP address to enable the Print Image operation (Function and Zoom).

TCP MTU Size: Select from Standard, 1400, and 1200. The MTU describes the maximum possible TCP packet size. Standard (1500) is optimal for most ethernet network environments.

HTTP Port : Select the HTTP Port. Select from Port 0 to 65535. Shortcuts are available for port 80 (Camera 1 button) and 8080 (camera 2 button). Consult with a qualified Network Administrator or an MIS professional to configure these settings.

Ethernet Settings	
Ethernet	: Enable
Hostname	: D406T2250419
DHCP	: Disable
Name Service	: Disable
DDNS Update Interval	: 1 min
IP Address	: 3. 18.173. 60
Subnet Mask	: 255.255.254. 0
Gateway	: 3. 18.172. 1
Primary Name Server	: 3. 18.173. 12
Backup Name Server	: 3. 18.173. 13
Print Server	: 3. 18.173. 11
TCP MTU Size	: Standard
HTTP Port:	: 80
[CANCEL] [OK]	



In order to use Dynamic DNS with GnuDIP, the user has to configure following in the menus:

- **Name Service** must be set to GnuDIP (Ethernet Setting Menu).
- **Primary Name Server** must be set to the IP address of the GnuDIP server (Ethernet Setting Menu).
- **Hostname** must be set to the required hostname format e.g. *ge04.companyname.net*. For registration purposes, the string until the first dot is used as hostname (here: ge04), the remainder is used as domain (here: companyname.net). The hostname is set via the Ethernet Setting menu and is case sensitive.
- **DDNS update interval** must be set to a reasonable value (e.g. 2 minutes).
- The password for the DDNS server has to be set in the **Passwords->DDNS password menu**. The password is 4 digits long (The Enter button can be used for the number 0).

When everything is configured correctly, the DVMRe will send periodically a Dynamic DNS update message over TCP port 3495 to the Dynamic DNS server telling the server its hostname. The DVMRe does not include its IP address in the message. Instead the Dynamic DNS server extracts the IP address of the DVMRe via the Ethernet source IP address. This guarantees that the correct IP address is used even when the DVMRe is behind a NAT router.

3.18 Front Panel Lock

Use this feature to lock the front panel keypad. While locked, the only operational key on the front panel is the **Menu** button. To unlock the front panel, enter the Installer password and return to this menu.

Highlight the item you wish to select.

Save changes and exit the menu: Press the **Enter** button.

Exit the menu without making changes: Press the **Menu** button.

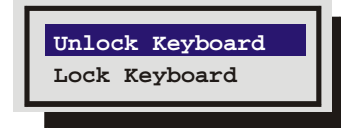

3.19 Factory Settings

Return To Factory Defaults

From the Factory Setting menu, press the **Enter** button. A password box will appear. Enter the Factory Default password. Select **OK**, then press the **Enter** button.

The unit will reboot, returning all settings (except the time, date, email addresses, and email IP address) to the factory defaults. Due to the large size of the hard disk, the reboot may take several minutes.

Factory Default Password	
10 and 16-Channel	8 1 1 1
4-Channel	4 1 1 1

Change Language

From the Factory Setting menu, enter the Language password. A menu will appear displaying the available language selections. Rotate the **Jog** to select the desired language.

Language Password	
10 and 16-Channel	5 4 1 5
4-Channel	1 4 1 4

Save changes and exit the menu: Press the **Enter** button.

Exit the menu without making changes: Press the **Menu** button.

Available Languages:

English	French	German
Italian	Russian	Polish
Czech	Finnish	Hungarian
Slovak	Spanish	Dutch
Danish		

3.20 Passwords

Use this feature to change the Installer, Operator or Ethernet passwords.

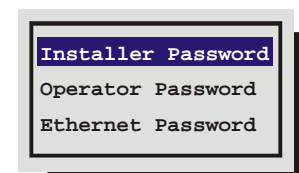

Changing the Installer or Operator Passwords

To change the password:

1. Highlight the password you wish to change, then press the **Enter** button. A password box will appear.
2. Enter the new password using the **Number** buttons.
3. Highlight **OK**, then press the **Enter** button.
4. Re-enter the password.
5. Highlight **OK**, then press the **Enter** button. The user will be prompted, indicating if the password was entered correctly and changed.

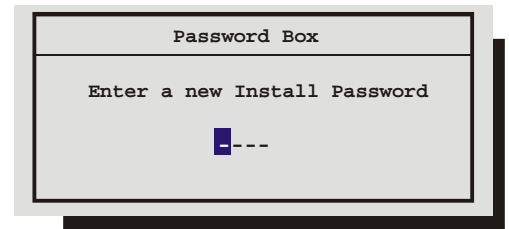

A screenshot of a terminal window titled "Password Box". The text inside reads "Enter a new Install Password" followed by a cursor and four dashes "----".

The Ethernet Password

The Ethernet Password feature limits access to only those users who access the unit using the password feature of WaveReader versions 2.3 or later. When the unit is first setup, the default is **No Password Protection**. Meaning, anyone using WaveReader and accessing with an ethernet connection can connect to the unit.



A screenshot of a terminal window titled "Password Box". The text inside reads "Enter a new Ethernet Password" followed by a cursor and four dashes "----".

Activate The Ethernet Password

1. Enter the new password using the **Number** buttons.
2. Highlight **OK**, then press the **Enter** button.
3. Re-enter the password.
4. Highlight **OK**, then press the **Enter** button. The user will be prompted, indicating if the password was entered correctly and changed.

Deactivate The Ethernet Password

To return the unit to **No Ethernet Password Protection**, enter the Ethernet Access Reset Password in the password box shown above.



A screenshot of a terminal window titled "Ethernet Access Reset Password". The text inside shows the number "1 1 1 1" with a cursor positioned under the first "1".

The DDNS Password

The DDNS password enables the DVMRe Triplex to contact the Domain Name Server in order to provide IP to Domain Name translation. You must obtain this number by calling you Domain Name Service. By default this password is 2222. This password is only used when **Name Service** in the Ethernet Settings Menu is set to GnuDIP.



A screenshot of a terminal window titled "Password Box". The text inside reads "Enter a new DDNS Password" followed by a cursor and four dashes "----".

3.21 The QuickInstall Menu

QuickInstall Menu Overview

After installation is complete, it is strongly recommended that, as a minimum, the items in the QuickInstall menu be configured before the unit is used.

All items located in the QuickInstall menu are also found in the Main menu. These items are provided in the separate QuickInstall menu as a convenience for the installer.

Use the following table to find detailed information about configuring specific items from the QuickInstall menu.

Change the time
Change the date
Edit Camera Titles
Camera Disable
Record Quality
Installer Password
Auto Disable Now

QuickInstall Menu Item	Primary Menu Location	Section In Manual
Change the time	Main Menu → Time/Date → Set Time	3.8
Change the date	Main Menu → Time/Date → Set Date	3.8
Edit Camera Titles	Main Menu → Camera Setup → Camera Titles	3.14
Camera Disable	Main Menu → Camera Setup → Camera Disable	3.14
Record Quality	Main Menu → Record → Record Quality	3.10
Installer Password	Main Menu → Passwords → Installer Password	3.20
Auto Disable Now	Main Menu → Camera Setup → Camera Disable → Auto Disable Now	3.14

3.22 The Operator Menu

The Operator Menu Overview

The Operator menu is provided so that the user has access to a limited number of menu items. These menu items are primarily monitor display setup options, so that the user may “personalize” the monitor displays during their shifts. Other options include video archive setup and changing the operator password.

None of the items are unique to the Operator menu. All items located in the Operator menu are also found in the Main menu.

Sequencing
Time/Date Display
Titles Display
Alarm History
Archive Setup
Operator Password

Use the following table to find detailed information about configuring specific items from the Operator menu.

Operator Menu Item	Primary Menu Location	Section In Manual
Sequencing	Main Menu → Sequencing	3.9
Time/Date Display	Main Menu → Time/Date → Time/Date Display	3.8
Titles Display	Main Menu → Camera Setup → Camera Titles → Title Display	3.14
Alarm History	Main Menu → Alarm → Alarm History	3.11
Video Archive Setup	Main Menu → Archive Setup	3.15
Operator Password	Main Menu → Password → Operator Password	3.20

3.23 The SystemView Menu

The SystemView Menu Overview

The SystemView menu is provided so that users may quickly view global software and hardware settings.

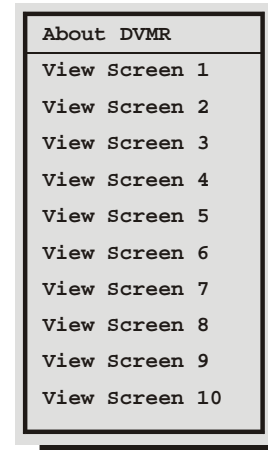

About DVMR menu: This menu provides information such as:

- Model Designation
- Serial Number
- Hostname
- Software Version
- Software Date
- Boot Code Version
- Hard Disk Size
- IP Address
- Hardware Address (MAC)
- DHCP Lease Expiration Date
- Last DDNS Update Status
- Last DDNS Update Success

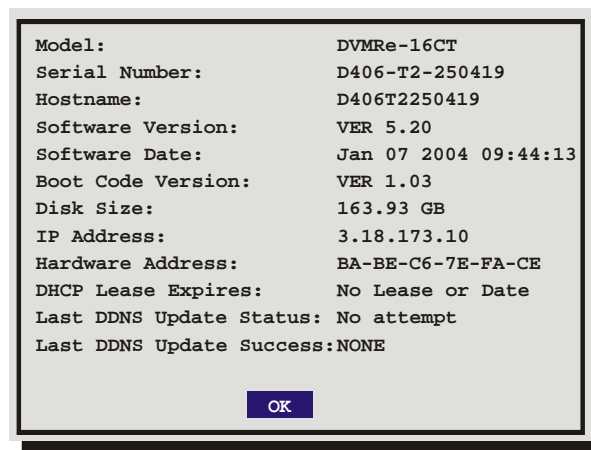

View Screens 1 through 10: These menus provide an overview of the units current operating parameters and the menu settings selected by the user or installer. Each View Screen is described in the following tables. The default values are **bolded** and *italicized*.

The View Screens

View Screen 1

Alarm Input

- Enable/Disable: **1 = Enabled**, 0 = Disabled
- Normally Open or Normally Closed: **0 = Open**, C = Closed
- Macro: Macro number if activated.

Alarm Action

- Freeze: **1 = Freeze**, 0 = No Freeze
- Cameras: Primary camera in alarm and three associated cameras.
- Relay: **1, 2, 1+2**, or None.
- Intrusion AND/OR: AND, **OR**

View Screen 2

Camera

- Enable/Disable: **1 = Enabled**, 0 = Disabled
- Signal Gain: AGC setting from 1 through 100. **50**
- Covert Camera: Yes or **No**
- Camera Title: **Camera x**, x=number

Videoloss Action

- Relay 1: 1 = Enabled, **0 = Disabled**
- Relay 2: 1 = Enabled, **0 = Disabled**
- Buzzer: 1 = Enabled, **0 = Disabled**

View Screen 3

Motion Detection

- Enable/Disable: **1 = Enabled**, 0 = Disabled
- Activity or Intrusion Detection: **I = Intrusion**, **A = Activity**
- Sensitivity: 1 through 10, **5**
- Relay Output: **None**, 1, 2, 1+2
- Link to Event: **Yes** or No
- Rejection Ratio: High, Medium, or Low
- Target Size: 1 through 256
- Alarm Camera: 1 through 4, 10 or 16

View Screen 4

Record Rate

- **Event Camera Settings:** T = Timelapse, E = Event, **ET = Event and Timelapse**
- **Timelapse Record Rate:** In pictures per second (pps). **30 spp**
- **Event Record Rate:** In pictures per second (pps). **1 pps**
- **Pre Event Duration:** 0 to 5 seconds. **2**
- **Post Event Duration:** 0 to 200 seconds. **0**
- **Activity Record Rate:** In pictures per second (pps). **2 spp**
- **Record Quality:** **High**, Medium, or Standard.
- **Event Associated Cameras:** Up to 3.

View Screen 5

Record Timer

- **DAY:** 1-31, Mon, Tue, Wed, Thu, Fri, Sat, Sun, Mon-Fri, Sat-Sun, Mon-Sun
- **Start:** Time (HH:MM)
- **Stop:** Time (HH:MM)
- **Macro:** Macro Number
- **On/Off:** On or **Off**

View Screen 6

- **Time and Date Display A:** **On** or Off.
- **Time and Date Display B:** **On** or Off.
- **Time Format:** 12 or **24 hour**
- **Date Format:** **MM/DD/YY**, DD/MM/YY, or YY/MM/DD
- **Master Clock:** Yes or No.
- **Multiscreen Dwell:** In seconds. **003**
- **Full Screen Dwell:** In seconds. **003**
- **Titles Display A:** **On** or Off.
- **Titles Display B:** **On** or Off.

View Screen 7

- **Record Mode:** No Overwrite, Write Once, or **Continuous**.
- **Indicate Detection:** On or **Off**.
- **Global Buzzer:** On or **Off**.
- **Live Alarm Buzzer:** On or **Off**.
- **Video Loss Buzzer:** On or **Off**.
- **Playback Buzzer:** On or **Off**.
- **Relay 1:** **Normally Open** or Normally Closed.
- **Relay 2:** **Normally Open** or Normally Closed.
- **Alarm Latch:** **T = Transparent**, L = Latched, TO (020) = Timed Out (Time)
- **Alarm Record Mode:** **Interleaved**, Exclusive, or No Change.
- **Full Screen Alarm:** Yes or **No**. This feature is not selectable on the 4-Channel units. **4ch = Yes**.
- **Global Alarm Record Rate:** In pictures per second (pps). **30 pps**
- **Pre Alarm Duration:** In seconds. **001**
- **Archive Alarm:** **Enable** or Disable.

View Screen 8

- **Auto Disable:** On or *Off*.
- **Background Archive:** On or *Off*.
- **Monitor Setup:** *Single* or Dual.
- **Baud Rate Port 1:** 1200,1400, 4800, 9600, 19200, 38400, and **57600**.
- **Baud Rate Port 2:** 1200,1400, 4800, 9600, **19200**, 38400, and 57600.
- **Network Address:** 001-005. **001**
- **Ethernet:** *Enable* or Disable.
- **POTS:** Enable or *Disable*.
- **Language:** *English*, German, French, Italian, Russian, Polish, Czech, Finnish, Hungarian, Slovak, Spanish, Dutch, or Danish.
- **Keyboard Lock:** On or *Off*.
- **Record Lock:** On or *Off*.
- **Regional Settings:** *Off*, USA, EUR, and AUS.
- **Time Zone:** *GMT+00:00*
- **QuickWave CD Write:** *On* or *Off*.

View Screen 9

- **NTP Update Interval:** Enable or *Disable*.
- **NTP Primary Server:** **3. 37. 8. 26**
- **NTP Backup Server:** **0. 0. 0. 0**
- **Subnet Mask:** **255.255.254. 0**
- **Gateway:** **3. 18.172. 1**
- **DHCP:** Enable or *Disable*.
- **Name Service:** *WINS* or Disable.
- **Primary Name Server:** **3. 18.173. 12**
- **Backup Name Server:** **3. 18.173. 13**
- **Print Server:** **3. 18.173. 11**
- **TCP MTU Size:** *Standard*, 1200, and 1400.
- **Archive Port Select:** *SCSI*, 1394.
- **SVHS on monitor B:** Enable or *Disable*.
- **DDNS Update Interval:** Disable, 1 – 1440 min. **2 minutes**.
- **HTTP Port:** **80** – 8080.

View Screen 10

- **Disk Test:** Test Now, Test Periodically or *Disable*.
- **Test Frequency in hours:** **0** – 1000.
- **Test Duration:** *Fast* or Thorough.
- **Disk Test Results:** *Disk Test Success* or *Disk Test Failed*.

4 Alarms

4.1 Alarm Input

Alarm devices are connected via the Alarm PCB on the back panel of the unit (see section 1.7). Each Alarm Input corresponds with the Camera Input of the same number. Alarm input to camera number assignments can be changed on 10 and 16-channel models. See Alarm Action menu (section 3.11).

4.2 Alarm Output

Front Panel Alarm LED: The LED located to the left and above the Alarm button is lit for the duration of the alarm.

Internal Buzzer: The internal buzzer is activated until it is Silenced and Acknowledged. This feature can be turned off in the menu system (see Buzzer Setup in section 3.11).

Monitor Displays: Discussed below in the **On-screen Displays During Alarms** section.

Output Relays: The alarm output relays are active for the duration of the alarm. This feature is configured in the menu system (see Alarm Action and Relay Configuration in section 3.11) and can be deactivated.

Macro Activation: Unit can be configured in the menu system to activate a macro when an alarm is detected.

Preset PTZ Camera commands: Unit can be configured in the menu system to send preset commands to specific cameras when an alarm is detected.

Record Rate: Record Rate can be increased by recording at the Alarm Record Rate (see section 3.10) and by Interleaved or Exclusive Recording (see Alarm Record mode in section 3.11).

4.3 Alarm Acknowledge

Pressing the **Alarm** button acknowledges to the unit that the alarm has been recognized and silences the internal buzzer. This does not clear the alarm condition.

4.4 On-screen Displays During Alarms

10 and 16-Channel Units

Monitor-A in Live Multiscreen Mode

Single Alarm: When a single alarm is received, the unit changes to 4-way display containing the camera in alarm, and three associated cameras. The three associated cameras are defined as a group in the menu system (see Alarm Action in section 3.11). The top left cameo displays the camera in alarm.

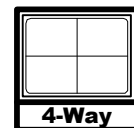

Single Alarm

Second Alarm: When a second alarm is received, the unit changes to a 10-way multiscreen, displaying the alarm cameras in the top two cameos. The associated cameras are displayed in the remaining cameos.

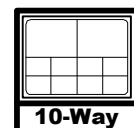

Second Alarm

Third Alarm: When a third alarm is received, the unit changes to a 9-way multiscreen, displaying the alarm cameras in the top three cameos. The associated cameras are displayed in the remaining cameos.

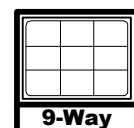

Third Alarm

More than three alarms simultaneously: The unit switches to the maximum multiscreen display, i.e. 16 or 10-way.

Other display options include:

- A full screen display of a single camera in alarm, with a sequenced full screen display for additional cameras in alarm. This option is selectable in the menu system (see Full Screen Alarm in section 3.11).
- Freeze camera display at the time the alarm was received.

Monitor-B Display During Alarm

Single Alarm: Unit switches to a full screen display of the camera in alarm.

Additional Alarms: Unit switches to a sequenced display of all cameras in alarm.

4-Channel Units

Single Alarm: Unit switches to a full screen display of the camera in alarm.

Additional Alarms: Unit switches to a sequenced display of all cameras in alarm.

4.5 Alarm Operations During Playback

Live Alarms Displays

Single Alarm: Unit switches to a full screen display of the camera in alarm on Monitor B.

Additional Alarms: Unit switches to a sequenced display of all cameras in alarm on Monitor B.

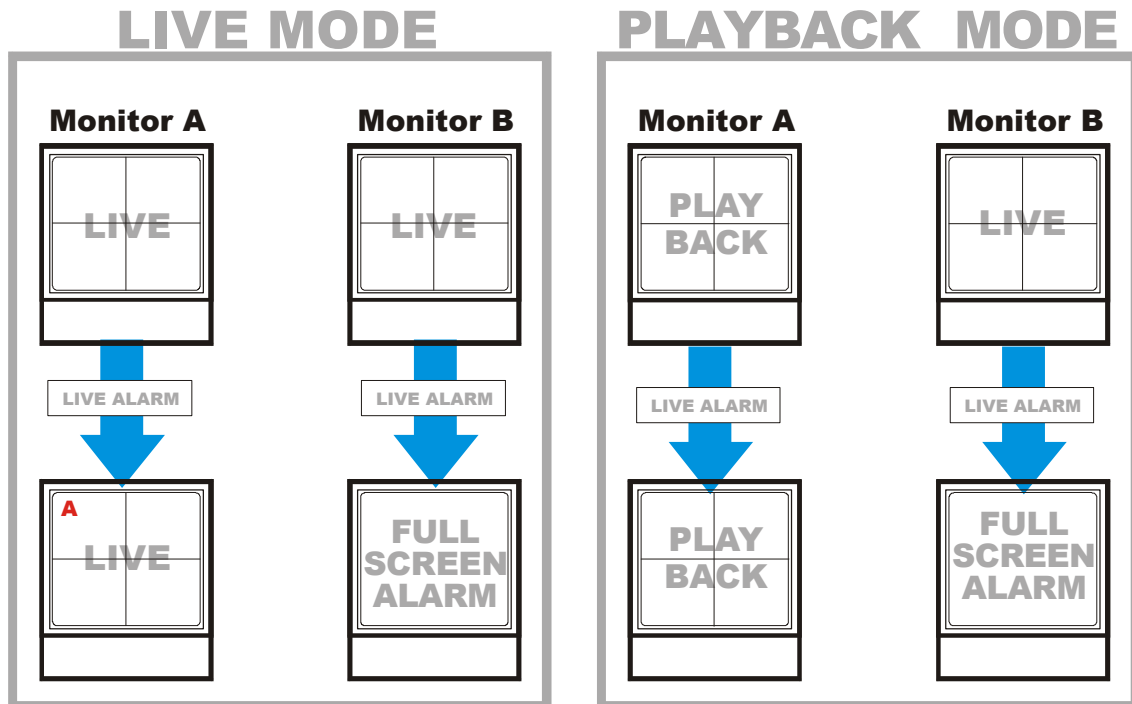

Recorded Alarms

Internal Buzzer: During playback, the internal buzzer is activated until it is silenced and acknowledged. This feature can be turned off in the menu system (see **Playback Buzzer**, Buzzer Setup in section 3.11).

Front Panel Alarm LED: The LED located to the left and above the **Alarm** button is lit for the duration of the alarm.

Monitor-A Multiscreen: Each camera in alarm is indicated on-screen by a flashing red “**A**” in its cameo. Alarm LED lights to indicate an alarm condition. There is no change in the playback (or Triplex) multiscreen based on playback of recorded alarms.

4.6 Alarm History Box

The Alarm History feature provides a list of the 100 most recent alarms. View the Alarm History Box by accessing the menu system, and selecting **Operator** ® **Alarm History**. The Alarm History Box can also be found under **Main Menu** ® **Alarm** ® **Alarm History**. For detailed information about viewing the Alarm History Box see Alarm History in section 3.11.

4.7 Searching For Recorded Alarms

See section 5.

5 Searching

The DVMRe Triplex is equipped with a powerful search interface to access video files stored on the hard disk or an external archive device.

Search Menu Overview

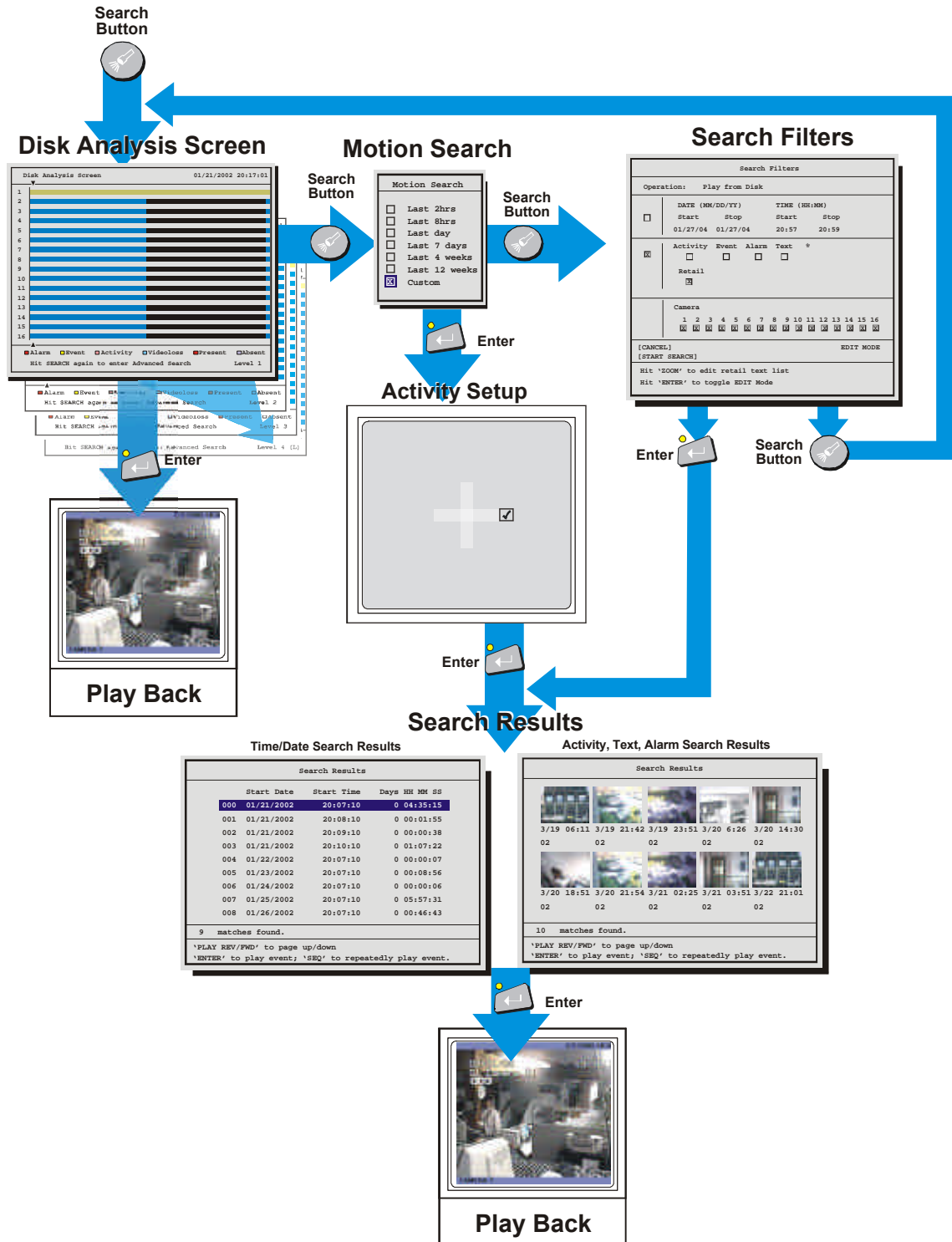

5.1 Disk Analysis Screen

Begin by pressing the **Search** button. The Disk Analysis Screen will appear. This screen shows a graphical representation of the recorded video stored on the internal hard disk.



Search Button

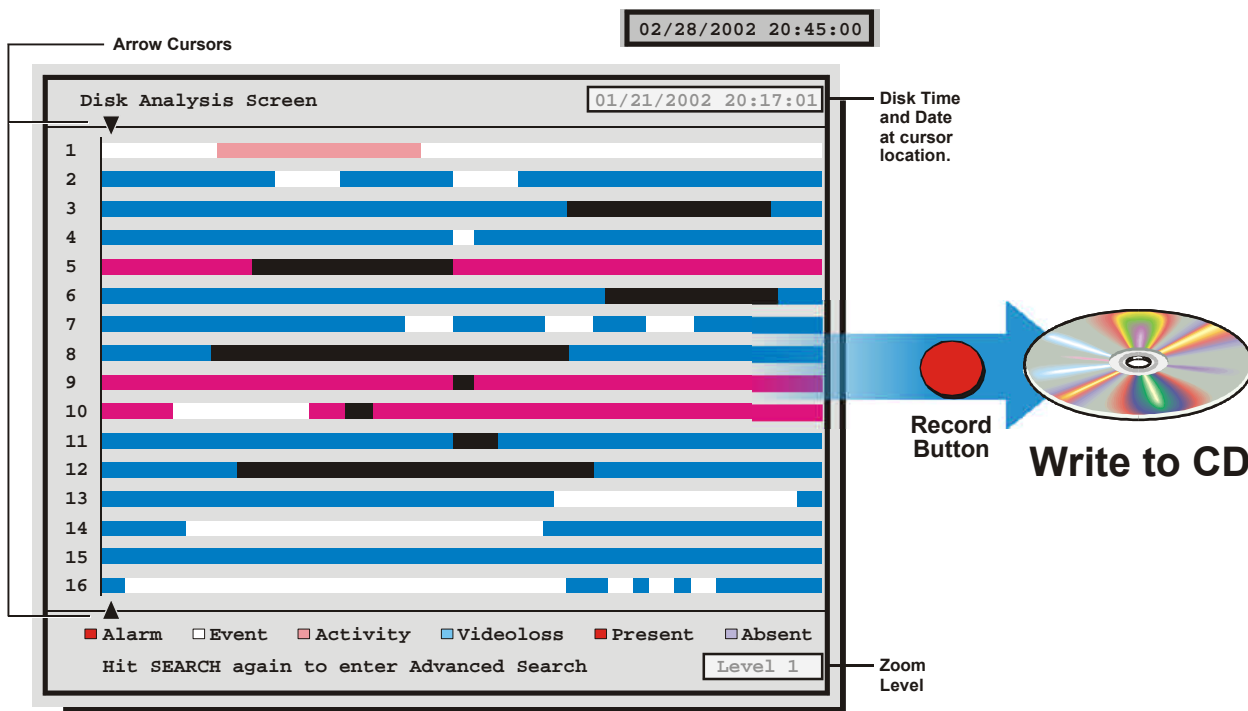

Rotating the **Jog** moves the two arrow cursors across the representation of the recorded video. As the cursors move across the screen the corresponding disk time is indicated in the upper right of the screen. The video representations are color-coded by category. Rotating the **Shuttle** expands (Zooms) the display. The Lowest level (most detail) is indicated on screen with an **(L)**. Pressing the **Enter** button will start Playback from the cursor location.

5.2 Quick Archive to CD

Archive to CD on the Disk Analysis Screen by selecting the time and date and pressing the record button. The QuickWave Setup must be set to ON from the Archive Setup → Quick Wave Setup menu (see section 3.15). The Archive Incident menu should appear.

1. Use the **Jog** to modify the time parameters and use the Shuttle to move between the Start and Stop fields.
2. Press the **Record** button on the front panel when satisfied.
3. The CD Writer will open the CD tray when completed.

The video may now be viewed on any PC equipped with a CD-ROM.

Archive Incident	
07/31/2003	02:20:06P
Start	Stop
02:02:51P	02:20:09P
Capacity: 557MB	
'RECORD' to Archive	

5.3 Motion Search

Pressing the **Search** button a second time will bring up the Motion Search menu. This menu performs a motion search with six preset time parameters and a custom search option. Rotate the **Jog** to navigate and the **Shuttle** to select a specific parameter. Selecting the **Custom** option and pressing the **Enter** button starts playback and brings up another window with Start/Stop, Time/Date options. These options provide the parameters to focus the search to a specific time period.

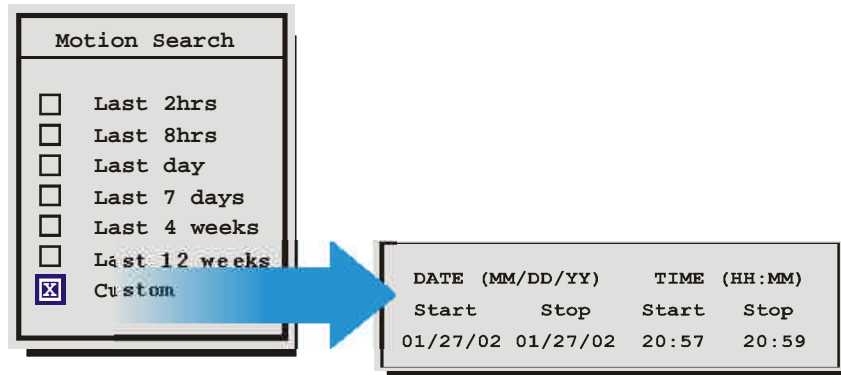

Selecting any of the other options and pressing **Enter** starts playback and displays the **Motion Search Setup Screen**.

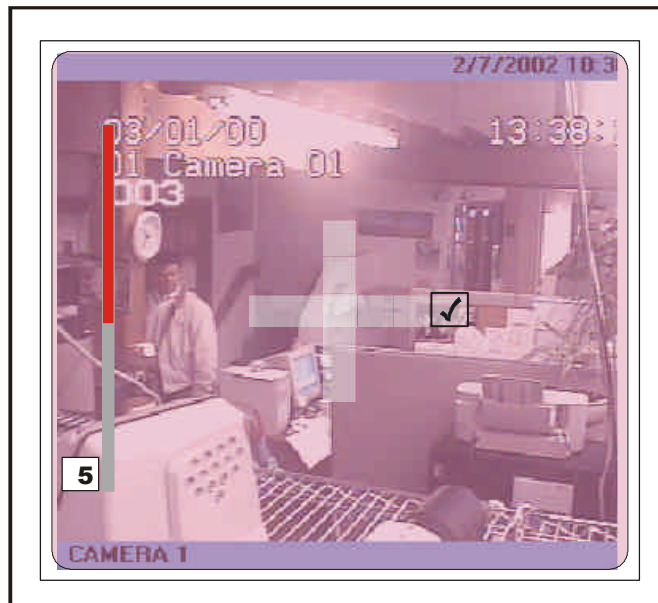

This screen overlays the current playback video and allows the user to enable or disable motion detection on the screen within blocks that form a 16 x 16 grid.

Pressing the **Function** key while in this screen overlays a help screen with all the available commands.

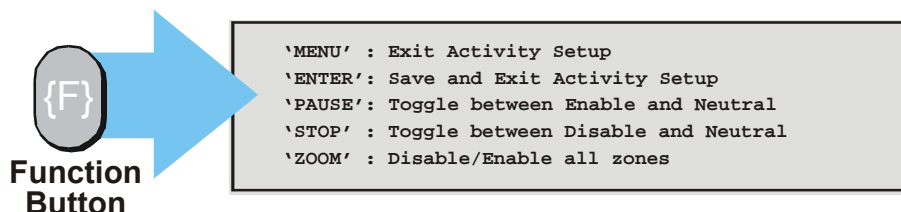

Pressing **Enter** upon completion of the activity setup will start the search and launch the **Search Results** window. See section 5.4 for operating instructions.

5.4 Search Filters

Pressing the **Search** button a third time brings up the Search Filters Menu. Use the Search Filters menu to specify:

- The type of operation to be performed: **Play from Disk**, **Play from Archive**, **Copy from Disk to Archive**, and **Copy from Archive to Disk**.
- The Start and Stop date of the search.
- The Start and Stop time of the search.
- Searching for recorded activity, events, retail text, or alarms.
- Searching for a text string.
- Which cameras to search inclusively or exclusively.

The screenshot shows the 'Search Filters' menu with the following sections and annotations:

- Operation:** A dropdown menu currently showing 'Play from Disk'. An annotation points to this section: 'The following options are available when an archive device is connected: 1. Play from Disk. 2. Play from Archive. 3. Copy from Disk to Archive. 4. Copy from Archive to Disk.'
- DATE (MM/DD/YY) TIME (HH:MM):** A table with columns for Start and Stop dates and times. The values shown are 01/27/04, 01/27/04, 20:57, and 20:59.
- Activity Selection:** A row of checkboxes for Activity, Event, Alarm, and Text. An annotation points to this row: 'Selecting these functions displays thumbnails in the Search Results window.'
- Retail:** A checkbox labeled 'Retail' which is checked. An annotation points to it: 'To access the Retail Search Menu select 'RETAIL' and press the 'ZOOM' key.'
- Camera:** A row of 16 numbered buttons (1-16), each with an 'X' in a box. An annotation points to this row: 'Hit Camera buttons to select/deselect individual cameras. Use the Zoom button to globally select/deselect cameras to search.'
- Navigation:** At the bottom, there are options for '[CANCEL]', '[START SEARCH]', and 'EDIT MODE'. Instructions at the very bottom read: 'Hit 'ZOOM' to edit retail text list' and 'Hit 'ENTER' to toggle EDIT Mode'.

Selecting Search Parameters

1. Rotating the Jog to navigate, highlight the **box** adjacent to the parameters that you wish to modify.
2. Once in the Parameter Box, use the **Shuttle** to navigate through the fields and the Jog to change the values.
3. To activate the parameter, use the **Shuttle** or the **Enter button** to place an **[X]** in the check box.
4. When finished, use the **Jog** to navigate to another parameter.

5.5 Retail Search

The local retail search feature is provided for customers who wish to search video for specific products from the front panel of the DVMRe. The customer can select from predefined product names from predefined categories. To use this feature you must create a text file containing the categories (product types) and product names (sub levels) that you want to search. This file is then uploaded to the DVMRe via the web interface.

Text File Format

To create a retail search text file open Notepad or any other simple text editor. The file must be saved as a text only file. The meta-character # is used in this text file to identify a category. All strings below a category are interpreted as sub levels of that category until another category appears. The creator of the retail text file is responsible to put the categories and sub levels into correct order. The DVMRe will not sort the strings. A category has to have at least one sub level. The customer has to store this file as a .txt file named retail_search.txt.

Example:

```
#Ice_Cream
Vanilla
Chocolate_Chip
#Soda
Vanilla
Root_Beer
Orange
#Beer
Draft
Light
Extra_Light
```

filename: retail_search.txt

Uploading/Downloading the retail_search .txt File

The retail search text file can be uploaded to the DVMRe unit via the Web interface. The index.ssi page will contain a link to the retail search page. Open the embedded web browser by typing the DVMRe's IP address in the address field of your Internet browser.

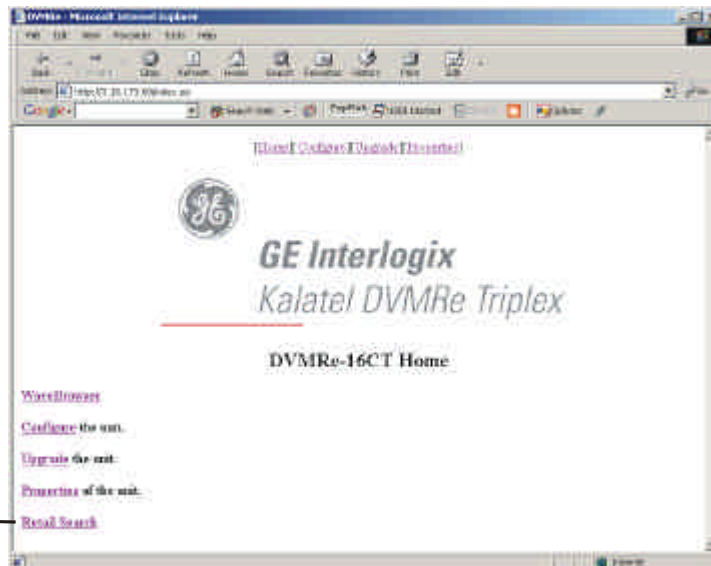

This page will appear if no retail text file has previously been uploaded. To upload the file, click the Browse button and navigate to the file location. Once the file is selected, click on the Upload Retail Search File button.

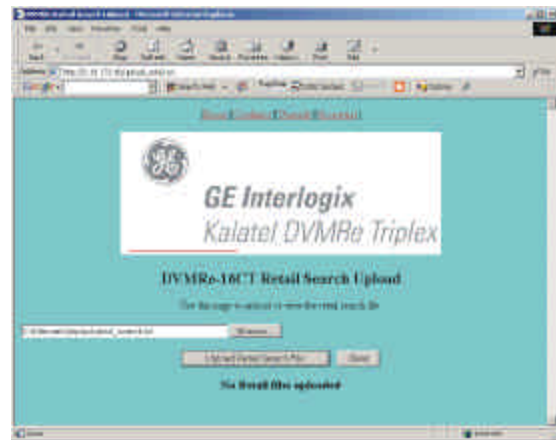
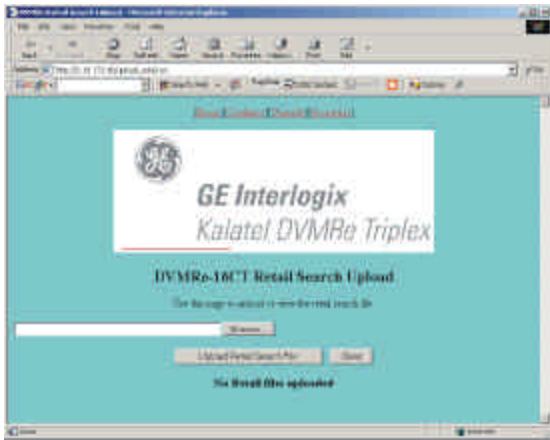

When the retail text file has been uploaded this page provides the options to delete or upload a new retail text file. The user can view the retail text file by clicking the link to the retail text file. The user can download the retail text file to a PC by right-clicking the link and by choosing 'Save Target As'. The user can only upload one retail text file and can delete the current retail text file. After uploading the file (and also after a reboot), the DVMRe will read the contents of the file and store it in memory.

The Local Retail Search Screen

Access to the Local Retail Search screen is gained through the Search Filters Menu. Press the Search button one or more times until the Search Filters Screen appears, then select the Retail radio box and press the Zoom key.

Search Filters																
Operation: Play from Disk																
<input type="checkbox"/>	DATE (MM/DD/YY)	TIME (HH:MM)														
	Start Stop	Start	Stop													
	01/27/04 01/27/04	20:57	20:59													
<input checked="" type="checkbox"/>	Activity	Event	Alarm Text *													
	<input type="checkbox"/>	<input type="checkbox"/>	<input type="checkbox"/>													
	Retail															
	<input checked="" type="checkbox"/>															
Camera																
	1	2	3	4	5	6	7	8	9	10	11	12	13	14	15	16
	<input checked="" type="checkbox"/>	<input checked="" type="checkbox"/>	<input checked="" type="checkbox"/>	<input checked="" type="checkbox"/>	<input checked="" type="checkbox"/>	<input checked="" type="checkbox"/>	<input checked="" type="checkbox"/>	<input checked="" type="checkbox"/>	<input checked="" type="checkbox"/>	<input checked="" type="checkbox"/>	<input checked="" type="checkbox"/>	<input checked="" type="checkbox"/>	<input checked="" type="checkbox"/>	<input checked="" type="checkbox"/>	<input checked="" type="checkbox"/>	<input checked="" type="checkbox"/>
[CANCEL] EDIT MODE																
[START SEARCH]																
Hit 'ZOOM' to edit retail text list																
Hit 'ENTER' to toggle EDIT Mode																

To access the Retail Search Menu select 'RETAIL' and press the 'ZOOM' key.



Setup Retail Search	
Categories	Ice_Cream
<input checked="" type="checkbox"/> (3)	Soda
	Beer
Sub Level	Vanilla
<input type="checkbox"/> (2)	Chocolate_Chip
Selected Strings	Vanilla
<input type="checkbox"/> Clear Individual (1)	
<input type="checkbox"/> Clear All	
[CANCEL]	
[OK]	
Hit 'ENTER' to toggle EDIT Mode	

Ice Cream selected from Category List

Vanilla selected from Sub Level

The following operations can be performed on this screen:

- Select category in the categories list.
- Select and deselect sub levels of the currently highlighted category.
- Clear individual or all selected sub levels.

3 categories, 5 sub levels, and 5 selected sub levels can be displayed on screen at one time. Up/down keys will scroll the screen backward and forward. The user can select sub levels from different categories by first selecting the category, then going to sub level frame and highlighting the selection. The user selections are kept in non-volatile memory so they survive a reboot. The user selections will be cleared when the user uploads a new retail text file. Like the other text searches, the results will display in thumbnail pictures and can be viewed through full screen playback with text.

Restrictions and Limitations

- The limit of the search strings is 1000. For example there might be 50 categories and 950 sub levels.
- It is not possible to have a second sub level (e.g. Soda>Diet Soda>Root _Beer).
- It is not possible to do a normal text search and a retail search at the same time.
- The characters #, *, and @ are meta characters and are not to be used in the text string.
- It is not possible to search for categories. In the previous retail search text file for example, the user cannot search for Beer.
- Only the first word of a sub level will be searched. For example, when the sub level 'Chocolate Chip' is selected, only the word 'Chocolate' will be searched for. The search string cannot contain blank characters or spaces and is not case sensitive.
- Only the first 30 characters of a category or sub level are displayed.
- The user can select up to 25 sub levels and search them simultaneously.
- A maximum of 200 matches are available for each specific search. The user can further modify searches by selecting time limit and cameras.









5.6 Search Results

Activate Search

From the Search Filters menu, use the **Jog** to navigate to the **Start Search** parameter. With the **Start Search** parameter highlighted, press the **Enter** button to begin the search operation. When finished searching, the Search Results window will appear. A maximum of 200 results can be displayed per search. Two types of Search Result windows will appear depending on the type of search that is performed.

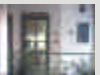
Activity, Text, Motion, Alarm Search Results

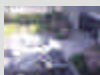
Search Results

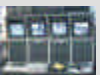
				
3/19 06:11	3/19 21:42	3/19 23:51	3/20 6:26	3/20 14:30
02	02	02	02	02
				
3/20 18:51	3/20 21:54	3/21 02:25	3/21 03:51	3/22 21:01
02	02	02	02	02

10 matches found.

'PLAY REV/FWD' to page up/down
'ENTER' to play event; 'SEQ' to repeatedly play event.

Time/Date Search Results

Search Results











	Start Date	Start Time	Days	HH	MM	SS
000	01/21/2002	20:07:10	0	04	35	15
001	01/21/2002	20:08:10	0	00	01	55
002	01/21/2002	20:09:10	0	00	00	38
003	01/21/2002	20:10:10	0	01	07	22
004	01/22/2002	20:07:10	0	00	00	07
005	01/23/2002	20:07:10	0	00	08	56
006	01/24/2002	20:07:10	0	00	00	06
007	01/25/2002	20:07:10	0	05	57	31
008	01/26/2002	20:07:10	0	00	46	43

9 matches found.

'PLAY REV/FWD' to page up/down
'ENTER' to play event; 'SEQ' to repeatedly play event.

Follow the directions on-screen to select, archive, playback, etc.

Search Results

				
3/19 06:11	3/19 21:42	3/19 23:51	3/20 6:26	3/20 14:30
02	02	02	02	02
				
3/20 18:51	3/20 21:54	3/21 02:25	3/21 03:51	3/22 21:01
02	02	02	02	02

10 matches found.

'PLAY REV/FWD' to page up/down
'ENTER' to play event; 'SEQ' to repeatedly play event.

Some options may be unavailable depending on the type of search performed. These options are not displayed. When archiving, the unit will not allow the amount of selected data to exceed the amount of space available on the target medium.

Press the **Menu** button to exit the Search Results window without making a selection.

Hitting the **Enter** button will play the selected search result.

Hitting the **Enter** button again while in playback will cause the next selection from the search list to be played.

Press the **Sequence** button to repeatedly play the selected event.

6 WebBrowser

The DVMRe Triplex has an integrated WebBrowser interface. The WaveBrowser option allows the user to view video from any ethernet connected Triplexes with software version 4.09 or above.



For WaveBrowser to function properly, certain ActiveX controls must be set correctly. To setup the ActiveX controls:

1. Click on the Tools → Internet Options Menu in Internet Explorer.
2. Click on the Security tab.
3. Select Internet for the Web Content Zone.
4. Click on the Custom Level button.
5. Ensure that both Download unsigned ActiveX controls and Initialize and Script ActiveX controls not marked as Safe are set to Prompt.
6. Click the OK button.
7. Click on the Yes button in the Warning message.
8. Click the OK button in the Internet Options window.

To access the web interface:

1. Launch Internet Explorer (version 5.5 or later) on any local Internet connected PC or laptop.
2. Type in the Triplex's IP address or hostname in the address field and press enter. The Enter Network Password box should appear.
3. Enter the correct Username and Password in their respective fields (the default username and password is admin). Click the OK button.
4. The WaveBrowser window should appear. Type the IP address in the IP Address Field and click the Connect button.

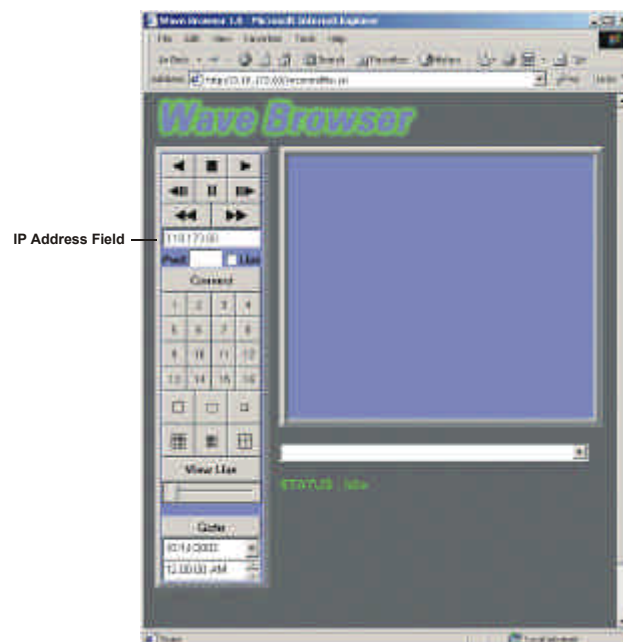

6.1 WaveBrowser Overview and Controls

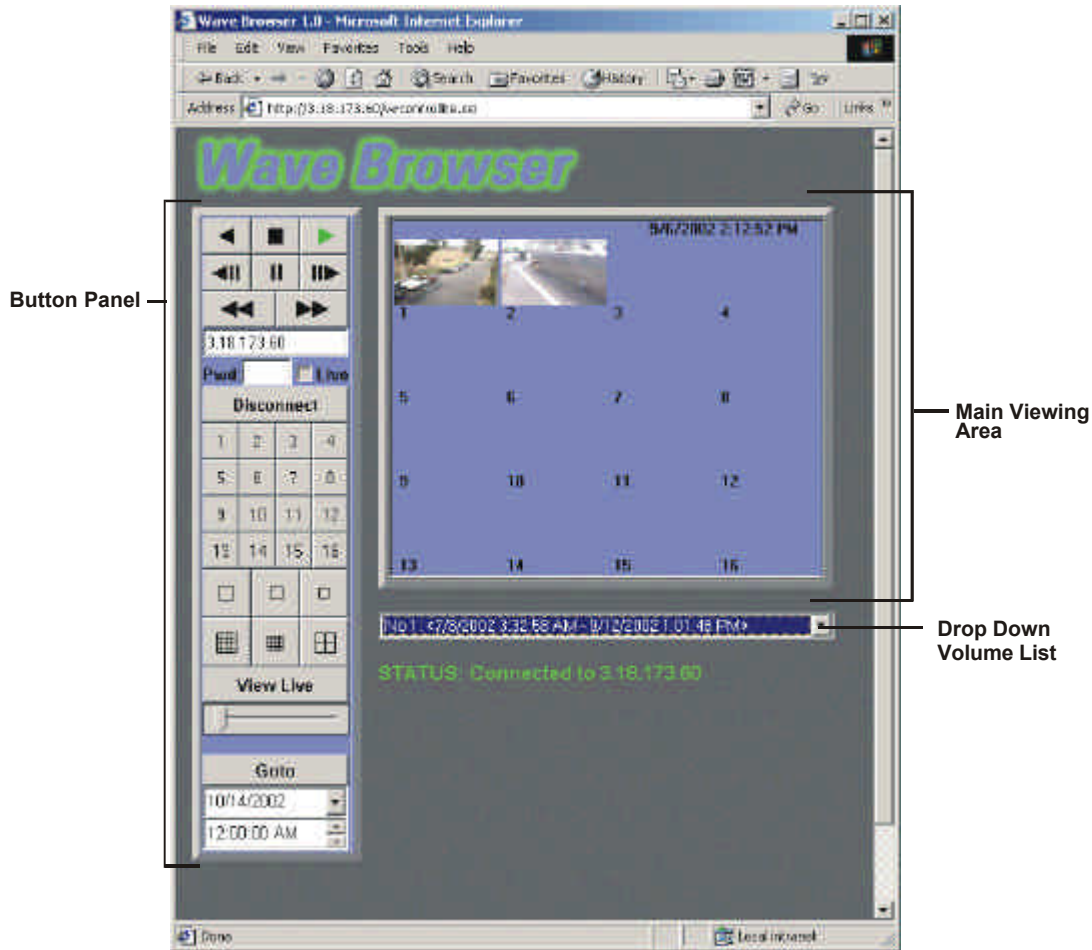

The Main program window consists of the following areas:

- **The Main Viewing Area:** The large blue area.
- **The Button Panel:** The left side of the window.
- **The Drop Down Volume List:** Allows the selection of available Disk volumes.

The Main Viewing Area

Pictures are displayed in this area in Multi-Camera, and Single-Camera formats. Picture display order is according to the information encoded by the unit used to create the original video data file.

Choose from the following displays:

- 16-way Multiscreen Display (Large and Medium)
- 4-way Display
- Single Camera Display Large
- Single Camera Display Medium
- Single Camera Display Small

The Button Panel

- 1. Play Backward button:** Click on this button to playback video in reverse.
- 2. Stop button:** Click on this button to halt all playback operations. The Play Pointer Slider Bar moves to the start of data.
- 3. Play Forward button:** Click on this button to playback video.
- 4. Single Frame Rewind button:** Click on this button to rewind the video a single frame.
- 5. Pause button:** Pauses playback until the Pause button is pressed again. Clicking any of the buttons, except Stop will also resume playback. The Play Pointer slider bar stays at the current position while paused.
- 6. Single Frame Advance button:** Click on this button to advance the video a single frame.
- 7. Rewind button:** Click on this button to perform high-speed reverse playback.
- 8. Fast Forward button:** Click on this button to perform high-speed playback.
- 9. IP Address Field:** Enter the unit's IP address.
- 10. Password Field:** Enter the unit's password, if necessary.
- 11. Live check box:** Click in this box to enable live viewing before connecting.
- 12. Connect/Disconnect button:** Click on this button(s) to connect to the unit.
- 13. Number buttons:** Press any of these buttons to call up individual cameras for display. When connected to a unit that has more than 16 cameras, right-clicking over the number buttons will display numbers 17 through 32. Right-click again to return to cameras 1 through 16.
- 14. Single Camera Display Size:** Choose from Small, Medium, or Large.
- 15. 16-way Multiscreen button:** Choose from a Medium 16-way, or Large 16-way.
- 16. 4-way Multiscreen button:** Selects a Large 4-way display.
- 17. View Live Button:** Click on this button while connected to view live video.
- 18. Play Pointer Slider Bar:** The Play Pointer slider bar advances to the right to indicate the playback position on the disk. The user can drag the bar to navigate forward or backward.
- 19. Goto Button:** Click on this button to go to the selected date for the drop down time and date boxes.
- 20. Drop down Date Selection Menu:** Click on this field to display a graphic calendar to select a date to view.
- 21. Time Selection Menu:** Click on the Up or Down Arrows to select a specific time to view.

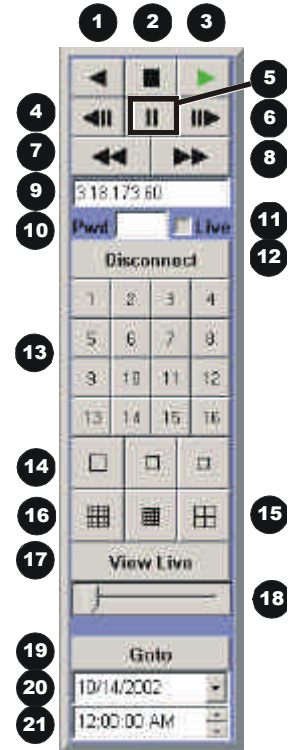

The Drop Down Volume List Box

Click on the arrow to display a list of available disk volumes on the connected unit. Click on the volume to select.

6.2 DVMRe Triplex WaveLink

A new feature with Triplex software version 5.00 is the DVMRe Triplex WaveLink. This feature allows putting command codes in the URL when calling WaveBrowser to control actions the WaveBrowser is going to perform.

This feature can be used by Web Developers to link various cameras to specific Web content. It will also be used by the DVMRe Email feature to allow the recipient of an alarm email to click on a link in the email, which causes the WaveBrowser to connect and play back at the time when the alarm occurred.

Functionality

The traditional WaveBrowser URL is **http://<IP_Address>/wrcontrollite.ssi**. This URL will start the WaveBrowser in the disconnected state. Triplex software version 5.00 supports command codes placed after an underscore after **wrcontrollite** and before **.ssi**. In the following example, the options are in bold.

Example: **http://3.18.172.230/wrcontrollite_c=1s=2a=3t=1361959858.ssi**.

The following table specifies the supported options:

Name	Code	Description	Example
Camera	c=<n>	Describes either the camera number for fullscreen (1=Camera 1, ... 16=Camera 16) or the type of the multiscreen display (100 = Multiscreen 16 large, 101= Multiscreen 16 small, 102= Quad screen)	c=10
Size	s=<n>	For fullscreen camera, describes the size of the display (1=large, 2 =medium, 3= small)	s=2
Action	a=<n>	Describes the action the WaveBrowser has to take: 0 No action 1 Normal Connection Play 2 Normal Connection Live 3 Normal Connection Goto 4 Live Connection	a=2
Time	t=<n>	When action is set to 3 (Goto), the time specifies where to go in number of seconds since 01/01/1960.	t=1361959858



Please Note: When an option is not specified, it will be set to 0.

When a normal connection is requested, but the DVMRe unit is already connected via a normal connection, the WaveBrowser should open a live connection instead.

The default page, <http://3.18.172.230>, does not accept option codes and will open the WaveBrowser in disconnected state.

The example URL from above (http://3.18.172.230/wrcontrollite_c=1s=2a=3t=1361959858.ssi) requests the WaveBrowser to make a **normal connection, play back at 2/27/2003 10:53:32** displaying **camera 1** in **medium size**.

Email Links

The DVMRe Triplex is able to send emails when certain events occur (like videoloss, alarms, etc.). When in record mode, the Triplex software version 5.00 will add a WaveBrowser link in the email notification. It will only add a link in the email if **Notify Alarm** is set to **enable** and the link will only pertain to the Alarm start.

Clicking this link initiates WaveBrowser to be started, make a normal connection and play back the specific camera with a medium size video window at the time the alarm occurred.

7 Technical Specifications

General	
External Power Supply	12 Volt DC. 60 Watt (5 Amp)
Connector	2.1mm barrel connector, center positive.
Power Consumption	35 Watt nominal (single hard disk).
Operating Temperature Range	Operating: 0 to 40°C. Storage: -20 to +60°C.
Relative Humidity Range (Non-Condensing)	Operating: 10% to 80%. Storage: 10% to 95%
Dimensions	17.5 x 14 x 1.7 Inches. 1U, 19 inch rack unit.
Weight	9 Lbs.

Connections	
10/100 Ethernet Port	RJ-45 Connector.
RS232 Port 1	DB-9 Male Connector.
AUX Port	DB-9 Male Connector.
RS232 Port 2	RJ-45 Connector.
Camera Inputs	BNC connectors. Auto Terminating. Color & Mono.
Monitor-A Output (Y/C)	4-pin Mini-DIN Connector.
Monitor-B Output (Y/C)	4-pin Mini-DIN Connector.
Monitor-A Output (Composite)	BNC Connector.
Monitor-B Output (Composite)	BNC Connector.
RS485 Port	Two Looping RJ-45 Connectors
SCSI Port	50 pin, High Density SCSI-2 female connector.
IEEE 1394 Firewire Port	6 position IEEE 1394 Socket
Alarm I/O Port	Use Supplied DB-25 PCB connector.

Video	
Video Signal Input	0.5 to 2.0 Volts peak-to-peak with Automatic Gain Control.
Video Signal Output	1 Volt peak-to-peak into 75-Ohm.
Input Termination	75-Ohm (Auto Terminating)
Display Memory	4 Megabytes
Resolution	Horizontal: 720 Pixels. Vertical: 484 Lines (576 for PAL).
Gray Scale	256 levels
Colors	Y:U:V 4:2:2, 16.8 Million Colors
Compression Standard	Wavelets

Audio	
Audio Input	315mV, 40k Ohms. Unbalanced.
Audio Output	315mV, 600 Ohms. Unbalanced.

Alarms	
Inputs	1 per camera.
Relay Configuration	User programmable as Normally Open or Normally Closed.
Record Priority	Interleaved, Exclusive, or No Change.
Alarm Status Indicators	Relay Outputs, On-screen Indicators. Status Retrievable via RS232 port.

Motion Detection	
Zones Per Camera	256: 16 x 16 grid.
Sensitivity Settings	10 levels
Gray Levels Per Zone	256 levels
Motion Detection Status Output	Relay Outputs, Link to Alarms, Link to Events, On-screen Indicators. Status retrievable via RS232 port.

Part Numbers	
Remote Keyboard	CBR-KB3, CBR-KB3/J, KTD405. Includes motorized pan, tilt, and zoom controls.
Rack Mount Kit	CBR-RK6. 1U Height. Part Number: 0110-R601
Replacement Manual	0150-0193

8 RS232 Alarm/Event Generation/Text Insertion Protocol

The RS232 Alarm/Event Generation /Text Insertion Protocol is designed to deliver Alarm, Event (commands), and Text data to the DVMRe from serial interface devices through the RS232 port.



Setting and Clearing Alarms with this Protocol is equivalent to activating and deactivating Alarms on the hardware alarm inputs.

8.1 Message Structure

The **Delimiter** byte signals the start of a new message, and has a value of 0xFF.

The **Class** and **Command** fields identify the type of message.

The **Data Length** is a 16-bit value indicating the number of bytes in the **Data** portion of the message. Data Length is sent using Intel byte ordering (Little Endian).

The **Check Sum** byte is the result of XORing all the bytes in the message.

Delimiter
Class
Command
Data Length
Data
Check Sum

8.2 Message Type

One message is currently supported to store text along with recorded video.

CMD_NEW_ADD_TEXT

Class byte is 0x14.

Command byte is 0x40.

Data Length is the number of data bytes in the message (from 2 to 502).

Camera byte indicates the camera associated with the alarm, event, or text. The valid range is from 0 to 15.

Alarm/Event byte usage is described in the following section.

String fields contain text characters. The string length can be from 0 to 500 characters in length. The String field is not required. If text data is available, it will be recorded with the next video frame for the camera identified by the camera field.

0xFF
0x14
0x40
Data Length[0]
Data Length[1]
Camera
Alarm/Event
String[0]
String[1]
:
String[n-1]
Check Sum

8.3 Alarm/Event Fields

The two least significant bits are currently used for the Event commands. Bits 2 and 3 are used for the Alarm commands.

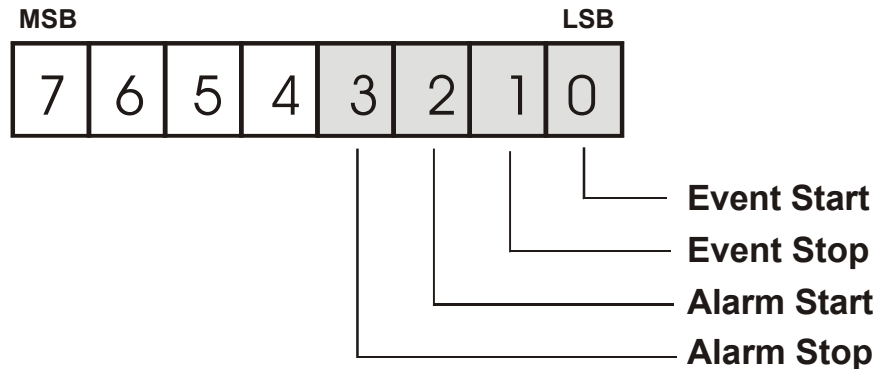

8.4 Alarm Actions

No Alarm Change – 0000 00XXb

If both the start and stop bits are clear, the alarm status and camera record rates will remain unchanged.

Start Alarm – 0000 01XXb

If only the start bit is set, the DVMRe will enter the Alarm mode. The selected camera will become the alarm camera. Pre-alarm video will be recorded and the Alarm Record Rate will be initiated.



Every Start Alarm command should subsequently be followed with a Stop Alarm command at some point. Failure to do so will render that alarm input useless, even if the alarm was latched and gets acknowledged from the front panel. A Stop Alarm followed by a Start Alarm will have to be sent to create a new alarm on that channel.

Stop Alarm – 0000 10XXb

If only the stop bit is set, the selected camera's alarm status will be cleared. If no other alarms are present, the DVMRe will exit the alarm mode.

Momentary Alarm – 0000 11XXb

If both the start and stop bits are set, a momentary alarm will be initiated on the selected camera. Pre-alarm video will be recorded at the alarm record rate, after which the DVMRe will continue to record video at the normal record rate.

8.5 Event Actions



All Event messages will be ignored while an Alarm condition exists in the DVMRe.

No Event Change – 0000 0000b

If both the start and stop bits are clear, there will be no change to the event status. The camera's record rate will not be changed.

Start Event – 0000 0001b

If only the start bit is set, an event will be initiated on the selected camera. This will cause the selected camera, as well as any pre-event video to be recorded at the Event Record Rate.

Stop Event – 0000 0010b

If only the stop bit is set, the current event on the selected camera will be terminated. This will start the post-event timer after which, the selected camera will resume recording at the normal record rate.

Momentary Event – 0000 0011b

If both the start and stop bits are set, a momentary event will be initiated on the selected camera. Pre-event video will be recorded at the event record rate for the selected camera. The post-event timer will continue recording at the event record rate, after which the selected camera will resume recording at the normal record rate.

9 RS232 Remote Control Protocol

The unit supports two different communication types:

- Remote Front Panel Button Emulation
- Remote Configuration and Status

9.1 Front Panel Button Emulation

Data Structure

Byte 1: 0xFF
 Byte 2: 0x55
 Byte 3: Front Panel Button Code

Description

Byte 1 and 2 are header bytes.

Byte 3 contains the code for a specific front panel button.

The different buttons and their corresponding codes are as follows.

No Button Pressed	0
Record	1
Play	2
Stop	3
Alarm	4
Freeze	5
Zoom	6
Sequence	7
Reserved	8
Camera 1	9
Camera 2	10
Camera 3	11
Camera 4	12
Camera 5	13
Camera 6	14
Camera 7	15
Camera 8	16
Camera 9	17
Camera 10	18
Camera 11	19
Camera 12	20
Camera 13	21
Camera 14	22
Camera 15	23
Camera 16	24
Reserved	25 - 40
Menu	41
Enter	42
Reserved	43
Macro	44
Reserved	45-49

Monitor B	50
Reserved	51-63
Left Arrow	64
Right Arrow	65
Up Arrow	66
Down Arrow	67
Reserved	68-74
Alarm and Sequence	75
*Alarm and Camera 1	76
*Alarm and Camera 2	77
*Alarm and Camera 3	78
*Alarm and Camera 4	79
*Alarm and Camera 5	80
*Alarm and Camera 6	81
*Alarm and Camera 7	82
*Alarm and Camera 8	83
*Alarm and Camera 9	84
*Alarm and Camera 10	85
*Alarm and Camera 11	86
*Alarm and Camera 12	87
*Alarm and Camera 13	88
*Alarm and Camera 14	89
*Alarm and Camera 15	90
*Alarm and Camera 16	91
Reserved	92-110
Search	111
Frame Reverse	112
Frame Forward	113
Play Reverse	114
Stop	115
Play Forward	116
Monitor A	130
2 Way Multiscreen	131
4 Way Multiscreen	132
6 Way Multiscreen	133
7 Way Multiscreen	134
9 Way Multiscreen	135
10 Way Multiscreen	136
13 Way Multiscreen	137
16 Way Multiscreen	138

*Must send a "No Button Pressed" command immediately following any of these commands.

9.2 Configuration and Status

i) Data structure

Byte 1: 0xFF
 Byte 2: Command Type
 0xAA: (SET) Update DVMRe with data.
 0xBB: (GET) Extract data from DVMRe.
 Byte 3: Data Length (n)
 Byte 4: Data Type
 0x61: Restart DVMRe
 0xFE: Send configuration data to DVMRe
 0x09: Read Alarm History from DVMRe
 0xFF: Read configuration and status data from DVMRe
 Byte 5: Data byte 1
 Byte 6: Data byte 2
 :
 :
 Byte x: Data byte n

ii) Sending data to the DVMRe

a) Restart DVMRe Triplex

This command will restart the DVMRe Triplex.

Byte 1: 0xFF
 Byte 2: 0xAA
 Byte 3: 0
 Byte 4: 0x61

b) Send data to DVMRe Triplex

Configuration data can be sent to the DVMRe Triplex, to change the way it operates. The data is arranged in the form of 16 byte blocks, numbered from 1 to 213. Blocks 182, 183 and 185 are status blocks, and hence cannot be written to. For details about the contents of each block, contact GE-Interlogix and request the **Block Data Structure** for the DVMRe Triplex.

Byte 1: 0xFF
 Byte 2: 0xAA
 Byte 3: 17
 Byte 4: 0xFE
 Byte 5: Block Number
 (1-181, 184, 186-213)
 Byte 6: data[0]
 :
 :
 Byte 21: data[15]

After sending a block or series of blocks, block number 255 must be updated to signal the end of the configuration session. All data bytes for block 255 must be set to 0.

iii) Requesting data from the DVMRe

When a message of type 0xBB is sent to the DVMRe Triplex, it will respond by sending 16 bytes of requested data.

a) Read Alarm History List

Byte 1: 0xFF
 Byte 2: 0xBB
 Byte 3: 0
 Byte 4: 0x09

When the "Read Alarm History List" message is received by the DVMRe Triplex, it responds by sending a start byte 0xFF, followed by ASCII strings for every alarm event in its alarm history list, and a stop byte, 0xFF. Each string is formatted as follows:

dd.bmm/ddbhh:mm:ssbaa<CR><LF>

dd: index number (00 - 99)
 b: space character
 mm: month (01-12)
 dd: day (01-31)
 hh: hours (00-23)
 mm: minutes (00-59)
 ss: seconds (00-59)
 aa: alarm number (01-16)
 <CR> Carriage return (0x0D)
 <LF> Line feed (0x0A)

Example: 03. 11/27 22:48:58 15

b) Read data from DVMRe Triplex

Configuration and status data can be read from the DVMRe Triplex. The data is arranged in the form of 16 byte blocks, numbered from 1 to 213. For details about the contents of each block, contact GE-Interlogix and request the **Block Data Structure** for the DVMRe Triplex.

Byte 1: 0xFF
 Byte 2: 0xBB
 Byte 3: 1
 Byte 4: 0xFF
 Byte 5: Block Number 1-213 or 255 if all blocks are requested.

The DVMRe Triplex responds to the "Read data" request by sending all the requested data bytes consecutively, without any start or stop bytes.

A total of either 16 bytes or 3408 bytes will be transmitted, depending on whether a single block or all the blocks were requested.

10 Macro Tables

Photo copy this page and use it to keep a record of the programmed macro functions.

10.1 Macro Functions Table

Macro Number	Description
1	
2	
3	
4	
5	
6	
7	
8	
9	
10	
11	
12	
13	
14	
15	
16	
Function + Sequence	Daylight Savings Time: Sets clock ahead one hour in April, and back one hour in October.

10.2 Scheduled Macro Table

Event	Day	Time	Macro to Run
1			
2			
3			
4			
5			
6			
7			
8			
9			
10			
11			
12			
13			
14			
15			
16			
17			
18			
19			
20			

11 Warranty and Service

11.1 Factory Service



Warning: Do not open the top cover or attempt to service the unit, as this may expose you to dangerous voltages and other hazards. Programmer maintenance of this unit is limited to external cleaning and inspection. Refer all servicing to qualified personnel.

If the unit requires factory service, contact the dealer who supplied the unit to you for the correct procedures on returning the unit to the factory or the nearest factory service center.

If the dealer is not available, contact the manufacturer of the unit as detailed below and request a Return Material Authorization number (RMA). The unit's serial number must be provided before a RMA number can be issued. Units returned to the factory for service must have freight and insurance prepaid, and must show the RMA number clearly on all shipping documents. The failure symptoms must be clearly described by the operator and enclosed with the unit together with a copy of the original suppliers invoice. Failure to comply with these instructions will delay service of the unit, and may result in the unit not being accepted by the Repair Center.

Factory Address

GE Security

Attention: Repair Center

3050 Redhill ave

Costa Mesa, CA. 92626

United States of America

Telephone: 800-343-3358 (7:00 AM to 4:30 PM, Pacific Time)

In Oregon: 541-754-9133

Fax: 541-754-7162 (24 hours a day)

For warranty information, see the following page.

11.2 Warranty and Return Information

GE Security warrants all of its equipment for three years from the date of purchase. This warranty covers any defects in materials and workmanship. Equipment failures that are due to improper installation, modification, abuse, or acts of nature will not be covered by this warranty. The repair department will evaluate all equipment returned for repair to determine warranty coverage. The Tech Support Manager will resolve any questions that may arise during evaluation to make a final determination.

Note: The three-year warranty does not apply to the following products:
MobileView® and the monitor CRT, which carry a 12-month warranty from the date of purchase.

The warranty specifically covers any defects in material and workmanship and does not cover equipment that has been abused, damaged, or modified.

For all warranty repairs, GE Security will cover all costs, including parts, labor, and shipping. Repaired equipment will be returned via the same method of shipment in which it was received. If a customer requests a faster return shipment, the difference will be charged.

For all non-warranty repairs, the customer will be billed for parts, labor, and shipping. Labor will be billed in half-hour increments.

Note: Customers requesting an estimate prior to repair will be notified by phone. If they cannot be reached, they will be notified by fax. If we are unable to reach the contact person for repair authorization after one phone attempt and two fax attempts, the equipment will be returned without being repaired. We will hold equipment no longer than two weeks.

Advance Replacement Policy

When an advance replacement is required, we will send the customer replacement equipment from our stock and receive the returned product in exchange. The received equipment will be evaluated and the repair department will determine whether it is a warranty replacement. If it is non-warranty, see our repair policy above for details. The following guidelines will be used for all advance replacements:

- Fewer than 45 days from purchase, GE Security will replace the product with new equipment.
- From 45 days to 1 year from purchase, GE Security will replace the product with refurbished equipment.
- From 1 year to 3 years from purchase, the product must be sent in for repair. Advance replacements will be sent for a fee of \$100.

If you have questions about this policy, please contact the GE Security RMA Department at 800-469-1676.

Free Manuals Download Website

<http://myh66.com>

<http://usermanuals.us>

<http://www.somanuals.com>

<http://www.4manuals.cc>

<http://www.manual-lib.com>

<http://www.404manual.com>

<http://www.luxmanual.com>

<http://aubethermostatmanual.com>

Golf course search by state

<http://golfingnear.com>

Email search by domain

<http://emailbydomain.com>

Auto manuals search

<http://auto.somanuals.com>

TV manuals search

<http://tv.somanuals.com>