



imagination at work

GE Digital Camera

C1033 / C1233



User Manual

Preparations

Basic operation

Camera function controls

Playback

Using the Menu

Camera connectivity

Appendix

WARNING

Do not expose the camera battery pack or other accessories to rain or humidity to prevent fire hazard or electric shock.

For customers in the U.S.A.

**Tested To Comply With FCC Standards
FOR HOME OR OFFICE USE**

FCC Statement

This device complies with part 15 of the FCC Rules. Operation is subject to the following two conditions:

(1) This device may not cause harmful interference, and (2) this device must accept any interference received, including interference that may cause undesired operation.

For customers in Europe



"CE" mark indicates that this product complies with the European requirements for safety, health, environment and customer protection. "CE" marked cameras are intended for sales in Europe.



This symbol [crossed-out wheeled bin WEEE Annex IV] indicates separate collection of waste electrical and electronic equipment in the European countries. Please do not throw the equipment into the domestic refuse. Please use the return and collection systems available in your country for the disposal of this product.

Declaration of Conformity

Model Name: C1033 / C1233

Trade Name: GE

Responsible Party: General Imaging Co.

Address: 1411 W. 190th Street, Suite 550, Gardena,
CA 90248, U.S.A.

Customer Service Telephone Number:
+1-800-730-6597

(Outside U.S. & Canada: +1-310-755-6857)

Conforms to the following Standards:

EMC: EN 55022:1998/A1:2000/A2:2003 Class B
EN 55024:1998/A1:2001/A2:2003
EN 61000-3-2:2000/A1:2001
EN 61000-3-3:1995/A1:2001

following the provision of the EMC Directive (89/336/
EEC,2004/108/EEC)

SAFETY PRECAUTIONS

Camera notes:

- ❗ Do not store or use the camera in the following types of locations:
 - In the rain, very humid and dusty places.
 - In a place where the camera can be exposed directly to the sunlight or subject to high temperature, e.g. Inside a closed car in summer.
 - In a place where the camera is subject to a high magnetic field, e.g. near motors, transformers or magnets.
- ❗ Do not place the camera on a wet surface or places where dripping water or sand may come in contact with the camera, which may cause irreparable faults.
- ❗ If the camera will not be used for a long period of time, we suggest you remove the battery and the memory card from the camera and keep them in dry environment.
- ❗ If you carry the camera suddenly from a cold location to a warm place, moisture may condense inside the camera. We suggest you wait for a while before turning on the camera.
- ❗ No compensation for loss of recordings. Loss of recordings cannot be compensated for if a malfunction of your camera or recording media, etc, makes the playback of recordings not possible.

Battery notes:

- ❗ Incorrect use of the batteries may cause them to leak, become hot, ignite or burst. Always observe the precautions given below.

- Do not expose the batteries to water, and take particular care to keep the terminals dry.
- Do not heat the batteries or throw them into a fire.
- Do not attempt to deform, disassemble or modify the batteries.

- ❗ Keep the batteries out of reach of babies and small children.
- ❗ In cold locations, battery performance deteriorates and the time for which they can be used shortens markedly.

Memory card notes:

- ❗ When using a new memory card, or a memory card has been initialized by a PC, be sure to format the card with your digital camera before using it.
- ❗ To edit image data, copy the image data to the PC's hard disk first.
- ❗ Do not change or delete the folder names or file names in the memory card from your PC, as this may make it impossible to recognize or misinterpret the original folder or file in your camera.
- ❗ The photos taken by this camera are stored in the auto-generated folder in SD card. Please do not store photos that are not taken by this model of camera, as this may make it impossible to recognize the picture when the camera is in playback mode. Please do not expose the camera to harsh environments such as moisture or extreme temperatures, which may shorten the life of your camera or damage the batteries.

BEFORE YOU START

Preface

Thank you for purchasing this GE digital camera. Please read this manual carefully and keep it in a safe place for future reference.

Copyright

© Copyright 2010 General Imaging Company All rights reserved.

No part of this publication may be reproduced, transmitted, transcribed, stored in a retrieval system, or translated into any language or computer language, in any form, by any means, without the prior written permission of General Imaging Company.

Trademarks

All trademarks mentioned in this manual are used for identification purposes only and are properties of their respective owners.

Safety information

Please read the following important information carefully before using the product.

- Do not take apart or attempt to service the camera yourself.
- Do not drop or knock the camera. Improper handling may damage the product.
- Turn off the camera before inserting or removing the battery and memory card.
- Use only the type of battery that come with the camera. Using other types of batteries may damage the camera and invalidate the warranty.
- Do not touch the camera lens.
- Please not expose the camera to harsh environments such as moisture, or extreme temperatures, which may shorten the life of your camera or damage the batteries.
- Do not use or store the camera in dusty, dirty, or sandy areas, as its components may be damaged.

- Do not expose the lens to direct sunlight for extended periods.
- Download all pictures and remove the batteries from the camera if you are going to store the camera for long periods of time.
- Do not use abrasive cleansers, alcohol-based, or solvent-based cleaners to clean the camera. To clean, wipe the camera with a slightly damp soft cloth.

About this manual

This manual provides you with instructions on how to use your GE digital camera. Every effort has been made to ensure that the contents of this manual are accurate, however General Imaging Company reserves the right to make changes without notice.

Symbols used in this manual

Throughout this manual, the following symbols are used to help you locate information quickly and easily:



Indicates the useful information to know.



Indicates precautions to be taken while operating the camera.

CONTENTS

WARNING	i	Using the Mode Button	13
SAFETY PRECAUTIONS	ii	Setting Date/Time and Language	14
BEFORE YOU START	1	Setting the Date and Time	14
Preface	1	Setting the Language	15
Copyright	1	About the LCD Screen	16
Trademarks	1	BASIC OPERATION	17
Safety information	1	Shooting in Auto Mode	17
About this manual	2	Using the Zoom Function	17
Symbols used in this manual	2	Basic Functions Menu	18
CONTENTS	3	Flash	18
GETTING READY	7	Self-timer/Continuous Capture	19
Unpacking	7	Macro Mode	19
Camera Views	8	Exposure Compensation	19
Inserting the Battery and SD/SDHC Card (Not included)	10	Advanced Functions Menu	20
Turning On and Off	12	WB (White Balance)	21
		ISO	21
		Quality	22

Size	22	Sunset	30
Color	23	Glass	30
USING THE MODES	24	Landscape	30
LCD Screen Display	24	Night Portrait	30
Still Picture Mode Display	24	Stabilization mode	31
Video Shooting Mode Display	26	Face Detection	32
Playback Mode Display	27	PLAYBACK	33
Panorama mode	28	Viewing Photos and Videos	33
Scene mode	29	Thumbnail View	34
Sport	29	Using Zoom on Playback (for still pictures only)	35
Indoor	29	Using the Delete Button	36
Snow	30	USING THE MENUS	37
Fireworks	30	Still Menu	37
Museum	30	AF Mode (Auto-Focus mode)	38
Night Landscape	30	Continuous AF	38
Children	30	Expo Metering (Exposure Metering)	39
Leaf	30		

Continuous Shot	39	Setup Menu	52
Date Imprint	40	Beep	53
Quick Review	41	LCD Brightness	53
Digital Zoom	41	Power Saver	54
Movie Menu	42	Zone	54
Continuous AF	43	Date/Time	55
Expo Metering (Exposure Metering)	43	Language	55
Playback Menu	44	File and Software	55
Protect	44	File Numbering	56
Delete	45	Copy to Card (Copy internal memory to memory card)	56
DPOF (Digital Print Order Format)	46	Reset Settings	57
Trim	47	FW Version (Firmware version)	57
Resize	47	Transmission	58
Rotate	48	Video System	58
Red-eye Reduction	48	Connecting to a PC	59
Display Setup	49	Setting the USB Mode	59
Slideshow	49		
Wallpaper Settings	50		

Transferring Files to your PC	59
Connecting to a PictBridge Compatible Printer	61
Setting the USB Mode	61
Connecting the Camera and Printer	62
Using the PictBridge Menu	63
Print with Date	63
Print without Date	64
Print Index	65
Print DPOF	66
Exit	66
APPENDICES	67
Specifications: C1033 / C1233	67
Error Messages	71
Troubleshooting	73

GETTING READY

Unpacking

Your package should contain the camera model you purchased along with the following items. If anything is missing or appears to be damaged, please contact your vendor.

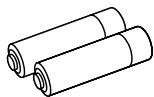

AA-size Alkaline Batteries



Warranty Card

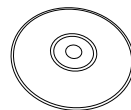

CD-ROM

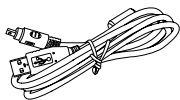

USB Cable



Wrist Strap

Camera Views

Front View

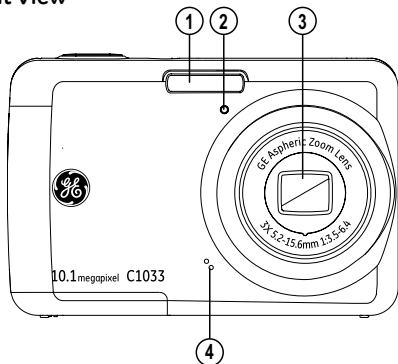

Back View

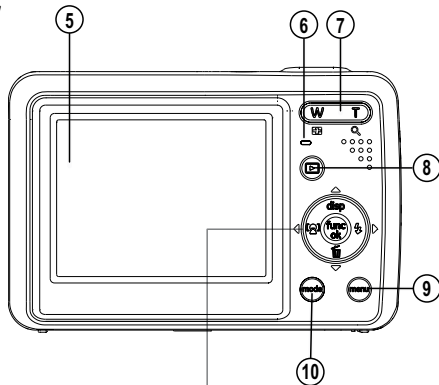

Right View

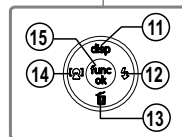
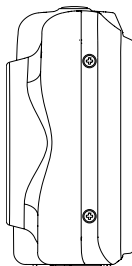

Top View

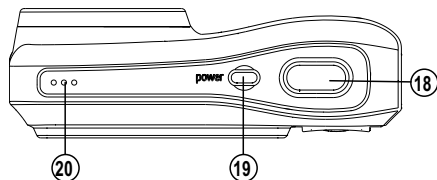

Bottom View

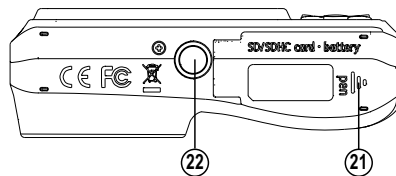

Left View

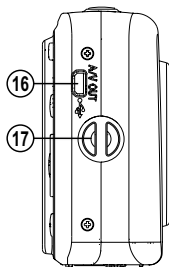

1	Flash Lamp	12	Flash Mode/Right Button
2	Timer Indicator	13	Delete Button/Down Button
3	Lens	14	Face Detection/Left button
4	Microphone	15	Function/OK Button
5	LCD Screen	16	USB/AV Port
6	Status Indicator	17	Wrist Strap
7	Zoom Button	18	Shutter Button
8	Playback Button	19	Power Button
9	Menu Button	20	Speaker
10	Mode Selection Button	21	Card Slot/Battery Compartment
11	Disp/Up Button	22	Tripod Socket

Insert the Battery and SD/SDHC Card (Not included)

1. Open the battery compartment.

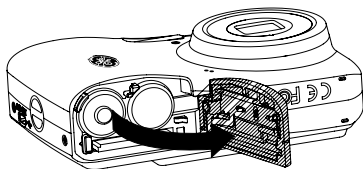
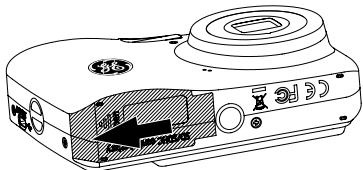

2. Insert the enclosed batteries into the battery slot in the correct direction.

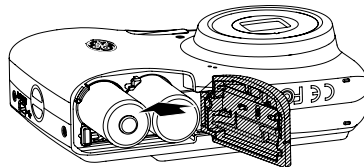

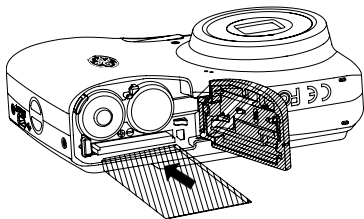

3. Insert an SD/SDHC card (not included) into the memory card slot as shown.

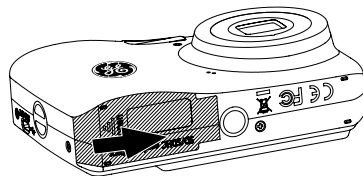
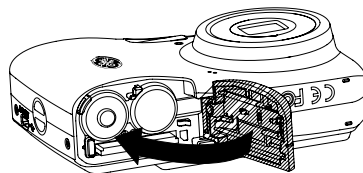

4. Close the battery compartment.



 Optional SD/SDHC cards are not included. The use of 64MB to 16 GB memory cards from recognized manufacturers such as SanDisk, Panasonic and Toshiba is recommended for reliable data storage.

 To remove the SD/SDHC card, open the battery compartment and gently push the card to release it. Pull the card out carefully.

Turning On and Off



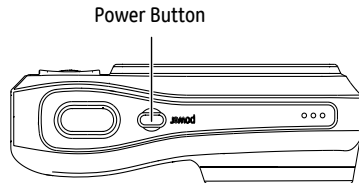

Press the Power button to turn the camera on. To turn off the camera, press the Power button again.



When the camera is turned on, it will be at the same shooting mode based on the last use. You can press the Mode button to select a different one after it is on. When using the camera for the first-time, the language setting page will appear. Please see page 14 or the Quick Start Guide in the package for details.

Using the Mode Button

The GE camera provides a convenient Mode Button that allows you to switch between different modes with ease. Press Left/Right button to choose the mode, press  to select. All the available modes are listed as follows:



Mode Name	Icon	Description
Auto mode		Switch to take still pictures in automatic mode.
Panorama mode		Switch to capture a sequence of shots and stitch them together into a panoramic photo.
Stabilization mode		Switch to take still pictures by reducing the blurs caused by hand shake, under low luminance, or slow shutter speed.
Scene mode	SCN	Switch to take still pictures in 12 different scene types by your choice.
Movie mode		Switch to record videos.
Portrait		Switch to take portrait pictures under normal condition.

Setting Date/Time and Language

To set the language, date, and time, go to the following setup options in the **Setup** menu.

- Date / Time
- Language

To access the **Setup** menu, do the following:

1. Press **Power** to turn the camera on.
2. Press the  button, switch among the setting menus by using the **Left/Right** button to select the corresponding basic setting menu.
3. Press the  button to confirm the setting.

Setting the Date and Time

1. Use the **Up/Down** button to select **Date/Time**. Then press the **Right** button to enter the setting.
2. Press the **Left/Right** to highlight each field and use the **Up/Down** to adjust the value.
3. Press the  button to confirm the setting.



Setting the Language

1. Use the **Up/Down** button to go to the **Language**. Then press the **Right** button to enter the setting.
2. Use the **Left/Right** buttons to select the desired language.
3. Press the  button to confirm the setting.

 The Date/Time and Language setup will automatically appear when the camera is turned on the first time.



About the LCD Screen

When you turn the camera on, various icons are shown on the LCD screen to indicate the current camera settings and status. To learn more about the displayed icons, see “LCD Screen display” on page 24.

LCD Screen notes:

Extremely high-precision technology had been used to manufacture the LCD screen so that most of the pixels are operational for use. However, there may be some minute points (black, white, red, blue or green) that constantly appear on the LCD screen. These points are normal in the manufacturing process and the recording is not affected in any way.



Avoid exposing the LCD screen to water; please remove any moisture on the LCD screen with dry and soft cleaning cloth.



If the LCD monitor is damaged, take particular care with the liquid crystal in the monitor. If any of the following situations arise, take the recommended immediate action indicated below:

- If liquid crystal comes in contact with your skin, wipe the area with a cloth and then wash thoroughly with soap and running water.
- If liquid crystal gets into your eye, flush the affected eye with clean water for at least 15 minutes and then seek medical assistance.
- If liquid crystal is swallowed, flush your mouth thoroughly with water. Drink large quantities of water and induce vomiting. Then seek medical assistance immediately.

BASIC OPERATION

Shooting in Auto Mode

Auto mode is the easiest mode to take photos. While operating in this mode, the camera automatically optimizes your photos for best results.

To start shooting, do the following:

1. Press **Power** to turn the camera on.
2. In the Mode menu, select the Auto mode ().
3. Compose your picture on the LCD screen and press the Shutter button halfway to focus on the subject.
4. The LCD screen will show green focus frame after the subject is in focus.
5. Press **Shutter** fully to capture the image.

Using the Zoom Function

Your camera is equipped with two types of zoom functions: optical zoom and digital zoom. Press the Zoom button of the camera to zoom in or out on the subject while taking pictures.

Zoom button

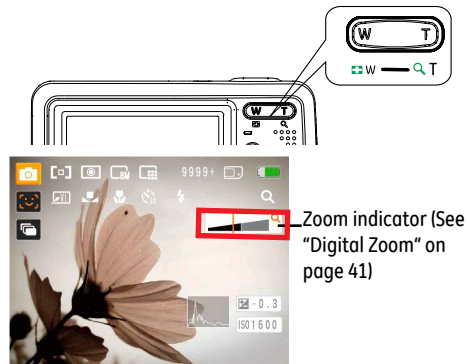

When the optical zoom reaches its maximum value, release the Zoom button then press it again for it to go further at the digital zoom. Zoom indicator is hidden after the Zoom button is released. The screen shows (T Q) for the current zoom status.

Basic Functions Menu

The Basic Function Menus of the camera include Flash, Self-timer, Macro Capture, and Exposure Compensation. The suitable function setting can let you shoot better photos.

Set the basic functions as per the following steps:

1. Pull up the Basic Function Menus by pressing Right/Flash button.

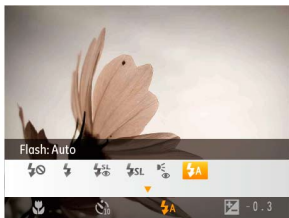

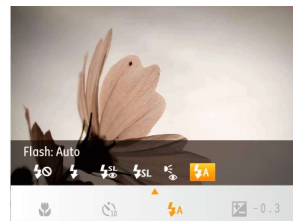

2. Press Left/Right button to select the settings of the required function.
3. Press **func ok** button to confirm the settings and exit the menu, or press Down button to enter the selection screen of Basic Function.







4. Press Left/Right button to select the basic functions required to set, press Up button to enter the setting screen for selecting basic functions, or press **func ok** button to confirm the settings and exit the screen.

Flash



- **⚡** Flash : Auto
Camera flash goes off automatically based on existing light conditions.
- **👁️** Flash : Red-eye reduction
The camera exposes a brief flash before the picture is taken to reduce red-eye effects.
- **⚡** Flash : Forced flash
Flash always goes off.

-  Flash : Forced off
Flash is turned off.
-  Flash : Slow Synchro
This allows you to take pictures of people at night that clearly show both your subjects and the night time backdrop.
-  Flash : Red-Eye + Slow Synchro
Using this mode for slow synchro shots with red-eye reduction.

Self-timer/Continuous Capture

-  Self-time : 2 sec
A single picture is shot 2 seconds after the Shutter button is pressed.
-  Self-time : 10 sec
A single picture is shot 10 seconds after the Shutter button is pressed.
-  Self-time : Continuous Shot
Pictures are shot continuously when the Shutter button is pressed down based on the Continuous Shot settings in the menu. (See "Continuous Shot" on page 39).
-  Self-time : Off
Disable the self-timer.

Macro Mode

-  Macro : On
Select this to focus on subjects 5cm from the lens.
-  Macro : Off
Select this option to disable Macro.

Exposure Compensation

The exposure compensation allows you to adjust the light exposure value and shoot the best photo.

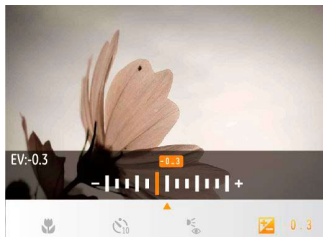

The adjustable range of exposure value is from EV -2.0 to EV+2.0.

Advanced Functions Menu

The Advanced Functions Menu of the camera include Image Size, Image Quality, White Balance, Image Color and ISO etc. The suitable function setting can let you shoot better photos and videos.

Set the advanced functions as per the following steps:

1. Pull up the Advanced Function Menus by pressing  button.

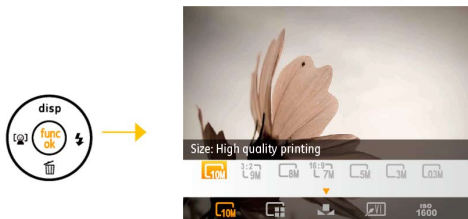

2. Press Left/Right button to select the settings of the required function.
3. Press  button to confirm the settings and exit the menu, or press Down button to enter the selection screen of Advanced Functions.







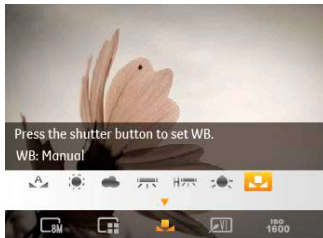

4. Press Left/Right button to select the advanced functions required to set, press Up button to enter the setting screen for selecting advanced functions, or press  button to confirm the settings and exit the screen.

WB (White Balance)

The White Balance allows you to adjust the color temperature under different light source to ensure faithful color reproduction.



The options of White Balance include:

-  WB : Auto
-  WB : Daylight
-  WB : Cloudy
-  WB : Fluorescent
-  WB : Fluorescent CWF
-  WB : Incandescent
-  WB : Manual (Press the shutter button to set WB)

ISO

The ISO function allows you to set the sensitivity of the camera sensor based on the brightness of the scene. To improve the performance in darker environments, a higher ISO value is required. On the other hand, a lower ISO value is needed when in bright conditions.

Pictures at higher ISO will naturally have more noise than those at lower ISO.



The options of ISO include automatic, 80, 100, 200, 400, 800 and 1600.



The available ISO values vary on different camera models.

Quality

The quality setting adjusts the compression ratio of the images. Higher quality settings give better photos, but will take up more memory space.



The picture quality of image has totally three options:

-  Quality : Best
-  Quality : Fine
-  Quality : Normal

Size

The size setting refers to the image resolution in pixels. A higher image resolution allows you to print that image in larger sizes without degrading the image quality.



The bigger the number of recorded pixels is, the better the image quality becomes. As the number of recorded pixels becomes smaller, you will be able to record more frames on a memory card.

Color

The color setting allows you to add artistic effects directly when taking pictures. You can try different color tones to alter the mood of your pictures.



The color options include:

- OFF Color : Auto
- BW Color : Black & White
- SE Color : Sepia
- VII Color : Vivid

USING THE MODES



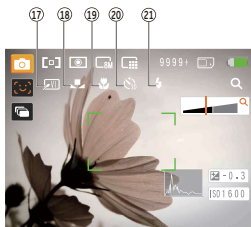
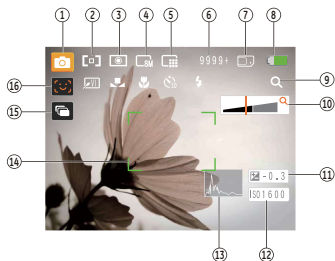

LCD Screen Display

Still Picture Mode Display

Mode:  SCN   



1 Shooting Mode Icons

-  Auto mode
-  Scene mode
-  Stabilization mode
-  Portrait
-  Panorama mode

2 AF Mode

-  Single-AF
-  Multi-AF

3 Expo Metering

-  Spot
-  Center
-  AiAE

4 Image Size

5 Image Quality

- 6 Remaining number of pictures
- 7 Memory card/built-in memory
- 8 Battery Status
- 9 WT Ratio (Displayed only when zoom is activated)
- 10 Zoom
- 11 Exposure
- 12 ISO Value
- 13 Histogram
- 14 Focus Frame
- 15 Continuous Shot
- 16 Face Detection
- 17 Picture Color
- 18 White Balance
- 19 Macro Mode
- 20 Self-timer



Self-time : 2-sec



Self-time : 10-sec

21 Flash Mode



Flash : Auto



Flash : Red-eye reduction



Flash : Forced flash



Flash : Forced off



Flash : Slow Synchro





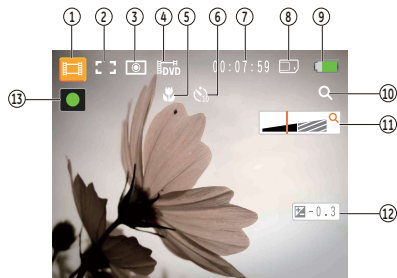

Flash : Red-Eye + Slow Synchro

Video Shooting Mode Display

Mode : 



- 1 Video Mode icon
- 2 Continuous AF
 Single-AF
- 3 Metering
 Spot
 Center
 AiAE

4 Video Quality

5 Focus Frame

6 Self-timer

 Self-time : 2-sec

 Self-time : 10-sec

7 Remaining Time for Video Recording

8 Memory Card/Built-in Memory

9 Battery Status

10 WT Ratio (Displayed only when zoom is activated)

11 Zoom

12 Exposure

13 Recording Status Icon

 Recording standby

 Recording

 For optimal video shooting, it is recommended that the SD card be used. If you shoot videos with the limited built-in memory as a result of short video recording, there may be picture jitter and noise.

 During video shooting, the optical zoom is fixed but the highest 5.7x digital zoom is still available.

Playback mode display

Mode: ▶

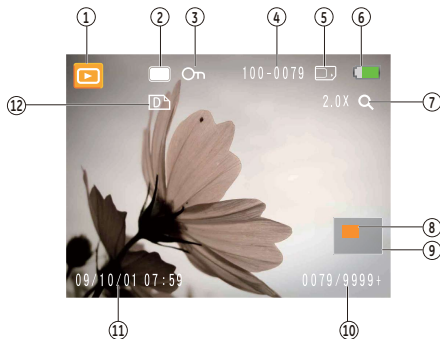

1. Play Mode icon
2. Picture File
3. File protection
4. Picture Number
5. Memory Card/Built-in Memory
6. Battery Status
7. Image Zoom
8. The current display area
9. Affecting regional
10. Memory Space (this picture/Total number of pictures)
11. Recording Date and Time
12. DPOF file

Panorama mode

Panorama Mode allows you to create a panoramic picture. The camera will automatically compose a panoramic picture using the individual shots that you take.

Follow these steps to create a panoramic picture:

1. Turn the mode dial to the Panorama Mode. Then enter the Photo Setup to Select either Auto Stitching or Manual Stitching (Please refer to Page 37 to enter the Still Picture Menu.)
2. Use the **Left/Right** buttons to specify the direction of picture taking, and then in 2 seconds the panoramic sequence will commence automatically.
3. Compose the first view of the panoramic picture on the LCD screen and press the Shutter button to capture.
4. After the first shot is taken, the semi-transparent image of the first shot will appear at the edge of the screen. You can use this image to compose your picture before you press the Shutter button to capture and finish manual stitching.



5. The camera will then stitch the pictures into a panorama automatically.
 6. Press the **OK** button to enter Playback mode and review the panorama result.
- After taking a Panoramic picture press the func/ok button to save and exit or press the Delete button to cancel and exit.
 - Flash Mode, Self-timer, Macro Mode, and Exposure Compensation are disabled on Panorama Mode.
 - Pictures cannot be deleted, nor the zoom adjusted until the series is finalized.
 - Panorama Mode can stitch 2 or 3 maximum pictures.













Scene mode

In **Manual Scene mode**, you can select from a total of 12 scene types to match your needs. You just need to select the right scene for the occasion and the camera will automatically adjust to the optimal settings for you.

Press the  button, select the Scene Mode menu with the Left/Right button, and the LCD screen will show the figure as below.



Select a scene using the Left/Right button and press the  button.

Icon	Mode Name	Icon	Mode Name
	Sport		Indoor
	Snow		Fireworks
	Museum		Night Landscape
	Children		Leaf
	Sunset		Glass
	Landscape		Night Portrait

Sport

For shooting fast-moving objects. Bring lively pictures to life.

Indoor

For shooting people indoors. Clearly show background and atmosphere.

Snow

Suitable for snowy landscape. Camera automatically adjusts and corrects exposure value (EV).

Fireworks

For shooting at night and fireworks. Shutterspeed is slower than normal. (Use of tripod is recommended)

Museum

For shooting in museums or places where flash is not allowed.

Night landscape

For shooting night scenes. Use of tripod is recommended.

Children

Suitable for photographing children and pets. The flash shuts off automatically in order not to disturb the subject being photographed.

Leaf

For shooting plants. Vivid reproduction of green.

Sunset

For shooting sunsets. Vivid reproduction of red and yellow.

Glass

Suitable for photographing objects behind glass or window.



Landscape

For shooting landscapes. Vivid reproduction of green and blue.

Night portrait

For shooting portraits with night scenes as background.





1. After selecting the scene type, press the  button to activate.
2. To select a different scene type, press the  button to enter the main function menu. Then press it again to return to the to Scene selection menu.

The main function menu also allows you to adjust the image quality and image size. Please refer to the "**Advanced Functions Menu**" section on page 20 for detailed instructions.

Stabilization mode

This mode can help reduce photo blur caused by hand shake, low light and slow shutter speed



-  Use stabilization mode in dark environments or when in slow shutter speed
-  Shooting in a windy or unstable environment (such as a moving vehicle) may cause blurred images.

Face Detection

The Face Detection mode will detect and focus on faces of persons during picture shooting so that the faces will be clearer.

1. In Shooting Mode, press the Left/Face Detection button to turn on the Face Detection and an icon () appears on the LCD.
2. Hold the camera securely, and point the camera towards the subject to start the face detection process. When the camera detects a face, a white rectangular frame will be drawn around the face. (Note: For best results, the face of the subject should be relatively large on the LCD screen, and the subject should be facing the camera as front on as possible.)
3. Press **Shutter** halfway to focus on the subject.
4. Press **Shutter** fully to capture the image.
5. Press the Left/Face Detection button to turn off Face Detection.

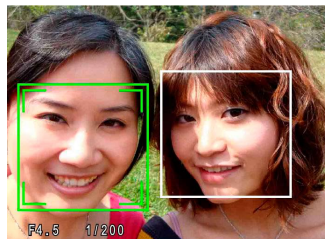
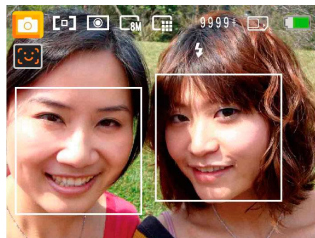

PLAYBACK

Viewing Photos and Videos

To view the captured photos and video clips on the LCD screen:

1. Press **▶** button to go to the **Playback** mode. The last recorded photo or video clip is displayed.
2. Use the **Left/Right** navigation buttons to scroll through the photos or video clips stored in the internal memory or memory card.
3. To play a selected video clip, press the **▶** button to enter the movie playback mode.

During video playback, the operating instructions will appear on the screen. Press the Left/Right button, and press the **▶** button for confirmation.

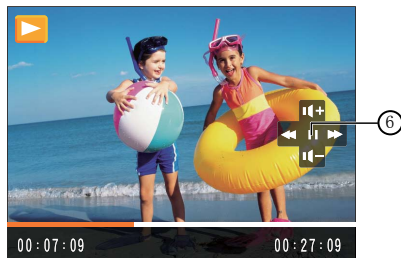
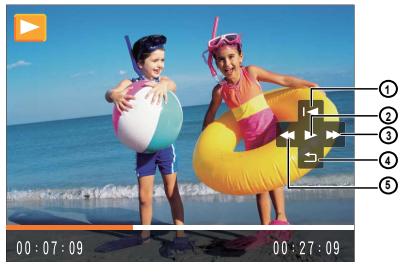

The operating instruction icons are as follows.

- | | | | |
|---|--------------|---|--------|
| 1 | First Frame | 4 | Back |
| 2 | Play | 5 | Rewind |
| 3 | Fast Forward | 6 | Pause |

During video playback, you can press the Up/Down button to adjust the volume.

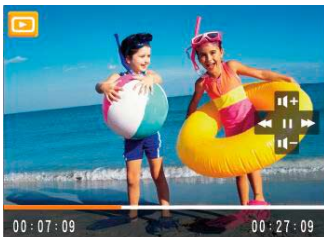

Thumbnail View

When in **Playback** mode, press one end of the Zoom button ( W) to display the thumbnail of photos and videos on the screen.

1. Use the Zoom button to switch between the 2x2, 3x3, and 4x4 thumbnail display.
2. Use **Up/Down/Left/Right** to select a photo or video clip to view.





If the  indicator appears on the LCD, then a movie file is currently being displayed.



Press the  button to restore a preview icon to its original image size.

Using Zoom Playback (for still pictures only)

The zoom buttons can also be used during playback. This allows you to magnify photos up to 2 ~ 8X.

1. Press  button to go to the **Playback** mode.
2. Use the **Left/Right** navigation buttons to select a photo to magnify.
3. Press one end of the Zoom button () to zoom in.
4. Use the Zoom buttons to zoom in and out. The zoom indication and the frame of the whole photo shall display on the screen.



5. Use the navigation buttons to pan across the image.
6. Press the  button to return the image to its original scale.



Movie images cannot be magnified.

Using the Delete Button

In Playback Mode, you can press the Down/Delete button to delete pictures or videos.

To delete pictures or videos:

1. Press  button to go to the Playback Mode.
2. Select a picture or video clip you want to delete with the Left/Right button.
3. Press the Down/Delete button and the delete screen appears.



4. Select Yes or Back with Up/Down button and press the  button for confirmation.



Erased photos/video clips cannot be recovered.



Please refer to page 45 for instructions on the Delete Menu options.

USING THE MENUS

Still Menu

Mode:  SCN 

In any of the above Still Picture Modes, press the  button to go to the Still Picture menu.



To adjust each setting:

1. In the Still Picture menu, switch between different Photo Setup or Camera Setup pages using the Left/Right button, to select the page with the function you want to adjust and press the Down button.



2. Press the Up/Down buttons to select the function.
3. Press the Right button to go to the submenu.



4. Press Up/Down button to select an option or press the Left or  button to return to the menu.
5. Press the  button for confirmation and exit the menu.

 After selecting a function, you can press the Up button to return to the Still Picture menu for other Photo Setup or Camera Setup pages. Or you can press the Down button several times to move to the next setup menu page.

Refer to the following pages for more details about each setting.

AF Mode (Auto-Focus mode)

Use this setting to control the auto-focus mechanism while taking pictures.



Two options are available:

- **Single-AF:** The focus frame appears on the center of the LCD screen to focus on the subject.
- **Multi-AF:** The camera automatically focuses the subject in a wide area to find the focus point.

Continuous AF

After Continuous AF is turned on, the camera will adjust focus automatically in response to any camera or subject movement.

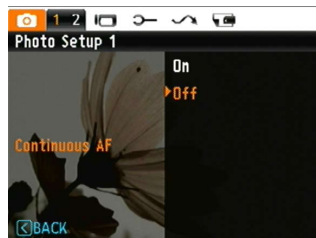

Expo Metering (Exposure Metering)

Use this setting to select an area for the exposure to be obtained.



Three options are available:

- Spot
- Center-Weight
- AiAE (Artificial Intelligence AE)

Continuous Shot

Use this setting to perform continuous shooting. Once in this mode, you must continuously hold down the Shutter button to use this function.



Four options are available:

- **Unlimited:** Press and hold the shutter to shoot continuously until you release the shutter or when the memory card has run out of space.
- **3 shot:** Capture up to 3 consecutive pictures.
- **3 shots (Last):** Capture pictures continuously until the Shutter button is released but only the last 3 shots are recorded.
- **Time-Lapse:** Automatically capture pictures in a pre-defined interval.

 The flash is designed not to work in this mode in order to enable quick succession of shots.

 Continuous Shot can only be selected in Self-timer Mode.

Date Imprint

Include a Date/Time stamp in the photo image.

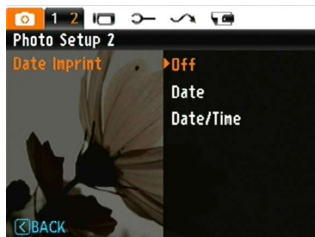

- Off
- Date
- Date / Time

Quick Review

This setting refers to the quick photo review immediately after taking a picture. The picture stays on the LCD screen for an adjustable period of time.



Digital Zoom

Use this setting to enable or disable the digital zoom function. When disabled, only the optical zoom is enabled.

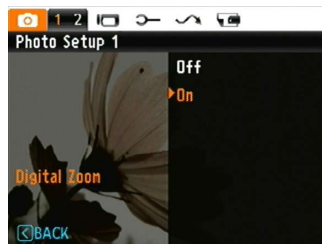

Four options are available:

- Off
- 1 sec
- 2 sec
- 3 sec

Movie Menu

Mode: 

In the Movie Mode, press the  button to go to the corresponding Movie menu.



To configure each setting:

1. In the Movie menu, switch between the Movie Setup or different Camera Setup pages using the Left/Right button, select the page with the function you want to adjust and press the Down button.



2. Press the Up/Down button to select the function and press the Right button to go to the submenu.



3. Press the Up/Down button to select an option or the Left or  button to return to the menu.
4. Press the  button for confirmation and exit the menu.

Refer to the following pages for more details about each setting.

Continuous AF

After Continuous AF is turned on, the camera will adjust focus automatically in response to any camera or subject movement.



Expo Metering (Exposure Metering)

Set metering mode for various lighting conditions.



Three options are available:

- Spot
- Center
- AiAE (Artificial Intelligence AE)

Playback Menu

Mode : 

In Playback mode, press the  button to enter the **Playback** menu.



Please refer to the following sections for detailed instructions on the various menu options.



Protect

To prevent any pictures or videos from being accidentally erased, use this setting to lock one or all of the files.



To protect/unprotect a picture or video:

1. Press  button and find the picture or video you want to protect by using Left/Right button. Once it is displayed on the screen, go to the Playback menu, select Protect settings and press the Up/Down button to make your selection.
2. Press the Up/Down button to select the protection setting option and press the Right button to go to the submenu.



3. Use the **Up/Down** navigation buttons to select **One** to protect this picture/video, or select **All** to protect all pictures/videos in the internal memory or memory card. Then press the **Right** navigation button to enter the submenu.
4. Press the  button to select **Yes** to lock. For locked picture/video, use **Unlock** option to unlock it.
5. A key () icon will appear on the top of the screen to indicate that the picture/video is protected.
6. Select **Reset** on the Protection setting to cancel protection for all files that have been placed in the protected mode.

Delete

There are two ways to delete files.



• Delete One:

1. In the Delete Option, select **One** and then press  button.
2. Using the **Left/Right** buttons, locate the photo or movie file to be deleted. Select **Yes** (to delete file) or **No** (to return to the previous menu) using the **Up/Down** buttons, then press the  button to confirm.

- **Delete All:**

1. In the Delete option, select All and then press  button.
2. Using the **Up/Down** buttons, select **Yes** (to delete all files) or **No** (to cancel and return to the previous menu).



The “” indicator means a file is protected. File protection must be removed first before a file can be deleted.



Deleting files will cause DPOF settings to be reset.

DPOF (Digital Print Order Format)

DPOF allows you to record your selection of pictures that you would like to print, and will save your selection in the memory card, so that you can simply hand your memory card to a photo kiosk without having to tell them in person which photos you would like to print.



Trim

The Trim setting allows you select an area of the photo you want to keep and then save it as a new photo.

To trim a picture:

1. Select the **Trim** setting from the  menu.
2. Using the **Left/Right** buttons, locate the photo that you want to crop and have it displayed on the LCD.
3. Use the zoom buttons and navigation buttons to adjust the trimming box to fit the location and size of the new picture.



4. Press the **Shutter** button to save what you see on the LCD screen as a new picture, or the  button to cancel and return to the **Playback** menu.



The image can not be clipped again when it is clipped to 640X480.

Resize

This setting allows you to resize a picture to a specified resolution, and saves it as a new picture.

1. Select the **Resize** setting from the **Playback** menu as described previously.



2. Use the **Left/Right** navigation buttons to select a picture to resize.
3. Use the **Up/Down** navigation buttons to select a resolution (**1024X768** or **640X480**) to resize the image or **Back** to cancel and return to the **Playback** menu.
4. Press the  button to confirm the setting.



Resizing an image creates a new file that contains the image in the size you select. The file with the original image also remains in memory.





If the message “The image cannot be edited.” appears, it means that the current image cannot be resized.

Rotate

You can use this setting to change the picture orientation of the picture.

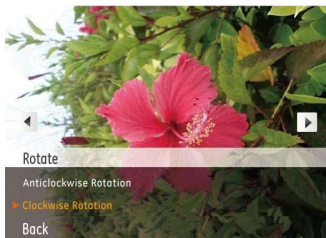
1. Select the **Rotate** setting from the **Playback** menu as described previously.
2. Use the **Left/Right** navigation buttons to select a picture to rotate.
3. Use the **Up/Down** navigation buttons to select the direction for rotation or **Back** to cancel and return to the **Playback** menu.



4. Press the  button to confirm the setting.

Red-eye Reduction

Use this setting to remove red-eyes in your photos.

1. Select the **Red-eye Reduction** in **Playback** menu as described previously.
2. Use the **Left/Right** button to select the picture from which the red-eye needs to be removed.
3. Use the **Up/Down** navigation buttons to select **Yes** to fix the selected image or **Back** to cancel and return to the **Playback** menu.





4. Press the  button to confirm the setting.



For best results, the face of the subject should be relatively large on the LCD screen, the subject should be facing the camera as front on as possible, and the red eyes should be as large as possible.

Display Setup

Mode: 

Press  button in Playback mode to enter Display Setup menu.



Refer to the following sections for details of every setting.

Slideshow

This setting allows you to view all the stored pictures as a slideshow.

1. Select the slideshow menu, press the right button to enter the options menu.
2. Use the **Up/Down** navigation buttons to select Effect, Interval time, or Repeat and use the **Left / Right** navigation buttons to adjust the setting.



3. Use the **Up/Down** navigation buttons to select **Start** to run the slideshow or **Cancel** to return to the **Playback** menu.
4. Press the  button to confirm the setting.

Wallpaper Settings

Use this setting to select your favorite picture to use as a background on the LCD screen.



1. Press Down button to select the Wallpaper Setting menu.

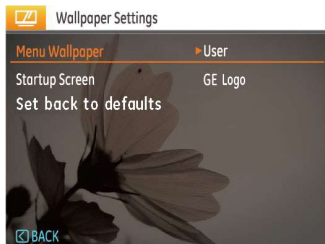

2. Press Right button, and the camera will enter the Wallpaper Setting interface.





Menu Wallpaper:

Use Up/Down button to select the Menu Wallpaper option, press  button to confirm or press Left button to return to last page, and press  to exit the menu.



- User
- Nature
- Sparkling

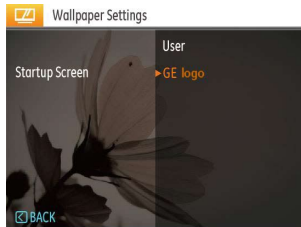

Startup Screen:

Use Up/Down button to select the Startup Screen option, press  to confirm or press Left button to return to last page, and press  to exit the menu.



- User
- GE logo

Set back to defaults:

Use Up/Down button to select Set back to defaults, press  to confirm or press Left button to return to last page, and press  to exit the menu.

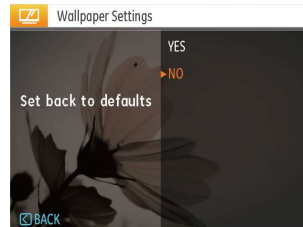

- Yes
- No

Setup Menu

Mode :  SCN     

The Setup menu for the camera is available in all modes. Each menu page can be selected by pressing the  button and switching between menus with the Left/Right button.



To adjust the settings:

1. Select the menu page with the function you want to adjust and press the Down button.

2. Switch between different functions with the Up/Down button.
3. Press the **Right** button to enter the submenu.



After selecting a function option, you can press the Up button to return to the menu for other Camera Setup pages. Or you can press the Down button to switch to the next menu page.

Refer to the following pages for more details about each setting.

Beep

Use this setting to adjust the volume of beep when buttons are pressed and change the tones for Shutter button, self-timer, and power-on/power-off.

To change this setting:

1. Select the **Beep** setting from the **Setup** menu as described previously.
2. Use the **Up/Down** navigation buttons to switch between volume, shutter tone, key tone, self-timer tone, and power tone fields.



3. Press the Right button, press the Up/Down button to adjust volume and change tone, and press the  button to confirm setting.

LCD Brightness

Use this setting to adjust the brightness of your LCD screen.

1. Select the **LCD Brightness** setting from the **Setup** menu as described previously.
2. Select auto or adjust the brightness level using the Left/Right button, and press the  button to confirm the setting.

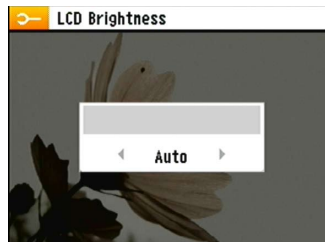

Power Saver

This setting allows you to save power and get the maximum possible running time for your battery. Follow the steps below to turn off the LCD screen and camera automatically after a period of inactivity.

1. Select the **Power Save** setting from the **Setup** menu as described previously.
2. Press the Up/Down button to select the power items for the screen and camera and press the Right button.





3. Press the Up/Down button to adjust the selected item. Both items have the following options:

- Turn off the LCD:
30 sec, 1 min, 2 min, and off.
 - Turn off the camera:
3 min, 5 min, 10 min, and off.
4. Press the  button to confirm.

Zone

The Zone setting is a useful function on your overseas trips. This feature enables you to display the local time on the LCD screen while you are overseas.

1. Select the **Zone** setting from the **Setup** menu as described previously. The world time screen appears.
2. Use the **Up/Down** navigation buttons to switch between the hometown () and travel destination () fields.
3. Use the **Left/Right** navigation buttons to select a city close to the desired time zone. Then press the  button to confirm.



Date/Time

See "Setting the Date and Time" section on page 14.

Language

See "Setting the Language" section on page 15.

File and Software

Format Memory

Please note: formatting enables you to delete all contents in the memory card and built-in memory, including protected photo and movie files.

To use this setting:

1. Select the Format in File and Software menu.
2. Use the Up/Down navigation buttons to select Yes or No. Then press the  button to confirm.



3. The current media is formatted.

File Numbering

After you take a picture or video clip, the camera will save it as file that ends with a serial number. You can use this item to choose whether the file is serially numbered or begins with 1 and is saved in another folder on the memory card.

1. Select the File Name in File and Software menu.
2. Select the option with the Up/Down button and press the  button for confirmation.

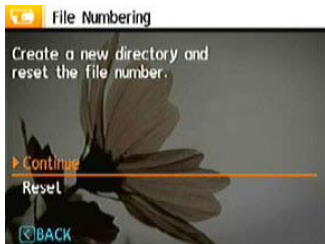

Copy to Card (Copy internal memory to memory card)

Use this setting to copy the files stored in the internal memory to the memory card.

1. Select the Copy to memory card in File and Software menu.
2. Use the Up/Down navigation buttons to select Yes or No. Then press the  button to confirm.



Reset Settings

Use this setting to restore the camera to its default settings.

1. Select the **Reset** setting in File and Software menu.
2. Use the **Up/Down** navigation buttons to select **Yes** or **No**. Then press the  button to confirm.



FW Version (Firmware Version)

Use this setting to view the current camera firmware version.

1. Select the **FW Version** in File and Software menu.
2. If SD card contains a new version of firmware, please upgrade accordingly as necessary.



 To update to the latest firmware version, you can go to the following website: www.ge.com/digitalcameras and look under Support.

Transmission

Video System

Use this setting to determine your video system in the current area.

1. Select the **Video System** in **Connection Setup** menu.
2. Use the **Up/Down** navigation buttons to select **NTSC** or **PAL**. Then press the  button to confirm.



The video output signal can be switched to NTSC or PAL to accommodate different regional standards. The appropriate setting will vary between regions.

NTSC: USA, Canada, Taiwan, Japan, etc.

PAL: Europe, Asia (excluding Taiwan), Oceania, etc.

Note: The TV output will not display properly if an incorrect video system is selected.

Connecting to a PC

Use the USB cable and ArcSoft software (CD-ROM) supplied with your camera to copy (transfer) pictures to a computer.

Setting the USB mode

Since the camera's USB port can be set to connect with either a PC or a Printer, the following steps will allow you to ensure that the camera is correctly configured to connect with a PC.

1. Go to the camera setting menu, select USB connection with the Up/Down button, and press the Right button.
2. Use the **Up/Down** navigation buttons to select **PC**.
3. Press the  button to confirm the setting.



Transferring files to your PC

The computer will automatically detect the camera as a removable drive. Double-click **My Computer** icon on the desktop to locate the removable drive and to copy the folders and files in the drive to a directory on your PC as you would copy any typical folder or file.

By using the USB cable, you can transfer the captured photos and videos to a PC. Follow the steps below to connect the camera to a PC.

1. Start a computer to which ArcSoft software has been installed.
2. Make sure both the camera and PC are turned on.
3. Connect one end of the supplied USB cable to the USB/AV OUT port on your camera.
4. Connect the other end of the cable to an available USB port on your PC.

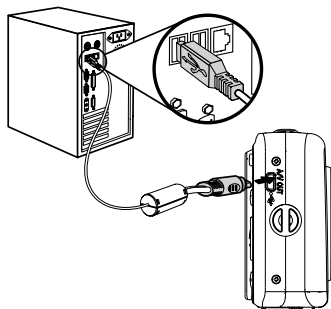

5. Disconnect the camera once transfer is completed.

If the USB option is set to [PC] :

Turn the camera off and disconnect the USB cable.

If the USB option is set to [PC (PTP)] :

Remove the camera from the system as described below before turning the camera off and disconnecting the USB cable.

Windows operating system (Windows 2000, Windows XP, Windows Vista, Windows 7.)

Click the [Safely remove the hardware] icon and remove the USB connector according to the appeared menu.

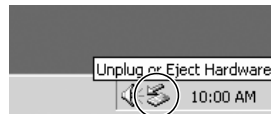

Macintosh

Drag the untitled icon to the Trash. ("Untitled")



Connecting to a PictBridge Compatible Printer



PictBridge allows printing images from a memory card in a digital camera directly to a printer, regardless of brand. To find out if a printer is PictBridge compatible, simply look for the PictBridge logo on the packaging or check

the manual for specifications. With the PictBridge function on your camera, you can print the captured photos directly with a PictBridge compatible printer using the supplied USB cable, without the need for a PC.

Setting the USB mode

Since the camera's USB port can be set to connect with either a PC or a Printer, the following steps will allow you to ensure that the camera is correctly configured to connect with a Printer.

1. Go to the camera setting menu, select USB connection with the Up/Down button, and press the Right button.
2. Use Up/Down to select Printer.

3. Press the  button to confirm the setting.



-  After the camera is reset, it will switch to PC mode automatically from USB mode.

Connecting the camera and printer.

1. Make sure both the camera and printer are turned on.
2. Connect one end of the supplied USB cable to the USB port on your camera.
3. Connect the other end of the cable to the USB port on the printer.

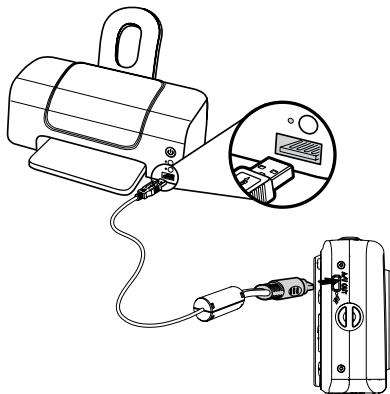

If the camera is not connected to a PictBridge compatible printer, the following error message appears on the LCD screen.

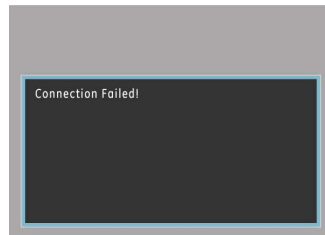

-  The above error message would also appear if the USB mode were set incorrectly, in which case you should disconnect the USB cable, check the USB mode settings, ensure that the Printer is turned on, and then try connecting the USB cable again.

Using the PictBridge Menu

After setting the USB mode to Printer, the **PictBridge** menu appears.



Select a menu item with the Up/Down button and press the Right button or  button to enter the item.

Refer to the following sections for more detailed information on each setting.

Print with date

If you have set the date and time of your camera, the date and time will be recorded and saved with each photo you take.

1. Select **Print with date** from the **PictBridge** menu. The following screen appears.

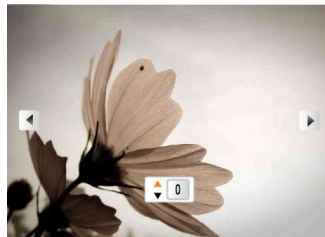

2. Use the **Left/Right** navigation buttons to scroll through the photos.

- Use the **Up/Down** navigation buttons to select the number of prints for the current displayed photo.
- Press the  button and the following screen appears.





- Select **Yes** to confirm the printing, or **Cancel**. Then press the  button.

Print without date

Use this setting to print the photos without dates on them.

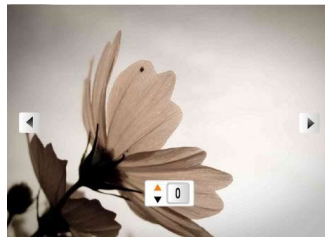
- Select **Print without date** from the **PictBridge** menu. The following screen appears.



- Use the **Left/Right** navigation buttons to scroll through the images.
- Use the **Up/Down** navigation buttons to select the number of prints for the current displayed image.
- Press the  button and the following screen appears.



5. Select **Yes** to confirm the printing, or **Cancel**. Then press the  button.

2. Select **Yes** to confirm the printing, or **Cancel**. Then press the  button.

Print index

You can use this setting to print all indexes to show all the photos currently in your camera.

1. Select **Print index** from the **PictBridge** menu. The following screen appears.

Print DPOF (Digital Print Order Format)

To use DPOF printing, you must make the selection of photos for printing using the DPOF settings before hand. See "DPOF" section on page 46.

1. Select **Print DPOF** from the **PictBridge** menu. The following screen appears.



2. Select **Yes** to confirm the printing, or **Cancel**. Then press the  button.

Exit

To exit the **PictBridge** menu, select **Exit**. The "Remove USB cable" message will be displayed.

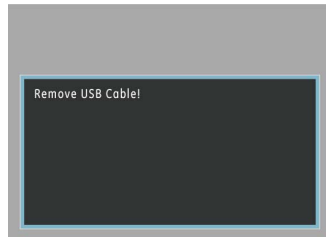

Disconnect the USB cable from the camera and printer.

APPENDICES

Specifications : C1033 / C1233



Design and specifications are subject to change without notice.

Model name		C1033	C1233
Effective Image Sensor Pixels		10.1 Megapixels	12.1 Megapixels
Image Sensor		10.3 Megapixels [1/2.5" (CCD)]	12.2 Megapixels [1/2.3" (CCD)]
Lens	Focal Length F =	5.2mm (Wide) ~ 15.6mm (Tele)	
	35mm film equivalent	31.2mm (Wide) ~ 93.6mm (Tele)	28.8mm (Wide) ~ 86.4mm (Tele)
	F number	F3.5 (Wide) ~ F6.4 (Tele)	
	Construction	7 elements in 7 groups	
	Optical Zoom	3X	
	Focusing Range	Normal: (Wide) 30cm ~ ∞, (Tele) 80cm ~ ∞; Macro: (Wide) 5cm ~ 60cm	
Anti-Handshake		Electronic Image Stabilization	
Digital Zoom		5.7X digital zoom (Combined Zoom: 17.1X)	

Model name		C1033	C1233
Number of Recording Pixels	Still Image	10MP, 9MP(3:2), 8MP, 7MP(16:9), 5MP, 3MP, 0.3MP	12MP, 10MP(3:2), 9MP(16:9), 10MP, 8MP, 5MP, 3MP, 0.3MP
	Movie	640x480pixels: 30fps/15fps, 320x240pixels: 30fps/15fps	
Image Compression		Best, Fine, Normal	
DCF, DPOF (Ver1.1) Support		Yes	
File Format	Still Image	Exif 2.2 (JPEG)	
	Movie	Quick Time Motion JPEG, Audio: G.711 [Monaural]]	
Shooting Modes		Auto, Scene (Sport, Indoor, Snow, Fireworks, Museum, Night Landscape, Children, Leaf, Sunset, Glass, Landscape, Night Portrait), Stabilization, Portrait, Panorama, Video	
Face-Detection		Yes	
Red-eye Removal		Yes	

Model name	C1033	C1233
Pan-Capture Panorama	Yes	
LCD Display	2.4 inch (112,320 pixels) LTPS (low-temperature polycrystalline silicon) TFT color LCD	
ISO Sensitivity	Auto, ISO80/100/200/400/800/1600	
AF Method	Single AF, Multi-AF (TTL 9-point), Face-Detection	
Light Metering Method	Artificial Intelligence AE (AiAE), Center-weighted Average, Spot (Fixed to center of frame)	
Exposure Control Method	ProgramAE (AE-lock available)	
Exposure Compensation	±2 EV in 1/3 Step increments	
Shutter Speed	4 ~ 1/2000 second	
Continuous Shooting	Approx. 2.05 fps (Large/Fine mode)	Approx. 1.28 fps (Large/Fine mode)
Playback Modes	Single Photo, Index (4/9/16 thumbnails), Slide Show, Movie (Slow-Motion possible), Zoom (Approx. 2X~8X), Audio, Histogram Display	
White Balance Control	Auto (AWB), Daylight, Cloudy, Fluorescent , Fluorescent CWF, Incandescent, Manual	

Model name	C1033	C1233
Internal Flash (Shooting Range)	Auto/Red-Eye Reduction/Forced Flash/No Flash/Slow Synchro/Red-Eye Reduction+Slow Synchro	
	Shooting Range Wide: Approx. 0.3m~2.3m / Tele: Approx. 0.3m ~ 1.9m (ISO 400)	
Recording Media	Internal Memory: 5MB	Internal Memory: 7.57MB
	SD Card/SDHC Card (Up to 16GB support)	SD Card/SDHC Card (Up to 32GB support)
Other Features	PictBridge, ExifPrint Support, Multi-language Support	
Jacks	USB2.0/AV-OUT (Integrated Proprietary Connector)	
Power	2 x AA Alkaline Battery, AA NiMH Battery [Not Included]	
Shooting Capability (Battery Performance)	AA Alkaline Batteries: Approx. 130 shots (based on CIPA standards)	
	AA NiMH Battery : Approx. 380 shots (CIPA Standards)	
Operation Environment	Temperature: 0~40°C, Humidity: 0~90%	
Dimensions (W x H x D)	91.5mm x 60.2mm x 30.2 mm	
Mass	Approx. 118g (Body only)	Approx. 120g (Body only)

Error messages

Messages	Explanation
No card	<ul style="list-style-type: none">• The memory card is not inserted.
Card error	<ul style="list-style-type: none">• The memory card is not formatted.
Card full	<ul style="list-style-type: none">• The memory card is full and cannot store any new images.
Write protect	<ul style="list-style-type: none">• The memory card is write-protected.
Picture error	<ul style="list-style-type: none">• The picture is not captured correctly.• The picture is damaged.
No picture	<ul style="list-style-type: none">• There are no images in the memory card or in the internal memory.
Lens error	<ul style="list-style-type: none">• The lens is probably stuck and the camera will power off automatically.
System error	<ul style="list-style-type: none">• Unexpected error encountered.
Image cannot be saved	<ul style="list-style-type: none">• The write protection switch in the memory card is set to the "LOCK" position.
Out of the range	<ul style="list-style-type: none">• When pictures were taken in Panorama mode, the direction of movement was incorrect or the angle was outside the range of the internal settings.
The maximum specified water depth was exceeded	<ul style="list-style-type: none">• During underwater recording or shooting, the camera was taken deeper than the maximum allowable depth.

Messages	Explanation
When the camera is used for longer than the specified time it may be damaged.	<ul style="list-style-type: none"> • During underwater recording or shooting, the camera was kept under water longer than the specified time.
Card is not formatted, format?	<ul style="list-style-type: none"> • Confirm whether the memory card should be formatted.
This image cannot be deleted	<ul style="list-style-type: none"> • The picture or video you are trying to delete is protected.
Cannot record movie	<ul style="list-style-type: none"> • The write protection switch in the memory card is set to the "LOCK" position.
Warning!! Camera recording, please wait.	<ul style="list-style-type: none"> • No other actions allowed to perform during video/audio recording.
Warning!! Battery exhausted.	<ul style="list-style-type: none"> • The battery is out of charge.
This file cannot be played back	<ul style="list-style-type: none"> • The picture format cannot be recognized by the camera.
No connection	<ul style="list-style-type: none"> • The camera is not connected to the printer correctly.
Print error	<ul style="list-style-type: none"> • There is a problem with camera or printer.
Cannot print	<ul style="list-style-type: none"> • Check that the printer is out of paper or out of ink. • Check if the printer has a paper jam.

Troubleshooting

Problem	Possible causes	Solution
Camera does not turn on.	<ul style="list-style-type: none">• The battery has run out.• The battery is not inserted correctly.	<ul style="list-style-type: none">• Replace with a fully charged battery.
Camera turns off suddenly during operation.	<ul style="list-style-type: none">• The battery has run out.	<ul style="list-style-type: none">• Replace with a fully charged battery.
The picture is blurred.	<ul style="list-style-type: none">• The lens is dirty.•  appears when taking pictures.	<ul style="list-style-type: none">• Use a soft cloth to clean the lens on your camera• Use the Image Stabilization mode.
Images and video files cannot be saved.	<ul style="list-style-type: none">• The memory card is full.	<ul style="list-style-type: none">• Replace the memory card with a new one.• Delete unwanted images.• Unlock the memory card.

Problem	Possible causes	Solution
No picture is taken when pressing the Shutter button.	<ul style="list-style-type: none"> • The memory card is full. • No available space to store the files. • The mode dial is in Playback mode. 	<ul style="list-style-type: none"> • Replace the memory card with a new one or clean off current memory card. • Delete unwanted images. • The memory card is locked.
Images cannot print from the connected printer.	<ul style="list-style-type: none"> • The camera is not connected to the printer correctly. • The printer is not PictBridge compatible. • The printer is out of paper or out of ink. • The paper is jammed. 	<ul style="list-style-type: none"> • Check the connection between the camera and printer. • Use a PictBridge compatible printer. • Load some paper in the printer. • Replace the ink cartridge in the printer. • Remove the jammed paper.

<http://www.ge.com/digitalcameras>



Free Manuals Download Website

<http://myh66.com>

<http://usermanuals.us>

<http://www.somanuals.com>

<http://www.4manuals.cc>

<http://www.manual-lib.com>

<http://www.404manual.com>

<http://www.luxmanual.com>

<http://aubethermostatmanual.com>

Golf course search by state

<http://golfingnear.com>

Email search by domain

<http://emailbydomain.com>

Auto manuals search

<http://auto.somanuals.com>

TV manuals search

<http://tv.somanuals.com>