

AZ61H09EAC

GE Zoneline® Deluxe Series Heat Pump Unit

Dimensions and Installation Information (in inches)

Electrical Wiring

All wiring, including installation of receptacle, must be made in accordance with local electrical codes and regulations.

Note: Aluminum wiring may pose special problems – consult a qualified electrician.

Grille Options

Stamped Aluminum Grille – RAG60

Exterior Architectural Louvers Durable Polycarbonate:

RAG61 (Beige)

RAG63 (Bittersweet)

RAG62 (Maple)

RAG67 (Extruded Aluminum)

Retrofit Kits:

RAK901L – Wall Case Insulation for use with heat pumps.

RAK40 – Deflector Kit to adapt chassis for use with existing exterior architectural louvered grilles.

Ducted Applications

4100 and 6100 series can be used with ductwork to heat or cool more than one room. RAK6052 Duct Adaptor is applied to top of case over air discharge/RAK601 Duct Extension is applied to right or left of adaptor. Locally fabricated ductwork may be added to extend to maximum recommended distance of 15 feet.

Electrical Connection

230/208 volt units may be plugged into a receptacle. 265 volt units are provided with a junction box and require direct connection. (NEC Requires 265V Direct Connection) See Architects and Engineers Design Data Manual for electrical connection information including use of sub-base for direct connected units. Installation must comply with local electrical codes and regulations.

Power Connection kits required on all Zoneline chassis.

For answers to your Monogram®, GE Profile™ or GE® appliance questions, visit our website at ge.com or call GE Answer Center® service, 800.626.2000.



Wall Case Dimensions

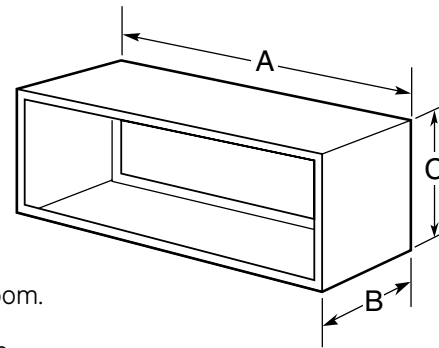

Maximum Cord Extension

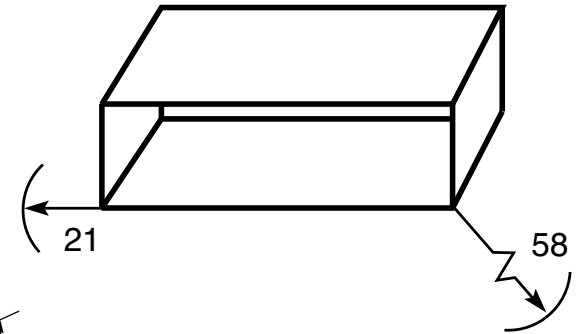

RAB71 Wall Sleeve

Heavy-gauge galvanized steel, with insulation.
A – 42"; B – 13-3/4"; C – 16"

RAB77 Wall Sleeve

Molded SMC fiberglass-reinforced polyester compound.
A – 42-1/8"; B – 13-7/8"; C – 16-1/4"

Wall Opening Dimensions

Add 1/4" to A and C dimensions for all cut-out size.
RAB71 16-1/4" Min. H x 42-1/4" Min. W
RAB71 available in 16", 24", 28" and 31" depths
RAB77 16-1/2" Min. H x 42-3/8" Min. W

265 Volt Sub-Base Connected Units				
Sub-Base	Power Connection Kit	Electric Heater Watts	Electric Heat Amps	Min. Circuit Protection (Amps)
RAK204E15	RAK5172	2,550	10.3	15
RAK204E20	RAK5202	3,450	13.7	20
RAK204E30	RAK5302	5,000	19.6	30

Specification Created 12/09

390513

AZ61H09EAC

GE Zoneline® Deluxe Series Heat Pump Unit

Features and Benefits

- R-410A Refrigerant
- 9,400 BTUH Cooling Capacity
- 12.7 E.E.R.
- 8,300 BTUH (Reverse Cycle Heat)
- Electronic Touch Controls with LED Display
- 2.7 Dehumidification (pts/hr)
- 3.8 Cop
- 360/211 CFM Indoor Fan (High/Low)
- 70/45 Vent CFM
- Electronic 7-Step Temperature Limiting To Prevent Overcooling or Overheating of Room
- Heat Sentinel
- Reverse Cycle Heating
- 29 Sound Transmission Class (STC)
- Corrosion Treated
- Warm Grey Beige

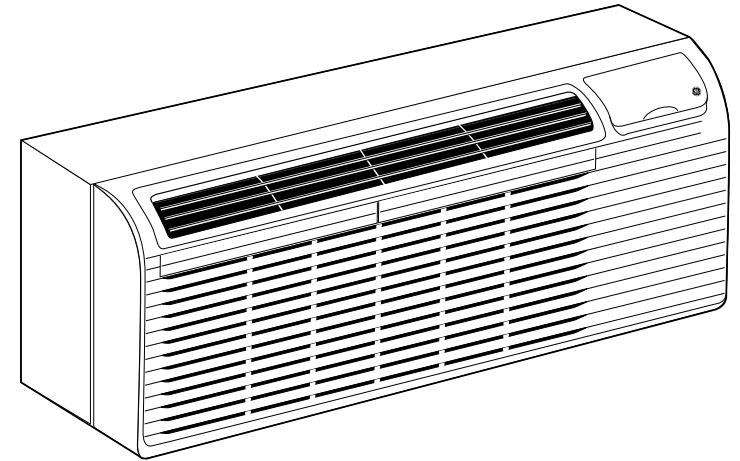

For answers to your Monogram®, GE Profile™ or GE® appliance questions, visit our website at ge.com or call GE Answer Center® service, 800.626.2000.



imagination at work

Free Manuals Download Website

<http://myh66.com>

<http://usermanuals.us>

<http://www.somanuals.com>

<http://www.4manuals.cc>

<http://www.manual-lib.com>

<http://www.404manual.com>

<http://www.luxmanual.com>

<http://aubethermostatmanual.com>

Golf course search by state

<http://golfingnear.com>

Email search by domain

<http://emailbydomain.com>

Auto manuals search

<http://auto.somanuals.com>

TV manuals search

<http://tv.somanuals.com>