

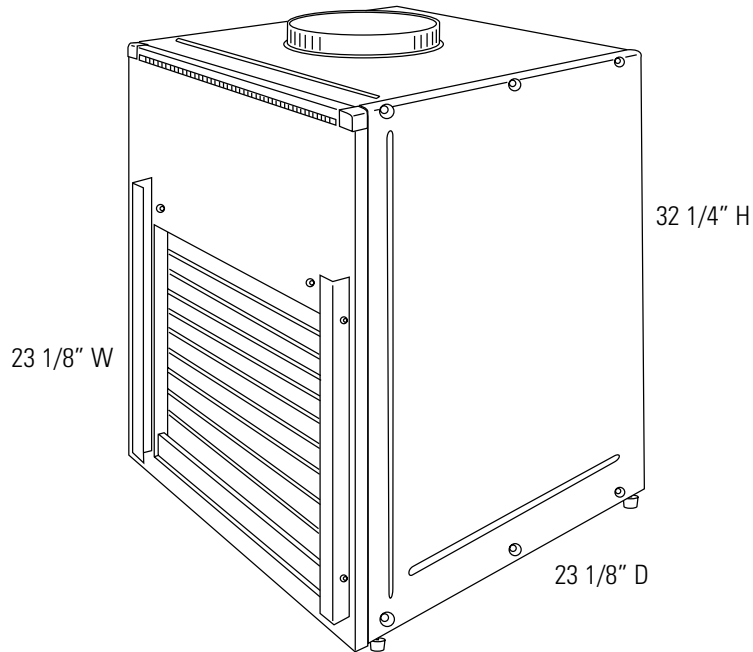

GE Appliances

AZ75H09DAC – GE Vertical Packaged Terminal Heat Pump

Overall Unit Dimensions



230/208 Volt	Line Cord Connected Units		
Power Connection Kit	RAK3152	RAK3202	RAK3302
Heater KW	2.55/2.09	3.45/2.82	5.00/4.09
Min. Circuit Amps	15	20	30
Recommended Protective Device	15 Amp Time Delay Fuse or Breaker	20 Amp Time Delay Fuse or Breaker	30 Amp Time Delay Fuse or Breaker

Specification Created 8/02

Minimum Clearances:

Front

- Allow 4 inches in front of unit. When determining closet depth, note that plenum may protrude into closet up to 4 inches, depending on wall depth.

Sides

- Allow 3 inches on each side of unit.
- For side access closets only: Allow 5 inches on the side where access is required.

Platform

- An 8"-12" high, field-supplied platform is recommended for drain access.

ZONELINE® WARRANTY

WHAT IS COVERED

FULL ONE-YEAR WARRANTY

For one year from date of original purchase, we will provide, free of charge, parts and service labor on site to repair or replace **any part of the Zoneline** that fails because of a manufacturing defect.

ADDITIONAL FOUR-YEAR WARRANTY

For an additional four years from the date of original purchase, we will provide, free of charge, parts and on-site service labor to repair or replace **any part of the sealed refrigerating system** (the compressor, condenser, evaporator and all connecting tubing) that fails because of a manufacturing defect.

*SEE WRITTEN WARRANTY FOR DETAILS

LIMITED 2ND THROUGH 5TH YEAR PARTS WARRANTY

For the second through the fifth year from date of original purchase, General Electric will provide, free of charge, parts that fail as a result of a manufacturing defect. Parts covered are fan motors, switches, heater, heater protectors, compressor overload, solenoids, circuit boards, auxiliary controls, thermistors, frost controls, capacitors and varistors. This is a limited parts-only warranty, and does not include labor or transportation to and from the service shop.

All warranty service will be provided by our Factory Service Centers or by our authorized Customer Care® servicers during normal working hours.

For answers to your Monogram®, GE Profile™ or GE appliance questions, visit our website at GEAppliances.com or call GE Answer Center® service, 800.626.2000.



GE Appliances

AZ75H09DAC – GE Vertical Packaged Terminal Heat Pump

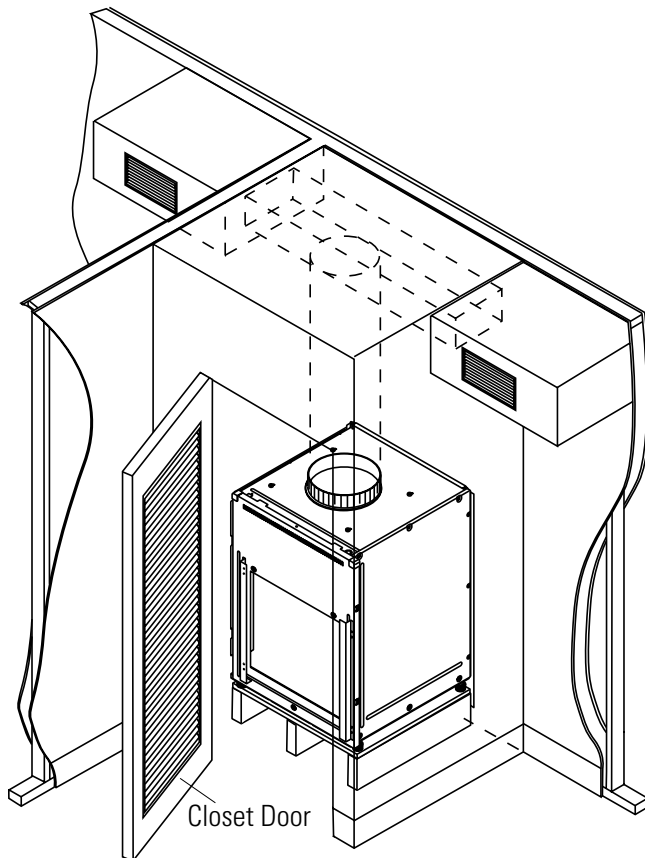

Features and Benefits

- 9,500/9,300 BTUH Cooling Capacity
- 8,400/8,200 BTUH Heating Capacity
- 10.5/10.5 E.E.R. (BTUH/Watt)
- Vertical Design Optimizes Floor Space – Unique Sleeve Design Makes Easier to Install
- Freeze Sentinel™ Protects Unoccupied Rooms Against Freeze-Up
- Three-Way, Slide-Out Chassis with Specially Designed Case Makes Maintenance and Service Quick and Easy
- Full Corrosion Treatment on Outside Coils and Other Components is Standard

Specification Created 8/02

Free Manuals Download Website

<http://myh66.com>

<http://usermanuals.us>

<http://www.somanuals.com>

<http://www.4manuals.cc>

<http://www.manual-lib.com>

<http://www.404manual.com>

<http://www.luxmanual.com>

<http://aubethermostatmanual.com>

Golf course search by state

<http://golfingnear.com>

Email search by domain

<http://emailbydomain.com>

Auto manuals search

<http://auto.somanuals.com>

TV manuals search

<http://tv.somanuals.com>