

Owner's Manual

Double-Door, Double-Drawer,
Stainless Steel, Free-Standing
Refrigerators

225D1804P011
49-60617

04-10 GE
monogram.com



Introduction

Your new Monogram refrigerator makes an eloquent statement of style, convenience and kitchen planning flexibility. Whether you chose it for its purity of design, practical storage arrangements or assiduous attention to detail—or for all of these reasons—you'll find that your Monogram refrigerator's superior blend of form and function will delight you for years to come.

The information on the following pages will help you operate and maintain your refrigerator properly.

If you have any other questions, visit our Website at: **monogram.com**

Contents

Consumer Services

Important Phone Numbers27

Model and Serial Numbers 3

Performance Data Sheet25

Problem Solver20–24

Product Registration 3

Safety Instructions 4–7

State of California

Water Treatment Device Certificate26

WarrantyBack Cover

Care and Cleaning

Cleaning—Outside and Inside18

Light Bulb Replacement 19

Moving18

Vacation18

Operating Instructions

Automatic Icemaker17

Additional Features15

Crispers16

Internal Water Dispenser10

Other Controls 9

Performance Air Flow System 8

Shelves and Bins12–14

Temperature Controls 8

TurboCool™ 9

Water Filter11

Before using your refrigerator

Read this manual carefully. It is intended to help you operate and maintain your new refrigerator properly.

Keep it handy for answers to your questions.

If you don't understand something or need more help, there is a list of toll-free consumer service numbers included in the back section of this manual.

OR

Visit our Website at: **monogram.com**

*Write
down
the model
& serial
numbers*

You'll see them on a label inside the fresh food compartment at the top on the right side.

Please write these numbers on the Consumer Product Ownership Registration Card included with the packing material.

Before sending in this card, please also write these numbers here:

Model Number

Serial Number

Use these numbers in any correspondence or service calls concerning your refrigerator.

*If you
received a
damaged
refrigerator*

Immediately contact the dealer (or builder) that sold you the refrigerator.

*Save time
& money*

Before you request service, check the Problem Solver in the back of this manual.

It lists causes of minor operating problems that you can correct yourself.

*If you
need
service*

To obtain service, see the Consumer Services page in the back of this manual.

We're proud of our service and want you to be pleased. If for some reason you are not happy with the service you receive, here are steps to follow for further help.

For customers in the USA:

FIRST, contact the people who serviced your appliance. Explain why you are not pleased. In most cases, this will solve the problem.

NEXT, if you are still not pleased, write all the details—including your phone number—to:

Manager, Customer Relations
GE Appliances
Appliance Park
Louisville, KY 40225

For customers in Canada:

FIRST, contact the people who serviced your appliance. Explain why you are not pleased. In most cases, this will solve the problem.

NEXT, if you are still not pleased, write all the details—including your phone number to:

Manager, Consumer Relations
Mabe Canada Inc.
1 Factory Lane, Suite 310
Moncton, N.B. E1C 9M3

IMPORTANT SAFETY INSTRUCTIONS

READ AND SAVE THESE INSTRUCTIONS

⚠ WARNING: *When using this appliance, always exercise basic safety precautions, including the following:*

- **Use this appliance only for its intended purpose** as described in this Owner's Manual.
- **This refrigerator must be properly installed in accordance with the Installation Instructions before it is used.**
- **Do not allow children to climb, stand or hang on the shelves in the refrigerator.** They could damage the refrigerator and seriously injure themselves.
- **Do not touch the cold surfaces in the freezer compartment when hands are damp or wet.** Skin may adhere to these extremely cold surfaces.
- **Do not store or use gasoline or other flammable vapors and liquids in the vicinity of this or any other appliance.**
- **In refrigerators with automatic icemakers,** avoid contact with moving parts of the ejector mechanism, or with the heating element located on the bottom of the icemaker. Do not place fingers or hands on the automatic icemaking mechanism while the refrigerator is plugged in.
- **Keep fingers out of the "pinch point" areas:** clearances between the doors and between the doors and cabinet are necessarily small. Be careful closing doors when children are in the area.
- **Unplug your refrigerator before cleaning and making repairs.** **NOTE:** We strongly recommend that any servicing be performed by a qualified individual.
- **Before replacing a burned-out light bulb,** the refrigerator should be unplugged in order to avoid contact with a live wire filament. (A burned-out light bulb may break when being replaced.)
NOTE: Turning control to OFF does not remove power to the light circuit.
- **Do not refreeze frozen foods which have thawed completely.**

⚠ DANGER: RISK OF CHILD ENTRAPMENT



Child entrapment and suffocation are not problems of the past. Junked or abandoned refrigerators are still dangerous...even if they will sit for "just a few days." If you are getting rid of your old refrigerator, please follow the instructions below to help prevent accidents.

Before you throw away your old refrigerator or freezer:

- Take off the doors.
- Leave the shelves in place so that children may not easily climb inside.

REFRIGERANTS

All refrigeration products contain refrigerants, which under federal law must be removed prior to product disposal.

If you are getting rid of an old refrigeration product, check with the company handling the disposal about what to do.

LIRE ET CONSERVER CES INSTRUCTIONS

⚠ AVERTISSEMENT : Lorsque vous utilisez le réfrigérateur, observez toujours certaines précautions de base, notamment :

- **N'utilisez le réfrigérateur que pour son usage prévu**, comme décrit dans le présent manuel.
- **Installez le réfrigérateur conformément aux directives d'installation avant de l'utiliser.**
- **Ne laissez pas les enfants grimper, s'asseoir, se tenir debout ni se pendre aux clayettes du réfrigérateur.** Ils pourraient endommager le réfrigérateur et se blesser gravement.
- **Une fois le réfrigérateur en marche, ne touchez pas les surfaces froides du congélateur, surtout si vous avez les mains humides ou mouillées :** la peau risque d'adhérer à ces surfaces très froides.
- **N'entreposez et n'utilisez pas d'essence ou autres vapeurs et liquides inflammables à proximité de cet appareil ou de tout autre appareil électroménager.**
- **Pour les réfrigérateurs dotés d'une machine à glaçons automatique**, évitez le contact avec les pièces mobiles du mécanisme éjecteur, ou avec l'élément chauffant situé à la partie inférieure de la machine à glaçons. Ne posez pas les doigts ou les mains sur le mécanisme de la machine à glaçons pendant que le réfrigérateur est branché.

- **Éloignez les doigts des parties du réfrigérateur où l'on peut facilement se pincer :** les espaces entre les portes et entre les portes et les placards sont toujours étroits. Soyez prudent lorsque vous fermez les portes de l'appareil en présence des enfants.
- **Débranchez votre réfrigérateur avant de le nettoyer et de le réparer.** **REMARQUE :** Nous vous recommandons vivement de confier toute réparation à un technicien qualifié.
- **Avant de remplacer une ampoule grillée**, le réfrigérateur doit être débranché afin d'éviter tout contact avec un fil sous tension. (Une ampoule grillée peut se briser pendant l'opération).
REMARQUE : Lorsque vous placez la commande sur éteint, l'alimentation électrique de l'ampoule n'est pas coupée.
- **Ne faites pas recongeler des aliments surgelés qui ont complètement dégelé.**

⚠ DANGER: RISQUES POUR LES ENFANTS

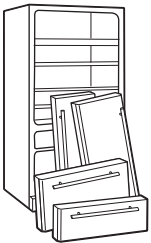

Les enfants pris au piège ou morts d'asphyxie sont toujours d'actualité. Les appareils de réfrigération abandonnés sont toujours aussi dangereux, même si on n'attend que "quelque jours" pour s'en débarrasser. Si vous ne gardez pas votre ancien appareil, veuillez suivre les directives ci-dessous afin de prévenir les accidents.

Avant de vous débarrasser de votre vieux appareil de réfrigération :

- Démontez les portes.
- Laissez les clayettes en place afin d'empêcher les enfants de grimper à l'intérieur.

REFRIGERANTS

Tous les appareils de réfrigération contiennent des réfrigérants qui, conformément aux lois fédérales, doivent être enlevés avant toute élimination de l'appareil.

Si vous vous débarrassez de vieux appareils de réfrigération, vérifiez, auprès de la société qui s'occupe de leur élimination, ce que vous devez faire.

IMPORTANT SAFETY INSTRUCTIONS

HOW TO CONNECT ELECTRICITY

Do not, under any circumstances, cut or remove the third (ground) prong from the power cord. For personal safety, this appliance must be properly grounded.

The power cord of this appliance is equipped with a 3-prong (grounding) plug which mates with a standard 3-prong (grounding) wall outlet to minimize the possibility of electric shock hazard from this appliance.

Have the wall outlet and circuit checked by a qualified electrician to make sure the outlet is properly grounded.

Where a standard 2-prong wall outlet is encountered, it is your personal responsibility and obligation to have it replaced with a properly grounded 3-prong wall outlet.

The refrigerator should always be plugged into its own individual electrical outlet which has a voltage rating that matches the rating plate.

This provides the best performance and also prevents overloading house wiring circuits which could cause a fire hazard from overheated wires.

Never unplug your refrigerator by pulling on the power cord. Always grip plug firmly and pull straight out from the outlet.

Repair or replace immediately all power cords that have become frayed or otherwise damaged. Do not use a cord that shows cracks or abrasion damage along its length or at either end.

When moving the refrigerator away from the wall, be careful not to roll over or damage the power cord.

USE OF EXTENSION CORDS

Because of potential safety hazards under certain conditions, we strongly recommend against the use of an extension cord.

However, if you must use an extension cord, it is absolutely necessary that it be a UL-listed, 3-wire grounding type appliance extension cord having a grounding type plug and outlet and that the electrical rating of the cord be 15 amperes (minimum) and 120 volts.

SAVE THESE INSTRUCTIONS

RACCORDEMENT ÉLECTRIQUE

Ne coupez ni retirez en aucun cas la troisième broche (mise à la terre) de la fiche du cordon d'alimentation. Pour votre sécurité, cet appareil doit être correctement mis à la terre.

Le cordon d'alimentation de cet appareil est muni d'une fiche à 3 broches (mise à la terre) qui se branche dans une prise mural ordinaire à 3 alvéoles (mise à la terre) pour réduire au minimum les risques du chocs électriques.

Faites examiner la prise de courant et le circuit par un électricien qualifié pour vous assurer que la prise est correctement mise à la terre.

Si la prise murale est du type standard à 2 alvéoles, il vous incombe de la faire remplacer par une prise à 3 alvéoles correctement mise à la terre.

La machine à glaçons doit toujours être branché dans sa propre prise de courant, dont la tension nominale est identique à celle indiquée sur la plaque signalétique.

Cette précaution est recommandée pour garantir un rendement optimum et éviter une surcharge des circuits électriques de la résidence, ce qui pourrait créer un risque d'incendie par surschauffe des fils.

Ne débranchez jamais l'appareil en tirant le cordon d'alimentation. Saisissez fermement la fiche du cordon et tirez droit pour la retirer de la prise.

Réparez ou remplacez immédiatement tout cordon effiloché ou endommagé. N'utilisez pas un cordon fendillé ou présentant des signes d'usure.

Lorsque vous déplacez l'appareil du mur, faites attention de ne pas la faire rouler sur le cordon d'alimentation afin de ne pas l'endommager.

CORDONS PROLONGATEURS

Nous vous recommandons fortement de ne pas utiliser de cordons prolongateurs à cause des risques potentiels qu'ils présentent dans certaines conditions.

Toutefois si vous décidez d'utiliser tout de même un cordon prolongateur, il est absolument nécessaire

qu'il s'agisse d'un cordon à 3 fils avec mise à la terre pour appareils électroménagers homologué UL aux États-Unis) ou homologué CSA (au Canada), pourvu d'une fiche et d'une prise mises à la terre de 15 ampères (minimum) et de 120 volts.

CONSERVEZ CES DIRECTIVES

Temperature controls

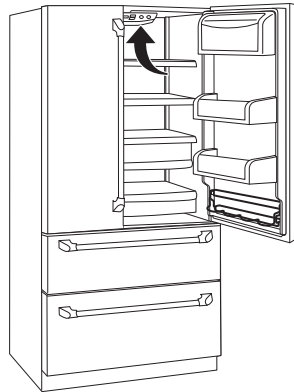
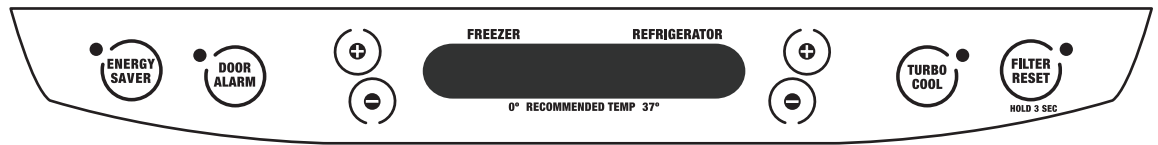

The temperature controls are preset in the factory at **37°F** for the fresh food compartment and **0°F** for the freezer compartment. Allow 24 hours for the temperature to stabilize to the preset recommended settings.

The temperature controls can display both the **SET** temperature as well as the actual temperature in the fresh food and freezer compartments. The actual temperature may vary slightly from the **SET** temperature based on usage and operating environment.

Setting either or both controls to **OFF** stops cooling in both the freezer and fresh food compartments but does not shut off electrical power to the refrigerator.

NOTE: The refrigerator is shipped with protective film covering the temperature controls. If this film was not removed during installation, remove it now.

To change the temperature, press and release the (warmer) or (colder) pad. The SET light will come on and the display will show the set temperature. To change the temperature, tap either the (warmer) or (colder) pad until the desired temperature is displayed. Fresh food temperatures can be adjusted between 34°F and 44°F and the freezer temperatures can be adjusted between -6°F and +6°F.

Once the desired temperature has been set, the temperature display will return to the actual fresh food and freezer temperatures after 5 seconds. Several adjustments may be required. Each time you adjust controls, allow 24 hours for the refrigerator to reach the temperature you have set.

To turn the cooling system off, tap the (warmer) pad for either the fresh food compartment or the freezer until the display shows OFF. **To turn the unit back on,** press the (colder) pad for either the fresh food compartment or freezer. The SET light will illuminate on the side you selected. Then press the (colder) pad again (on the side where the SET light is illuminated) and it will go to the preset points of 0°F for the freezer and 37°F for the fresh food compartment.

Performance Air Flow System

The Performance Air-Flow System is designed to maximize temperature control in the fresh food and freezer compartments. This unique special feature consists of the Air Tower along the top and back walls of the fresh food compartment and the Air Tunnel on the bottom portion of the freezer rear wall. Placing food in front of the louvers on these components will not affect performance.

Although the Air Tower and the Air Tunnel can be removed, doing so will affect temperature performance. (For removal instructions, on-line, 24 hours a day, contact us at GEAppliances.com or call 800.444.1845. In Canada, call us at 1.800.561.3344.)

How TurboCool™ works



TurboCool rapidly cools the refrigerator compartment in order to more quickly cool foods. Use **TurboCool** when adding a large amount of food to the refrigerator compartment, putting away foods after they have been sitting out at room temperature or when putting away warm leftovers. It can also be used if the refrigerator has been without power for an extended period.

Once activated, the compressor will turn on immediately and the fans will cycle on and off at high speed as needed for 8 hours. The compressor will continue to run until the refrigerator compartment cools to approximately 34°F (1°C), then it will cycle on and off to maintain this setting. After 8 hours, or if **TURBOCOOL** is pressed again, the refrigerator compartment will return to the original setting.

How to use TurboCool

- 1 Press **TURBOCOOL**. The refrigerator temperature display will show TC.
- 2 After **TurboCool** is complete, the refrigerator compartment will return to the original setting.

NOTES:

- The refrigerator temperature cannot be changed during **TurboCool**.
- The freezer temperature is not affected during **TurboCool**.
- When opening the refrigerator door during **TurboCool**, the fans will continue to run if they have cycled on.

Door Alarm



The door alarm will sound if either door is open for more than 2 minutes. The beeping sound will stop when you close the door.

Internal Water Dispenser

The water dispenser is located on the left wall inside the refrigerator compartment.

To dispense water:

- 1 Hold the glass against the recess.
- 2 Push the water dispenser button.
- 3 Hold the glass underneath the dispenser for 2–3 seconds after releasing the dispenser button. Water may continue to dispense after the button is released.

If no water is dispensed when the refrigerator is first installed, there may be air in the water line system. Press the dispenser button and run 1½ gallons to remove trapped air from the water line and to fill the water system. During this process, the dispenser noise may be loud as the air is purged from the water line system. To flush out impurities in the water line, throw away the first 6 glassfuls of water.

NOTE: *To avoid water deposits, the dispenser should be cleaned periodically by wiping with a clean cloth or sponge.*

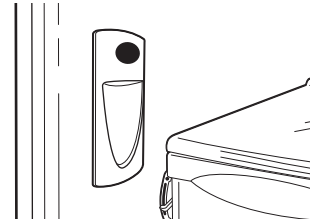

Water filter

Water Filter Cartridge

The water filter cartridge is located in the back upper right corner of the refrigerator compartment.



When to Replace the Filter

There is a replacement indicator light for the water filter cartridge on the temperature display. This light will turn orange to tell you that you need to replace the filter soon. The filter cartridge should be replaced when the replacement indicator light turns red or if the flow of water to the dispenser or icemaker decreases.

On models with external dispensers, the top of the LCD screen will display, "Replace Water Filter."

Installing the Filter Cartridge

- 1 If you are replacing the cartridge, first remove the old one by slowly turning it to the left. DO NOT pull down on the cartridge. A small amount of water may drip down.



⚠ CAUTION: If air has been trapped in the system, the filter cartridge may be ejected as it is removed. Use caution when removing.

- 2 Remove the protective foil from the end of the cartridge.
- 3 Fill the replacement cartridge with water from the tap to allow for better flow from the dispenser immediately after installation.

- 4 Lining up the arrow on the cartridge and the cartridge holder, slowly rotate the cartridge clockwise until it stops. When the cartridge is properly installed, you will feel it "click" as it locks into place.



Do not overtighten.

- 5 Run 1½ gallons from the dispenser to clear the system and prevent sputtering. See *To Use the Dispenser* section.

- 6 Press and hold the **RESET WATER FILTER** pad for 3 seconds.



NOTE: A newly-installed water filter cartridge may **cause water to spurt** from the dispenser.

Filter Bypass Plug

You must use the filter bypass plug when a replacement filter cartridge is not available. The icemaker will not operate without the filter or filter bypass plug.

Replacement Filters:

To order additional filter cartridges in the United States, visit our Website, GEAppliances.com, or call GE Parts and Accessories, 800.626.2002.

Filter Model MWF

Customers in Canada should consult the yellow pages for the nearest Mabe Service Center.

Rearranging the shelves

Shelves in the refrigerator compartment are adjustable.

Refrigerator Compartment

To remove:

- 1 Remove all items from the shelf.
- 2 Tilt the shelf up at the front.
- 3 Lift the shelf up at the back and bring the shelf out.

To replace:

- 1 While tilting the shelf up, insert the top hook at the back of the shelf in a slot on the track.
- 2 Lower the front of the shelf until the bottom of the shelf locks into place.

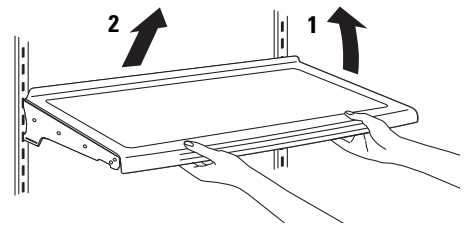

Some models have wire shelves that can be adjusted in the same manner.

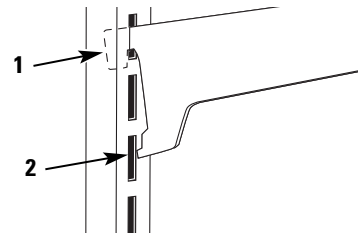

Slide-out spillproof shelf

The slide-out spillproof shelf allows you to reach items stored behind others. The special edges are designed to help prevent spills from dripping to lower shelves.

To remove:

- 1 Remove all items from shelf.
- 2 Slide the shelf out until it stops.
- 3 Lift the front edge of the shelf until the central tabs are above the front bar.
- 4 Continue pulling the shelf forward until it can be removed.

To replace:

- 1 Place the rear shelf tabs just in front of the central notches on the shelf frame.
- 2 Slide the shelf in until the central tabs are slightly behind the front bar.

- 3 Lower the shelf into place until it is horizontal and slide the shelf in.

Make sure that the shelf sits flat after reinstallation and doesn't move freely from side to side.

Make sure you push the shelves all the way in before you close the door.

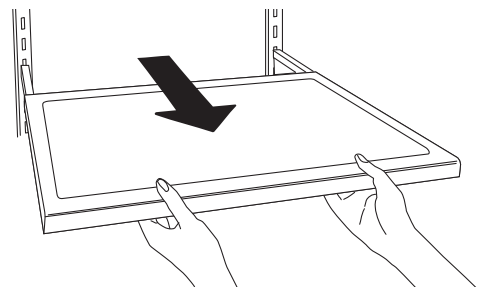

QuickSpace™ shelf

This shelf splits in half and slides under itself for storage of tall items on the shelf below.

This shelf can be removed and replaced or relocated just like Slide-Out Spillproof Shelves.

On some models, this shelf can not be used in the lowest position.

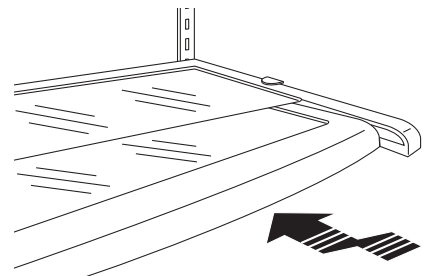

Basket removal (top drawer)

To Remove the Full-Width Basket on Top Freezer Drawer Models:

- 1 Open the top freezer drawer until it stops.
- 2 The freezer basket rests on the inside tabs on the drawer slides.
- 3 Lift the front end of the basket so that the front two alignment tabs come out of the metal slide bracket first. Then rotate the front edge of the basket up while lifting the remaining two rear alignment tabs out of the metal slide bracket.
- 4 Make sure the plastic sleeves remain attached to the 4 slots on the metal slide brackets.

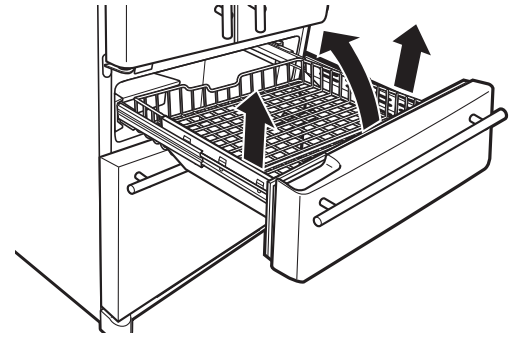

Appearance may vary

When Replacing the Full-Width Basket:

Tilt the basket back and lower it down into the drawer. Rotate the basket to a horizontal position and press it down into the 4 alignment tabs.

NOTE: Always be sure that all 4 basket slots are engaged in the metal slide brackets before sliding back into the freezer.

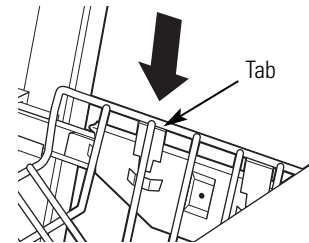

Adjustable divider in bottom freezer basket

The freezer basket has a divider that can be both repositioned or removed.

To Remove the Divider in the Bottom Freezer Basket:

Pull the divider forward until the rear locating tabs are out of the slots. Turn the divider slightly to the side to release the front locating tabs and lift out.

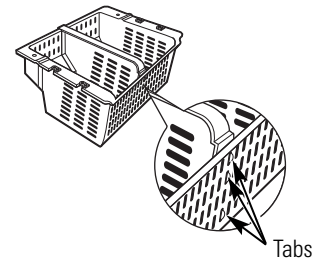

To Replace the Divider in the Bottom Freezer Basket:

Turn the divider slightly to one side so the tabs on the front fit into the vent slots on the basket. Position the divider so the back locating tabs snap into place in the back vent slots.

To Reposition the Divider in the Bottom Freezer Basket:

- 1 Remove the divider as instructed above.
- 2 Slide the divider left or right to the desired location and replace as instructed above.

Basket removal (bottom drawer)

To Remove the 2-Piece Basket:

- 1 Open the bottom freezer drawer until it stops.
- 2 Pull the divider forward until the rear locating tabs are out of the slots. Turn the divider slightly to the side to release the front locating tabs and lift out.
- 3 The freezer basket rests on the metal slide brackets and is held in place with swing locks.
- 4 Turn the swing locks from horizontal to vertical position.
- 5 Lift the front of the basket up, rotate it toward you, and bring it straight up to remove.
- 6 Lift the back portion of the basket up and out of the drawer.

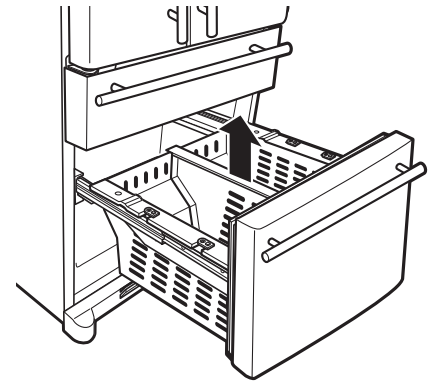

When Replacing the 2-Piece Basket:

- 1 Place the rear of the basket onto the metal slide brackets. There will be 2 pins on each underside of the back that will align for securing the basket.
- 2 Seat the front of the basket onto the metal slide brackets and over the swing locks.
- 3 Turn the swing locks from vertical to horizontal position to lock the basket in place.
- 4 Turn the divider slightly to one side so the tabs on the front fit into the vent slots on the basket. Position the divider so the back locating tabs snap into place in the back vent slots.

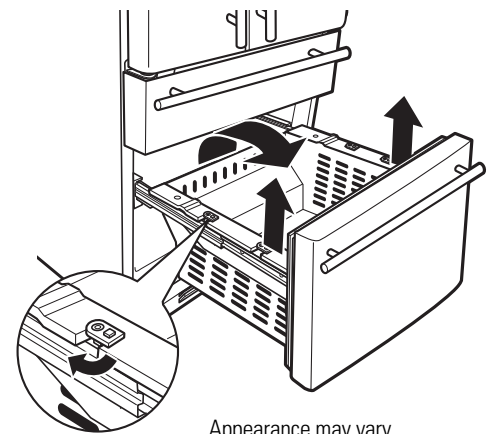

Appearance may vary

Adjustable bins on the door

Adjustable bins can easily be carried from refrigerator to work area.

To remove: Lift bin straight up, then pull out.

To replace or relocate: Slide in the bin just above the molded door supports, and push down. The bin will lock in place.

The snigger helps prevent tipping, spilling or sliding of small items stored on the door shelf.

Grip the finger hold near the rear of the snigger and move it to fit your needs.

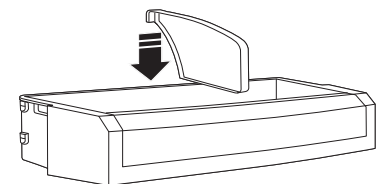

Non- Adjustable bins on the door

To remove: Lift the bin straight up, then pull out.

To replace: Engage the bin in the molded supports on the door and push down. It will lock in place.

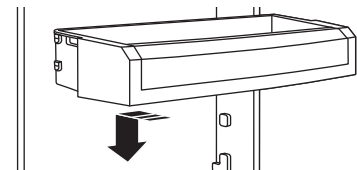

Non- Adjustable beverage rack

To remove: Lift the rack straight up, then pull out.

To replace: Engage the rack in the molded supports on the door and push down. It will lock in place.

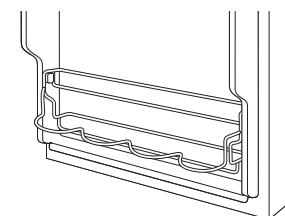

Door swing clearances

The doors are factory set for a 150° door swing. To avoid contact damage to the refrigerator doors or to adjacent cabinetry or walls, observe the minimum clearances shown.

- Allow 4" clearance on each side to an adjacent wall for a 90° opening and access to drawers.
- Allow 15" clearance on each side to an adjacent wall for removal of drawers.

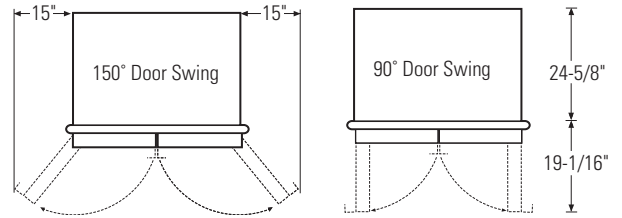

Door alignment

If the top of the doors are uneven, first try to raise the lowest door by turning the leveling leg on the same side as the door until the doors are even. If the unit rocks, re-adjust the leveling legs to the extent that the unit is stable.

If the doors remain uneven, turn the adjustable pin to raise, or lower, the left door to match the right door. Use a 1/4 Allen wrench to turn the pin.

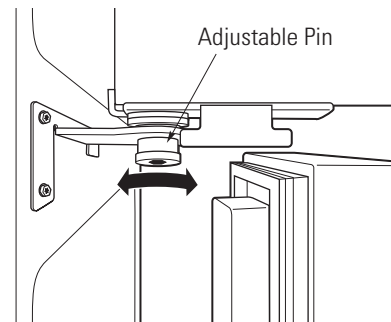
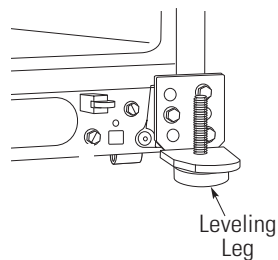

Fruit and vegetable crispers

Excess water that may accumulate in the bottom of the drawers should be wiped dry.

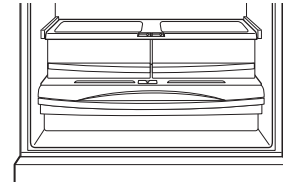

Adjustable humidity crispers

Slide the control all the way to the **HIGH** setting to provide high humidity recommended for most vegetables.

Slide the control all the way to the **LOW** setting to provide lower humidity levels recommended for most fruits.

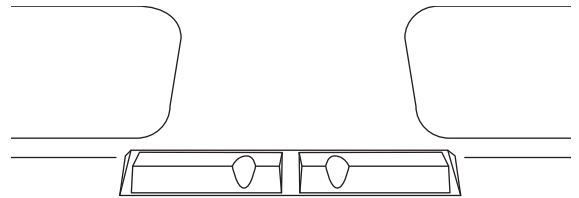

Convertible meat pan

The convertible meat pan has its own cold air duct to allow a stream of cold air from the freezer compartment to flow to the pan.

The variable temperature control regulates the air flow from the Climate Keeper.

Set the control to the **coldest** setting to store fresh meats.



Set the control to **Cold** to convert the pan to normal refrigerator temperature and provide extra vegetable storage space. The cold air duct is turned off. Variable settings between these extremes can be selected.

Deli pan removal

To remove:

- 1 Remove the fruit and vegetable drawers.
- 2 Pull the drawer out to the stop position.
- 3 Lift the lid to access the 4 swing locks.
- 4 Rotate all four swing locks to the unlock position.
- 5 Lift the front of the drawer up and out.

To replace:

- 1 Make sure all four swing locks are in the unlock position.
- 2 Place the sides of the drawer into the drawer supports, making sure the swing locks fit on the drawer slots.
- 3 Lock all four swing locks by rotating them to the lock position.
- 4 Lower the lid and slide in the drawer.
- 5 Replace the fruit and vegetable drawers.

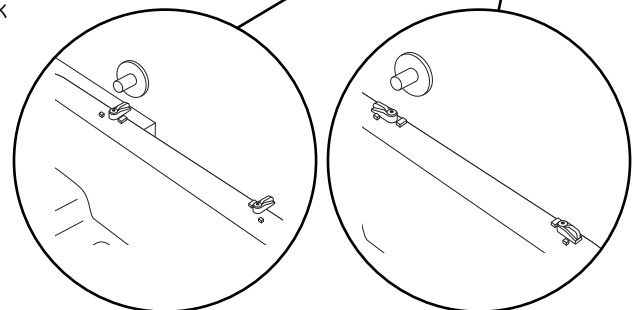
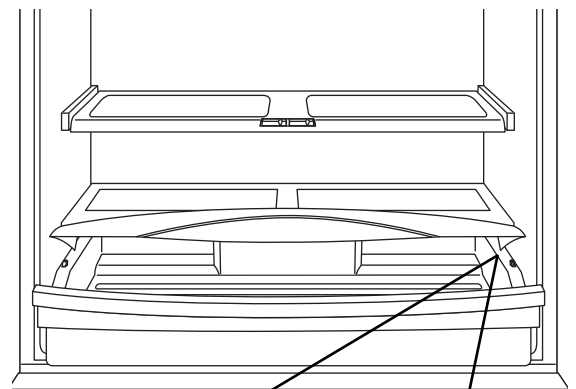

Swing Locks –
Unlock Position

Swing Locks –
Lock Position

Automatic icemaker

NOTE: A newly installed refrigerator may take 12 to 24 hours to begin making ice.

The icemaker will produce seven cubes per cycle—approximately 100–130 cubes in a 24-hour period, depending on freezer compartment temperature, room temperature, number of door openings and other use conditions.

See below for how to access ice and reach the power switch.

If the refrigerator is operated before the water connection is made to the icemaker, set the power switch in the **O (off)** position.

When the refrigerator has been connected to the water supply, set the power switch to the **I (on)** position. The icemaker power light will turn green when the freezer light switch is pressed in or when the freezer door is closed.

The icemaker will fill with water when it cools to 15°F (–10°C). A newly installed refrigerator may take 12 to 24 hours to begin making ice cubes.

You will hear a buzzing sound each time the icemaker fills with water.

Throw away the first few batches of ice to allow the water line to clear.

Be sure nothing interferes with the sweep of the feeler arm.

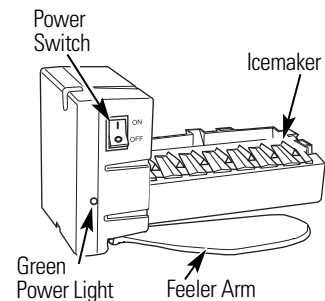

When the bin fills to the level of the feeler arm, the icemaker will stop producing ice. It is normal for several cubes to be joined together.

If ice is not used frequently, old ice cubes will become cloudy, taste stale and shrink.

NOTE: In homes with lower-than-average water pressure, you may hear the icemaker cycle multiple times when making one batch of ice.

NOTE: Set the power switch to the **O (off)** position if the water supply is shut off.

Accessing ice and reaching the power switch

To reach the icemaker power switch, open the top freezer drawer and remove the full-width basket. Always be sure to replace the basket.

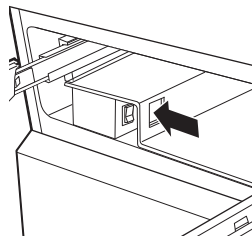

To reach the power switch.

To access ice, open the bottom freezer drawer. The ice bucket is located below the mullion. Pull it forward to access ice.

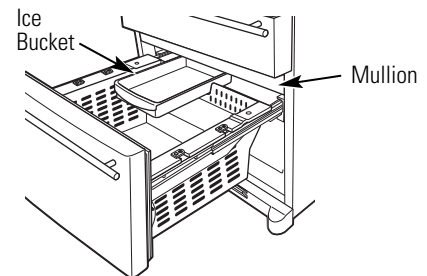

To access ice.

Cleaning the outside

The stainless steel panels and handles can be cleaned with a commercially available stainless steel cleaner such as *Stainless Steel Magic*.™

Stainless Steel Magic is available at Ace, True Value, Servistar, HWI and other leading stores.

It is also available through GE Parts and Accessories, 800.626.2002. Order part number WX10X15.

Do not use appliance wax or polish on the stainless steel.

Cleaning the inside

To help prevent odors, leave an open box of baking soda in the fresh food and freezer compartments.

Unplug the refrigerator before cleaning.

If this is not practical, wring excess moisture out of sponge or cloth when cleaning around switches, lights or controls.

Use warm water and baking soda solution—about a tablespoon (15 ml) of baking soda to a quart (1 liter) of water. This both cleans and neutralizes odors. Rinse and wipe dry.

Use of any cleaning solution other than that which is recommended, especially those that contain petroleum distillates, can crack or damage the interior of the refrigerator.

Avoid cleaning cold glass shelves with hot water because the extreme temperature difference may cause them to break. Handle glass shelves carefully. Bumping tempered glass can cause it to shatter.

Do not wash any plastic refrigerator parts in the dishwasher.

Behind the refrigerator

Be careful when moving the refrigerator away from the wall. All types of floor coverings can be damaged, particularly cushioned coverings and those with embossed surfaces.

Pull the refrigerator straight out and return it to position by pushing it straight in. Moving the refrigerator in a side direction may result in damage to the floor covering or refrigerator.

When pushing the refrigerator back, make sure you don't roll over the power cord or icemaker supply line.

Preparing for vacation

For long vacations or absences, remove food and unplug the refrigerator. Clean the interior with a baking soda solution of one tablespoon (15 ml) of baking soda to one quart (1 liter) of water. Leave the doors open.

Set the icemaker power switch to the **O (off)** position and shut off the water supply to the refrigerator.

If the temperature can drop below freezing, have a qualified servicer drain the water supply system to prevent serious property damage due to flooding.

Preparing to move

Secure all loose items such as shelves and drawers by taping them securely in place to prevent damage.

When using a hand truck to move the refrigerator, do not rest the front or back of the refrigerator against the hand truck. This could damage the refrigerator. Handle only from the sides

of the refrigerator.

Be sure the refrigerator stays in an upright position during moving.

Fresh food compartment— upper light

Setting the controls to OFF does not remove power to the light circuit.

- 1 Unplug the refrigerator.
- 2 The bulbs are located at the top of the compartment, inside the light shield.
- 3 To remove the light shield, pull forward on the shield to disengage the tabs at the back of the shield. Pull down to remove the light shield.
- 4 After replacing the bulbs with appliance bulbs of the same or lower wattage, replace the light shield. When replacing the light shield, set the front tabs into the appropriate slots in the front of the shield housing and pull forward to seat the tabs at the back of the shield into the housing.
- 5 Plug the refrigerator back in.

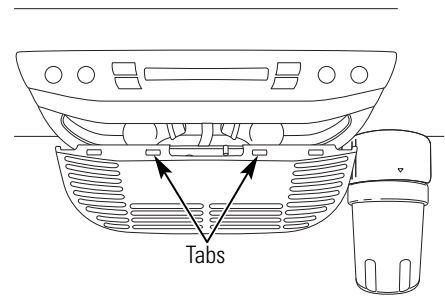

Freezer light

⚠ CAUTION: *Light bulbs may be hot.*

Setting the controls to OFF does not remove power to the light circuit.

- 1 Unplug the refrigerator.
- 2 Remove the freezer basket for access. The bulb is located at the rear of the freezer inside a light shield.
- 3 To remove, grasp the shield at the top and pull out to release the tabs at the bottom.
- 4 After replacing with an appliance bulb of the same or lower wattage, replace the shield and freezer basket.
- 5 Plug the refrigerator back in.

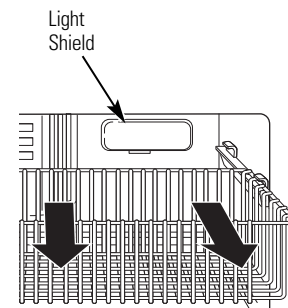

Appearance may vary

Normal operating sounds

Newer refrigerators sound different from older refrigerators. Modern refrigerators have more features and use newer technology.

Do you hear what I hear? These sounds are normal.

**HUMMM...
WHOOSH...**

- The new high efficiency compressor may run faster and longer than your old refrigerator and you may hear a high-pitched hum or pulsating sound while it is operating.
- Sometimes the refrigerator runs for an extended period, especially when the doors are opened frequently. This means that the **Frost Guard™** feature is working to prevent freezer burn and improve food preservation.
- You may hear a whooshing sound when the doors close. This is due to pressure equalizing within the refrigerator.



- You may hear the fans spinning at high speeds. This happens when the refrigerator is first plugged in, when the doors are opened frequently or when a large amount of food is added to the refrigerator or freezer compartments. The fans are helping to maintain the correct temperatures.
- If either door is open for over 3 minutes, you may hear the fans come on in order to cool the light bulbs.
- The fans change speeds in order to provide optimal cooling and energy savings.

**CLICKS, POPS,
CRACKS and CHIRPS**

- You may hear cracking or popping sounds when the refrigerator is first plugged in. This happens as the refrigerator cools to the correct temperature.
- Electronic dampers click open and closed to provide optimal cooling and energy savings.
- The compressor may cause a clicking or chirping sound when attempting to restart (this could take up to 5 minutes).
- The electronic control board may cause a clicking sound when relays activate to control refrigerator components.
- Expansion and contraction of cooling coils during and after defrost can cause a cracking or popping sound.
- After an icemaking cycle, you may hear the ice cubes dropping into the ice bucket.

WATER SOUNDS



- The flow of refrigerant through the freezer cooling coils may make a gurgling noise like boiling water.
- Water dropping on the defrost heater can cause a sizzling, popping or buzzing sound during the defrost cycle.
- A water dripping noise may occur during the defrost cycle as ice melts from the evaporator and flows into the drain pan.
- Closing the door may cause a gurgling sound due to pressure equalization.



For additional information on normal icemaker and dispenser operating sounds, see the **Automatic Icemaker and Internal Water Dispenser** sections.

Questions?
Use this
problem
solver!

PROBLEM	POSSIBLE CAUSE
REFRIGERATOR DOES NOT OPERATE	<ul style="list-style-type: none"> • Refrigerator may be in defrost cycle when motor does not operate for about 30 minutes. • Either or both controls set to OFF. Set to a temperature setting. • If interior light is not on, refrigerator may not be plugged in at wall outlet. Push the plug completely into the wall outlet. • The fuse is blown/circuit breaker is tripped. Replace fuse or reset the breaker. • The refrigerator is in showroom mode. Unplug it and plug it back in.
VIBRATION OR RATTLING (Slight vibration is normal.)	<ul style="list-style-type: none"> • Adjust the rollers as shown in the Installation Instructions.
MOTOR OPERATES FOR LONG PERIODS OR CYCLES ON AND OFF FREQUENTLY (Modern refrigerators with more storage space and a larger freezer require more operating time. They start and stop often to maintain even temperatures.)	<ul style="list-style-type: none"> • Normal when refrigerator is first plugged in. Wait 24 hours for the refrigerator to completely cool down. • Often occurs when large amounts of food are placed in refrigerator. This is normal. • Door left open or package holding door open. • Hot weather or frequent door openings. This is normal. • Temperature controls set at the coldest setting. See Temperature Controls.
FRESH FOOD OR FREEZER COMPARTMENT TOO WARM	<ul style="list-style-type: none"> • Temperature controls not set cold enough. See Temperature Controls. • Warm weather or frequent door openings. • Door left open for long time. • Package may be holding door open.
FROST OR ICE CRYSTALS ON FROZEN FOOD (Frost within package is normal.)	<ul style="list-style-type: none"> • Door left open or package holding door open. • Too frequent or too long door openings.
DIVIDER BETWEEN FRESH FOOD AND FREEZER COMPARTMENTS FEELS WARM	<ul style="list-style-type: none"> • Automatic energy saver system circulates warm liquid around the front edge of the freezer compartment to help prevent condensation from forming on the outside.
AUTOMATIC ICEMAKER DOES NOT WORK	<ul style="list-style-type: none"> • Icemaker power switch is in the O (off) position. • Water supply turned off or not connected. See Installation Instructions. • Freezer compartment too warm. Allow 24 hours for the refrigerator to completely cool down. • Piled up cubes in storage bin cause icemaker to shut off. Level cubes in bin. • Ice cubes stuck in icemaker (green power light on the icemaker is blinking). Turn off the icemaker, remove cubes and turn the icemaker back on.

Questions?
Use this
problem
solver!

PROBLEM	POSSIBLE CAUSE
FREQUENT "BUZZING" SOUND	<ul style="list-style-type: none"> • Icemaker power switch is in the I (on) position, but the water supply to the refrigerator has not been connected. Set the power switch to the O (off) position. Keeping it in the I (on) position will damage the water valve.
ICE CUBES HAVE ODOR/TASTE	<ul style="list-style-type: none"> • Old cubes need to be discarded. • Ice storage bin needs to be emptied and washed. • Unsealed packages in fresh food and/or freezer compartments may be transmitting odor/taste to ice cubes. • Interior of refrigerator needs cleaning. See Care and Cleaning.
SMALL OR HOLLOW CUBES	<ul style="list-style-type: none"> • Water filter clogged. Replace the filter or use the filter bypass plug.
SLOW ICE CUBE FREEZING	<ul style="list-style-type: none"> • Door may have been left open. • Turn temperature of freezer compartment colder. See Temperature Controls.
CUBE DISPENSER DOES NOT WORK	<ul style="list-style-type: none"> • Icemaker or water supply turned off. Turn on icemaker or water supply. • Ice cubes are frozen to the icemaker feeler arm. Remove the cubes. • Irregular clumps in the storage bin. Break up with fingertip pressure and discard remaining clumps. The freezer may be too warm. Adjust the freezer temperature control colder one step at a time until clumps do not form.
WATER HAS POOR TASTE/ODOR	<ul style="list-style-type: none"> • Water dispenser has not been used for a long time. Dispense water until all water in the system has been replenished.
WATER IN FIRST GLASS IS WARM	<ul style="list-style-type: none"> • Normal when refrigerator is first installed. Allow 24 hours for the refrigerator to completely cool down. • Water dispenser has not been used for a long time. Dispense water until all water in the system has been replenished. • Water system has been drained. Allow several hours for the replenished water supply to chill.
WATER DISPENSER DOES NOT WORK	<ul style="list-style-type: none"> • Water supply line turned off or not connected. See the Installation Instructions. • Water filter clogged. Replace the filter or use the filter bypass plug. • Air may be trapped in the system. Press the dispenser arm for at least 2 minutes.
WATER SPURTING FROM DISPENSER	<ul style="list-style-type: none"> • Newly installed filter cartridge. Run 1½ gallons from the dispenser to clear the system.

Questions?
Use this
problem
solver!

PROBLEM	POSSIBLE CAUSE
WATER IS NOT DISPENSED BUT ICEMAKER IS WORKING	<ul style="list-style-type: none"> • Water in reservoir is frozen. Call for service. • Fresh food control setting is too cold. Set to a warmer setting.
NO WATER OR ICE CUBE PRODUCTION	<ul style="list-style-type: none"> • Water supply line or shutoff valve is clogged. Call a plumber. • Replace the filter or use the filter bypass plug.
ORANGE GLOW IN FREEZER	<ul style="list-style-type: none"> • Defrost heater is on. This is normal.
REFRIGERATOR HAS ODOR	<ul style="list-style-type: none"> • Foods with strong odors should be tightly wrapped. • Interior needs cleaning. See Care and Cleaning. • Keep open box of baking soda in refrigerator; replace every 3 months.
DOOR NOT CLOSING PROPERLY	<ul style="list-style-type: none"> • Door gasket on hinge side is sticking or folding over. Apply paraffin wax to the face of the gasket. • A door bin is hitting a shelf inside the refrigerator. Move the door bin up one position.
MOISTURE FORMS ON OUTSIDE OF REFRIGERATOR	<ul style="list-style-type: none"> • Not unusual during periods of high humidity. Wipe surface dry. • Door left open or package holding door open.
MOISTURE COLLECTS INSIDE	<ul style="list-style-type: none"> • Too frequent or too long door openings. • In humid weather, air carries moisture into refrigerator when doors are opened.
INTERIOR LIGHT DOES NOT WORK	<ul style="list-style-type: none"> • No power at outlet. • Light bulb needs replacing. See Care and Cleaning.
HOT AIR FROM BOTTOM OF REFRIGERATOR	<ul style="list-style-type: none"> • Normal air flow cooling motor. In the refrigeration process, it is normal that heat be expelled in the area under the refrigerator. Some floor coverings are sensitive and will discolor at these safe and normal temperatures.
REFRIGERATOR NEVER SHUTS OFF BUT TEMPERATURES ARE OK	<ul style="list-style-type: none"> • Adaptive defrost keeps compressor running during door openings. This is normal. The refrigerator will cycle off after the door remains closed for two hours.
REFRIGERATOR BEEPING	<ul style="list-style-type: none"> • Door is open and door alarm is on.

Questions?
Use this
problem
solver!

PROBLEM	POSSIBLE CAUSE
ACTUAL TEMPERATURE NOT EQUAL TO SET TEMPERATURE	<ul style="list-style-type: none"> • Unit just plugged in. Allow 24 hours for the system to stabilize. • Door open for too long. Allow 24 hours for the system to stabilize. • Warm food added to refrigerator. Allow 24 hours for the system to stabilize. • Defrost cycle is in process. Allow 24 hours for the system to stabilize.
SELECTTEMP FEATURE IS NOT WORKING	<ul style="list-style-type: none"> • Fresh food compartment temperature control is set at the warmest setting. This is normal. In order to minimize energy usage, the SELECTTEMP feature is disabled when the fresh food compartment temperature control is set at the warmest setting.
DOORS ARE NOT ALIGNED	<ul style="list-style-type: none"> • Unlevel floor. Adjust rollers then align doors by adjusting the fresh food compartment hinge. See Installation Instructions.

Performance Data Sheet
SmartWater Filtration System
MWF Cartridge

This system has been tested according to NSF/ANSI 42/53 for reduction of the substances listed below. The concentration of the indicated substances in water entering the system was reduced to a concentration less than or equal to the permissible limit for water leaving the system, as specified in NSF/ANSI 42/53.*
 (100% safety factors built in for unmetered usage)

Standard No. 42: Aesthetic Effects								
Parameter	USEPA MCL	Influent Challenge Concentration	Influent Average	Effluent		% Reduction		Min. Required Reduction
				Average	Maximum	Average	Minimum	
Chlorine	—	2.0 mg/L ± 10%	1.96 mg/L	0.06 mg/L	0.11 mg/L	96.77%	94.74%	> 50%
T&O	—	—	—	—	—	—	—	—
Particulate**	—	≥ 10,000 particles/mL	6,400,000 #/mL	58,833 #/mL	150,000 #/mL	99.14%	97.97%	≥ 85%

Standard No. 53: Health Effects								
Parameter	USEPA MCL	Influent Challenge Concentration	Influent Average	Effluent		% Reduction		Min. Required Reduction
				Average	Maximum	Average	Minimum	
Turbidity	0.5 NTU	11 ± 1 NTU***	10.5 NTU	0.14 NTU	0.28 NTU	98.54%	97.20%	0.5 NTU
Cysts	≥ 99.95% Reduction	Minimum 50,000 L	118,750 #/L	< 1 #/L	4 #/L	> 99.99%	> 99.99%	≥ 99.95%
Asbestos	≥ 99% Reduction	10 ⁷ to 10 ⁸ fibers/L; > 10µm	57 MF/L	0.996 MF/L	< 1 MF/L	99.60%	99.39%	≥ 99%
Lead at pH 6.5	0.015 mg/L	0.15 mg/L ± 10%	0.1567 mg/L	< 0.001 mg/L	< 0.001 mg/L	99.36%	99.29%	0.010 mg/L
Lead at pH 8.5	0.015 mg/L	0.15 mg/L ± 10%	0.1433 mg/L	< 0.001 mg/L	< 0.001 mg/L	99.30%	99.29%	0.010 mg/L
Mercury at pH 6.5	0.002 mg/L	0.006 mg/L ± 10%	0.0059 mg/L	0.000350 mg/L	0.0007 mg/L	94.70%	87.50%	0.002 mg/L
Mercury at pH 8.5	0.002 mg/L	0.006 mg/L ± 10%	0.0057 mg/L	0.000325 mg/L	0.0006 mg/L	93.20%	89.29%	0.002 mg/L
Alachlor	0.002 mg/L	0.04 mg/L ± 10%	0.0367 mg/L	0.00023 mg/L	0.0004 mg/L	99.34%	98.67%	0.002 mg/L
Lindane	0.0002 mg/L	0.002 mg/L ± 10%	0.0020 mg/L	< 0.00002 mg/L	< 0.00002 mg/L	99.00%	98.95%	0.0002 mg/L
2,4-D	0.070 mg/L	0.210 mg/L ± 10%	0.2033 mg/L	0.00337 mg/L	0.011000 mg/L	98.32%	94.50%	0.070 mg/L
Toxaphene	0.003 mg/L	0.015 mg/L ± 10%	0.0160 mg/L	0.00100 mg/L	0.001000 mg/L	93.44%	91.67%	0.003 mg/L
Benzene	0.005 mg/L	0.015 mg/L ± 10%	0.0145 mg/L	0.000500 mg/L	0.000500 mg/L	96.51%	95.83%	0.005 mg/L
Carbofuran	0.040 mg/L	0.080 mg/L ± 10%	0.0830 mg/L	0.001000 mg/L	0.001000 mg/L	98.78%	98.65%	0.04 mg/L
1,4 dichlorobenzene	0.075 mg/L	0.225 mg/L ± 10%	0.2283 mg/L	0.000500 mg/L	0.000500 mg/L	99.78%	99.77%	0.075 mg/L
Atrazine	0.003 mg/L	0.009 mg/L ± 10%	0.0087 mg/L	< 0.0005 mg/L	< 0.0005 mg/L	94.22%	93.33%	0.003 mg/L

* Tested using a flow rate of 0.50 gpm; pressure of 60 psig; pH of 7.5 ± 0.5; temp. of 68° ± 5°F (20° ± 3°C)

** Measurement in Particles/ml. Particles used were 0.5-1 microns

*** NTU=Nephelometric Turbidity units

Operating Specifications

- Capacity: certified for up to 300 gallons (1135 l); up to six months for models without a replacement filter indicator light; up to one year for models with a replacement filter indicator light
- Pressure requirement: 40–120 psi (2.8–8.2 bar), non-shock
- Temperature: 33–100°F (0.6–38°C)
- Flow rate: 0.5 gpm (1.9 lpm)

General Installation/Operation/Maintenance Requirements

- Run 1½ gallons at full flow to purge out trapped air.
- Replace cartridge when the indicator light flashes or water flow rate is reduced on non-indicator units.

Special Notices

- Installation instructions, parts and service availability, and standard warranty are included with the product when shipped.
- This drinking water system must be maintained according to manufacturer's instructions, including replacement of filter cartridges.
- Do not use with water that is microbiologically unsafe or of unknown quality without adequate disinfection before or after the system. Systems certified for cyst reduction may be used on disinfected water that may contain filterable cysts.
- The contaminants or other substances removed or reduced by this water treatment system are not necessarily in your water.
- Check for compliance with the state and local laws and regulations.
- Note that while the testing was performed under standard laboratory conditions, actual performance may vary. Systems must be installed and operated in accordance with manufacturer's recommended procedures and guidelines.

System Tested and Certified by NSF International against ANSI/NSF Standard 42 & 53 for the reduction of:

Standard No. 42: Aesthetic Effects

Chemical Unit
 Chlorine Taste and Odor
 Mechanical Filtration Unit
 Particulate Reduction, Class I

Standard No. 53: Health Effects

Chemical Reduction Unit
 Alachlor and Atrazine Reduction
 Benzene and Carbofuran Reduction
 1,4 dichlorobenzene and 2,4-D Reduction
 Lead and Lindane Reduction
 Mercury and Toxaphene Reduction
 Mechanical Filtration Unit
 Turbidity Reduction
 Cyst and Asbestos Reduction



**Water Treatment Device
Certificate Number**

05 - 1698

Date Issued: February 2, 2005

Trademark/Model Designation

MWF

Replacement Elements

MWF

Manufacturer: General Electric Company

The water treatment device(s) listed on this certificate have met the testing requirements pursuant to Section 116830 of the Health and Safety Code for the following health related contaminants:

Microbiological Contaminants and Turbidity

Cysts
Turbidity

Inorganic/Radiological Contaminants

Asbestos
Lead
Mercury

Organic Contaminants

Alachlor
Atrazine
Benzene
Carbofuran
Lindane
Mercury
Toxaphene
1,4-dichlorobenzene
2,4-D

Rated Service Capacity: 300 gal

Rated Service Flow: 0.5 gpm

Conditions of Certification:

Do not use where water is microbiologically unsafe or with water of unknown quality, except that systems certified for cyst reduction may be used on disinfected waters that may contain filterable cysts.

For Purchases Made In Iowa: This form must be signed and dated by the buyer and seller prior to the consummation of this sale. This form should be retained on file by the seller for a minimum of two years.

BUYER:

Name

Address

City State Zip

Signature Date

SELLER:

Name

Address

City State Zip

Signature Date

With the purchase of your new Monogram appliance, receive the assurance that if you ever need information or assistance from GE, we'll be there. All you have to do is call—toll-free!

GE Answer Center®

**In the USA:
800.626.2000**

Whatever your question about any Monogram major appliance, GE Answer Center® information service is available to help. Your call—and your question—will be answered promptly and courteously. Call the GE Answer Center® Monday to Friday, 8 a.m. to 10 p.m. EST, and Saturday, 8 a.m. to 7 p.m. EST.

OR

Visit our Website at: monogram.com

In Canada, call 1.800.561.3344.

In-Home Repair Service

**In the USA:
800.444.1845**

**In Canada:
1.800.561.3344**

A GE consumer service professional will provide expert repair service, scheduled at a time that's convenient for you. To schedule service, call Monday to Friday, 7 a.m. to 10 p.m. EST, or Saturday and Sunday, 8 a.m. to 6 p.m. EST. Many GE Consumer Service company-operated locations offer you service today or tomorrow, or at your convenience. Our factory-trained technicians know your appliance inside and out—so most repairs can be handled in just one visit.

In Canada: Monday to Friday, 7 a.m. to 8 p.m. and Saturday, 8 a.m. to 5 p.m. EDST.

For Customers With Special Needs...

**In the USA:
800.626.2000**

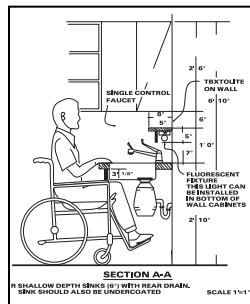

GE offers Braille controls for a variety of GE appliances, and a brochure to assist in planning a barrier-free kitchen for persons with limited mobility.

Consumers with impaired hearing or speech who have access to a TDD or a conventional teletypewriter may call 800.TDD.GEAC (800.833.4322) to request information or service.

Service Contracts

**In the USA:
800.626.2224**

**In Canada:
1.800.561.3344**

You can have the secure feeling that GE Consumer Service will still be there after your warranty expires. Purchase a GE contract while your warranty is still in effect and you'll receive a substantial discount. With a multiple-year contract, you're assured of future service at today's prices.

Parts and Accessories

**In the USA:
800.626.2002**

**In Canada:
1.800.561.3344**

Individuals qualified to service their own appliances can have parts or accessories sent directly to their home. The GE parts system provides access to over 47,000 parts...and all GE Genuine Renewal Parts are fully warranted. VISA, MasterCard and Discover cards are accepted. Visit www.geappliances.com.

User maintenance instructions contained in this manual cover procedures intended to be performed by any user. Other servicing generally should be referred to qualified service personnel. Caution must be exercised, since improper servicing may cause unsafe operation.

YOUR MONOGRAM REFRIGERATOR WARRANTY

Staple sales slip or cancelled check here. Proof of original purchase date is needed to obtain service under warranty.

WHAT IS COVERED

From the Date of the Original Purchase

LIMITED ONE-YEAR WARRANTY

For one year from date of original purchase, we will provide, free of charge, parts and service labor in your home to repair or replace *any part of the refrigerator* that fails because of a manufacturing defect.

LIMITED FIVE-YEAR WARRANTY

For five years from date of original purchase, we will provide, free of charge, parts and service labor in your home to repair or replace *any part of the sealed refrigerating system* (the compressor, condenser, evaporator and all connecting tubing) that fails because of a manufacturing defect.

LIMITED THIRTY-DAY WARRANTY ON WATER FILTER CARTRIDGE (Water filter, if included)

From the date of the original purchase we will provide, free of charge, replacement parts for *any part of the water filter cartridge* that fails because of a manufacturing defect. During this limited thirty-day warranty, we will also provide, free of charge, a replacement water filter cartridge.

.....
This warranty is extended to the original purchaser and any succeeding owner for products purchased for ordinary home use in the 48 mainland states, Hawaii, Washington, D.C. or Canada. If the product is located in an area where service by a GE Authorized Servicer is not available, you may be responsible for a trip charge or you may be required to bring the product to an Authorized GE Service location for service. In Alaska the warranty is the same except that it is LIMITED because you must pay to ship the product to the service shop or for the service technician's travel costs to your home.

All warranty service will be provided by our Factory Service Centers or by our authorized Customer Care® servicers during normal working hours.

Should your appliance need service, during warranty period or beyond, in the USA call 800.444.1845. In Canada: 800.561.3344. Please have your serial number and model number available when calling for service.

WHAT IS NOT COVERED

- Service trips to your home to teach you how to use the product.
- Replacement of house fuses or resetting of circuit breakers.
- Damage to the product caused by accident, fire, floods or acts of God.
- Failure of the product if it is used for other than its intended purpose or used commercially.
- Damage caused after delivery.
- Improper installation, delivery or maintenance. If you have an installation problem, contact your dealer or installer. You are responsible for providing adequate electrical, plumbing and other connecting facilities.
- Replacement of the light bulbs, if included, or water filter cartridge, if included, other than as noted above.
- Replacement of the water filter cartridge, if included, due to water pressure that is outside the specified operating range or due to excessive sediment in the water supply.
- Loss of food due to spoilage (in the USA only).
- Incidental or consequential damage caused by possible defects with this appliance.
- Product not accessible to provide required service.

EXCLUSION OF IMPLIED WARRANTIES—Your sole and exclusive remedy is product repair as provided in this Limited Warranty. Any implied warranties, including the implied warranties of merchantability or fitness for a particular purpose, are limited to one year or the shortest period allowed by law.

Some states/provinces do not allow the exclusion or limitation of incidental or consequential damages, so the above limitation or exclusion may not apply to you. This warranty gives you specific legal rights, and you may also have other rights which vary from state to state/province to province. To know what your legal rights are in your state/province, consult your local or state/provincial consumer affairs office or your state's Attorney General.

**Warrantor in USA: General Electric Company,
Louisville, KY 40225**

Warrantor in Canada: Mabe Canada Inc.

225D1804P011
49-60617

04-10 GE
Printed in the United States



GE Consumer & Industrial Appliances
General Electric Company
Louisville, KY 40225
GEAppliances.com

Free Manuals Download Website

<http://myh66.com>

<http://usermanuals.us>

<http://www.somanuals.com>

<http://www.4manuals.cc>

<http://www.manual-lib.com>

<http://www.404manual.com>

<http://www.luxmanual.com>

<http://aubethermostatmanual.com>

Golf course search by state

<http://golfingnear.com>

Email search by domain

<http://emailbydomain.com>

Auto manuals search

<http://auto.somanuals.com>

TV manuals search

<http://tv.somanuals.com>