

# Owner's Manual

Side-by-Side  
36", 42", 48"  
Built-In Refrigerators



**Monogram®**

# Consumer Information

## *Built-In Refrigerators*

---

### *Introduction*

Your new Monogram refrigerator makes an eloquent statement of style, convenience and kitchen planning flexibility. Whether you chose it for its purity of design, practical storage arrangements or assiduous attention to detail—or for all of these reasons—you'll find that your Monogram refrigerator's superior blend of form and function will delight you for years to come.

The Monogram refrigerator was designed to provide the flexibility to blend in with your kitchen cabinetry. Decorative door insert panels allow it to match your kitchen cabinets or blend with your kitchen decor. Through a series of product choices, the Monogram refrigerator can be beautifully integrated into the kitchen.

Since this is designed to be a built-in product, custom panels are required on the front of the Monogram refrigerator. Consult your kitchen designer or cabinetmaker for your customized look.

The information on the following pages will help you operate and maintain your refrigerator properly.

If you have any questions, visit our website at: [ge.com](http://ge.com)

---

### *Contents*

#### **Consumer Services**

Important Phone Numbers . . . . .	.31
Model and Serial Numbers . . . . .	.3
Problem Solver . . . . .	.25–28
Product Registration . . . . .	.3
Safety Instructions . . . . .	4–7
Smartwater Filter Performance	
Data Sheet . . . . .	.29
State of California	
Water Treatment Device Certificate . . . . .	.30
Warranty . . . . .	Back Cover

#### **Care and Cleaning**

Cleaning—Outside and Inside . . . . .	.19
Cleaning—Condenser . . . . .	.24
Light Bulb Replacement . . . . .	20–23
Moving and Vacation . . . . .	.24
Master Light Switch . . . . .	.21

#### **Operating Instructions**

Automatic Icemaker . . . . .	.12
Climate Control Drawer . . . . .	.13, 14, 16
Control Lock . . . . .	.14
Ice and Water Dispenser . . . . .	.10, 11
Shelves and Bins . . . . .	.17, 18
Storage Pans . . . . .	.15, 16
Temperature Controls . . . . .	.8
Water Filter Cartridge . . . . .	.9
Sabbath Mode Product Kit, ZSAB1 . . . . .	.18

## Consumer Information

*Built-In Refrigerators*

---

*Before  
using your  
refrigerator*

Read this manual carefully. It is intended to help you operate and maintain your new refrigerator properly.

Keep it handy for answers to your questions.

If you don't understand something or need more help, there is a list of toll-free consumer service numbers included in the back section of this manual.

**OR**

Visit our Website at: [ge.com](http://ge.com)

---

*Write  
down the  
model &  
serial  
numbers*

You'll see them on a label above the freezer compartment behind the grille panel.

These numbers are also on the Consumer Product Ownership Registration Card included with this manual.

**Before sending in this card, please write these numbers here:**

\_\_\_\_\_  
Model Number

\_\_\_\_\_  
Serial Number

Use these numbers in any correspondence or service calls concerning your refrigerator.

---

*If you  
received a  
damaged  
refrigerator*

Immediately contact the dealer (or builder) that sold you the refrigerator.

---

*Save time  
& money*

**Before you request service, check the Problem Solver in the back of this manual.**

It lists causes of minor operating problems that you can correct yourself.

---

*If you  
need  
service*

**To obtain service, see the Consumer Services page in the back of this manual.**

We're proud of our service and want you to be pleased. If for some reason you are not happy with the service you receive, here are steps to follow for further help.

**For customers in the USA:**

FIRST, contact the people who serviced your appliance. Explain why you are not pleased. In most cases, this will solve the problem.

NEXT, if you are still not pleased, write all the details—including your phone number—to:

Manager, Customer Relations  
GE Appliances  
Appliance Park  
Louisville, KY 40225

**For customers in Canada:**

FIRST, contact the people who serviced your appliance. Explain why you are not pleased. In most cases, this will solve the problem.

NEXT, if you are still not pleased, write all the details—including your phone number to:

Manager, Consumer Relations  
Camco Inc.  
1 Factory Lane, Suite 310  
Moncton, N.B. E1C 9M3

---

# IMPORTANT SAFETY INSTRUCTIONS

---

## READ AND SAVE THESE INSTRUCTIONS

**⚠ WARNING** — When using this appliance, always exercise basic safety precautions, including the following:

- Use this appliance only for its intended purpose as described in this Owner's Manual.
- This refrigerator must be properly installed in accordance with the Installation Instructions before it is used.
- Do not allow children to climb, stand or hang on the shelves in the refrigerator. They could damage the refrigerator and seriously injure themselves.
- After your refrigerator is in operation, do not touch the cold surfaces in the freezer compartment, particularly when hands are damp or wet. Skin may adhere to these extremely cold surfaces.
- Do not store or use gasoline or other flammable vapors and liquids in the vicinity of this or any other appliance.
- In refrigerators with an automatic icemaker, avoid contact with the moving parts of the ejector mechanism, or with the heating element located on the bottom of the icemaker. Do not place fingers or hands on the automatic icemaking mechanism while the refrigerator is plugged in.
- Keep fingers out of the "pinch point" areas: clearances between the doors and between the doors and cabinet are necessarily small. Be careful closing doors when children are in the area.
- Unplug your refrigerator before cleaning and making repairs. NOTE: We strongly recommend that any servicing be performed by a qualified individual.
- Before replacing a burned-out light bulb, set the Master Light switch in the OFF position to turn off the lights in order to avoid contact with a live wire filament. (A burned-out light bulb may break when being replaced.) NOTE: Setting the refrigerator temperature controls to OFF does not remove power to the light circuit.
- Do not refreeze frozen foods which have thawed completely.

---

## ⚠ DANGER: RISK OF CHILD ENTRAPMENT

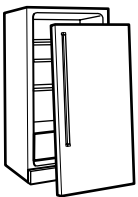

Child entrapment and suffocation are not problems of the past. Junked or abandoned refrigeration products are still dangerous... even if they will sit for "just a few days." If you are getting rid of your old appliance, please follow these instructions to help prevent accidents.

Before You Throw Away Your Old Refrigeration Product:

- Take off the doors.
- Leave the shelves in place so that children may not easily climb inside.

---

## REFRIGERANTS

All refrigeration products contain refrigerants, which under federal law must be removed prior to product disposal. If you are getting rid of an old refrigeration product, check with the company handling the disposal about what to do.

# IMPORTANTES INSTRUCTIONS DE SÉCURITÉ

---

## LIRE ET CONSERVER CES INSTRUCTIONS

### **⚠ AVERTISSEMENT :**

Lorsque vous utilisez le réfrigérateur, observez toujours certaines précautions de base, notamment :

- N'utilisez le réfrigérateur que pour son usage prévu, comme décrit dans le présent manuel.
- Installez le réfrigérateur conformément aux directives d'installation avant de l'utiliser.
- Ne laissez pas les enfants grimper, s'asseoir, se tenir debout ni se pendre aux clayettes du réfrigérateur. Ils pourraient endommager le réfrigérateur et se blesser gravement.
- Une fois le réfrigérateur en marche, ne touchez pas les surfaces froides du congélateur, surtout si vous avez les mains humides ou mouillées : la peau risque d'adhérer à ces surfaces très froides.
- N'entreposez et n'utilisez pas d'essence ou autres vapeurs et liquides inflammables à proximité de cet appareil ou de tout autre appareil électroménager.
- Pour les réfrigérateurs dotés d'une machine à glaçons automatique, évitez le contact avec les pièces mobiles du mécanisme éjecteur, ou avec l'élément chauffant situé à la partie inférieure de la machine à glaçons. Ne posez pas les doigts ou les mains sur le mécanisme de la machine à glaçons pendant que le réfrigérateur est branché.
- Éloignez les doigts des parties du réfrigérateur où l'on peut facilement se pincer : les espaces entre les portes et les placards sont toujours étroits. Soyez prudent lorsque vous fermez les portes de l'appareil en présence des enfants.
- Débranchez votre réfrigérateur avant de le nettoyer et de le réparer.  
**REMARQUE :** Nous vous recommandons vivement de confier toute réparation à un technicien qualifié.
- Avant de remplacer une ampoule grillée, mettez le commutateur de lumière principale en position OFF (arrêt) pour éteindre la lumière afin d'éviter tout contact avec un fil sous tension. (Une ampoule grillée peut se briser pendant l'opération).  
**REMARQUE :** Lorsque vous placez les commandes de température du réfrigérateur sur OFF (arrêt), l'alimentation électrique de l'ampoule n'est pas coupée.
- Ne faites PAS recongeler des aliments surgelés qui ont complètement dégelé.

## **⚠ DANGER! RISQUES POUR LES ENFANTS**

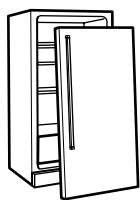

Les enfants pris au piège ou morts d'asphyxie sont toujours d'actualité. Les appareils de réfrigération abandonnés sont toujours aussi dangereux, même si on n'attend que "quelque jours" pour s'en débarrasser. Si vous ne gardez pas votre ancien appareil, veuillez suivre les directives ci-dessous afin de prévenir les accidents.

Avant de vous débarrasser de votre vieux appareil de réfrigération:

- Démontez les portes.
- Laissez les clayettes en place afin d'empêcher les enfants de grimper à l'intérieur.

## RÉFRIGÉRANTS

Tous les appareils de réfrigération contiennent des réfrigérants qui, conformément aux lois fédérales, doivent être enlevés avant toute élimination de l'appareil. Si vous vous débarrassez de vieux appareils de réfrigération, vérifiez, auprès de la société qui s'occupe de leur élimination, ce que vous devez faire.

# IMPORTANT SAFETY INSTRUCTIONS

---

## *HOW TO CONNECT ELECTRICITY*

**Do not, under any circumstances, cut or remove the third (ground) prong from the power cord. For personal safety, this appliance must be properly grounded.**

The power cord of this appliance is equipped with a 3-prong (grounding) plug which mates with a standard 3-prong (grounding) wall outlet to minimize the possibility of electric shock hazard from this appliance.

Have the wall outlet and circuit checked by a qualified electrician to make sure the outlet is properly grounded.

Where a standard 2-prong wall outlet is encountered, it is your personal responsibility and obligation to have it replaced with a properly grounded 3-prong wall outlet.

Use of a GFI (Ground Fault Interruptor) is not recommended for the refrigerator outlet.

The appliance should always be plugged into its own individual electrical outlet which has a voltage rating that matches the rating plate. This provides the best performance and also prevents overloading house wiring circuits which could cause a fire hazard from overheated wires.

**DO NOT USE AN ADAPTER PLUG TO CONNECT THE REFRIGERATOR TO A 2-PRONG OUTLET.**

**DO NOT USE AN EXTENSION CORD WITH THIS APPLIANCE.**

Never unplug an appliance by pulling on the power cord. Always grip the plug firmly and pull straight out from the outlet.

Repair or replace immediately all power cords that have become frayed or otherwise damaged. Do not use a cord that shows cracks or abrasion damage along its length or at either end.

When moving the appliance, be careful not to roll over or damage the power cord.

***SAVE THESE INSTRUCTIONS***

# IMPORTANTES INSTRUCTIONS DE SÉCURITÉ

---

## *RACCORDEMENT ÉLECTRIQUE*

Ne coupez ni retirez en aucun cas la troisième broche (mise à la terre) de la fiche du cordon d'alimentation. Pour votre sécurité, cet appareil doit être correctement mis à la terre.

Le cordon d'alimentation de cet appareil est muni d'une fiche à 3 broches (mise à la terre) qui se branche dans une prise mural ordinaire à 3 alvéoles (mise à la terre) pour réduire au minimum les risques du chocs électriques.

Faites examiner la prise de courant et le circuit par un électricien qualifié pour vous assurer que la prise est correctement mise à la terre.

Si la prise murale est du type standard à 2 alvéoles, il vous incombe de la faire remplacer par une prise à 3 alvéoles correctement mise à la terre.

L'utilisation d'un interrupteur de défaut à la terre (GFI–Ground Fault Interruptor) n'est pas recommandé pour la prise de courant du réfrigérateur.

La machine à glaçons doit toujours être branché dans sa propre prise de courant, dont la tension nominale est identique à celle indiquée sur la plaque signalétique. Cette précaution est recommandée pour garantir un rendement optimum et éviter une surcharge des circuits électriques de la résidence, ce qui pourrait créer un risque d'incendie par surschauffe des fils.

**N'UTILISEZ PAS UNE FICHE D'ADAPTATION POUR RACCORDER LE RÉFRIGÉRATEUR DANS UNE PRISE MURALE À 2 ALVÉOLES.**

**N'UTILISEZ PAS DE CORDONS PROLONGATEURS AVEC CET APPAREIL.**

Ne débranchez jamais l'appareil en tirant le cordon d'alimentation. Saisissez fermement la fiche du cordon et tirez droit pour la retirer de la prise.

Réparez ou remplacez immédiatement tout cordon effiloché ou endommagé. N'utilisez pas un cordon fendillé ou présentant des signes d'usure.

Lorsque vous déplacez l'appareil du mur, faites attention de ne pas la faire rouler sur le cordon d'alimentation afin de ne pas l'endommager.

## *CONSERVEZ CES DIRECTIVES*

# Temperature Controls

Built-In Refrigerators

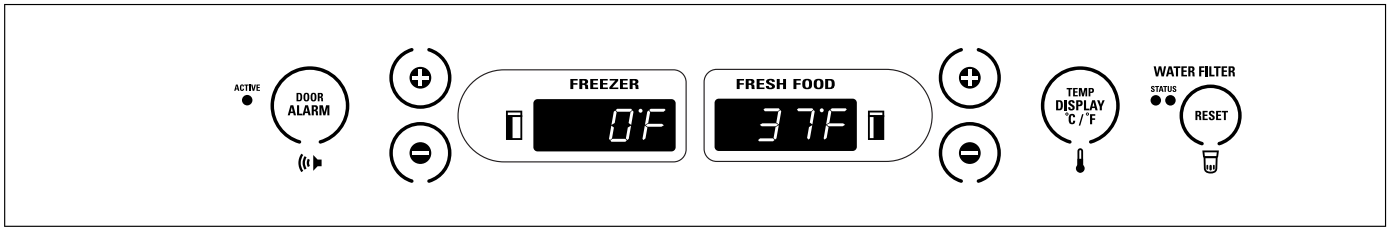

Preset Settings:  
Allow 24 hours to reach these preset temperatures.

## Temperature controls

The temperature display shows the actual temperature of the freezer and fresh food compartments. The actual temperature will vary from the set temperature based on factors such as door opening, amount of food, defrost cycling and room temperature.

**NOTE:** Frequent door openings or door left open for periods of time may increase the internal temperature of the freezer and fresh food compartments temporarily.

To turn off the cooling system in both the freezer and fresh food compartments, press either  $\oplus$  pad until both displays show **OFF**.

To turn the cooling system on, press either  $\ominus$  pad. The preset temperatures of 0°F and 37°F will appear in the display.

To check the current temperature setting for the fresh food or freezer compartment, press the  $\oplus$  or  $\ominus$  pad once. After 5 seconds, the display will return to the actual temperature.

To change the temperature settings, press the  $\oplus$  or  $\ominus$  pads to desired temperature set point for fresh food and freezer separately. Allow 24 hours for the refrigerator to reach the temperature you have set.

### Temperature Ranges

	Low	High
Fresh Food	34°F 1°C	45°F 7°C
Freezer	-6°F -21°C	+6°F -14°C

**NOTE:** Setting the controls to **OFF** stops cooling, but does not shut off electrical power to the refrigerator.

## Changing display temperatures from °F to °C

To change the temperature display between Fahrenheit and Celsius, press **Temp Display °C/°F**.

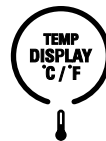

## Door alarm

To turn the Door Alarm feature on, press **DOOR ALARM** once. The **ACTIVE** light will come on. To turn it off, press it again.

On models with a dispenser, the Door Alarm feature is located on the dispenser panel on the front of the freezer door.

When the **DOOR ALARM** is active, the alarm will flash and beep if you keep the door open for more than 2 minutes.





# Water Filter Cartridge

Built-In Refrigerators

## Water filter cartridge

The water filter cartridge is located in the back upper right corner of the refrigerator compartment.

### To Replace the Filter:

The filter cartridge is designed to filter 300 gallons of water (lasting approximately 12 months).

It should be replaced when the status light turns red or if you notice the ice cubes getting hollow or small.



### Installing the Filter Cartridge:

1. Remove the old cartridge by slowly turning it to the left. A small amount of water may drip down. **Do not** pull down on the cartridge.
2. Fill the new cartridge with water from the tap to allow for better flow immediately after installation.
3. Line up the arrow on the cartridge with the center of the holder. **Do not** push it up into the holder.
4. Slowly turn it to the right until the cartridge stops. It will rotate about 1/4 turn. **DO NOT OVERTIGHTEN.**

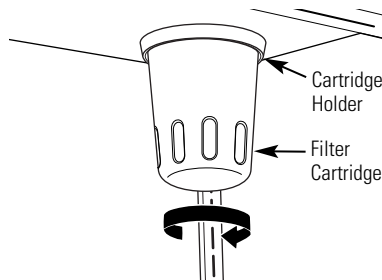

Slowly turn it to the right.  
Do not overtighten.

### To Reset the Filter Status Light:

Press and hold the **RESET** pad for 3 seconds.

### Filter Bypass Plug:

You **must** use the filter bypass plug:

- a) if you have a household reverse osmosis water system and/or another form of home water filtration system

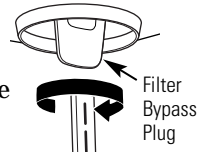

- b) if a replacement filter is not available.

The icemaker and dispenser will not operate without the filter or filter bypass plug installed.

### Replacement filters:

To order additional filter cartridges in the United States, visit our Website at [ge.com](http://ge.com), or call GE Parts and Accessories, 800.626.2002.

MWF

Suggested Retail \$38.95–47.95

Customers in Canada should consult the yellow pages for the nearest Camco Service Center.

*Dispenser  
with  
glass-touch  
controls*

**How it Works**

The electronic controls on the dispenser are truly interactive. The control panel is equipped with a proximity sensor that causes the panel to light up as you approach the dispenser (approx. 2 inches). To make a selection, simply touch the graphic for the feature you want, and the halo for that feature will light up. When you walk away from the refrigerator, the lighted graphics switch off automatically.

*Ice storage bin***To remove:**

Lift up the access door to reach the icemaker. Set the icemaker power switch to the **O** (off) position. With the access door closed, support the storage bin at the bottom while slightly lifting. Pull bin straight out.

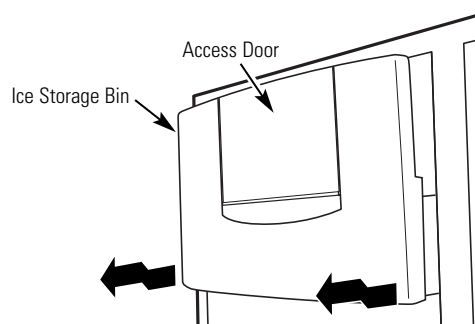
**To replace:**

Slide the bin back until the tab on the bin locks into the slot on the shelf. If the bin does not go all the way back, remove it and rotate the drive mechanism 1/4 turn. Then push the bin back again.

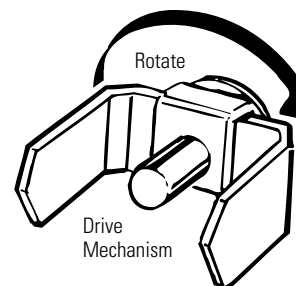
*Important facts about your ice & water dispenser*

- Do not add ice from trays or bags to the storage bin. It may not crush or dispense well.
- Avoid overfilling glass with ice and use of narrow or extra-tall glasses. Backed-up ice can jam the chute or cause the door in the chute to freeze shut. If ice is blocking the chute, poke it through with a wooden spoon.
- Beverages and foods should not be quick-chilled in the ice storage bin. Cans, bottles or food packages in the storage bin may cause the icemaker or auger to jam.
- To keep dispensed ice from missing the glass, put the glass close to, but not touching, the dispenser opening.
- Some crushed ice may be dispensed even though you selected **CUBES**. This happens occasionally when a few cubes accidentally get directed to the crusher.
- After crushed ice is dispensed, some water may drip from the chute.
- Sometimes a mound of snow will form on the door in the ice chute. This condition is normal and usually occurs when you have dispensed crushed ice repeatedly. The snow will eventually evaporate.
- Dispensed water is not ice cold. For colder water, simply add crushed ice or cubes before dispensing water.
- The first glass of water dispensed may be warmer than the following ones. This is normal.
- To eliminate drips on the spill shelf, tilt the glass in slightly when dispensing water.

### *Automatic icemaker*

**A newly-installed refrigerator may take 12–24 hours to begin making ice.**

The icemaker will produce seven cubes per cycle—approximately 15 cycles in a 24-hour period, depending on freezer compartment temperature, room temperature, number of door openings and other use conditions.

If the refrigerator is operated before the water connection is made to the icemaker, set the power switch to **O (off)**.

When the refrigerator has been connected to the water supply, set the power switch to **I (on)**. The green light will come on.

Throw away the first full bucket of ice.

Be sure nothing interferes with the sweep of the feeler arm.

When the bin fills to the level of the feeler arm, the icemaker will stop producing ice.

It is normal for several cubes to be joined together.

If ice is not used frequently, old ice cubes will become cloudy, taste stale and shrink.

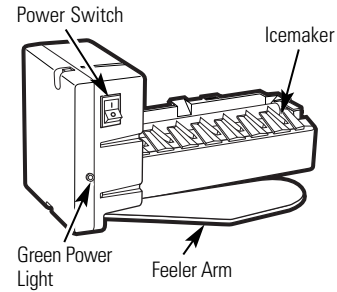

After the icemaker has been turned on again, there will be a delay of about 45 minutes before the icemaker resumes operations.

**NOTE:** In homes with lower-than-average water pressure, you may hear the icemaker water valve cycle on several times when making one batch of ice.

*Climate  
Control  
drawer*

**How it Works**

The **Climate Control** feature is a system of dampers, a fan, a temperature thermistor, a heater and a specially designed tray. The Climate Control drawer can be used to chill items quickly, thaw foods quickly or store items at their optimum temperatures.

The drawer is tightly sealed to prevent the drawer's temperature from causing temperature fluctuations in the rest of the refrigerator.

**SELECT TEMP**—Use this feature to store items at their optimum temperatures. The **CITRUS** setting will maintain a drawer temperature of 39–47°F by cycling a small heater off and on as needed. The **PRODUCE** setting will maintain the drawer temperature at 31–38°F by drawing in additional cold air as needed. The **MEAT** setting will maintain the drawer temperature at 27–37°F by drawing in additional cold air as needed.

**EXPRESS CHILL**—This feature can be used to cool items in minutes, rather than hours. Extra cool air is circulated throughout the drawer. Once the cycle is complete, the drawer will revert to the pre-set fresh food temperature.

**EXPRESS THAW**—This feature thaws items in hours rather than days. Food is gently thawed in a cool environment by circulating air throughout the drawer. Temperature is maintained in the drawer by cycling a small heater off and on as needed. Once the thaw cycle is complete, the pan will automatically adjust to a temperature of 27–37°F to store the food at its optimum temperature.

**Climate Control Tray**—Besides using the specially designed Climate Control tray when using the drawer, it can also be used as a chilled serving tray to keep foods cold.

**NOTE:** By turning the controls on the Climate Control drawer off, the drawer can be used as a standard sealed produce pan.

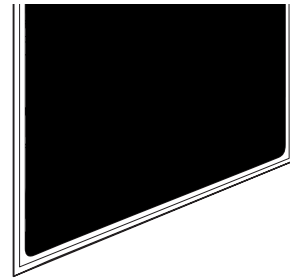

---

**How to Use**

- 1 Empty the drawer. Place the tray in the drawer. Place the items on the tray and close the drawer completely.
- 2 Select the *Express Thaw*,™ *Express Chill*™ or *Select Temp*™ pad. The display will come on. Press the pad until the light appears next to the desired setting. Use the chart on the next page to determine the best setting.
  - To stop a feature before it is finished, press that feature's pad until no options are selected and the display is off.
  - During *Express Thaw*™ and *Express Chill*™ the display on the controls will count down the time remaining in the cycle.
  - After the *Express Thaw*™ cycle is complete, the drawer will reset to the **MEAT** setting (27–37°F) to help preserve thawed items until they are used.

- The displayed actual temperature of the Climate Control drawer may vary slightly from the **SET** temperature based on usage and operation environment.

**NOTE:** For food safety reasons, it is recommended that foods be wrapped in plastic wrap when using *Express Thaw*.™ This will help contain meat juices and improve thawing performance.

# Climate Control Drawer

*Built-In Refrigerators*

## *Climate Control chart*

NOTE: Results may vary depending on packaging, starting temperature and other food traits.



### Citrus Setting (39–47°F)

- Oranges, Lemons, Limes, Pineapple, Cantaloupe
- Beans, Cucumbers, Tomatoes, Peppers, Eggplant, Squash

### Produce Setting (31–38°F)

- Strawberries, Raspberries, Kiwifruit, Pears, Cherries, Blackberries, Grapes, Plums, Nectarines, Apples
- Asparagus, Broccoli, Corn, Mushrooms, Spinach, Cauliflower, Kale, Green Onions, Beets, Onions

### Meat Setting (27–37°F)

- Raw Meat, Fish and Poultry

### 15 Minutes

- 1 Beverage Can (12 oz)
- 2 Small Juice Boxes (6–8 oz each)

### 30 Minutes

- Wine (750 ml bottle)
- 2 to 6 Beverage Cans (12 oz each)
- 2 Plastic 20 oz Bottles of Beverage
- 4 to 6 Small Juice Boxes (6–8 oz each)
- 3 Foil Juice Packets

### 45 Minutes

- 2 Liter of Beverage
- 1/2 Gallon of Juice
- Gelatin—1 package

### 0.5 Lbs. (4 hours)

- Individually Wrapped Filet Mignon (0.5 lb)
- Hamburger Patties (0.5 lb)

### 1.5 Lbs. (8 hours)

- Chicken Breasts (1.5 lbs)
- Ground Beef (1.5 lbs)
- Steak (1.5 lbs)

### 3.0 Lbs. (12 hours)

- Chicken Breasts (3.0 lbs)
- Ground Beef (3.0 lbs)
- Steak (3.0 lbs)

## *Control lock*

### **Control Lock**

Press and hold this pad for 3 seconds to lock the settings for the Climate Control drawer. To unlock, press and hold for another 3 seconds.



# Storage Pans

*Built-In Refrigerators*

## *Sealed deli pan*

Use the Sealed Deli Pan for the convenient storage of lunch meats and cheese, hors d'oeuvres, spreads and snacks. The pan and shelf to which it is attached can be adjusted to any height.

## *Sealed produce pans*

The top pan has adjustable humidity levels for the higher humidity levels required by most vegetables and lower humidity levels required for most fruits.

The second pan is designed to provide constant high humidity levels.

Make sure the drawers are closed completely to maintain the correct humidity level.

**NOTE:** The Climate Control drawer can be used as another sealed produce pan by turning the controls on the Climate Control drawer off. The temperature inside the drawer will be the same as the fresh food compartment.

How long produce can be stored will depend upon the type of food and its condition when placed in the pans.

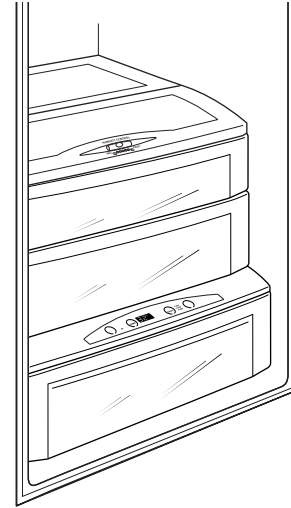

- |                 |                 |                  |                    |                |            |
|-----------------|-----------------|------------------|--------------------|----------------|------------|
| • Artichokes    | • Cherries      | • Parsley        | • Broccoli         | • Cabbage      | • Parsnips |
| • Asparagus     | • Corn          | • Peas, green    | • Brussels sprouts | • Cauliflower  | • Turnips  |
| • Beets, topped | • Cucumbers     | • Radishes       |                    | • Green onions |            |
| • Blueberries   | • Currants      | • Rhubarb        |                    |                |            |
| • Carrots       | • Greens, leafy | • Spinach        |                    |                |            |
| • Celery        | • Lettuce       | • Tomatoes, ripe |                    |                |            |

## *Drawer and pan removal*

### **To remove a drawer or pan:**

1. Pull the pan out to the stop position.
2. Lift the front of the pan up and out of the wire holder.
3. Lift the back of the pan up and out.

### **To replace a pan:**

1. Place the back of the pan in the wire holder, making sure the wire holder fits into the grooves on the back of the pan.
2. Lower the front of the pan into the wire holder.
3. Press firmly on the top of the pan to snap it into the wire holder.

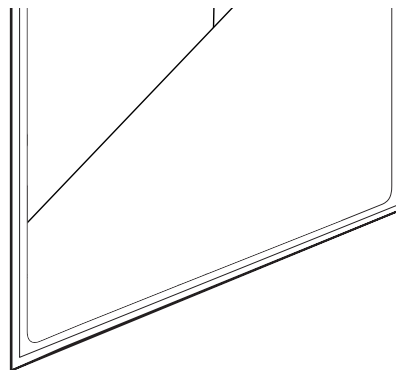



## Shelves and Bins

*Built-In Refrigerators*

---

### *How to rearrange your shelves*

Tempered glass shelves in the fresh food compartment and wire shelves in the freezer compartment are adjustable, enabling you to make efficient shelf arrangements to fit your family's food storage needs.

#### **To remove shelves:**

Tilt shelf up at front, then lift it up and out of tracks on rear wall of refrigerator.

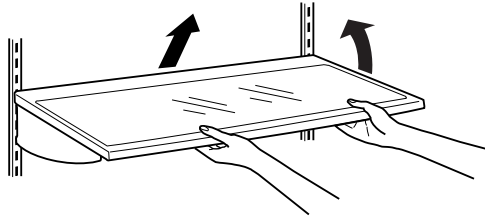

#### **To replace shelves:**

Select desired shelf height. With shelf front raised slightly, engage top lugs in tracks at rear of cabinet. Then lower front of shelf until it locks into position.

### *Door bins*

All door bins, except for the deep gallon door bin, are adjustable and can be moved up and down to meet your storage needs. The deep gallon door bin can be removed for cleaning.

#### **To remove any bin:**

Lift the bin up and slide it toward you.

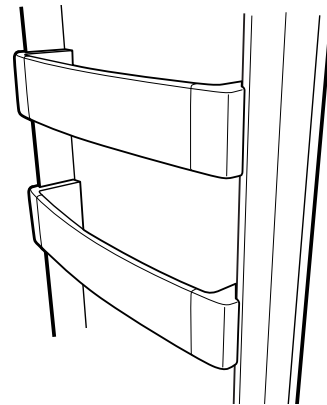

### *Removable wine rack*

The rack can be attached to the left or right side of any shelf. It is designed to hold a bottle, including a 2 liter bottle, on its side.

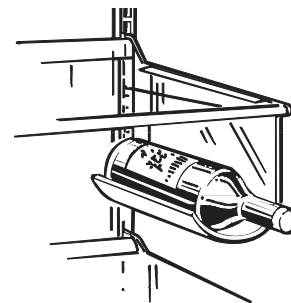

### *Freezer baskets*

Wire slide-out freezer baskets can be pulled out for easy access to frozen foods.

**To remove:**

Pull basket out. Lift the front of the basket up and then take it out.

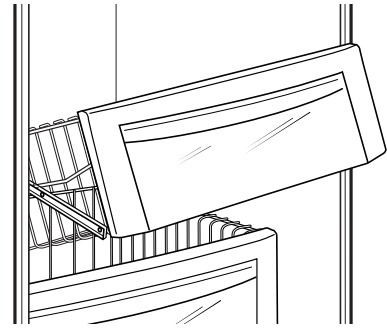

### *Freezer juice rack*

This slide-out rack can be used to easily access frozen juices or foods.

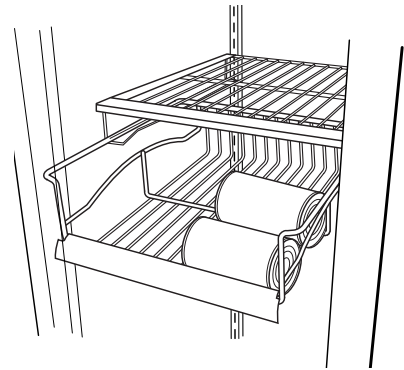

### *Sabbath Mode Product Kit* (available at extra cost)

The Sabbath Mode Product Kit was designed for use on the Jewish Sabbath and Holidays. The Sabbath Mode feature makes it possible for observant Jews to refrigerate and freezer food during the duration of the holiday.

The Sabbath Mode feature can be set to override typical reactions to actions in your refrigerator. While in the Sabbath Mode your refrigerator will still operate normally. However the refrigerator will not respond to your actions.

While in the Sabbath Mode you may notice the fan running when the door is opened; however, this is not a result of your actions. The fan will operate at random times. The defrost heater will continue to defrost the refrigerator and freezer and will be activated on a timer. The defrost heater will not defrost as a result of door openings or any consumer actions.

**ON/OFF**—To activate, raise the top grill panel, set the Sabbath Mode switch to the **ON** position. A green LED light will be visible below the Sabbath Mode Kit switch. The light will be visible when the grille is closed between the grille door and compartment doors.

**DISPLAYS, ALARMS and LIGHTS**—The main temperature control and Express Chill displays will be deactivated; therefore they will not be lit, sound a tone or operate when touched. Door alarms and lights will be disabled.

**ICE and WATER DISPENSER**—The proximity sensor and dispenser touch sensor icons will not operate. Ice or water cannot be retrieved from the dispenser.

**ICEMAKER**—The icemaker will continue to operate. The icemaker can be disabled by opening the freezer, opening the ice storage bin door and setting the icemaker power switch to the **O (off)** position (see *Automatic Icemaker*). To obtain ice, open the freezer door and remove the cubed ice from the ice bin.

This Sabbath Mode Product Kit can be purchased from your local appliance dealer. The ZSAB1 Kit is designed for use with Monogram Built-In Refrigerators: 36", 42" and 48" Side-by-Side models manufactured after February 2004 and 36" Bottom-Freezer models manufactured after April 2004. To locate your nearest dealer visit our web site [ge.com](http://ge.com) or call 1.800.626.2000. In Canada, call 1.888.880.3030. Order Kit # ZSAB1.

**NOTE:** The Sabbath Mode Product Kit must be installed by a qualified service technician.

### *Cleaning outside*

**The dispenser spill shelf and the area beneath it** should be cleaned periodically with a mild liquid dish detergent.

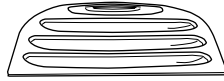

**Dispenser cradle**—Before cleaning, lock the dispenser by touching **CONTROL LOCK** for 3 seconds to prevent activating the dispenser. Clean with warm water and a mild liquid dish detergent. Rinse thoroughly and wipe dry. Unlock the dispenser by touching **CONTROL LOCK** for 3 seconds.

**Do not use chemical cleaners to clean the dispenser or any part of the dispenser.**

**Door handles and trim**—Clean with a cloth dampened with soapy water. Dry with a soft cloth.

**Keep the outside clean.** Wipe with a clean cloth lightly dampened with mild liquid dish detergent. Dry with a clean, soft cloth.

Do not wipe the refrigerator with a soiled dish cloth or wet towel. These may leave a residue that can damage the finish. Do not use scouring pads, powdered cleaners, bleach or cleaners containing bleach because these products can scratch and damage the finish.

**Stainless steel**—Regularly clean and polish the Stainless Steel Door Panels and Handles (on some models) with a commercially available stainless steel cleaner such as *Stainless Steel Magic*<sup>™</sup> to preserve and protect the fine finish. *Stainless Steel Magic* and the Monogram polishing cloth are available through GE Parts and Accessories, 800.626.2002, or ge.com. For *Stainless Steel Magic*, order part number WX10X15. For Monogram polishing cloth, order part number WX72X10001.

Do not use appliance wax or polish on the stainless steel.

### *Cleaning inside*

**Turn off power at the circuit breaker or fuse box before cleaning.** If this is not practical, wring excess moisture out of sponge or cloth when cleaning around switches, lights or controls.

Use warm water and baking soda solution—about a tablespoon (15 ml) of baking soda to a quart (1 liter) of water. This both cleans and neutralizes odors. Thoroughly rinse and wipe dry.

**Other parts of the refrigerator**—including door gaskets, meat and vegetable drawers, ice storage bin and all plastic parts—can be cleaned the same way.

**Do not wash any plastic refrigerator parts in the dishwasher.**

**Do not wash the aluminum Climate Control tray in the dishwasher. The aluminum will discolor in the dishwasher.**

**Avoid cleaning cold glass shelves with hot water because the extreme temperature difference may cause them to break. Handle glass shelves carefully. Rough handling of tempered glass can cause it to shatter.**

**WARNING** — Halogen lights generate intense heat. Be certain power is off and lamps have sufficient time to cool before attempting to replace.

Power to the lamps can be turned off at the Master Light switch located behind the grille panel at the top of the refrigerator.

Turning the temperature control to **OFF** does **NOT** remove power to the light circuits.

## **AVERTISSEMENT :**

Les ampoules halogènes produisent une chaleur intense. Assurez-vous de bien couper le courant et de laisser suffisamment de temps aux ampoules pour leur permettre de se refroidir avant d'essayer de les remplacer.

Vous pouvez couper le courant en utilisant le commutateur de lumière principale situé derrière le panneau grillagé en haut du réfrigérateur.

Vous **NE COUPEZ PAS** l'alimentation électrique du réfrigérateur des circuits de lumières en mettant le bouton de contrôle de température en position **OFF (arrêt)**.

**The refrigerator uses two types of halogen bulbs:**

**Type 1** The columns along the back wall of the fresh food and freezer compartments are lit up by lamps located behind the top pan in the fresh food compartment and the bottom basket in the freezer compartment.

**Type 2** These lamps are located inside the light shield at the top of the fresh food compartment and on top of the Climate Control drawer at the bottom of the fresh food compartment.

Type 1 bulbs have a life expectancy of about 2000 hours. Type 2 bulbs have a life expectancy of about 2000 hours. However, if the bulbs do need to be replaced, they can be purchased at hardware, general retail and home improvement stores or through GE Parts and Accessories, 800.626.2002.



**Type 1**

**Type 2**

#### *Using the Master Light switch*

This feature turns off the lights in the fresh food and freezer compartments.

The switch is located behind the grille panel at the top of the refrigerator. Lift up the panel to access the switch.

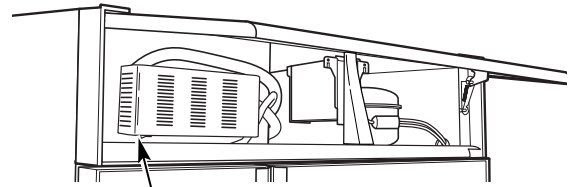

The switch is located behind the grille panel.

#### *Type 1 bulb replacement*

**NOTE:** Before replacing the bulbs, review the light bulb information and WARNING.

**Replacing Type 1 bulbs located in lamps behind the top pan in the fresh food compartment and the bottom freezer basket in the freezer compartment:**

1. Set the Master Light switch to the **OFF** position (see *Using the Master Light switch*) and allow the lamps to cool.
2. To access the lamps in the fresh food compartment, remove the Humidity Control pan. See *Drawer and Pan Removal* section. Raise the lid of the pan up to expose the light cover.  
  
To access the lamps in the freezer compartment, remove the bottom freezer basket. See *Freezer Baskets* section.
3. On the back wall there is a curved light shield. Grasp each end of the light shield. Pull the shield toward you and the tabs on the shield will release from the slots in the housing.
4. Remove the glass above the bulbs by pulling it straight out.

**NOTE:** Always follow bulb manufacturer's directions for handling and replacing bulbs.

5. Remove the bulb by holding the base and pulling straight up. Replace with a new bulb.
6. Replace the glass by sliding it into place. Then replace the light shield by resting the top lip of the shield on top of the light housing. Then press the sides until the tabs pop into the slots in the housing.

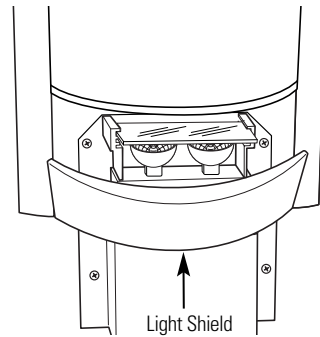

Light Shield

**WARNING** — The light shield must be replaced or the heat from the bulb could damage the refrigerator.

#### **AVERTISSEMENT :**

Vous devez remettre en place l'écran à lumière pour ne pas endommager votre réfrigérateur avec la chaleur produite par l'ampoule.

7. Reset the Master Light switch to the **ON** position.

...des p... le...  
...réf...



### Type 2 bulb replacement

**NOTE:** Before replacing the bulbs, review the light bulb information and **WARNING**.

**Replacing Type 2 bulbs in lamps located in the top of the Climate Control drawer:**

1. Set the Master Light switch to the **OFF** position (see *Using the Master Light switch*) and allow the lamps to cool.
2. To access the lamps, remove the second produce pan. See *Drawer and Pan Removal* section.
3. The lamps at the back, that face up, can be lifted out. To access the lamp that shines into the Climate Control drawer, twist the holder until the arrow points towards the back of the refrigerator, then lift up.
4. Turn the lamp protector to access the bulb.

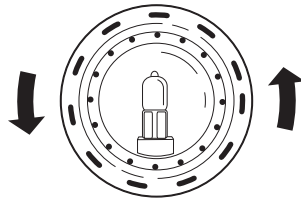

**NOTE:** Always follow bulb manufacturer's directions for handling and replacing bulbs.

5. Remove the bulb by holding the base and pulling straight out. Replace with a new bulb and replace the lamp protector.

**WARNING** — Lamp protectors must be replaced or the heat from the bulb could damage the refrigerator.

### **AVERTISSEMENT :**

Vous devez remettre en place les écrans protecteurs des ampoules pour ne pas endommager votre réfrigérateur avec la chaleur produite par les ampoules.

6. Reset the Master Light switch to the **ON** position.

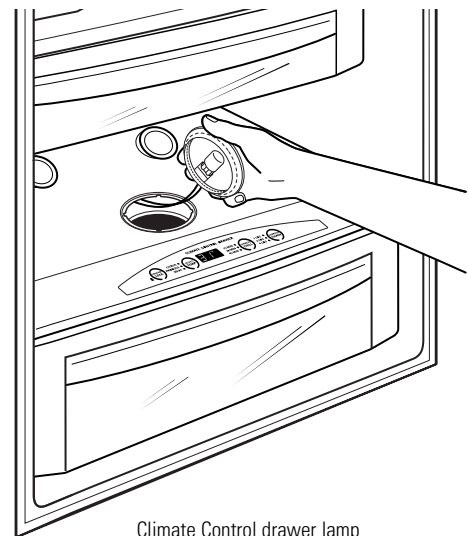
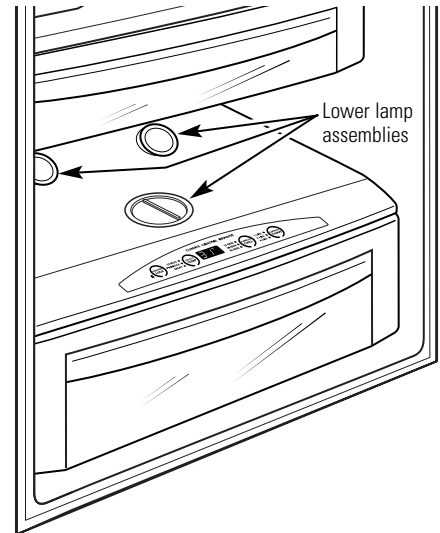

### *Cleaning the condenser*

There is no need for routine condenser cleanings in normal home operating environments. However, in environments that may be particularly dusty or greasy, the condenser should be cleaned (at least annually) for efficient refrigerator operation.

To clean the condenser:

### **⚠ WARNING:**

The condenser fins have sharp edges. Wear a long-sleeved shirt and gloves to safely clean the condenser.

1. Turn off the power at the circuit breaker or fuse box. Wait about 30 minutes for the condenser area to cool.
2. Raise the grille panel at the top of the refrigerator to reach the condenser.  
The condenser fins have sharp edges. Wear a long-sleeved shirt and gloves to safely clean the condenser.  
The condenser is located at the very back of the machine compartment on the right behind the compressor. The condenser fins are not visible from the front.

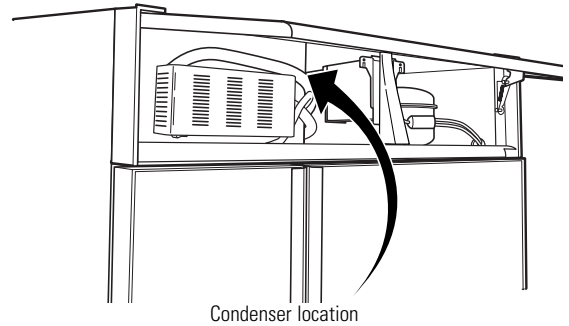

Condenser location

3. To clean the condenser, reach back through the middle section of the machine compartment to the right with a soft bristle brush and loosen dust and lint on the condenser fins.
4. Use a vacuum hose to remove soil.
5. Reconnect power at the fuse box or circuit breaker.

### *Preparing for vacation*

For long vacations or absences, remove food and shut off power to the refrigerator at the fuse box or circuit breaker. Clean the interior (see *Cleaning Inside*). Leave doors open.

For shorter vacations, remove perishable foods and leave controls at regular settings. However, if the room temperature is expected to drop below 60°F (16°C), follow the same instructions as for long vacations.

Set the icemaker power switch to the **O (off)** position and be sure to shut off the water supply to the refrigerator.



# The Problem Solver

*Built-In Refrigerators*

*Questions?  
Use this  
problem  
solver!*

PROBLEM	POSSIBLE CAUSE
<b>REFRIGERATOR DOES NOT OPERATE</b>	<ul style="list-style-type: none"> <li>• May be in defrost cycle when compressor does not operate for about 30 minutes.</li> <li>• Temperature control set at <b>OFF</b>.</li> <li>• If interior light is not on, refrigerator may not be plugged in at wall outlet.</li> <li>• The fuse is blown/circuit breaker is tripped. Replace fuse or reset the breaker.</li> </ul>
<b>MOTOR OPERATES FOR LONG PERIODS OR CYCLES ON AND OFF FREQUENTLY</b> (Modern refrigerators with more storage space and a larger freezer require more operating time. They start and stop often to maintain even temperatures.)	<ul style="list-style-type: none"> <li>• Normal when refrigerator is first plugged in. Wait 24 hours for the refrigerator to completely cool down.</li> <li>• The new variable speed compressor is designed to run for longer periods of time to optimize efficiency and noise. You may notice the compressor and/or fan speeds accelerate based upon door openings and/or increased food loads.</li> <li>• You may hear the fans spinning at high speeds. This happens when the refrigerator is first plugged in, when the doors are opened frequently or when a large amount of food is added to the refrigerator or freezer compartments. The fans are helping to maintain the correct temperatures.</li> <li>• Door left open or package holding door open.</li> <li>• If either door is open for over 3 minutes, you may hear the fans come on in order to cool the light.</li> <li>• Hot weather or frequent door openings. This is normal.</li> <li>• Temperature controls set at the coldest setting. See <i>Temperature Controls</i>.</li> </ul>
<b>OPERATING SOUNDS</b>	<ul style="list-style-type: none"> <li>• Refrigerator is so quiet, that most of the time you will hear low or no operating noise.</li> <li>• Normal fan air flow—one fan blows cold air through the fresh food and freezer compartments—another fan cools the compressor motor.</li> <li>• The fans change speeds in order to provide optimal cooling and energy savings.</li> <li>• These <b>NORMAL</b> sounds will also be heard from time to time:               <ul style="list-style-type: none"> <li>– You may hear a whooshing or gurgling sound when the doors close. This is due to pressure equalizing within the refrigerator.</li> <li>– A water dripping noise may occur during the defrost cycle as ice melts from the evaporator and flows into the drain pan.</li> <li>– The flow of refrigerant through the freezer cooling coils may make a gurgling noise like boiling water.</li> <li>– Water dropping on the defrost heater can cause a sizzling, popping or buzzing sound during the defrost cycle.</li> <li>– You may hear cracking or popping sounds when the refrigerator is first plugged in or during/after the defrost cycle. This happens as the refrigerator cools to the correct temperature.</li> <li>– Electronic dampers click open and closed to provide optimal cooling and energy savings.</li> <li>– The compressor may cause a clicking or chirping sound when attempting to restart (this could take up to 5 minutes).</li> <li>– The electronic control board may cause a clicking sound when relays activate to control refrigerator components.</li> <li>– Ice cubes dropping into the bin and water running in pipes as icemaker refills.</li> <li>– The icemaker water valve will buzz when the icemaker fills with water.</li> </ul> </li> </ul>

# The Problem Solver

*Built-In Refrigerators*

*Questions?  
Use this  
problem  
solver!*

PROBLEM	POSSIBLE CAUSE
<b>DOOR NOT CLOSING PROPERLY</b>	<ul style="list-style-type: none"> <li>• Package may be holding door open.</li> <li>• Check the door gasket; it may out of position.</li> <li>• Refrigerator is not level. See <i>Installation Instructions</i>.</li> </ul>
<b>ACTUAL TEMPERATURE NOT EQUAL TO SET TEMPERATURE</b>	<ul style="list-style-type: none"> <li>• Refrigerator just plugged in. Allow 24 hours for system to stabilize.</li> <li>• Door open for too long. Allow 24 hours for system to stabilize.</li> <li>• Warm food added to refrigerator. Allow 24 hours for system to stabilize.</li> <li>• Defrost cycle is in process. Allow 24 hours for system to stabilize.</li> </ul>
<b>VIBRATION OR RATTLING</b> (Slight vibration is normal.)	<ul style="list-style-type: none"> <li>• Refrigerator may not be properly installed.</li> </ul>
<b>FRESH FOOD OR FREEZER COMPARTMENT TOO WARM</b>	<ul style="list-style-type: none"> <li>• Temperature controls not set cold enough. See <i>Temperature Controls</i>.</li> <li>• Warm weather or frequent door openings.</li> <li>• Door left open for long time.</li> <li>• Package may be holding door open.</li> </ul>
<b>FROST OR ICE CRYSTALS ON FROZEN FOOD</b> (Frost within package is normal.)	<ul style="list-style-type: none"> <li>• Door left open or package holding door open.</li> <li>• Too frequent or too long door openings.</li> </ul>
<b>SLOW ICE CUBE FREEZING</b>	<ul style="list-style-type: none"> <li>• Door may have been left open.</li> <li>• Freezer compartment is too warm. Set the freezer to a colder temperature.</li> </ul>
<b>ICE HAS ODOR/TASTE</b>	<ul style="list-style-type: none"> <li>• Old cubes need to be discarded.</li> <li>• Ice storage bin needs to be emptied and washed.</li> <li>• Unsealed packages in freezer compartment may be transmitting odor/taste to ice.</li> <li>• Keep open box of baking soda in refrigerator; replace every 3 months.</li> <li>• Poor-tasting incoming water. Replace water filter.</li> </ul>
<b>AUTOMATIC ICEMAKER DOES NOT WORK</b>	<ul style="list-style-type: none"> <li>• Icemaker power switch is in the <b>O (off)</b> position.</li> <li>• Water supply turned off or not connected.</li> <li>• Freezer compartment too warm.</li> <li>• Piled up cubes in storage bin may cause icemaker to shut off too soon. Level cubes in bin.</li> </ul>
<b>MOISTURE FORMS ON CABINET SURFACE BETWEEN THE DOORS</b>	<ul style="list-style-type: none"> <li>• Not unusual during periods of high humidity. Wipe surface dry.</li> <li>• Controlling humidity and temperature in the kitchen with air conditioning will eliminate this condition.</li> </ul>

# The Problem Solver

## Built-In Refrigerators

PROBLEM	POSSIBLE CAUSE
<b>MOISTURE COLLECTS INSIDE</b>	<ul style="list-style-type: none"><li>• Too frequent or long door openings.</li><li>• In humid weather, air carries moisture into refrigerator when doors are opened.</li><li>• Controlling humidity and temperature in the kitchen with air conditioning will eliminate this condition.</li></ul>
<b>REFRIGERATOR HAS ODOR</b>	<ul style="list-style-type: none"><li>• Foods with strong odors should be tightly covered.</li><li>• Check for spoiled food.</li><li>• Interior needs cleaning. See <i>Care and Cleaning</i>.</li><li>• Keep open box of baking soda in refrigerator; replace every 3 months.</li></ul>
<b>INTERIOR LIGHT DOES NOT WORK</b>	<ul style="list-style-type: none"><li>• No power at outlet.</li><li>• Light bulb needs replacing. See <i>Care and Cleaning</i>.</li><li>• Master Light switch is in the <b>OFF</b> position.</li><li>• The refrigerator is equipped with a safety feature that turns off the refrigerator lights when the doors have been opened for an extended period. Once the refrigerator doors are closed and the lights have had time to cool, they will again come on automatically when the doors are opened.</li></ul>
<b>SMALL OR HOLLOW CUBES</b>	<ul style="list-style-type: none"><li>• Water filter clogged. Replace the filter or use the filter bypass plug.</li><li>• Check for a connection to a Reverse Osmosis water system. If an RO is connected, remove the water filter and install the original bypass plug that came with the unit.</li></ul>
<b>WATER ON THE FLOOR</b>	<ul style="list-style-type: none"><li>• If you use an extra tall glass or pitcher, or overfill a glass or pitcher, you may be jamming the cubes in the funnel chute. They can fuse inside the chute and drop out later, leaving water or ice on the floor.</li></ul>
<b>UNEVEN SPACING OR GAPS BETWEEN DOORS AND KITCHEN CABINET</b>	<ul style="list-style-type: none"><li>• Kitchen cabinets are not level or square. Call the installer or cabinetmaker.</li></ul>
<b>POOR DOOR ALIGNMENT OR ONE DOOR HIGHER THAN THE OTHER</b>	<ul style="list-style-type: none"><li>• Fresh food door needs adjusting. See <i>Installation Instructions</i>.</li><li>• Refrigerator is not level. See <i>Attention Installer Instructions</i>.</li></ul>
<b>WATER HAS POOR TASTE OR ODOR</b>	<ul style="list-style-type: none"><li>• Water dispenser has not been used for a long time. Dispense water until all water in system is replenished.</li></ul>
<b>WATER IN FIRST GLASS IS WARM</b>	<ul style="list-style-type: none"><li>• Normal when refrigerator is first installed. Wait 24 hours for the refrigerator to completely cool down.</li><li>• Water dispenser has not been used for a long time. Dispense water until all water in system is replenished.</li><li>• Water system has been drained. Allow several hours for replenished supply to chill.</li></ul>

# The Problem Solver

*Built-In Refrigerators*

*Questions?  
Use this  
problem  
solver!*

<b>PROBLEM</b>	<b>POSSIBLE CAUSE</b>
<b>WATER DISPENSER DOES NOT WORK</b>	<ul style="list-style-type: none"> <li>• Water supply line turned off, restricted or not connected. Call your installer for proper water supply line connection.</li> <li>• Water filter clogged. Replace the filter or use the filter bypass plug.</li> <li>• The <b>CONTROL LOCK</b> on the dispenser has been activated. To unlock the dispenser, touch <b>CONTROL LOCK</b> for 3 seconds.</li> <li>• Air may be trapped in system. Press the dispenser arm for at least 2 minutes.</li> </ul>
<b>ICE DISPENSER DOES NOT WORK</b>	<ul style="list-style-type: none"> <li>• <b>Ice bin improperly installed.</b> See <i>Ice storage bin</i>.</li> <li>• Icemaker turned off or water supply turned off. Turn on icemaker or water supply.</li> <li>• Ice cubes are frozen to the icemaker feeler arm. Remove cubes.</li> <li>• Irregular ice clumps in storage bin. Break up with fingertip pressure and discard remaining clumps.</li> <li>• Freezer may be too warm. Adjust freezer control to a colder setting, one position at a time, until clumps do not form.</li> <li>• Water filter clogged. Replace the filter or use the filter bypass plug.</li> <li>• The <b>CONTROL LOCK</b> on the dispenser has been activated. To unlock the dispenser, touch <b>CONTROL LOCK</b> for 3 seconds.</li> </ul>
<b>WATER SPURTING FROM DISPENSER</b>	<ul style="list-style-type: none"> <li>• Newly installed filter cartridge. Run water from the dispenser for 3 minutes (about one and a half gallons).</li> </ul>
<b>NO WATER OR ICE PRODUCTION</b>	<ul style="list-style-type: none"> <li>• Water supply line turned off, restricted or not connected. Call your installer for proper water supply line connection.</li> <li>• Water filter clogged. Replace the filter or use the filter bypass plug.</li> </ul>
<b>CUBED ICE WAS SELECTED BUT CRUSHED ICE WAS DISPENSED</b>	<ul style="list-style-type: none"> <li>• Last setting was <b>CRUSHED ICE</b>. A few cubes were left in the crusher from the previous setting. This is normal.</li> <li>• If continual crushed ice is dispensed while cubed ice is selected, adjust ice bin. See <i>Ice storage bin</i>.</li> </ul>
<b>FOOD IS NOT THAWING/CHILLING IN CLIMATE CONTROL DRAWER</b>	<ul style="list-style-type: none"> <li>• Packaging. Increase time or re-package in plastic.</li> <li>• Wrong weight selected. Select a larger weight.</li> <li>• Item with high fat content. Select a larger weight.</li> <li>• Not using the Climate Control tray. Place items on tray and allow space in between items for better air flow.</li> </ul>
<b>SELECT TEMP FEATURE ON CLIMATE CONTROL DRAWER IS NOT WORKING</b>	<ul style="list-style-type: none"> <li>• Fresh Food temperature control is set at warmest setting. This is normal. In order to minimize energy usage, the Select Temp feature is disabled when the Fresh Food control is set at the warmest setting.</li> </ul>
<b>CLIMATE CONTROL DRAWER CONTROLS DO NOT WORK</b>	<ul style="list-style-type: none"> <li>• Control Lock feature is active. Press and hold the <b>CONTROL LOCK</b> pad on the Climate Control drawer for 3 seconds.</li> </ul>

**Performance Data Sheet**  
**SmartWater Filtration System**  
**MWF Cartridge**

**This system has been tested according to NSF/ANSI 42/53 for reduction of the substances listed below. The concentration of the indicated substances in water entering the system was reduced to a concentration less than or equal to the permissible limit for water leaving the system, as specified in NSF/ANSI 42/53.\* (100% safety factors built in for unmetrated usage)**

Standard No. 42: Aesthetic Effects								
Parameter	USEPA MCL	Influent Challenge Concentration	Influent Average	Effluent		% Reduction		Min. Required Reduction
				Average	Maximum	Average	Minimum	
Chlorine	—	2.0 mg/L ± 10%	1.96 mg/L	0.06 mg/L	0.11 mg/L	96.77%	94.74%	> 50%
T & O	—	—	—	—	—	—	—	—
Particulate**	—	≥ 10,000 particles/mL	6,400,000 #/mL	58,833 #/mL	150,000 #/mL	99.14%	97.97%	≥ 85%

Standard No. 53: Health Effects								
Parameter	USEPA MCL	Influent Challenge Concentration	Influent Average	Effluent		% Reduction		Min. Required Reduction
				Average	Maximum	Average	Minimum	
Turbidity	0.5 NTU	11 ± 1 NTU***	10.5 NTU	0.14 NTU	0.28 NTU	98.54%	97.20%	0.5 NTU
Cysts	≥ 99.95% Reduction	Minimum 50,000 L	118,750 #/L	< 1 #/L	4 #/L	> 99.99%	> 99.99%	≥ 99.95%
Asbestos	≥ 99% Reduction	10 <sup>7</sup> to 10 <sup>8</sup> fibers/L; > 10µm	57 MF/L	0.996 MF/L	< 1 MF/L	99.60%	99.39%	≥ 99%
Lead at pH 6.5	0.015 mg/L	0.15 mg/L ± 10%	0.1567 mg/L	< 0.001 mg/L	< 0.001 mg/L	99.36%	99.29%	0.010 mg/L
Lead at pH 8.5	0.015 mg/L	0.15 mg/L ± 10%	0.1433 mg/L	< 0.001 mg/L	< 0.001 mg/L	99.30%	99.29%	0.010 mg/L
Mercury at pH 6.5	0.002 mg/L	0.006 mg/L ± 10%	0.0059 mg/L	0.000350 mg/L	0.0007 mg/L	94.70%	87.50%	0.002 mg/L
Mercury at pH 8.5	0.002 mg/L	0.006 mg/L ± 10%	0.0057 mg/L	0.000325 mg/L	0.0006 mg/L	93.20%	89.29%	0.002 mg/L
Alachlor	0.002 mg/L	0.04 mg/L ± 10%	0.0367 mg/L	0.00023 mg/L	0.0004 mg/L	99.34%	98.67%	0.002 mg/L
Lindane	0.0002 mg/L	0.002 mg/L ± 10%	0.0020 mg/L	< 0.00002 mg/L	< 0.00002 mg/L	99.00%	98.95%	0.0002 mg/L
2,4-D	0.070 mg/L	0.210 mg/L ± 10%	0.2033 mg/L	0.00337 mg/L	0.011000 mg/L	98.32%	94.50%	0.070 mg/L
Toxaphene	0.003 mg/L	0.015 mg/L ± 10%	0.0160 mg/L	0.00100 mg/L	0.001000 mg/L	93.44%	91.67%	0.003 mg/L
Benzene	0.005 mg/L	0.015 mg/L ± 10%	0.0145 mg/L	0.000500 mg/L	0.000500 mg/L	96.51%	95.83%	0.005 mg/L
Carbofuran	0.040 mg/L	0.080 mg/L ± 10%	0.0830 mg/L	0.001000 mg/L	0.001000 mg/L	98.78%	98.65%	0.04 mg/L
1,4 dichlorobenzene	0.075 mg/L	0.225 mg/L ± 10%	0.2283 mg/L	0.000500 mg/L	0.000500 mg/L	99.78%	99.77%	0.075 mg/L
Atrazine	0.003 mg/L	0.009 mg/L ± 10%	0.0087 mg/L	< 0.0005 mg/L	< 0.0005 mg/L	94.22%	93.33%	0.003 mg/L

\* Tested using a flow rate of 0.50 gpm; pressure of 60 psig; pH of 7.5 ± 0.5; temp. of 68° ± 5°F (20° ± 3°C)

\*\* Measurement in Particles/ml. Particles used were 0.5-1 microns

\*\*\* NTU=Nephelometric Turbidity units

**Operating Specifications**

- Capacity: certified for up to 300 gallons (1135 l); up to six months for models without a replacement filter indicator light; up to one year for models with a replacement filter indicator light
- Pressure requirement: 40–120 psi (2.8–8.2 bar), non-shock
- Temperature: 33–100°F (0.6–38°C)
- Flow rate: 0.5 gpm (1.9 lpm)

**General Installation/Operation/Maintenance Requirements**

- Flush new cartridge at full flow for 3 minutes to purge out trapped air.
- Replace cartridge when the indicator light flashes or water flow rate is reduced on non-indicator units.

**Special Notices**

- Installation instructions, parts and service availability, and standard warranty are included with the product when shipped.
- This drinking water system must be maintained according to manufacturer's instructions, including replacement of filter cartridges.
- Do not use with water that is microbiologically unsafe or of unknown quality without adequate disinfection before or after the system. Systems certified for cyst reduction may be used on disinfected water that may contain filterable cysts.
- The contaminants or other substances removed or reduced by this water treatment system are not necessarily in your water.
- Check for compliance with the state and local laws and regulations.
- Note that while the testing was performed under standard laboratory conditions, actual performance may vary. Systems must be installed and operated in accordance with manufacturer's recommended procedures and guidelines.

System Tested and Certified by NSF International against ANSI/NSF Standard 42 & 53 for the reduction of:
<b>Standard No. 42: Aesthetic Effects</b>
Chemical Unit
Chlorine Taste and Odor
Mechanical Filtration Unit
Particulate Reduction, Class I
<b>Standard No. 53: Health Effects</b>
Chemical Reduction Unit
Alachlor and Atrazine Reduction
Benzene and Carbofuran Reduction
1,4 dichlorobenzene and 2,4-D Reduction
Lead and Lindane Reduction
Mercury and Toxaphene Reduction
Mechanical Filtration Unit
Turbidity Reduction
Cyst and Asbestos Reduction



State of California  
Department of Health Services  
**Water Treatment Device  
Certificate Number**

**05 - 1698**

Date Issued: February 2, 2005

---

---

**Trademark/Model Designation**

MWF

**Replacement Elements**

MWF

**Manufacturer:** General Electric Company

---

---

The water treatment device(s) listed on this certificate have met the testing requirements pursuant to Section 116830 of the Health and Safety Code for the following health related contaminants:

**Microbiological Contaminants and Turbidity**

Cysts  
Turbidity

**Inorganic/Radiological Contaminants**

Asbestos  
Lead  
Mercury

**Organic Contaminants**

Alachlor  
Atrazine  
Benzene  
Carbofuran  
Lindane  
Mercury  
Toxaphene  
1,4-dichlorobenzene  
2,4-D

---

**Rated Service Capacity:** 300 gal

**Rated Service Flow:** 0.5 gpm

---

**Conditions of Certification:**

Do not use where water is microbiologically unsafe or with water of unknown quality, except that systems certified for cyst reduction may be used on disinfected waters that may contain filterable cysts.

*With the purchase of your new Monogram appliance, receive the assurance that if you ever need information or assistance from GE, we will be there. All you have to do is call—toll-free!*

### **GE Answer Center®**

**In the USA:  
800.626.2000**

Whatever your question about any Monogram major appliance, GE Answer Center® information service is available to help. Your call—and your question—will be answered promptly and courteously. And you can call any time. GE Answer Center® service is open 24 hours a day, 7 days a week.

**OR**

Visit our Website at: [ge.com](http://ge.com)

*In Canada, call 1.888.880.3030.*

### **In-Home Repair Service**

**In the USA:  
800.444.1845**

**In Canada:  
1.888.880.3030**

A GE consumer service professional will provide expert repair service, scheduled at a time that's convenient for you. Many GE Consumer Service company-operated locations offer you service today or tomorrow, or at your convenience (7:00 a.m. to 7:00 p.m. weekdays, 9:00 a.m. to 2:00 p.m. Saturdays). Our factory-trained technicians know your appliance inside and out—so most repairs can be handled in just one visit.

### **For Customers With Special Needs...**

**In the USA:  
800.626.2000**

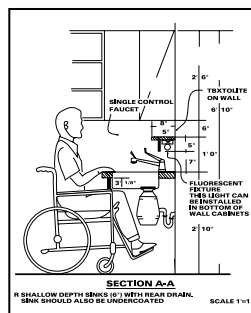

GE offers Braille controls for a variety of GE appliances, and a brochure to assist in planning a barrier-free kitchen for persons with limited mobility.

Consumers with impaired hearing or speech who have access to a TDD or a conventional teletypewriter may call 800.TDD.GEAC (800.833.4322) to request information or service.

### **Service Contracts**

**In the USA:  
800.626.2224**

**In Canada:  
1.888.880.3030**

You can have the secure feeling that GE Consumer Service will still be there after your warranty expires. Purchase a GE contract while your warranty is still in effect and you'll receive a substantial discount. With a multiple-year contract, you're assured of future service at today's prices.

### **Parts and Accessories**

**In the USA:  
800.626.2002**

**In Canada:  
1.888.880.3030**

Individuals qualified to service their own appliances can have parts or accessories sent directly to their home. The GE parts system provides access to over 47,000 parts...and all GE Genuine Renewal Parts are fully warranted. VISA, MasterCard and Discover cards are accepted.

User maintenance instructions contained in this manual cover procedures intended to be performed by any user. Other servicing generally should be referred to qualified service personnel. Caution must be exercised, since improper servicing may cause unsafe operation.

# Warranty

Built-In Refrigerators

## YOUR MONOGRAM REFRIGERATOR WARRANTY

**Staple sales slip or cancelled check here. Proof of original purchase date is needed to obtain service under warranty.**

### WHAT IS COVERED

*From the Date of the Original Purchase*

#### LIMITED TWO-YEAR WARRANTY

For two years from date of original purchase, we will provide, free of charge, parts and service labor in your home to repair or replace *any part of the refrigerator* that fails because of a manufacturing defect.

#### LIMITED FIVE-YEAR WARRANTY

For five years from date of original purchase, we will provide, free of charge, parts and service labor in your home to repair or replace *any part of the sealed refrigerating system* (the compressor, condenser, evaporator and all connecting tubing) that fails because of a manufacturing defect.

#### LIMITED ADDITIONAL SEVEN-YEAR WARRANTY ON THE SEALED SYSTEM

For the sixth through twelfth year from the date of the original purchase, we will provide, free of charge, replacement parts for *any part of the sealed refrigerating system* (the compressor, condenser, evaporator and all connecting tubing) that fails because of a manufacturing defect. You pay for the service trip to your home and for service labor charges.

#### LIMITED THIRTY-DAY WARRANTY ON WATER FILTER CARTRIDGE (Water filter, if included)

From the date of the original purchase we will provide, free of charge, replacement parts for *any part of the water filter cartridge* that fails because of a manufacturing defect. During this limited thirty-day warranty, we will also provide, free of charge, a replacement water filter cartridge.

.....  
This warranty is extended to the original purchaser and any succeeding owner for products purchased for ordinary home use in the 48 mainland states, Hawaii, Washington, D.C. or Canada. If the product is located in an area where service by a GE Authorized Servicer is not available, you may be responsible for a trip charge or you may be required to bring the product to an Authorized GE Service location for service. In Alaska the warranty is the same except that it is LIMITED because you must pay to ship the product to the service shop or for the service technician's travel costs to your home.

All warranty service will be provided by our Factory Service Centers or by our authorized Customer Care® servicers during normal working hours.

Should your appliance need service, during warranty period or beyond, in the USA call 800.444.1845. In Canada: 888.880.3030. Please have your serial number and model number available when calling for service.

### WHAT IS NOT COVERED

- Service trips to your home to teach you how to use the product.
- Replacement of house fuses or resetting of circuit breakers.
- Damage to the product caused by accident, fire, floods or acts of God.
- Failure of the product if it is used for other than its intended purpose or used commercially.
- Damage caused after delivery.
- Improper installation, delivery or maintenance. If you have an installation problem, contact your dealer or installer. You are responsible for providing adequate electrical, plumbing and other connecting facilities.
- Replacement of the light bulbs, if included, or water filter cartridge, if included, other than as noted above.
- Replacement of the water filter cartridge, if included, due to water pressure that is outside the specified operating range or due to excessive sediment in the water supply.
- Loss of food due to spoilage (in the USA only).
- Incidental or consequential damage caused by possible defects with this appliance.
- Product not accessible to provide required service.

**EXCLUSION OF IMPLIED WARRANTIES—Your sole and exclusive remedy is product repair as provided in this Limited Warranty. Any implied warranties, including the implied warranties of merchantability or fitness for a particular purpose, are limited to one year or the shortest period allowed by law.**

Some states/provinces do not allow the exclusion or limitation of incidental or consequential damages, so the above limitation or exclusion may not apply to you. This warranty gives you specific legal rights, and you may also have other rights which vary from state to state/province to province. To know what your legal rights are in your state/province, consult your local or state/provincial consumer affairs office or your state's Attorney General.

197D4946P003  
49-60422

11-05 JR

Printed in the United States

Warrantor in USA: General Electric Company,  
Louisville, KY 40225

Warrantor in Canada: Camco Inc.



GE Consumer & Industrial  
Appliances  
General Electric Company  
Louisville, KY 40225  
ge.com



## Free Manuals Download Website

<http://myh66.com>

<http://usermanuals.us>

<http://www.somanuals.com>

<http://www.4manuals.cc>

<http://www.manual-lib.com>

<http://www.404manual.com>

<http://www.luxmanual.com>

<http://aubethermostatmanual.com>

Golf course search by state

<http://golfingnear.com>

Email search by domain

<http://emailbydomain.com>

Auto manuals search

<http://auto.somanuals.com>

TV manuals search

<http://tv.somanuals.com>